

Simulink®

Reference



MATLAB® & SIMULINK®

R2021b



How to Contact MathWorks



Latest news: www.mathworks.com
Sales and services: www.mathworks.com/sales_and_services
User community: www.mathworks.com/matlabcentral
Technical support: www.mathworks.com/support/contact_us



Phone: 508-647-7000



The MathWorks, Inc.
1 Apple Hill Drive
Natick, MA 01760-2098

Simulink[®] Reference

© COPYRIGHT 2002–2021 by The MathWorks, Inc.

The software described in this document is furnished under a license agreement. The software may be used or copied only under the terms of the license agreement. No part of this manual may be photocopied or reproduced in any form without prior written consent from The MathWorks, Inc.

FEDERAL ACQUISITION: This provision applies to all acquisitions of the Program and Documentation by, for, or through the federal government of the United States. By accepting delivery of the Program or Documentation, the government hereby agrees that this software or documentation qualifies as commercial computer software or commercial computer software documentation as such terms are used or defined in FAR 12.212, DFARS Part 227.72, and DFARS 252.227-7014. Accordingly, the terms and conditions of this Agreement and only those rights specified in this Agreement, shall pertain to and govern the use, modification, reproduction, release, performance, display, and disclosure of the Program and Documentation by the federal government (or other entity acquiring for or through the federal government) and shall supersede any conflicting contractual terms or conditions. If this License fails to meet the government's needs or is inconsistent in any respect with federal procurement law, the government agrees to return the Program and Documentation, unused, to The MathWorks, Inc.

Trademarks

MATLAB and Simulink are registered trademarks of The MathWorks, Inc. See www.mathworks.com/trademarks for a list of additional trademarks. Other product or brand names may be trademarks or registered trademarks of their respective holders.

Patents

MathWorks products are protected by one or more U.S. patents. Please see www.mathworks.com/patents for more information.

Revision History

| | | |
|----------------|-------------|--|
| July 2002 | Online only | Revised for Simulink 5 (Release 13) |
| April 2003 | Online only | Revised for Simulink 5.1 (Release 13SP1) |
| April 2004 | Online only | Revised for Simulink 5.1.1 (Release 13SP1+) |
| June 2004 | Online only | Revised for Simulink 6 (Release 14) |
| October 2004 | Online only | Revised for Simulink 6.1 (Release 14SP1) |
| March 2005 | Online only | Revised for Simulink 6.2 (Release 14SP2) |
| September 2005 | Online only | Revised for Simulink 6.3 (Release 14SP3) |
| March 2006 | Online only | Revised for Simulink 6.4 (Release 2006a) |
| September 2006 | Online only | Revised for Simulink 6.5 (Release 2006b) |
| March 2007 | Online only | Revised for Simulink 6.6 (Release 2007a) |
| September 2007 | Online only | Revised for Simulink 7.0 (Release 2007b) |
| March 2008 | Online only | Revised for Simulink 7.1 (Release 2008a) |
| October 2008 | Online only | Revised for Simulink 7.2 (Release 2008b) |
| March 2009 | Online only | Revised for Simulink 7.3 (Release 2009a) |
| September 2009 | Online only | Revised for Simulink 7.4 (Release 2009b) |
| March 2010 | Online only | Revised for Simulink 7.5 (Release 2010a) |
| September 2010 | Online only | Revised for Simulink 7.6 (Release 2010b) |
| April 2011 | Online only | Revised for Simulink 7.7 (Release 2011a) |
| September 2011 | Online only | Revised for Simulink 7.8 (Release 2011b) |
| March 2012 | Online only | Revised for Simulink 7.9 (Release 2012a) |
| September 2012 | Online only | Revised for Simulink 8.0 (Release 2012b) |
| March 2013 | Online only | Revised for Simulink 8.1 (Release 2013a) |
| September 2013 | Online only | Revised for Simulink 8.2 (Release 2013b) |
| March 2014 | Online only | Revised for Simulink 8.3 (Release 2014a) |
| October 2014 | Online only | Revised for Simulink 8.4 (Release 2014b) |
| March 2015 | Online only | Revised for Simulink 8.5 (Release 2015a) |
| September 2015 | Online only | Revised for Simulink 8.6 (Release 2015b) |
| October 2015 | Online only | Rereleased for Simulink 8.5.1 (Release 2015aSP1) |
| March 2016 | Online only | Revised for Simulink 8.7 (Release 2016a) |
| September 2016 | Online only | Revised for Simulink 8.8 (Release 2016b) |
| March 2017 | Online only | Revised for Simulink 8.9 (Release 2017a) |
| September 2017 | Online only | Revised for Simulink 9.0 (Release 2017b) |
| March 2018 | Online only | Revised for Simulink 9.1 (Release 2018a) |
| September 2018 | Online only | Revised for Simulink 9.2 (Release 2018b) |
| March 2019 | Online only | Revised for Simulink 9.3 (Release 2019a) |
| September 2019 | Online only | Revised for Simulink 10.0 (Release 2019b) |
| March 2020 | Online only | Revised for Simulink 10.1 (Release 2020a) |
| September 2020 | Online only | Revised for Simulink 10.2 (Release 2020b) |
| March 2021 | Online only | Revised for Simulink 10.3 (Release 2021a) |
| September 2021 | Online only | Revised for Simulink 10.4 (Release 2021b) |

| | |
|----------|--|
| 1 | Blocks |
| 2 | Functions |
| 3 | Mask Icon Drawing Commands |
| 4 | Simulink Debugger Commands |
| 5 | Classes |
| 6 | Model and Block Parameters |
| | Programmatic Model Editor Appearance Parameters 6-2 |
| | Internal Programmatic Model Settings 6-9 |
| | Common Block Properties 6-12 |
| | About Common Block Properties 6-12 |
| | Examples of Setting Block Properties 6-25 |
| | Block-Specific Parameters 6-26 |
| | Programmatic Parameters of Blocks and Models 6-26 |
| | Block-Specific Parameters and Programmatic Equivalents 6-27 |

| | |
|------------------------------|--------------|
| Mask Parameters | 6-131 |
| About Mask Parameters | 6-131 |

Tools and Apps

7

Objects

8

Model Advisor Checks

9

| | |
|--|-------------|
| Simulink Checks | 9-2 |
| Simulink Check Overview | 9-4 |
| Migrating to Simplified Initialization Mode Overview | 9-4 |
| Identify unconnected lines, input ports, and output ports | 9-4 |
| Check root model Inport block specifications | 9-5 |
| Check optimization settings | 9-6 |
| Check diagnostic settings ignored during accelerated model reference simulation | 9-8 |
| Check for parameter tunability information ignored for referenced models | 9-9 |
| Check for implicit signal resolution | 9-9 |
| Check for optimal bus virtuality | 9-10 |
| Check for Discrete-Time Integrator blocks with initial condition uncertainty | 9-10 |
| Identify disabled library links | 9-11 |
| Check for large number of function arguments from virtual bus across model reference boundary | 9-12 |
| Identify parameterized library links | 9-12 |
| Identify unresolved library links | 9-13 |
| Identify configurable subsystem blocks for converting to variant subsystem blocks | 9-14 |
| Identify Variant Model blocks and convert those to Variant Subsystem containing Model block choices | 9-14 |
| Identify Variant blocks using Variant objects with empty conditions | 9-14 |
| Check usage of function-call connections | 9-15 |
| Check Data Store Memory blocks for multitasking, strong typing, and shadowing issues | 9-15 |
| Check if read/write diagnostics are enabled for data store blocks | 9-16 |
| Check data store block sample times for modeling errors | 9-17 |
| Check for potential ordering issues involving data store access | 9-18 |
| Check structure parameter usage with bus signals | 9-19 |
| Check Delay, Unit Delay and Zero-Order Hold blocks for rate transition . | 9-20 |
| Check for calls to slDataTypeAndScale | 9-21 |
| Check bus signals treated as vectors | 9-22 |

| | |
|---|------|
| Check for potentially delayed function-call subsystem return values | 9-23 |
| Identify block output signals with continuous sample time and non-floating point data type | 9-24 |
| Check usage of Merge blocks | 9-25 |
| Check usage of Outport blocks | 9-27 |
| Check usage of Discrete-Time Integrator blocks | 9-34 |
| Check model settings for migration to simplified initialization mode | 9-35 |
| Check S-functions in the model | 9-36 |
| Check for non-continuous signals driving derivative ports | 9-37 |
| Runtime diagnostics for S-functions | 9-38 |
| Identify unit mismatches in the model | 9-38 |
| Identify automatic unit conversions in the model | 9-39 |
| Identify disallowed unit systems in the model | 9-39 |
| Identify undefined units in the model | 9-40 |
| Identify ambiguous units in the model | 9-40 |
| Check model for block upgrade issues | 9-41 |
| Check model for block upgrade issues requiring compile time information | 9-41 |
| Check if SLX file compression is off | 9-42 |
| Check that the model or library is saved in current version | 9-43 |
| Check model for SB2SL blocks | 9-43 |
| Check Model History properties | 9-44 |
| Identify Model Info blocks that can interact with external source control tools | 9-45 |
| Identify Model Info blocks that use the Configuration Manager | 9-45 |
| Check model for upgradable SerDes Toolbox blocks | 9-46 |
| Check model for legacy 3DoF or 6DoF blocks | 9-46 |
| Check model for Aerospace Blockset navigation blocks | 9-47 |
| Check and update masked blocks in library to use promoted parameters | 9-47 |
| Check and update mask image display commands with unnecessary imread() function calls | 9-48 |
| Check and update mask to affirm icon drawing commands dependency on mask workspace | 9-49 |
| Identify masked blocks that specify tabs in mask dialog using MaskTabNames parameter | 9-49 |
| Identify questionable operations for strict single-precision design | 9-50 |
| Check get_param calls for block CompiledSampleTime | 9-51 |
| Check if all simulation outputs are returned as a single Simulink.SimulationOutput object | 9-53 |
| Check model for parameter initialization and tuning issues | 9-53 |
| Check for virtual bus across model reference boundaries | 9-54 |
| Check model for custom library blocks that rely on frame status of the signal | 9-55 |
| Check model for S-function upgrade issues | 9-56 |
| Update System object syntax | 9-57 |
| Check Rapid accelerator signal logging | 9-57 |
| Check virtual bus inputs to blocks | 9-58 |
| Check for root outports with constant sample time | 9-61 |
| Analyze model hierarchy and continue upgrade sequence | 9-61 |
| Check Access to Data Stores | 9-63 |
| Check relative execution orders for Data Store Read and Data Store Write blocks | 9-63 |
| Check for case mismatches in references to models and libraries | 9-64 |
| Check model for Signal Builder blocks | 9-64 |
| Check output dimensions of MATLAB Function blocks | 9-64 |

| | |
|--|------|
| Check model for RF Blockset Divider blocks using Wilkinson power divider component with broken connections | 9-65 |
| Identify Environment Controller Blocks and Replace Them with Variant Source Blocks | 9-66 |

Performance Advisor Checks

10

| | |
|---|-------------|
| Simulink Performance Advisor Checks | 10-2 |
| Simulink Performance Advisor Check Overview | 10-2 |
| Baseline | 10-3 |
| Checks that Require Update Diagram | 10-3 |
| Checks that Require Simulation to Run | 10-3 |
| Check Simulation Modes Settings | 10-3 |
| Check Compiler Optimization Settings | 10-3 |
| Check Hardware Acceleration Settings | 10-3 |
| Create baseline | 10-4 |
| Identify resource-intensive diagnostic settings | 10-4 |
| Check optimization settings | 10-4 |
| Identify inefficient lookup table blocks | 10-4 |
| Check MATLAB System block simulation mode | 10-5 |
| Identify Interpreted MATLAB Function blocks | 10-5 |
| Identify simulation target settings | 10-5 |
| Check model reference rebuild setting | 10-6 |
| Identify Scope blocks | 10-6 |
| Identify active instrumentation settings on the model | 10-6 |
| Check model reference parallel build | 10-6 |
| Check Delay block circular buffer setting | 10-7 |
| Check continuous and discrete rate coupling | 10-8 |
| Check zero-crossing impact on continuous integration | 10-8 |
| Check discrete signals driving derivative port | 10-9 |
| Check solver type selection | 10-9 |
| Select multi-thread co-simulation setting on or off | 10-10 |
| Identify co-simulation signals for numerical compensation | 10-10 |
| Check Dataflow Domain Settings | 10-10 |
| Select simulation mode | 10-11 |
| Select compiler optimizations on or off | 10-11 |
| Select hardware acceleration setting | 10-12 |
| Final Validation | 10-12 |

Simulink Limits

11

| | |
|---|-------------|
| Maximum Size Limits of Simulink Models | 11-2 |
| Systems and Models | 11-3 |
| System | 11-3 |
| System Component | 11-3 |
| Model | 11-3 |

| | |
|---|--------------|
| Model Component | 11-4 |
| Differential Algebraic Equations | 11-5 |
| Simulink Models | 11-6 |
| Block Diagram | 11-6 |
| Blocks | 11-7 |
| Lines | 11-10 |
| Data | 11-11 |
| Parameters | 11-15 |
| Properties | 11-17 |
| State variables | 11-21 |
| Sample Time | 11-23 |
| Units | 11-25 |
| Direct Feedthrough | 11-25 |
| Algebraic Loop | 11-26 |
| Artificial Algebraic Loops | 11-26 |
| Zero-Crossing Detection | 11-27 |
| Simulink Simulation | 11-28 |
| Compilation | 11-28 |
| Callback | 11-29 |
| Execution Order | 11-29 |
| Simulation | 11-30 |
| Solver | 11-30 |
| Simulink Tools | 11-33 |
| Programming Constructs in Simulink | 11-44 |
| Model Development Processes | 11-46 |
| Test Harness | 11-48 |
| What is Simulink Online? | 11-49 |

Block Reference Page Examples

12

| | |
|--|--------------|
| Create Mux Signal and Extract Elements | 12-5 |
| Manage Bus-to-Vector Conversions | 12-6 |
| Assign Signal Values to a Bus | 12-8 |
| Initialize Your Model Using the Callback Button Block | 12-9 |
| Control a Parameter Value with Callback Button Blocks | 12-10 |
| Control the Duty Cycle of a PWM Signal Using Dashboard Blocks | 12-11 |
| Control Merging Signals with the Push Button Block | 12-13 |
| Tune the Relative Slip for an Anti-Lock Braking System | 12-15 |

| | |
|--|--------------|
| Interactively Simulate a Vehicle Climate Control System | 12-17 |
| Interactively Simulate a Thermal Model of a House | 12-20 |
| Create a Realistic Dashboard Using the Circular Gauge Block | 12-22 |
| Solve a Linear System of Algebraic Equations | 12-25 |
| Model a Planar Pendulum | 12-26 |
| Improved Linearization with Transfer Fcn Blocks | 12-29 |
| View Dead Zone Output on Sine Wave | 12-30 |
| View Backlash Output on Sine Wave | 12-31 |
| Prelookup With External Breakpoint Specification | 12-32 |
| Prelookup with Evenly Spaced Breakpoints | 12-33 |
| Configure the Prelookup Block to Output Index and Fraction as a Bus | 12-34 |
| Approximating the sinh Function Using the Lookup Table Dynamic Block | 12-35 |
| Create a Logarithm Lookup Table | 12-36 |
| Providing Table Data as an Input to the Direct Lookup Table Block .. | 12-37 |
| Specifying Table Data in the Direct Lookup Table Block Dialog Box .. | 12-38 |
| Using the Quantizer and Saturation blocks in sldemo_boiler | 12-39 |
| Scalar Expansion with the Coulomb and Viscous Friction Block | 12-40 |
| Sum Block Reorders Inputs | 12-41 |
| Iterated Assignment with the Assignment Block | 12-42 |
| View Sample Time Using the Digital Clock Block | 12-43 |
| Bit Specification Using a Positive Integer | 12-44 |
| Bit Specification Using an Unsigned Integer Expression | 12-45 |
| Track Running Minimum Value of Chirp Signal | 12-46 |
| Horizontal Matrix Concatenation | 12-47 |
| Vertical Matrix Concatenation | 12-48 |
| Multidimensional Matrix Concatenation | 12-49 |

| | |
|---|--------------|
| Unary Minus of Matrix Input | 12-50 |
| Sample Time Math Operations Using the Weighted Sample Time Math Block | 12-51 |
| Construct Complex Signal from Real and Imaginary Parts | 12-52 |
| Construct Complex Signal from Magnitude and Phase Angle | 12-53 |
| Find Nonzero Elements in an Array | 12-54 |
| Calculate the Running Minimum Value with the MinMax Running Resettable Block | 12-55 |
| Find Maximum Value of Input | 12-57 |
| Permute Array Dimensions | 12-59 |
| Multiply Inputs of Different Dimensions with the Product Block | 12-60 |
| Multiply and Divide Inputs Using the Product Block | 12-61 |
| Divide Inputs of Different Dimensions Using the Divide Block | 12-62 |
| Complex Division Using the Product of Elements Block | 12-63 |
| Element-Wise Multiplication and Division Using the Product of Elements Block | 12-64 |
| sin Function with Floating-Point Input | 12-65 |
| sincos Function with Fixed-Point Input | 12-66 |
| Trigonometric Function Block Behavior for Complex Exponential Output | 12-67 |
| Control Algorithm Execution Using Enumerated Signal | 12-68 |
| Integer and Enumerated Data Type Support in the Ground Block | 12-70 |
| Fixed-Point Data Type Support in the Ground Block | 12-71 |
| Read 1-D Array and Structure From Workspace | 12-72 |
| Read Structure From Workspace Using Model Sample Time | 12-73 |
| Read 2-D Signals in Structure Format From Workspace | 12-74 |
| From File Block Loading Timeseries Data | 12-75 |
| Eliminate Singleton Dimension with the Squeeze Block | 12-76 |
| Difference Between Time- and Sample-Based Pulse Generation | 12-77 |

| | |
|--|---------------|
| Specify a Waveform with the Repeating Sequence Block | 12-79 |
| Tune Phase Delay on Pulse Generator During Simulation | 12-80 |
| Difference Sine Wave Signal | 12-81 |
| Discrete-Time Derivative of Floating-Point Input | 12-82 |
| First-Order Sample-and-Hold of a Sine Wave | 12-83 |
| Calculate and Display Simulation Step Size using Memory and Clock Blocks | 12-84 |
| Capture the Velocity of a Bouncing Ball with the Memory Block | 12-85 |
| Implement a Finite-State Machine with the Combinatorial Logic and Memory Blocks | 12-87 |
| Discrete-Time Integration Using the Forward Euler Integration Method | 12-88 |
| Signal Routing with the From, Goto, and Goto Tag Visibility Blocks .. | 12-89 |
| Zero-Based and One-Based Indexing with the Index Vector Block | 12-91 |
| Noncontiguous Values for Data Port Indices of Multiport Switch Block | 12-92 |
| Using Variable-Size Signals on the Delay Block | 12-93 |
| Buses with the Delay Block for Frame-Based Processing | 12-94 |
| Control Execution of Delay Block with Enable Port | 12-95 |
| Zero-Based Indexing for Multiport Switch Data Ports | 12-96 |
| One-Based Indexing for Multiport Switch Data Ports | 12-97 |
| Enumerated Names for Data Port Indices of the Multiport Switch Block | 12-98 |
| Prevent Block Windup in Multiloop Control | 12-99 |
| Bumpless Control Transfer | 12-100 |
| Bumpless Control Transfer with a Two-Degree-of-Freedom PID Controller | 12-101 |
| Using a Bit Set block | 12-102 |
| Using a Bit Clear block | 12-103 |
| Two-Input AND Logic | 12-104 |

| | |
|--|---------------|
| Circuit Logic | 12-105 |
| Unsigned Inputs for the Bitwise Operator Block | 12-106 |
| Signed Inputs for the Bitwise Operator Block | 12-107 |
| Merge Block with Input from Atomic Subsystems | 12-108 |
| Index Options with the Selector Block | 12-109 |
| Switch Block with a Boolean Control Port Example | 12-110 |
| Merge Block with Unequal Input Widths Example | 12-111 |
| Detect Rising Edge of Signals | 12-113 |
| Detect Falling Edge Using the Detect Fall Nonpositive Block | 12-115 |
| Detect Increasing Signal Values with the Detect Increase Block | 12-116 |
| Extract Bits from Stored Integer Value | 12-117 |
| Detect Signal Values Within a Dynamically Specified Interval | 12-118 |
| Model a Digital Thermometer Using the Polynomial Block | 12-120 |
| Convert Data Types in Simulink Models | 12-121 |
| Control Data Types with the Data Type Duplicate Block | 12-123 |
| Probe Sample Time of a Signal | 12-124 |
| Convert Signals Between Continuous Time and Discrete Time | 12-125 |
| Convert Muxed Signal to a Vector | 12-127 |
| Create Contiguous Copy of a Bus Signal | 12-128 |
| Convert Virtual Bus to a Nonvirtual Bus | 12-129 |
| Convert Nonvirtual Bus to Virtual Bus | 12-130 |
| Remove Scaling from a Fixed-Point Signal | 12-131 |
| Stop Simulation Block with Relational Operator Block | 12-132 |
| Output Simulation Data with Blocks | 12-133 |
| Increment and Decrement Real-World Values | 12-137 |
| Increment and Decrement Stored Integer Values | 12-139 |
| Specify a Vector of Initial Conditions for a Discrete Filter Block | 12-140 |

| | |
|--|---------------|
| Generate Linear Models for a Rising Edge Trigger Signal | 12-142 |
| Generate Linear Models at Predetermined Times | 12-144 |
| Capture Measurement Descriptions in a DocBlock | 12-145 |
| Square Root of Negative Values | 12-146 |
| Signed Square Root of Negative Values | 12-147 |
| rSqrt of Floating-Point Inputs | 12-148 |
| rSqrt of Fixed-Point Inputs | 12-149 |
| Model a Series RLC Circuit | 12-150 |
| Extract Vector Elements and Distribute Evenly Across Outputs | 12-153 |
| Extract Vector Elements Using the Demux Block | 12-154 |
| Detect Change in Signal Values | 12-155 |
| Detect Fall to Negative Signal Values | 12-156 |
| Detect Decreasing Signal Values | 12-157 |
| Function-Call Blocks Connected to Branches of the Same Function-Call Signal | 12-158 |
| Function-Call Feedback Latch on Feedback Signal Between Child and Parent | 12-159 |
| Single Function-Call Subsystem | 12-160 |
| Function-Call Subsystem with Merged Signal As Input | 12-161 |
| Partitioning an Input Signal with the For Each Block | 12-162 |
| Specifying the Concatenation Dimension in the For Each Block | 12-163 |
| Working with the Initialize Function, Reset Function, and Terminate Function Blocks | 12-164 |
| Reading and Writing States with the Initialize Function and Terminate Function Blocks | 12-165 |
| PWM Control of a Boost Converter | 12-166 |
| Voltage Controlled Oscillator | 12-169 |
| Check Signal Lower Bound with Check Dynamic Lower Bound Block | 12-171 |

| | |
|--|---------------|
| Check Signal Upper Bound with Check Dynamic Upper Bound Block | 12-173 |
| Check Signal Lower Bound with Check Static Lower Bound Block .. | 12-175 |
| Check Signal Range with Check Static Range Block | 12-177 |
| Check Signal Upper Bound with Check Static Upper Bound Block .. | 12-179 |
| Check Signal Slope with Check Discrete Gradient Block | 12-181 |
| Check Signal Value with Check Dynamic Gap Block | 12-183 |
| Check Signal Value with Check Static Gap Block | 12-185 |
| Check Signal Range with Check Dynamic Range Block | 12-187 |
| Check Signal Resolution with Check Input Resolution Block | 12-189 |

Simulink Featured Examples

13

| | |
|---|--------------|
| Simulation of a Bouncing Ball | 13-5 |
| Single Hydraulic Cylinder Simulation | 13-11 |
| Thermal Model of a House | 13-21 |
| Approximating Nonlinear Relationships: Type S Thermocouple | 13-26 |
| Digital Waveform Generation: Approximating a Sine Wave | 13-35 |
| Accurate Zero-Crossing Detection | 13-45 |
| Spiral Galaxy Formation Simulation Using MATLAB Function Blocks | 13-46 |
| Counters Using Conditionally Executed Subsystems | 13-50 |
| Friction Model with Hard Stops | 13-52 |
| State Events | 13-54 |
| Bang-Bang Control Using Temporal Logic | 13-55 |
| Inverted Pendulum with Animation | 13-56 |
| Double Spring Mass System | 13-58 |
| Tank Fill and Empty with Animation | 13-60 |

| | |
|--|---------------|
| Simulating Systems with Variable Transport Delay Phenomena | 13-63 |
| Modeling a Foucault Pendulum | 13-67 |
| Foucault Pendulum Model with VRML Visualization | 13-75 |
| Exploring Variable-Step Solvers Using a Stiff Model | 13-78 |
| Exploring the Solver Jacobian Structure of a Model | 13-84 |
| Double Bouncing Ball: Use of Adaptive Zero-Crossing Location | 13-93 |
| Four Hydraulic Cylinder Simulation | 13-100 |
| Two Cylinder Model with Load Constraints | 13-106 |
| Modeling a Fault-Tolerant Fuel Control System | 13-112 |
| Using a Data Dictionary to Manage the Data for a Fuel Control System | 13-127 |
| Modeling Engine Timing Using Triggered Subsystems | 13-130 |
| Engine Timing Model with Closed Loop Control | 13-140 |
| Building a Clutch Lock-Up Model | 13-144 |
| Modeling Clutch Lock-Up Using If Blocks | 13-155 |
| Modeling an Anti-Lock Braking System | 13-160 |
| Automotive Suspension | 13-166 |
| Modeling an Automatic Transmission Controller | 13-172 |
| Vehicle Electrical System | 13-183 |
| Simulating Automatic Climate Control Systems | 13-185 |
| Vehicle Electrical and Climate Control Systems | 13-190 |
| Power Window Control Project | 13-196 |
| Developing the Apollo Lunar Module Digital Autopilot | 13-203 |
| Designing a High Angle of Attack Pitch Mode Control | 13-208 |
| Six Degrees of Freedom (6-DoF) Motion Platform | 13-221 |
| Aircraft Longitudinal Flight Control | 13-224 |
| Simulink Model Discretizer | 13-226 |
| Radar Tracking Using MATLAB Function Block | 13-227 |

| | |
|--|---------------|
| Optical Sensor Image Generation | 13-229 |
| Air Traffic Control Radar Design | 13-238 |
| Designing a Guidance System in MATLAB and Simulink | 13-244 |
| Airframe Trim and Linearize | 13-260 |
| Anti-Windup Control Using a PID Controller | 13-265 |
| Bumpless Control Transfer Between Manual and PID Control | 13-280 |
| Two Degree-of-Freedom PID Control for Setpoint Tracking | 13-289 |
| Data Typing in Simulink | 13-295 |
| Data Typing Filter | 13-299 |
| Explore Simulink Bus Capabilities | 13-301 |
| Model Arrays of Buses | 13-309 |
| Matrix Signals | 13-311 |
| Variable-Size Signal Basic Operations | 13-312 |
| Variable-Size Signal Length Adaptation | 13-314 |
| Multimode Variable-Size Signal | 13-315 |
| Parallel Channel Power Allocation | 13-316 |
| Merging Signals | 13-318 |
| Share Data Store Between Instances of a Reusable Algorithm | 13-331 |
| Attaching Input Data to External Inputs via Custom Input Mappings | 13-336 |
| Using Mapping Modes with Custom-Mapped External Inputs | 13-340 |
| Converting Harness-Driven Models to Use Harness-Free External Inputs | 13-344 |
| Logging States in Structure Format | 13-349 |
| Saving and Restoring Simulation Operating Point | 13-352 |
| Logging Intervals | 13-356 |
| Working with Big Data | 13-359 |
| Simulink Subsystem Semantics | 13-363 |

| | |
|---|---------------|
| If-Then-Else Blocks | 13-364 |
| Triggered Subsystems | 13-366 |
| Enabled Subsystems | 13-368 |
| Advanced Enabled Subsystems | 13-370 |
| Resettable Subsystems | 13-373 |
| Discrete and Continuous Resettable Subsystems | 13-375 |
| Block Priority | 13-378 |
| Monitoring Ink Status on a Shared Printer Using Simulink Functions | 13-379 |
| Modeling Reusable Components Using Multiply Instanced Simulink Functions | 13-381 |
| Dynamic Priority Scheduling of Functions | 13-383 |
| Component-Based Modeling with Model Reference | 13-384 |
| Viewing Signals in Model Reference Instances | 13-388 |
| Visualize Model Reference Hierarchies | 13-396 |
| Introduction to Managing Data with Model Reference | 13-401 |
| Detailed Workflow for Managing Data with Model Reference | 13-412 |
| Interface Specification Using Bus Objects | 13-429 |
| Convert Subsystem to Referenced Model | 13-436 |
| Using Data Stores Across Multiple Models | 13-438 |
| Model Reference Function-Call | 13-444 |
| Explore Protected Model Capabilities | 13-446 |
| Model Reference Variants | 13-451 |
| Assigning Tasks to Cores for Multicore Programming | 13-455 |
| Implement an FFT on a Multicore Processor and an FPGA | 13-458 |
| Multicore Programming of a Field-Oriented Control on Zynq | 13-462 |
| Multicore Deployment of a Plant Model | 13-468 |
| Modeling Objects with Identical Dynamics Using For Each Subsystem | 13-472 |

| | |
|---|---------------|
| Vectorizing a Scalar Algorithm with a For Each Subsystem | 13-477 |
| Tiled Processing of 2D Signals with For Each Subsystem | 13-479 |
| Neighborhood Processing Using For Each Subsystems | 13-480 |
| Using a Project with SVN | 13-483 |
| Using a Project with Git | 13-488 |
| Using a Project | 13-493 |
| Perform Impact Analysis with a Project | 13-497 |
| Referencing Projects from Another Project | 13-504 |
| Automate Label Management in a Project | 13-505 |
| Run Custom Tasks with a Project | 13-508 |
| Upgrade Simulink Models Using a Project | 13-511 |
| Export a Subset of a Project Using an Export Profile | 13-513 |
| Create and Reference a Project Programmatically | 13-515 |
| Compare and Merge Simulink Models | 13-519 |
| Compare and Merge Simulink Models Containing Stateflow | 13-521 |
| Resolve Conflicts with Simulink Three-Way Merge | 13-524 |
| Call C Functions Using C Caller Block | 13-528 |
| Bring Custom Image Filter Algorithms as Reusable Blocks in Simulink | 13-532 |
| Custom Code and Hand Coded Blocks using the S-function API | 13-534 |
| Inputs Passed by Value or Address to Legacy Functions | 13-535 |
| Output Passed by Return Argument from Legacy Functions | 13-538 |
| Fixed Point Signals in Legacy Functions | 13-540 |
| Fixed Point Parameters in Legacy Functions | 13-543 |
| Lookup Tables Implemented in Legacy Functions | 13-546 |
| Start and Terminate Actions Within Legacy Functions | 13-549 |
| Using Buses with Legacy Functions Having Structure Arguments ... | 13-553 |
| Inherited Signal Dimensions for Legacy Function Arguments | 13-556 |

| | |
|---|---------------|
| C++ Object Methods as Legacy Functions | 13-559 |
| Persistent Memory Within Legacy Functions | 13-562 |
| Multi-Dimensional Signals in Legacy Functions | 13-565 |
| Complex Signals in Legacy Function | 13-567 |
| Specified or Inherited Sample Time with Legacy Functions | 13-569 |
| Illustration of Law of Large Numbers | 13-572 |
| Using Buses with MATLAB System Blocks | 13-574 |
| Run Quality Checks on S-Functions | 13-576 |
| Using the Prelookup and Interpolation Blocks | 13-578 |
| Saving Memory in Prelookup and Interpolation Blocks by Using Smaller Data | 13-583 |
| Model Advisor | 13-584 |
| Introduction to Profiling Models | 13-585 |
| Introduction to Accelerating Models | 13-588 |
| Determine Why Simulink Accelerator Is Regenerating Code | 13-590 |
| Parallel Simulations Using Parsim: Test-Case Sweep | 13-595 |
| Parallel Simulations Using Parsim: Parameter Sweep in Normal Mode | 13-599 |
| Parallel Simulations Using Parsim: Parameter Sweep in Rapid Accelerator Mode | 13-603 |
| Rapid Accelerator Simulations Using Parsim | 13-607 |
| Multiple Simulations Workflow Tips | 13-611 |
| Streamline Simulink Blockset Authoring Process with Blockset Designer | 13-615 |
| Importing a Co-Simulation FMU into Simulink | 13-616 |
| Importing a Model Exchange FMU into Simulink | 13-617 |
| Simplify Interface for Structured Data with FMU Import Block | 13-618 |
| Co-Simulation Signal Compensation | 13-620 |
| Multithread Co-Simulation | 13-622 |

| | |
|--|---------------|
| Pulse Width Modulation Using MATLAB System Block | 13-624 |
| Modeling Cyber-Physical Systems | 13-625 |
| Schedule an Export-Function Model Using the Schedule Editor | 13-630 |
| Promote Block Parameters on a Mask | 13-634 |
| Graph-Based Multithread Simulation | 13-635 |
| Find Shortest Control Path in Simulink Model | 13-637 |

Blocks

Abs

Output absolute value of input

Library: Simulink / Math Operations
 HDL Coder / HDL Floating Point Operations
 HDL Coder / Math Operations



Description

The Abs block outputs the absolute value of the input.

For signed-integer data types, the absolute value of the most negative value is not representable by the data type. In this case, the **Saturate on integer overflow** check box controls the behavior of the block.

| If you... | The block... | And... |
|------------------------------|---|---|
| Select this check box | Saturates to the most positive value of the integer data type | <ul style="list-style-type: none"> For 8-bit signed integers, -128 maps to 127. For 16-bit signed integers, -32768 maps to 32767. For 32-bit signed integers, -2147483648 maps to 2147483647. |
| Do not select this check box | Wraps to the most negative value of the integer data type | <ul style="list-style-type: none"> For 8-bit signed integers, -128 remains -128. For 16-bit signed integers, -32768 remains -32768. For 32-bit signed integers, -2147483648 remains -2147483648. |

The Abs block supports zero-crossing detection. However, when you select **Enable zero-crossing detection** on the dialog box, the block does not report the simulation minimum or maximum in the Fixed-Point Tool. If you want to use the Fixed-Point Tool to analyze a model, disable zero-crossing detection for all Abs blocks in the model first.

Ports

Input

Port_1 – Input signal

scalar | vector

Input signal to the absolute value block.

Data Types: half | single | double | int8 | int16 | int32 | int64 | uint8 | uint16 | uint32 | uint64 | fixed point

Output

Port_1 — Absolute value output signal

scalar | vector

Absolute value of the input signal.

Data Types: half | single | double | int8 | int16 | int32 | int64 | uint8 | uint16 | uint32 | uint64 | fixed point

Parameters

Main

Enable zero-crossing detection — Enable zero-crossing detection

on (default) | Boolean

Select to enable zero-crossing detection. For more information, see “Zero-Crossing Detection” in the Simulink documentation.

Programmatic Use

Block Parameter: ZeroCross

Type: character vector, string

Values: 'off' | 'on'

Default: 'on'

Sample time — Specify sample time as a value other than -1

-1 (default) | scalar | vector

Specify the sample time as a value other than -1. For more information, see “Specify Sample Time”.

Dependencies

This parameter is not visible unless it is explicitly set to a value other than -1. To learn more, see “Blocks for Which Sample Time Is Not Recommended”.

Programmatic Use

Block Parameter: SampleTime

Type: character vector

Values: scalar or vector

Default: '-1'

Signal Attributes

Click the **Show data type assistant** button  to display the **Data Type Assistant**, which helps you set the data type attributes. For more information, see “Specify Data Types Using Data Type Assistant”.

Output minimum — Minimum output value for range checking

[] (default) | scalar

Lower value of the output range that Simulink checks.

Simulink uses the minimum to perform:

- Parameter range checking (see “Specify Minimum and Maximum Values for Block Parameters”) for some blocks.
- Simulation range checking (see “Specify Signal Ranges” and “Enable Simulation Range Checking”).
- Automatic scaling of fixed-point data types.
- Optimization of the code that you generate from the model. This optimization can remove algorithmic code and affect the results of some simulation modes such as SIL or external mode. For more information, see “Optimize using the specified minimum and maximum values” (Embedded Coder).

Note Output minimum does not saturate or clip the actual output signal. Use the Saturation block instead.

Programmatic Use

Block Parameter: OutMin

Type: character vector

Values: ' [] ' | scalar

Default: ' [] '

Output maximum — Maximum output value for range checking

[] (default) | scalar

Upper value of the output range that Simulink checks.

Simulink uses the maximum value to perform:

- Parameter range checking (see “Specify Minimum and Maximum Values for Block Parameters”) for some blocks.
- Simulation range checking (see “Specify Signal Ranges” and “Enable Simulation Range Checking”).
- Automatic scaling of fixed-point data types.
- Optimization of the code that you generate from the model. This optimization can remove algorithmic code and affect the results of some simulation modes such as SIL or external mode. For more information, see “Optimize using the specified minimum and maximum values” (Embedded Coder).

Note Output maximum does not saturate or clip the actual output signal. Use the Saturation block instead.

Programmatic Use

Block Parameter: OutMax

Type: character vector

Values: ' [] ' | scalar

Default: ' [] '

Output data type — Specify the output data type

Inherit: Same as input (default) | Inherit: Inherit via internal rule | Inherit: Inherit via back propagation | double | single | half | int8 | int32 | uint32 | int64 | uint64 | fixdt(1,16,2^0,0) | <data type expression> | ...

Choose the data type for the output. The type can be inherited, specified directly, or expressed as a data type object such as Simulink.NumericType.

Dependencies

When input is a floating-point data type smaller than single precision, the `Inherit: Inherit via internal` rule output data type depends on the setting of the “Inherit floating-point output type smaller than single precision” configuration parameter. Data types are smaller than single precision when the number of bits needed to encode the data type is less than the 32 bits needed to encode the single-precision data type. For example, `half` and `int16` are smaller than single precision.

Programmatic Use

Block Parameter: `OutDataTypeStr`

Type: character vector

Values: `'Inherit: Same as input'` | `'Inherit: Inherit via internal rule'` | `'Inherit: Inherit via back propagation'` | `'single'` | `'half'` | `'int8'` | `'uint8'` | `int16` | `'uint16'` | `'int32'` | `'uint32'` | `'int64'` | `'uint64'` | `fixdt(1,16,0)` | `fixdt(1,16,2^0,0)` | `fixdt(1,16,2^0,0)` | `'<data type expression>'`

Default: `'Inherit: Same as input'`

Lock output data type setting against changes by the fixed-point tools — Prevent fixed-point tools from overriding Output data type

`off` (default) | `on`

Select this parameter to prevent the fixed-point tools from overriding the **Output** data type you specify on the block. For more information, see “Use Lock Output Data Type Setting” (Fixed-Point Designer).

Programmatic Use

Block Parameter: `LockScale`

Type: character vector

Values: `'off'` | `'on'`

Default: `'off'`

Integer rounding mode — Rounding mode for fixed-point operations

`Floor` (default) | `Ceiling` | `Convergent` | `Nearest` | `Round` | `Simplest` | `Zero`

Specify the rounding mode for fixed-point operations. For more information, see “Rounding” (Fixed-Point Designer).

Block parameters always round to the nearest representable value. To control the rounding of a block parameter, enter an expression using a MATLAB® rounding function into the mask field.

Programmatic Use

Block Parameter: `RndMeth`

Type: character vector

Values: `'Ceiling'` | `'Convergent'` | `'Floor'` | `'Nearest'` | `'Round'` | `'Simplest'` | `'Zero'`

Default: `'Floor'`

Saturate on integer overflow — Choose the behavior when integer overflow occurs

`off` (default) | `on`

When you select this check box, saturation applies to every internal operation on the block, not just the output or result. In general, the code generation process can detect when overflow is not possible. In this case, the code generator does not produce saturation code.

| Action | Reason for Taking This Action | What Happens | Example |
|-------------------------------|---|---|---|
| Select this check box. | Your model has possible overflow and you want explicit saturation protection in the generated code. | Overflows saturate to the maximum value that the data type can represent. | The number 130 does not fit in a signed 8-bit integer and saturates to 127. |
| Do not select this check box. | You want to optimize efficiency of your generated code. | Overflows wrap to the appropriate value that is representable by the data type. | The number 130 does not fit in a signed 8-bit integer and wraps to -126. |

Programmatic Use

Block Parameter: SaturateOnIntegerOverflow

Type: character vector

Value: 'off' | 'on'

Default: 'off'

Block Characteristics

| | |
|---------------------------------|--|
| Data Types | double fixed point half integer single |
| Direct Feedthrough | yes |
| Multidimensional Signals | yes |
| Variable-Size Signals | yes |
| Zero-Crossing Detection | yes |

Extended Capabilities

C/C++ Code Generation

Generate C and C++ code using Simulink® Coder™.

HDL Code Generation

Generate Verilog and VHDL code for FPGA and ASIC designs using HDL Coder™.

HDL Coder™ provides additional configuration options™ that affect HDL implementation and synthesized logic.

HDL Architecture

This block has a single, default HDL architecture.

HDL Block Properties

| General | |
|----------------------------------|--|
| ConstrainedOutputPipeline | Number of registers to place at the outputs by moving existing delays within your design. Distributed pipelining does not redistribute these registers. The default is 0. For more details, see “ConstrainedOutputPipeline” (HDL Coder). |

| General | |
|-----------------------|--|
| InputPipeline | Number of input pipeline stages to insert in the generated code. Distributed pipelining and constrained output pipelining can move these registers. The default is 0. For more details, see "InputPipeline" (HDL Coder). |
| OutputPipeline | Number of output pipeline stages to insert in the generated code. Distributed pipelining and constrained output pipelining can move these registers. The default is 0. For more details, see "OutputPipeline" (HDL Coder). |

| Native Floating Point | |
|------------------------------|--|
| LatencyStrategy | Specify whether to map the blocks in your design to <code>inherit</code> , <code>Max</code> , <code>Min</code> , or <code>Zero</code> for the floating-point operator. The default is <code>inherit</code> . See also "LatencyStrategy" (HDL Coder). |

Complex Data Support

This block supports code generation for complex signals with floating-point types in **Native Floating Point** mode.

Code generation for the block with complex signals that use fixed-point types is not supported. To calculate the magnitude of a complex number, use the **Complex to Magnitude-Angle HDL Optimized** block instead.

PLC Code Generation

Generate Structured Text code using Simulink® PLC Coder™.

Fixed-Point Conversion

Design and simulate fixed-point systems using Fixed-Point Designer™.

See Also

Sign | Sum

Introduced before R2006a

Action Port

Control port for action signal to If Action Subsystem or Switch Case Action Subsystem block

Description

The Action Port block controls the execution of these subsystem blocks:

- If Action Subsystem blocks connected to If blocks.
- Switch Case Action Subsystem blocks connected to Switch Case blocks.
- Simulink based states in Stateflow® charts. See “Create and Edit Simulink Based States” (Stateflow).

Parameters

States when execution is resumed — Select handling of internal states

held (default) | reset

Select how to handle internal states when a subsystem with an Action Port block reenables.

held

When the subsystem reenables, retain the previous state values of the subsystem. Previous state values between calls are retained even if you call other subsystem blocks connected to the If or Switch Case block.

reset

When the subsystem reenables, reinitialize the state values.

A subsystem reenables when the logical expression for its action port evaluates to true after having been previously false. In the following example, the Action Port blocks for both subsystems A and B have the **States when execution is resumed** parameter set to **reset**.

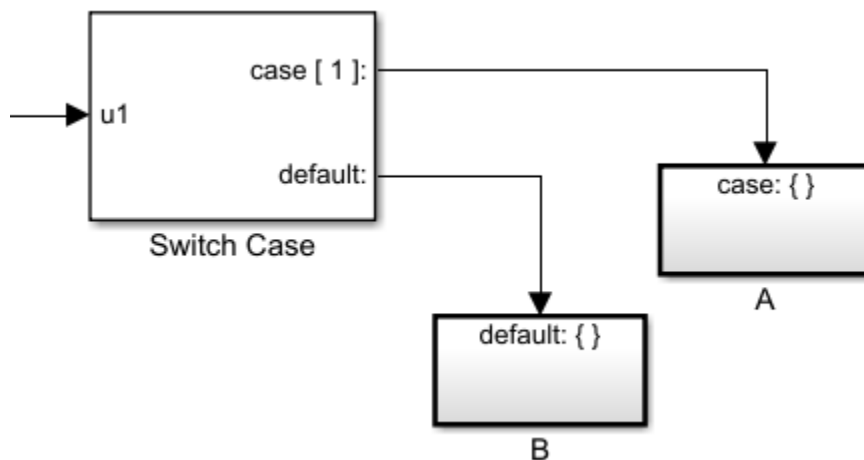

When **case[1]** is **true**, subsystem **A** is executed. Repeated calls to subsystem **A** while **case [1]** continues to be **true**, does not reset its state values. The same behavior applies to subsystem **B**.

Programmatic Use**Block Parameter:** InitializeStates**Type:** character vector**Value:** 'held' | 'reset'**Default:** 'held'**Propagate sizes of variable-size signals — Select when to propagate a variable-size signal**

Only when execution is resumed (default) | During execution

Select when to propagate a variable-size signal.

Only when execution is resumed

Propagate variable-size signals only when reenabling the subsystem containing the Action Port block.

During execution

Propagate variable-size signals at each time step.

Programmatic Use**Block Parameter:** PropagateVarSize**Type:** character vector**Values:** 'Only when execution is resumed' | 'During execution'**Default:** 'Only when execution is resumed'**See Also**

If | If Action Subsystem | Switch Case | Switch Case Action Subsystem

Topics

Select Subsystem Execution

Introduced before R2006a

Algebraic Constraint

Constrain input signal

Library: Simulink / Math Operations

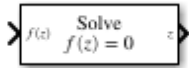

Description

The Algebraic Constraint block constrains the input signal $f(z)$ to z or 0 and outputs an algebraic state z . The block outputs a value that produces 0 or z at the input. The output must affect the input through a direct feedback path. In other words, the feedback path only contains blocks with direct feedthrough. For example, you can specify algebraic equations for index 1 differential-algebraic systems (DAEs).

Ports

Input

f(z) — Input signal

real scalar or vector

Signal is subjected to the constraint $f(z) = 0$ or $f(z) = z$ to solve the algebraic loop.

Data Types: double

Output

z — Output state

real scalar or vector

Solution to the algebraic loop when the input signal **f(z)** is subjected to the constraint $f(z) = 0$ or $f(z) = z$.

Data Types: double

Parameters

Constraint — Constraint on input signal

$f(z) = 0$ (default) | $f(z) = z$

Type of constraint for which to solve. You can solve for $f(z) = 0$ or $f(z) = z$

Programmatic Use

Block Parameter: Constraint

Type: character vector

Values: 'f(z) = 0' | 'f(z) = z'

Default: 'f(z) = 0'

Solver — Algebraic Loop Solver

auto (default) | Trust region | Line search

Choose between the Trust region [1], [2] or Line search [3] algorithms to solve the algebraic loop. By default this value is set to `auto`, which selects the algebraic loop solver based on the model configuration and switches the solver between the Trust region and Line search algorithm during simulation

Programmatic Use

Block Parameter: Solver

Type: character vector

Values: 'auto' | 'Trust region' | 'Line search'

Default: 'auto'

Tolerance — Solver Tolerance

auto (default) | positive scalar

This option is visible when you explicitly specify a solver to be used (Trust region or Line Search) in the **Solver** drop-down menu. Specify a smaller value for higher accuracy or a larger value for faster execution. By default it is set to `auto`.

Programmatic Use

Block Parameter: Tolerance

Type: character vector

Values: 'auto' | positive scalar

Default: 'auto'

Initial Guess — Initial guess of solution value

0 (default) | scalar

Initial guess for the algebraic state z that is close to the expected solution value to improve the efficiency of the algebraic loop solver. By default, this value is set to 0

Programmatic Use

Block Parameter: InitialGuess

Type: character vector

Values: scalar

Default: '0'

Block Characteristics

| | |
|---------------------------------|--------|
| Data Types | double |
| Direct Feedthrough | no |
| Multidimensional Signals | no |
| Variable-Size Signals | no |
| Zero-Crossing Detection | no |

References

- [1] Garbow, B. S., K. E. Hillstom, and J. J. Moré. *User Guide for MINPACK-1*. Argonne, IL: Argonne National Laboratory, 1980.

[2] Rabinowitz, P. H. *Numerical Methods for Nonlinear Algebraic Equations*. New York: Gordon and Breach, 1970.

[3] Kelley, C. T. *Iterative Methods for Linear and Nonlinear Equations*. Society for Industrial and Applied Mathematics, Philadelphia, PA: 1995.

Extended Capabilities

C/C++ Code Generation

Generate C and C++ code using Simulink® Coder™.

Not recommended for production code.

See Also

“Algebraic Loop Concepts”

Introduced before R2006a

Argument Inport

Argument input port for Simulink Function block

Description

This block is an argument input port for a function that you define in the Simulink Function block.

Ports

Input

u — Argument input

scalar | vector | matrix

The Argument Inport block accepts complex or real signals of any data type that Simulink supports, including fixed-point and enumerated data types. The Argument Inport block also accepts a bus object as a data type.

The complexity and data type of the block output are the same as the argument input. You can specify the signal type and data type of an input argument to an Argument Inport block using the **Signal type** and **Data type** parameters.

Data Types: single | double | int8 | int16 | int32 | uint8 | uint16 | uint32 | Boolean | fixed point | enumerated | bus

Output

out — Block output

scalar | vector | matrix

Block output signal from this block.

Data Types: single | double | int8 | int16 | int32 | uint8 | uint16 | uint32 | Boolean | fixed point | enumerated | bus

Parameters

Port number — Specify port number of block

1 (default) | integer

Specify the order in which the port that corresponds to the block appears in the parent subsystem or model block.

1

Specify the first port location for this block.

integer

Specify location of port.

Programmatic Use

Block parameter: Port

Type: character vector
Value: '1' | '<integer>'
Default: '1'

Argument name — Specify input argument name

u (default) | character vector

Specify input argument name for the function prototype displayed on the face of the Simulink Function block.

u

Default name for the input argument.

character vector

Name of the input argument.

Programmatic Use

Block parameter: ArgumentName

Type: character vector

Value: 'u' | '<character vector>'

Default: 'u'

Minimum — Specify minimum value for block output

[] (default) | number

Specify the minimum value for the block output signal.

Note If you specify a bus object as the data type for this block, do not set the minimum value for bus data on the block. Simulink ignores this setting. Instead, set the minimum values for bus elements of the bus object specified as the data type. For information on the Minimum property of a bus element, see `Simulink.BusElement`.

Simulink uses this value to perform Simulation range checking and automatic scaling of fixed-point data types.

[]

Minimum value not specified.

number

Finite real double scalar value.

Programmatic Use

Block parameter: OutMin

Type: character vector

Value: '[]' | '<number>'

Default: '[]'

Maximum — Specify maximum value for block output

[] (default) | number

Specify the maximum value for the block output signal.

Note If you specify a bus object as the data type for this block, do not set the maximum value for bus data on the block. Simulink ignores this setting. Instead, set the maximum values for bus elements of

the bus object specified as the data type. For information on the Maximum property of a bus element, see `Simulink.BusElement`.

Simulink uses this value to perform Simulation range checking and automatic scaling of fixed-point data types.

`[]`

Maximum value not specified.

number

Finite real double scalar value.

Programmatic Use

Block parameter: `OutMax`

Type: character vector

Value: `'[]'` | `'<number>'`

Default: `'[]'`

Data type — Specify block output data type

`double` (default) | `single` | `int8` | `uint8` | `int16` | `uint16` | `int32` | `uint32` | `int64` | `uint64` | `boolean` | `fixdt(1,16)` | `fixdt(1,16,0)` | `fixdt(1,16,2^,0)` | `Enum: <class name>` | `Bus: <object name>` | `<data type expression>`

Specify the block output data type.

`double`

Data type is double.

`single`

Data type is single.

`int8`

Data type is int8.

`uint8`

Data type is uint8.

`int16`

Data type is int16.

`uint16`

Data type is uint16.

`int32`

Data type is int32.

`uint32`

Data type is uint32.

`int64`

Data type is int64.

`uint64`

Data type is uint64.

`boolean`

Data type is `boolean`.

`fixdt(1,16,0)`

Data type is fixed point `fixdt(1,16,0)`.

`fixdt(1,16,2^0,0)`

Data type is fixed point `fixdt(1,16,2^0,0)`.

Enum: `<class name>`

Data type is enumerated, for example, Enum: `Basic Colors`.

Bus: `<object name>`

Data type is a `Simulink.Bus` object.

`<data type expression>`

The name of a data type object, for example `Simulink.NumericType`

Tips

You cannot enter the name of a `Simulink.Bus` object as a data type expression. To specify the **Data type** for the block using a Bus object, select the Bus: `<object name>` option and replace `<object name>` with the name of the Bus object.

Programmatic Use

Block parameter: `OutDataTypeStr`

Type: character vector

Value: `'double' | 'single' | 'int8' | 'uint8' | 'int16' | 'uint16' | 'int32' | 'uint32' | 'boolean' | 'fixdt(1,16)' | 'fixdt(1,16,0)' | 'fixdt(1,16,2^0,0)' | '<data type expression>'`

Default: `'double'`

Lock output data type setting against changes by the fixed-point tools — Prevent fixed-point tools from overriding data type

`off` (default) | `on`

Control changes to data type settings from the Fixed-Point Tool and the Fixed-Point Advisor. For more information, see “Use Lock Output Data Type Setting” (Fixed-Point Designer).

On

Locks all data type settings for this block.

Off

Allows the Fixed-Point Tool and the Fixed-Point Advisor to change data type settings for this block.

Programmatic Use

Block parameter: `LockScale`

Type: character vector

Value: `'off' | 'on'`

Default: `'off'`

Port dimensions — Specify port dimensions

`1` (default) | `n` | `[m n]`

Specify the dimensions of the argument input signal to the block. For more information, see Output.

1

Inherit port dimensions.

n

Vector signal of width n.

[m n]

Matrix signal having m rows and n columns.

Programmatic Use

Block parameter: PortDimensions

Type: character vector

Value: '1' | 'n' | '[m n]'

Default: '1'

Signal type — Select real or complex signal

real (default) | complex

Select real or complex signal.

real

Specify the signal type as a real number.

complex

Specify the signal type as a complex number.

Programmatic Use

Block parameter: SignalType

Type: character vector

Value: 'real' | 'complex'

Default: 'real'

See Also

Argument Output | Simulink Function | Function Caller

Topics

“Simulink Functions Overview”

“Argument Specification for Simulink Function Blocks”

Introduced in R2014b

Argument Outputport

Argument output port for Simulink Function block

Description

This block is an output argument port for a function that you define in the Simulink Function block.

Ports

Input

in – Block input

scalar | vector | matrix

Block input signal to this block.

Data Types: single | double | int8 | int16 | int32 | uint8 | uint16 | uint32 | Boolean | fixed point | enumerated | bus

Output

y – Argument output

scalar | vector | matrix

The Argument Outputport block accepts real or complex signals of any data type that Simulink supports. An Argument Outputport block can also accept fixed-point and enumerated data types when the block is not a root-level output port. The Argument Outputport block also accepts a bus object as a data type.

The complexity and data type of the block input are the same as the argument output. You can specify the signal type and data type of an output argument from an Argument Outputport block using the **Signal type** and **Data type** parameters. For more information, see “Data Types Supported by Simulink”.

Data Types: single | double | int8 | int16 | int32 | uint8 | uint16 | uint32 | Boolean | fixed point | enumerated | bus

Parameters

Port number – Specify port number of block

1 (default) | integer

Specify the order in which the port that corresponds to the block appears in the parent subsystem or model block.

1

Specify the first port location for this block.

integer

Specify location of port.

Programmatic Use**Block parameter:** Port**Type:** character vector**Value:** '1' | '<integer>'**Default:** '1'**Argument name — Specify output argument name**

u (default) | character vector

Specify output argument name for the function prototype displayed on the face of the Simulink Function block.

u

Default name of the output argument.

character vector

Name of the output argument.

Programmatic Use**Block parameter:** ArgumentName**Type:** character vector**Value:** 'u' | '<character vector>'**Default:** 'u'**Minimum — Specify minimum value for block input**

[] (default) | number

Specify the minimum value for the block input signal.

Note If you specify a bus object as the data type for this block, do not set the minimum value for bus data on the block. Simulink ignores this setting. Instead, set the minimum values for bus elements of the bus object specified as the data type. For information on the Minimum property of a bus element, see `Simulink.BusElement`.

Simulink uses this value to perform Simulation range checking (see “Specify Signal Ranges”) and automatic scaling of fixed-point data types.

[]

Minimum value not specified.

number

Finite real double scalar value.

Programmatic Use**Block parameter:** OutMin**Type:** character vector**Value:** '[]' | '<number>'**Default:** '[]'**Maximum — Specify maximum value for block input**

[] (default) | number

Specify the maximum value for the block input signal.

Note If you specify a bus object as the data type for this block, do not set the maximum value for bus data on the block. Simulink ignores this setting. Instead, set the maximum values for bus elements of the bus object specified as the data type. For information on the Maximum property of a bus element, see `Simulink.BusElement`.

Simulink uses this value to perform Simulation range checking (see “Specify Signal Ranges”) and automatic scaling of fixed-point data types.

`[]`

Maximum value not specified.

number

Finite real double scalar value.

Programmatic Use

Block parameter: OutMax

Type: character vector

Value: `[]` | `'<number>'`

Default: `[]`

Data type — Specify block input data type

`double` (default) | `single` | `int8` | `uint8` | `int16` | `uint16` | `int32` | `uint32` | `int64` | `uint64` | `boolean` | `fixdt(1,16)` | `fixdt(1,16,0)` | `fixdt(1,16,2^,0)` | Enum: `<class name>` | Bus: `<object name>` | `<data type expression>`

Specify block input data type. For more information, see

- Outport
- “Specify Data Types Using Data Type Assistant”

`double`

Data type is double.

`single`

Data type is single.

`int8`

Data type is int8.

`uint8`

Data type is uint8.

`int16`

Data type is int16.

`uint16`

Data type is uint16.

`int32`

Data type is int32.

`uint32`

Data type is uint32.

`int64`

Data type is `int64`.

`uint64`

Data type is `uint64`.

`boolean`

Data type is `boolean`.

`fixdt(1,16,0)`

Data type is fixed point `fixdt(1,16,0)`.

`fixdt(1,16,2^0,0)`

Data type is fixed point `fixdt(1,16,2^0,0)`.

Enum: `<class name>`

Data type is enumerated, for example, Enum: `Basic Colors`.

Bus: `<object name>`

Data type is a `Simulink.Bus` object.

`<data type expression>`

The name of a data type object, for example `Simulink.NumericType`

Tips

You cannot enter the name of a `Simulink.Bus` object as a data type expression. To specify the **Data type** for the block using a Bus object, select the Bus: `<object name>` option and replace `<object name>` with the name of the Bus object.

Programmatic Use

Block parameter: `OutDataTypeStr`

Type: character vector

Value: `'double' | 'single' | 'int8' | 'uint8' | 'int16' | 'uint16' | 'int32' | 'uint32' | 'int64' | 'uint64' | 'boolean' | '<fixdt(1,16)' | 'fixdt(1,16,0)' | 'fixdt(1,16,2^0,0)' | '<data type expression>'`

Default: `'double'`

Lock output data type setting against changes by the fixed-point tools — Prevent fixed-point tools from overriding data type

`off` (default) | `on`

Control changes to data type settings from the Fixed-Point Tool and the Fixed-Point Advisor. For more information, see “Use Lock Output Data Type Setting” (Fixed-Point Designer).

On

Locks all data type settings for this block.

Off

Allows the Fixed-Point Tool and the Fixed-Point Advisor to change data type settings for this block.

Programmatic Use

Block parameter: `LockScale`

Type: character vector

Value: 'off' | 'on'

Default: 'off'

Port dimensions — Specify port dimensions

1 (default) | n | [m n]

Specify the dimensions of the output argument signal from the block. For more information, see [Output](#).

1

Inherit port dimensions.

n

Vector signal of width n.

[m n]

Matrix signal having m rows and n columns.

Programmatic Use

Block parameter: PortDimensions

Type: character vector

Value: '1' | 'n' | '[m n]'

Default: '1'

Signal type — Select real or complex signal

real (default) | complex

Select real or complex signal. For more information, see [Output](#).

real

Specify the signal type as a real number.

complex

Specify the signal type as a complex number.

Programmatic Use

Block parameter: SignalType

Type: character vector

Value: 'real' | 'complex'

Default: 'real'

See Also

[Argument Inport](#) | [Simulink Function](#) | [Function Caller](#)

Topics

[“Simulink Functions Overview”](#)

[“Argument Specification for Simulink Function Blocks”](#)

Introduced in R2014b

ASCII to String

UInt8 vector signal to string signal

Library: Simulink / String

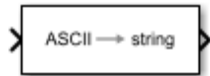

Description

The ASCII to String block converts uint8 vector signals to string signals. The block treats each element in the input vector as an ASCII value during the conversion. For example, the block converts an input vector of [72 101 108 108 111] to the string "Hello".

Ports

Input

Port_1 – ASCII signal

vector

ASCII signal, specified as a vector.

While using dynamic strings, if the length of the input vector exceeds the number of characters specified in the configuration parameter **Buffer size of dynamically-sized string (bytes)** (256 by default), the ASCII to String block truncates the string output to the buffer size-1 (for example, 255), for generated code. To avoid truncation, increase the value of the **Buffer size of dynamically-sized string (bytes)** configuration parameter.

Example: [088 099]

Data Types: uint8

Output

Port_1 – Converted string signal

scalar

Converted string signal from input ASCII signal, specified as a scalar. The block converts each ASCII element in the vector into its alphanumeric equivalent and outputs all elements concatenated into one string.

Data Types: string

Block Characteristics

| | |
|---------------------------------|------------------|
| Data Types | integer string |
| Direct Feedthrough | yes |
| Multidimensional Signals | no |

| | |
|--------------------------------|----|
| Variable-Size Signals | no |
| Zero-Crossing Detection | no |

Extended Capabilities

C/C++ Code Generation

Generate C and C++ code using Simulink® Coder™.

See Also

Compose String | Scan String | String Compare | String Concatenate | String Constant | String Find | String Length | String to Double | String to Single | String To Enum | String To ASCII | Substring | To String

Topics

“String Data Type Conversions”

“Simulink Strings”

Introduced in R2018a

Assertion

Check whether signal is zero

Library: Simulink / Model Verification
HDL Coder / Model Verification

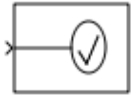

Description

The Assertion block checks whether any of the elements of the input signal are 0. If all of the elements are nonzero, the assertion is `true` (1) and the block does nothing. If not, the block halts the simulation and returns an error message by default.

Ports

Input

Port_1 — Input signal

scalar | vector | matrix

Input signal to the assertion check.

Data Types: half | single | double | int8 | int16 | int32 | int64 | uint8 | uint16 | uint32 | uint64 | Boolean | fixed point | enumerated

Parameters

Enable assertion — Enable or disable check

on (default) | off

Clearing this parameter disables the block and causes the model to behave as if the block does not exist. To enable or disable all verification blocks, regardless of the setting of this option, go to the Configuration Parameters window, click **Diagnostics > Data Validity**, expand the **Advanced parameters** section, and set **Model Verification block enabling** to `Enable all` or `Disable all`.

Programmatic Use

Parameter: enabled

Type: character vector

Values: 'on' | 'off'

Default: 'on'

Simulation callback when assertion fails (optional) — Expression to evaluate when assertion fails

' ' (default) | MATLAB expression

Specify a MATLAB expression to evaluate when the assertion fails. Because the expression is evaluated in the MATLAB workspace, define all variables used in the expression in that workspace.

Dependencies

To enable this parameter, select the **Enable assertion** parameter.

Programmatic Use

Parameter: callback

Type: character vector

Values: MATLAB expression

Default: ''

Stop simulation when assertion fails — Whether to stop simulation when check fails

on (default) | off

Select this parameter to stop the simulation when the check fails. Clear this parameter to display a warning and continue the simulation.

Programmatic Use

Parameter: stopWhenAssertionFail

Type: character vector

Values: 'on' | 'off'

Default: 'on'

Sample time — Specify sample time as a value other than -1

-1 (default) | scalar | vector

Specify the sample time as a value other than -1. For more information, see “Specify Sample Time”.

Dependencies

This parameter is not visible unless it is explicitly set to a value other than -1. To learn more, see “Blocks for Which Sample Time Is Not Recommended”.

Programmatic Use

Block Parameter: SampleTime

Type: character vector

Values: scalar or vector

Default: '-1'

Block Characteristics

| | |
|---------------------------------|--|
| Data Types | Boolean double fixed point half integer single |
| Direct Feedthrough | no |
| Multidimensional Signals | yes |
| Variable-Size Signals | no |
| Zero-Crossing Detection | no |

Extended Capabilities

C/C++ Code Generation

Generate C and C++ code using Simulink® Coder™.

For information about how Simulink Coder™ generated code handles Model Verification blocks, see “Configure Model for Debugging” (Simulink Coder).

Not recommended for production code.

HDL Code Generation

Generate Verilog and VHDL code for FPGA and ASIC designs using HDL Coder™.

HDL Coder provides additional configuration options that affect HDL implementation and synthesized logic.

HDL Architecture

This block can be used for checking whether the input signal is zero during simulation, but is not included in the hardware implementation.

PLC Code Generation

Generate Structured Text code using Simulink® PLC Coder™.

Fixed-Point Conversion

Design and simulate fixed-point systems using Fixed-Point Designer™.

See Also

[Check Dynamic Lower Bound](#) | [Check Dynamic Upper Bound](#) | [Check Static Lower Bound](#) | [Check Static Upper Bound](#)

Introduced before R2006a

Assignment

Assign values to specified elements of signal

Library: Simulink / Math Operations
HDL Coder / Math Operations



Description

The Assignment block assigns values to specified elements of the signal. You specify the indices of the elements to be assigned values either by entering the indices in the block dialog box or by connecting an external indices source or sources to the block. The signal at the block data port, U, specifies values to be assigned to Y. The block replaces the specified elements of Y with elements from the data signal.

Based on the value you enter for the **Number of output dimensions** parameter, a table of index options is displayed. Each row of the table corresponds to one of the output dimensions in **Number of output dimensions**. For each dimension, you can define the elements of the signal to work with. Specify a vector signal as a 1-D signal and a matrix signal as a 2-D signal. To enable an external index port, in the corresponding row of the table, set **Index Option** to **Index vector (port)**.

For example, assume a 5-D signal with a one-based index mode. The table in the Assignment block dialog changes to include one row for each dimension. If you define each dimension with the following entries:

| Row | Index Option | Index |
|-----|-------------------------|---------|
| 1 | Assign all | |
| 2 | Index vector (dialog) | [1 3 5] |
| 3 | Starting index (dialog) | 4 |
| 4 | Starting index (port) | |
| 5 | Index vector (port) | |

The assigned values are $Y(1:\text{end}, [1\ 3\ 5], 4:3+\text{size}(U,3), \text{Idx}4:\text{Idx}4+\text{size}(U,4)-1, \text{Idx}5)=U$, where $\text{Idx}4$ and $\text{Idx}5$ are the input ports for dimensions 4 and 5.

When using the Assignment block in normal mode, Simulink initializes block outputs to zero even if the model does not explicitly initialize them. In accelerator mode, Simulink converts the model into an S-Function. This involves code generation. The code generated may not do implicit initialization of block outputs. In such cases, you must explicitly initialize the model outputs.

You can use the block to assign values to vector, matrix, or multidimensional signals.

You can use an array of buses as an input signal to an Assignment block.

Assignment Block in Conditional Subsystem

If you place an Assignment block in a conditional subsystem block, a hidden signal buffer (which is equivalent to a Signal Copy block) is inserted in many cases, and merging of signals from Assignment blocks with partial writes can cause an error.

However, if you select the **Ensure output is virtual** parameter for the conditional subsystem Outputport block, such cases are supported and partial writes to arrays using Assignment blocks are possible. See “Ensure Output is Virtual”.

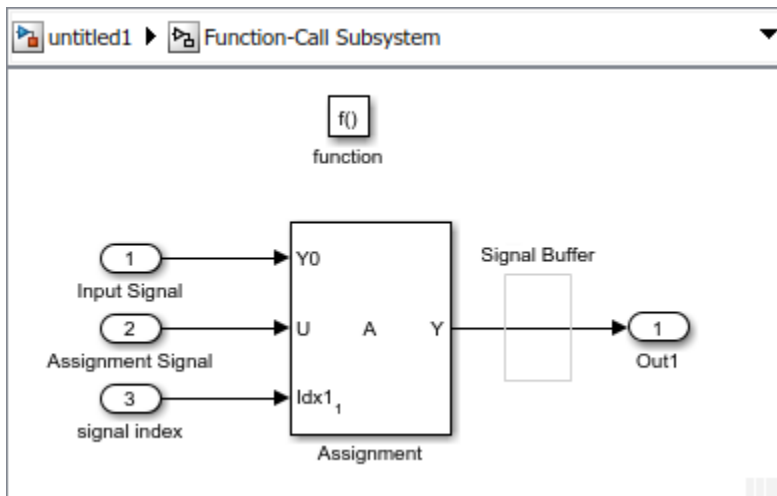

Ports

Input

Y0 – Input initialization signal

scalar | vector

The initialization signal for the output signal. If an element is not assigned another value, then the value of the output element matches this input signal value.

Data Types: single | double | int8 | int16 | int32 | int64 | uint8 | uint16 | uint32 | uint64 | fixed point | Boolean | enumerated | bus

U – Input data port

scalar | vector

Value assigned to the output element when specified.

Data Types: single | double | int8 | int16 | int32 | int64 | uint8 | uint16 | uint32 | uint64 | fixed point | Boolean | enumerated | bus

IdxN – Nth index signal

scalar | vector

External port specifying an index for the assignment of the corresponding output element.

Dependencies

To enable an external index port, in the corresponding row of the **Index Option** table, set **Index Option** to `Index vector (port)` or `Starting index (port)`.

Data Types: `single` | `double` | `int8` | `int16` | `int32` | `uint8` | `uint16` | `uint32`

Output

Y – Output signal with assigned values

`scalar` | `vector`

The output signal with assigned values for the specified elements.

Data Types: `single` | `double` | `int8` | `int16` | `int32` | `int64` | `uint8` | `uint16` | `uint32` | `uint64` | `fixed point` | `enumerated` | `bus`

Parameters

Number of output dimensions – Number of dimensions of the output signal

`1` (default) | `integer`

Enter the number of dimensions of the output signal.

Programmatic Use

Parameter: `NumberOfDimensions`

Type: `character vector`

Values: `integer`

Default: `'1'`

Index mode – Index mode

`One-based` (default) | `Zero-based`

Select the indexing mode. If `One-based` is selected, an index of 1 specifies the first element of the input vector. If `Zero-based` is selected, an index of 0 specifies the first element of the input vector.

Programmatic Use

Parameter: `IndexMode`

Type: `character vector`

Values: `'Zero-based'` | `'One-based'`

Default: `'One-based'`

Index Option – Index method for elements

`Index vector (dialog)` (default) | `Assign all` | `Index vector (port)` | `Starting index (dialog)` | `Starting index (port)`

Define, by dimension, how the elements of the signal are to be indexed. From the list, select:

| Menu Item | Action |
|------------------------------------|---|
| <code>Assign all</code> | This is the default. All elements are assigned. |
| <code>Index vector (dialog)</code> | Enables the Index column. Enter the indices of elements. |
| <code>Index vector (port)</code> | Disables the Index column. The index port defines the indices of elements. |

| Menu Item | Action |
|-------------------------|---|
| Starting index (dialog) | Enables the Index column. Enter the starting index of the range of elements to be assigned values. |
| Starting index (port) | Disables the Index column. The index port defines the starting index of the range of elements to be assigned values. |

If you choose **Index vector (port)** or **Starting index (port)** for any dimension in the table, you can specify one of these values for the **Initialize output (Y)** parameter:

- Initialize using input port <Y0>
- Specify size for each dimension in table

Otherwise, Y0 always initializes output port Y.

The **Index** and **Output Size** columns are displayed as relevant.

Programmatic Use

Parameter: IndexOptionArray

Type: character vector

Values: 'Assign all' | 'Index vector (dialog)' | 'Index option (port)' | 'Starting index (dialog)' | 'Starting index (port)'

Default: 'Index vector (dialog)'

Index — Index of elements

1 (default) | integer

If the **Index Option** is **Index vector (dialog)**, enter the index of each element you are interested in.

If the **Index Option** is **Starting index (dialog)**, enter the starting index of the range of elements to be selected. The number of elements from the starting point is determined by the size of this dimension at U.

Programmatic Use

Parameter: IndexParamArray

Type: character vector

Values: cell array

Default: '{ }'

Output Size — Width of the block output signal

1 (default) | integer

Enter the width of the block output signal.

Dependencies

To enable this column, select **Specify size for each dimension in table** for the **Initialize output (Y)** parameter.

Programmatic Use

Parameter: OutputSizeArray

Type: character vector

Values: cell array

Default: '{ }'

Initialize output (Y) — How to initialize the output signal

Initialize using input port <Y0> (default) | Specify size for each dimension in the table

Specify how to initialize the output signal.

- Initialize using input port <Y0> - Signal at the input port Y0 initializes the output.
- Specify size for each dimension in table - Requires you to specify the width of the block's output signal in the **Output Size** parameter. If the output has unassigned elements, the value of those elements is undefined.

Dependency

Enabled when you set **Index Option** to Index vector (port) or Starting index (port).

Programmatic Use

Parameter: OutputInitialize

Type: character vector

Values: 'Initialize using input port <Y0>' | 'Specify size for each dimension in table'

Default: 'Initialize using input port <Y0>'

Action if any output element is not assigned — Specify whether to produce a warning or error if you have not assigned all output elements

Error (default) | Warning | None

Specify whether to produce a warning or error if you have not assigned all output elements. Options include:

- Error — Simulink software terminates the simulation and displays an error.
- Warning — Simulink software displays a warning and continues the simulation.
- None — Simulink software takes no action.

Programmatic Use

Parameter: DiagnosticForDimensions

Type: character vector

Values: 'Error' | 'Warning' | 'None'

Default: 'None'

Sample time — Specify sample time as a value other than -1

-1 (default) | scalar | vector

Specify the sample time as a value other than -1. For more information, see “Specify Sample Time”.

Dependencies

This parameter is not visible unless it is explicitly set to a value other than -1. To learn more, see “Blocks for Which Sample Time Is Not Recommended”.

Programmatic Use

Block Parameter: SampleTime

Type: character vector

Values: scalar or vector

Default: '-1'

Block Characteristics

| | |
|---------------------------------|--|
| Data Types | Boolean double enumerated fixed point integer single |
| Direct Feedthrough | yes |
| Multidimensional Signals | yes |
| Variable-Size Signals | yes |
| Zero-Crossing Detection | no |

Extended Capabilities

C/C++ Code Generation

Generate C and C++ code using Simulink® Coder™.

HDL Code Generation

Generate Verilog and VHDL code for FPGA and ASIC designs using HDL Coder™.

HDL Coder provides additional configuration options that affect HDL implementation and synthesized logic.

HDL Architecture

This block has a single, default HDL architecture.

HDL Block Properties

| | |
|----------------------------------|--|
| ConstrainedOutputPipeline | Number of registers to place at the outputs by moving existing delays within your design. Distributed pipelining does not redistribute these registers. The default is 0. For more details, see “ConstrainedOutputPipeline” (HDL Coder). |
| InputPipeline | Number of input pipeline stages to insert in the generated code. Distributed pipelining and constrained output pipelining can move these registers. The default is 0. For more details, see “InputPipeline” (HDL Coder). |
| OutputPipeline | Number of output pipeline stages to insert in the generated code. Distributed pipelining and constrained output pipelining can move these registers. The default is 0. For more details, see “OutputPipeline” (HDL Coder). |

Complex Data Support

This block supports code generation for complex signals.

Restrictions

- 3-dimensional matrix inputs are not supported. You can use 1-D vectors and 2-D matrices with the block.

- Variable-size signals are not supported for code generation.

PLC Code Generation

Generate Structured Text code using Simulink® PLC Coder™.

Fixed-Point Conversion

Design and simulate fixed-point systems using Fixed-Point Designer™.

See Also

“Group Nonvirtual Buses in Arrays of Buses” | Bus Assignment

Introduced before R2006a

Backlash

Model behavior of system with play

Library: Simulink / Discontinuities
HDL Coder / Discontinuities

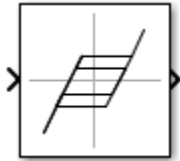

Description

The Backlash block implements a system in which a change in input causes an equal change in output, except when the input changes direction. When the input changes direction, the initial change in input has no effect on the output. The amount of side-to-side play in the system is referred to as the *deadband*. The deadband is centered about the output. This figure shows an initial state, with the default deadband width of 1 and initial output of 0.

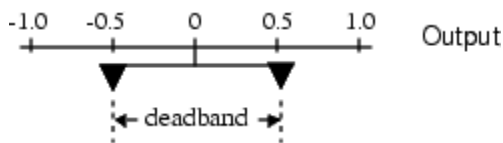

A system with play can be in one of three modes.

| Mode | Input | Output |
|----------------------------|---------------------------------------|---|
| Disengaged | Inside deadband zone. | Remains constant. |
| Engaged-positive direction | Outside deadband zone and increasing. | Equals input <i>minus</i> half of deadband width. |
| Engaged-negative direction | Outside deadband zone and decreasing. | Equals input <i>plus</i> half of deadband width. |

The **Initial output** parameter value defines the initial center of the deadband zone.

This table shows output values when initial conditions are: **Deadband width** = 2 and **Initial output** = 5.

| Output Value | Condition |
|--------------------|------------------------------|
| 5 | $4 \leq \text{input} \leq 6$ |
| $\text{input} + 1$ | $\text{input} < 4$ |
| $\text{input} - 1$ | $\text{input} > 6$ |

For example, you can use the Backlash block to model the meshing of two gears. The input and output are both shafts with a gear on one end, and the input shaft drives the output shaft. Extra space between the gear teeth introduces *play*. The width of this spacing is the **Deadband width** parameter. If the system is disengaged initially, the **Initial output** parameter defines the output.

These figures illustrate operation when the initial input is within the deadband and the system begins in disengaged mode.

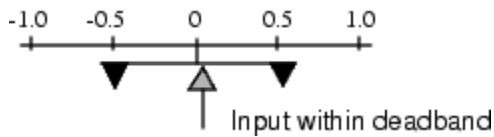

When the input increases and reaches the end of the deadband, it engages the output. The output remains at its previous value.

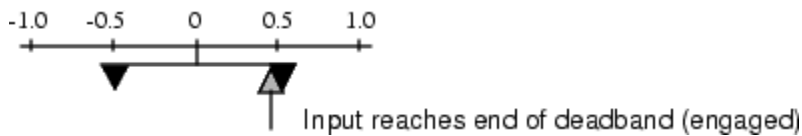

After the input engages the output, the output changes by the same amount as the input.

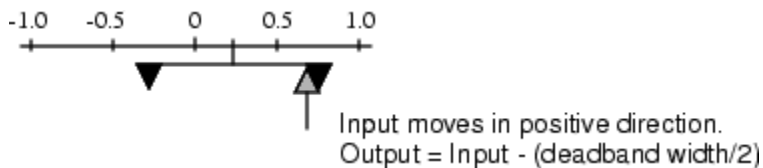

If the input reverses direction, it disengages from the output. The output remains constant until the input reaches the end of the deadband and engages again.

Ports

Input

Port_1 — Input signal

scalar | vector

Input signal to the backlash algorithm. The value of this signal is either in the deadband or engaging the output in a positive or negative direction.

Data Types: double | single | int8 | int16 | int32 | uint8 | uint16 | uint32

Output

Port_1 — Output signal

scalar | vector

Output signal after the backlash algorithm is applied to the input signal. When the input is in the deadband, then the output remains unchanged. If the input is engaged with the output, then the output changes an equal amount as the input.

Data Types: double | single | int8 | int16 | int32 | uint8 | uint16 | uint32

Parameters

Deadband width — Specify the width of the deadband

1 (default) | scalar | vector

Specify the size of the deadband zone centered on the output value. When the input signal is inside the deadband, then a change in input does not cause a change in output. When the input signal is outside of the deadband, then the output changes an equal amount as the input.

Programmatic Use

Block Parameter: BacklashWidth

Type: character vector

Values: real scalar or vector

Default: '1'

Initial output — Specify the initial output value

0 (default) | scalar | vector

Specify the initial center of the deadband zone. If the initial input value is in the deadband zone, then the output value is equal to **Initial output**. If the initial input value is outside of the deadband zone, then the output value is **Initial output** plus or minus half of the deadzone width.

Programmatic Use

Block Parameter: InitialOutput

Type: character vector

Values: real scalar or vector

Default: '0'

Input processing — Specify sample- or frame-based processing

Elements as channels (sample based) (default) | Columns as channels (frame based)

Specify whether the block performs sample- or frame-based processing:

- Columns as channels (frame based) — Treat each column of the input as a separate channel (frame-based processing).

Note Frame-based processing requires a DSP System Toolbox™ license.

For more information, see “Sample- and Frame-Based Concepts” (DSP System Toolbox).

- Elements as channels (sample based) — Treat each element of the input as a separate channel (sample-based processing).

Use **Input processing** to specify whether the block performs sample- or frame-based processing. For more information about these two processing modes, see “Sample- and Frame-Based Concepts” (DSP System Toolbox).

Programmatic Use

Block Parameter: InputProcessing

Type: character vector

Values: 'Columns as channels (frame based)' | 'Elements as channels (sample based)'

Default: 'Elements as channels (sample based)'

Enable zero-crossing detection — Enable zero-crossing detection

on (default) | Boolean

Select to enable zero-crossing detection. For more information, see “Zero-Crossing Detection” in the Simulink documentation.

Programmatic Use**Block Parameter:** ZeroCross**Type:** character vector, string**Values:** 'off' | 'on'**Default:** 'on'**Block Characteristics**

| | |
|---------------------------------|---------------------------|
| Data Types | double integer single |
| Direct Feedthrough | yes |
| Multidimensional Signals | no |
| Variable-Size Signals | no |
| Zero-Crossing Detection | yes |

Extended Capabilities**C/C++ Code Generation**

Generate C and C++ code using Simulink® Coder™.

Generated code relies on memcpy or memset function (string.h) in certain conditions.

HDL Code Generation

Generate Verilog and VHDL code for FPGA and ASIC designs using HDL Coder™.

HDL Coder provides additional configuration options that affect HDL implementation and synthesized logic.

HDL Architecture

This block has a single, default HDL architecture.

HDL Block Properties

| | |
|----------------------------------|--|
| ConstrainedOutputPipeline | Number of registers to place at the outputs by moving existing delays within your design. Distributed pipelining does not redistribute these registers. The default is 0. For more details, see “ConstrainedOutputPipeline” (HDL Coder). |
| InputPipeline | Number of input pipeline stages to insert in the generated code. Distributed pipelining and constrained output pipelining can move these registers. The default is 0. For more details, see “InputPipeline” (HDL Coder). |
| OutputPipeline | Number of output pipeline stages to insert in the generated code. Distributed pipelining and constrained output pipelining can move these registers. The default is 0. For more details, see “OutputPipeline” (HDL Coder). |

RestrictionsThe **Deadband width** and **Initial output** parameters support only scalar values.

See Also

Dead Zone

Introduced before R2006a

Band-Limited White Noise

Introduce white noise into continuous system

Library: Simulink / Sources



Description

The Band-Limited White Noise block generates normally distributed random numbers that are suitable for use in continuous or hybrid systems.

Simulation of White Noise

Theoretically, continuous white noise has a correlation time of 0, a flat power spectral density (PSD), and a total energy of infinity. In practice, physical systems are never disturbed by white noise, although white noise is a useful theoretical approximation when the noise disturbance has a correlation time that is very small relative to the natural bandwidth of the system.

In Simulink software, you can simulate the effect of white noise by using a random sequence with a correlation time much smaller than the shortest time constant of the system. The Band-Limited White Noise block produces such a sequence. The correlation time of the noise is the sample rate of the block. For accurate simulations, use a correlation time much smaller than the fastest dynamics of the system. You can get good results by specifying

$$tc \approx \frac{1}{100} \frac{2\pi}{f_{max}}$$

where f_{max} is the bandwidth of the system in rad/sec.

Comparison with the Random Number Block

The primary difference between this block and the Random Number block is that the Band-Limited White Noise block produces output at a specific sample rate. This rate is related to the correlation time of the noise.

Usage with the Averaging Power Spectral Density Block

The Band-Limited White Noise block specifies a two-sided spectrum, where the units are Hz. The Averaging Power Spectral Density block specifies a one-sided spectrum, where the units are the square of the magnitude per unit radial frequency: $\text{mag}^2/(\text{rad}/\text{sec})$. When you feed the output of a Band-Limited White Noise block into an Averaging Power Spectral Density block, the average PSD value is π times smaller than the **Noise power** of the Band-Limited White Noise block. This difference is the result of converting the units of one block to the units of the other, $1/(1/2)(2\pi) = 1/\pi$, where:

- $1/2$ is the factor for converting from a two-sided to one-sided spectrum.
- 2π is the factor for converting from Hz to rad/sec.

Ports

Output

Port_1 — Normally distributed random numbers

scalar | vector | matrix | N-D array

Normally distributed random numbers specified as a scalar, vector, matrix, or N-D array.

Data Types: double

Parameters

Noise power — Height of PSD of white noise

[0.1] (default) | scalar | vector | matrix | N-D array

Specify the height of the PSD of the white noise as a scalar, vector, matrix, or N-D array of positive values.

Programmatic Use

Block Parameter: Cov

Type: character vector

Values: scalar | vector | matrix | N-D array

Default: '[0.1]'

Sample time — Correlation time of noise

0.1 (default) | scalar | vector

Correlation time of the noise. For more information, see “Specify Sample Time”.

Programmatic Use

Block Parameter: Ts

Type: character vector

Values: scalar | vector

Default: '0.1'

Seed — Starting seed

[23341] (default) | scalar | vector | matrix | N-D array

Specify the starting seed for the random number generator as a scalar, vector, matrix, or N-D array. Values must be positive, real-valued, and finite.

Programmatic Use

Block Parameter: seed

Type: character vector

Values: scalar | vector | matrix | N-D array

Default: '[23341]'

Interpret vector parameters as 1-D — Treat vector parameters as 1-D

on (default) | off

Select to output a 1-D array when the block parameters are vectors. Otherwise, output a 2-D array one of whose dimensions is 1. For more information, see “Determine the Output Dimensions of Source Blocks”.

Programmatic Use**Block Parameter:** VectorParams1D**Type:** character vector**Values:** 'on' | 'off'**Default:** 'on'**Block Characteristics**

| | |
|---------------------------------|--------|
| Data Types | double |
| Direct Feedthrough | no |
| Multidimensional Signals | no |
| Variable-Size Signals | no |
| Zero-Crossing Detection | no |

Algorithms

To produce the correct intensity of this noise, the covariance of the noise is scaled to reflect the implicit conversion from a continuous PSD to a discrete noise covariance. The appropriate scale factor is $1/tc$, where tc is the correlation time of the noise. This scaling ensures that the response of a continuous system to the approximate white noise has the same covariance as the system would have to true white noise. Because of this scaling, the covariance of the signal from the Band-Limited White Noise block is not the same as the **Noise power** (intensity) parameter. This parameter is actually the height of the PSD of the white noise. This block approximates the covariance of white noise as the **Noise power** divided by tc .

Extended Capabilities**C/C++ Code Generation**

Generate C and C++ code using Simulink® Coder™.

Cannot use inside a triggered subsystem hierarchy.

See Also

Random Number

Topics

"Sample Time"

Introduced before R2006a

Bias

Add bias to input

Library: Simulink / Math Operations
 HDL Coder / HDL Floating Point Operations
 HDL Coder / Math Operations

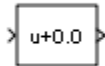

Description

The Bias block adds a bias, or offset, to the input signal according to

$$Y = U + bias$$

where U is the block input and Y is the output.

Ports

Input

Port_1 — Input signal

scalar | vector

Input signal to which the bias is added to create the output signal.

Data Types: half | single | double | int8 | int16 | int32 | int64 | uint8 | uint16 | uint32 | uint64 | fixed point

Output

Port_1 — Output signal

scalar | vector

Output signal resulting from adding the bias to the input signal.

Data Types: half | single | double | int8 | int16 | int32 | int64 | uint8 | uint16 | uint32 | uint64 | fixed point

Parameters

Bias — Offset to add to the input signal

0.0 (default) | scalar | vector

Specify the value of the offset to add to the input signal.

Programmatic Use

Block Parameter: Bias

Type: character vector

Values: real, finite

Default: '0.0'

Saturate on integer overflow — Choose the behavior when integer overflow occurs

off (default) | on

| Action | Reasons for Taking This Action | What Happens for Overflows | Example |
|-------------------------------|---|---|---|
| Select this check box. | Your model has possible overflow, and you want explicit saturation protection in the generated code. | Overflows saturate to either the minimum or maximum value that the data type can represent. | The maximum value that the <code>int8</code> (signed, 8-bit integer) data type can represent is 127. Any block operation result greater than this maximum value causes overflow of the 8-bit integer. With the check box selected, the block output saturates at 127. Similarly, the block output saturates at a minimum output value of -128. |
| Do not select this check box. | You want to optimize efficiency of your generated code. You want to avoid overspecifying how a block handles out-of-range signals. For more information, see “Troubleshoot Signal Range Errors”. | Overflows wrap to the appropriate value that is representable by the data type. | The maximum value that the <code>int8</code> (signed, 8-bit integer) data type can represent is 127. Any block operation result greater than this maximum value causes overflow of the 8-bit integer. With the check box cleared, the software interprets the overflow-causing value as <code>int8</code> , which can produce an unintended result. For example, a block result of 130 (binary 1000 0010) expressed as <code>int8</code> , is -126. |

When you select this check box, saturation applies to every internal operation on the block, not just the output or result. Usually, the code generation process can detect when overflow is not possible. In this case, the code generator does not produce saturation code.

Programmatic Use

Block Parameter: DoSatur

Type: character vector

Value: 'off' | 'on'

Default: 'off'

Block Characteristics

| | |
|-------------------|--|
| Data Types | double fixed point half integer single |
|-------------------|--|

| | |
|---------------------------------|-----|
| Direct Feedthrough | yes |
| Multidimensional Signals | no |
| Variable-Size Signals | yes |
| Zero-Crossing Detection | no |

Extended Capabilities

C/C++ Code Generation

Generate C and C++ code using Simulink® Coder™.

HDL Code Generation

Generate Verilog and VHDL code for FPGA and ASIC designs using HDL Coder™.

HDL Coder provides additional configuration options that affect HDL implementation and synthesized logic.

HDL Architecture

This block has a single, default HDL architecture.

HDL Block Properties

| | |
|----------------------------------|--|
| ConstrainedOutputPipeline | Number of registers to place at the outputs by moving existing delays within your design. Distributed pipelining does not redistribute these registers. The default is 0. For more details, see “ConstrainedOutputPipeline” (HDL Coder). |
| InputPipeline | Number of input pipeline stages to insert in the generated code. Distributed pipelining and constrained output pipelining can move these registers. The default is 0. For more details, see “InputPipeline” (HDL Coder). |
| OutputPipeline | Number of output pipeline stages to insert in the generated code. Distributed pipelining and constrained output pipelining can move these registers. The default is 0. For more details, see “OutputPipeline” (HDL Coder). |

PLC Code Generation

Generate Structured Text code using Simulink® PLC Coder™.

Fixed-Point Conversion

Design and simulate fixed-point systems using Fixed-Point Designer™.

See Also

Add | Gain | Divide

Introduced before R2006a

Bit Clear

Set specified bit of stored integer to zero

Library: Simulink / Logic and Bit Operations
HDL Coder / Logic and Bit Operations



Description

The Bit Clear block sets the specified bit, given by its index, of the stored integer to zero. Scaling is ignored.

You can specify the bit to be set to zero with the **Index of bit** parameter, where bit zero is the least significant bit.

Ports

The Bit Clear block supports Simulink integer, fixed-point, and Boolean data types. The block does not support true floating-point data types or enumerated data types.

Input

Port_1 — Input signal

scalar or vector

The input signal is the specified bit of the stored integer.

Data Types: `single` | `double` | `Boolean` | `fixed point`

Output

Port_1 — Output signal

scalar or vector

The output consists of the specified bit set to zero.

Data Types: `single` | `double` | `int8` | `int16` | `int32` | `int64` | `uint8` | `uint16` | `uint32` | `uint64` | `Boolean` | `fixed point` | `enumerated` | `bus`

Parameters

Index of bit — Index of bit

0 (default) | scalar or vector

Index of bit where bit 0 is the least significant bit.

Programmatic Use**Block Parameter:** iBit**Type:** scalar or vector**Values:** {'0'}**Default:** '0'**Block Characteristics**

| | |
|---------------------------------|--|
| Data Types | Boolean ^a fixed point integer |
| Direct Feedthrough | yes |
| Multidimensional Signals | yes |
| Variable-Size Signals | no |
| Zero-Crossing Detection | no |

a. Bit operations are not recommended for use with Boolean signals.

Extended Capabilities**C/C++ Code Generation**

Generate C and C++ code using Simulink® Coder™.

HDL Code Generation

Generate Verilog and VHDL code for FPGA and ASIC designs using HDL Coder™.

HDL Coder provides additional configuration options that affect HDL implementation and synthesized logic.

HDL Architecture

This block has a single, default HDL architecture.

HDL Block Properties

| | |
|----------------------------------|--|
| ConstrainedOutputPipeline | Number of registers to place at the outputs by moving existing delays within your design. Distributed pipelining does not redistribute these registers. The default is 0. For more details, see “ConstrainedOutputPipeline” (HDL Coder). |
| InputPipeline | Number of input pipeline stages to insert in the generated code. Distributed pipelining and constrained output pipelining can move these registers. The default is 0. For more details, see “InputPipeline” (HDL Coder). |
| OutputPipeline | Number of output pipeline stages to insert in the generated code. Distributed pipelining and constrained output pipelining can move these registers. The default is 0. For more details, see “OutputPipeline” (HDL Coder). |

PLC Code Generation

Generate Structured Text code using Simulink® PLC Coder™.

Fixed-Point Conversion

Design and simulate fixed-point systems using Fixed-Point Designer™.

See Also

Bit Set | Bitwise Operator | Bit Rotate | Bit Shift

Introduced before R2006a

Bit Set

Set specified bit of stored integer to one

Library: Simulink / Logic and Bit Operations
HDL Coder / Logic and Bit Operations



Description

The Bit Set block sets the specified bit of the stored integer to one. Scaling is ignored.

You can specify the bit to be set to one with the **Index of bit** parameter, where bit zero is the least significant bit.

Ports

Input

Port_1 — Input signal

scalar or vector

Input signal with the specified bit of the stored integer.

Data Types: `single` | `double` | `Boolean` | `fixed point`

Output

Port_1 — Output signal

scalar or vector

Output signal with the specified bit set to 1.

Data Types: `single` | `double` | `int8` | `int16` | `int32` | `int64` | `uint8` | `uint16` | `uint32` | `uint64` | `Boolean` | `fixed point` | `enumerated` | `bus`

Parameters

Index of bit — Index of bit

0 (default) | scalar or vector

Index of bit where bit 0 is the least significant bit.

Programmatic Use

Block Parameter: `iBit`

Type: character vector

Values: positive integer

Default: '0'

Block Characteristics

| | |
|---------------------------------|--|
| Data Types | Boolean ^a fixed point integer |
| Direct Feedthrough | yes |
| Multidimensional Signals | yes |
| Variable-Size Signals | no |
| Zero-Crossing Detection | no |

a. Bit operations are not recommended for use with Boolean signals.

Extended Capabilities

C/C++ Code Generation

Generate C and C++ code using Simulink® Coder™.

HDL Code Generation

Generate Verilog and VHDL code for FPGA and ASIC designs using HDL Coder™.

HDL Coder provides additional configuration options that affect HDL implementation and synthesized logic.

HDL Architecture

This block has a single, default HDL architecture.

HDL Block Properties

| | |
|----------------------------------|--|
| ConstrainedOutputPipeline | Number of registers to place at the outputs by moving existing delays within your design. Distributed pipelining does not redistribute these registers. The default is 0. For more details, see “ConstrainedOutputPipeline” (HDL Coder). |
| InputPipeline | Number of input pipeline stages to insert in the generated code. Distributed pipelining and constrained output pipelining can move these registers. The default is 0. For more details, see “InputPipeline” (HDL Coder). |
| OutputPipeline | Number of output pipeline stages to insert in the generated code. Distributed pipelining and constrained output pipelining can move these registers. The default is 0. For more details, see “OutputPipeline” (HDL Coder). |

PLC Code Generation

Generate Structured Text code using Simulink® PLC Coder™.

Fixed-Point Conversion

Design and simulate fixed-point systems using Fixed-Point Designer™.

See Also

Bit Clear | Bitwise Operator | Bit Rotate | Bit Shift

Introduced before R2006a

Bitwise Operator

Specified bitwise operation on inputs

Library: Simulink / Logic and Bit Operations
HDL Coder / Logic and Bit Operations

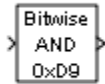

Description

The Bitwise Operator block performs the bitwise operation that you specify on one or more operands. Unlike logic operations of the Logical Operator block, bitwise operations treat the operands as a vector of bits rather than a single value.

Restrictions on Block Operations

The Bitwise Operator block does not support shift operations. For shift operations, use the Shift Arithmetic block.

When configured as a multi-input XOR gate, this block performs modulo-2 addition according to the IEEE® Standard for Logic Elements.

Ports

Input

Port_1 — Input signal

scalar | vector

Input signal, specified as a scalar or vector.

- The NOT operator accepts only one input, which can be a scalar or a vector. If the input is a vector, the output is a vector of the same size containing the bitwise logical complements of the input vector elements.
- For a single vector input, the block applies the operation (except the NOT operator) to all elements of the vector.
- For two or more inputs, the block performs the operation between all of the inputs. If the inputs are vectors, the block performs the operation between corresponding elements of the vectors to produce a vector output.

Data Types: int8 | int16 | int32 | int64 | uint8 | uint16 | uint32 | uint64 | Boolean | fixed point

Output

Port_1 — Output signal

scalar | vector

The output signal specified as the output data type, which the block inherits from the driving block, must represent zero exactly. Data types that satisfy this condition include signed and unsigned integer data types.

The size of the block output depends on the number of inputs, the vector size, and the operator you select. If you do not specify a bit mask, the output is a scalar. If you do specify a bit mask, the output is a vector.

Data Types: `int8` | `int16` | `int32` | `int64` | `uint8` | `uint16` | `uint32` | `uint64` | `Boolean` | `fixed point`

Parameters

Operator – Bitwise logical operator

`AND` (default) | `OR` | `NOR` | `NAND` | `XOR` | `NOT`

Specify the bitwise logical operator for the block operands.

You can select one of these bitwise operations:

| Bitwise Operation | Description |
|-------------------|--|
| AND | TRUE if the corresponding bits are all TRUE |
| OR | TRUE if at least one of the corresponding bits is TRUE |
| NAND | TRUE if at least one of the corresponding bits is FALSE |
| NOR | TRUE if no corresponding bits are TRUE |
| XOR | TRUE if an odd number of corresponding bits are TRUE |
| NOT | TRUE if the input is FALSE (available only for single input) |

Programmatic Use

Block Parameter: `logicop`

Type: character vector

Values: `'AND'` | `'OR'` | `'NAND'` | `'NOR'` | `'XOR'` | `'NOT'`

Default: `'AND'`

Use bit mask – Select to use bit mask

`checked` (default) | `unchecked`

Select to use the bit mask. Clearing this check box enables **Number of input ports** and disables **Bit Mask** and **Treat mask as**.

Programmatic Use

Block Parameter: `UseBitMask`

Type: character vector

Values: `'off'` | `'on'`

Default: `'on'`

Number of input ports – Number of input signals

`1` (default) | integer

Specify the number of inputs. You can have more than one input ports.

Dependency

Clearing the **Use bit mask** check box enables **Number of input ports** and disables **Bit Mask** and **Treat mask as**.

Programmatic Use

Block Parameter: NumInputPorts

Type: character vector

Values: positive integer

Default: '1'

Bit Mask – Bit mask to associate with a single input

bin2dec (default)

Specify the bit mask to associate with a single input. This parameter reads values as hexadecimal values.

You can use the bit mask to set, get, or clear a bit on the input.

| To perform a... | Set the Operator parameter to... | And create a bit mask with... |
|-----------------|----------------------------------|--|
| Bit set | OR | A 1 for each corresponding input bit that you want to set to 1 |
| Bit clear | AND | A 0 for each corresponding input bit that you want to set to 0 |
| Bit get | AND | A 1 for each corresponding input bit that you want to get |

Suppose you want to set the fourth bit of an 8-bit input vector. The bit mask would be 00010000, which you can specify as 2^4 for the **Bit Mask** parameter. To clear the bit, the bit mask would be 11101111, which you can specify as $2^7+2^6+2^5+2^3+2^2+2^1+2^0$ for the **Bit Mask** parameter.

Tip Do not use a mask greater than 53 bits. Otherwise, an error message appears during simulation.

Dependency

This parameter is available only when you select **Use bit mask**.

Programmatic Use

Block Parameter: BitMask

Type: character vector

Values: positive integer

Default: 'bin2dec('11011001')'

Treat mask as – Treat the mask as a real-world value or a stored integer

Stored Integer (default) | Real World Value

Specify whether to treat the mask as a real-world value or a stored integer.

The encoding scheme is $V = SQ + B$, as described in “Scaling” (Fixed-Point Designer) in the Fixed-Point Designer™ documentation. Real World Value treats the mask as V . Stored Integer treats the mask as Q .

Dependency

This parameter is available only when you select **Use bit mask**.

Programmatic Use

Block Parameter: BitMaskRealWorld

Type: character vector

Values: 'Real World Value' | 'Stored Integer'

Default: 'Stored Integer'

Block Characteristics

| | |
|---------------------------------|--|
| Data Types | Boolean ^a fixed point integer |
| Direct Feedthrough | no |
| Multidimensional Signals | yes |
| Variable-Size Signals | no |
| Zero-Crossing Detection | no |

a. Bit operations are not recommended for use with Boolean signals.

Extended Capabilities

C/C++ Code Generation

Generate C and C++ code using Simulink® Coder™.

HDL Code Generation

Generate Verilog and VHDL code for FPGA and ASIC designs using HDL Coder™.

HDL Coder provides additional configuration options that affect HDL implementation and synthesized logic.

HDL Architecture

This block has a single, default HDL architecture.

HDL Block Properties

| | |
|----------------------------------|--|
| ConstrainedOutputPipeline | Number of registers to place at the outputs by moving existing delays within your design. Distributed pipelining does not redistribute these registers. The default is 0. For more details, see “ConstrainedOutputPipeline” (HDL Coder). |
| InputPipeline | Number of input pipeline stages to insert in the generated code. Distributed pipelining and constrained output pipelining can move these registers. The default is 0. For more details, see “InputPipeline” (HDL Coder). |

| | |
|-----------------------|--|
| OutputPipeline | Number of output pipeline stages to insert in the generated code. Distributed pipelining and constrained output pipelining can move these registers. The default is 0. For more details, see “OutputPipeline” (HDL Coder). |
|-----------------------|--|

PLC Code Generation

Generate Structured Text code using Simulink® PLC Coder™.

Fixed-Point Conversion

Design and simulate fixed-point systems using Fixed-Point Designer™.

See Also

Logical Operator | Compare To Constant | Compare To Zero | Shift Arithmetic

Introduced before R2006a

Block Support Table

View data type support for Simulink blocks

Library: Simulink / Model-Wide Utilities



Description

The Block Support Table block helps you access a table that lists the data types that Simulink blocks support. To view the table, double-click the block.

Block Characteristics

| | |
|---------------------------------|----|
| Data Types | |
| Direct Feedthrough | no |
| Multidimensional Signals | no |
| Variable-Size Signals | no |
| Zero-Crossing Detection | no |

Tips

To open the Block Support Table from the command line, enter `showblockdatatypetable` at the MATLAB command prompt.

Extended Capabilities

C/C++ Code Generation

Generate C and C++ code using Simulink® Coder™.

The Block Support Table block is ignored during code generation.

See Also

`showblockdatatypetable`

Topics

“Data Types Supported by Simulink”

Introduced in R2007b

Bus Assignment

Replace specified bus elements

Library: Simulink / Signal Routing
HDL Coder / Signal Routing

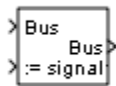

Description

The Bus Assignment block assigns the values of an input element to bus elements. Use a Bus Assignment block to change bus element values without adding Bus Selector and Bus Creator blocks that select bus elements and reassemble them into a bus.

Connect the bus to the first input port. To other input ports, connect one or more elements whose values you want to assign to a bus element. Use the Block Parameters dialog box to specify the bus elements to be replaced. The block displays an assignment input port for each such element. For an example of a model that uses a Bus Assignment block, see “Replace Values of Bus Elements”.

By default, Simulink repairs broken selections in the Bus Assignment Block Parameters dialog boxes that are due to upstream bus hierarchy changes. Simulink generates a warning to highlight that it modified the model. To prevent Simulink from making these repairs automatically, in the **Model Configuration Parameters > Diagnostics > Connectivity** pane, set the “Repair bus selections” diagnostic to Error without repair.

Limitations

When using arrays of buses with a Bus Assignment block, these limitations apply:

- You can assign or replace a nested bus that is an array of buses. For a bus that is nested inside an array of buses, see “Assign into Arrays of Buses”.
- To replace an element in an array of buses, use a Selector block to select the index for the bus element that you want to use with the Bus Assignment block. Then, use that selected bus element with the Bus Assignment block.

Ports

Input

Bus — Accept bus for bus element value assignment

real or complex values of any data type supported by Simulink

Input buses can have real or complex values of any data type supported by Simulink, including bus objects, arrays of buses, fixed-point, and enumerated data types. For details about data types, see Simulink, “Data Types Supported by Simulink”.

The element connected to the assignment port must have the same structure, data type, and sample time as the bus element to which it corresponds. You can use a Rate Transition block to change the

sample time of an individual element or elements in a bus, to include the element or bus in a nonvirtual bus.

Data Types: `single` | `double` | `half` | `int8` | `int16` | `int32` | `int64` | `uint8` | `uint16` | `uint32` | `uint64` | `Boolean` | `fixed point` | `enumerated` | `bus` | `string`

:= — Accept elements whose value are assigned to bus elements

real or complex values of any data type supported by Simulink

Assignment input ports can accept elements can have real or complex values of any data type supported by Simulink, including bus objects, arrays of buses, fixed-point, and enumerated data types. You cannot use the Bus Assignment block to replace a bus that is nested within an array of buses. For details about data types, see Simulink, “Data Types Supported by Simulink”.

The Bus Assignment block assigns elements connected to its assignment input ports to specified elements of the bus connected to its bus input port. The block replaces the elements previously assigned to those elements. The change does not affect the composition of the bus; it affects only the values of the elements themselves. Signals not replaced are unaffected by the replacement of other elements.

Data Types: `single` | `double` | `half` | `int8` | `int16` | `int32` | `int64` | `uint8` | `uint16` | `uint32` | `uint64` | `Boolean` | `fixed point` | `enumerated` | `bus` | `string`

Output

Bus — Output bus

virtual or nonvirtual bus

Bus that includes the assigned bus element values and the values of the bus elements of the input bus that you did not assign values to.

Data Types: `single` | `double` | `half` | `int8` | `int16` | `int32` | `int64` | `uint8` | `uint16` | `uint32` | `uint64` | `Boolean` | `fixed point` | `enumerated` | `bus` | `string`

Parameters

Elements in the bus — Bus elements of input bus

list of element names

List of the bus elements of the input bus. An arrow next to an element name indicates that the input element is a bus. To display the elements in an input bus, click the arrow.

Click any item in the list to select it. To find the source of the selected element, click **Find**. Simulink opens and highlights the system containing the element source. To move the currently selected element into the adjacent list of elements to be assigned values (see **Elements that are being assigned** below), click **Select**. To refresh the display to reflect modifications to the bus connected to the block, click **Refresh**.

Filter by name — Filter set of displayed elements

text

Specify a search term to use for filtering a long list of input elements. Do not enclose the search term in quotation marks. The filter does a partial string search. To access filtering options, including using a regular expression for specifying the search term, click the  button on the right of the **Filter by name** edit box.

Enable regular expression – Filter set of displayed input elements

off (default) | on

Enable the use of MATLAB regular expressions for filtering element names. For example, entering `t$` in the **Filter by name** edit box displays all elements whose names end with a lowercase `t` (and their immediate parents). For details, see “Regular Expressions”.

Dependencies

To access this parameter, click the  button on the right of the **Filter by name** edit box.

Show filtered results as a flat list – Filter set of displayed input elements

off (default) | on

By default, the list displays as a tree list of filtered elements, based on the search text in the **Filter by name** edit box. To use a flat list format that uses dot notation to reflect the hierarchy of buses, select this parameter.

Dependencies

To access this parameter, click the  button on the right of the **Filter by name** edit box.

Elements that are being assigned – Names of bus elements to be assigned values

list of element names

Names of bus elements to be assigned values. This block displays an assignment input port for each bus element in this list. The label of the corresponding input port contains the name of the element. You can order the elements by using the **Up**, **Down**, or **Remove** buttons. Port connectivity is maintained when you change the element order.

If an input bus no longer contains a bus element, three question marks (???) appear before the name of that bus element. The bus has changed since the last time you refreshed the Bus Assignment block input and bus element assignment lists. To address this issue, either modify the bus to include an element of the specified name or remove the name from the list of bus elements designated to be assigned values.

Programmatic Use**Block Parameter:** OutputSignals**Type:** character vector**Values:** 'signal1'|'signal2'**Default:** none**Block Characteristics**

| | |
|---------------------------------|--|
| Data Types | Boolean bus double enumerated fixed point half integer single string |
| Direct Feedthrough | yes |
| Multidimensional Signals | yes |
| Variable-Size Signals | yes |
| Zero-Crossing Detection | no |

Extended Capabilities

C/C++ Code Generation

Generate C and C++ code using Simulink® Coder™.

Actual data type or capability support depends on block implementation.

HDL Code Generation

Generate Verilog and VHDL code for FPGA and ASIC designs using HDL Coder™.

HDL Coder provides additional configuration options that affect HDL implementation and synthesized logic.

To learn more about using buses for HDL code generation, see “Buses” (HDL Coder) and “Use Bus Signals to Improve Readability of Model and Generate HDL Code” (HDL Coder).

HDL Architecture

This block has a single, default HDL architecture.

HDL Block Properties

| | |
|----------------------------------|--|
| ConstrainedOutputPipeline | Number of registers to place at the outputs by moving existing delays within your design. Distributed pipelining does not redistribute these registers. The default is 0. For more details, see “ConstrainedOutputPipeline” (HDL Coder). |
| InputPipeline | Number of input pipeline stages to insert in the generated code. Distributed pipelining and constrained output pipelining can move these registers. The default is 0. For more details, see “InputPipeline” (HDL Coder). |
| OutputPipeline | Number of output pipeline stages to insert in the generated code. Distributed pipelining and constrained output pipelining can move these registers. The default is 0. For more details, see “OutputPipeline” (HDL Coder). |

PLC Code Generation

Generate Structured Text code using Simulink® PLC Coder™.

Fixed-Point Conversion

Design and simulate fixed-point systems using Fixed-Point Designer™.

Actual data type or capability support depends on block implementation.

See Also

Bus Creator | Bus Selector

Topics

“Group Signal Lines into Virtual Buses”
 “Group Nonvirtual Buses in Arrays of Buses”
 “Types of Composite Signals”
 “Share and Reuse Bus-Routing Blocks”

Introduced before R2006a

Bus Creator

Create bus from input elements

Library: Simulink / Commonly Used Blocks
 Simulink / Signal Routing
 HDL Coder / Signal Routing



Description

The Bus Creator block combines a set of input elements into a bus. You can connect any element types to the input ports, including other buses. You can access elements in a bus by using a Bus Selector block.

Elements of a bus must have unique names. By default, each element of the bus inherits the name of the element connected to the Bus Creator block. If duplicate names are present, the Bus Creator block appends the port number to all input element names. For elements that do not have names, the Bus Creator block generates names in the form `signaln`, where `n` is the port number connected to the element. You can refer to elements by name when you search for their sources or select elements for connection to other blocks. For element naming guidelines, see “Signal Names and Labels”.

Ports

Input

Port_1 – Input element to include in bus

signal | message

Input element to include in the bus.

The number of input ports is driven by the **Number of inputs** parameter.

Data Types: single | double | half | int8 | int16 | int32 | int64 | uint8 | uint16 | uint32 | uint64 | string | Boolean | fixed point | enumerated | bus

Output

Port_1 – Output bus

virtual bus | nonvirtual bus

Output bus composed of the combined input elements, specified as a virtual or nonvirtual bus. For more information on the types of buses, see “Types of Composite Signals”.

Data Types: bus

Parameters

Number of inputs – Number of input elements

2 (default) | integer

Number of input elements, not fewer than two, specified as an integer. Increasing the number of inputs adds empty input ports to the block. Before you simulate the model, make sure that an input element is connected to each input port.

When you modify the **Number of inputs** parameter, click **Refresh** to update the list of elements.

Tip If all input ports are already connected, you can add an input port to the Bus Creator block by connecting another line to it.

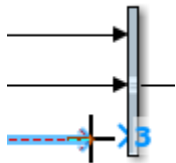

Interactively adding a port updates the **Number of inputs** parameter and adds the new element to the list of elements in the bus.

Programmatic Use

Block Parameter: Inputs

Type: character vector

Values: integer greater than or equal to 2, comma-separated list of element names

Default: '2'

By default, the Inputs parameter specifies the number of inputs. When you use it to specify the names of elements in the bus, the number of inputs matches the number of element names you specify.

Elements in the bus – List of input elements

list of element names

List of input elements to combine into a bus. You can view all elements entering the block, including the elements contained in nested buses. An arrow next to an element indicates that an input element is a bus. To display the contents of that bus, click the arrow.

To rearrange the elements in the output bus, use the **Up** and **Down** buttons. You can select multiple top-level adjacent elements in the **Elements in the bus** list to reorder or remove.

To find the source of any element entering the block, select the element in the **Elements in the bus** list and click the **Find** button. Simulink highlights the icon of the source, opening the subsystem that contains the element source, if necessary.

If you change an element name while the Block Parameters dialog box is open, you can see the updated name by clicking **Refresh**.

Programmatic Use**Block Parameter: Inputs****Type:** character vector**Values:** integer greater than or equal to 2, comma-separated list of element names**Default:** '2'

By default, the Inputs parameter specifies the number of inputs. When you use it to specify the names of elements in the bus, the number of inputs matches the number of element names you specify.

Filter by name — Search term for filtering displayed input elements

text

Search term for filtering displayed input elements, specified as text. Do not enclose the search term in quotation marks. The filter does a partial string search.

To access the filtering options, click the **Show filtering options**  button to the right of the **Filter by name** box.

Enable regular expression — Option to filter displayed input elements by regular expression

off (default) | on

Option to filter the displayed input elements by regular expression.

When this parameter is enabled, entering `t$` in the **Filter by name** box displays all elements whose names end with a lowercase `t` (and their immediate parents). For details, see “Regular Expressions”.

Dependencies

To access this parameter, click the **Show filtering options**  button to the right of the **Filter by name** box.

Show filtered results as a flat list — Option to display filtered results as a flat list

off (default) | on

Option to display filtered results as a flat list that uses dot notation to reflect the hierarchy of buses. By default, the filtered elements appear in a hierarchical tree.

Dependencies

To access this parameter, click the **Show filtering options**  button to the right of the **Filter by name** box.

Output data type — Data type of output bus

'Inherit: auto' (default) | 'Bus: <object name>' | <data type expression>

Data type of the output bus.

If you select `Bus: <object name>`, replace `<object name>` with the name of a Simulink.Bus object. The Bus object must be accessible when you edit the model.

To define a Bus object using the **Bus Editor**, click the **Show data type assistant** button , and then click the **Edit** button.

If you select `<data type expression>`, specify an expression that evaluates to a Bus object.

Programmatic Use**Block Parameter:** `OutDataTypeStr`**Type:** character vector**Values:** `'Inherit: auto' | 'Bus: <object name>'`**Default:** `'Inherit: auto'`**Require names of inputs to match names above — Check that input element names match names listed in dialog box**`off (default) | on`

Check that the input element names match the names listed in the Block Parameters dialog box. If the element names do not match, Simulink returns an error.

Tips

The **Require names of inputs to match names above** parameter might be removed in a future release. To enforce strong data typing, consider using the **Use names from inputs instead of from bus object** parameter.

Dependencies

If you select **Use names from inputs instead of from bus object**, the Simulink software ignores the **Require names of inputs to match names above** setting.

If you change the **Number of inputs** programmatically, this parameter reverts to `'off'`.

Rename selected signal — New name for selected input element`' ' (default) | character vector`

New name for the selected input element. See “Signal Names and Labels” for name guidelines.

Dependencies

To display this parameter, enable the **Require names of inputs to match names above** parameter.

Use names from inputs instead of from bus object — Option to use names from input elements instead of from Simulink.Bus object`on (default) | off`

By default, the Bus Creator block uses the input element names as the output bus element names, even when you specify a `Simulink.Bus` object as the data type.

To inherit bus element names from the Bus object, clear this parameter. Clearing the parameter:

- Enforces strong data typing.
- Avoids having to enter an element name multiple times: in the Bus object and in the model. Entering the name multiple times can accidentally create element name mismatches.
- Supports the array of buses requirement to have consistent element names across array elements.

Alternatively, you can enforce strong data typing by checking that input element names match the Bus object element names. Keep the **Use names from inputs instead of from bus object** check box selected and set the **Element name mismatch** configuration parameter to `error`.

Dependencies

To display this parameter, set the **Output data type** parameter to a Bus object.

Programmatic Use

Block Parameter: InheritFromInputs

Type: character vector

Values: 'on' | 'off'

Default: 'on'

Output as nonvirtual bus — Output nonvirtual bus

off (default) | on

Output a nonvirtual bus instead of a virtual bus.

All elements in a nonvirtual bus must have the same sample time, even if the elements of the associated Bus object specify inherited sample times for some elements. Any operation resulting in a nonvirtual bus containing elements with different sample rates generates an error. To change the sample time of an element or bus that has a different sample time than the other nonvirtual bus input elements, use a Rate Transition block. For details, see “Modify Sample Times for Nonvirtual Buses”.

To generate code that uses a C structure to define the structure of the bus that this block creates, enable this parameter.

Dependencies

To display this parameter, set the **Output data type** parameter to a Bus object.

Programmatic Use

Block Parameter: NonVirtualBus

Type: character vector

Values: 'on' | 'off'

Default: 'off'

Block Characteristics

| | |
|---------------------------------|--|
| Data Types | Boolean bus double enumerated fixed point half integer single string |
| Direct Feedthrough | no |
| Multidimensional Signals | yes |
| Variable-Size Signals | yes |
| Zero-Crossing Detection | no |

Tips

For buses at subsystem and model interfaces, you can use Out Bus Element blocks instead of a Bus Creator block with an Outport block. Out Bus Element blocks:

- Reduce line complexity and clutter in a block diagram.
- Make it easier to change the interface incrementally.

Extended Capabilities

C/C++ Code Generation

Generate C and C++ code using Simulink® Coder™.

Actual data type or capability support depends on block implementation.

HDL Code Generation

Generate Verilog and VHDL code for FPGA and ASIC designs using HDL Coder™.

HDL Coder provides additional configuration options that affect HDL implementation and synthesized logic.

To learn more about using buses for HDL code generation, see “Buses” (HDL Coder) and “Use Bus Signals to Improve Readability of Model and Generate HDL Code” (HDL Coder).

HDL Architecture

This block has a single, default HDL architecture.

HDL Block Properties

| | |
|----------------------------------|--|
| ConstrainedOutputPipeline | Number of registers to place at the outputs by moving existing delays within your design. Distributed pipelining does not redistribute these registers. The default is 0. For more details, see “ConstrainedOutputPipeline” (HDL Coder). |
| InputPipeline | Number of input pipeline stages to insert in the generated code. Distributed pipelining and constrained output pipelining can move these registers. The default is 0. For more details, see “InputPipeline” (HDL Coder). |
| OutputPipeline | Number of output pipeline stages to insert in the generated code. Distributed pipelining and constrained output pipelining can move these registers. The default is 0. For more details, see “OutputPipeline” (HDL Coder). |

PLC Code Generation

Generate Structured Text code using Simulink® PLC Coder™.

Fixed-Point Conversion

Design and simulate fixed-point systems using Fixed-Point Designer™.

Actual data type or capability support depends on block implementation.

See Also

Bus Assignment | Bus Selector | Bus to Vector | Out Bus Element

Topics

“Group Signal Lines into Virtual Buses”

“Simplify Subsystem and Model Interfaces with Buses”

“Bus-Capable Blocks”

“Replace Values of Bus Elements”

“Modify Sample Times for Nonvirtual Buses”

“Specify Bus Properties with Simulink.Bus Object Data Types”

Introduced before R2006a

Bus Selector

Select elements from incoming bus

Library: Simulink / Commonly Used Blocks
 Simulink / Signal Routing
 HDL Coder / Signal Routing



Description

The Bus Selector block outputs the elements you select from the input bus. The block can output the selected elements separately or in a new virtual bus.

Ports

Input

Port_1 — Input bus

virtual bus | nonvirtual bus

Input bus, which can be virtual or nonvirtual.

For arrays of buses, you must use a Selector block to select the bus that you want to use with the Bus Selector block.

Data Types: bus

Output

Port_1 — Selected bus elements of input bus

signal | message

Selected bus elements of an input bus.

For each output element, this block uses a separate port from the top to the bottom of the block. If the block is rotated, see “Port Location After Rotating or Flipping” for the port order of various block orientations.

Data Types: single | double | half | int8 | int16 | int32 | int64 | uint8 | uint16 | uint32 | uint64 | string | Boolean | fixed point | enumerated | bus

Parameters

Elements in the bus — List of elements in input bus

list of element names

List of elements in the input bus from which to select output elements.

If you change an element name while the Block Parameters dialog box is open, you can see the updated name by clicking **Refresh**.

To highlight the source of an element entering the block, select the element in the list and click **Find**.

Programmatic Use

Block Parameter: InputSignals

Type: cell array

Values: element names

Filter by name — Search term for filtering displayed input elements

text

Search term for filtering displayed input elements, specified as text. Do not enclose the search term in quotation marks. The filter does a partial string search.

To access the filtering options, click the **Show filtering options**  button to the right of the **Filter by name** box.

Enable regular expression — Option to filter displayed input elements by regular expression

off (default) | on

Option to filter the displayed input elements by regular expression.

When this parameter is enabled, entering `t$` in the **Filter by name** box displays all elements whose names end with a lowercase `t` (and their immediate parents). For details, see “Regular Expressions”.

Dependencies

To access this parameter, click the **Show filtering options**  button on the right side of the **Filter by name** box.

Show filtered results as a flat list — Option to display filtered results as a flat list

off (default) | on

Option to display filtered results as a flat list that uses dot notation to reflect the hierarchy of buses. By default, the filtered elements appear in a hierarchical tree.

Dependencies

To access this parameter, click the **Show filtering options**  button on the right side of the **Filter by name** box.

Selected elements — Selected elements of input bus

list of elements names

The selected elements of the input bus.

To specify an output element, select an element from the **Elements in the bus** list, and then click the **Select** button. The element is added at the end of the **Selected elements** list. To add elements below an existing element, select an element in the **Selected elements** list before you click **Select**. Elements are added below the element you selected.

If you select multiple elements from the **Elements in the bus** list, the order in which you select them is the order in which Simulink inserts them in the **Selected elements** list.

If an output element listed in the **Selected elements** list is not an input to the Bus Selector block, the element name starts with three question marks (???).

To change the order of the output bus elements, use the **Up** and **Down** buttons. Port connectivity with downstream blocks is maintained when you change the element order.

To remove bus elements from the block output, use the **Remove** button. You can select multiple contiguous elements to move or remove.

Tip In the Simulink Editor, as you draw a new line close to the output side of a Bus Selector block when all output ports are already connected, Simulink:

- Adds a port
- Prompts you to specify the element to be selected

You cannot use this automatic port addition approach if:

- A bus input is not connected to the Bus Selector block.
 - You do not specify an element in response to the prompt that appears when you draw a line close to the Bus Selector block icon.
 - You select the **Output as virtual bus** parameter.
-

Programmatic Use

Block Parameter: OutputSignals

Type: character vector

Values: character vector in the form of 'signal1,signal2'

Default: none

Output as virtual bus — Option to output selected elements as virtual bus

off (default) | on

Option to output the selected elements as a virtual bus.

By default, the block outputs each of the selected elements from a separate output port that is labeled with the corresponding bus element name. When this parameter is enabled, the block outputs the selected elements from one port, grouped in a virtual bus.

The output bus is virtual. To convert the output to a nonvirtual bus, insert a Signal Conversion block after the Bus Selector block. Set the Signal Conversion block **Output** parameter to **Nonvirtual bus** and set the **Data type** to a Simulink.Bus object.

When the **Selected elements** list includes only one element and you enable **Output as virtual bus**, then that element is not wrapped in a bus. For example, if the element is a bus, the output element is that bus. If the element is not a bus, the output element is not a bus.

Programmatic Use

Block Parameter: OutputAsBus

Type: character vector

Values: 'on' | 'off'

Default: 'off'

Block Characteristics

| | |
|---------------------------------|--|
| Data Types | Boolean bus double enumerated fixed point half integer single string |
| Direct Feedthrough | yes |
| Multidimensional Signals | yes |
| Variable-Size Signals | yes |
| Zero-Crossing Detection | no |

Tips

For buses at subsystem and model interfaces, you can use In Bus Element blocks instead of an Inport block with a Bus Selector block. In Bus Element blocks:

- Reduce line complexity and clutter in a block diagram.
- Make it easier to change the interface incrementally.
- Allow access to a bus element closer to the point of usage, avoiding the use of a Bus Selector and Goto block configuration.

Extended Capabilities

C/C++ Code Generation

Generate C and C++ code using Simulink® Coder™.

Actual data type or capability support depends on block implementation.

HDL Code Generation

Generate Verilog and VHDL code for FPGA and ASIC designs using HDL Coder™.

HDL Coder provides additional configuration options that affect HDL implementation and synthesized logic.

To learn more about using buses for HDL code generation, see “Buses” (HDL Coder) and “Use Bus Signals to Improve Readability of Model and Generate HDL Code” (HDL Coder).

HDL Architecture

This block has a single, default HDL architecture.

HDL Block Properties

| | |
|----------------------------------|--|
| ConstrainedOutputPipeline | Number of registers to place at the outputs by moving existing delays within your design. Distributed pipelining does not redistribute these registers. The default is 0. For more details, see “ConstrainedOutputPipeline” (HDL Coder). |
|----------------------------------|--|

| | |
|-----------------------|--|
| InputPipeline | Number of input pipeline stages to insert in the generated code. Distributed pipelining and constrained output pipelining can move these registers. The default is 0. For more details, see "InputPipeline" (HDL Coder). |
| OutputPipeline | Number of output pipeline stages to insert in the generated code. Distributed pipelining and constrained output pipelining can move these registers. The default is 0. For more details, see "OutputPipeline" (HDL Coder). |

PLC Code Generation

Generate Structured Text code using Simulink® PLC Coder™.

Fixed-Point Conversion

Design and simulate fixed-point systems using Fixed-Point Designer™.

Actual data type or capability support depends on block implementation.

See Also

Bus Creator | Bus Assignment | Bus to Vector | Out Bus Element

Topics

"Group Signal Lines into Virtual Buses"

"Simplify Subsystem and Model Interfaces with Buses"

"Bus-Capable Blocks"

"Replace Values of Bus Elements"

Introduced before R2006a

Bus to Vector

Convert virtual bus to vector

Library: Simulink / Signal Attributes
HDL Coder / Signal Attributes

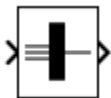

Description

The Bus to Vector block converts a virtual bus to a vector signal. The input bus must consist of scalars or 1-D, row, or column vectors that have the same data type, signal type, and sampling mode. If the input bus contains row or column vectors, the output is a row or column vector, respectively. Otherwise, the output is a 1-D array.

Use the Bus to Vector block only to replace an implicit bus-to-vector conversion with an explicit conversion. To identify and correct buses used as vectors without manually inserting Bus to Vector blocks, you can use the Simulink Model Advisor **“Check bus signals treated as vectors”** on page 9-22 check. Alternatively, you can use the `Simulink.BlockDiagram.addBusToVector` function, which automatically inserts Bus to Vector blocks wherever needed.

Note If you use **Save As** to save a model in a version of the Simulink product before R2007a, a null subsystem that outputs nothing replaces each Bus to Vector block. Before you can use the model, reconnect or otherwise correct each path that used to contain a Bus to Vector block but now is interrupted by a null subsystem.

Ports

Input

Port_1 — Accept signal to convert to vector

virtual bus | nonbus signal

The input bus signals must consist of scalars or 1-D, row, or column vectors that have the same data type, signal type, and sampling mode. If the input is a nonbus signal, the block does no conversion.

Data Types: single | double | half | int8 | int16 | int32 | int64 | uint8 | uint16 | uint32 | uint64 | Boolean | fixed point | enumerated

Output

Port_1 — Output vector signal

vector | 1-D array

Output a vector signal, based on input bus signal. If the input bus contains row or column vectors, the block output is a row or column vector, respectively. Otherwise, the output is a 1-D array.

Data Types: single | double | half | int8 | int16 | int32 | int64 | uint8 | uint16 | uint32 | uint64 | Boolean | fixed point | enumerated

Block Characteristics

| | |
|---------------------------------|---|
| Data Types | Boolean bus double enumerated fixed point half integer single |
| Direct Feedthrough | no |
| Multidimensional Signals | no |
| Variable-Size Signals | no |
| Zero-Crossing Detection | no |

Extended Capabilities

C/C++ Code Generation

Generate C and C++ code using Simulink® Coder™.

Actual data type or capability support depends on block implementation.

HDL Code Generation

Generate Verilog and VHDL code for FPGA and ASIC designs using HDL Coder™.

HDL Coder provides additional configuration options that affect HDL implementation and synthesized logic.

To learn more about using buses for HDL code generation, see “Buses” (HDL Coder) and “Use Bus Signals to Improve Readability of Model and Generate HDL Code” (HDL Coder).

HDL Architecture

This block has a single, default HDL architecture.

HDL Block Properties

| | |
|----------------------------------|--|
| ConstrainedOutputPipeline | Number of registers to place at the outputs by moving existing delays within your design. Distributed pipelining does not redistribute these registers. The default is 0. For more details, see “ConstrainedOutputPipeline” (HDL Coder). |
| InputPipeline | Number of input pipeline stages to insert in the generated code. Distributed pipelining and constrained output pipelining can move these registers. The default is 0. For more details, see “InputPipeline” (HDL Coder). |
| OutputPipeline | Number of output pipeline stages to insert in the generated code. Distributed pipelining and constrained output pipelining can move these registers. The default is 0. For more details, see “OutputPipeline” (HDL Coder). |

Fixed-Point Conversion

Design and simulate fixed-point systems using Fixed-Point Designer™.

Actual data type or capability support depends on block implementation.

See Also

Blocks

Bus Creator | Bus Selector | Mux | Data Type Conversion

Functions

`Simulink.BlockDiagram.addBusToVector`

Topics

“Identify Automatic Bus Conversions”

“Types of Composite Signals”

Introduced in R2007a

Callback Button

Execute MATLAB code using button with customizable appearance

Library: Simulink / Dashboard / Customizable Blocks

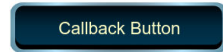

Description

The Callback Button block executes MATLAB code in response to a click or button press. You can specify separate code to execute for a click and a press. When you specify code to execute in response to a press, you can configure the block to execute the code at a specified rate while the button is pressed. When you use the Callback Button block from the Customizable Blocks library, you can also customize the appearance of the block to look like a button in your real system.

The Callback Button block executes the code for a click when you release the left mouse button with the cursor on the Callback Button. The code for a press executes when you click the Callback Button and hold for the specified **Press Delay**.

Double-clicking the Callback Button block does not open its dialog box during simulation or when the block is selected. To edit the block parameters, you can use the **Property Inspector** or open the block dialog box by:

- Double-clicking the block when the block is not selected and the model is not simulating.
- Right-clicking the block and selecting **Block Parameters** from the context menu.

Customize Callback Button Blocks

When you add a Callback Button block to your model, the block is preconfigured with a default design. You can use the block with the default design or customize the appearance of the block. When you design a Callback Button block, you configure the block appearance for each possible state. When you configure the **Block Type** as **Momentary**, the block has two states, and when you configure the **Block Type** as **Latch**, the block has four. For each state, you can:

- Add an image that defines the appearance of the block in that state.
- Specify text for the button label and configure its color and position within the block.
- Add an icon and specify the position of the icon relative to the label.

When you want an aspect of the block, such as the label text or color, to indicate the state of the block, configure that aspect of the design differently for each state. When you want an aspect of the block to remain the same for all states, configure that aspect of the block design so it is the same for all states.

You can also design the block background and foreground, which apply for all states. To configure the foreground for the block, upload a foreground image. To configure the background for the block, you can upload a background image or use a solid background color.

To customize the appearance of the block, use design mode. You can enter design mode in one of three ways after selecting the block:

- On the **Button** tab, under **Design**, click **Edit**.
- In the **Property Inspector**, on the **Design** tab, click **Edit Design**.
- Pause on the ellipsis that appears above the block and click the **Edit Custom Block** button.

Design mode gives you access to block parameters and settings that allow you to customize the appearance of the block. You can use the toolbar above the block to configure the image, the icon, and the label color and opacity for each state. For more customization options, use the **Design** tab in the Property Inspector.

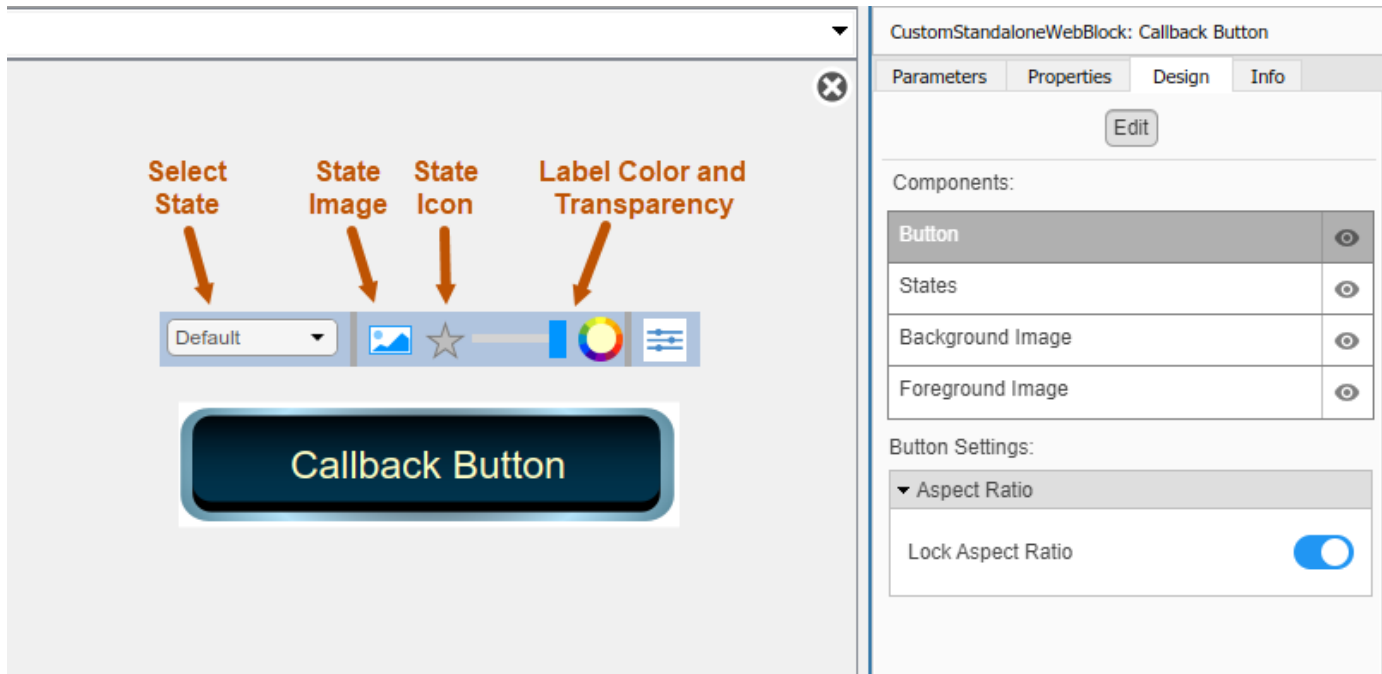

When you finish designing the button, click **Exit** in the upper-right of the canvas to exit design mode.

Parameters

Button Type — Button response to click

Momentary (default) | Latch

Specify how the block responds to a click.

- **Momentary** — The button changes state only while pressed. When you release the mouse, the button returns to its default state.
- **Latch** — The button latches the state change when clicked. The button remains in the pressed state until you click it again.

When you configure **Button Type** as **Momentary**, the block has these states:

- **Default** — Default state for the block when it is not pressed
- **Pressed** — Block state when the block is pressed

When you configure **Button Type** as **Latch**, the block has these states:

- **Default** — Default state for the block when it is not pressed.
- **Pressed** — Transitional state when you press the button while it is in the **Default** state. The block transitions to the **Latched** state when you release the mouse.
- **Latched** — Latched state for the block when it is not pressed.
- **Latched and Pressed** — Transitional state when you press the button while it is in the **Latched** state. The block transitions to the **Default** state when you release the mouse.

Button Text — Label for button

'Callback Button' (default) | string | character array

Text label for the button. When you want the button to have the same label text for all states, specify the text using the **Button Text** parameter. To specify a different button label for each state, use the **Design** tab.

Mouse Action — Mouse action to run code

'ClickFcn' (default) | 'PressFcn'

Mouse action that causes the MATLAB code to execute.

- Select **ClickFcn** to view and edit the code that executes when the **Callback Button** block is clicked.
- Select **PressFcn** to view and edit the code that executes when the button is pressed.

MATLAB Code — Code to execute in response to mouse action

empty (default) | MATLAB Code

MATLAB code that executes in response to the mouse action.

Dependencies

The MATLAB code displayed depends on the **Mouse Action** parameter selection.

- Select **ClickFcn** to view and edit the code that executes when the **Callback Button** block is clicked.
- Select **PressFcn** to view and edit the code that executes when the button is pressed.

Press Delay (ms) — Time to hold button for press

500 (default) | scalar

Amount of time required to cause the **PressFcn** code to execute.

Dependencies

Press Delay (ms) is visible only when **PressFcn** is selected as the **Mouse Action**.

Repeat Interval (ms) — Time interval to repeat PressFcn code

0 (default) | scalar

Time interval after which the **PressFcn** code executes again if the **Callback Button** block is still pressed.

Dependencies

Repeat Interval (ms) is visible only when **PressFcn** is selected as the **Mouse Action**.

Block Characteristics

| | |
|---------------------------------|----|
| Data Types | |
| Direct Feedthrough | no |
| Multidimensional Signals | no |
| Variable-Size Signals | no |
| Zero-Crossing Detection | no |

Tips

To design a button that changes the value of a variable or parameter in your model, use the Push Button block.

Extended Capabilities

C/C++ Code Generation

Generate C and C++ code using Simulink® Coder™.

Dashboard blocks are ignored for code generation.

See Also

Callback Button | Push Button

Topics

“Initialize Your Model Using the Callback Button Block” on page 12-9

“Control a Parameter Value with Callback Button Blocks” on page 12-10

Introduced in R2021b

Callback Button

Execute MATLAB code using button

Library: Simulink / Dashboard

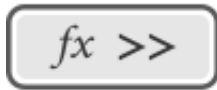

Description

The Callback Button block executes MATLAB code in response to a click or button press. You can specify separate code to execute for a click and a press. When you specify code to execute in response to a press, you can configure the block to execute the code at a specified rate while the button is pressed.

The Callback Button block executes the code for a click when you release the left mouse button with the cursor on the Callback Button. The code for a press executes when you click the Callback Button and hold for the specified **Press Delay**.

Double-clicking the Callback Button block does not open its dialog box during simulation or when the block is selected. To edit the block parameters, you can use the **Property Inspector** or open the block dialog box by:

- Double-clicking the block when the block is not selected and the model is not simulating.
- Right-clicking the block and selecting **Block Parameters** from the context menu.

The Callback Button block in the Customizable Blocks library provides the same functionality as this Callback Button block and provides additional capabilities to:

- Design the appearance of the block to look like a button in a real system.
- Configure the button type as momentary or latch.

Parameters

Button Text — Label for button

'Callback Button' (default) | character array

Text label for the button.

Tips

To design a button that displays different text depending on the state of the block, use the Callback Button block in the Customizable Blocks library.

Programmatic Use

Block Parameter: ButtonText

Type: string or character array

Default: 'Callback Button'

Mouse Action — Mouse action to run code

'ClickFcn' (default) | 'PressFcn'

Mouse action that causes the MATLAB code to execute.

- Select ClickFcn to view and edit the code that executes when the Callback Button block is clicked.
- Select PressFcn to view and edit the code that executes when the button is pressed.

MATLAB Code — Code to execute in response to mouse action

empty (default) | MATLAB Code

MATLAB code that executes in response to the mouse action.

Dependencies

The MATLAB code displayed depends on the **Mouse Action** parameter selection.

- Select ClickFcn to view and edit the code that executes when the Callback Button block is clicked.
- Select PressFcn to view and edit the code that executes when the button is pressed.

Press Delay (ms) — Time to hold button for press

500 (default) | scalar

Amount of time required to cause the PressFcn code to execute.

Dependency

Press Delay (ms) is visible only when PressFcn is selected as the **Mouse Action**.

Repeat Interval (ms) — Time interval to repeat PressFcn code

0 (default) | scalar

Time interval after which the PressFcn code executes again if the Callback Button block is still pressed.

Dependency

Repeat Interval (ms) is visible only when PressFcn is selected as the **Mouse Action**.

Block Characteristics

| | |
|---------------------------------|----|
| Data Types | |
| Direct Feedthrough | no |
| Multidimensional Signals | no |
| Variable-Size Signals | no |
| Zero-Crossing Detection | no |

Extended Capabilities

C/C++ Code Generation

Generate C and C++ code using Simulink® Coder™.

Dashboard blocks are ignored for code generation.

See Also

Push Button | Callback Button

Introduced in R2017b

C Caller

Integrate C code in Simulink

Library: Simulink / User-Defined Functions

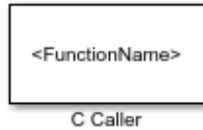



Description

The C Caller block integrates your external C code into Simulink. This block imports and lists the functions in your external C code, and allows you to select your resolved C functions to integrate in your Simulink models. The C Caller block standalone supports code generation. For more complex models, code generation depends on the capabilities of your Simulink model.

To use the C Caller block, define your source code and any supporting files using **Simulation Target** under **Configuration Parameters**. Then, bring a C Caller block to the Simulink canvas, using **Library Browser > Simulink > User Defined Functions**. To change the defined source code file and its dependencies, go to **Simulation Target** tab in **Configuration Parameters** by clicking the



from the block dialog. After changing your source code or any of its dependencies, refresh the

list of functions by clicking the  on the block dialog. To browse the function definitions in your source code, use the  icon to access your source files.

Ports

Input

Input argument — Input argument for the corresponding C Caller block

scalar | vector | matrix

Input argument to the C Caller block.

Number of input arguments and their names are inferred through the selected function in your external C code. To receive data to a C Caller block, connect an input signal to the input ports.

Input label has the same name as your input argument unless changed by editing the **Label** column under **Port Specification** from the **Block Dialog**. If you rename the label to an input port, the C Caller block changes the name of the port.

For input variables, you can change the input scope to parameters or constants using the **Scope** column.

Data Types: single | double | int8 | int16 | int32 | int64 | uint8 | uint16 | uint32 | uint64 | Boolean | fixed point | enumerated | bus

Output

Output argument — Output argument for the corresponding C Caller block

scalar | vector | matrix

Output argument from the C Caller block.

Number of output arguments and their names are inferred through the selected function in your external C code. To send data from your C Caller block, connect a block to the output port of your C Caller block.

Output port label has the same name as your output argument unless you change it by editing the **Label** column under **Port Specification** from the **Block Dialog**. If you rename the label to an input port, the C Caller block changes the name of the port.

Data Types: single | double | int8 | int16 | int32 | int64 | uint8 | uint16 | uint32 | uint64 | Boolean | enumerated | bus

Parameters

Function name — Name of function

character vector

Name of the function parsed for the C Caller block. For a list of available functions, see “Available Functions” on page 1-0 .

Tunable: Yes

Programmatic Use

Block Parameter: FunctionName

Type: character vector

```
myFunctionName = get_param(gcb, 'FunctionName')
```

```
myFunctionName =
```

```
    'mean_filter'
```

Port specification — Specify port properties

string

The `Port specification` table indicates the attributes of each input and output element for the selected block. These properties include Argument name, scope, input/output label, type and size of the input/output variables. Argument name, scope, type, and size are inferred from your source code. If the scope is an input, you can modify this variable to a parameter or a constant.

Name — Demonstrates the variable name inferred from your source code.

A bold argument name indicates that the port or parameter is a global argument.

Scope — Indicates the role of the variables from your source code. If the variable is an input argument in the C Caller block source code, you can change the scope type to a constant or a parameter. If the variable is an output argument in the source code, you cannot change the scope type.

Label — Labels the input or output variable for the Simulink model. You can change the labels using this table. If the scope is a parameter, enter the parameter name in this field. If the scope is a constant, enter the constant value.

Type — Indicates the data type coming from the ports.

Size — Indicates the size of the input and output data.

Available Functions — List of available functions

cell array

List of all available functions that can be mapped to a C Caller block.

The C Caller block in your model imports all functions in your external source code, and shows the function names next to the “Function name” on page 1-0 on the block dialog. To select and use a function in your block, confirm that the function name appears in the Available Functions table.

If you are missing one of the functions, reload the source code by clicking  on the block dialog. To change the names of functions, modify your source code and click the **Refresh** button to reload.

Programmatic Use

Block Parameter: AvailableFunctions

Type: character vector

```
allAvailableFunctions = get_param(gcb, 'AvailableFunctions')
```

```
allAvailableFunctions =
```

```
    1×1 cell array
```

```
    {'add'}
```

Block Characteristics

| | |
|---------------------------------|---|
| Data Types | Boolean ^a bus ^a double ^a enumerated ^a fixed point ^a integer ^a single ^a |
| Direct Feedthrough | no |
| Multidimensional Signals | limited ^a |
| Variable-Size Signals | no |
| Zero-Crossing Detection | no |

a. Actual data type or capability support depends on block implementation.

Extended Capabilities

C/C++ Code Generation

Generate C and C++ code using Simulink® Coder™.

Actual data type or capability support depends on block implementation.

Fixed-Point Conversion

Design and simulate fixed-point systems using Fixed-Point Designer™.

See Also

C Function | MATLAB Function | MATLAB System | S-Function | S-Function Builder

Topics

“Integrate C Code Using C Caller Blocks”

Introduced in R2018b

C Function

Integrate and call external C code from a Simulink model

Library: Simulink / User-Defined Functions



Description

The C Function block integrates and calls external C code from a Simulink model. Use this block to define external code and customize the integration of your code by preprocessing or postprocessing the data. In addition, you can specify customized code for simulation and C code generation. You can call functions defined in your code conditionally, and you can also call multiple functions in one block. Using this block, you can initialize the block's persistent data and pass it to an external function.

You can also use C Function block to call a subset of C Math Library functions. See “Call C Library Functions From C Function Block” for more information.

The C Function block supports initializing persistent data and calling external functions from the block dialog. The C Function block supports only initializing and terminating persistent data; the block does not support updating the data during simulation. To model a dynamic system with continuous states, use an S-Function block. To learn more about S-functions, see “What Is an S-Function?”.

Define the source code and supporting files to be called by the C Function block in the **Simulation Target** pane of the configuration parameters.

Limitations

The following features of Simulink are not compatible with the C Function block.

- Simulink Coverage™
 - Only execution coverage is measured.
- Simulink Code Inspector™
- Simulink Design Verifier™
- Simulink Test™
 - Test harness

In addition, the following limitations apply to the source code referenced by a C Function block.

- The C keyword `static` is not supported.
 - To cache values across time steps, define the symbol as `Persistent` in the **Symbols** table of the block dialog.
- Files cannot be included in the script.

External functions must be specified in the **Simulation Target** pane of the Configuration Parameters dialog.

If you have existing includes defined in the **Simulation Target** pane that cannot be mixed with the new include, consider adding the include and C Function block in a library model and use a link to the block in the main model. For more information, see “Create Custom Library”.

- Pointers of different types cannot be assigned to each other. The pointer types should match when you call external functions.
- The code cannot take the address of a constant.
- Directly calling of some C library functions from the C Function block is not supported. To see a list of the C Math Library functions that you can call directly, see “Call C Library Functions From C Function Block”. To call other C library functions, create a wrapper function that calls the C library function.

Ports

Input

Input port — Input of the C Function block

scalar | vector

Input to the C Function block.

The number of inputs and their names are determined by the definitions in your external C code and the definitions of the symbols in the **Symbols** table in the block parameters dialog.

The input port label is the same as the name of the input symbol unless you change it by editing the **Label** field in the **Symbols** table of the blocks dialog.

Data Types: single | double | int8 | int16 | int32 | int64 | uint8 | uint16 | uint32 | uint64 | Boolean | enumerated | bus

Output

Output port — Output of the C Function block

scalar | vector

Output from the C Function block.

Number of outputs and their names are determined by the definitions in your external C code and the definitions of the symbols in the **Symbols** table in the block parameters dialog.

The output port label is the same as the name of the output symbol unless you change it by editing the **Label** field in the **Symbols** table of the block parameters dialog.

Data Types: single | double | int8 | int16 | int32 | int64 | uint8 | uint16 | uint32 | uint64 | Boolean | enumerated | bus

Parameters

Output Code — Output code

character array | string

Specifies the code that the C Function block executes during simulation. For example, you can call a function from the external C code specified in the **Simulation Target** pane, make modifications to the results, and perform operations to pass the results to other blocks.

Start Code — Initialization code

character array | string

Specifies the initialization code of the C Function block. This code executes one time at the start of simulation. For example, you can initialize persistent data.

Terminate Code — Termination code

character array | string

Specifies cleanup code that the C Function block runs at model termination. This code executes once at the end of a simulation. For example, use this code to free the memory cached on persistent symbols specified as void pointers.

Symbols — Specify symbol properties

table

The **Symbols** table specifies the attributes of the symbols in the C code. You must enter the attributes of each symbol in the table.

- **Name** — Symbol name in the source code.
- **Scope** — Scope of the symbol. You can change the scope of a symbol at any time. The following scopes are available:
 - **Input** — Input symbol to the C Function block.
 - **Output** — Output symbol to the C Function block.
 - **InputOutput** — Define a symbol as both input and output to the C Function block.
 - **Parameter** — Define a symbol as a parameter. The parameter name is defined by the **Label** property of the symbol.
 - **Persistent** — Define a symbol as persistent data.

You can define a void pointer using the **Persistent** scope. A *void pointer* is a pointer that can store any type of data that you create or allocate.

- **Constant** — Define a symbol as constant using value-size or numeric expressions.
- **Label** — Label of the symbol. For symbols with their scope set to **Input** or **Output**, this label appears as the port name on the block. For symbols with their scope set to **Parameter**, this label is the label that appears on the block parameter mask. If the scope is **Constant**, the label is the constant expression. You cannot define a label for **Persistent** symbols.
- **Type** — Data type of the symbol. Select a data type from the drop-down list or specify custom data type.

To use a custom type such as `Simulink.Bus`, `Simulink.Enum` or `Simulink.AliasType` that does not have an external header definition associated with a C Function block, set the type accordingly on the **Symbol** table.

- **Size** — Size of the symbol data. The C Function block supports only scalars and vectors; matrices and higher-dimension arrays are not supported. You can use a size expression to define the size of an output or use `-1` to inherit size.

- **Port** — For input and output symbols, **Port** indicates the port index on the block of the symbol data. For parameter symbols, **Port** indicates the order that the symbol appears in the block parameter mask.

Block Characteristics

| | |
|---------------------------------|--|
| Data Types | Boolean ^a bus ^a double ^a enumerated ^a integer ^a single ^a |
| Direct Feedthrough | no |
| Multidimensional Signals | yes |
| Variable-Size Signals | no |
| Zero-Crossing Detection | no |

a. Actual data type or capability support depends on block implementation.

Extended Capabilities

C/C++ Code Generation

Generate C and C++ code using Simulink® Coder™.

Actual data type or capability support depends on block implementation.

See Also

Objects

SymbolSpec | Symbol

Topics

“Call and Integrate External C Algorithms into Simulink Using C Function Blocks”

Introduced in R2020a

Check Box

Select parameter or variable value

Library: Simulink / Dashboard

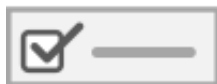

Description

The Check Box block allows you to set the value of a parameter or variable during simulation by checking or clearing the box. Use the Check Box block with other Dashboard blocks to create an interactive dashboard for your model.

Double-clicking the Check Box block does not open its dialog box during simulation and when the block is selected. To edit the block's parameters, you can use the **Property Inspector**, or you can right-click the block and select **Block Parameters** from the context menu.

Connect Dashboard Blocks

Dashboard blocks do not use ports to connect to model elements. To connect dashboard blocks to variables and block parameters, use connect mode. Connect mode facilitates the process of connecting dashboard blocks in your model, especially when you want to connect multiple blocks at once. To connect a single dashboard block, you can also use the **Connection** table in the block dialog box.

Tip You can modify dashboard block connections in your model during normal and accelerator mode simulations.

Note Dashboard blocks cannot connect to variables until you update the model diagram. To connect dashboard blocks to variables or modify variable values between opening your model and running a simulation, update the model diagram using **Ctrl+D**.

To enter connect mode, select the block. Then, on the block tab, click **Connect**. In connect mode, when you select one or more blocks, a list of parameters and variables available for connection appears. Select a variable or parameter from the list to connect to the selected dashboard block.

When the value of the selected variable or block parameter is nonscalar, use the text box at the bottom of the **Connection** table to specify the element you want to connect to the dashboard block. To connect to an element of a vector, matrix, or array, specify the element index, for example, 3 or (1, 3). To connect to an element in a bus or structure, specify the element in the context of the bus or structure hierarchy by using dots to indicate different levels in the hierarchy, and omit the top level. For example, specify a.b to connect to scalar element b of the structure or bus a nested inside the selected composite variable or parameter.

To connect another dashboard block, pause on another dashboard block and click the **Connect** button above it. Then, make a selection of signals and blocks in your model and choose a model element to connect.

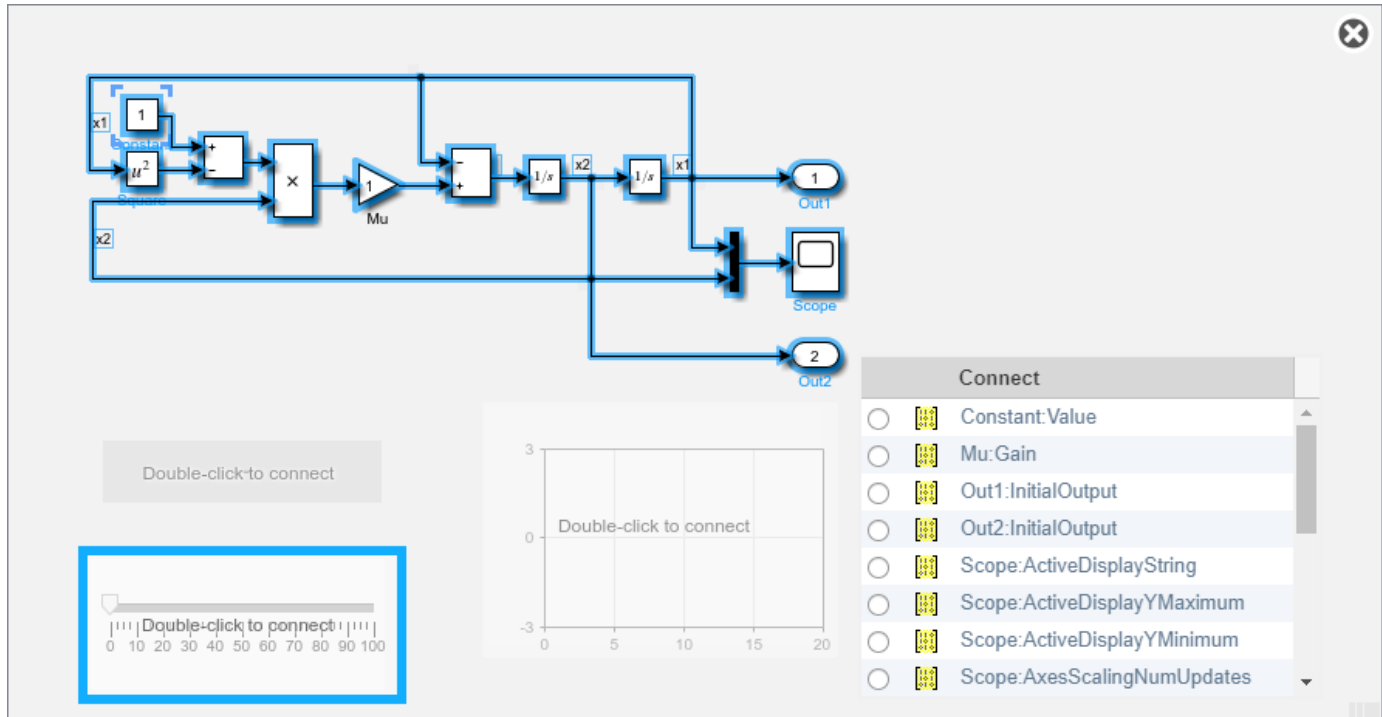

When you finish connecting the dashboard blocks in your model, on the block tab, click **Done Connecting**.

Tip You can hide the message shown on unconnected blocks using the `set_param` function with the `ShowInitialText` block parameter. The message also disappears when you connect the block.

Parameter Logging

Tunable parameters connected to dashboard blocks are logged to the Simulation Data Inspector, where you can view the parameter values along with logged signal data. You can access logged parameter data in the MATLAB workspace by exporting the parameter data from the Simulation Data Inspector by using the UI or the `Simulink.sdi.exportRun` function. For more information about exporting data using the Simulation Data Inspector UI, see “Export Data to the Workspace or a File”. The parameter data is stored in a `Simulink.SimulationData.Parameter` object, accessible as an element in the exported `Simulink.SimulationData.Dataset`.

Limitations

- Except for the Dashboard Scope block and the Display block, dashboard blocks can only connect to real scalar signals.
- The toolstrip does not support blocks that are inside a panel.
- You cannot use the **Connection** table in the block dialog to connect a dashboard block to a block that is commented out. When you connect a dashboard block to a commented block using connect

mode, the dashboard block does not display the connected value until the you uncomment the block.

- Dashboard blocks cannot connect to model elements inside referenced models.
- When you simulate a model hierarchy, dashboard blocks inside referenced models do not update.
- Dashboard blocks do not support rapid accelerator simulation.
- When you connect a dashboard block to a variable or parameter during simulation, the data for that variable or parameter is not logged to the Simulation Data Inspector. To log variable and parameter data to the Simulation Data Inspector, connect the dashboard block to the variable or parameter prior to simulation.
- When you simulate a model in external mode with the **Default parameter behavior** set to **Inlined**, dashboard blocks can appear to change parameter and variable values. However, the change does not propagate to the simulation. For example, Gain blocks display changes made to the **Gain** parameter using the dashboard blocks, but the **Gain** value used in the simulation does not change.

Parameters

Connection — Select a variable or block parameter to connect

variable and parameter connection options

Select the variable or block parameter to control using the **Connection** table. To connect the block to a signal:

- 1 Make a selection in the model that includes one or more blocks.
- 2 Select the variable or parameter you want to connect.

When the value of the selected variable or block parameter is nonscalar, use the text box at the bottom of the **Connection** table to specify the element you want to connect to the dashboard block. To connect to an element of a vector, matrix, or array, specify the element index, for example, 3 or (1, 3). To connect to an element in a bus or structure, specify the element in the context of the bus or structure hierarchy by using dots to indicate different levels in the hierarchy, and omit the top level. For example, specify a.b to connect to scalar element b of the structure or bus a nested inside the selected composite variable or parameter.

- 3 Click **Apply**.

To facilitate understanding and debugging your model, you can connect Dashboard blocks to variables and parameters in your model during simulation.

Note To see workspace variables in the connection table, update the model diagram using **Ctrl+D**.

Programmatic Use

To programmatically connect a dashboard block to a tunable parameter or a variable, use a `Simulink.HMI.ParamSourceInfo` object. The `Simulink.HMI.ParamSourceInfo` object contains four properties. Some of the properties apply to connecting dashboard blocks to parameters, and some apply to connecting dashboard blocks to variables. Not all fields have a value for a connection because a given dashboard block connects to either a parameter or a variable.

Block Parameter: Binding

Type: Simulink.HMI.ParamSourceInfo

Default: []

Check Box Label — Description of check box action

Label (default) | character vector

Label that appears next to the check box. You can use the **Check Box Label** to describe what happens in your model when you check the check box.

Example: Enable sound

Programmatic Use

Block Parameter: Label

Type: character vector

Default: 'Label'

Checked/Unchecked Values — Values to assign for checked and unchecked states

Unchecked: 0 Checked: 1 (default) | scalar

Value to assign to the connected variable or parameter for the checked and unchecked block states.

- Unchecked — Value assigned to the connected parameter when the Check Box block is not checked.
- Checked — Value assigned to the connected parameter when the Check Box block is checked.

Programmatic Use

You set the **Unchecked** and **Checked** values programmatically using a 2-by-1 vector that contains the **Unchecked** and **Checked** values, in that order.

Block Parameter: Values

Type: 2x1 vector

Default: [0 1]

Label — Block label position

Hide (default) | Bottom | Top

Position of the block label. When the block is connected to an element in the model, the label is the name of the connected element.

Programmatic Use

Block Parameter: LabelPosition

Type: character vector

Values: 'Hide' | 'Bottom' | 'Top'

Default: 'Hide'

Opacity — Block background opacity

1 (default) | scalar

Block background opacity, specified as a scalar value between 0 and 1.

Example: 0.5

Programmatic Use

Block Parameter: Opacity

Type: scalar

Default: 1

Foreground Color — Block foreground color

[r g b] vector

Block foreground color, including the text. You can select a color from a palette of standard colors or specify a custom color.

Programmatic Use

Specify the `ForegroundColor` parameter for the block as a 1-by-3 [r g b] vector with values between 0 and 1.

Block Parameter: `ForegroundColor`

Type: [r g b] vector

Background Color — Block background color

[r g b] vector

Block background color. You can select a color from a palette of standard colors or specify a custom color.

Programmatic Use

Specify the `BackgroundColor` parameter for the block as a 1-by-3 [r g b] vector with values between 0 and 1.

Block Parameter: `BackgroundColor`

Type: [r g b] vector

Block Characteristics

| | |
|---------------------------------|----------------------------------|
| Data Types | double half integer single |
| Direct Feedthrough | no |
| Multidimensional Signals | no |
| Variable-Size Signals | no |
| Zero-Crossing Detection | no |

Extended Capabilities**C/C++ Code Generation**

Generate C and C++ code using Simulink® Coder™.

Dashboard blocks are ignored for code generation.

See Also

Rocker Switch | Slider Switch | Toggle Switch | Rotary Switch

Topics

“Tune and Visualize Your Model with Dashboard Blocks”

“Decide How to Visualize Simulation Data”

Introduced in R2017b

Check Discrete Gradient

Check that absolute value of difference between successive samples of discrete signal is less than specified value

Library: Simulink / Model Verification
HDL Coder / Model Verification

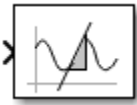

Description

The Check Discrete Gradient block checks each signal element and determines whether the absolute value of the difference between successive values of the element is less than an specified value. The block then executes an assertion after comparison. You can specify the value of gradient (1 by default) by adjusting the **Maximum gradient** parameter. If the input signal difference is less than the absolute value of the **Maximum gradient**, the assertion is `true` (1) and the block does nothing. If not, the block halts the simulation and returns an error message by default.

Note To run simulations, the Check Discrete Gradient block requires a fixed-step discrete solver. If another solver is selected, an error prompts.

Ports

Input

Port_1 — Input signal checked against gradient

scalar | vector | matrix

Input signal the block checks to determine if the difference of each element between successive samples is less than the absolute value of the **Maximum gradient** parameter.

Data Types: single | double | int8 | int16 | int32 | int64 | uint8 | uint16 | uint32 | uint64 | fixed point

Output

Port_1 — Assertion output signal

scalar

Output signal that is `true` (1) if the assertion succeeds, and `false` (0) if the assertion fails. If, in the Configuration Parameters window, in the **Math and Data Types** section, under **Advanced parameters**, you select **Implement logic signals as Boolean data**, then the output data type is Boolean. Otherwise, the data type of the signal is double.

Dependencies

To enable this output port, select the **Output assertion signal** parameter check box.

Data Types: double | Boolean

Parameters

Maximum gradient — Maximum value of allowed differences

1 (default) | scalar

Specify the value on the allowed gradient of the input signal.

Programmatic Use

Parameter: gradient

Type: character vector

Values: real scalar

Default: '1'

Enable assertion — Enable or disable check

on (default) | off

Clearing this parameter disables the block and causes the model to behave as if the block does not exist. To enable or disable all verification blocks, regardless of the setting of this option, go to the Configuration Parameters window, click **Diagnostics > Data Validity**, expand the **Advanced parameters** section, and set **Model Verification block enabling** to **Enable all** or **Disable all**.

Programmatic Use

Parameter: enabled

Type: character vector

Values: 'on' | 'off'

Default: 'on'

Simulation callback when assertion fails (optional) — Expression to evaluate when assertion fails

' ' (default) | MATLAB expression

Specify a MATLAB expression to evaluate when the assertion fails. Because the expression is evaluated in the MATLAB workspace, define all variables used in the expression in that workspace.

Dependencies

To enable this parameter, select the **Enable assertion** parameter.

Programmatic Use

Parameter: callback

Type: character vector

Values: MATLAB expression

Default: ''

Stop simulation when assertion fails — Whether to stop simulation when check fails

on (default) | off

Select this parameter to stop the simulation when the check fails. Clear this parameter to display a warning and continue the simulation.

Programmatic Use

Parameter: stopWhenAssertionFail

Type: character vector

Values: 'on' | 'off'

Default: 'on'

Output assertion signal – Create output signal

off (default) | on

Select this parameter to enable the output port.

Programmatic Use**Parameter:** export**Type:** character vector**Values:** 'on' | 'off'**Default:** 'off'**Select icon type – Select icon type**

graphic (default) | text

Specify the style of the block icon. The `graphic` option displays a graphical representation of the assertion condition on the icon. The `text` option displays a mathematical expression that represents the assertion condition.

Programmatic Use**Parameter:** icon**Type:** character vector**Values:** 'graphic' | 'text'**Default:** 'graphic'**Block Characteristics**

| | |
|---------------------------------|---|
| Data Types | double fixed point integer single |
| Direct Feedthrough | no |
| Multidimensional Signals | yes |
| Variable-Size Signals | no |
| Zero-Crossing Detection | no |

Extended Capabilities**C/C++ Code Generation**

Generate C and C++ code using Simulink® Coder™.

For information about how Simulink Coder generated code handles Model Verification blocks, see “Configure Model for Debugging” (Simulink Coder).

Not recommended for production code.

HDL Code Generation

Generate Verilog and VHDL code for FPGA and ASIC designs using HDL Coder™.

HDL Coder provides additional configuration options that affect HDL implementation and synthesized logic.

HDL Architecture

This block can be used to check whether the difference between successive samples is less than the specified gradient during simulation, but is not included in the generated code.

PLC Code Generation

Generate Structured Text code using Simulink® PLC Coder™.

Fixed-Point Conversion

Design and simulate fixed-point systems using Fixed-Point Designer™.

See Also

[Check Dynamic Range](#) | [Check Dynamic Gap](#)

Introduced before R2006a

Check Dynamic Gap

Check that gap of possibly varying width occurs in range of signal's amplitudes

Library: Simulink / Model Verification
HDL Coder / Model Verification

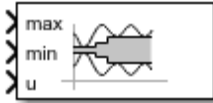

Description

The Check Dynamic Gap block checks that a signal falls outside a range of values at each time step and executes an assertion after comparison. The width of the gap can vary from time step to time step. The **u** port is the tested input signal. The inputs **min** and **max** specify the lower and upper bounds of the gap, respectively. If **u** falls outside of the gap defined by **min** and **max**, the assertion is `true` (1) and the block does nothing. If not, the block halts the simulation and returns an error message by default.

The input signals can be scalars, vectors, or matrices. All three input signals must be the same data type. The block compares the value of **u** to the bounds differently depending on the signal.

- When comparing scalars to vectors or matrices, the block compares the scalar signal to each element of the non-scalar signal.
- When comparing vectors or matrix signals to other vectors or matrices, the block compares the input to the bounds element-by-element.
- For models with more than one vector or matrix input signal, the vectors or matrices must have the same dimensions.

Ports

Input

max — Upper bound of dynamic gap

scalar | vector | matrix

Signal specifying the upper bound of the gap.

Data Types: half | single | double | int8 | int16 | int32 | int64 | uint8 | uint16 | uint32 | uint64 | Boolean | fixed point | enumerated

min — Lower bound of dynamic gap

scalar | vector | matrix

Signal specifying the lower bound of the gap.

Data Types: half | single | double | int8 | int16 | int32 | int64 | uint8 | uint16 | uint32 | uint64 | Boolean | fixed point | enumerated

u — Input signal checked against gap

scalar | vector | matrix

Input signal checked for a gap of width specified by **max** and **min**.

Data Types: half | single | double | int8 | int16 | int32 | int64 | uint8 | uint16 | uint32 | uint64 | Boolean | fixed point | enumerated

Output

Port_1 — Assertion output signal

scalar

Output signal that is true (1) if the assertion succeeds, and false (0) if the assertion fails. If, in the Configuration Parameters window, in the **Math and Data Types** section, under **Advanced parameters**, you select **Implement logic signals as Boolean data**, then the output data type is Boolean. Otherwise, the data type of the signal is double.

Dependencies

To enable this output port, select the **Output assertion signal** parameter check box.

Data Types: double | Boolean

Parameters

Enable assertion — Enable or disable check

on (default) | off

Clearing this parameter disables the block and causes the model to behave as if the block does not exist. To enable or disable all verification blocks, regardless of the setting of this option, go to the Configuration Parameters window, click **Diagnostics > Data Validity**, expand the **Advanced parameters** section, and set **Model Verification block enabling** to **Enable all** or **Disable all**.

Programmatic Use

Parameter: enabled

Type: character vector

Values: 'on' | 'off'

Default: 'on'

Simulation callback when assertion fails (optional) — Expression to evaluate when assertion fails

' ' (default) | MATLAB expression

Specify a MATLAB expression to evaluate when the assertion fails. Because the expression is evaluated in the MATLAB workspace, define all variables used in the expression in that workspace.

Dependencies

To enable this parameter, select the **Enable assertion** parameter.

Programmatic Use

Parameter: callback

Type: character vector

Values: MATLAB expression

Default: ' '

Stop simulation when assertion fails — Whether to stop simulation when check fails

on (default) | off

Select this parameter to stop the simulation when the check fails. Clear this parameter to display a warning and continue the simulation.

Programmatic Use

Parameter: stopWhenAssertionFail

Type: character vector

Values: 'on' | 'off'

Default: 'on'

Output assertion signal – Create output signal

off (default) | on

Select this parameter to enable the output port.

Programmatic Use

Parameter: export

Type: character vector

Values: 'on' | 'off'

Default: 'off'

Select icon type – Select icon type

graphic (default) | text

Specify the style of the block icon. The `graphic` option displays a graphical representation of the assertion condition on the icon. The `text` option displays a mathematical expression that represents the assertion condition.

Programmatic Use

Parameter: icon

Type: character vector

Values: 'graphic' | 'text'

Default: 'graphic'

Block Characteristics

| | |
|---------------------------------|---|
| Data Types | Boolean double enumerated fixed point half integer single |
| Direct Feedthrough | no |
| Multidimensional Signals | yes |
| Variable-Size Signals | no |
| Zero-Crossing Detection | no |

Extended Capabilities

C/C++ Code Generation

Generate C and C++ code using Simulink® Coder™.

For information about how Simulink Coder generated code handles Model Verification blocks, see “Configure Model for Debugging” (Simulink Coder).

Not recommended for production code.

HDL Code Generation

Generate Verilog and VHDL code for FPGA and ASIC designs using HDL Coder™.

HDL Coder provides additional configuration options that affect HDL implementation and synthesized logic.

HDL Architecture

This block can be used to check the gap in the varying signal amplitudes, but it is not included in the generated code.

PLC Code Generation

Generate Structured Text code using Simulink® PLC Coder™.

Fixed-Point Conversion

Design and simulate fixed-point systems using Fixed-Point Designer™.

See Also

[Check Dynamic Lower Bound](#) | [Check Dynamic Upper Bound](#) | [Check Dynamic Range](#)

Introduced before R2006a

Check Dynamic Lower Bound

Check that one signal is always less than another signal

Library: Simulink / Model Verification
HDL Coder / Model Verification

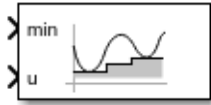

Description

The Check Dynamic Lower Bound block checks if a reference signal, **min**, is less than the amplitude of an input signal, **u** at each time step and executes an assertion after comparison. If **min** is less than **u**, the assertion is `true` (1) and the block does nothing. If not, the block halts the simulation and returns an error message by default.

The input signals can be scalars, vectors, or matrices. Both input signals must be the same data type. The block compares the value of **u** to the bound differently depending on the signal.

- When comparing scalars to vectors or matrices, the block compares the scalar signal to each element of the non-scalar signal.
- When comparing a vector or matrix signal to another vector or matrix signal, the block checks the signals element-by-element.
- For models with an input and bound that are both vectors or matrices, the input and bound must have the same dimensions.

Ports

Input

min — Lower bound of dynamic range check

scalar | vector | matrix

Signal specifying the lower bound of the check against the input signal **u** amplitude. Signal data type and dimension must be the same as **u**.

Data Types: half | single | double | int8 | int16 | int32 | int64 | uint8 | uint16 | uint32 | uint64 | Boolean | fixed point | enumerated

u — Input signal checked against bound

scalar | vector | matrix

Input signal checked against the lower bound specified by **min**. Both input signals must be the same data type and dimension.

Data Types: half | single | double | int8 | int16 | int32 | int64 | uint8 | uint16 | uint32 | uint64 | Boolean | fixed point | enumerated

Output

Port_1 — Assertion output signal

scalar

Output signal that is `true` (1) if the assertion succeeds and `false` (0) if the assertion fails. If, in the Configuration Parameters window, in the **Math and Data Types** section, under **Advanced parameters**, you select **Implement logic signals as Boolean data**, then the output data type is Boolean. Otherwise, the data type of the signal is double.

Dependencies

To enable this output port, select the **Output assertion signal** parameter check box.

Data Types: double | Boolean

Parameters

Enable assertion — Enable or disable check

on (default) | off

Clearing this parameter disables the block and causes the model to behave as if the block does not exist. To enable or disable all verification blocks, regardless of the setting of this option, go to the Configuration Parameters window, click **Diagnostics > Data Validity**, expand the **Advanced parameters** section, and set **Model Verification block enabling** to `Enable all` or `Disable all`.

Programmatic Use

Parameter: enabled

Type: character vector

Values: 'on' | 'off'

Default: 'on'

Simulation callback when assertion fails (optional) — Expression to evaluate when assertion fails

' ' (default) | MATLAB expression

Specify a MATLAB expression to evaluate when the assertion fails. Because the expression is evaluated in the MATLAB workspace, define all variables used in the expression in that workspace.

Dependencies

To enable this parameter, select the **Enable assertion** parameter.

Programmatic Use

Parameter: callback

Type: character vector

Values: MATLAB expression

Default: ' '

Stop simulation when assertion fails — Whether to stop simulation when check fails

on (default) | off

Select this parameter to stop the simulation when the check fails. Clear this parameter to display a warning and continue the simulation.

Programmatic Use**Parameter:** stopWhenAssertionFail**Type:** character vector**Values:** 'on' | 'off'**Default:** 'on'**Output assertion signal – Create output signal**

off (default) | on

Select this parameter to enable the output port.

Programmatic Use**Parameter:** export**Type:** character vector**Values:** 'on' | 'off'**Default:** 'off'**Select icon type – Select icon type**

graphic (default) | text

Specify the style of the block icon. The graphic option displays a graphical representation of the assertion condition on the icon. The text option displays a mathematical expression that represents the assertion condition.

Programmatic Use**Parameter:** icon**Type:** character vector**Values:** 'graphic' | 'text'**Default:** 'graphic'**Block Characteristics**

| | |
|---------------------------------|---|
| Data Types | Boolean double enumerated fixed point half integer single |
| Direct Feedthrough | no |
| Multidimensional Signals | yes |
| Variable-Size Signals | no |
| Zero-Crossing Detection | no |

Extended Capabilities**C/C++ Code Generation**

Generate C and C++ code using Simulink® Coder™.

For information about how Simulink Coder generated code handles Model Verification blocks, see “Configure Model for Debugging” (Simulink Coder).

HDL Code Generation

Generate Verilog and VHDL code for FPGA and ASIC designs using HDL Coder™.

HDL Coder provides additional configuration options that affect HDL implementation and synthesized logic.

HDL Architecture

This block can be used to check the lower bound of a test signal as compared to the input, but it is not included in the generated code.

PLC Code Generation

Generate Structured Text code using Simulink® PLC Coder™.

Fixed-Point Conversion

Design and simulate fixed-point systems using Fixed-Point Designer™.

See Also

[Check Dynamic Upper Bound](#) | [Check Dynamic Range](#)

Introduced before R2006a

Check Dynamic Range

Check that signal falls inside range of amplitudes that varies from time step to time step

Library: Simulink / Model Verification
HDL Coder / Model Verification

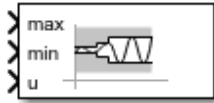

Description

The Check Dynamic Range block checks that a signal falls inside a range of values at each time step and executes an assertion after comparison. The width of the range can vary from time step to time step. The **u** port is the tested input signal. The **min** and **max** ports are the lower and upper bounds of the range, respectively. If **u** is between **max** and **min**, the assertion is `true` (1) and the block does nothing. If not, the block halts the simulation and returns an error message by default.

The input signals can be scalars, vectors, or matrices. All three input signals must be the same data type. The block compares the value of **u** to the bounds differently depending on the signal.

- When comparing scalars to vectors or matrices, the block compares the scalar signal to each element of the non-scalar signal.
- When comparing vectors or matrix signals to other vectors or matrices, the block checks the inputs element-by-element.
- For models with more than one vector or matrix input signal, the vectors or matrices must have the same dimensions.

Ports

Input

max — Upper bound of dynamic range check

scalar | vector | matrix

Signal specifying the upper bound of the range.

Data Types: half | single | double | int8 | int16 | int32 | int64 | uint8 | uint16 | uint32 | uint64 | Boolean | fixed point | enumerated

min — Lower bound of dynamic range check

scalar | vector | matrix

Signal specifying the lower bound of the range.

Data Types: half | single | double | int8 | int16 | int32 | int64 | uint8 | uint16 | uint32 | uint64 | Boolean | fixed point | enumerated

u — Input signal checked against range

scalar | vector | matrix

Signal checked against the range specified by the **max** and **min** ports.

Data Types: half | single | double | int8 | int16 | int32 | int64 | uint8 | uint16 | uint32 | uint64 | Boolean | fixed point | enumerated

Output

Port_1 — Assertion output signal

scalar

Output signal that is `true` (1) if the assertion succeeds and `false` (0) if the assertion fails. If, in the Configuration Parameters window, in the **Math and Data Types** section, under **Advanced parameters**, you select **Implement logic signals as Boolean data**, then the output data type is Boolean. Otherwise, the data type of the signal is double.

Dependencies

To enable this port, select the **Output assertion signal** parameter.

Data Types: double | Boolean

Parameters

Enable assertion — Enable or disable check

on (default) | off

Clearing this parameter disables the block and causes the model to behave as if the block does not exist. To enable or disable all verification blocks, regardless of the setting of this option, go to the Configuration Parameters window, click **Diagnostics > Data Validity**, expand the **Advanced parameters** section, and set **Model Verification block enabling** to `Enable all` or `Disable all`.

Programmatic Use

Parameter: enabled

Type: character vector

Values: 'on' | 'off'

Default: 'on'

Simulation callback when assertion fails (optional) — Expression to evaluate when assertion fails

' ' (default) | MATLAB expression

Specify a MATLAB expression to evaluate when the assertion fails. Because the expression is evaluated in the MATLAB workspace, define all variables used in the expression in that workspace.

Dependencies

To enable this parameter, select the **Enable assertion** parameter.

Programmatic Use

Parameter: callback

Type: character vector

Values: MATLAB expression

Default: ' '

Stop simulation when assertion fails — Whether to stop simulation when check fails

on (default) | off

Select this parameter to stop the simulation when the check fails. Clear this parameter to display a warning and continue the simulation.

Programmatic Use

Parameter: stopWhenAssertionFail

Type: character vector

Values: 'on' | 'off'

Default: 'on'

Output assertion signal – Create output signal

off (default) | on

Select this parameter to enable the output port.

Programmatic Use

Parameter: export

Type: character vector

Values: 'on' | 'off'

Default: 'off'

Select icon type – Select icon type

graphic (default) | text

Specify the style of the block icon. The `graphic` option displays a graphical representation of the assertion condition on the icon. The `text` option displays a mathematical expression that represents the assertion condition.

Programmatic Use

Parameter: icon

Type: character vector

Values: 'graphic' | 'text'

Default: 'graphic'

Block Characteristics

| | |
|---------------------------------|---|
| Data Types | Boolean double enumerated fixed point half integer single |
| Direct Feedthrough | no |
| Multidimensional Signals | yes |
| Variable-Size Signals | no |
| Zero-Crossing Detection | no |

Extended Capabilities

C/C++ Code Generation

Generate C and C++ code using Simulink® Coder™.

For information about how Simulink Coder generated code handles Model Verification blocks, see “Configure Model for Debugging” (Simulink Coder).

HDL Code Generation

Generate Verilog and VHDL code for FPGA and ASIC designs using HDL Coder™.

HDL Coder provides additional configuration options that affect HDL implementation and synthesized logic.

HDL Architecture

This block can be used to check whether a test signal falls within a range of amplitudes, but it is not included in the generated code.

PLC Code Generation

Generate Structured Text code using Simulink® PLC Coder™.

Fixed-Point Conversion

Design and simulate fixed-point systems using Fixed-Point Designer™.

See Also

Relational Operator

Introduced before R2006a

Check Dynamic Upper Bound

Check that one signal is always greater than another signal

Library: Simulink / Model Verification
HDL Coder / Model Verification

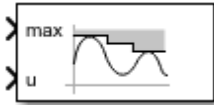

Description

The Check Dynamic Upper Bound block checks if the a reference signal, **max**, is greater than the amplitude of an input signal, **u**, at each time step and executes an assertion after comparison. If **max** is greater than **u**, the assertion is `true` (1) and the block does nothing. If not, the block halts the simulation and returns an error message by default.

The input signals can be scalars, vectors, or matrices. Both input signals must be the same data type. The block compares the value of **u** to **max** differently depending on the signal.

- When comparing scalars to vectors or matrices, the block compares the scalar signal to each element of the non-scalar signal.
- When comparing a vector or matrix signal to another vector or matrix signal, the block checks the signals element-by-element.
- For models with an input signal and bound that are both vectors or matrices, the input signal and bound must have the same dimensions.

Ports

Input

max — Upper bound of range check

scalar | vector | matrix

Signal specifying the lower bound of the range that the block checks the input signal **u** amplitude. Signal data type and dimension must be the same as **u**.

Data Types: half | single | double | int8 | int16 | int32 | int64 | uint8 | uint16 | uint32 | uint64 | Boolean | fixed point | enumerated

u — Input signal checked against bound

scalar | vector | matrix

Input signal checked against the lower bound specified by **min**.

Data Types: half | single | double | int8 | int16 | int32 | int64 | uint8 | uint16 | uint32 | uint64 | Boolean | fixed point | enumerated

Output

Port_1 — Assertion output signal

scalar

Output signal that is `true` (1) if the assertion succeeds and `false` (0) if the assertion fails. If, in the Configuration Parameters window, in the **Math and Data Types** section, under **Advanced parameters**, you select **Implement logic signals as Boolean data**, then the output data type is Boolean. Otherwise, the data type of the signal is double.

Dependencies

To enable this output port, select the **Output assertion signal** parameter check box.

Data Types: `double` | `Boolean`

Parameters

Enable assertion – Enable or disable check

`on` (default) | `off`

Clearing this parameter disables the block and causes the model to behave as if the block does not exist. To enable or disable all verification blocks, regardless of the setting of this option, go to the Configuration Parameters window, click **Diagnostics > Data Validity**, expand the **Advanced parameters** section, and set **Model Verification block enabling** to `Enable all` or `Disable all`.

Programmatic Use

Parameter: `enabled`

Type: character vector

Values: `'on'` | `'off'`

Default: `'on'`

Simulation callback when assertion fails (optional) – Expression to evaluate when assertion fails

`''` (default) | MATLAB expression

Specify a MATLAB expression to evaluate when the assertion fails. Because the expression is evaluated in the MATLAB workspace, define all variables used in the expression in that workspace.

Dependencies

To enable this parameter, select the **Enable assertion** parameter.

Programmatic Use

Parameter: `callback`

Type: character vector

Values: MATLAB expression

Default: `''`

Stop simulation when assertion fails – Whether to stop simulation when check fails

`on` (default) | `off`

Select this parameter to stop the simulation when the check fails. Clear this parameter to display a warning and continue the simulation.

Programmatic Use

Parameter: `stopWhenAssertionFail`

Type: character vector

Values: `'on'` | `'off'`

Default: `'on'`

Output assertion signal – Create output signal

off (default) | on

Select this parameter to enable the output port.

Programmatic Use**Parameter:** export**Type:** character vector**Values:** 'on' | 'off'**Default:** 'off'**Select icon type – Select icon type**

graphic (default) | text

Specify the style of the block icon. The `graphic` option displays a graphical representation of the assertion condition on the icon. The `text` option displays a mathematical expression that represents the assertion condition.

Programmatic Use**Parameter:** icon**Type:** character vector**Values:** 'graphic' | 'text'**Default:** 'graphic'**Block Characteristics**

| | |
|---------------------------------|---|
| Data Types | Boolean double enumerated fixed point half integer single |
| Direct Feedthrough | no |
| Multidimensional Signals | yes |
| Variable-Size Signals | no |
| Zero-Crossing Detection | no |

Extended Capabilities**C/C++ Code Generation**

Generate C and C++ code using Simulink® Coder™.

For information about how Simulink Coder generated code handles Model Verification blocks, see “Configure Model for Debugging” (Simulink Coder).

HDL Code Generation

Generate Verilog and VHDL code for FPGA and ASIC designs using HDL Coder™.

HDL Coder provides additional configuration options that affect HDL implementation and synthesized logic.

HDL Architecture

This block can be used to check the upper bound of a test signal as compared to the input, but it is not included in the generated code.

PLC Code Generation

Generate Structured Text code using Simulink® PLC Coder™.

Fixed-Point Conversion

Design and simulate fixed-point systems using Fixed-Point Designer™.

See Also

[Check Dynamic Lower Bound](#) | [Check Dynamic Range](#)

Introduced before R2006a

Check Input Resolution

Check that input signal has specified resolution

Library: Simulink / Model Verification
HDL Coder / Model Verification

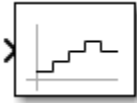

Description

The Check Input Resolution block checks whether the input signal has a specified resolution. The block input and resolution can be either a scalar or vector. The input and resolution must be the same data type.

If the **Resolution** parameter is a scalar, the block calculates the modulus of the input signal over the provided scalar resolution. The calculated modulus is then compared to a tolerance of $10e-3$, and executes an assertion after comparison. If the modulus is less than the tolerance, the assertion is `true (1)` and the block does nothing. If not, the block halts the simulation and returns an error message by default. If the **Resolution** parameter is a vector, it asserts `true (1)` if the value of the input signal is equal to any of the resolution vector elements.

The block compares the input to the resolution in several additional ways depending on the dimensions of the signal and resolution.

- When comparing a scalar input signal or resolution to a vector input signal or resolution, the block compares the scalar to each element of the vector.
- When comparing a vector input signal to a vector resolution, the block compares the input signal to the resolution element-by-element.
- For models with an input signal and resolution that are both vectors, the input signal and resolution must have the same dimensions.

Ports

Input

Port_1 – Input signal checked against resolution

scalar | vector

Input signal that the block checks against the resolution specified by the **Resolution** parameter.

Data Types: double

Output

Port_1 – Assertion output signal

scalar

Output signal that is `true (1)` if the assertion succeeds and `false (0)` if the assertion fails. If, in the Configuration Parameters window, in the **Math and Data Types** section, under **Advanced**

parameters, you select **Implement logic signals as Boolean data**, then the output data type is Boolean. Otherwise, the data type of the signal is double.

Dependencies

To enable this port, select **Output assertion signal**.

Data Types: double | Boolean

Parameters

Resolution — Resolution value to compare to input signal

scalar | vector

Specify the resolution requirement for the input signal.

Programmatic Use

Parameter: resolution

Type: character vector

Values: '1' | real scalar or vector

Default: '1'

Enable assertion — Enable or disable check

on (default) | off

Clearing this parameter disables the block and causes the model to behave as if the block does not exist. To enable or disable all verification blocks, regardless of the setting of this option, go to the Configuration Parameters window, click **Diagnostics > Data Validity**, expand the **Advanced parameters** section, and set **Model Verification block enabling** to **Enable all** or **Disable all**.

Programmatic Use

Parameter: enabled

Type: character vector

Values: 'on' | 'off'

Default: 'on'

Simulation callback when assertion fails (optional) — Expression to evaluate when assertion fails

' ' (default) | MATLAB expression

Specify a MATLAB expression to evaluate when the assertion fails. Because the expression is evaluated in the MATLAB workspace, define all variables used in the expression in that workspace.

Dependencies

To enable this parameter, select the **Enable assertion** parameter.

Programmatic Use

Parameter: callback

Type: character vector

Values: MATLAB expression

Default: ''

Stop simulation when assertion fails — Whether to stop simulation when check fails

on (default) | off

Select this parameter to stop the simulation when the check fails. Clear this parameter to display a warning and continue the simulation.

Programmatic Use

Parameter: stopWhenAssertionFail

Type: character vector

Values: 'on' | 'off'

Default: 'on'

Output assertion signal – Create output signal

off (default) | on

Select this parameter to enable the output port.

Programmatic Use

Parameter: export

Type: character vector

Values: 'on' | 'off'

Default: 'off'

Block Characteristics

| | |
|---------------------------------|--------|
| Data Types | double |
| Direct Feedthrough | no |
| Multidimensional Signals | yes |
| Variable-Size Signals | no |
| Zero-Crossing Detection | no |

Extended Capabilities

C/C++ Code Generation

Generate C and C++ code using Simulink® Coder™.

For information about how Simulink Coder generated code handles Model Verification blocks, see “Configure Model for Debugging” (Simulink Coder).

Not recommended for production code.

HDL Code Generation

Generate Verilog and VHDL code for FPGA and ASIC designs using HDL Coder™.

HDL Coder provides additional configuration options that affect HDL implementation and synthesized logic.

HDL Architecture

This block can be used to check whether the input signal has a specified resolution during simulation, but it is not included in the generated code.

PLC Code Generation

Generate Structured Text code using Simulink® PLC Coder™.

See Also

Math Function | Repeating Sequence Stair

Introduced before R2006a

Check Static Gap

Check that gap exists in signal's range of amplitudes

Library: Simulink / Model Verification
HDL Coder / Model Verification



Description

The Check Static Gap block checks that an input signal is less than (or optionally equal to) a static lower bound or greater than (or optionally equal to) a static upper bound at the current time step. The **Upper bound** and **Lower bound** parameters define the upper and lower bounds of the gap. The block then executes an assertion after comparison. If the signal falls outside of the gap, the assertion is `true` (1) and the block does nothing. If not, the block halts the simulation and returns an error message by default.

The input signal and bounds can be scalars, vectors, or matrices. The input and the bounds must be the same data type. The block compares the value of the input to the bounds differently depending on the signal.

- When comparing scalars to vectors or matrices, the block compares the scalar to each element of the non-scalar input signal or bound.
- When comparing vectors or matrix signals to other vectors or matrices, the block compares the input signal and the bounds element-by-element.
- For models with more than one vector or matrix as the input signal or bounds, the vectors or matrices must have the same dimensions.

Ports

Input

Port_1 — Input signal checked against gap

scalar | vector | matrix

Input signal the block checks if the signal value is less than a static lower bound or greater than a static upper bound.

Data Types: `half` | `single` | `double` | `int8` | `int16` | `int32` | `int64` | `uint8` | `uint16` | `uint32` | `uint64` | `Boolean` | `fixed point` | `enumerated` | `bus`

Output

Port_1 — Assertion output signal

scalar

Output signal that is `true` (1) if the assertion succeeds, and `false` (0) if the assertion fails. If, in the Configuration Parameters window, in the **Math and Data Types** section, under **Advanced**

parameters, you select **Implement logic signals as Boolean data**, then the output data type is Boolean. Otherwise, the data type of the signal is double.

Dependencies

To enable this output port, set the **Output assertion signal** parameter check box.

Data Types: double | Boolean

Parameters

Upper bound — Upper boundary value

scalar | vector | matrix

Specify the upper bound on the range of amplitudes that the input signal can have.

Programmatic Use

Parameter: max

Type: character vector

Values: scalar | vector | matrix

Default: '0'

Inclusive upper bound — Include the upper bound in range

on (default) | off

Select this check box to make the range of valid input amplitudes include the upper bound.

Programmatic Use

Parameter: max_included

Type: character vector

Values: 'on' | 'off'

Default: 'on'

Lower bound — Lower boundary value

scalar | vector | matrix

Specify the lower bound on the range of amplitudes that the input signal can have.

Programmatic Use

Parameter: min

Type: character vector

Values: scalar | vector | matrix

Default: '0'

Inclusive lower bound — Include the lower bound in range

on (default) | off

Select this check box to make the range of valid input amplitudes include the lower bound.

Programmatic Use

Parameter: min_included

Type: character vector

Values: 'on' | 'off'

Default: 'on'

Enable assertion — Enable or disable check

on (default) | off

Clearing this parameter disables the block and causes the model to behave as if the block does not exist. To enable or disable all verification blocks, regardless of the setting of this option, go to the Configuration Parameters window, click **Diagnostics > Data Validity**, expand the **Advanced parameters** section, and set **Model Verification block enabling** to **Enable all** or **Disable all**.

Programmatic Use

Parameter: enabled

Type: character vector

Values: 'on' | 'off'

Default: 'on'

Simulation callback when assertion fails (optional) — Expression to evaluate when assertion fails

' ' (default) | MATLAB expression

Specify a MATLAB expression to evaluate when the assertion fails. Because the expression is evaluated in the MATLAB workspace, define all variables used in the expression in that workspace.

Dependencies

To enable this parameter, select the **Enable assertion** parameter.

Programmatic Use

Parameter: callback

Type: character vector

Values: MATLAB expression

Default: ''

Stop simulation when assertion fails — Whether to stop simulation when check fails

on (default) | off

Select this parameter to stop the simulation when the check fails. Clear this parameter to display a warning and continue the simulation.

Programmatic Use

Parameter: stopWhenAssertionFail

Type: character vector

Values: 'on' | 'off'

Default: 'on'

Output assertion signal — Create output signal

off (default) | on

Select this parameter to enable the output port.

Programmatic Use

Parameter: export

Type: character vector

Values: 'on' | 'off'

Default: 'off'

Select icon type — Select icon type

graphic (default) | text

Specify the style of the block icon. The **graphic** option displays a graphical representation of the assertion condition on the icon. The **text** option displays a mathematical expression that represents the assertion condition.

Programmatic Use**Parameter:** icon**Type:** character vector**Values:** 'graphic' | 'text'**Default:** 'graphic'**Block Characteristics**

| | |
|---------------------------------|---|
| Data Types | Boolean double enumerated fixed point half integer single |
| Direct Feedthrough | no |
| Multidimensional Signals | yes |
| Variable-Size Signals | no |
| Zero-Crossing Detection | no |

Extended Capabilities**C/C++ Code Generation**

Generate C and C++ code using Simulink® Coder™.

For information about how Simulink Coder generated code handles Model Verification blocks, see “Configure Model for Debugging” (Simulink Coder).

Not recommended for production code.

HDL Code Generation

Generate Verilog and VHDL code for FPGA and ASIC designs using HDL Coder™.

HDL Coder provides additional configuration options that affect HDL implementation and synthesized logic.

HDL Architecture

This block checks whether each element is less than a static lower bound or greater than a static upper bound during simulation, but it is not included in the generated code.

PLC Code Generation

Generate Structured Text code using Simulink® PLC Coder™.

Fixed-Point Conversion

Design and simulate fixed-point systems using Fixed-Point Designer™.

See Also

Check Dynamic Range | Check Static Upper Bound | Check Static Lower Bound

Introduced before R2006a

Check Static Lower Bound

Check that signal is greater than (or optionally equal to) static lower bound

Library: Simulink / Model Verification
HDL Coder / Model Verification

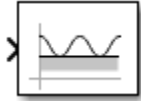

Description

The Check Static Lower Bound block checks if an input signal is greater than (or optionally equal to) a specified lower bound at each time step and executes an assertion after comparison. The **Lower bound** parameter defines the lower bound. If the input signal is greater than the lower bound, the assertion is `true` (1) and the block does nothing. If not, the block halts the simulation and returns an error message by default.

The input signal and bound can be scalars, vectors, or matrices. The input and the bound must be the same data type. The block compares the value of the input to the bound differently depending on the signal.

- When comparing scalars to vectors or matrices, the block compares the scalar to each element of the non-scalar input signal or bound.
- When comparing a vector or matrix input signal to a vector or matrix bound, the block compares the input signal to the bound element-by-element.
- For models with an input signal and bound that are both vectors or matrices, the input signal and bound must have the same dimensions.

Ports

Input

Port_1 — Input signal checked against bound

scalar | vector | matrix

Input signal checked against the lower bound specified by the **Lower bound** parameter.

Data Types: half | single | double | int8 | int16 | int32 | int64 | uint8 | uint16 | uint32 | uint64 | Boolean | fixed point | enumerated

Output

Port_1 — Assertion output signal

scalar

Output signal that is `true` (1) if the assertion succeeds and `false` (0) if the assertion fails. If, in the Configuration Parameters window, in the **Math and Data Types** section, under **Advanced parameters**, you select **Implement logic signals as Boolean data**, then the output data type is Boolean. Otherwise, the data type of the signal is double.

Dependencies

To enable this output port, select the **Output assertion signal** parameter check box.

Data Types: double | Boolean

Parameters

Lower bound — Lower boundary value

scalar | vector | matrix

Specify the lower bound on the range of amplitudes that the input signal can have.

Programmatic Use

Parameter: min

Type: character vector

Values: scalar | vector | matrix

Default: '0'

Inclusive boundary — Include the lower bound in range

on (default) | off

Select this check box to make the range of valid input amplitudes include the lower bound.

Programmatic Use

Parameter: min_included

Type: character vector

Values: 'on' | 'off'

Default: 'on'

Enable assertion — Enable or disable check

on (default) | off

Clearing this parameter disables the block and causes the model to behave as if the block does not exist. To enable or disable all verification blocks, regardless of the setting of this option, go to the Configuration Parameters window, click **Diagnostics > Data Validity**, expand the **Advanced parameters** section, and set **Model Verification block enabling** to **Enable all** or **Disable all**.

Programmatic Use

Parameter: enabled

Type: character vector

Values: 'on' | 'off'

Default: 'on'

Simulation callback when assertion fails (optional) — Expression to evaluate when assertion fails

' ' (default) | MATLAB expression

Specify a MATLAB expression to evaluate when the assertion fails. Because the expression is evaluated in the MATLAB workspace, define all variables used in the expression in that workspace.

Dependencies

To enable this parameter, select the **Enable assertion** parameter.

Programmatic Use**Parameter:** callback**Type:** character vector**Values:** MATLAB expression**Default:** ''**Stop simulation when assertion fails — Whether to stop simulation when check fails**

on (default) | off

Select this parameter to stop the simulation when the check fails. Clear this parameter to display a warning and continue the simulation.

Programmatic Use**Parameter:** stopWhenAssertionFail**Type:** character vector**Values:** 'on' | 'off'**Default:** 'on'**Output assertion signal — Create output signal**

off (default) | on

Select this parameter to enable the output port.

Programmatic Use**Parameter:** export**Type:** character vector**Values:** 'on' | 'off'**Default:** 'off'**Select icon type — Select icon type**

graphic (default) | text

Specify the style of the block icon. The `graphic` option displays a graphical representation of the assertion condition on the icon. The `text` option displays a mathematical expression that represents the assertion condition.

Programmatic Use**Parameter:** icon**Type:** character vector**Values:** 'graphic' | 'text'**Default:** 'graphic'**Block Characteristics**

| | |
|---------------------------------|---|
| Data Types | Boolean double enumerated fixed point half integer single |
| Direct Feedthrough | no |
| Multidimensional Signals | yes |
| Variable-Size Signals | no |
| Zero-Crossing Detection | no |

Extended Capabilities

C/C++ Code Generation

Generate C and C++ code using Simulink® Coder™.

For information about how Simulink Coder generated code handles Model Verification blocks, see “Configure Model for Debugging” (Simulink Coder).

Not recommended for production code.

HDL Code Generation

Generate Verilog and VHDL code for FPGA and ASIC designs using HDL Coder™.

HDL Coder provides additional configuration options that affect HDL implementation and synthesized logic.

HDL Architecture

This block checks whether each input signal element is greater than a static lower bound during simulation, but it is not included in the generated code.

PLC Code Generation

Generate Structured Text code using Simulink® PLC Coder™.

Fixed-Point Conversion

Design and simulate fixed-point systems using Fixed-Point Designer™.

See Also

[Check Static Upper Bound](#) | [Check Dynamic Lower Bound](#) | [Check Dynamic Upper Bound](#) | [Check Dynamic Range](#)

Introduced before R2006a

Check Static Range

Check that signal falls inside fixed range of amplitudes

Library: Simulink / Model Verification
HDL Coder / Model Verification



Description

The Check Static Range block checks that each element of the input signal falls inside the same range of amplitudes at each time step. The **Upper bound** and **Lower bound** parameters define the upper and lower bounds of the range. The block then executes an assertion after comparison. If the signal falls inside the bounds, the assertion is `true` (1) and the block does nothing. If not, the block halts the simulation and returns an error message by default.

The input signal and bounds can be scalars, vectors, or matrices. All three must be the same data type. The block compares the value of the input to the bounds differently depending on the signal.

- When comparing scalars to vectors or matrices, the block compares the scalar to each element of the non-scalar input signal or bounds.
- When comparing vectors or matrix signals to other vectors or matrices, the block compares the input signal to the bounds element-by-element.
- For models with more than one vector or matrix input signal or bounds, the vectors or matrices must have the same dimensions.

Ports

Input

Port_1 — Input signal checked against range

scalar | vector | matrix

Input signal checked against the range specified by the **Upper bound** and **Lower bound** parameters.

Data Types: half | single | double | int8 | int16 | int32 | int64 | uint8 | uint16 | uint32 | uint64 | Boolean | fixed point | enumerated

Output

Port_1 — Assertion output signal

scalar

Output signal that is `true` (1) if the assertion succeeds, and `false` (0) if the assertion fails. If, in the Configuration Parameters window, in the **Math and Data Types** section, under **Advanced parameters**, you select **Implement logic signals as Boolean data**, then the output data type is Boolean. Otherwise, the data type of the signal is double.

Dependencies

To enable this output port, set the **Output assertion signal** parameter check box.

Data Types: double | Boolean

Parameters**Upper bound — Upper bound compared to input signal**

scalar | vector | matrix

Specify the upper bound on the range of amplitudes that the input signal can have.

Programmatic Use

Parameter: max

Type: character vector

Values: scalar | vector | matrix

Default: '0'

Inclusive upper boundary — Include the upper bound in range

on (default) | off

Select this check box to make the range of valid input amplitudes include the lower bound.

Programmatic Use

Parameter: min_included

Type: character vector

Values: 'on' | 'off'

Default: 'on'

Lower bound — Lower bound compared to input signal

scalar | vector | matrix

Specify the lower bound on the range of amplitudes that the input signal can have.

Programmatic Use

Parameter: min

Type: character vector

Values: scalar | vector | matrix

Default: '0'

Inclusive lower bound — Include the lower bound in range

on (default) | off

Select this check box to make the range of valid input amplitudes include the lower bound.

Programmatic Use

Parameter: min_included

Type: character vector

Values: 'on' | 'off'

Default: 'on'

Enable assertion — Enable or disable check

on (default) | off

Clearing this parameter disables the block and causes the model to behave as if the block does not exist. To enable or disable all verification blocks, regardless of the setting of this option, go to the

Configuration Parameters window, click **Diagnostics > Data Validity**, expand the **Advanced parameters** section, and set **Model Verification block enabling** to **Enable all** or **Disable all**.

Programmatic Use

Parameter: enabled

Type: character vector

Values: 'on' | 'off'

Default: 'on'

Simulation callback when assertion fails (optional) – Expression to evaluate when assertion fails

' ' (default) | MATLAB expression

Specify a MATLAB expression to evaluate when the assertion fails. Because the expression is evaluated in the MATLAB workspace, define all variables used in the expression in that workspace.

Dependencies

To enable this parameter, select the **Enable assertion** parameter.

Programmatic Use

Parameter: callback

Type: character vector

Values: MATLAB expression

Default: ''

Stop simulation when assertion fails – Whether to stop simulation when check fails

on (default) | off

Select this parameter to stop the simulation when the check fails. Clear this parameter to display a warning and continue the simulation.

Programmatic Use

Parameter: stopWhenAssertionFail

Type: character vector

Values: 'on' | 'off'

Default: 'on'

Output assertion signal – Create output signal

off (default) | on

Select this parameter to enable the output port.

Programmatic Use

Parameter: export

Type: character vector

Values: 'on' | 'off'

Default: 'off'

Select icon type – Select icon type

graphic (default) | text

Specify the style of the block icon. The **graphic** option displays a graphical representation of the assertion condition on the icon. The **text** option displays a mathematical expression that represents the assertion condition.

Programmatic Use**Parameter:** icon**Type:** character vector**Values:** 'graphic' | 'text'**Default:** 'graphic'**Block Characteristics**

| | |
|---------------------------------|---|
| Data Types | Boolean double enumerated fixed point half integer single |
| Direct Feedthrough | no |
| Multidimensional Signals | yes |
| Variable-Size Signals | no |
| Zero-Crossing Detection | no |

Extended Capabilities**C/C++ Code Generation**

Generate C and C++ code using Simulink® Coder™.

For information about how Simulink Coder generated code handles Model Verification blocks, see “Configure Model for Debugging” (Simulink Coder).

Not recommended for production code.

HDL Code Generation

Generate Verilog and VHDL code for FPGA and ASIC designs using HDL Coder™.

HDL Coder provides additional configuration options that affect HDL implementation and synthesized logic.

HDL Architecture

This block checks whether each input signal element falls within the same amplitude range at each time step during simulation, but it is not included in the generated code.

PLC Code Generation

Generate Structured Text code using Simulink® PLC Coder™.

Fixed-Point Conversion

Design and simulate fixed-point systems using Fixed-Point Designer™.

See Also

Check Dynamic Range | Check Static Lower Bound | Check Static Upper Bound

Introduced before R2006a

Check Static Upper Bound

Check that signal is less than (or optionally equal to) static upper bound

Library: Simulink / Model Verification
HDL Coder / Model Verification

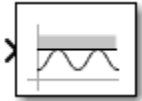

Description

The Check Static Upper Bound block checks if an input signal is less than (or optionally equal to) a specified lower bound at each time step and executes an assertion after comparison. The **Upper bound** parameter defines the upper bound. If the input signal is less than the upper bound, the assertion is `true` (1) and the block does nothing. If not, the block halts the simulation and returns an error message by default.

The input signal and bound can be scalars, vectors, or matrices. The input and the bound must be the same data type. The block compares the value of the input to the bound differently depending on the signal.

- When comparing scalars to vectors or matrices, the block compares the scalar to each element of the non-scalar input signal or bound.
- When comparing a vector or matrix signal to a vector or matrix upper bound, the block compares the input signal to the bound element-by-element.
- For models with an input signal and bound that are both vectors or matrices, the input signal and bound must have the same dimensions.

Ports

Input

Port_1 — Input signal checked against bound

scalar | vector | matrix

Input signal checked against the upper bound specified by the **Upper bound** parameter.

Data Types: half | single | double | int8 | int16 | int32 | int64 | uint8 | uint16 | uint32 | uint64 | Boolean | fixed point | enumerated

Output

Port_1 — Assertion output signal

scalar

Output signal that is `true` (1) if the assertion succeeds and `false` (0) if the assertion fails. If, in the Configuration Parameters window, in the **Math and Data Types** section, under **Advanced parameters**, you select **Implement logic signals as Boolean data**, then the output data type is Boolean. Otherwise, the data type of the signal is double.

Dependencies

To enable this output port, select the **Output assertion signal** parameter check box.

Data Types: double | Boolean

Parameters

Upper bound — Upper boundary value

scalar | vector | matrix

Specify the upper bound on the range of amplitudes that the input signal can have.

Programmatic Use

Parameter: max

Type: character vector

Values: scalar | vector | matrix

Default: '0'

Inclusive boundary — Include the upper bound in range

on (default) | off

Select this check box to make the range of valid input amplitudes include the upper bound.

Programmatic Use

Parameter: max_included

Type: character vector

Values: 'on' | 'off'

Default: 'on'

Enable assertion — Enable or disable check

on (default) | off

Clearing this parameter disables the block and causes the model to behave as if the block does not exist. To enable or disable all verification blocks, regardless of the setting of this option, go to the Configuration Parameters window, click **Diagnostics > Data Validity**, expand the **Advanced parameters** section, and set **Model Verification block enabling** to **Enable all** or **Disable all**.

Programmatic Use

Parameter: enabled

Type: character vector

Values: 'on' | 'off'

Default: 'on'

Simulation callback when assertion fails (optional) — Expression to evaluate when assertion fails

' ' (default) | MATLAB expression

Specify a MATLAB expression to evaluate when the assertion fails. Because the expression is evaluated in the MATLAB workspace, define all variables used in the expression in that workspace.

Dependencies

To enable this parameter, select the **Enable assertion** parameter.

Programmatic Use**Parameter:** callback**Type:** character vector**Values:** MATLAB expression**Default:** ''**Stop simulation when assertion fails — Whether to stop simulation when check fails**

on (default) | off

Select this parameter to stop the simulation when the check fails. Clear this parameter to display a warning and continue the simulation.

Programmatic Use**Parameter:** stopWhenAssertionFail**Type:** character vector**Values:** 'on' | 'off'**Default:** 'on'**Output assertion signal — Create output signal**

off (default) | on

Select this parameter to enable the output port.

Programmatic Use**Parameter:** export**Type:** character vector**Values:** 'on' | 'off'**Default:** 'off'**Select icon type — Select icon type**

graphic (default) | text

Specify the style of the block icon. The `graphic` option displays a graphical representation of the assertion condition on the icon. The `text` option displays a mathematical expression that represents the assertion condition.

Programmatic Use**Parameter:** icon**Type:** character vector**Values:** 'graphic' | 'text'**Default:** 'graphic'**Block Characteristics**

| | |
|---------------------------------|---|
| Data Types | Boolean double enumerated fixed point half integer single |
| Direct Feedthrough | no |
| Multidimensional Signals | yes |
| Variable-Size Signals | no |
| Zero-Crossing Detection | no |

Extended Capabilities

C/C++ Code Generation

Generate C and C++ code using Simulink® Coder™.

For information about how Simulink Coder generated code handles Model Verification blocks, see “Configure Model for Debugging” (Simulink Coder).

Not recommended for production code.

HDL Code Generation

Generate Verilog and VHDL code for FPGA and ASIC designs using HDL Coder™.

HDL Coder provides additional configuration options that affect HDL implementation and synthesized logic.

HDL Architecture

This block checks whether each input signal element is lower than a static upper bound during simulation, but it is not included in the generated code.

PLC Code Generation

Generate Structured Text code using Simulink® PLC Coder™.

Fixed-Point Conversion

Design and simulate fixed-point systems using Fixed-Point Designer™.

See Also

[Check Static Lower Bound](#) | [Check Dynamic Lower Bound](#) | [Check Dynamic Upper Bound](#) | [Check Dynamic Range](#)

Introduced before R2006a

Chirp Signal

Generate sine wave with increasing frequency

Library: Simulink / Sources



Description

The Chirp Signal block generates a sine wave whose frequency increases at a linear rate with time. You can use this block for spectral analysis of nonlinear systems. The block generates a scalar or vector output.

The parameters, **Initial frequency**, **Target time**, and **Frequency at target time**, determine the block's output. You can specify any or all of these variables as scalars or arrays. All the parameters specified as arrays must have the same dimensions. The block expands scalar parameters to have the same dimensions as the array parameters. The block output has the same dimensions as the parameters unless you select the **Interpret vector parameters as 1-D** check box. If you select this check box and the parameters are row or column vectors, the block outputs a vector (1-D array) signal.

Limitations

- The start time of the simulation must be 0. To confirm this value, go to the **Solver** pane in the Configuration Parameters dialog box and view the **Start time** field.
- Suppose that you use a Chirp Signal block in an enabled subsystem. Whenever the subsystem is enabled, the block output matches what would appear if the subsystem were enabled throughout the simulation.

Ports

Output

Port_1 – Chirp signal

scalar | vector | matrix | N-D array

Sine wave whose frequency increases at a linear rate with time. The chirp signal can be a scalar, vector, matrix, or N-D array.

Data Types: double

Parameters

Initial frequency – Initial frequency (Hz)

0.1 (default) | scalar | vector | matrix | N-D array

The initial frequency of the signal, specified as a scalar, vector, matrix, or N-D array.

Programmatic Use**Block Parameter:** f1**Type:** character vector**Values:** scalar | vector | matrix | N-D array**Default:** '0.1'**Target time — Target time (seconds)**

100 (default) | scalar | vector | matrix | N-D array

Time, in seconds, at which the frequency reaches the **Frequency at target time** parameter value. You specify the **Target time** as a scalar, vector, matrix, or N-D array. After the target time is reached, the frequency continues to change at the same rate.

Programmatic Use**Block Parameter:** T**Type:** character vector**Values:** scalar | vector | matrix | N-D array**Default:** '100'**Frequency at target time — Frequency (Hz)**

1 (default) | scalar | vector | matrix | N-D array

Frequency, in Hz, of the signal at the target time, specified as a scalar, vector, matrix, or N-D array.

Programmatic Use**Block Parameter:** f2**Type:** character vector**Values:** scalar | vector | matrix | N-D array**Default:** '1'**Interpret vector parameters as 1-D — Treat vector parameters as 1-D**

on (default) | off

When you select this check box, any column or row matrix values you specify for the **Initial frequency**, **Target time**, and **Frequency at target time** parameters result in a vector output whose elements are the elements of the row or column. For more information, see “Determine the Output Dimensions of Source Blocks”.

Programmatic Use**Block Parameter:** VectorParams1D**Type:** character vector**Values:** 'on' | 'off'**Default:** 'on'**Block Characteristics**

| | |
|---------------------------------|--------|
| Data Types | double |
| Direct Feedthrough | no |
| Multidimensional Signals | no |
| Variable-Size Signals | no |

| | |
|--------------------------------|----|
| Zero-Crossing Detection | no |
|--------------------------------|----|

Extended Capabilities

C/C++ Code Generation

Generate C and C++ code using Simulink® Coder™.

Not recommended for production code. Relates to resource limits and restrictions on speed and memory often found in embedded systems. Generated code can contain dynamic allocation and freeing of memory, recursion, additional memory overhead, and widely-varying execution times. While the code is functionally valid and generally acceptable in resource-rich environments, smaller embedded targets often cannot support such code. Usually, blocks evolve toward being suitable for production code. Thus, blocks suitable for production code remain suitable.

See Also

Sine Wave

Topics

“Creating Signals”

Introduced before R2006a

Circular Gauge

Display signal value during simulation on circular gauge with customizable appearance

Library: Simulink / Dashboard / Customizable Blocks



Description

The Circular Gauge block displays the value of the connected signal on a circular gauge that you can design to look like a gauge in a real system.

The Circular Gauge block displays the instantaneous value of the connected signal throughout simulation. You can modify the range and tick values on the Circular Gauge block to fit your data. Use the Circular Gauge block with other dashboard blocks to build an interactive dashboard of controls and indicators for your model.

Customize Circular Gauge Blocks

When you add a Circular Gauge block to your model, the block is preconfigured with a default design. You can use the block with the default design or customize the appearance of the block using design mode. You can enter design mode in one of three ways after selecting the block:

- On the **Gauge** tab, under **Design**, click **Edit**.
- In the **Property Inspector**, on the **Design** tab, click **Edit**.
- Pause on the ellipsis that appears over the block and click the **Edit Custom Block** button.

Design mode gives you access to block parameters and settings that allow you to customize the appearance of the block. You can use the toolbar above the block to change the background image or needle image and to set the color and opacity of the gauge scale, tick labels, and value bar. To design the appearance of the scale, select the aspect of the scale you want to edit in the middle section of the toolbar. Use the controls on the right of the toolbar to set the color and opacity.

You can also click and drag to reposition the scale and needle. The movement of the needle is limited to the radial line that goes from the center of the block to the minimum value on the scale. You can adjust the angle of the scale arc and the scale size by clicking and dragging the grab points highlighted in design mode.

For fine control over the design of the Circular Gauge block, use the **Design** tab in the **Property Inspector**. You can use the **Property Inspector** to enter exact values for design settings. The **Design** tab also includes design parameters that are not available through the toolbar or interactive editing, such as the ability to add a foreground image to the block.

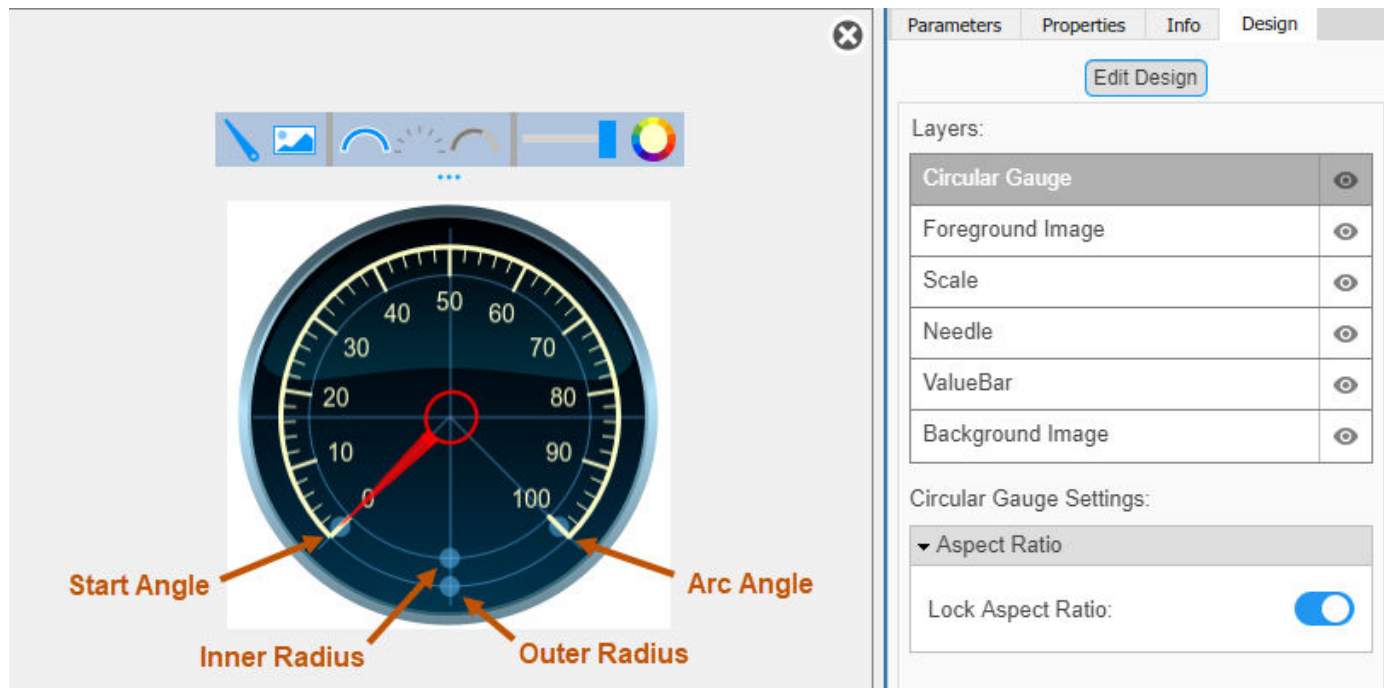

When you finish designing the gauge, click **Exit** in the upper-right of the canvas to exit design mode.

Connect Dashboard Blocks

Dashboard blocks do not use ports to connect to model elements. To connect dashboard blocks to signals in your model, use connect mode. Connect mode facilitates the process of connecting dashboard blocks in your model, especially when you want to connect multiple blocks at once. To connect a single dashboard block, you can also use the **Connection** table in the block dialog box.

Tip You can modify dashboard block connections during normal and accelerator mode simulations.

To enter connect mode, select a dashboard block to connect. Then, on the block tab, click **Connect**. In connect mode, when you select one or more signals or blocks, a list of signals that are available for connection appears. Select a signal from the list to connect to the selected dashboard block. To connect another dashboard block, pause on the block you want to connect and click the **Connect** button above it. Then, select one or more signals and blocks in the model and choose a signal to connect.

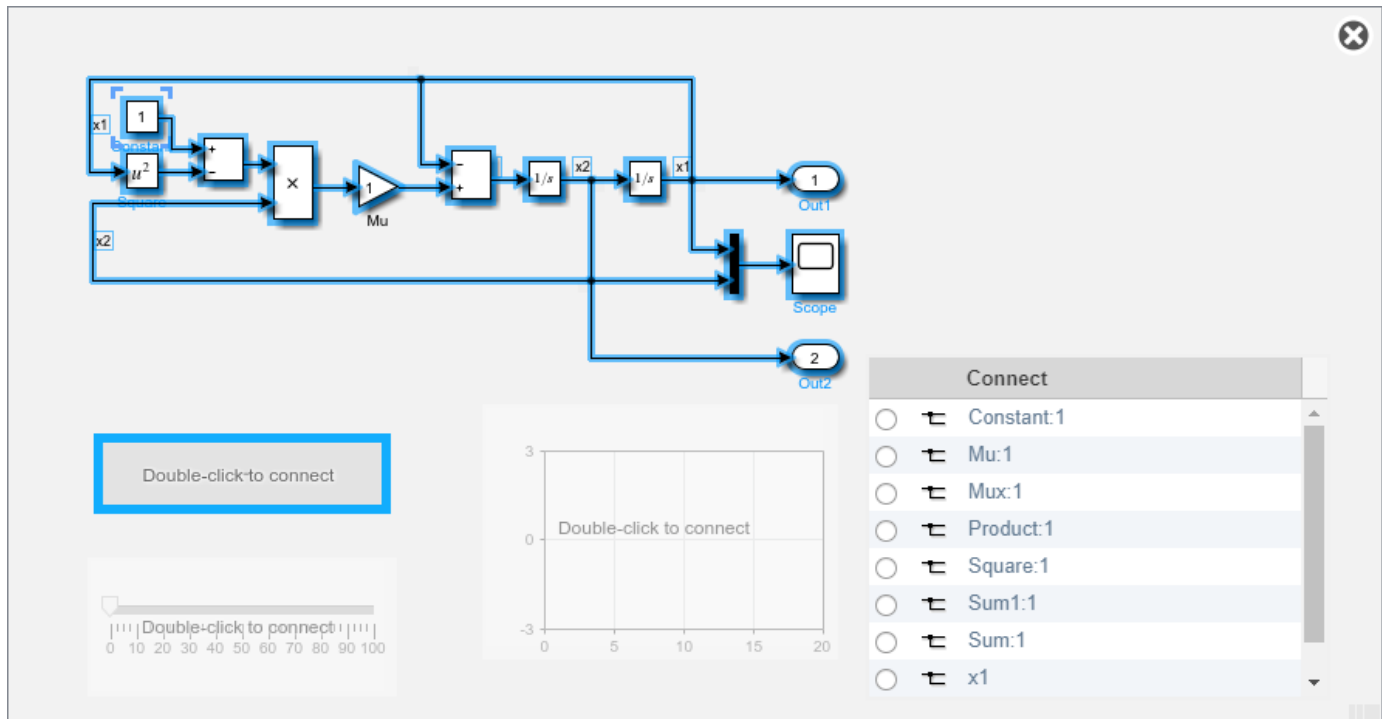

When you finish connecting the dashboard blocks in your model, on the block tab, click **Done Connecting**.

Tip You can hide the message shown on unconnected blocks using the `set_param` function with the `ShowInitialText` block parameter. The message also disappears when you connect the block.

Limitations

- Except for the Dashboard Scope block and the Display block, dashboard blocks can only connect to real scalar signals.
- The toolstrip does not support blocks that are inside a panel.
- You cannot use the **Connection** table in the block dialog to connect a dashboard block to a block that is commented out. When you connect a dashboard block to a commented block using connect mode, the dashboard block does not display the connected value until the you uncomment the block.
- Dashboard blocks cannot connect to model elements inside referenced models.
- When you simulate a model hierarchy, dashboard blocks inside referenced models do not update.
- Dashboard blocks do not support rapid accelerator simulation.
- You cannot connect a dashboard block to data or activity in Stateflow during simulation.
- Some signals do not have data available during simulation due to block reduction or optimization for accelerator mode simulations. To view such a signal using a dashboard block, mark the signal for logging.

Parameters

Connection — Signal to connect and display

signal connection options

Use the connection table to select the signal to connect to the block. To connect the block to a signal:

- 1 Make a selection in the model that includes one or more signals.
- 2 In the table, select the signal you want to connect.
- 3 Click **Apply**.

Tip You can connect dashboard blocks to signals in the model during simulation.

Programmatic Use

Block Parameter: Binding

Type: Simulink.HMI.SignalSpecification

Default: []

Minimum — Minimum tick mark value

0 (default) | scalar

Finite, real, double, scalar value specifying the minimum tick mark value for the scale. The minimum must be less than the value of the **Maximum** parameter.

Programmatic Use

To programmatically set the Minimum parameter, use a 1-by-3 vector containing values for the Minimum, Tick Interval, and Maximum parameters, in that order. To use the **auto** value for the Tick Interval, leave the Tick Interval position in the vector empty or specify -1.

Block Parameter: Limits

Type: 1x3 vector

Default: [0 -1 100]

Maximum — Maximum tick mark value

100 (default) | scalar

Finite, real, double, scalar value specifying the maximum tick mark value for the scale. The maximum must be greater than the value of the **Minimum** parameter.

Programmatic Use

To programmatically set the Maximum parameter, use a 1-by-3 vector containing values for the Minimum, Tick Interval, and Maximum parameters, in that order. To use the **auto** value for the Tick Interval, leave the Tick Interval position in the vector empty or specify -1.

Block Parameter: Limits

Type: 1x3 vector

Default: [0 -1 100]

Tick Interval — Interval between major tick marks

auto (default) | scalar

Finite, real, positive, whole, scalar value specifying the interval of major tick marks on the scale. When set to `auto`, the block automatically adjusts the tick interval based on the values of the **Maximum** and **Minimum** parameters.

Programmatic Use

To programmatically set the `Tick Interval` parameter, use a 1-by-3 vector containing values for the `Minimum`, `Tick Interval`, and `Maximum` parameters, in that order. To use the `auto` value for the `Tick Interval`, leave the `Tick Interval` position in the vector empty or specify `-1`.

Block Parameter: Limits

Type: 1x3 vector

Default: [0 -1 100]

Scale Colors — Color indications on gauge scale

colors for scale ranges

Color specifications for value ranges on the scale. Press the **+** button to add a scale color. For each color added, specify the minimum and maximum values of the range in which you want to display that color.

Programmatic Use

To programmatically specify the `Scale Colors` parameter, use an array of structures with the fields:

- `Min` — Minimum value for the color range on the scale
- `Max` — Maximum value for the color range on the scale
- `Color` — 1-by-3 vector of double values between 0 and 1 that specify the color for the range in the form [r g b]

Include a structure in the array for each scale range for which you want to specify a color.

```
range1.Min = 0;  
range1.Max = 10;  
range1.Color = [0 0 1];  
range2.Min = 10;  
range2.Max = 15;  
range2.Color = [0 1 0];  
scaleRanges = [range1 range2];
```

Block Parameter: ScaleColors

Type: structure array

Default: 0x1 struct array

Lock Aspect Ratio — Whether to maintain block aspect ratio

on (default) | off

Whether to maintain the block aspect ratio when resizing the block and when you specify a new background image.

Label — Block label position

Top (default) | Bottom | Hide

Position of the block label. When the block is connected to an element in the model, the label is the name of the connected element.

Programmatic Use**Block Parameter:** LabelPosition**Type:** character vector**Values:** 'Top' | 'Bottom' | 'Hide'**Default:** 'Top'**Opacity — Block background opacity**

1 (default) | scalar

Block background opacity, specified as a scalar value between 0 and 1. Specify the background opacity using the **Design** tab in the Property Inspector.

- 1 On the **Design** tab, click **Edit Design**.
- 2 Select the **Background** component.
- 3 In the **Background Color** section, specify the desired opacity.

Example: 0.5

Programmatic Use**Block Parameter:** Opacity**Type:** scalar**Default:** 1**Foreground Color — Block foreground color**

[r g b] vector

Block foreground color, excluding the text. The **Foreground Color** applies to the scale and the block name. To specify the color for the block text, use the **Font Color**.

Specify the **Foreground Color** for the block using the **Design** tab in the Property Inspector.

- 1 On the **Design** tab, click **Edit Design**.
- 2 Select the **Scale** component.
- 3 In the **Ticks** section, open the **Color** menu. You can choose from the palette of standard colors or specify a custom color.

Programmatic Use

Specify the `ForegroundColor` parameter for the block as a 1-by-3 [r g b] vector with values between 0 and 1.

Block Parameter: ForegroundColor**Type:** [r g b] vector**Background Color — Block background color**

[r g b] vector

Block background color. You can choose to select a solid background color instead of providing a background image. To design a block that uses a solid background, use the **Design** tab in the Property Inspector.

- 1 On the **Design** tab, click **Edit Design**.
- 2 Select the **Background** component.
- 3 Select **Use background color**.

- 4 Choose a background color from the palette of standard colors or specify a custom color.
- 5 Adjust the **Offset from scale** option until the solid background is the desired size.

Changing the background color using the toolbar removes the background image and enables the **Use background color** option.

When you use a solid background with the Circular Gauge block, you can design noncircular gauges. When the scale arc angle is 180° or smaller, the background shape conforms to the scale.

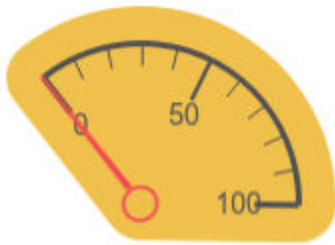

Programmatic Use

Specify the `BackgroundColor` parameter for the block as a 1-by-3 [r g b] vector with values between 0 and 1.

Block Parameter: `BackgroundColor`

Type: [r g b] vector

Font Color — Block font color

[r g b] vector

Block font color. The **Font Color** applies to the scale labels. To specify the color of the scale, use the **Foreground Color**.

Specify the **Font Color** for the block using the **Design** tab in the Property Inspector.

- 1 On the **Design** tab, click **Edit Design**.
- 2 Select the **Scale** component.
- 3 In the **Labels** section, open the **Color** menu. You can choose from the palette of standard colors or specify a custom color.

Block Characteristics

| | |
|---------------------------------|---|
| Data Types | Boolean double enumerated fixed point half integer single |
| Direct Feedthrough | no |
| Multidimensional Signals | no |
| Variable-Size Signals | no |
| Zero-Crossing Detection | no |

Extended Capabilities

C/C++ Code Generation

Generate C and C++ code using Simulink® Coder™.

Dashboard blocks are ignored for code generation.

See Also

Gauge | Half Gauge | Horizontal Gauge | Linear Gauge | Quarter Gauge | Vertical Gauge

Topics

“Tune and Visualize Your Model with Dashboard Blocks”

“Interactively Design and Debug Models Using Panels”

“Simulation Pacing”

Introduced in R2020b

Clock

Display and provide simulation time

Library: Simulink / Sources



Description

The Clock block outputs the current simulation time at each simulation step. This block is useful for other blocks that need the simulation time.

When you need the current time within a discrete system, use the Digital Clock block.

Ports

Output

Port_1 — Sample time

scalar

Sample time, specified as the current simulation time at each simulation time step.

Data Types: `double`

Parameters

Display time — Display simulation time on block icon

`off` (default) | `on`

Select this check box to display the simulation time as part of the Clock block icon. When you clear this check box, the simulation time does not appear on the block icon.

Programmatic Use

Block Parameter: `DisplayTime`

Type: character vector

Values: `'off'` | `'on'`

Default: `'off'`

Decimation — Interval at which to update block icon

`10` (default) | positive integer

Specify the interval at which Simulink updates the Clock icon as a positive integer.

Suppose that the decimation is 1000. For a fixed integration step of 1 millisecond, the Clock icon updates at 1 second, 2 seconds, and so on.

Dependencies

To display the simulation time on the block icon, you must select the **Display time** check box.

Programmatic Use**Block Parameter:** Decimation**Type:** character vector**Value:** scalar**Default:** '10'**Block Characteristics**

| | |
|---------------------------------|--------|
| Data Types | double |
| Direct Feedthrough | no |
| Multidimensional Signals | no |
| Variable-Size Signals | no |
| Zero-Crossing Detection | no |

Extended Capabilities**C/C++ Code Generation**

Generate C and C++ code using Simulink® Coder™.

Not recommended for production code. Relates to resource limits and restrictions on speed and memory often found in embedded systems. Generated code can contain dynamic allocation and freeing of memory, recursion, additional memory overhead, and widely-varying execution times. While the code is functionally valid and generally acceptable in resource-rich environments, smaller embedded targets often cannot support such code. Usually, blocks evolve toward being suitable for production code. Thus, blocks suitable for production code remain suitable.

See Also

Digital Clock

Topics

"Sample Time"

Introduced before R2006a

Combinatorial Logic

Implement truth table

Library: Simulink / Logic and Bit Operations



Description

The Combinatorial Logic block implements a standard truth table for modeling programmable logic arrays (PLAs), logic circuits, decision tables, and other Boolean expressions. You can use this block in conjunction with Memory blocks to implement finite-state machines or flip-flops.

Ports

Input

Port_1 — Input signal

vector

Input signal, specified as a vector. The type of signals accepted by a Combinatorial Logic block depends on whether you selected the Boolean logic signals option (see “Implement logic signals as Boolean data (vs. double)”). If this option is enabled, the block accepts real signals of type `Boolean` or `double`.

Data Types: `double` | `Boolean`

Output

Port_2 — Output signal

scalar | vector

Output signal, `double` if the truth table contains non-Boolean values of type `double`; `Boolean` otherwise. The type of the output is the same as that of the input except that the block outputs `double` if the input is `Boolean` and the truth table contains non-Boolean values.

Data Types: `double` | `Boolean`

Parameters

Truth table — Matrix of outputs

matrix

You specify a matrix that defines all possible block outputs as the **Truth table** parameter. Each row of the matrix contains the output for a different combination of input elements. You must specify outputs for every combination of inputs. The number of columns is the number of block outputs.

The **Truth table** parameter can have Boolean values (0 or 1) of any data type, including fixed-point data types. If the table contains non-Boolean values, the data type of the table must be `double`.

The relationship between the number of inputs and the number of rows is:

$$\text{number of rows} = 2^{(\text{number of inputs})}$$

Simulink returns a row of the matrix by computing the row's index from the input vector elements. Simulink computes the index by building a binary number where input vector elements having zero values are 0 and elements having nonzero values are 1, then adding 1 to the result. For an input vector, u , of m elements:

$$\text{row index} = 1 + u(m) \cdot 2^0 + u(m-1) \cdot 2^1 + \dots + u(1) \cdot 2^{m-1}$$

Programmatic Use

Block Parameter: TruthTable

Type: character vector

Values: matrix

Default: '[0 0;0 1;0 1;1 0;0 1;1 0;1 0;1 1]'

Block Characteristics

| | |
|---------------------------------|------------------|
| Data Types | Boolean double |
| Direct Feedthrough | yes |
| Multidimensional Signals | no |
| Variable-Size Signals | no |
| Zero-Crossing Detection | no |

Extended Capabilities

C/C++ Code Generation

Generate C and C++ code using Simulink® Coder™.

See Also

Compare To Constant | Compare To Zero | Bit Clear | Bit Set

Introduced before R2006a

Combo Box

Select parameter value from drop-down menu

Library: Simulink / Dashboard



Description

The Combo Box block lets you set the value of a parameter to one of several values. You can define each selectable value and its label through the Combo Box block parameters. Use the Combo Box block with other Dashboard blocks to build an interactive dashboard of controls and indicators for your model.

Double-clicking the Combo Box block does not open its dialog box during simulation and when the block is selected. To edit the block's parameters, you can use the **Property Inspector**, or you can right-click the block and select **Block Parameters** from the context menu.

Connect Dashboard Blocks

Dashboard blocks do not use ports to connect to model elements. To connect dashboard blocks to variables and block parameters, use connect mode. Connect mode facilitates the process of connecting dashboard blocks in your model, especially when you want to connect multiple blocks at once. To connect a single dashboard block, you can also use the **Connection** table in the block dialog box.

Tip You can modify dashboard block connections in your model during normal and accelerator mode simulations.

Note Dashboard blocks cannot connect to variables until you update the model diagram. To connect dashboard blocks to variables or modify variable values between opening your model and running a simulation, update the model diagram using **Ctrl+D**.

To enter connect mode, select the block. Then, on the block tab, click **Connect**. In connect mode, when you select one or more blocks, a list of parameters and variables available for connection appears. Select a variable or parameter from the list to connect to the selected dashboard block.

When the value of the selected variable or block parameter is nonscalar, use the text box at the bottom of the **Connection** table to specify the element you want to connect to the dashboard block. To connect to an element of a vector, matrix, or array, specify the element index, for example, 3 or (1, 3). To connect to an element in a bus or structure, specify the element in the context of the bus or structure hierarchy by using dots to indicate different levels in the hierarchy, and omit the top level. For example, specify a.b to connect to scalar element b of the structure or bus a nested inside the selected composite variable or parameter.

To connect another dashboard block, pause on another dashboard block and click the **Connect** button above it. Then, make a selection of signals and blocks in your model and choose a model element to connect.

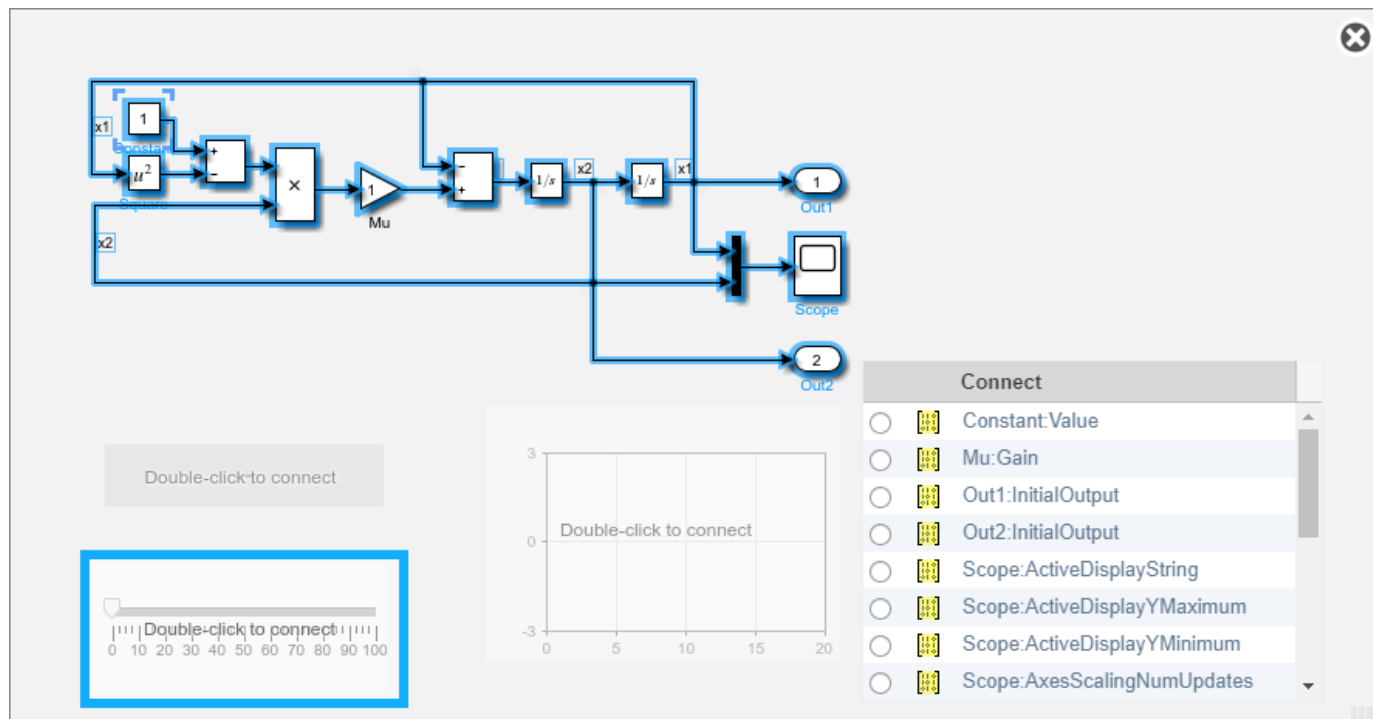

When you finish connecting the dashboard blocks in your model, on the block tab, click **Done Connecting**.

Tip You can hide the message shown on unconnected blocks using the `set_param` function with the `ShowInitialText` block parameter. The message also disappears when you connect the block.

Parameter Logging

Tunable parameters connected to dashboard blocks are logged to the Simulation Data Inspector, where you can view the parameter values along with logged signal data. You can access logged parameter data in the MATLAB workspace by exporting the parameter data from the Simulation Data Inspector by using the UI or the `Simulink.sdi.exportRun` function. For more information about exporting data using the Simulation Data Inspector UI, see “Export Data to the Workspace or a File”. The parameter data is stored in a `Simulink.SimulationData.Parameter` object, accessible as an element in the exported `Simulink.SimulationData.Dataset`.

Limitations

- Except for the Dashboard Scope block and the Display block, dashboard blocks can only connect to real scalar signals.
- The toolstrip does not support blocks that are inside a panel.
- You cannot use the **Connection** table in the block dialog to connect a dashboard block to a block that is commented out. When you connect a dashboard block to a commented block using connect

mode, the dashboard block does not display the connected value until the you uncomment the block.

- Dashboard blocks cannot connect to model elements inside referenced models.
- When you simulate a model hierarchy, dashboard blocks inside referenced models do not update.
- Dashboard blocks do not support rapid accelerator simulation.
- When you connect a dashboard block to a variable or parameter during simulation, the data for that variable or parameter is not logged to the Simulation Data Inspector. To log variable and parameter data to the Simulation Data Inspector, connect the dashboard block to the variable or parameter prior to simulation.
- When you simulate a model in external mode with the **Default parameter behavior** set to **Inlined**, dashboard blocks can appear to change parameter and variable values. However, the change does not propagate to the simulation. For example, Gain blocks display changes made to the **Gain** parameter using the dashboard blocks, but the **Gain** value used in the simulation does not change.

Parameters

Connection — Select a variable or block parameter to connect

variable and parameter connection options

Select the variable or block parameter to control using the **Connection** table. To connect the block to a signal:

- 1 Make a selection in the model that includes one or more blocks.
- 2 Select the variable or parameter you want to connect.

When the value of the selected variable or block parameter is nonscalar, use the text box at the bottom of the **Connection** table to specify the element you want to connect to the dashboard block. To connect to an element of a vector, matrix, or array, specify the element index, for example, 3 or (1, 3). To connect to an element in a bus or structure, specify the element in the context of the bus or structure hierarchy by using dots to indicate different levels in the hierarchy, and omit the top level. For example, specify a.b to connect to scalar element b of the structure or bus a nested inside the selected composite variable or parameter.

- 3 Click **Apply**.

To facilitate understanding and debugging your model, you can connect Dashboard blocks to variables and parameters in your model during simulation.

Note To see workspace variables in the connection table, update the model diagram using **Ctrl+D**.

Programmatic Use

To programmatically connect a dashboard block to a tunable parameter or a variable, use a `Simulink.HMI.ParamSourceInfo` object. The `Simulink.HMI.ParamSourceInfo` object contains four properties. Some of the properties apply to connecting dashboard blocks to parameters, and some apply to connecting dashboard blocks to variables. Not all fields have a value for a connection because a given dashboard block connects to either a parameter or a variable.

Block Parameter: Binding

Type: Simulink.HMI.ParamSourceInfo

Default: []

States — Set of states to select for connected parameter

scalar and character vector

Set of states from which to select a value for the connected parameter. Each **State** consists of a **State Value** and a **State Label**.

- **State Value** — Value assigned to the connected variable or parameter when you select the state with the corresponding **Label**.
- **State Label** — Label for each state. You can use the **Label** to display the value the connected parameter takes when the switch is positioned at the bottom, or you can enter a descriptive text label.

Click the + button to add additional **States**.

The default configuration for the block includes these **States**.

States

| State Value | State Label |
|-------------|-------------|
| 0 | Label1 |
| 1 | Label2 |
| 2 | Label3 |

Programmatic Use

To programmatically configure the **States** for a block, use an array of structures containing the fields **Value** and **Label**. Include a structure in the array for each state you want to configure on the block.

```
state1.Value = 1;
state1.Label = 'State 1';
state2.Value = 2;
state2.Label = 'State 2';
radioStates = [state1 state2];
```

Block Parameter: States

Type: structure

Default: 3x1 structure array

Enumerated Data Type — Specify state values and labels using an enumerated data type

off (default) | on

You can use an enumerated data type that pairs a numeric value with each enumeration to configure the state values and labels for the block. To specify the states for the block using an enumerated data type, first select the **Enumerated Data Type** option. Then, specify the name of the enumerated data type in the text box. The definition for the specified enumerated data type must be saved on the MATLAB path or in the base workspace.

Example: myEnumType

Programmatic Use

To programmatically specify the state labels and values for the block using an enumerated data type, specify 'on' for the UseEnumeratedDataType parameter and the name of the enumerated data type for the EnumeratedDataType parameter.

Block Parameter: UseEnumeratedDataType

Type: string or character array

Values: 'on' | 'off'

Default: 'off'

Block Parameter: EnumeratedDataType

Type: string or character array

Default: ''

Label — Block label position

Hide (default) | Bottom | Top

Position of the block label. When the block is connected to an element in the model, the label is the name of the connected element.

Programmatic Use

Block Parameter: LabelPosition

Type: character vector

Values: 'Hide' | 'Bottom' | 'Top'

Default: 'Hide'

Opacity — Block background opacity

1 (default) | scalar

Block background opacity, specified as a scalar value between 0 and 1.

Example: 0.5

Programmatic Use

Block Parameter: Opacity

Type: scalar

Default: 1

Foreground Color — Block foreground color

[r g b] vector

Block foreground color, including the text. You can select a color from a palette of standard colors or specify a custom color.

Programmatic Use

Specify the ForegroundColor parameter for the block as a 1-by-3 [r g b] vector with values between 0 and 1.

Block Parameter: ForegroundColor

Type: [r g b] vector

Background Color — Block background color

[r g b] vector

Block background color. You can select a color from a palette of standard colors or specify a custom color.

Programmatic Use

Specify the `BackgroundColor` parameter for the block as a 1-by-3 [r g b] vector with values between 0 and 1.

Block Parameter: `BackgroundColor`

Type: [r g b] vector

Block Characteristics

| | |
|---------------------------------|----------------------------------|
| Data Types | double half integer single |
| Direct Feedthrough | no |
| Multidimensional Signals | no |
| Variable-Size Signals | no |
| Zero-Crossing Detection | no |

Extended Capabilities**C/C++ Code Generation**

Generate C and C++ code using Simulink® Coder™.

Dashboard blocks are ignored for code generation.

See Also

Rotary Switch | Radio Button

Topics

“Tune and Visualize Your Model with Dashboard Blocks”

“Decide How to Visualize Simulation Data”

Introduced in R2017b

Compare To Constant

Determine how signal compares to specified constant

Library: Simulink / Logic and Bit Operations
HDL Coder / Logic and Bit Operations



Description

The Compare To Constant block compares an input signal to a constant. Specify the constant in the **Constant value** parameter. Specify how the input is compared to the constant value with the **Operator** parameter.

Ports

Input

Port_1 — Input signal

scalar

Input signal, specified as a scalar, is compared with zero. The block first converts its **Constant value** parameter to the input data type, and then performs the specified operation.

Data Types: half | single | double | int8 | int16 | int32 | int64 | uint8 | uint16 | uint32 | uint64 | Boolean | fixed point | enumerated | bus

Output

Port_1 — Output signal

0 | 1

The output is 0 if the comparison is false, and 1 if it is true.

Data Types: uint8 | Boolean

Parameters

Operator — Logical operator

<= (default) | == | ~= | < | >= | >

This parameter can have these values:

- == — Determine whether the input is equal to the specified constant.
- ~= — Determine whether the input is not equal to the specified constant.
- < — Determine whether the input is less than the specified constant.
- <= — Determine whether the input is less than or equal to the specified constant.

- > — Determine whether the input is greater than the specified constant.
- >= — Determine whether the input is greater than or equal to the specified constant.

Programmatic Use**Block Parameter:** relop**Type:** character vector**Values:** '==' | '~=' | '<' | '<=' | '>=' | '>'**Default:** '<='**Constant value — Constant to compare with**

constant

Specify the constant value to which the input is compared.

Programmatic Use**Block Parameter:** const**Type:** character vector**Value:** scalar | vector | matrix | N-D array**Default:** '3.0'**Output data type — Data type of the output**

boolean (default) | uint8

Specify the data type of the output, boolean or uint8.

Programmatic Use**Block Parameter:** OutDataTypeStr**Type:** character vector**Values:** 'boolean' | 'uint8'**Default:** 'boolean'**Enable zero-crossing detection — Select to enable zero-crossing detection**

'on' (default) | 'off'

Select to enable zero-crossing detection. For more information, see “Zero-Crossing Detection” in the Simulink documentation.

Programmatic Use**Block Parameter:** ZeroCross**Type:** character vector**Values:** 'off' | 'on'**Default:** 'on'**Block Characteristics**

| | |
|---------------------------------|---|
| Data Types | Boolean double enumerated fixed point half integer single |
| Direct Feedthrough | yes |
| Multidimensional Signals | yes |
| Variable-Size Signals | yes |

| | |
|--------------------------------|-----|
| Zero-Crossing Detection | yes |
|--------------------------------|-----|

Extended Capabilities

C/C++ Code Generation

Generate C and C++ code using Simulink® Coder™.

HDL Code Generation

Generate Verilog and VHDL code for FPGA and ASIC designs using HDL Coder™.

HDL Coder provides additional configuration options that affect HDL implementation and synthesized logic.

HDL Architecture

This block has a single, default HDL architecture.

HDL Block Properties

| | |
|----------------------------------|--|
| ConstrainedOutputPipeline | Number of registers to place at the outputs by moving existing delays within your design. Distributed pipelining does not redistribute these registers. The default is 0. For more details, see “ConstrainedOutputPipeline” (HDL Coder). |
| InputPipeline | Number of input pipeline stages to insert in the generated code. Distributed pipelining and constrained output pipelining can move these registers. The default is 0. For more details, see “InputPipeline” (HDL Coder). |
| OutputPipeline | Number of output pipeline stages to insert in the generated code. Distributed pipelining and constrained output pipelining can move these registers. The default is 0. For more details, see “OutputPipeline” (HDL Coder). |

Complex Data Support

This block supports code generation for complex signals.

PLC Code Generation

Generate Structured Text code using Simulink® PLC Coder™.

Fixed-Point Conversion

Design and simulate fixed-point systems using Fixed-Point Designer™.

See Also

Compare To Zero | Logical Operator | Combinatorial Logic

Introduced before R2006a

Compare To Zero

Determine how signal compares to zero

Library: Simulink / Logic and Bit Operations
HDL Coder / Logic and Bit Operations



Description

The Compare To Zero block compares an input signal to zero. Specify how the input is compared to zero with the **Operator** parameter.

The output is 0 if the comparison is false, and 1 if it is true.

Ports

Input

Port_1 — Input signal

scalar

Input signal, specified as scalar, is compared with zero. If the input data type cannot represent zero, parameter overflow occurs. To detect this overflow, go to the **Diagnostics > Data Validity** pane of the Configuration Parameters dialog box and set **Parameters > Detect overflow** to warning or error.

In this case, the block compares the input signal to the *ground value* of the input data type. For example, if you have an input signal of type `fixdt(0,8,2^0,10)`, the input data type can represent unsigned 8-bit integers from 10 to 265 due to a bias of 10. The ground value is 10, instead of 0.

Data Types: half | single | double | int8 | int16 | int32 | int64 | uint8 | uint16 | uint32 | uint64 | Boolean | fixed point

Output

Port_1 — Output signal

0 | 1

The output is 0 if the comparison is false, and 1 if it is true.

The block output is `uint8` or `boolean`, depending on your selection for the **Output data type** parameter.

Data Types: uint8 | Boolean

Parameters

Operator — Logical operator

`<=` (default) | `==` | `~=` | `<` | `>=` | `>`

This parameter can have the following values:

- `==` — Determine whether the input is equal to zero.
- `~=` — Determine whether the input is not equal to zero.
- `<` — Determine whether the input is less than zero.
- `<=` — Determine whether the input is less than or equal to zero.
- `>` — Determine whether the input is greater than zero.
- `>=` — Determine whether the input is greater than or equal to zero.

Programmatic Use

Block Parameter: `relop`

Type: character vector

Values: `'=='` | `'~='` | `'<'` | `'<='` | `'>='` | `'>'`

Default: `'<='`

Output data type — Data type of the output

`boolean` (default) | `uint8`

Specify the data type of the output, `boolean` or `uint8`.

Programmatic Use

Block Parameter: `OutDataTypeStr`

Type: character vector

Values: `'boolean'` | `'uint8'`

Default: `'boolean'`

Enable zero-crossing detection — Select to enable zero-crossing detection

`on` (default) | `off`

Select to enable zero-crossing detection. For more information, see “Zero-Crossing Detection” in the Simulink documentation.

Programmatic Use

Block Parameter: `ZeroCross`

Type: character vector

Values: `'off'` | `'on'`

Default: `'on'`

Block Characteristics

| | |
|---------------------------------|--|
| Data Types | <code>Boolean</code> <code>double</code> <code>fixed point</code> <code>half</code> <code>integer</code> <code>single</code> |
| Direct Feedthrough | <code>yes</code> |
| Multidimensional Signals | <code>yes</code> |
| Variable-Size Signals | <code>yes</code> |

| | |
|--------------------------------|-----|
| Zero-Crossing Detection | yes |
|--------------------------------|-----|

Extended Capabilities

C/C++ Code Generation

Generate C and C++ code using Simulink® Coder™.

HDL Code Generation

Generate Verilog and VHDL code for FPGA and ASIC designs using HDL Coder™.

HDL Coder provides additional configuration options that affect HDL implementation and synthesized logic.

HDL Architecture

This block has a single, default HDL architecture.

HDL Block Properties

| | |
|----------------------------------|--|
| ConstrainedOutputPipeline | Number of registers to place at the outputs by moving existing delays within your design. Distributed pipelining does not redistribute these registers. The default is 0. For more details, see “ConstrainedOutputPipeline” (HDL Coder). |
| InputPipeline | Number of input pipeline stages to insert in the generated code. Distributed pipelining and constrained output pipelining can move these registers. The default is 0. For more details, see “InputPipeline” (HDL Coder). |
| OutputPipeline | Number of output pipeline stages to insert in the generated code. Distributed pipelining and constrained output pipelining can move these registers. The default is 0. For more details, see “OutputPipeline” (HDL Coder). |

Complex Data Support

This block supports code generation for complex signals.

PLC Code Generation

Generate Structured Text code using Simulink® PLC Coder™.

Fixed-Point Conversion

Design and simulate fixed-point systems using Fixed-Point Designer™.

See Also

Compare To Constant | Logical Operator | Bitwise Operator | String Compare

Introduced before R2006a

Complex to Magnitude-Angle

Compute magnitude and/or phase angle of complex signal

Library: Simulink / Math Operations



Description

The Complex to Magnitude-Angle block outputs the magnitude and/or phase angle of the input signal, depending on the setting of the **Output** parameter. The outputs are real values of the same data type as the block input. The input can be an array of complex signals, in which case the output signals are also arrays. The magnitude signal array contains the magnitudes of the corresponding complex input elements. The angle output similarly contains the angles of the input elements.

Ports

Input

Port_1 — Input signal

scalar | vector | matrix

Complex input signal that the block computes and outputs the magnitude and/or the phase angle.

Data Types: single | double

Output

Port_1 — Output signal

scalar | vector | matrix

Output signal that is the magnitude and/or phase angle of the input signal. To choose the output, set the **Output** parameter.

Data Types: single | double

Parameters

Output — Magnitude and/or phase angle output specification

Magnitude and angle (default) | Magnitude | Angle

Specify if the output is the magnitude and/or the phase angle in radians of the input signal.

Command-Line Information

Parameter: Output

Type: character vector

Values: 'Magnitude and angle' | 'Magnitude' | 'Angle'

Default: 'Magnitude and angle'

Sample time — Specify sample time as a value other than -1

-1 (default) | scalar | vector

Specify the sample time as a value other than -1. For more information, see “Specify Sample Time”.

Dependencies

This parameter is not visible unless it is explicitly set to a value other than -1. To learn more, see “Blocks for Which Sample Time Is Not Recommended”.

Programmatic Use**Block Parameter:** SampleTime**Type:** character vector**Values:** scalar or vector**Default:** '-1'**Block Characteristics**

| | |
|---------------------------------|-----------------|
| Data Types | double single |
| Direct Feedthrough | yes |
| Multidimensional Signals | yes |
| Variable-Size Signals | yes |
| Zero-Crossing Detection | no |

Extended Capabilities**C/C++ Code Generation**

Generate C and C++ code using Simulink® Coder™.

See Also

Complex to Real-Imag | Real-Imag to Complex

Introduced before R2006a

Complex to Real-Imag

Output real and imaginary parts of complex input signal

Library: Simulink / Math Operations
HDL Coder / Math Operations



Description

The Complex to Real-Imag block outputs the real and/or imaginary part of the input signal, depending on the setting of the **Output** parameter. The real outputs are of the same data type as the complex input. The input can be an array (vector or matrix) of complex signals, in which case the output signals are arrays of the same dimensions. The real array contains the real parts of the corresponding complex input elements. The imaginary output similarly contains the imaginary parts of the input elements.

Ports

Input

Port_1 — Input signal

scalar | vector | matrix

Complex input signal that the block computes and outputs the real and/or imaginary part.

Data Types: single | double | int8 | int16 | int32 | int64 | uint8 | uint16 | uint32 | uint64 | Boolean | fixed point

Output

Port_1 — Output signal

scalar | vector | matrix

Output signal that is the real and/or imaginary part of the input signal. To choose which part is output, set the **Output** parameter.

Data Types: single | double | int8 | int16 | int32 | int64 | uint8 | uint16 | uint32 | uint64 | Boolean | fixed point

Parameters

Output — Real and/or imaginary output specification

Real and imag (default) | Real | Imag

Specify if the output is the real and/or imaginary part of the input signal.

Command-Line Information**Parameter:** Output**Type:** character vector**Values:** 'Real and imag' | 'Real' | 'Imag'**Default:** 'Real and imag'**Sample time — Specify sample time as a value other than -1**

-1 (default) | scalar | vector

Specify the sample time as a value other than -1. For more information, see “Specify Sample Time”.

Dependencies

This parameter is not visible unless it is explicitly set to a value other than -1. To learn more, see “Blocks for Which Sample Time Is Not Recommended”.

Programmatic Use**Block Parameter:** SampleTime**Type:** character vector**Values:** scalar or vector**Default:** '-1'**Block Characteristics**

| | |
|---------------------------------|---|
| Data Types | Boolean double fixed point integer single |
| Direct Feedthrough | yes |
| Multidimensional Signals | yes |
| Variable-Size Signals | yes |
| Zero-Crossing Detection | no |

Extended Capabilities**C/C++ Code Generation**

Generate C and C++ code using Simulink® Coder™.

HDL Code Generation

Generate Verilog and VHDL code for FPGA and ASIC designs using HDL Coder™.

HDL Coder provides additional configuration options that affect HDL implementation and synthesized logic.

HDL Architecture

This block has a single, default HDL architecture.

HDL Block Properties

| | |
|----------------------------------|--|
| ConstrainedOutputPipeline | Number of registers to place at the outputs by moving existing delays within your design. Distributed pipelining does not redistribute these registers. The default is 0. For more details, see “ConstrainedOutputPipeline” (HDL Coder). |
| InputPipeline | Number of input pipeline stages to insert in the generated code. Distributed pipelining and constrained output pipelining can move these registers. The default is 0. For more details, see “InputPipeline” (HDL Coder). |
| OutputPipeline | Number of output pipeline stages to insert in the generated code. Distributed pipelining and constrained output pipelining can move these registers. The default is 0. For more details, see “OutputPipeline” (HDL Coder). |

Complex Data Support

This block supports code generation for complex signals.

Fixed-Point Conversion

Design and simulate fixed-point systems using Fixed-Point Designer™.

See Also

Complex to Magnitude-Angle | Real-Imag to Complex

Introduced before R2006a

Compose String

Compose output string signal based on specified format and input signals

Library: Simulink / String

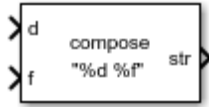

Description

The Compose String block composes output string signal based on the format specifier listed in the **Format** parameter. The **Format** parameter determines the number of input signals. If there are multiple inputs, the block constructs the string by combining these multiple inputs in order, and applying the associated format specifier, one format specifier for each input. Each format specifier starts with a percent sign, %, followed by the conversion character. For example, %f formats the input as a floating point output. To supplement the string output, you can also add a character to the format specification. Use this block to compose and format an output string signal from a multiple inputs.

For example, if the **Format** parameter contains "%s is %f", the block expects two inputs, a string signal and a single or double signal. If the first input is the string "Pi" and the second input is a double value 3.14, the output is "Pi is 3.14".

When a MinGW® compiler compiles code generated from the block, running the compiled code may produce nonstandard results for floating-point inputs. For example, a numeric input of 501.987 returns the string "5.019870e+002" instead of the expected string "5.019870e+02".

Ports

Input

d — Data for first part of string

scalar

Data for the first part of string, specified as a scalar. The **Format** parameter determines the port label and the format of the input data. For example, if the first item in the **Format** parameter is %d, the port label is d.

The data type of the input signal must be compatible with the format specifier in the **Format** parameter. For more information, see the **Format** parameter.

Data Types: single | double | int8 | int16 | int32 | uint8 | uint16 | uint32 | Boolean

f — Data for second part of string

scalar

Data for the second part of string, specified as a scalar. The **Format** parameter determines the port label and the format of the input data. For example, if the first item in the **Format** parameter is %f, the port label is f.

The data type of the input signal must be compatible with the format specifier specified in the **Format** parameter. For more information, see the **Format** parameter.

Data Types: `single` | `double` | `int8` | `int16` | `int32` | `uint8` | `uint16` | `uint32` | `Boolean` | `fixed point` | `enumerated` | `bus`

Port_N — Data for N parts of string

`scalar` (default)

Data for N parts of string, specified as a scalar. The **Format** parameter determines the port label and the format of the input data. For example, if the corresponding item in the **Format** parameter is `%f`, the port label is `f`.

The data type of the input signal must be compatible with the format specifier in the **Format** parameter. For more information, see the **Format** parameter.

Data Types: `single` | `double` | `int8` | `int16` | `int32` | `uint8` | `uint16` | `uint32` | `Boolean` | `fixed point` | `enumerated` | `bus`

Output

str — Output string

`scalar`

Output string composed of inputs, specified as a scalar.

Data Types: `string`

Parameters

Format — Format input data

`"%d %f"` (default) | `scalar`

Format of input data, specified as a scalar.

For more information about acceptable format specifiers, see the Algorithms section.

Output data type — Output data type

`string` (default) | `<data type expression>` | `scalar`

Output data type, specified using the string data type to specify a string with no maximum length.

To specify a string data type with a maximum length, specify `stringtype(N)`. For example, `stringtype(31)` creates a string data type with a maximum length of 31 characters.

Click the **Show data type assistant** button  to display the **Data Type Assistant**, which helps you set the data type attributes. See “Specify Data Types Using Data Type Assistant” in the *Simulink User's Guide* for more information.

Block Characteristics

| | |
|---------------------------------|--|
| Data Types | <code>double</code> <code>integer</code> <code>single</code> <code>string</code> |
| Direct Feedthrough | <code>yes</code> |
| Multidimensional Signals | <code>no</code> |

| | |
|--------------------------------|----|
| Variable-Size Signals | no |
| Zero-Crossing Detection | no |

Algorithms

A formatting specifier starts with a percent sign, %, and ends with a conversion character. The conversion character is required. Optionally, you can specify identifier, flags, field width, precision, and subtype specifiers between % and the conversion character. (Spaces are invalid between specifiers and are shown here only for readability).

The Compose String block uses this format specifier prototype:

```
%[flags][width][.precision][length]specifier
```

Conversion Character

This table shows conversion characters to format numeric and character data as text.

| Value Type | Conversion | Details |
|-----------------------|------------|---|
| Integer, signed | %d or %i | Base 10 |
| Integer, unsigned | %u | Base 10 |
| | %o | Base 8 (octal) |
| | %x | Base 16 (hexadecimal), lowercase letters a-f |
| | %X | Same as %x, uppercase letters A-F |
| Floating-point number | %f | Floating-point notation (Use a precision operator to specify the number of digits after the decimal point.) |
| | %e | Exponential notation, such as 3.141593e+00 (Use a precision operator to specify the number of digits after the decimal point.) |
| | %E | Same as %e, but uppercase, such as 3.141593E+00 (Use a precision operator to specify the number of digits after the decimal point.) |
| | %g | The more compact of %e or %f, with no trailing zeros (Use a precision operator to specify the number of significant digits.) |
| | %G | The more compact of %E or %f, with no trailing zeros (Use a precision operator to specify the number of significant digits.) |
| String | %s | The type of the output text is the same as the type of Format . |

Optional Operators

The optional identifier, flags, field width, precision, and operators further define the format of the output text.

- **Flags**

| | |
|-----|---|
| '-' | Left-justify. Works with all specifiers. Example: %-5.2f Example: %-10s |
| '+' | Always print a sign character (+ or -) for any numeric value. Works with all specifiers except u, o, x, X, and s. Example: %+5.2f Right-justify text. Example: %+10s |
| ' ' | Insert a space before the value. Works with all specifiers except u, o, x, X, and s. Example: % 5.2f |
| '0' | Pad to field width with zeros before the value. Works with all specifiers except s. Example: %05.2f |
| '#' | Modify selected numeric conversions: <ul style="list-style-type: none"> • For %o, %x, or %X, print 0, 0x, or 0X prefix. • For %f, %e, or %E, print decimal point even when precision is 0. • For %g or %G, do not remove trailing zeros or decimal point. Works with all specifiers except d, i, u, and s. Example: %#5.0f |

- **Field Width**

Minimum number of characters to print.

The function pads to field width with spaces before the value unless otherwise specified by flags.

- **Precision**

| | |
|-------------------|--|
| For %f, %e, or %E | Number of digits to the right of the decimal point Example: "%.4f" prints pi as '3.1416' |
| d, i, o, u, x, X | Minimum number of digits to be written. Outputs shorter than the specified precision are padded with leading zeros. Example: "%.4d" prints 5 as '0005' |
| For %g or %G | Number of significant digits Example: "%.4g" prints pi as '3.142' |
| s | Maximum number of characters to be written to the output. Example: "%.2s" prints "Hello!" as "He" |

Note If you specify a precision operator for floating-point values that exceeds the precision of the input numeric data type, the results might not match the input values to the precision you specified. The result depends on your computer hardware and operating system.

Text Before or After Formatting Operators

| Special Character | Representation |
|--|--|
| Single quotation mark | ' ' |
| Percent character | %% |
| Backslash | \\ |
| Alarm | \a |
| Backspace | \b |
| Form feed | \f |
| New line | \n |
| Carriage return | \r |
| Horizontal tab | \t |
| Vertical tab | \v |
| Character whose Unicode® numeric value can be represented by the hexadecimal number, N | \xN Example: <code>printf('\x5A')</code> returns 'Z' |
| Character whose Unicode numeric value can be represented by the octal number, N | \N Example: <code>printf('\132')</code> returns 'Z' |

Format can also include additional text before a percent sign, %, or after a conversion character. The text can be:

- Ordinary text to print.
- Special characters that you cannot enter as ordinary text. This table shows how to represent special characters in `formatSpec`.

Length Specifiers

The Format String block supports the `h` and `l` length subspecifiers. These specifiers can change according to the **Configuration Parameters > Hardware Implementation > Number of bits** settings

| Length | d i | u o x X | f e E g G | s |
|---------------------|-------|----------------|-----------------------------|--------|
| No length specifier | int | unsigned int | double (default), single | string |
| h | short | unsigned short | — | — |
| l | long | unsigned long | — | — |

Note for Specifiers that Specify Integer Data Types (d, i, u, o, x, X)

Target `int`, `long`, and `short` type sizes are controlled by settings in the **Configuration Parameters > Hardware Implementation** pane. For example, if the target `int` is 32 bits and the specifier is `%u`, then the expected input type will be `uint32`. However, the input port accepts any built-in integer type of that size or smaller with the `%u` specifier

Notes for Specifiers that Specify Floating Point Data Types (f, e, E, g, F)

- Do not use `l` and `h` with these specifiers. Do not use the length subspecifier (for example, `%f` is allowed, but `%hf` and `%lf` are not allowed).
- Ports that correspond with these specifiers accept both single and double data types.

Note for Specifiers that Specify the String Data Type (s)

- The `s` specifier does not work with the `l` or `h` subspecifiers, and only accepts a string input data type.

Extended Capabilities**C/C++ Code Generation**

Generate C and C++ code using Simulink® Coder™.

See Also

[sprintf](#) | [ASCII to String](#) | [Scan String](#) | [String Compare](#) | [String Concatenate](#) | [String Constant](#) | [String Find](#) | [String Length](#) | [String to Double](#) | [String to Single](#) | [String to ASCII](#) | [String to Enum](#) | [Substring](#) | [To String](#)

Topics

[“Display and Extract Coordinate Data”](#)

[“Simulink Strings”](#)

Introduced in R2018a

Configurable Subsystem

Represent any block selected from user-specified library of blocks

Library: Simulink / Ports & Subsystems



Description

Note Configurable Subsystem block will be removed in a future release. It is recommended to use Variant Subsystem instead of Configurable Subsystem. Variant Subsystems offer more capabilities than Configurable Subsystems with these advantages:

- You can mix Model blocks and Subsystem blocks as variant choices.
- You can specify variants that have different numbers of input and output ports.

For more information on converting Configurable Subsystem block to a Variant Subsystem block, see “Convert Configurable Subsystem to Variant Subsystem”.

For more information on Variant Subsystem, see Variant Subsystem, Variant Model.

If your model contains a Configurable Subsystem block, you will see a warning message. To change the warning message to an error message set the string command line parameter `ConfigurableSubsystemUsage` to `error`.

```
set_param(bdroot, 'ConfigurableSubsystemUsage', 'error');
```

To revert it to a warning, set the `ConfigurableSubsystemUsage` to `warning`.

The Configurable Subsystem block represents one of a set of blocks contained in a specified library of blocks. The context menu of the Configurable Subsystem block lets you choose which block the configurable subsystem represents.

Configurable Subsystem blocks simplify creation of models that represent families of designs. For example, suppose that you want to model an automobile that offers a choice of engines. To model such a design, you would first create a library of models of the engine types available with the car. You would then use a Configurable Subsystem block in your car model to represent the choice of engines. To model a particular variant of the basic car design, a user need only choose the engine type, using the configurable engine block's dialog box.

To create a configurable subsystem in a model, you must first create a library containing a master configurable subsystem and the blocks that it represents. You can then create configurable instances of the master subsystem by dragging copies of the master subsystem from the library and dropping them into models.

You can add any type of block to a master configurable subsystem library. Simulink derives the port names for the configurable subsystem by making a unique list from the port names of all the choices. However, Simulink uses default port names for non-subsystem block choices.

You cannot break library links in a configurable subsystem because Simulink uses those links to reconfigure the subsystem when you choose a new configuration. Breaking links would be useful only if you do not intend to reconfigure the subsystem. In this case, you can replace the configurable subsystem with a nonconfigurable subsystem that implements the permanent configuration.

Creating a Master Configurable Subsystem

To create a master configurable subsystem:

- 1 Create a library of blocks representing the various configurations of the configurable subsystem.
- 2 Save the library.
- 3 Create an instance of the Configurable Subsystem block in the library.

To do so, drag a copy of the Configurable Subsystem block from the Simulink Ports & Subsystems library into the library you created in the previous step.

- 4 Display the Configurable Subsystem block dialog box by double-clicking it. The dialog box displays a list of the other blocks in the library.
- 5 Under **List of block choices** in the dialog box, select the blocks that represent the various configurations of the configurable subsystems you are creating.
- 6 To apply the changes and close the dialog box, click the **OK** button.
- 7 Select **Block Choice** from the context menu of the Configurable Subsystem block.

The context menu displays a submenu listing the blocks that the subsystem can represent.

- 8 Select the block that you want the subsystem to represent by default.
- 9 Save the library.

Note If you add or remove blocks from a library, you must recreate any Configurable Subsystem blocks that use the library.

If you modify a library block that is the default block choice for a configurable subsystem, the change does not immediately propagate to the configurable subsystem. To propagate this change, do one of the following:

- Change the default block choice to another block in the subsystem, then change the default block choice back to the original block.
- Recreate the configurable subsystem block, including the selection of the updated block as the default block choice.

If a configurable subsystem in your model contains a broken link to a library block, editing the link and saving the model does not fix the broken link the next time you open the model. To fix a broken library link in your configurable subsystem, use one of the following approaches.

- Convert the configurable subsystem to a variant subsystem. Right-click the configurable subsystem, and select **Subsystem and Model Reference > Convert Subsystem to > Variant Subsystem**.
- Remove the library block from the master configurable subsystem library, add the library block back to the master configurable subsystem library, and then resave the master configurable subsystem library.

Creating an Instance of a Configurable Subsystem

To create an instance of a configurable subsystem in a model:

- 1 Open the library containing the master configurable subsystem.
- 2 Drag a copy of the master into the model.
- 3 Select **Block Choice** from the context menu of that Configurable Subsystem instance.
- 4 Select the block that you want the configurable subsystem to represent.

The instance of the configurable system displays the icon and parameter dialog box of the block that it represents.

Setting Instance Block Parameters

As with other blocks, you can use the parameter dialog box of a configurable subsystem instance to set its parameters interactively and the `set_param` command to set the parameters from the MATLAB command line or in a MATLAB file. If you use `set_param`, you must specify the full path name of the configurable subsystem's current block choice as the first argument of `set_param`, for example:

```
curr_choice = get_param('mymod/myconfigsys', 'BlockChoice');
curr_choice = ['mymod/myconfigsys/' curr_choice];
set_param(curr_choice, 'MaskValues', ...);
```

Mapping I/O Ports

A configurable subsystem displays a set of input and output ports corresponding to input and output ports in the selected library. Simulink uses the following rules to map library ports to Configurable Subsystem block ports:

- Map each uniquely named input/output port in the library to a separate input/output port of the same name on the Configurable Subsystem block.
- Map all identically named input/output ports in the library to the same input/output ports on the Configurable Subsystem block.
- Terminate any input/output port not used by the currently selected library block with a Terminator/Ground block.

This mapping allows a user to change the library block represented by a Configurable Subsystem block without having to rewire connections to the Configurable Subsystem block.

For example, suppose that a library contains two blocks A and B and that block A has input ports labeled a, b, and c and an output port labeled d and that block B has input ports labeled a and b and an output port labeled e.

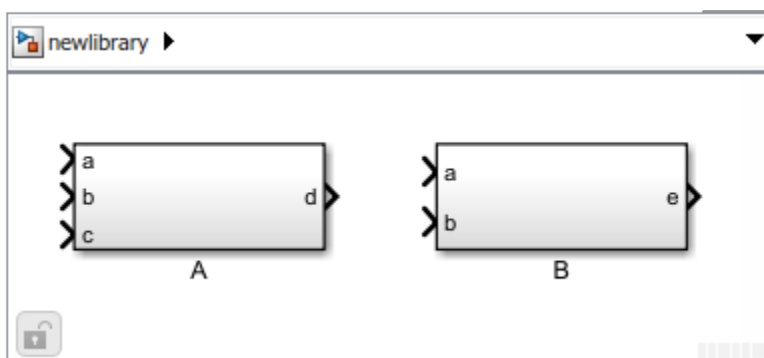

A Configurable Subsystem block based on this library would have three input ports labeled a, b, and c, respectively, and two output ports labeled d and e.

In this example, port a on the Configurable Subsystem block connects to port a of the selected library block no matter which block is selected. Port c on the Configurable Subsystem block functions only if library block A is selected. Otherwise, it simply terminates.

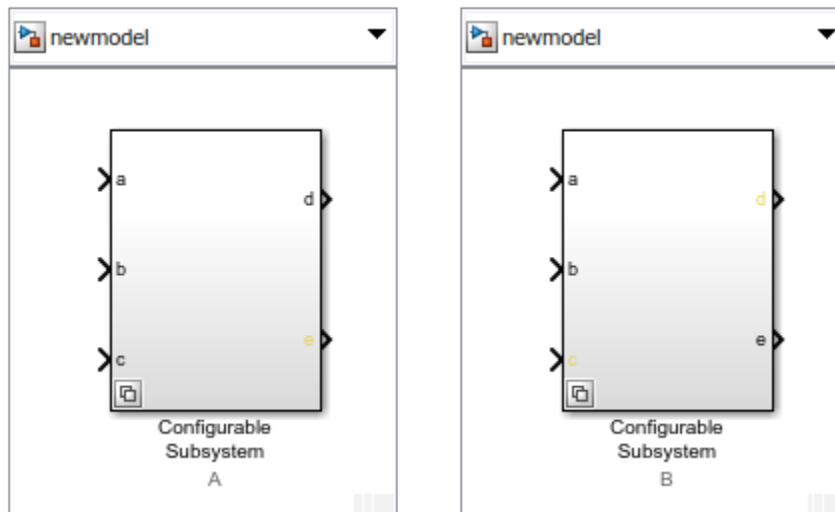

Note A Configurable Subsystem block does not provide ports that correspond to non-I/O ports, such as the trigger and enable ports on triggered and enabled subsystems. Thus, you cannot use a Configurable Subsystem block directly to represent blocks that have such ports. You can do so indirectly, however, by wrapping such blocks in subsystem blocks that have input or output ports connected to the non-I/O ports.

Convert to Variant Subsystem

Right-click a configurable subsystem and select **Subsystems and Model Reference > Convert Subsystem To > Variant Subsystem**.

During conversion, Simulink performs the following operations:

- Replaces the Subsystem block with a Variant Subsystem block, preserving ports and connections.
- Adds the original subsystem as a variant choice in the Variant Subsystem block.
- Overrides the Variant Subsystem block to use the subsystem that was originally the active choice.
- Preserves links to libraries. For linked subsystems, Simulink adds the linked subsystem as a variant choice.

Simulink also preserves the subsystem block masks, and it copies the masks to the variant choice.

See Variant Subsystem for more information on variant choices.

Ports

Input

Port_1 – Input signal

scalar | vector | matrix | N-D array | bus

Input signal to the Configurable Subsystem. The block that the Configurable Subsystem represents determines the supported data types and dimensions of the input signal.

Dependencies

The number of input ports depends on the blocks in the library that the Configurable Subsystem represents. For more information, see “Mapping I/O Ports” on page 1-179.

Data Types: half | single | double | int8 | int16 | int32 | int64 | uint8 | uint16 | uint32 | uint64 | Boolean | fixed point | enumerated | bus

Output

Port_1 – Output signal

scalar | vector | matrix | N-D array | bus

Output signal from the Configurable Subsystem. The block that the Configurable Subsystem represents determines the output data types and dimensions.

Dependencies

The number of output ports depends on the blocks in the library that the Configurable Subsystem represents. For more information, see “Mapping I/O Ports” on page 1-179.

Data Types: half | single | double | int8 | int16 | int32 | int64 | uint8 | uint16 | uint32 | uint64 | Boolean | fixed point | enumerated | bus

Parameters

List of block choices – Block members of the configurable subsystem

no default

Select the blocks you want to include as members of the configurable subsystem. You can include user-defined subsystems as blocks.

Programmatic Use

Block Parameter: MemberBlocks

Type: cell array of character vectors

Values: cell array of block names as character vectors

Default: { ' ' }

Port names – Port names

no default

Lists of input and output ports of member blocks. In the case of multiports, you can rearrange selected port positions by clicking the **Up** and **Down** buttons.

Block Characteristics

| | |
|---------------------------------|---|
| Data Types | Boolean ^a bus ^a double ^a enumerated ^a fixed point ^a half ^a integer ^a single ^a string ^a |
| Direct Feedthrough | no |
| Multidimensional Signals | limited ^a |
| Variable-Size Signals | limited ^a |
| Zero-Crossing Detection | no |

a. Actual data type or capability support depends on block implementation.

Extended Capabilities

C/C++ Code Generation

Generate C and C++ code using Simulink® Coder™.

Actual code generation support depends on block implementation.

HDL Code Generation

Generate Verilog and VHDL code for FPGA and ASIC designs using HDL Coder™.

Actual code generation support depends on block implementation.

Fixed-Point Conversion

Design and simulate fixed-point systems using Fixed-Point Designer™.

Actual data type support depends on block implementation.

See Also

Subsystem, Atomic Subsystem, Nonvirtual Subsystem, CodeReuse Subsystem | Variant Subsystem

Topics

“Model Discretizer”

Introduced before R2006a

Constant

Generate constant value

Library: Simulink / Commonly Used Blocks
 Simulink / Sources
 DSP System Toolbox / Sources
 HDL Coder / Commonly Used Blocks
 HDL Coder / Sources



Description

The Constant block generates a real or complex constant value signal. Use this block to provide a constant signal input. The block generates scalar, vector, or matrix output, depending on:

- The dimensionality of the **Constant value** parameter
- The setting of the **Interpret vector parameters as 1-D** parameter

The output of the block has the same dimensions and elements as the **Constant value** parameter. If you specify for this parameter a vector that you want the block to interpret as a vector, select the **Interpret vector parameters as 1-D** check box. Otherwise, if you specify a vector for the **Constant value** parameter, the block treats that vector as a matrix.

Tip To output a constant enumerated value, consider using the Enumerated Constant block instead. The Constant block provides block parameters that do not apply to enumerated types, such as **Output minimum** and **Output maximum**.

Using Bus Objects as the Output Data Type

The Constant block supports nonvirtual buses as the output data type. Using a bus object as the output data type can help simplify your model. If you use a bus object as the output data type, set the **Constant value** to \emptyset or to a MATLAB structure that matches the bus object.

Using Structures for the Constant Value of a Bus

The structure you specify must contain a value for every element of the bus represented by the bus object. The block output is a nonvirtual bus signal.

You can use the `Simulink.Bus.createMATLABStruct` to create a full structure that corresponds to a bus.

You can use `Simulink.Bus.createObject` to create a bus object from a MATLAB structure.

If the signal elements in the output bus use numeric data types other than `double`, you can specify the structure fields by using typed expressions such as `uint16(37)` or untyped expressions such as

37. To control the field data types, you can use the bus object as the data type of a `Simulink.Parameter` object. To decide whether to use typed or untyped expressions, see “Control Data Types of Initial Condition Structure Fields”.

Setting Configuration Parameters to Support Using a Bus Object Data Type

To enable the use of a bus object as an output data type, before you start a simulation, set **Configuration Parameters > Diagnostics > Data Validity > Advanced parameters > Underspecified initialization detection** to Simplified. For more information, see “Underspecified initialization detection”.

Ports

Output

Port_1 — Constant value

scalar | vector | matrix | N-D array

Constant value, specified as a real or complex valued scalar, vector, matrix, or N-D array. By default, the Constant block outputs a signal whose dimensions, data type, and complexity are the same as those of the **Constant value** parameter. However, you can specify the output to be any data type that Simulink supports, including fixed-point and enumerated data types.

Note If you specify a bus object as the data type for this block, do not set the maximum value for bus data on the block. Simulink ignores this setting. Instead, set the maximum values for bus elements of the bus object specified as the data type. For more information, see `Simulink.BusElement`.

Data Types: single | double | half | int8 | int16 | int32 | int64 | uint8 | uint16 | uint32 | uint64 | Boolean | fixed point | enumerated | bus

Parameters

Main

Constant value — Constant output value

1 (default) | scalar | vector | matrix | N-D array

Specify the constant value output of the block.

- You can enter any expression that MATLAB evaluates as a matrix, including the Boolean keywords `true` and `false`.
- If you set the **Output data type** to be a bus object, you can specify one of these options:
 - A full MATLAB structure corresponding to the bus object
 - `0` to indicate a structure corresponding to the ground value of the bus object

For details, see “Using Bus Objects as the Output Data Type” on page 1-183.

- For nonbus data types, Simulink converts this parameter from its value data type to the specified output data type offline, using a rounding method of nearest and overflow action of saturate.

Programmatic Use**Block Parameter:** Value**Type:** character vector**Value:** scalar | vector | matrix | N-D array**Default:** '1'**Interpret vector parameters as 1-D — Treat vectors as 1-D**

on (default) | off

Select this check box to output a vector of length N if the **Constant value** parameter evaluates to an N-element row or column vector.

- When you select this check box, the block outputs a vector of length N if the **Constant value** parameter evaluates to an N-element row or column vector. For example, the block outputs a matrix of dimension 1-by-N or N-by-1.
- When you clear this check box, the block does not output a vector of length N if the **Constant value** parameter evaluates to an N-element row or column vector.

Programmatic Use**Block Parameter:** VectorParams1D**Type:** character vector**Values:** 'on' | 'off'**Default:** 'on'**Sample time — Sampling interval**

inf (default) | scalar | vector

Specify the interval between times that the Constant block output can change during simulation (for example, due to tuning the **Constant value** parameter).

The default value of `inf` indicates that the block output can never change. This setting speeds simulation and generated code by avoiding the need to recompute the block output.

See “Specify Sample Time” for more information.

Programmatic Use**Block Parameter:** SampleTime**Type:** character vector**Values:** scalar | vector**Default:** 'inf'**Signal Attributes****Output minimum — Minimum output value for range checking**

[] (default) | scalar

Specify the lower value of the output range that Simulink checks as a finite, real, double, scalar value.

Note If you specify a bus object as the data type for this block, do not set the minimum value for bus data on the block. Simulink ignores this setting. Instead, set the minimum values for bus elements of the bus object specified as the data type. For information on the Minimum parameter for a bus element, see `Simulink.BusElement`.

Simulink uses the minimum to perform:

- Parameter range checking (see “Specify Minimum and Maximum Values for Block Parameters”) for some blocks.
- Simulation range checking (see “Specify Signal Ranges” and “Enable Simulation Range Checking”).
- Automatic scaling of fixed-point data types.
- Optimization of the code that you generate from the model. This optimization can remove algorithmic code and affect the results of some simulation modes such as SIL or external mode. For more information, see “Optimize using the specified minimum and maximum values” (Embedded Coder).

Note Output minimum does not saturate or clip the actual output signal. Use the Saturation block instead.

Programmatic Use

Block Parameter: OutMin

Type: character vector

Values: scalar

Default: '[]'

Output maximum — Maximum output value for range checking

[] (default) | scalar

Specify the upper value of the output range that Simulink checks as a finite, real, double, scalar value.

Note If you specify a bus object as the data type for this block, do not set the maximum value for bus data on the block. Simulink ignores this setting. Instead, set the maximum values for bus elements of the bus object specified as the data type. For information on the Maximum parameter for a bus element, see `Simulink.BusElement`.

Simulink uses the maximum value to perform:

- Parameter range checking (see “Specify Minimum and Maximum Values for Block Parameters”) for some blocks.
- Simulation range checking (see “Specify Signal Ranges” and “Enable Simulation Range Checking”).
- Automatic scaling of fixed-point data types.
- Optimization of the code that you generate from the model. This optimization can remove algorithmic code and affect the results of some simulation modes such as SIL or external mode. For more information, see “Optimize using the specified minimum and maximum values” (Embedded Coder).

Note Output maximum does not saturate or clip the actual output signal. Use the Saturation block instead.

Programmatic Use**Block Parameter:** OutMax**Type:** character vector**Values:** scalar**Default:** '[]'**Output data type — Output data type**

Inherit: Inherit from 'Constant value' (default) | Inherit: Inherit via back propagation | double | single | half | int8 | int16 | int32 | int64 | uint8 | uint16 | uint32 | uint64 | boolean | fixdt(1,16) | fixdt(1,16,0) | fixdt(1,16,2^0,0) | Enum: <class name> | Bus: <object name> | <data type expression>

Specify the output data type. The type can be inherited, specified directly, or expressed as a data type object such as Simulink.NumericType.

Click the **Show data type assistant** button  to display the **Data Type Assistant**, which helps you set the data type attributes. For more information, see “Specify Data Types Using Data Type Assistant”.

Programmatic Use**Block Parameter:** OutDataTypeStr**Type:** character vector

Values: 'Inherit: Inherit from 'Constant value'' | 'Inherit: Inherit via back propagation' | 'double' | 'single' | 'half' | 'int8' | 'uint8' | 'int16' | 'uint16' | 'int32' | 'uint32' | 'int64' | 'uint64' | 'boolean' | 'fixdt(1,16)' | 'fixdt(1,16,0)' | 'fixdt(1,16,2^0,0)' | 'Enum: <class name>' | 'Bus: <object name>'

Default: 'Inherit: Inherit from 'Constant value''**Lock output data type setting against changes by the fixed-point tools — Prevent fixed-point tools from overriding Output data type**

off (default) | on

Select this parameter to prevent the fixed-point tools from overriding the **Output** data type you specify on the block. For more information, see “Use Lock Output Data Type Setting” (Fixed-Point Designer).

Programmatic Use**Block Parameter:** LockScale**Type:** character vector**Values:** 'off' | 'on'**Default:** 'off'**Block Characteristics**

| | |
|---------------------------------|---|
| Data Types | Boolean bus double enumerated fixed point half integer single |
| Direct Feedthrough | no |
| Multidimensional Signals | yes |
| Variable-Size Signals | no |

| | |
|--------------------------------|----|
| Zero-Crossing Detection | no |
|--------------------------------|----|

Extended Capabilities

C/C++ Code Generation

Generate C and C++ code using Simulink® Coder™.

HDL Code Generation

Generate Verilog and VHDL code for FPGA and ASIC designs using HDL Coder™.

HDL Coder provides additional configuration options that affect HDL implementation and synthesized logic.

Tunable Parameters

You can use a tunable parameter in a Constant block intended for HDL code generation. For details, see “Generate DUT Ports for Tunable Parameters” (HDL Coder).

HDL Architecture

| Architecture | Parameters | Description |
|------------------|----------------|--|
| default Constant | None | This implementation emits the value of the Constant block. |
| Logic Value | None | By default, this implementation emits the character 'Z' for each bit in the signal. For example, for a 4-bit signal, the implementation would emit 'ZZZZ'. |
| | {'Value', 'Z'} | If the signal is in a high-impedance state, use this parameter value. This implementation emits the character 'Z' for each bit in the signal. For example, for a 4-bit signal, the implementation would emit 'ZZZZ'. |
| | {'Value', 'X'} | If the signal is in an unknown state, use this parameter value. This implementation emits the character 'X' for each bit in the signal. For example, for a 4-bit signal, the implementation would emit 'XXXX'. |

HDL Block Properties

| | |
|----------------------------------|--|
| ConstrainedOutputPipeline | Number of registers to place at the outputs by moving existing delays within your design. Distributed pipelining does not redistribute these registers. The default is 0. For more details, see “ConstrainedOutputPipeline” (HDL Coder). |
| InputPipeline | Number of input pipeline stages to insert in the generated code. Distributed pipelining and constrained output pipelining can move these registers. The default is 0. For more details, see “InputPipeline” (HDL Coder). |

| | |
|-----------------------|--|
| OutputPipeline | Number of output pipeline stages to insert in the generated code. Distributed pipelining and constrained output pipelining can move these registers. The default is 0. For more details, see “OutputPipeline” (HDL Coder). |
|-----------------------|--|

Complex Data Support

This block supports code generation for complex signals.

Restrictions

- The `Logic Value` implementation does not support the `double` data type. If you specify this implementation for a constant value of type `double`, a code generation error occurs.
- For **Sample time**, enter -1. Delay balancing does not support an `inf` sample time.

PLC Code Generation

Generate Structured Text code using Simulink® PLC Coder™.

Fixed-Point Conversion

Design and simulate fixed-point systems using Fixed-Point Designer™.

See Also

Enumerated Constant | `Simulink.Parameter` | `Simulink.BusElement`

Topics

“Set Block Parameter Values”

“Specify Bus Properties with `Simulink.Bus` Object Data Types”

“Specify Initial Conditions for Bus Elements”

“Create Array of Buses from MATLAB Structures”

Introduced before R2006a

Coulomb and Viscous Friction

Model discontinuity at zero, with linear gain elsewhere

Library: Simulink / Discontinuities
HDL Coder / Discontinuities



Description

The Coulomb and Viscous Friction block models Coulomb (static) and viscous (dynamic) friction. The block models a discontinuity at zero and a linear gain otherwise.

The block output matches the MATLAB result for:

$$y = \text{sign}(x) .* (\text{Gain} .* \text{abs}(x) + \text{Offset})$$

where y is the output, x is the input, Gain is the signal gain for nonzero input values, and Offset is the Coulomb friction.

The block accepts one input and generates one output. The input can be a scalar, vector, or matrix with real and complex elements.

- For a scalar input, Gain and Offset can have dimensions that differ from the input. The output is a scalar, vector, or matrix depending on the dimensions of Gain and Offset .
- For a vector or matrix input, Gain and Offset must be scalar or have the same dimensions as the input. The output is a vector or matrix of the same dimensions as the input.

Ports

Input

Port_1 — Input signal

scalar | vector | matrix

The input signal to the model of Coulomb and viscous friction.

Data Types: single | double | int8 | int16 | int32 | int64 | uint8 | uint16 | uint32 | uint64 | fixed point

Output

Port_1 — Output signal

scalar | vector | matrix

The output signal calculated by applying the friction models to the input.

Data Types: single | double | int8 | int16 | int32 | int64 | uint8 | uint16 | uint32 | uint64 | fixed point

Parameters

To edit the parameters for the Coulomb and Viscous Friction block, double-click the block icon.

Coulomb friction value — Static friction offset

[1320] (default) | real values

Specify the offset that applies to all input values.

Programmatic Use

Block Parameter: offset

Type: character vector

Value: real values

Default: '[1 3 2 0]'

Coefficient of viscous friction — Dynamic friction coefficient

1 (default) | real values

Specify the signal gain for nonzero input values.

Programmatic Use

Block Parameter: gain

Type: character vector

Value: real values

Default: '1'

Block Characteristics

| | |
|---------------------------------|---|
| Data Types | double fixed point integer single |
| Direct Feedthrough | no |
| Multidimensional Signals | no |
| Variable-Size Signals | no |
| Zero-Crossing Detection | no |

Extended Capabilities

C/C++ Code Generation

Generate C and C++ code using Simulink® Coder™.

HDL Code Generation

Generate Verilog and VHDL code for FPGA and ASIC designs using HDL Coder™.

HDL Coder provides additional configuration options that affect HDL implementation and synthesized logic.

HDL Architecture

This block has a single, default HDL architecture.

HDL Block Properties

| | |
|----------------------------------|--|
| ConstrainedOutputPipeline | Number of registers to place at the outputs by moving existing delays within your design. Distributed pipelining does not redistribute these registers. The default is 0. For more details, see “ConstrainedOutputPipeline” (HDL Coder). |
| InputPipeline | Number of input pipeline stages to insert in the generated code. Distributed pipelining and constrained output pipelining can move these registers. The default is 0. For more details, see “InputPipeline” (HDL Coder). |
| OutputPipeline | Number of output pipeline stages to insert in the generated code. Distributed pipelining and constrained output pipelining can move these registers. The default is 0. For more details, see “OutputPipeline” (HDL Coder). |

Restrictions

HDL code generation does not support complex input.

PLC Code Generation

Generate Structured Text code using Simulink® PLC Coder™.

Fixed-Point Conversion

Design and simulate fixed-point systems using Fixed-Point Designer™.

See Also

Dead Zone | Backlash

Introduced before R2006a

Counter Free-Running

Count up and overflow back to zero after reaching maximum value for specified number of bits

Library: Simulink / Sources
HDL Coder / Sources



Description

The Counter Free-Running block counts up until reaching the maximum value, $2^{Nbits} - 1$, where $Nbits$ is the number of bits. Then the counter overflows to zero and begins counting up again.

After overflow, the counter always initializes to zero. However, if you select the global doubles override, the Counter Free-Running block does not wrap back to zero.

Note This block does not report wrap on overflow warnings during simulation. To report these warnings, see the `Simulink.restoreDiagnostic` reference page. The block does report errors due to wrap on overflow.

Ports

Output

Port_1 — Count value

scalar

Count value, specified as an unsigned integer of 8 bits, 16 bits, or 32 bits.

Data Types: `uint8` | `uint16` | `uint32`

Parameters

Number of Bits — Number of bits

16 (default) | scalar

Specify the number of bits as a finite, real-valued. When you specify:

- A positive integer, for example 8, the block counts up to $2^8 - 1$, which is 255.
- An unsigned integer expression, for example `uint8(8)`, the block counts up to `uint8(2uint8(8) - 1)`, which is 254.

Programmatic Use

Block Parameter: NumBits

Type: character vector

Values: scalar

Default: '16'

Sample time — Interval between samples

-1 (default) | scalar | vector

Specify the time interval between samples as a scalar (sampling period), or a two-element vector ([sampling period, initial offset]). To inherit the sample time, set this parameter to -1. For more information, see “Specify Sample Time”.

Programmatic Use

Block Parameter: tsamp

Type: character vector

Values: scalar | vector

Default: '-1'

Block Characteristics

| | |
|---------------------------------|-----------------------|
| Data Types | fixed point integer |
| Direct Feedthrough | no |
| Multidimensional Signals | no |
| Variable-Size Signals | no |
| Zero-Crossing Detection | no |

Extended Capabilities

C/C++ Code Generation

Generate C and C++ code using Simulink® Coder™.

Not recommended for production code. Relates to resource limits and restrictions on speed and memory often found in embedded systems. Generated code can contain dynamic allocation and freeing of memory, recursion, additional memory overhead, and widely-varying execution times. While the code is functionally valid and generally acceptable in resource-rich environments, smaller embedded targets often cannot support such code. Usually, blocks evolve toward being suitable for production code. Thus, blocks suitable for production code remain suitable.

HDL Code Generation

Generate Verilog and VHDL code for FPGA and ASIC designs using HDL Coder™.

HDL Coder provides additional configuration options that affect HDL implementation and synthesized logic.

HDL Architecture

This block has a single, default HDL architecture.

HDL Block Properties

| | |
|----------------------------------|--|
| ConstrainedOutputPipeline | Number of registers to place at the outputs by moving existing delays within your design. Distributed pipelining does not redistribute these registers. The default is 0. For more details, see “ConstrainedOutputPipeline” (HDL Coder). |
| InputPipeline | Number of input pipeline stages to insert in the generated code. Distributed pipelining and constrained output pipelining can move these registers. The default is 0. For more details, see “InputPipeline” (HDL Coder). |
| OutputPipeline | Number of output pipeline stages to insert in the generated code. Distributed pipelining and constrained output pipelining can move these registers. The default is 0. For more details, see “OutputPipeline” (HDL Coder). |

PLC Code Generation

Generate Structured Text code using Simulink® PLC Coder™.

Fixed-Point Conversion

Design and simulate fixed-point systems using Fixed-Point Designer™.

See Also

Counter Limited | MATLAB Function

Introduced before R2006a

Counter Limited

Count up and wrap back to zero after outputting specified upper limit

Library: Simulink / Sources
HDL Coder / Sources



Description

The Counter Limited block counts up until the specified upper limit is reached. Then the counter wraps back to zero, and restarts counting up. The counter always initializes to zero.

Note This block does not report wrap on overflow warnings during simulation. To report these warnings, see the `Simulink.restoreDiagnostic` reference page. The block does report errors due to wrap on overflow.

Ports

Output

Port_1 — Count value

scalar

Count value, specified as an unsigned integer of 8 bits, 16 bits, or 32 bits. The block uses the smallest number of bits required to represent the upper limit.

Data Types: `uint8` | `uint16` | `uint32`

Parameters

Upper limit — Upper limit

7 (default) | scalar

Specify the upper limit for the block to count to as a finite, real-valued scalar.

Programmatic Use

Block Parameter: `uplimit`

Type: character vector

Values: scalar

Default: '7'

Sample time — Interval between samples

-1 (default) | scalar | vector

Specify the time interval between samples as a scalar (`sampling period`), or a two-element vector (`sampling period`, `initial offset`). To inherit the sample time, set this parameter to -1. For more information, see “Specify Sample Time”.

Programmatic Use**Block Parameter:** tsamp**Type:** character vector**Values:** scalar | vector**Default:** '-1'**Block Characteristics**

| | |
|---------------------------------|---------------------------------|
| Data Types | Boolean fixed point integer |
| Direct Feedthrough | no |
| Multidimensional Signals | no |
| Variable-Size Signals | no |
| Zero-Crossing Detection | no |

Extended Capabilities**C/C++ Code Generation**

Generate C and C++ code using Simulink® Coder™.

- The code generator does not explicitly group primitive blocks that constitute a nonatomic masked subsystem block in the generated code. This flexibility allows for more efficient code generation. In certain cases, you can achieve grouping by configuring the masked subsystem block to execute as an atomic unit by selecting the **Treat as atomic unit** option.
- Not recommended for production code. Relates to resource limits and restrictions on speed and memory often found in embedded systems. Generated code can contain dynamic allocation and freeing of memory, recursion, additional memory overhead, and widely-varying execution times. While the code is functionally valid and generally acceptable in resource-rich environments, smaller embedded targets often cannot support such code. Usually, blocks evolve toward being suitable for production code. Thus, blocks suitable for production code remain suitable.

HDL Code Generation

Generate Verilog and VHDL code for FPGA and ASIC designs using HDL Coder™.

HDL Coder provides additional configuration options that affect HDL implementation and synthesized logic.

HDL Architecture

This block has a single, default HDL architecture.

HDL Block Properties

| | |
|----------------------------------|--|
| ConstrainedOutputPipeline | Number of registers to place at the outputs by moving existing delays within your design. Distributed pipelining does not redistribute these registers. The default is 0. For more details, see “ConstrainedOutputPipeline” (HDL Coder). |
|----------------------------------|--|

| | |
|-----------------------|--|
| InputPipeline | Number of input pipeline stages to insert in the generated code. Distributed pipelining and constrained output pipelining can move these registers. The default is 0. For more details, see "InputPipeline" (HDL Coder). |
| OutputPipeline | Number of output pipeline stages to insert in the generated code. Distributed pipelining and constrained output pipelining can move these registers. The default is 0. For more details, see "OutputPipeline" (HDL Coder). |

PLC Code Generation

Generate Structured Text code using Simulink® PLC Coder™.

Fixed-Point Conversion

Design and simulate fixed-point systems using Fixed-Point Designer™.

See Also

Counter Free-Running

Introduced before R2006a

Cross Product

Cross product of two vectors

Library: Simulink / Matrix Operations

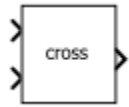

Description

The Cross Product block returns the cross product, or vector product, of two 3-by-1 vectors.

Ports

Input

Port_1 – First input vector

3-element vector

First input vector, specified as a 3-element vector.

Data Types: single | double | half | int8 | int16 | int32 | int64 | uint8 | uint16 | uint32 | uint64 | fixed point | enumerated | bus

Port_2 – Second input vector

3-element vector

Second input vector, specified as a 3-element vector.

Data Types: single | double | half | int8 | int16 | int32 | int64 | uint8 | uint16 | uint32 | uint64 | Boolean | fixed point | enumerated | bus

Output

Port_1 – Cross product of input vectors

3-element vector

Cross product of input vectors, returned as a 3-element vector.

Data Types: single | double | half | int8 | int16 | int32 | int64 | uint8 | uint16 | uint32 | uint64 | Boolean | fixed point | enumerated | bus

Block Characteristics

| | |
|---------------------------------|--|
| Data Types | Boolean double fixed point half integer single |
| Direct Feedthrough | no |
| Multidimensional Signals | no |
| Variable-Size Signals | no |

| | |
|--------------------------------|----|
| Zero-Crossing Detection | no |
|--------------------------------|----|

Extended Capabilities

C/C++ Code Generation

Generate C and C++ code using Simulink® Coder™.

See Also

[Hermitian Transpose](#) | [Identity Matrix](#) | [IsSymmetric](#) | [IsTriangular](#) | [Matrix Square](#) | [Transpose](#)

Topics

“Compatible Array Sizes for Basic Operations”

MATLAB Matrix Operations

Introduced in R2021b

Dashboard Scope

Trace signals during simulation

Library: Simulink / Dashboard

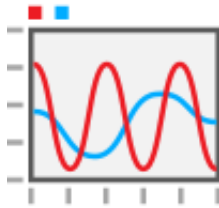

Description

The Dashboard Scope block shows connected signals during simulation on a scope display. You can use the Dashboard Scope block with other Dashboard blocks to build an interactive dashboard of controls and indicators for your model. The Dashboard Scope block provides a complete picture of signal behavior over the course of the simulation, and connected signals log to the Simulation Data Inspector for analysis during or after simulation. Use the Dashboard Scope block to display signals of any data type that Simulink supports, including enumerated data types. The Dashboard Scope block can display up to eight signals from an array or bus.

Connect Dashboard Blocks

Dashboard blocks do not use ports to connect to model elements. To connect dashboard blocks to signals in your model, use connect mode. Connect mode facilitates the process of connecting dashboard blocks in your model, especially when you want to connect multiple blocks at once. If you only want to connect a single dashboard block, you can also use the **Connection** table in the block dialog box.

Tip You can modify dashboard block connections during normal and accelerator mode simulations.

To enter connect mode, select a dashboard block to connect and then, on the block tab, click **Connect**. In connect mode, when you select one or more signals, a list of signals that are available for connection appears. Select a signal from the list to connect the signal to the selected dashboard block. To connect another dashboard block, pause on the block you want to connect and click the **Connect** button above it. Then, select one or more signals in the model and choose a signal to connect.

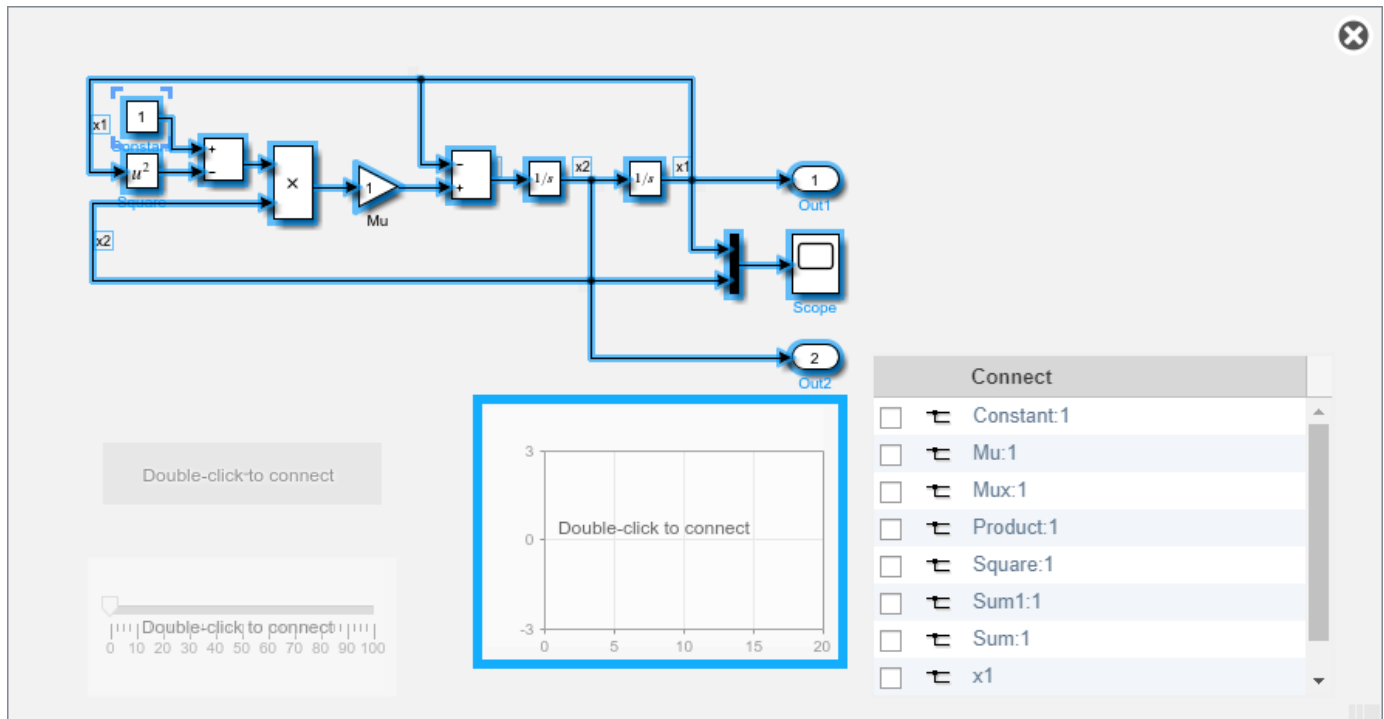

When you finish connecting the dashboard blocks in your model, on the block tab, click **Done Connecting**.

Tip You can hide the message shown on unconnected blocks using the `set_param` function with the `ShowInitialText` block parameter. The message also disappears when you connect the block.

Data Cursors

You can add data cursors to a Dashboard Scope block to inspect the displayed signals. The data cursors show when the Dashboard Scope block is selected. With the Dashboard Scope block selected, you can move cursors along the displayed signals to see the data values that correspond to each time sample. When you display two cursors, a box between the cursors along the time axis displays the time difference between the two cursors.

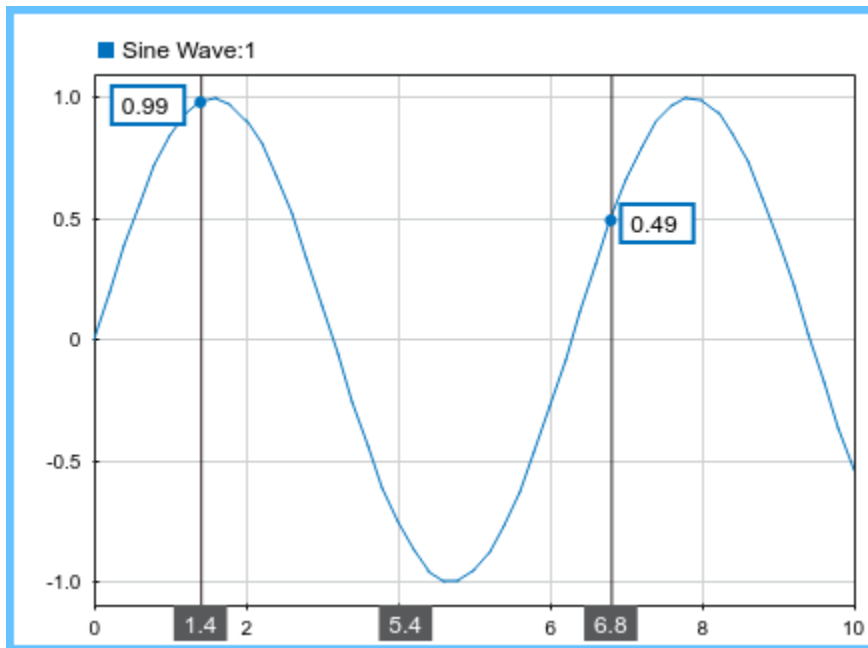

To add data cursors, right-click the Dashboard Scope block. Under the **Data Cursors** menu, select the number of cursors you want to add.

Zoom, Pan, and Fit to View

You can also use zoom, pan, and fit-to-view actions to inspect your signals. You can restrict the zoom and fit-to-view actions to change the plot limits for only the t -axis or only the y -axis. To zoom, pan, or fit to view, right-click the Dashboard Scope block and select an action.

- Pan
- Zoom In
- Zoom in Time
- Zoom in Y
- Zoom Out
- Fit to View
- Fit to View in Time
- Fit to View in Y

Signal Appearance

You can modify the color and line style for signals connected to a Dashboard Scope block from the **Connection** table in the block dialog box. To modify the appearance of a connected signal:

- 1 Click the signal appearance preview for the signal in the **Style** column of the **Connection** table.

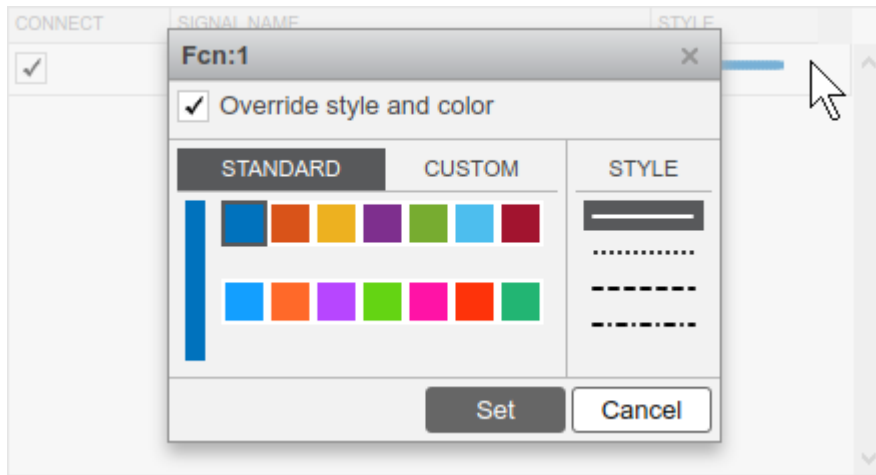

- 2 Choose a signal color from the palette of standard colors or specify a custom color using RGB values between 0 and 255.
- 3 Select the line style from the solid, dotted, dashed, and dot-dashed options under the **Style** section in the signal appearance dialog.

Signal color and line style remain consistent for a signal throughout a model. You can configure the line style and color for a signal through the Instrumentation Properties for a logged signal and through the Dashboard Scope block dialog of a Dashboard Scope block connected to the signal. The **Override style and color** setting is selected by default and controls whether signal appearance options chosen through that Dashboard Scope block dialog box override signal appearance options configured elsewhere in the model. When you clear the **Override style and color** setting, changes made using the dialog box for that Dashboard Scope block are not applied.

When you connect signals to a Dashboard Scope block using the block dialog box, the connection table shows the default signal color and line style used for a signal you connect. As you check signals to connect, the **Connection** table updates the default style and color to be used for the next signal you connect from the remaining signals in the selection.

| CONNECT | SIGNAL NAME | STYLE |
|-------------------------------------|---------------------------|-------|
| <input checked="" type="checkbox"/> | Fcn:1 | |
| <input checked="" type="checkbox"/> | Mu:1 | |
| <input type="checkbox"/> | Mux:1 | |
| <input type="checkbox"/> | Product:1 | |
| <input type="checkbox"/> | Sum:1 | |
| <input type="checkbox"/> | x1 | |
| <input type="checkbox"/> | x2 | |

Complex Signals

The Dashboard Scope block displays complex signals according to their **Complex Format**. You can configure the **Complex Format** for a signal using the Instrumentation Properties dialog, accessible when you right-click the logging badge for the signal and select **Properties**.

A signal can have a **Complex Format** that is:

- **Real-Imaginary**
- **Magnitude-Phase**
- **Magnitude**
- **Phase**

When you set the **Complex Format** for a signal to **Real-Imaginary** or **Magnitude-Phase**, the Dashboard Scope block displays both components of the signal. The real or magnitude component displays in the color indicated in the **Connection** table. The imaginary or phase component displays in a different shade of the color indicated in the **Connection** table.

Limitations

- You cannot use the **Connection** table to connect a Dashboard block to a block that is commented out. When you connect a Dashboard block to a commented block using connect mode, the Dashboard block does not display the connected value until the you uncomment the block.
- The toolstrip does not support dashboard blocks that are in a panel.
- Dashboard blocks cannot connect to signals inside referenced models.
- When you simulate a model hierarchy, Dashboard blocks inside referenced models do not update.
- Dashboard blocks do not support rapid accelerator simulation.
- You cannot connect a dashboard block to data or activity in Stateflow during simulation.
- Some signals do not have data available during simulation due to block reduction or optimization for accelerator mode simulations. To view such a signal using a dashboard block, mark the signal for logging.

Parameters

Connection

Connection — Select signals to connect and display

signal connection options

Select one or more signals to connect using the **Connection** table. Populate the **Connection** table by selecting signals of interest in your model. Select the check box next to the signal you want to display. Click **Apply** to connect the signal. To facilitate understanding and debugging your model, you can connect signals to a Dashboard Scope block during simulation.

You can also configure the line style and color for signals connected to a Dashboard Scope block using the **Connection** table. For more information, see “Signal Appearance” on page 1-203.

Programmatic Use

To programmatically specify one or more signals to connect to the Dashboard Scope block, use a cell array of `Simulink.HMI.SignalSpecification` objects.

Block Parameter: Binding

Type: cell array of `Simulink.HMI.SignalSpecification` objects

Default: []

To programmatically configure the line style and color for connected signals, use the `Colors` parameter. Specify the value for the `Colors` parameter as an array of structures, where each structure specifies the line style and color for one signal. Settings specified using the `Colors` parameter apply to the signal at the same index in the value for the `Binding` parameter.

Specify the line style and color for each signal as a structure with the fields:

- `Color` — 1-by-3 [r g b] vector with values between 0 and 1 specifying the signal color.
- `LineStyle` — Character vector specifying one of these line style options:
 - Solid: '-'
 - Dashed: '—'
 - Dotted: ':'
 - Dash-dotted: '-.'

```
sig1Colors.Color = [0 0 1];
sig1Colors.LineStyle = '--';
sig2Colors.Color = [1 0 1];
sig2Colors.LineStyle = '-';
sigColors = [sig1Colors sig2Colors];
```

Block Parameter: Colors

Type: array of structures

Main**Time Span — Time axis span**

auto (default) | scalar

A finite, real, double, scalar value that sets the time span of the plot.

When **Time Span** is set to auto, the block sets its time span to the model's simulation stop time.

Tips

When you set the **Time Span** to a value that is less than the duration of the simulation, use the **Update Mode** parameter to control whether the display wraps or scrolls when the simulation time exceeds the specified time span.

Programmatic Use

Block Parameter: TimeSpan

Type: string | character array

Values: 'auto' or numeric value

Default: 'auto'

Update Mode — Display update behavior

Wrap (default) | Scroll

How the display updates during simulation, specified as `Wrap` or `Scroll`.

- `Wrap` — Display wraps to show incoming data after simulation time reaches end of time span.
- `Scroll` — Display scrolls to show incoming data after simulation time reaches end of time span.

Programmatic Use

Block Parameter: `UpdateMode`

Type: string | character array

Values: 'Wrap' | 'Scroll'

Default: 'Wrap'

Min — Vertical axis minimum

-3 (default) | scalar

A finite, real, double, scalar value that sets the minimum of the vertical axis.

Dependencies

The **Min** value must be less than the **Max** value.

Programmatic Use

To specify the `Min` parameter for the Dashboard Scope block programmatically, use a 1-by-2 vector containing the minimum y-axis value and maximum y-axis value, in that order.

Block Parameter: `YLimits`

Type: 1x2 vector

Default: [-3 3]

Max — Vertical axis maximum

3 (default) | scalar

A finite, real, double, scalar value that sets the maximum of the vertical axis.

Dependencies

The **Max** value must be greater than the **Min** value.

Programmatic Use

To specify the `Max` parameter for the Dashboard Scope block programmatically, use a 1-by-2 vector containing the minimum y-axis value and maximum y-axis value, in that order.

Block Parameter: `YLimits`

Type: 1x2 vector

Default: [-3 3]

Normalize y-axis limits — y-axis normalization to range of [0,1]

off (default) | on

When on, normalizes the connected signal data for display on a y-axis range of [0, 1].

Programmatic Use

Block Parameter: `NormalizeYAxis`

Type: string | character vector

Values: 'on' | 'off'

Default: 'off'

Scale axes limits at stop — Plot fit-to-view upon simulation stop

on (default) | off

When on, performs a fit-to-view operation on the data displayed in the plot when the simulation stops.

Programmatic Use

Block Parameter: ScaleAtStop

Type: string | character vector

Values: 'on' | 'off'

Default: 'on'

Show "Double-click to connect" message — Connection instructions visibility

on (default) | off

When on, shows instructional text if the block is not connected. When the block is not connected, you can specify this parameter as off to hide the text.

Programmatic Use

Block Parameter: ShowInitialText

Type: string | character vector

Values: 'on' | 'off'

Default: 'on'

Display**Ticks — Axes tick positions**

Outside (default) | Inside | None

Axes tick positions, specified as Outside, Inside, or None.

- Outside — Ticks are drawn on the outside of the x- and y-axes.
- Inside — Ticks are drawn on the inside of the x- and y-axes.
- None — No ticks are shown on the x- or y-axes.

Programmatic Use

Block Parameter: TicksPosition

Type: string | character vector

Values: 'Outside' | 'Inside' | 'None'

Default: 'Outside'

Tick Labels — Tick label visibility

All (default) | T-Axis | Y-Axis | None

Visibility of tick labels on the x- and y-axes.

- All — Ticks labels are shown on the x- and y-axes.
- T-Axis — Tick labels are shown on the x-axis only.
- Y-Axis — Tick labels are shown on the y-axis only.
- None — No tick labels are shown on the x- or y-axis.

Programmatic Use

Block Parameter: TickLabels

Type: string | character vector

Values: 'All' | 'T-Axis' | 'Y-Axis' | 'None'

Default: 'All'

Legend — Legend position

Top (default) | Right | Inside top | Inside right | Hide

You can position the legend at the top of the plot, inside or outside the plot area or on the right of the plot, inside or outside the plot area. You can also hide the legend. The legend shows the color chosen for each connected signal next to the signal name.

Programmatic Use

Block Parameter: LegendPosition

Type: string | character vector

Values: 'Top' | 'Right' | 'InsideTop' | 'InsideRight' | 'Hide'

Default: 'Top'

Horizontal — Horizontal grid line visibility

on (default) | off

Visibility of horizontal grid lines.

- on — Horizontal grid lines are visible on Dashboard Scope.
- off — Horizontal grid lines are not shown on Dashboard Scope.

Programmatic Use

Block Parameter: Grid

Type: string | character vector

Values: 'All' | 'Horizontal' | 'Vertical' | 'None'

Default: 'All'

Vertical — Vertical grid line visibility

on (default) | off

Visibility of vertical grid lines.

- on — Vertical grid lines are visible on Dashboard Scope.
- off — Vertical grid lines are not shown on Dashboard Scope.

Programmatic Use

Block Parameter: Grid

Type: string | character vector

Values: 'All' | 'Horizontal' | 'Vertical' | 'None'

Default: 'All'

Border — Plot border visibility

on (default) | off

Plot border visibility.

- on — Plot border is shown on Dashboard Scope.
- off — Plot border is not shown on Dashboard Scope.

Programmatic Use

Block Parameter: Border

Type: string | character vector

Values: 'on' | 'off'

Default: 'on'

Markers — Signal data marker visibility

off (default) | on

Signal data marker visibility.

- on — Data markers are shown for signals plotted on Dashboard Scope.
- off — Data markers are not shown for signals plotted on Dashboard Scope.

Programmatic Use

Block Parameter: Markers

Type: string | character vector

Values: 'on' | 'off'

Default: 'off'

Style

ForegroundColor — Grid lines color

[r g b] vector

Color of grid lines. You can select a color from a palette of standard colors or specify a custom color.

Programmatic Use

Specify the `ForegroundColor` parameter for the block as a 1-by-3 [r g b] vector with values between 0 and 1.

Block Parameter: `ForegroundColor`

Type: [r g b] vector

BackgroundColor — Plot area color

[r g b] vector

Color of plot area. You can select a color from a palette of standard colors or specify a custom color.

Programmatic Use

Specify the `BackgroundColor` parameter for the block as a 1-by-3 [r g b] vector with values between 0 and 1.

Block Parameter: `BackgroundColor`

Type: [r g b] vector

Font Color — Ticks and tick labels color

[r g b] vector

Color of ticks and tick labels. You can select a color from a palette of standard colors or specify a custom color.

Programmatic Use

Specify the `FontColor` parameter for the block as a 1-by-3 [r g b] vector with values between 0 and 1.

Block Parameter: `FontColor`

Type: [r g b] vector

Block Characteristics

| | |
|---------------------------------|--|
| Data Types | Boolean bus double enumerated fixed point half integer single string |
| Direct Feedthrough | no |
| Multidimensional Signals | yes |
| Variable-Size Signals | no |
| Zero-Crossing Detection | no |

Extended Capabilities

C/C++ Code Generation

Generate C and C++ code using Simulink® Coder™.

Dashboard blocks are ignored for code generation.

See Also

Topics

“Tune and Visualize Your Model with Dashboard Blocks”

“Decide How to Visualize Simulation Data”

Introduced in R2015a

Data Store Memory

Define data store

Library: Simulink / Signal Routing



Description

The Data Store Memory block defines and initializes a named shared data store, which is a memory region usable by Data Store Read and Data Store Write blocks that specify the same data store name.

The location of the Data Store Memory block that defines a data store determines which Data Store Read and Data Store Write blocks can access the data store:

- If the Data Store Memory block is in the *top-level system*, Data Store Read and Data Store Write blocks anywhere in the model can access the data store.
- If the Data Store Memory block is in a *subsystem*, Data Store Read and Data Store Write blocks in the same subsystem or in any subsystem below it in the model hierarchy can access the data store.

Data Store Read or Data Store Write blocks cannot access a Data Store Memory block that is either in a model that contains a Model block or in a referenced model.

Do not include a Data Store Memory block in a For Each subsystem.

Obtaining correct results from data stores requires ensuring that data store reads and writes occur in the expected order. For details, see:

- “Order Data Store Access”
- “Data Store Diagnostics”
- “Log Data Stores”

You can use `Simulink.Signal` objects in addition to, or instead of, Data Store Memory blocks to define data stores. A data store defined in the *base* workspace with a signal object is a *global* data store. Global data stores are accessible to every model, including all referenced models. See “Data Stores” for more information.

You can select a Data Store Read, Data Store Write, or Data Store Memory block to highlight blocks related to it. To show a related block in an open diagram or new tab, pause on the ellipsis that

appears after selection. Then, select **Related Blocks**  from the action bar. When multiple blocks correspond to the selected block, a list of related blocks opens. You can filter the list of related blocks by entering a search term in the text box. After you select a related block from the list, window focus goes to the open diagram or new tab that shows the related block.

Parameters

Main

Data store name — Name for the data store

A (default) | character vector | string

Specify a name for the data store you are defining with this block. Data Store Read and Data Store Write blocks with the same name can read from, and write to, the data store initialized by this block. The name can represent a Data Store Memory block or a sign object defined to be a data store.

Programmatic Use

Block Parameter: DataStoreName

Type: character vector

Values: 'A' | ...

Default: 'A'

Rename All — Rename this data store throughout the model

button

Rename this data store everywhere the Data Store Read and Data Store Write blocks use it in a model.

Limitations

You cannot use **Rename All** to rename a data store if you:

- Use a `Simulink.Signal` object in a workspace to control the code generated for the data store
- Use a `Simulink.Signal` object instead of a Data Store Memory block to define the data store

You must instead rename the corresponding `Simulink.Signal` object from Model Explorer. For an example, see “Rename Data Store Defined by Signal Object”.

Corresponding Data Store Read/Write blocks — Path to connected Data Store Read/Write blocks

block path

List all the Data Store Read and Data Store Write blocks that have the same data store name as the current block, and that are in the current system or in any subsystem below it in the model hierarchy. Clicking a block path displays and highlights that block in your model.

Signal Attributes

Initial value — Initial value of data store

0 (default) | scalar | vector | matrix | N-D array

Specify the initial value or values of the data store. The **Minimum** parameter specifies the minimum value for this parameter, and the **Maximum** parameter specifies the maximum value.

If you specify a nonscalar value and set **Dimensions** to -1 (the default), the data store has the same dimensions as the array. Data that you write to the data store (by using Data Store Write blocks) must have these dimensions.

If you set the **Dimensions** parameter to a value other than -1, the initial value dimensions must match the dimensions that you specify, unless the initial value is a scalar or a MATLAB structure. If

you specify a scalar, each element of the data store uses the scalar as the initial value. Use this technique to apply the same initial value (the scalar that you specify) to each element without manually matching the dimensions of the initial value with the dimensions of the data store.

To use this block to initialize a nonvirtual bus signal, specify the initial value as a MATLAB structure and set the model configuration parameter “Underspecified initialization detection” to *Simplified*. For more information about initializing nonvirtual bus signals using structures, see “Specify Initial Conditions for Bus Elements”.

Programmatic Use**Block Parameter:** InitialValue**Type:** character vector**Values:** scalar | vector | matrix | N-D array**Default:** '0'**Minimum — Minimum output value for range checking**

[] (default) | scalar

Specify the minimum value that the block should output. The default value is [] (unspecified). This number must be a finite real double scalar value.

Note If you specify a bus object as the data type for this block, do not set the minimum value for bus data on the block. Simulink ignores this setting. Instead, set the minimum values for bus elements of the bus object specified as the data type. For information on the Minimum property of a bus element, see `Simulink.BusElement`.

Simulink uses the minimum value to perform:

- Parameter range checking (see “Specify Minimum and Maximum Values for Block Parameters”).
- Simulation range checking (see “Specify Signal Ranges”).
- Automatic scaling of fixed-point data types.
- Optimization of the code that you generate from the model. This optimization can remove algorithmic code and affect the results of some simulation modes such as SIL or external mode. For more information, see “Optimize using the specified minimum and maximum values” (Embedded Coder).

Programmatic Use**Block Parameter:** OutMin**Type:** character vector**Values:** scalar**Default:** '[]'**Maximum — Maximum output value for range checking**

[] (default) | scalar

Specify the maximum value that the block should output. The default value is [] (unspecified). This number must be a finite real double scalar value.

Note If you specify a bus object as the data type for this block, do not set the maximum value for bus data on the block. Simulink ignores this setting. Instead, set the maximum values for bus

elements of the bus object specified as the data type. For information on the Maximum property of a bus element, see `Simulink.BusElement`.

Simulink uses the maximum value to perform:

- Parameter range checking (see “Specify Minimum and Maximum Values for Block Parameters”).
- Simulation range checking (see “Specify Signal Ranges”).
- Automatic scaling of fixed-point data types.
- Optimization of the code that you generate from the model. This optimization can remove algorithmic code and affect the results of some simulation modes such as SIL or external mode. For more information, see “Optimize using the specified minimum and maximum values” (Embedded Coder).

Programmatic Use

Block Parameter: OutMax

Type: character vector

Values: scalar

Default: '[]'

Data type — Output data type

Inherit: auto (default) | double | single | half | int8 | uint8 | int16 | uint16 | int32 | uint32 | int64 | uint64 | boolean | fixdt(1,16,0) | fixdt(1,16,2^0,0) | string | Enum: <class name>

Specify the output data type. You can set it to:

- A rule that inherits a data type (for example, Inherit: auto).
- The name of a built-in data type (for example, single).
- The name of a data type object (for example, a `Simulink.NumericType` object).
- An expression that evaluates to a data type (for example, `fixdt(1,16,0)`). Do not specify a bus object as the data type in an expression; use `Bus: <object name>` to specify a bus data type.

Click the **Show data type assistant** button  to display the **Data Type Assistant**, which helps you set the data type attributes. For more information, see “Specify Data Types Using Data Type Assistant”.

Programmatic Use

Block Parameter: OutDataTypeStr

Type: character vector

Values: 'Inherit: auto' | 'double' | 'single' | 'half' | 'int8' | 'uint8' | 'int16' | 'uint16' | 'int32' | 'uint32' | 'int64' | 'uint64' | 'boolean' | 'fixdt(1,16,0)' | 'fixdt(1,16,2^0,0)' | 'string' | 'Enum: <class name>'

Default: 'Inherit: auto'

Lock output data type setting against changes by the fixed-point tools — Prevent fixed-point tools from overriding Output data type

off (default) | on

Select this parameter to prevent the fixed-point tools from overriding the **Output** data type you specify on the block. For more information, see “Use Lock Output Data Type Setting” (Fixed-Point Designer).

Programmatic Use**Block Parameter:** LockScale**Type:** character vector**Values:** 'off' | 'on'**Default:** 'off'**Dimensions (-1 to infer from Initial value) — Dimensions of data store**

-1 (default) | scalar | vector | matrix

Dimensions of the data store. The default value, -1, enables you to set the dimensions of the data store by using the **Initial value** parameter. However, in this case, you cannot use scalar expansion with the initial value. You must specify the initial value by using an array that has the dimensions that you want.

If you use a value other than -1, specify the same dimensions as the dimensions of the **Initial value** parameter, unless you specify the initial value as a scalar (for scalar expansion) or a MATLAB structure. If the data store represents an array of buses, and if you use a MATLAB structure for the initial value, you can specify dimensions to initialize the array of buses with this structure.

Programmatic Use**Block Parameter:** Dimensions**Type:** character vector**Values:** scalar | vector | matrix**Default:** '-1'**Interpret vector parameters as 1-D — Interpret vectors as 1-D**

on (default) | off

Specify that the data store interpret vector initial values as one-dimensional.

By default, MATLAB represents vector data as matrices, which have two dimensions. For example, MATLAB represents the vector [1 2 3] as a 1-by-3 matrix.

When you select this parameter, the data store represents vector data by using only one dimension instead of two. For example, if you specify an initial value of [1 2 3], the data store stores a one-dimensional vector with three elements.

For more information, see “Determine the Output Dimensions of Source Blocks”.

Programmatic Use**Block Parameter:** VectorParams1D**Type:** character vector**Values:** 'off' | 'on'**Default:** 'on'**Signal type — Complexity of data store values**

auto (default) | real | complex

Specify the numeric type, real or complex, of the values in the data store.

Programmatic Use**Block Parameter:** SignalType**Type:** character vector**Values:** 'auto' | 'real' | 'complex'**Default:** 'auto'

Share across model instances — Allow Model blocks to read from the same data store

off (default) | on

In a single model reference hierarchy, when you use multiple Model blocks to refer to a model that contains a Data Store Memory block, by default, each instance of the referenced model (each Model block) reads from and writes to a separate copy of the data store. When you select **Share across model instances**, instead of interacting with a separate copy, all of the instances read from and write to the same data store.

When you set the model configuration parameter **Code interface packaging** to Reusable function to generate reentrant code from a model (Simulink Coder), a data store with **Share across model instances** selected appears in the code as a global symbol that the generated entry-point functions access directly. For example, a global symbol is a global variable or a field of a global structure variable. Therefore, each call that your code makes to the entry-point functions (each instance of the model) shares the data.

For an example, see “Share Data Store Between Instances of a Reusable Algorithm” on page 13-331. For more information, see “Share Data Among Referenced Model Instances”.

Programmatic Use**Block Parameter:** ShareAcrossModelInstances**Type:** character vector**Values:** 'off' | 'on'**Default:** 'off'**Data store name must resolve to Simulink signal object — Require data store name resolve to Simulink signal object**

off (default) | on

Specify that Simulink software, when compiling the model, searches the model and base workspace for a Simulink.Signal object having the same name, as described in “Symbol Resolution”. If Simulink does not find such an object, the compilation stops with an error. Otherwise, Simulink compares the attributes of the signal object to the corresponding attributes of the Data Store Memory block. If the block and the object attributes are inconsistent, Simulink halts model compilation and displays an error.

Programmatic Use**Block Parameter:** StateMustResolveToSignalObject**Type:** character vector**Values:** 'off' | 'on'**Default:** 'off'**Diagnostics****Detect Read Before Write — Action when model attempts to read data before writing in current time step**

warning (default) | none | error

Select the diagnostic action to take if the model attempts to read data from a data store to which it has not written data in this time step. See also the “Detect read before write” diagnostic in the **Data Store Memory block** section of the **Model Configuration Parameters > Diagnostics > Data Validity** pane.

- None — Produce no response.

- Warning — Display a warning and continue the simulation.
- Error — Terminate the simulation and display an error.

Programmatic Use**Block Parameter:** ReadBeforeWriteMsg**Type:** character vector**Values:** 'none' | 'warning' | 'error'**Default:** 'warning'**Detect Write After Read — Action when block attempts to write after reading in same time step**

warning (default) | none | error

Select the diagnostic action to take if the model attempts to write data to the data store after previously reading data from it in the current time step. See also the “Detect write after read” diagnostic in the **Data Store Memory block** section of the **Model Configuration Parameters > Diagnostics > Data Validity** pane.

- None — Produce no response.
- Warning — Display a warning and continue the simulation.
- Error — Terminate the simulation and display an error.

Programmatic Use**Block Parameter:** WriteAfterReadMsg**Type:** character vector**Values:** 'none' | 'warning' | 'error'**Default:** 'warning'**Detect Write After Write — Action when model writes twice in same time step**

warning (default) | none | error

Select the diagnostic action to take if the model attempts to write data to the data store twice in succession in the current time step. See also the “Detect write after write” diagnostic in the **Data Store Memory block** section of the **Model Configuration Parameters > Diagnostics > Data Validity** pane.

- None — Produce no response.
- Warning — Display a warning and continue the simulation.
- Error — Terminate the simulation and display an error.

Programmatic Use**Block Parameter:** WriteAfterWriteMsg**Type:** character vector**Values:** 'none' | 'warning' | 'error'**Default:** 'warning'**Logging****Log data store data — Log data store data**

off (default) | on

Select this option to save the values of this signal to the MATLAB workspace during simulation. See “Signal Logging” for details.

Programmatic Use**Block Parameter:** DataLogging**Type:** character vector**Values:** 'off' | 'on'**Default:** 'off'**Logging name — Name associated with logged signal data**

Use data store name (default) | Custom

Use this pair of controls, consisting of a list box and an edit field, to specify the name associated with logged signal data.

Simulink uses the signal name as its logging name by default. To specify a custom logging name, select Custom from the list box and enter the custom name in the adjacent edit field.

Programmatic Use**Block Parameter:** DataLoggingNameMode**Type:** character vector**Values:** 'SignalName' | 'Custom'**Default:** ''

Note If you set DataLoggingNameMode to Custom, you must specify the name associated with logged signal data using the DataLoggingName parameter.

Block Parameter: DataLoggingName**Type:** character vector**Values:** character vector**Default:** ''**Limit data points to last — Discard all but the last N data points**

5000 | non-zero integer

Discard all but the last N data points, where N is the number that you enter in the adjacent edit field. For more information, see “Log Data Stores”.

Programmatic Use**Block Parameter:** DataLoggingMaxPoints**Type:** character vector**Values:** nonzero integer**Default:** '5000'**Decimation — Log every Nth data point**

2 (default) | integer

Log every Nth data point, where N is the number that you enter in the adjacent edit field. For example, suppose that your model uses a fixed-step solver with a step size of 0.1 s. If you select this option and accept the default decimation value (2), Simulink records data points for this signal at times 0.0, 0.2, 0.4, and so on. For more information, see “Log Data Stores”.

Programmatic Use**Block Parameter:** DataLoggingLimitDataPoints**Type:** character vector**Values:** non-zero integer

Default: '2'

Block Characteristics

| | |
|---------------------------------|--|
| Data Types | Boolean bus double enumerated fixed point half integer single string |
| Direct Feedthrough | yes |
| Multidimensional Signals | yes |
| Variable-Size Signals | no |
| Zero-Crossing Detection | no |

Extended Capabilities

C/C++ Code Generation

Generate C and C++ code using Simulink® Coder™.

PLC Code Generation

Generate Structured Text code using Simulink® PLC Coder™.

To generate PLC code for a model that uses a Data Store Memory block, first define a `Simulink.Signal` in the base workspace. Then in the **Signal Attributes** tab of the block parameters, set the data store name to resolve to that of the `Simulink.Signal` object.

Fixed-Point Conversion

Design and simulate fixed-point systems using Fixed-Point Designer™.

See Also

Data Store Read | Data Store Write

Topics

“Storing Data Using Data Store Memory Blocks”

“Data Stores”

“Choosing How to Store Global Data”

“C Code Generation Configuration for Model Interface Elements” (Simulink Coder)

“Organize Parameter Data into a Structure by Using Struct Storage Class” (Embedded Coder)

“Access Data Stores with Simulink Blocks”

“Log Data Stores”

Introduced before R2006a

Data Store Read

Read data from data store

Library: Simulink / Signal Routing



Description

The Data Store Read block copies data from the named data store or a selected portion thereof to its output. More than one Data Store Read block can read from the same data store.

The data store from which the data is read is determined by the location of the Data Store Memory block or signal object that defines the data store. For more information, see “Data Stores” and Data Store Memory.

Obtaining correct results from data stores requires ensuring that data store reads and writes occur in the expected order. See “Order Data Store Access” and “Data Store Diagnostics” for details.

You can select a Data Store Read, Data Store Write, or Data Store Memory block to highlight blocks related to it. To show a related block in an open diagram or new tab, pause on the ellipsis that

appears after selection. Then, select **Related Blocks**  from the action bar. When multiple blocks correspond to the selected block, a list of related blocks opens. You can filter the list of related blocks by entering a search term in the text box. After you select a related block from the list, window focus goes to the open diagram or new tab that shows the related block.

Ports

Input

IdxN — Nth index signal

scalar | vector

External port specifying an index for the selection of the corresponding data store subelements.

Dependencies

To enable an external index port, on the **Element Selection** tab, select **Enable indexing**. Then, in the Nth row of the **Index Option** table, set **Index Option** to Index vector (port) or Starting index (port).

Data Types: int8 | int16 | int32 | uint8 | uint16

Output

Port_1 — Values from specified data store

scalar | vector | matrix | N-D array

Values from the specified data store, output with the same data type and number of dimensions as in the data store. The block supports both real and complex signals. You can choose whether to output the entire data store or only selected elements.

You can use arrays of buses with a Data Store Read block. For details about defining and using an array of buses, see “Group Nonvirtual Buses in Arrays of Buses”.

Data Types: `single` | `double` | `half` | `int8` | `int16` | `int32` | `int64` | `uint8` | `uint16` | `uint32` | `uint64` | `Boolean` | `fixed point` | `enumerated` | `bus`

Parameters

Parameters

Data store name — Name of data store from which block reads

`A` (default) | name of data store

Specify the name of the data store from which this block reads data. The adjacent list provides the names of Data Store Memory blocks that exist at the same level in the model as the Data Store Read block or at higher levels. The list also includes all `Simulink.Signal` objects in the base and model workspaces. To change the name, select a name from the list or enter the name directly in the edit field.

When compiling a model containing this block, Simulink searches the model upwards from the level of the block for a Data Store Memory block having the specified data store name. If Simulink does not find such a block, it searches the model workspace and the MATLAB workspace for a `Simulink.Signal` object having the same name. If Simulink finds the signal object, it creates a hidden Data Store Memory block at the root level of the model with the properties specified by the signal object and an initial value set to an array of zeros. The dimensions of that array are inherited from the `Dimensions` property of the signal object.

If Simulink finds neither the Data Store Memory block nor the signal object, it halts the compilation and displays an error. See “Symbol Resolution” for more information about the search path.

Programmatic Use

Block Parameter: `DataStoreName`

Type: character vector

Values: data store name

Default: 'A'

Data store memory block — Data Store Memory block name

block path

This property is read-only.

This field lists the Data Store Memory block that initialized the store from which this block reads.

Corresponding Data Store Write blocks — List of corresponding Data Store Write blocks

block path

This property is read-only.

This field lists the path to all Data Store Write blocks with the same data store name as this block that are in the same (sub)system or in any subsystem below it in the model hierarchy. Click any entry in this list to highlight the corresponding block in your model.

Sample time – Sample time

-1 (default) | scalar | vector

The sample time, which controls when the block reads from the data store. A value of -1 indicates that the sample time is inherited. See “Specify Sample Time” for more information.

Programmatic Use

Block Parameter: SampleTime

Type: character vector

Values: scalar | vector

Default: '-1'

Element Selection

Elements in the array (Signals in the bus) – Elements in associated data store

character vector (no default)

List of elements in the associated data store. For data stores containing arrays, you can read the whole data store, or you can specify one or more elements of the data store. For data stores with a bus data type, you can expand the tree to view and select the bus elements. The list displays the maximum dimensions for each element in parentheses.

If **Enable indexing** is not selected, select an element and use one of the following approaches:

- Click **Select>>** to display that element and all its subelements in the **Selected element(s)** list.
- Use the **Specify element(s) to select** edit box to specify the subelements that you want to select for reading. Then click **Select>>**.

To select multiple elements, repeat the above procedure for each element.

Alternatively, you can select **Enable indexing**, then select a single element and specify the subelements dynamically using the **Index Option** parameter.

To refresh the display and reflect modifications to the array or bus used in the data store, click **Refresh**.

Dependencies

The prompt for this section (**Elements in the array** or **Signals in the bus**) depends on the type of data in the data store.

Programmatic Use

Block Parameter: DataStoreElements

Type: character vector

Values: pound-delimited list of elements (See “Specification using the command line”.)

Default: ''

Specify element(s) to select – MATLAB expression defining element to select

character vector (no default)

Enter a MATLAB expression to define a specific element that you want to read, then click **Select>>** to add the element to the **Selected elements(s)** table. Repeat to select additional elements.

For example, for a data store named DSM that has maximum dimensions of [3,5], you could enter expressions such as DSM(2,4) or DSM([1 3],2) in the edit box. See “Accessing Specific Bus and Matrix Elements”.

To apply the element selection, click **OK** or **Apply**.

Dependencies

The **Specify element(s) to select** edit box appears only if **Enable indexing** is not selected.

Programmatic Use

Block Parameter: DataStoreElements

Type: character vector

Values: pound-delimited list of elements (See “Specification using the command line”.)

Default: ''

Selected element(s) — List of selected elements

character vector (no default)

Elements that you select from the data store. The Data Store Read block icon displays an output port for each element that you specify.

To change the order of bus or matrix elements in the list, select the element in the list and click **Up** or **Down**. Changing the order of the elements in the list changes the order of the ports. To remove an element, click **Remove**.

Dependencies

The **Selected element(s)** table appears only if **Enable indexing** is not selected.

Programmatic Use

Block Parameter: DataStoreElements

Type: character vector

Values: pound-delimited list of elements (See “Specification using the command line”.)

Default: ''

Enable indexing — Enable indexing to specify subelements of data store element to read

'off' (default) | 'on'

Select this parameter to enable indexing similar to that used by the Selector block, whereby you can dynamically specify indices of subelements to read by using one or more index input ports, as well as specifying indices by using the block dialog. A Data Store Read block can read from only a single element of a data store (that is, a single signal in a bus) when this parameter is selected. To read from multiple elements of a data store using dynamic indexing, use multiple Data Store Read blocks.

Clear this parameter to disable Selector block-style indexing. You can select multiple data store elements to read, but you can specify which subelements to read only by using the block dialog.

Note Do not select **Enable indexing** if the associated data store contains only a single, scalar element.

Programmatic Use

Block Parameter: EnableIndexing

Type: character vector

Values: 'off' | 'on'

Default: 'off'

Number of dimensions — Number of dimensions of data store element

1 (default) | positive integer

Number of dimensions of selected data store element. You must explicitly indicate this number.

Dependencies

This parameter is enabled only if **Enable indexing** is selected.

Programmatic Use

Block Parameter: NumberOfDimensions

Type: character vector

Values: positive integer

Default: '1'

Index mode — Index mode

One-based (default) | Zero-based

Select the indexing mode. If One-based is selected, an index of 1 specifies the first element of the input vector. If Zero-based is selected, an index of 0 specifies the first element of the input vector.

Dependencies

This parameter is enabled only if **Enable indexing** is selected.

Programmatic Use

Parameter: IndexMode

Type: character vector

Values: 'Zero-based' | 'One-based'

Default: 'One-based'

Index Option — Index method for subelements

Index vector (dialog) (default) | Select all | Index vector (port) | Starting index (dialog) | Starting index (port)

Define, by dimension, how the subelements of the selected data store element are to be indexed.

From the list, select:

| Menu Item | Action |
|-------------------------|--|
| Select all | All subelements are read. |
| Index vector (dialog) | Enables the Index column. Enter a vector containing the indices of subelements to be read. |
| Index vector (port) | The relevant index port defines the indices of subelements to be read. |
| Starting index (dialog) | Enables the Index and Output Size columns. Enter the starting index and size of the range of subelements to be read. |

| Menu Item | Action |
|-----------------------|---|
| Starting index (port) | Enables the Output Size column. The relevant index port defines the starting index of the range of elements to be read. Enter the size of the range. |

The **Index** and **Output Size** columns are displayed as relevant.

Dependencies

This parameter is enabled only if **Enable indexing** is selected.

Programmatic Use

Parameter: IndexOptionArray

Type: character vector

Values: 'Select all' | 'Index vector (dialog)' | 'Index vector (port)' | 'Starting index (dialog)' | 'Starting index (port)'

Default: 'Index vector (dialog)'

Index — Indices or starting index of subelements

1 (default) | integer | vector of integers

If the **Index Option** is `Index vector (dialog)`, enter a vector containing the indices of each subelement to read.

If the **Index Option** is `Starting index (dialog)`, enter the starting index of the range of subelements to read.

Dependencies

This parameter is enabled only if **Enable indexing** is selected and the **Index Option** for the dimension is `Index vector (dialog)` or `Starting index (dialog)`.

Programmatic Use

Parameter: IndexParamArray

Type: character vector

Values: cell array

Default: '{ }'

Output Size — Size of range of subelements to read

1 (default) | integer

If the **Index Option** is `Starting index (dialog)` or `Starting index (port)`, enter the size of the range of subelements to read.

Dependencies

This parameter is enabled only if **Enable indexing** is selected and the **Index Option** for the dimension is `Starting index (dialog)` or `Starting index (port)`.

Programmatic Use

Block Parameter: OutputSizeArray

Type: character vector

Values: cell array

Default: '{ }'

Block Characteristics

| | |
|---------------------------------|--|
| Data Types | Boolean bus double enumerated fixed point half integer single string |
| Direct Feedthrough | no |
| Multidimensional Signals | yes |
| Variable-Size Signals | no |
| Zero-Crossing Detection | no |

Extended Capabilities

C/C++ Code Generation

Generate C and C++ code using Simulink® Coder™.

Fixed-Point Conversion

Design and simulate fixed-point systems using Fixed-Point Designer™.

See Also

Data Store Memory | Data Store Write

Topics

“Data Stores”

“Rename Data Stores”

“Order Data Store Access”

“Access Data Stores with Simulink Blocks”

“Data Store Diagnostics”

Introduced before R2006a

Data Store Write

Write data to data store

Library: Simulink / Signal Routing



Description

The Data Store Write block copies the value at its input to the named data store. Each write operation performed by a Data Store Write block writes over the data store or a selected portion thereof and replaces the previous contents.

The data store to which this block writes is determined by the location of the Data Store Memory block or signal object that defines the data store. For more information, see “Data Stores” and Data Store Memory. The size of the data store is set by the signal object or the Data Store Memory block that defines and initializes the data store. Each Data Store Write block that writes to that data store can write up to the amount of data in the data store.

More than one Data Store Write block can write to the same data store. However, if two Data Store Write blocks attempt to write to the same data store during the same simulation step, results are unpredictable.

Obtaining correct results from data stores requires ensuring that data store reads and writes occur in the expected order. For details, see “Order Data Store Access” and “Data Store Diagnostics”.

You can log the values of a local or global data store data variable for all the steps in a simulation. For details, see “Log Data Stores”.

You can select a Data Store Read, Data Store Write, or Data Store Memory block to highlight blocks related to it. To show a related block in an open diagram or new tab, pause on the ellipsis that

appears after selection. Then, select **Related Blocks**  from the action bar. When multiple blocks correspond to the selected block, a list of related blocks opens. You can filter the list of related blocks by entering a search term in the text box. After you select a related block from the list, window focus goes to the open diagram or new tab that shows the related block.

Ports

Input

Port_1 — Values to write to data store

scalar | vector | matrix | N-D array

Values to write to the specified data store. The Data Store Write block accepts a real or complex signal.

You can use an array of buses with a Data Store Write block. For details about defining and using an array of buses, see “Group Nonvirtual Buses in Arrays of Buses”.

To assign a subset of the bus or matrix elements to the associated data store, use the **Element Assignment** pane. The Data Store Write block icon reflects the elements that you specify. For details, see “Accessing Specific Bus and Matrix Elements”.

Data Types: `single` | `double` | `half` | `int8` | `int16` | `int32` | `int64` | `uint8` | `uint16` | `uint32` | `uint64` | `Boolean` | `fixed point` | `enumerated` | `bus`

IdxN — Nth index signal

scalar | vector

External port specifying an index for the assignment of the corresponding data store subelements.

Dependencies

To enable an external index port, on the **Element Assignment** tab, select **Enable indexing**. Then, in the Nth row of the **Index Option** table, set **Index Option** to `Index vector (port)` or `Starting index (port)`.

Data Types: `int8` | `int16` | `int32` | `uint8` | `uint16`

Parameters

Parameters

Data store name — Name of data store to which block writes

A (default) | name of data store

Specify the name of the data store to which this block writes data. The adjacent list provides the names of Data Store Memory blocks that exist at the same level in the model as the Data Store Write block or at higher levels. The list also includes all `Simulink.Signal` objects in the base and model workspaces. To change the name, select a name from the list or enter the name directly in the edit field.

When compiling a model containing this block, Simulink searches the model upwards from the level of the block for a Data Store Memory block having the specified data store name. If Simulink does not find such a block, it searches the model workspace and the MATLAB workspace for a `Simulink.Signal` object having the same name. If Simulink finds a signal object, it creates a hidden Data Store Memory block at the root level of the model with the properties specified by the signal object and an initial value set to an array of zeros. The dimensions of that array are inherited from the `Dimensions` property of the signal object.

If Simulink finds neither the Data Store Memory block nor the signal object, it halts the compilation and displays an error. See “Symbol Resolution” for more information about the search path.

Programmatic Use

Block Parameter: `DataStoreName`

Type: character vector

Values: data store name

Default: 'A'

Data store memory block — Data Store Memory block name

block path

This property is read-only.

This field lists the Data Store Memory block that initialized the store to which this block writes.

Corresponding Data Store Read blocks – List of corresponding Data Store Read blocks block path

This property is read-only.

This field lists the path to all Data Store Read blocks with the same data store name as this block that are in the same (sub)system or in any subsystem below it in the model hierarchy. Click any entry in this list to highlight the corresponding block in your model.

Sample time – Sample time

-1 (default) | scalar | vector

The sample time, which controls when the block writes to the data store. A value of -1 indicates that the sample time is inherited. See “Specify Sample Time” for more information.

Programmatic Use

Block Parameter: SampleTime

Type: character vector

Values: scalar | vector

Default: '-1'

Element Assignment

Elements in the array (Signals in the bus) – Elements in associated data store

character vector (no default)

List of elements in the associated data store. For data stores with arrays, you can write the whole data store, or you can assign one or more elements to the whole data store. For data stores with a bus data type, you can expand the tree to view and select the bus elements. The list displays the maximum dimensions for each element in parentheses.

If **Enable indexing** is not selected, select an element and use one of the following approaches:

- Click **Select>>** to display that element and all its subelements in the **Selected element(s)** list.
- Use the **Specify element(s) to assign** edit box to specify the subelements that you want to select for writing. Then click **Select>>**.

To select multiple elements, repeat the above procedure for each element.

Alternatively, you can select **Enable indexing**, then select a single element and specify the subelements dynamically using the **Index Option** parameter.

To refresh the display and reflect modifications to the array or bus used in the data store, click **Refresh**.

Dependencies

The prompt for this section (**Elements in the array** or **Signals in the bus**) depends on the type of data in the data store.

Programmatic Use**Block Parameter:** DataStoreElements**Type:** character vector**Values:** pound-delimited list of elements (See “Specification using the command line”.)**Default:** ''**Specify element(s) to assign — MATLAB expression defining the elements to assign**

character vector (no default)

Enter a MATLAB expression to define the specific element that you want to write, then click **Select>>** to add the element to the **Assigned element(s)** table. Repeat to select additional elements.

For example, for a data store named DSM that has maximum dimensions of [3,5], you could enter expressions such as DSM(2,4) or DSM([1 3],2) in the edit box. See “Accessing Specific Bus and Matrix Elements”.

To apply the element selection, click **OK** or **Apply**.

Dependencies

The **Specify element(s) to assign** edit box appears only if **Enable indexing** is not selected.

Programmatic Use**Block Parameter:** DataStoreElements**Type:** character vector**Values:** pound-delimited list of elements (See “Specification using the command line”.)**Default:** ''**Assigned element(s) — List of selected elements**

character vector (no default)

Elements that you select for assignment. The Data Store Write block icon displays an input port for each element that you specify.

To change the order of bus or matrix elements in the list, select the element in the list and click **Up** or **Down**. Changing the order of the elements in the list changes the order of the ports. To remove an element, click **Remove**.

Dependencies

The **Assigned element(s)** table appears only if **Enable indexing** is not selected.

Programmatic Use**Block Parameter:** DataStoreElements**Type:** character vector**Values:** pound-delimited list of elements (See “Specification using the command line”.)**Default:** ''**Enable indexing — Enable indexing to specify subelements of data store element to write**

'off' (default) | 'on'

Select this parameter to enable indexing similar to that used by the Assignment block, whereby you can dynamically specify indices of subelements to write by using one or more index input ports, as well as specifying indices by using the block dialog. A Data Store Write block can write to only a single element of a data store (that is, a single signal in a bus) when this parameter is selected. To

write to multiple elements of a data store using dynamic indexing, use multiple Data Store Write blocks.

Clear this parameter to disable Assignment block-style indexing. You can select multiple data store elements to write, but you can specify which subelements to write only by using the block dialog.

Note Do not select **Enable indexing** if the associated data store contains only a single, scalar element.

Programmatic Use

Block Parameter: EnableIndexing

Type: character vector

Values: 'off' | 'on'

Default: 'off'

Number of dimensions — Number of dimensions of data store element

1 (default) | positive integer

Number of dimensions of selected data store element. You must explicitly indicate this number.

Dependencies

This parameter is enabled only if **Enable indexing** is selected.

Programmatic Use

Block Parameter: NumberOfDimensions

Type: character vector

Values: positive integer

Default: '1'

Index mode — Index mode

One-based (default) | Zero-based

Select the indexing mode. If One-based is selected, an index of 1 specifies the first element of the input vector. If Zero-based is selected, an index of 0 specifies the first element of the input vector.

Dependencies

This parameter is enabled only if **Enable indexing** is selected.

Programmatic Use

Parameter: IndexMode

Type: character vector

Values: 'Zero-based' | 'One-based'

Default: 'One-based'

Index Option — Index method for subelements

Index vector (dialog) (default) | Select all | Index vector (port) | Starting index (dialog) | Starting index (port)

Define, by dimension, how the subelements of the selected data store element are to be indexed. From the list, select:

| Menu Item | Action |
|-------------------------|---|
| Select all | Disables the Index column. All subelements are assigned. |
| Index vector (dialog) | Enables the Index column. Enter a vector containing the indices of subelements to be assigned values. |
| Index vector (port) | Disables the Index column. The relevant index port defines the indices of subelements to be assigned values. |
| Starting index (dialog) | Enables the Index column. Enter the starting index of the range of subelements to be assigned values. The size of the range is inherited from the size of relevant dimension of the input data signal. |
| Starting index (port) | Disables the Index column. The relevant index port defines the starting index of the range of elements to be assigned values. The size of the range is inherited from the size of relevant dimension of the input data signal. |

The **Index** column is displayed as relevant.

Dependencies

This parameter is enabled only if **Enable indexing** is selected.

Programmatic Use

Parameter: IndexOptionArray

Type: character vector

Values: 'Select all' | 'Index vector (dialog)' | 'Index vector (port)' | 'Starting index (dialog)' | 'Starting index (port)'

Default: 'Index vector (dialog)'

Index — Indices or starting index of subelements

1 (default) | integer | vector of integers

If the **Index Option** is `Index vector (dialog)`, enter a vector containing the indices of each subelement to write.

If the **Index Option** is `Starting index (dialog)`, enter the starting index of the range of subelements to write.

Dependencies

This parameter is enabled only if **Enable indexing** is selected and the **Index Option** for the dimension is `Index vector (dialog)` or `Starting index (dialog)`.

Programmatic Use

Parameter: IndexParamArray

Type: character vector

Values: cell array

Default: '{ }'

Block Characteristics

| | |
|---------------------------------|--|
| Data Types | Boolean bus double enumerated fixed point half integer single string |
| Direct Feedthrough | no |
| Multidimensional Signals | yes |
| Variable-Size Signals | no |
| Zero-Crossing Detection | no |

Extended Capabilities

C/C++ Code Generation

Generate C and C++ code using Simulink® Coder™.

Fixed-Point Conversion

Design and simulate fixed-point systems using Fixed-Point Designer™.

See Also

Data Store Memory | Data Store Read

Topics

“Data Stores”

“Rename Data Stores”

“Order Data Store Access”

“Access Data Stores with Simulink Blocks”

“Log Data Stores”

“Data Store Diagnostics”

Introduced before R2006a

Data Type Conversion

Convert input signal to specified data type

Library: Simulink / Commonly Used Blocks
 Simulink / Signal Attributes
 HDL Coder / Commonly Used Blocks
 HDL Coder / HDL Floating Point Operations
 HDL Coder / Signal Attributes

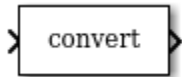

Description

The Data Type Conversion block converts an input signal of any Simulink data type to the data type that you specify.

Note To control the output data type by specifying block parameters, or to inherit a data type from a downstream block, use the Data Type Conversion block. To inherit a data type from a different signal in the model, use the Data Type Conversion Inherited block.

Convert Fixed-Point Signals

When you convert between fixed-point data types, the **Input and output to have equal** parameter controls block behavior. This parameter does not change the behavior of the block when:

- The input and output do not have a fixed-point data type.
- The input or output has a fixed-point data type with trivial scaling.

For more information about fixed-point numbers, see “Fixed-Point Numbers in Simulink” (Fixed-Point Designer).

To convert a signal from one data type to another by attempting to preserve the real-world value of the input signal, select **Real World Value (RWV)**, the default setting. The block accounts for the limits imposed by the scaling of the input and output and attempts to generate an output of equal real-world value.

To change the real-world value of the input signal by performing a scaling reinterpretation of the stored integer value, select **Stored Integer (SI)**. Within the limits of the specified data types, the block attempts to preserve the stored integer value of the signal during conversion. A best practice is to specify input and output data types using the same word length and signedness. Doing so ensures that the block changes only the scaling of the signal. Specifying a different signedness or word length for the input and output could produce unexpected results such as range loss or unexpected sign extensions. For an example, see “Convert Data Types in Simulink Models” on page 12-121.

If you select **Stored Integer (SI)**, the block does not perform a lower-level bit reinterpretation of a floating-point input signal. For example, if the input is `single` and has value 5, the bits that store the input in memory are given in hexadecimal by the following command.

```
num2hex(single(5))
```

40a00000

However, the Data Type Conversion block does not treat the stored integer value as 40a00000, but instead as the real-world value, 5. After conversion, the stored integer value of the output is 5.

Cast Enumerated Signals

Use a Data Type Conversion block to cast enumerated signals as follows:

- 1 To cast a signal of enumerated type to a signal of any numeric type.

The underlying integers of all enumerated values input to the Data Type Conversion block must be within the range of the numeric type. Otherwise, an error occurs during simulation.

- 2 To cast a signal of any integer type to a signal of enumerated type.

The value input to the Data Type Conversion block must match the underlying value of an enumerated value. Otherwise, an error occurs during simulation.

You can enable the **Saturate on integer overflow** parameter so that Simulink uses the default value of the enumerated type when the value input to the block does not match the underlying value of an enumerated value. See “Type Casting for Enumerations” (Simulink Coder).

You cannot use a Data Type Conversion block in these cases:

- To cast a noninteger numeric signal to an enumerated signal.
- To cast a complex signal to an enumerated signal, regardless of the data types of the real and imaginary parts of the complex signal.

See “Simulink Enumerations” for information on working with enumerated types.

Ports

Input

Port_1 — Input signal

scalar | vector | matrix | N-D array

Input signal, specified as a scalar, vector, matrix, or N-D array. The input can be any real- or complex-valued signal. If the input is real, the output is real. If the input is complex, the output is complex. The block converts the input signal to the **Output data type** you specify.

When you are converting fixed-point data types, use the **Input and output to have equal** parameter to determine whether the conversion happens based on the Real World Value (RWV) or Stored Integer (SI) value of the signal. For more information, see “Convert Fixed-Point Signals” on page 1-235.

Data Types: single | double | half | int8 | int16 | int32 | int64 | uint8 | uint16 | uint32 | uint64 | Boolean | fixed point | enumerated

Output

Port_1 — Output signal

scalar | vector | matrix | N-D array

Output signal, converted to the data type you specify, with the same dimensions as the input signal.

Data Types: `single` | `double` | `half` | `int8` | `int16` | `int32` | `int64` | `uint8` | `uint16` | `uint32` | `uint64` | `Boolean` | `fixed point` | `enumerated`

Parameters

Output minimum — Minimum output value for range checking

`[]` (default) | scalar

Lower value of the output range that Simulink checks.

Simulink uses the minimum to perform:

- Parameter range checking (see “Specify Minimum and Maximum Values for Block Parameters”) for some blocks.
- Simulation range checking (see “Specify Signal Ranges” and “Enable Simulation Range Checking”).
- Automatic scaling of fixed-point data types.
- Optimization of the code that you generate from the model. This optimization can remove algorithmic code and affect the results of some simulation modes such as SIL or external mode. For more information, see “Optimize using the specified minimum and maximum values” (Embedded Coder).

Note **Output minimum** does not saturate or clip the actual output signal. Use the Saturation block instead.

Programmatic Use

Block Parameter: `OutMin`

Type: character vector

Values: `'[]'` | scalar

Default: `'[]'`

Output maximum — Maximum output value for range checking

`[]` (default) | scalar

Upper value of the output range that Simulink checks.

Simulink uses the maximum value to perform:

- Parameter range checking (see “Specify Minimum and Maximum Values for Block Parameters”) for some blocks.
- Simulation range checking (see “Specify Signal Ranges” and “Enable Simulation Range Checking”).
- Automatic scaling of fixed-point data types.
- Optimization of the code that you generate from the model. This optimization can remove algorithmic code and affect the results of some simulation modes such as SIL or external mode. For more information, see “Optimize using the specified minimum and maximum values” (Embedded Coder).

Note **Output maximum** does not saturate or clip the actual output signal. Use the Saturation block instead.

Programmatic Use**Block Parameter:** OutMax**Type:** character vector**Values:** '[]' | scalar**Default:** '[]'**Output data type — Output data type**

Inherit: Inherit via back propagation (default) | double | single | half | int8 | uint8 | int16 | uint16 | int32 | uint32 | int64 | uint64 | boolean | fixdt(1,16) | fixdt(1,16,0) | fixdt(1,16,2^0,0) | Enum: <class name> | <data type expression>

Choose the data type for the output. The type can be inherited, specified directly, or expressed as a data type object such as Simulink.NumericType.

Programmatic Use**Block Parameter:** OutDataTypeStr**Type:** character vector

Values: 'Inherit: Inherit via back propagation' | 'double' | 'single' | 'half' | 'int8' | 'uint8' | 'int16' | 'uint16' | 'int32' | 'uint32' | 'int64' | 'uint64' | 'fixdt(1,16)' | 'fixdt(1,16,0)' | 'fixdt(1,16,2^0,0)' | 'Enum: <class name>' | <data type expression>

Default: 'Inherit: Inherit via back propagation'**Lock output data type setting against changes by the fixed-point tools — Prevent fixed-point tools from overriding Output data type**

off (default) | on

Select this parameter to prevent the fixed-point tools from overriding the **Output** data type you specify on the block. For more information, see “Use Lock Output Data Type Setting” (Fixed-Point Designer).

Programmatic Use**Block Parameter:** LockScale**Type:** character vector**Values:** 'off' | 'on'**Default:** 'off'**Input and output to have equal — Constraint for converting fixed-point data types**

Real World Value (RWV) (default) | Stored Integer (SI)

Specify which type of input and output must be equal, in the context of fixed-point data representation.

- Real World Value (RWV) — Specifies the goal of making the Real World Value (RWV) of the input equal to the Real World Value (RWV) of the output.
- Stored Integer (SI) — Specifies the goal of making the Stored Integer (SI) value of the input equal to the Stored Integer (SI) value of the output.

Programmatic Use**Block Parameter:** ConvertRealWorld**Type:** character vector**Values:** 'Real World Value (RWV)' | 'Stored Integer (SI)'**Default:** 'Real World Value (RWV)'

Integer rounding mode — Specify the rounding mode for fixed-point operations

Floor (default) | Ceiling | Convergent | Nearest | Round | Simplest | Zero

Choose one of these rounding modes.

Ceiling

Rounds both positive and negative numbers toward positive infinity. Equivalent to the MATLAB `ceil` function.

Convergent

Rounds number to the nearest representable value. If a tie occurs, rounds to the nearest even integer. Equivalent to the Fixed-Point Designer `convergent` function.

Floor

Rounds both positive and negative numbers toward negative infinity. Equivalent to the MATLAB `floor` function.

Nearest

Rounds number to the nearest representable value. If a tie occurs, rounds toward positive infinity. Equivalent to the Fixed-Point Designer `nearest` function.

Round

Rounds number to the nearest representable value. If a tie occurs, rounds positive numbers toward positive infinity and rounds negative numbers toward negative infinity. Equivalent to the Fixed-Point Designer `round` function.

Simplest

Automatically chooses between round toward floor and round toward zero to generate rounding code that is as efficient as possible.

Zero

Rounds number toward zero. Equivalent to the MATLAB `fix` function.

Programmatic Use

Block Parameter: `RndMeth`

Type: character vector

Values: `'Ceiling'` | `'Convergent'` | `'Floor'` | `'Nearest'` | `'Round'` | `'Simplest'` | `'Zero'`

Default: `'Floor'`

See Also

For more information, see “Rounding” (Fixed-Point Designer).

Saturate on integer overflow — Method of overflow action

off (default) | on

Specify whether overflows saturate or wrap.

- `off` — Overflows wrap to the appropriate value that the data type can represent.

For example, the number 130 does not fit in a signed 8-bit integer and wraps to -126.

- `on` — Overflows saturate to either the minimum or maximum value that the data type can represent.

For example, an overflow associated with a signed 8-bit integer can saturate to -128 or 127.

Tip

- Consider selecting this check box when your model has a possible overflow and you want explicit saturation protection in the generated code.
- Consider clearing this check box when you want to optimize efficiency of your generated code.

Clearing this check box also helps you to avoid overspecifying how a block handles out-of-range signals. For more information, see “Troubleshoot Signal Range Errors”.

- When you select this check box, saturation applies to every internal operation on the block, not just the output or result.
- In general, the code generation process can detect when overflow is not possible. In this case, the code generator does not produce saturation code.

Programmatic Use

Block Parameter: SaturateOnIntegerOverflow

Type: character vector

Values: 'off' | 'on'

Default: 'off'

Sample time — Specify sample time as a value other than -1

-1 (default) | scalar | vector

Specify the sample time as a value other than -1. For more information, see “Specify Sample Time”.

Dependencies

This parameter is not visible unless it is explicitly set to a value other than -1. To learn more, see “Blocks for Which Sample Time Is Not Recommended”.

Programmatic Use

Block Parameter: SampleTime

Type: character vector

Values: scalar or vector

Default: '-1'

Block Characteristics

| | |
|---------------------------------|---|
| Data Types | Boolean double enumerated fixed point half integer single |
| Direct Feedthrough | yes |
| Multidimensional Signals | yes |
| Variable-Size Signals | yes |
| Zero-Crossing Detection | no |

Extended Capabilities**C/C++ Code Generation**

Generate C and C++ code using Simulink® Coder™.

HDL Code Generation

Generate Verilog and VHDL code for FPGA and ASIC designs using HDL Coder™.

HDL Coder provides additional configuration options that affect HDL implementation and synthesized logic.

Note If you use double data types in your model, use this block for conversion between double and single data types. You cannot use the block to convert between double and fixed-point data types.

HDL Architecture

This block has a single, default HDL architecture.

HDL Block Properties

| General | |
|----------------------------------|--|
| ConstrainedOutputPipeline | Number of registers to place at the outputs by moving existing delays within your design. Distributed pipelining does not redistribute these registers. The default is 0. For more details, see “ConstrainedOutputPipeline” (HDL Coder). |
| InputPipeline | Number of input pipeline stages to insert in the generated code. Distributed pipelining and constrained output pipelining can move these registers. The default is 0. For more details, see “InputPipeline” (HDL Coder). |
| OutputPipeline | Number of output pipeline stages to insert in the generated code. Distributed pipelining and constrained output pipelining can move these registers. The default is 0. For more details, see “OutputPipeline” (HDL Coder). |

Note With the HDL Code Advisor, you can replace Data Type Conversion blocks that use the Stored Integer (SI) mode and convert between floating-point and fixed-point data types with Float Typecast blocks.

| Native Floating Point | |
|------------------------------|--|
| LatencyStrategy | Specify whether to map the blocks in your design to <code>inherit</code> , <code>Max</code> , <code>Min</code> , <code>Zero</code> , or <code>Custom</code> for the floating-point operator. The default is <code>inherit</code> . See also “LatencyStrategy” (HDL Coder). |
| NFPCustomLatency | To specify a value, set LatencyStrategy to <code>Custom</code> . HDL Coder adds latency equal to the value that you specify for the NFPCustomLatency setting. See also “NFPCustomLatency” (HDL Coder). |

Enumeration Data Support

This block supports code generation for enumerated signals. Use this block to cast a signal of an enumerated type to any integer type or to cast a signal of any integer type to an enumerated type.

Complex Data Support

This block supports code generation for complex signals.

Restrictions

If you configure a Data Type Conversion block for double to fixed-point conversion or fixed-point to double conversion, a warning is displayed during code generation.

PLC Code Generation

Generate Structured Text code using Simulink® PLC Coder™.

Fixed-Point Conversion

Design and simulate fixed-point systems using Fixed-Point Designer™.

See Also

[Data Type Conversion Inherited](#) | [Data Type Propagation](#) | [Data Type Scaling Strip](#)

Topics

[“Control Data Types of Signals”](#)

[“About Data Types in Simulink”](#)

[“Simulink Enumerations”](#)

[“Fixed Point”](#)

Introduced before R2006a

Data Type Conversion Inherited

Convert from one data type to another using inherited data type and scaling

Library: Simulink / Signal Attributes



Description

The Data Type Conversion Inherited block converts one input to the data type and scaling of the other input. The first input is used as the reference signal. The second input, **u**, is converted to the reference type by inheriting the data type and scaling information. (For a description of the port order for various block orientations, see “Port Location After Rotating or Flipping”.)

Inheriting the data type and scaling provides these advantages:

- It makes reusing existing models easier.
- It allows you to create new fixed-point models with less effort since you can avoid the detail of specifying the associated parameters.

Ports

Input

Port_1 – Reference signal

scalar | vector | matrix | N-D array

Reference signal, defining the data type used to convert input signal **u**.

Data Types: single | double | half | int8 | int16 | int32 | int64 | uint8 | uint16 | uint32 | uint64 | Boolean | fixed point | enumerated

u – Input signal to convert

scalar | vector | matrix | N-D array

Input signal to convert to the reference data type, specified as a scalar, vector, matrix, or N-D array.

Data Types: single | double | half | int8 | int16 | int32 | int64 | uint8 | uint16 | uint32 | uint64 | Boolean | fixed point | enumerated

Output

y – Output signal

scalar | vector | matrix | N-D array

Output is the input signal **u**, converted to the reference data type.

Data Types: single | double | half | int8 | int16 | int32 | int64 | uint8 | uint16 | uint32 | uint64 | Boolean | fixed point | enumerated

Parameters

Input and Output to have equal — Constraint for converting fixed-point data types

Real World Value (RWV) (default) | Stored Integer (SI)

Specify which type of input and output must be equal, in the context of fixed-point data representation.

- Real World Value (RWV) — Specifies the goal of making the Real World Value (RWV) of the input equal to the Real World Value (RWV) of the output.
- Stored Integer (SI) — Specifies the goal of making the Stored Integer (SI) value of the input equal to the Stored Integer (SI) value of the output.

Programmatic Use

Block Parameter: ConvertRealWorld

Type: character vector

Values: 'Real World Value (RWV)' | 'Stored Integer (SI)'

Default: 'Real World Value (RWV)'

Integer rounding mode — Rounding mode for fixed-point operations

Floor (default) | Ceiling | Convergent | Nearest | Round | Simplest | Zero

Specify the rounding mode for fixed-point operations. For more information, see “Rounding” (Fixed-Point Designer).

Programmatic Use

Block Parameter: RndMeth

Type: character vector

Values: 'Ceiling' | 'Convergent' | 'Floor' | 'Nearest' | 'Round' | 'Simplest' | 'Zero'

Default: 'Floor'

Saturate to max or min when overflows occur — Method of overflow action

off (default) | on

When you select this check box, overflows saturate to the maximum or minimum value that the data type can represent. Otherwise, overflows wrap.

When you select this check box, saturation applies to every internal operation on the block, not just the output or result. In general, the code generation process can detect when overflow is not possible. In this case, the code generator does not produce saturation code.

Programmatic Use

Block Parameter: DoSatur

Type: character vector

Values: 'off' | 'on'

Default: 'off'

Block Characteristics

| | |
|---------------------------|---|
| Data Types | Boolean double enumerated fixed point half integer single |
| Direct Feedthrough | yes |

| | |
|---------------------------------|-----|
| Multidimensional Signals | yes |
| Variable-Size Signals | yes |
| Zero-Crossing Detection | no |

Extended Capabilities

C/C++ Code Generation

Generate C and C++ code using Simulink® Coder™.

Fixed-Point Conversion

Design and simulate fixed-point systems using Fixed-Point Designer™.

See Also

Data Type Conversion | Data Type Propagation

Topics

“Control Data Types of Signals”

“About Data Types in Simulink”

“Fixed Point”

Introduced before R2006a

Data Type Duplicate

Force all inputs to same data type

Library: Simulink / Signal Attributes
HDL Coder / Signal Attributes



Description

The Data Type Duplicate block forces all inputs to have the same data type. Other attributes of input signals, such as dimension, complexity, and sample time, are independent.

You can use the Data Type Duplicate block to check for consistency of data types among blocks. If all signals do not have the same data type, the block returns an error message.

The Data Type Duplicate block is typically used such that one signal to the block controls the data type for all other blocks. The other blocks are set to inherit their data types via backpropagation.

The block can also be useful in a user created library. These library blocks can be placed in any model, and the data type for all library blocks are configured according to the usage in the model. To create a library block with more complex data type rules than duplication, use the Data Type Propagation block.

Ports

Input

Port_1 — First input signal

scalar | vector | matrix | N-D array

First input signal, specified as a scalar, vector, matrix, or N-D array. If all signals do not have the same data type, the block returns an error message.

Data Types: single | double | half | int8 | int16 | int32 | uint8 | uint16 | uint32 | string | Boolean | fixed point | enumerated

Port_N — Nth input signal

scalar | vector | matrix | N-D array

Nth input signal, specified as a scalar, vector, matrix, or N-D array. If all signals do not have the same data type, the block returns an error message.

Data Types: single | double | half | int8 | int16 | int32 | uint8 | uint16 | uint32 | string | Boolean | fixed point | enumerated

Parameters

Number of input ports — Number of block inputs

2 (default) | real-valued positive integer

Specify the number of inputs to this block as a real-valued positive integer.

Programmatic Use

Block Parameter: NumInputPorts

Type: character vector

Values: real-valued positive integer

Default: '2'

Block Characteristics

| | |
|---------------------------------|--|
| Data Types | Boolean bus double enumerated fixed point half integer single string |
| Direct Feedthrough | no |
| Multidimensional Signals | yes |
| Variable-Size Signals | yes |
| Zero-Crossing Detection | no |

Extended Capabilities

C/C++ Code Generation

Generate C and C++ code using Simulink® Coder™.

HDL Code Generation

Generate Verilog and VHDL code for FPGA and ASIC designs using HDL Coder™.

HDL Coder provides additional configuration options that affect HDL implementation and synthesized logic.

HDL Architecture

This block can be used to force inputs to have same data type in subsystems that generate code, but is not included in the hardware implementation.

PLC Code Generation

Generate Structured Text code using Simulink® PLC Coder™.

Fixed-Point Conversion

Design and simulate fixed-point systems using Fixed-Point Designer™.

See Also

Data Type Conversion | Data Type Propagation

Topics

“Control Data Types of Signals”

“About Data Types in Simulink”

“Fixed Point”

Introduced before R2006a

Data Type Propagation

Set data type and scaling of propagated signal based on information from reference signals

Library: Simulink / Signal Attributes
HDL Coder / Signal Attributes



Description

The Data Type Propagation block allows you to control the data type and scaling of signals in your model. You can use this block along with fixed-point blocks that have their **Output data type** parameter configured to **Inherit: Inherit via back propagation**.

The block has three inputs: **Ref1** and **Ref2** are the reference inputs, while the **Prop** input back-propagates the data type and scaling information gathered from the reference inputs. This information is then passed on to other fixed-point blocks.

The block provides many choices for propagating data type and scaling information. For example, you can use:

- The number of bits from the **Ref1** reference signal or the number of bits from widest reference signal
- The range from the **Ref2** reference signal or the range of the reference signal with the greatest range
- A bias of zero, regardless of the biases used by the reference signals
- The precision of the reference signal with the least precision

You specify how data type information is propagated using the **Propagated data type** parameter:

- If you select **Specify via dialog**, then you manually specify the data type via the **Propagated data type** edit field.
- If you select **Inherit via propagation rule**, then you must use the parameters described in "Parameters" on page 1-250.

You specify how scaling information is propagated using the **Propagated scaling** parameter:

- If you select **Specify via dialog**, then you manually specify the scaling via the **Propagated scaling** edit field.
- If you select **Inherit via propagation rule**, then you must use the parameters described in "Parameters" on page 1-250.

After you use the information from the reference signals, you can apply a second level of adjustments to the data type and scaling. To do so, use individual multiplicative and additive adjustments. This flexibility has various uses. For example, if you are targeting a DSP, then you can configure the block

so that the number of bits associated with a multiply and accumulate (MAC) operation is twice as wide as the input signal, and has a specific number of guard bits added to it.

The Data Type Propagation block also provides a mechanism to force the computed number of bits to a useful value. For example, if you are targeting a 16-bit micro, then the target C compiler is likely to support sizes of only 8 bits, 16 bits, and 32 bits. The block forces these three choices to be used. For example, suppose that the block computes a data type size of 24 bits. Since 24 bits is not directly usable by the target chip, the signal is forced up to 32 bits, which is natively supported.

There is also a method for dealing with floating-point reference signals. This method makes it easier to create designs that are easily retargeted between fixed-point chips and floating-point chips.

The Data Type Propagation block allows you to set up libraries of useful subsystems that are properly configured based on the connected signals. Without this data type propagation process, subsystems from a library are unlikely to work as desired with most integer or fixed-point signals. Manual intervention would be required to configure the data type and scaling. In many situations, this block can eliminate the manual intervention.

Precedence Rules

The precedence of the dialog box parameters decreases from top to bottom. Also:

- Double-precision reference inputs have precedence over all other data types.
- Single-precision reference inputs have precedence over integer and fixed-point data types.
- Multiplicative adjustments are carried out before additive adjustments.
- The number of bits is determined before the precision or positive range is inherited from the reference inputs.
- PosRange is one bit higher than the exact maximum positive range of the signal.
- The computed number-of-bits are promoted to the smallest allowable value that is greater than or equal to the computation. If none exists, then the block returns an error.

Ports

Input

Ref1 — First reference signal

scalar | vector | matrix | N-D array

First reference signal, from which to gather data type and scaling information.

Data Types: single | double | half | int8 | int16 | int32 | int64 | uint8 | uint16 | uint32 | uint64 | Boolean | fixed point

Ref2 — Second reference signal

scalar | vector | matrix | N-D array

Second reference signal from which to gather data type and scaling information.

Data Types: single | double | half | int8 | int16 | int32 | int64 | uint8 | uint16 | uint32 | uint64 | Boolean | fixed point

Prop — Propagated data type and scaling

data type and scaling

Data type and scaling information, back-propagated to the model. After the block gathers data type and scaling information from the reference signals, you can apply a second level of adjustments to the data type and scaling. To do so, specify individual multiplicative and additive adjustments in the block dialog box.

Data Types: `single` | `double` | `half` | `int8` | `int16` | `int32` | `int64` | `uint8` | `uint16` | `uint32` | `uint64` | `fixed point`

Parameters

Propagated Type

1. Propagated data type — Mode of specifying propagated data type

`Inherit via propagation rule` (default) | `Specify via dialog`

Specify whether to propagate the data type via the dialog box, or inherit the data type from the reference signals.

Dependencies

Setting this parameter to `Specify via dialog` enables the **1.1. Propagated data type (e.g. `fixdt(1,16)`, `fixdt('single')`)**.

Programmatic Use

Block Parameter: `PropDataTypeMode`

Type: character vector

Values: `'Specify via dialog'` | `'Inherit via propagation rule'`

Default: `'Inherit via propagation rule'`

1.1. Propagated data type (e.g. `fixdt(1,16)`, `fixdt('single')`) — Propagated data type

`fixdt(1,16)` (default) | data type string

Specify the data type to propagate.

Dependencies

To enable this parameter, set **1. Propagated data type** to `Specify via dialog`.

Programmatic Use

Block Parameter: `PropDataTypeMode`

Type: character vector

Values: `'Specify via dialog'` | `'Inherit via propagation rule'`

Default: `'Inherit via propagation rule'`

1.1 If any reference input is double, output is — Output data type when a reference input is double

`double` (default) | `single`

Specify the output data type as `single` or `double`. This parameter makes it easier to create designs that are easily retargeted between fixed-point chips and floating-point chips.

Dependencies

To enable this parameter, set **Propagated data type** to `Inherit via propagation rule`.

Programmatic Use**Block Parameter:** IfRefDouble**Type:** character vector**Values:** 'double' | 'single'**Default:** 'double'**1.2 If any reference input is single, output is – Output data type when a reference input is single**

single (default) | double

Specify the output data type as `single` or `double`. This parameter makes it easier to create designs that are easily retargeted between fixed-point chips and floating-point chips.

Dependencies

To enable this parameter, set **Propagated data type** to `Inherit` via propagation rule.

Programmatic Use**Block Parameter:** IfRefSingle**Type:** character vector**Values:** 'double' | 'single'**Default:** 'single'**1.3 Is-Signed – Signedness of propagated data type**

IsSigned1 or IsSigned2 (default) | IsSigned1 | IsSigned2 | TRUE | FALSE

Specify the sign of **Prop** as one of the following values.

| Parameter Value | Description |
|------------------------|---|
| IsSigned1 | Prop is a signed data type if Ref1 is a signed data type. |
| IsSigned2 | Prop is a signed data type if Ref2 is a signed data type. |
| IsSigned1 or IsSigned2 | Prop is a signed data type if either Ref1 or Ref2 are signed data types. |
| TRUE | Ref1 and Ref2 are ignored, and Prop is always a signed data type. |
| FALSE | Ref1 and Ref2 are ignored, and Prop is always an unsigned data type. |

For example, if the **Ref1** signal is `ufix(16)`, the **Ref2** signal is `sfix(16)`, and the **Is-Signed** parameter is `IsSigned1 or IsSigned2`, then **Prop** is forced to be a signed data type.

Dependencies

To enable this parameter, set **Propagated data type** to `Inherit` via propagation rule.

Programmatic Use**Block Parameter:** IsSigned**Type:** character vector**Values:** 'IsSigned1' | 'IsSigned2' | 'IsSigned1 or IsSigned2' | 'TRUE' | 'FALSE'**Default:** 'IsSigned1 or IsSigned2'**1.4.1 Number-of-bits: Base – Number of bits for the base of the propagated data type**

$$\max([\text{NumBits1 } \text{NumBits2}]) \text{ (default) } | \text{NumBits1} | \text{NumBits2} | \min([\text{NumBits1 } \text{NumBits2}]) | \text{NumBits1} + \text{NumBits2}$$

Specify the number of bits used by **Prop** for the base data type as one of the following values.

| Parameter Value | Description |
|--------------------------|---|
| NumBits1 | The number of bits for Prop is given by the number of bits for Ref1 . |
| NumBits2 | The number of bits for Prop is given by the number of bits for Ref2 . |
| max([NumBits1 NumBits2]) | The number of bits for Prop is given by the reference signal with largest number of bits. |
| min([NumBits1 NumBits2]) | The number of bits for Prop is given by the reference signal with smallest number of bits. |
| NumBits1+NumBits2 | The number of bits for Prop is given by the sum of the reference signal bits. |

For more information about the base data type, refer to Targeting an Embedded Processor (Fixed-Point Designer).

Dependencies

To enable this parameter, set **Propagated data type** to `Inherit` via propagation rule.

Programmatic Use

Block Parameter: NumBitsBase

Type: character vector

Values: 'NumBits1' | 'NumBits2' | 'max([NumBits1 NumBits2])' | 'min([NumBits1 NumBits2])' | 'NumBits1+NumBits2'

Default: 'max([NumBits1 NumBits2])'

1.4.2 Number-of-bits: Multiplicative adjustment — Number of bits for multiplicative adjustment of propagated data type

1 (default) | positive integer

Specify the number of bits used by **Prop** by including a multiplicative adjustment that uses a data type of `double`. For example, suppose that you want to guarantee that the number of bits associated with a multiply and accumulate (MAC) operation is twice as wide as the input signal. To do this, set this parameter to 2.

Dependencies

To enable this parameter, set **Propagated data type** to `Inherit` via propagation rule.

Programmatic Use

Block Parameter: NumBitsMult

Type: character vector

Values: positive integer

Default: '1'

1.4.3 Number-of-bits: Additive adjustment — Number of bits for additive adjustment of propagated data type

0 (default) | positive integer

Specify the number of bits used by **Prop** by including an additive adjustment that uses a data type of `double`. For example, if you are performing multiple additions during a MAC operation, the result could overflow. To prevent overflow, you can associate guard bits with the propagated data type. To associate four guard bits, you specify the value 4.

Dependencies

To enable this parameter, set **Propagated data type** to `Inherit` via propagation rule.

Programmatic Use

Block Parameter: `NumBitsAdd`

Type: character vector

Values: scalar

Default: `'0'`

1.4.4 Number-of-bits: Allowable final values — Allowable number of bits in propagated data type

`'1:128'` (default) | scalar or vector of positive integers

Force the computed number of bits used by **Prop** to a useful value. For example, if you are targeting a processor that supports only 8 bits, 16 bits, and 32 bits, then you configure this parameter to `[8,16,32]`. The block always propagates the smallest specified value that fits. If you want to allow all fixed-point data types, you would specify the value `1:128`.

Dependencies

To enable this parameter, set **Propagated data type** to `Inherit` via propagation rule.

Programmatic Use

Block Parameter: `NumBitsAllowFinal`

Type: character vector

Values: scalar or vector of positive integers

Default: `'1:128'`

Propagated Scaling**2. Propagated scaling — Propagated scaling mode**

`Inherit via propagation rule` (default) | `Specify via dialog` | `Obtain via best precision`

Choose to propagate the scaling via the dialog box, inherit the scaling from the reference signals, or calculate the scaling to obtain best precision.

Programmatic Use

Block Parameter: `PropScalingMode`

Type: character vector

Values: `Inherit via propagation rule` | `Specify via dialog` | `Obtain via best precision`

Default: `Inherit via propagation rule`

2.1. Propagated scaling (Slope or [Slope Bias]) — Slope or slope and bias

`2^-10` | `Slope` | `[Slope Bias]`

Specify the scaling as either a slope or a slope and bias.

Dependencies

To enable this parameter, set **Propagated scaling** to `Specify via dialog`.

Programmatic Use

Block Parameter: `PropScaling`

Type: character vector
Values: Slope | [Slope Bias]
Default: '2^-10'

2.1. Values used to determine best precision scaling — Values to constrain precision

[5 -7] (default)

Specify any values to be used to constrain the precision, such as the upper and lower limits on the propagated input. Based on the data type, the block selects a scaling such that these values can be represented with no overflow error and minimum quantization error.

Dependencies

To enable this parameter, set **Propagated scaling** to Obtain via best precision.

Programmatic Use

Block Parameter: ValuesUsedBestPrec

Type: character vector

Values: vector of values

Default: '[5 -7]'

2.1.1. Slope: Base — Slope for base of the propagated data type

min([Slope1 Slope2]) (default) | Slope1 | Slope2 | min([Slope1 Slope2]) | max([Bias1 Bias2]) | Slope1*Slope2 | Slope1/Slope2 | PosRange1 | PosRange2 | max([PosRange1 PosRange2]) | min([PosRange1 PosRange2]) | PosRange1*PosRange2 | PosRange1/PosRange2

Specify the slope used by **Prop** for the base data type as one of the following values.

| Parameter Value | Description |
|----------------------------|---|
| Slope1 | The slope of Prop is given by the slope of Ref1 . |
| Slope2 | The slope of Prop is given by the slope of Ref2 . |
| max([Slope1 Slope2]) | The slope of Prop is given by the maximum slope of the reference signals. |
| min([Slope1 Slope2]) | The slope of Prop is given by the minimum slope of the reference signals. |
| Slope1*Slope2 | The slope of Prop is given by the product of the reference signal slopes. |
| Slope1/Slope2 | The slope of Prop is given by the ratio of the Ref1 slope to the Ref2 slope. |
| PosRange1 | The range of Prop is given by the range of Ref1 . |
| PosRange2 | The range of Prop is given by the range of Ref2 . |
| max([PosRange1 PosRange2]) | The range of Prop is given by the maximum range of the reference signals. |
| min([PosRange1 PosRange2]) | The range of Prop is given by the minimum range of the reference signals. |
| PosRange1*PosRange2 | The range of Prop is given by the product of the reference signal ranges. |

| Parameter Value | Description |
|---------------------|---|
| PosRange1/PosRange2 | The range of Prop is given by the ratio of the Ref1 range to the Ref2 range. |

You control the precision of **Prop** with `Slope1` and `Slope2`, and you control the range of **Prop** with `PosRange1` and `PosRange2`. Also, `PosRange1` and `PosRange2` are one bit higher than the maximum positive range of the associated reference signal.

Dependencies

To enable this parameter, set **Propagated scaling** to `Inherit` via propagation rule.

Programmatic Use

Block Parameter: `SlopeBase`

Type: character vector

Values: `'Slope1'` | `'Slope2'` | `'max([Slope1 Slope2])'` | `'min([Slope1 Slope2])'` | `'Slope1*Slope2'` | `'Slope1/Slope2'` | `'PosRange1'` | `'PosRange2'` | `'max([PosRange1 PosRange2])'` | `'min([PosRange1 PosRange2])'` | `'PosRange1*PosRange2'` | `'PosRange1/PosRange2'`

Default: `'min([Slope1 Slope2])'`

2.1.2. Slope: Multiplicative adjustment — Slope of multiplicative adjustment of propagated data type

1 (default) | scalar

Specify the slope used by **Prop** by including a multiplicative adjustment that uses a data type of `double`. For example, if you want 3 bits of additional precision (with a corresponding decrease in range), the multiplicative adjustment is 2^{-3} .

Dependencies

To enable this parameter, set **Propagated scaling** to `Inherit` via propagation rule.

Programmatic Use

Block Parameter: `SlopeMult`

Type: character vector

Values: scalar

Default: `'1'`

2.1.3. Slope: Additive adjustment — Slope of additive adjustment of propagated data type

0 (default) | scalar

Specify the slope used by **Prop** by including an additive adjustment that uses a data type of `double`. An additive slope adjustment is often not needed. The most likely use is to set the multiplicative adjustment to 0, and set the additive adjustment to force the final slope to a specified value.

Dependencies

To enable this parameter, set **Propagated scaling** to `Inherit` via propagation rule.

Programmatic Use

Block Parameter: `SlopeAdd`

Type: character vector

Values: scalar

Default: '0'

2.2.1. Bias: Base — Base bias for Prop

Bias1 (default) | Bias2 | max([Bias1 Bias2]) | min([Bias1 Bias2]) | Bias1*Bias2 | Bias1/Bias2 | Bias1+Bias2 | Bias1-Bias2

Specify the bias used by **Prop** for the base data type. The parameter values are described as follows:

| Parameter Value | Description |
|--------------------|--|
| Bias1 | The bias of Prop is given by the bias of Ref1 . |
| Bias2 | The bias of Prop is given by the bias of Ref2 . |
| max([Bias1 Bias2]) | The bias of Prop is given by the maximum bias of the reference signals. |
| min([Bias1 Bias2]) | The bias of Prop is given by the minimum bias of the reference signals. |
| Bias1*Bias2 | The bias of Prop is given by the product of the reference signal biases. |
| Bias1/Bias2 | The bias of Prop is given by the ratio of the Ref1 bias to the Ref2 bias. |
| Bias1+Bias2 | The bias of Prop is given by the sum of the reference biases. |
| Bias1-Bias2 | The bias of Prop is given by the difference of the reference biases. |

Dependencies

To enable this parameter, set **Propagated scaling** to `Inherit` via propagation rule.

Programmatic Use

Block Parameter: BiasBase

Type: character vector

Values: 'Bias1' | 'Bias2' | 'max([Bias1 Bias2])' | 'min([Bias1 Bias2])' | 'Bias1*Bias2' | 'Bias1/Bias2' | 'Bias1+Bias2' | 'Bias1-Bias2'

Default: 'Bias1'

2.2.2. Bias: Multiplicative adjustment — Multiplicative bias for propagated data type

1 (default) | scalar

Specify the bias used by Prop by including a multiplicative adjustment that uses a data type of `double`.

This parameter is visible only when you set **Propagated scaling** to `Inherit` via propagation rule.

Programmatic Use

Block Parameter: BiasMult

Type: character vector

Values: scalar

Default: '1'

2.3.2. Bias: Additive adjustment — Additive bias for propagated data type

0 (default) | scalar

Specify the bias used by **Prop** by including an additive adjustment that uses a data type of double.

If you want to guarantee that the bias associated with **Prop** is zero, configure both the multiplicative adjustment and the additive adjustment to 0.

Dependencies

To enable this parameter, set **Propagated scaling** to Inherit via propagation rule.

Programmatic Use

Block Parameter: BiasAdd

Type: character vector

Values: scalar

Default: '0'

Block Characteristics

| | |
|---------------------------------|--|
| Data Types | Boolean double fixed point half integer single |
| Direct Feedthrough | no |
| Multidimensional Signals | yes |
| Variable-Size Signals | yes |
| Zero-Crossing Detection | no |

Extended Capabilities

C/C++ Code Generation

Generate C and C++ code using Simulink® Coder™.

HDL Code Generation

Generate Verilog and VHDL code for FPGA and ASIC designs using HDL Coder™.

HDL Coder provides additional configuration options that affect HDL implementation and synthesized logic.

HDL Architecture

This block can be used to control scaling and data types of signals that are part of subsystems that generate HDL code, but is not included in the hardware implementation.

Fixed-Point Conversion

Design and simulate fixed-point systems using Fixed-Point Designer™.

See Also

Data Type Conversion | Data Type Duplicate | Data Type Conversion Inherited

Topics

“Control Data Types of Signals”

“About Data Types in Simulink”

“Fixed Point”

Introduced before R2006a

Data Type Scaling Strip

Remove scaling and map to built in integer

Library: Simulink / Signal Attributes

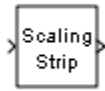

Description

The Data Type Scaling Strip block strips the scaling off a fixed-point signal. It maps the input data type to the smallest built-in data type that has enough data bits to hold the input. The stored integer value of the input is the value of the output. The output always has nominal scaling (slope = 1.0 and bias = 0.0), so the output does not distinguish between real world value and stored integer value.

Ports

Input

Port_1 — Input signal

scalar | vector | matrix

Input signal, specified as a scalar, vector, or matrix. The block strips the scaling off a fixed-point input signal, and outputs the stored integer value with the smallest possible built-in data type.

Data Types: single | double | int8 | int16 | int32 | int64 | uint8 | uint16 | uint32 | uint64 | Boolean | fixed point

Output

Port_1 — Input signal mapped to built-in data type

scalar | vector | matrix

Stored integer value of the input signal with the smallest possible built-in data type, and the same dimensions as the input.

Data Types: single | double | int8 | int16 | int32 | uint8 | uint16 | uint32

Block Characteristics

| | |
|---------------------------------|---|
| Data Types | Boolean double fixed point integer single |
| Direct Feedthrough | yes |
| Multidimensional Signals | yes |
| Variable-Size Signals | yes |

| | |
|--------------------------------|----|
| Zero-Crossing Detection | no |
|--------------------------------|----|

Extended Capabilities

C/C++ Code Generation

Generate C and C++ code using Simulink® Coder™.

Fixed-Point Conversion

Design and simulate fixed-point systems using Fixed-Point Designer™.

See Also

[Data Type Conversion](#) | [Data Type Duplicate](#) | [Data Type Propagation](#)

Topics

[“About Data Types in Simulink”](#)

[“Fixed Point”](#)

Introduced before R2006a

Dead Zone

Provide region of zero output

Library: Simulink / Discontinuities
HDL Coder / Discontinuities

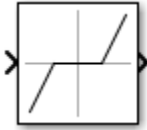

Description

The Dead Zone block generates zero output within a specified region, called its dead zone. You specify the lower limit (LL) and upper limit (UL) of the dead zone as the **Start of dead zone** and **End of dead zone** parameters. The block output depends on the input (U) and the values for the lower and upper limits.

| Input | Output |
|-----------------------------|----------|
| $U \geq LL$ and $U \leq UL$ | Zero |
| $U > UL$ | $U - UL$ |
| $U < LL$ | $U - LL$ |

Ports

Input

Port_1 — Input signal

scalar | vector

Input signal to the dead-zone algorithm.

Data Types: single | double | int8 | int16 | int32 | int64 | uint8 | uint16 | uint32 | uint64 | fixed point

Output

Port_1 — Output signal

scalar | vector

Output signal after the dead-zone algorithm is applied to the input signal.

Data Types: single | double | int8 | int16 | int32 | int64 | uint8 | uint16 | uint32 | uint64 | fixed point

Parameters

Start of dead zone — Specify the lower bound of the dead zone

'-0.5' (default) | scalar | vector

Specify dead zone lower limit. Set the value for **Start of dead zone** less than or equal to **End of dead zone**. When the input value is less than **Start of dead zone**, then the block shifts the output value down by the **Start of dead zone** value.

Programmatic Use

Block Parameter: LowerValue

Type: character vector

Value: scalar or vector less than or equal to UpperValue.

Default: '-0.5'

End of dead zone — Specify the upper limit of the dead zone

'0.5' (default) | scalar | vector

Specify dead zone upper limit. Set the value for **End of dead zone** greater than or equal to **Start of dead zone**. When the input value is greater than **End of dead zone**, then the block shifts the output value down by the **End of dead zone** value.

Programmatic Use

Block Parameter: UpperValue

Type: character vector

Value: scalar or vector greater than or equal to LowerValue.

Default: '0.5'

Saturate on integer overflow — Choose the behavior when integer overflow occurs

off (default) | on

| Action | Reasons for Taking This Action | What Happens for Overflows | Example |
|------------------------|--|---|--|
| Select this check box. | Your model has possible overflow, and you want explicit saturation protection in the generated code. | Overflows saturate to either the minimum or maximum value that the data type can represent. | The maximum value that the <code>int8</code> (signed, 8-bit integer) data type can represent is 127. Any block operation result greater than this maximum value causes overflow of the 8-bit integer. With the check box selected, the block output saturates at 127. Similarly, the block output saturates at a minimum output value of -128. |

| Action | Reasons for Taking This Action | What Happens for Overflows | Example |
|-------------------------------|--|---|---|
| Do not select this check box. | <p>You want to optimize efficiency of your generated code.</p> <p>You want to avoid overspecifying how a block handles out-of-range signals. For more information, see “Troubleshoot Signal Range Errors”.</p> | Overflows wrap to the appropriate value that is representable by the data type. | The maximum value that the <code>int8</code> (signed, 8-bit integer) data type can represent is 127. Any block operation result greater than this maximum value causes overflow of the 8-bit integer. With the check box cleared, the software interprets the overflow-causing value as <code>int8</code> , which can produce an unintended result. For example, a block result of 130 (binary 1000 0010) expressed as <code>int8</code> , is -126. |

When you select this check box, saturation applies to every internal operation on the block, not just the output or result. Usually, the code generation process can detect when overflow is not possible. In this case, the code generator does not produce saturation code.

Programmatic Use

Block Parameter: DoSatur

Type: character vector

Value: 'off' | 'on'

Default: 'off'

Treat as gain when linearizing – Specify the gain value

On (default) | boolean

The linearization commands in Simulink software treat this block as a gain in state space. Select this check box to cause the commands to treat the gain as 1. Clear the box to have the commands treat the gain as 0.

Programmatic Use

Block Parameter: LinearizeAsGain

Type: character vector

Value: 'off' | 'on'

Default: 'on'

Enable zero-crossing detection – Enable zero-crossing detection

on (default) | Boolean

Select to enable zero-crossing detection. For more information, see “Zero-Crossing Detection” in the Simulink documentation.

Programmatic Use

Block Parameter: ZeroCross

Type: character vector, string

Values: 'off' | 'on'

Default: 'on'

Sample time — Specify sample time as a value other than -1

-1 (default) | scalar | vector

Specify the sample time as a value other than -1. For more information, see “Specify Sample Time”.

Dependencies

This parameter is not visible unless it is explicitly set to a value other than -1. To learn more, see “Blocks for Which Sample Time Is Not Recommended”.

Programmatic Use**Block Parameter:** SampleTime**Type:** character vector**Values:** scalar or vector**Default:** '-1'**Block Characteristics**

| | |
|---------------------------------|---|
| Data Types | double fixed point integer single |
| Direct Feedthrough | yes |
| Multidimensional Signals | no |
| Variable-Size Signals | no |
| Zero-Crossing Detection | yes |

Extended Capabilities**C/C++ Code Generation**

Generate C and C++ code using Simulink® Coder™.

HDL Code Generation

Generate Verilog and VHDL code for FPGA and ASIC designs using HDL Coder™.

HDL Coder provides additional configuration options that affect HDL implementation and synthesized logic.

HDL Architecture

This block has a single, default HDL architecture.

HDL Block Properties

| | |
|----------------------------------|--|
| ConstrainedOutputPipeline | Number of registers to place at the outputs by moving existing delays within your design. Distributed pipelining does not redistribute these registers. The default is 0. For more details, see “ConstrainedOutputPipeline” (HDL Coder). |
| InputPipeline | Number of input pipeline stages to insert in the generated code. Distributed pipelining and constrained output pipelining can move these registers. The default is 0. For more details, see “InputPipeline” (HDL Coder). |

| | |
|-----------------------|--|
| OutputPipeline | Number of output pipeline stages to insert in the generated code. Distributed pipelining and constrained output pipelining can move these registers. The default is 0. For more details, see “OutputPipeline” (HDL Coder). |
|-----------------------|--|

Fixed-Point Conversion

Design and simulate fixed-point systems using Fixed-Point Designer™.

See Also

Dead Zone Dynamic | Backlash

Introduced before R2006a

Dead Zone Dynamic

Provide dynamic region of zero output

Library: Simulink / Discontinuities
HDL Coder / Discontinuities

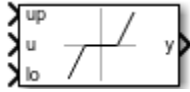

Description

The Dead Zone Dynamic block generates a region of zero output based on dynamic input signals that specify the upper and lower limit. The block output depends on the input **u**, and the values of the input signals **up** and **lo**.

| Input | Output |
|-----------------------------|----------|
| $u \geq lo$ and $u \leq up$ | Zero |
| $u > up$ | $u - up$ |
| $u < lo$ | $u - lo$ |

The Dead Zone Dynamic block is a masked subsystem and does not have any parameters.

Ports

Input

u — Input signal

scalar | vector

Input signal to the dead zone algorithm.

Data Types: single | double | int8 | int16 | int32 | int64 | uint8 | uint16 | uint32 | uint64 | fixed point

lo — Lower limit for the dead zone

scalar | vector

Dynamic value providing the lower bound of the region of zero output. When the input is less than **lo** then the output value is shifted down by value of **lo**.

Data Types: single | double | int8 | int16 | int32 | int64 | uint8 | uint16 | uint32 | uint64 | fixed point

up — Upper limit for the dead zone

scalar

Dynamic value providing the upper bound of the region of zero output. When the input is greater than **up** then the output value is shifted down by value of **up**.

Data Types: single | double | int8 | int16 | int32 | int64 | uint8 | uint16 | uint32 | uint64 | fixed point

Output

y — Output signal

scalar | vector

Output signal after the dynamic dead zone algorithm is applied to the input signal.

Data Types: single | double | int8 | int16 | int32 | int64 | uint8 | uint16 | uint32 | uint64 | fixed point

Block Characteristics

| | |
|---------------------------------|---|
| Data Types | double fixed point integer single |
| Direct Feedthrough | no |
| Multidimensional Signals | no |
| Variable-Size Signals | no |
| Zero-Crossing Detection | no |

Extended Capabilities

C/C++ Code Generation

Generate C and C++ code using Simulink® Coder™.

HDL Code Generation

Generate Verilog and VHDL code for FPGA and ASIC designs using HDL Coder™.

HDL Coder provides additional configuration options that affect HDL implementation and synthesized logic.

HDL Architecture

This block has a single, default HDL architecture.

HDL Block Properties

| | |
|----------------------------------|--|
| ConstrainedOutputPipeline | Number of registers to place at the outputs by moving existing delays within your design. Distributed pipelining does not redistribute these registers. The default is 0. For more details, see “ConstrainedOutputPipeline” (HDL Coder). |
| InputPipeline | Number of input pipeline stages to insert in the generated code. Distributed pipelining and constrained output pipelining can move these registers. The default is 0. For more details, see “InputPipeline” (HDL Coder). |
| OutputPipeline | Number of output pipeline stages to insert in the generated code. Distributed pipelining and constrained output pipelining can move these registers. The default is 0. For more details, see “OutputPipeline” (HDL Coder). |

PLC Code Generation

Generate Structured Text code using Simulink® PLC Coder™.

Fixed-Point Conversion

Design and simulate fixed-point systems using Fixed-Point Designer™.

See Also

Dead Zone | Triggered Subsystem

Introduced before R2006a

Decrement Real World

Decrease real-world value of signal by one

Library: Simulink / Additional Math & Discrete / Additional Math:
Increment - Decrement
HDL Coder / Math Operations



Description

The Decrement Real World block decreases the real-world value of the signal by one. Overflows always wrap.

Ports

Input

Port_1 – Input signal

scalar | vector | matrix

Input signal, specified as a scalar, vector, or matrix.

Data Types: single | double | int8 | int16 | int32 | int64 | uint8 | uint16 | uint32 | uint64 | fixed point

Output

Port_1 – Output signal

scalar | vector | matrix

Output is the real-world value of the input signal decreased by one. Overflows always wrap. The output has the same data type and dimensions as the input.

Data Types: single | double | int8 | int16 | int32 | int64 | uint8 | uint16 | uint32 | uint64 | fixed point

Block Characteristics

| | |
|---------------------------------|---|
| Data Types | double fixed point integer single |
| Direct Feedthrough | no |
| Multidimensional Signals | no |
| Variable-Size Signals | yes |

| | |
|--------------------------------|----|
| Zero-Crossing Detection | no |
|--------------------------------|----|

Extended Capabilities

C/C++ Code Generation

Generate C and C++ code using Simulink® Coder™.

The code generator does not explicitly group primitive blocks that constitute a nonatomic masked subsystem block in the generated code. This flexibility allows for more efficient code generation. In certain cases, you can achieve grouping by configuring the masked subsystem block to execute as an atomic unit by selecting the **Treat as atomic unit** option.

HDL Code Generation

Generate Verilog and VHDL code for FPGA and ASIC designs using HDL Coder™.

HDL Coder provides additional configuration options that affect HDL implementation and synthesized logic.

HDL Architecture

This block has a single, default HDL architecture.

HDL Block Properties

| | |
|----------------------------------|--|
| ConstrainedOutputPipeline | Number of registers to place at the outputs by moving existing delays within your design. Distributed pipelining does not redistribute these registers. The default is 0. For more details, see “ConstrainedOutputPipeline” (HDL Coder). |
| InputPipeline | Number of input pipeline stages to insert in the generated code. Distributed pipelining and constrained output pipelining can move these registers. The default is 0. For more details, see “InputPipeline” (HDL Coder). |
| OutputPipeline | Number of output pipeline stages to insert in the generated code. Distributed pipelining and constrained output pipelining can move these registers. The default is 0. For more details, see “OutputPipeline” (HDL Coder). |

Fixed-Point Conversion

Design and simulate fixed-point systems using Fixed-Point Designer™.

See Also

Decrement Stored Integer | Decrement Time To Zero | Decrement To Zero | Increment Real World

Topics

“Fixed-Point Numbers”

Introduced before R2006a

Decrement Stored Integer

Decrease stored integer value of signal by one

Library: Simulink / Additional Math & Discrete / Additional Math:
Increment - Decrement
HDL Coder / Math Operations



Description

The Decrement Stored Integer block decreases the stored integer value of a signal by one.

Floating-point signals also decrease by one, and overflows always wrap.

Ports

Input

Port_1 — Input signal

scalar | vector | matrix

Input signal, specified as a scalar, vector, or matrix.

Data Types: single | double | int8 | int16 | int32 | int64 | uint8 | uint16 | uint32 | uint64 | fixed point

Output

Port_1 — Output signal

scalar | vector | matrix

Output is the stored integer value of the input signal decreased by one. Floating-point signals also decrease by one, and overflows always wrap. The output has the same data type and dimensions as the input.

Data Types: single | double | int8 | int16 | int32 | int64 | uint8 | uint16 | uint32 | uint64 | fixed point

Block Characteristics

| | |
|---------------------------------|---|
| Data Types | double fixed point integer single |
| Direct Feedthrough | no |
| Multidimensional Signals | no |
| Variable-Size Signals | yes |

| | |
|--------------------------------|----|
| Zero-Crossing Detection | no |
|--------------------------------|----|

Extended Capabilities

C/C++ Code Generation

Generate C and C++ code using Simulink® Coder™.

The code generator does not explicitly group primitive blocks that constitute a nonatomic masked subsystem block in the generated code. This flexibility allows for more efficient code generation. In certain cases, you can achieve grouping by configuring the masked subsystem block to execute as an atomic unit by selecting the **Treat as atomic unit** option.

HDL Code Generation

Generate Verilog and VHDL code for FPGA and ASIC designs using HDL Coder™.

HDL Coder provides additional configuration options that affect HDL implementation and synthesized logic.

HDL Architecture

This block has a single, default HDL architecture.

HDL Block Properties

| | |
|----------------------------------|--|
| ConstrainedOutputPipeline | Number of registers to place at the outputs by moving existing delays within your design. Distributed pipelining does not redistribute these registers. The default is 0. For more details, see “ConstrainedOutputPipeline” (HDL Coder). |
| InputPipeline | Number of input pipeline stages to insert in the generated code. Distributed pipelining and constrained output pipelining can move these registers. The default is 0. For more details, see “InputPipeline” (HDL Coder). |
| OutputPipeline | Number of output pipeline stages to insert in the generated code. Distributed pipelining and constrained output pipelining can move these registers. The default is 0. For more details, see “OutputPipeline” (HDL Coder). |

Fixed-Point Conversion

Design and simulate fixed-point systems using Fixed-Point Designer™.

See Also

Decrement Real World | Decrement Time To Zero | Decrement To Zero | Increment Stored Integer

Topics

“Fixed-Point Numbers”

Introduced before R2006a

Decrement Time To Zero

Decrease real-world value of signal by sample time, but only to zero

Library: Simulink / Additional Math & Discrete / Additional Math:
Increment - Decrement

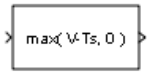

Description

The Decrement Time To Zero block decreases the real-world value of the signal by the sample time, T_s . The output never goes below zero.

Limitations

The Decrement Time To Zero block works only with fixed sample rates and does not work inside a triggered subsystem.

Ports

Input

Port_1 — Input signal

scalar | vector | matrix

Input signal, specified as a scalar, vector, or matrix.

Data Types: single | double | int8 | int16 | int32 | int64 | uint8 | uint16 | uint32 | uint64 | fixed point

Output

Port_1 — Output signal

scalar | vector | matrix

Output is the real-world value of the input signal decreased by the sample time, T_s . The output never goes below zero. The output has the same data type and dimensions as the input.

Data Types: single | double | int8 | int16 | int32 | int64 | uint8 | uint16 | uint32 | uint64 | fixed point

Block Characteristics

| | |
|---------------------------------|---|
| Data Types | double fixed point integer single |
| Direct Feedthrough | no |
| Multidimensional Signals | no |

| | |
|--------------------------------|----|
| Variable-Size Signals | no |
| Zero-Crossing Detection | no |

Extended Capabilities

C/C++ Code Generation

Generate C and C++ code using Simulink® Coder™.

Fixed-Point Conversion

Design and simulate fixed-point systems using Fixed-Point Designer™.

See Also

Decrement Real World | Decrement Stored Integer | Decrement To Zero

Topics

“Fixed-Point Numbers”

Introduced before R2006a

Decrement To Zero

Decrease real-world value of signal by one, but only to zero

Library: Simulink / Additional Math & Discrete / Additional Math:
Increment - Decrement

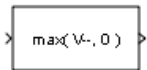

Description

The Decrement To Zero block decreases the real-world value of the signal by one. The output never goes below zero.

Ports

Input

Port_1 – Input signal

scalar | vector | matrix

Input signal, specified as a scalar, vector, or matrix.

Data Types: single | double | int8 | int16 | int32 | int64 | uint8 | uint16 | uint32 | uint64 | fixed point

Output

Port_1 – Output signal

scalar | vector | matrix

Output is the real-world value of the input signal decreased by one. The output never goes below zero. The output has the same data type and dimensions as the input.

Data Types: single | double | int8 | int16 | int32 | int64 | uint8 | uint16 | uint32 | uint64 | fixed point

Block Characteristics

| | |
|---------------------------------|---|
| Data Types | double fixed point integer single |
| Direct Feedthrough | no |
| Multidimensional Signals | no |
| Variable-Size Signals | no |
| Zero-Crossing Detection | no |

Extended Capabilities

C/C++ Code Generation

Generate C and C++ code using Simulink® Coder™.

The code generator does not explicitly group primitive blocks that constitute a nonatomic masked subsystem block in the generated code. This flexibility allows for more efficient code generation. In certain cases, you can achieve grouping by configuring the masked subsystem block to execute as an atomic unit by selecting the **Treat as atomic unit** option.

HDL Code Generation

Generate Verilog and VHDL code for FPGA and ASIC designs using HDL Coder™.

HDL Coder provides additional configuration options that affect HDL implementation and synthesized logic.

HDL Architecture

This block has a single, default HDL architecture.

HDL Block Properties

| | |
|----------------------------------|--|
| ConstrainedOutputPipeline | Number of registers to place at the outputs by moving existing delays within your design. Distributed pipelining does not redistribute these registers. The default is 0. For more details, see “ConstrainedOutputPipeline” (HDL Coder). |
| InputPipeline | Number of input pipeline stages to insert in the generated code. Distributed pipelining and constrained output pipelining can move these registers. The default is 0. For more details, see “InputPipeline” (HDL Coder). |
| OutputPipeline | Number of output pipeline stages to insert in the generated code. Distributed pipelining and constrained output pipelining can move these registers. The default is 0. For more details, see “OutputPipeline” (HDL Coder). |

Fixed-Point Conversion

Design and simulate fixed-point systems using Fixed-Point Designer™.

See Also

Decrement Real World | Decrement Stored Integer | Decrement Time To Zero

Topics

“Fixed-Point Numbers”

Introduced before R2006a

Delay

Delay input signal by fixed or variable sample periods

Library: Simulink / Commonly Used Blocks
 Simulink / Discrete
 HDL Coder / Commonly Used Blocks
 HDL Coder / Discrete



Description

The Delay block outputs the input of the block after a delay. The block determines the delay time based on the value of the **Delay length** parameter. The block supports:

- Variable delay length
- Specification of the initial condition from an input port
- State storage
- Using a circular buffer instead of an array buffer for state storage
- Resetting the state to the initial condition with an external reset signal
- Controlling execution of the block at every time step with an external enable signal

The initial block output depends on several factors such as the **Initial condition** parameter and the simulation start time. For more information, see “Initial Block Output” on page 1-277. The **External reset** parameter determines if the block output resets to the initial condition on triggering. The **Show enable port** parameter determines if the block execution is controlled in every time step by an external enable signal.

Initial Block Output

The output in the first few time steps of the simulation depends on the block sample time, the delay length, and the simulation start time. The block supports specifying or inheriting discrete sample times to determine the time interval between samples. For more information, see “Specify Sample Time”.

The table shows the Delay block output for the first few time steps with these settings. The block inherits a discrete sample time as $[T_{sampling}, T_{offset}]$, where $T_{sampling}$ is the sampling period and T_{offset} is the initial time offset. n is the value of the **Delay length** parameter and T_{start} is the simulation start time for the model

| Simulation Time Range | Block Output |
|---|------------------------------------|
| (T_{start}) to $(T_{start} + T_{offset})$ | Zero |
| $(T_{start} + T_{offset})$ to $(T_{start} + T_{offset} + n * T_{sampling})$ | Initial condition parameter |
| After $(T_{start} + T_{offset} + n * T_{sampling})$ | Input signal |

Behavior with External Enable Signal

Selecting the **Show enable port** check box enables the Enable port. If the enable port is enabled, the block operates in this order

- 1 Checks if the enable condition is satisfied.
- 2 If the reset port is enabled, checks the reset condition.
- 3 Performs the Delay block functionality.

The block has this operation with the Enable port:

- At the first block enable, the block output is the initial condition value ($x0$).
- For consecutive enable signals, the block takes the last state of the input signal u .
- If the port is not enabled at the start of simulation, the Delay block outputs 0 .
- During simulation, if the port becomes disabled after having been enabled, the block does not execute and holds its last value.

Variable-Size Support

The Delay block provides the following support for variable-size signals:

- The data input port u accepts variable-size signals. The other input ports do not accept variable-size signals.
- The output port has the same signal dimensions as the data input port u for variable-size inputs.

The rules that apply to variable-size signals depend on the input processing mode of the Delay block.

| Input Processing Mode | Rules for Variable-Size Signal Support |
|--|--|
| Elements as channels (sample based) | <ul style="list-style-type: none"> • The signal dimensions change only during state reset when the block is enabled. • The initial condition must be scalar. |
| Columns as channels (frame based) | <ul style="list-style-type: none"> • No support |

Bus Support

The Delay block provides the following support for bus signals:

- The data input u accepts virtual and nonvirtual bus signals. Other than input port $x0$, the other input ports do not accept bus signals.
- The initial condition $x0$ port accepts nonvirtual bus signals.
- The output port has the same bus type as the data input port u for bus inputs.
- Buses work with:
 - Sample-based and frame-based processing
 - Fixed and variable delay length
 - Array and circular buffers

To use a bus signal as the input to a Delay block, specify the initial condition on the dialog box or through the $x0$ port. Support for virtual and nonvirtual buses depends on the initial condition that

you specify and whether the **State name** parameter is empty or not. For the x0 input port, only nonvirtual buses are supported.

| Initial Condition | State Name | |
|-------------------|------------------------------------|-----------------------------|
| | Empty | Not Empty |
| Zero | Virtual and nonvirtual bus support | Nonvirtual bus support only |
| Nonzero scalar | Virtual and nonvirtual bus support | No bus support |
| Nonscalar | No bus support | No bus support |
| Structure | Virtual and nonvirtual bus support | Nonvirtual bus support only |
| Partial structure | Virtual and nonvirtual bus support | Nonvirtual bus support only |

String Support

The Delay block can accept and output string data type only if:

- The block is configured for the default value of the **Initial condition** parameter (0).
- The **Delay length** value is 1 or less.

Ports

Input

u — Data input signal

scalar | vector

Input data signal delayed according to parameters settings.

Data Types: half | single | double | int8 | int16 | int32 | int64 | uint8 | uint16 | uint32 | uint64 | string | Boolean | fixed point | enumerated | bus

d — Delay length

scalar

Delay length specified as inherited from an input port. Enabled when you select the **Delay length: Source** parameter as **Input port**.

Data Types: half | single | double | int8 | int16 | int32 | int64 | uint8 | uint16 | uint32 | uint64 | fixed point

Enable — External enable signal

scalar

Enable signal that enables or disables execution of the block. To create this port, select the **Show enable port** parameter.

Data Types: half | single | double | int8 | int16 | int32 | int64 | uint8 | uint16 | uint32 | uint64 | Boolean | fixed point

External reset — External reset signal

scalar

External signal that resets execution of the block to the initial condition. To create this port, select the **External reset** parameter.

Data Types: half | single | double | int8 | int16 | int32 | int64 | uint8 | uint16 | uint32 | uint64 | Boolean | fixed point

x0 — Initial condition

scalar | vector

Initial condition specified as inherited from an input port. Enabled when you select the **Initial Condition: Source** parameter as **Input port**.

Data Types: half | single | double | int8 | int16 | int32 | int64 | uint8 | uint16 | uint32 | uint64 | fixed point | bus

Output**Port_1 — Output signal**

scalar | vector

Output signal that is the input signal delayed by the length of time specified by the parameter **Delay length**. The initial value of the output signal depends on several conditions. See “Initial Block Output” on page 1-277.

Data Types: half | single | double | int8 | int16 | int32 | int64 | uint8 | uint16 | uint32 | uint64 | string | Boolean | fixed point | enumerated | bus

Parameters**Main****Delay length — Delay length**

Dialog (default) | Input port

Specify whether to enter the delay length directly on the dialog box (fixed delay) or to inherit the delay from an input port (variable delay).

- If you set **Source** to **Dialog**, enter the delay length in the edit field under **Value**.
- If you set **Source** to **Input port**, verify that an upstream signal supplies a delay length for the **d** input port. You can also specify its maximum value by specifying the parameter **Upper limit**.

Specify the scalar delay length as a real, non-negative integer. An out-of-range or non-integer value in the dialog box (fixed delay) returns an error. An out-of-range value from an input port (variable delay) casts it into the range. A noninteger value from an input port (variable delay) truncates it to the integer.

Programmatic Use**Block Parameter:** DelayLengthSource**Type:** character vector**Values:** 'Dialog' | 'Input port'**Default:** 'Dialog'**Block Parameter:** DelayLength

Type: character vector

Values: scalar

Default: '2'

Block Parameter: DelayLengthUpperLimit

Type: character vector

Values: scalar

Default: '100'

Initial condition — Initial condition

Dialog (default) | Input port

Specify whether to enter the initial condition directly on the dialog box or to inherit the initial condition from an input port.

- If you set **Source** to **Dialog**, enter the initial condition in the edit field under **Value**.
- If you set **Source** to **Input port**, verify that an upstream signal supplies an initial condition for the x_0 input port.

Simulink converts offline the data type of **Initial condition** to the data type of the input signal u using a round-to-nearest operation and saturation.

Note When **State name must resolve to Simulink signal object** is selected on the **State Attributes** pane, the block copies the initial value of the signal object to the **Initial condition** parameter. However, when the source for **Initial condition** is **Input port**, the block ignores the initial value of the signal object.

Programmatic Use

Block Parameter: InitialConditionSource

Type: character vector

Values: 'Dialog' | 'Input port'

Default: 'Dialog'

Block Parameter: InitialCondition

Type: character vector

Values: scalar

Default: '0.0'

Input processing — Specify sample- or frame-based processing

Elements as channels (sample based) (default) | Columns as channels (frame based)

Specify whether the block performs sample- or frame-based processing:

- **Columns as channels (frame based)** — Treat each column of the input as a separate channel (frame-based processing).

Note Frame-based processing requires a DSP System Toolbox license.

For more information, see “Sample- and Frame-Based Concepts” (DSP System Toolbox).

- **Elements as channels (sample based)** — Treat each element of the input as a separate channel (sample-based processing).

Use **Input processing** to specify whether the block performs sample- or frame-based processing. For more information about these two processing modes, see “Sample- and Frame-Based Concepts” (DSP System Toolbox).

Programmatic Use**Block Parameter:** InputProcessing**Type:** character vector**Values:** 'Columns as channels (frame based)' | 'Elements as channels (sample based)'**Default:** 'Elements as channels (sample based)'**Use circular buffer for state – Circular buffer for storing state**

off (default) | on

Select to use a circular buffer for storing the state in simulation and code generation. Otherwise, an array buffer stores the state.

Using a circular buffer can improve execution speed when the delay length is large. For an array buffer, the number of copy operations increases as the delay length goes up. For a circular buffer, the number of copy operations is constant for increasing delay length.

If one of the following conditions is true, an array buffer always stores the state because a circular buffer does not improve execution speed.

- For sample-based signals, the delay length is 1.
- For frame-based signals, the delay length is no larger than the frame size.

Programmatic Use**Block Parameter:** UseCircularBuffer**Type:** character vector**Values:** 'off' | 'on'**Default:** 'off'**Prevent direct feedthrough – Prevent direct feedthrough**

off (default) | on

Select to increase the delay length from zero to the lower limit for the **Input processing** mode.

- For sample-based signals, increase the minimum delay length to 1.
- For frame-based signals, increase the minimum delay length to the frame length.

Selecting this check box prevents direct feedthrough from the input port, *u*, to the output port. However, this check box cannot prevent direct feedthrough from the initial condition port, *x0*, to the output port.

Dependency

To enable this parameter, set **Delay length: Source** to Input port.

Programmatic Use**Block Parameter:** PreventDirectFeedthrough**Type:** character vector**Values:** 'off' | 'on'**Default:** 'off'

Remove delay length check in generated code – Remove delay length out-of-range check

off (default) | on

Select to remove code that checks for out-of-range delay length.

| Check Box | Result | When to Use |
|-----------|--|----------------------------------|
| Selected | Generated code does not include conditional statements to check for out-of-range delay length. | For code efficiency |
| Cleared | Generated code includes conditional statements to check for out-of-range delay length. | For safety-critical applications |

Dependency

To enable this parameter, set **Delay length: Source** to Input port.

Programmatic Use

Block Parameter: RemoveDelayLengthCheckInGeneratedCode

Type: character vector

Values: 'off' | 'on'

Default: 'off'

Diagnostic for delay length – Diagnostic checks for delay length

None (default) | Warning | Error

Specify whether to produce a warning or error when the input d is less than the lower limit or greater than the **Delay length: Upper limit**. The lower limit depends on the setting for **Prevent direct feedthrough**.

- If the check box is cleared, the lower limit is zero.
- If the check box is selected, the lower limit is 1 for sample-based signals and frame length for frame-based signals.

Options for the diagnostic include:

- None — Simulink software takes no action.
- Warning — Simulink software displays a warning and continues the simulation.
- Error — Simulink software terminates the simulation and displays an error.

Dependency

To enable this parameter, set **Delay length: Source** to Input port.

Programmatic Use

Block Parameter: DiagnosticForDelayLength

Type: character vector

Values: 'None' | 'Warning' | 'Error'

Default: 'None'

Show enable port – Create enable port

off (default) | on

Select to control execution of this block with an enable port. The block is considered enabled when the input to this port is nonzero, and is disabled when the input is 0. The value of the input is checked at the same time step as the block execution.

Programmatic Use

Block Parameter: ShowEnablePort

Type: character vector

Values: 'off' | 'on'

Default: 'off'

External reset — External state reset

None (default) | Rising | Falling | Either | Level | Level hold

Specify the trigger event to use to reset the states to the initial conditions.

| Reset Mode | Behavior |
|------------|--|
| None | No reset |
| Rising | Reset on a rising edge |
| Falling | Reset on a falling edge |
| Either | Reset on either a rising or falling edge |
| Level | Reset in either of these cases: <ul style="list-style-type: none"> When the reset signal is nonzero at the current time step When the reset signal value changes from nonzero at the previous time step to zero at the current time step |
| Level hold | Reset when the reset signal is nonzero at the current time step |

Programmatic Use

Block Parameter: ExternalReset

Type: character vector

Values: 'None' | 'Rising' | 'Falling' | 'Either' | 'Level' | 'Level hold'

Default: 'None'

Sample time (-1 for inherited) — Discrete interval between sample time hits

-1 (default) | scalar

Specify the time interval between samples. To inherit the sample time, set this parameter to -1. This block supports discrete sample time, but not continuous sample time.

Programmatic Use

Block Parameter: SampleTime

Type: character vector

Value: real scalar

Default: '-1'

State Attributes

State name — Unique name for block state

' ' (default) | alphanumeric string

Use this parameter to assign a unique name to the block state. The default is ' '. When this field is blank, no name is assigned. When using this parameter, remember these considerations:

- A valid identifier starts with an alphabetic or underscore character, followed by alphanumeric or underscore characters.
- The state name applies only to the selected block.

This parameter enables **State name must resolve to Simulink signal object** when you click **Apply**.

For more information, see “C Code Generation Configuration for Model Interface Elements” (Simulink Coder).

Programmatic Use

Block Parameter: StateName

Type: character vector

Values: unique name

Default: ' '

State name must resolve to Simulink signal object — Require state name resolve to a signal object

off (default) | on

Select this check box to require that the state name resolves to a Simulink signal object.

Dependencies

To enable this parameter, specify a value for **State name**. This parameter appears only if you set the model configuration parameter **Signal resolution** to a value other than None.

Programmatic Use

Block Parameter: StateMustResolveToSignalObject

Type: character vector

Values: 'off' | 'on'

Default: 'off'

Block Characteristics

| | |
|---------------------------------|--|
| Data Types | Boolean bus double enumerated fixed point half integer single string |
| Direct Feedthrough | yes |
| Multidimensional Signals | yes |
| Variable-Size Signals | yes |
| Zero-Crossing Detection | no |

Extended Capabilities

C/C++ Code Generation

Generate C and C++ code using Simulink® Coder™.

Generated code relies on `memcpy` or `memset` functions (`string.h`) under certain conditions.

HDL Code Generation

Generate Verilog and VHDL code for FPGA and ASIC designs using HDL Coder™.

HDL Coder provides additional configuration options that affect HDL implementation and synthesized logic.

| Block Parameter Setting | Description |
|--|--|
| Set External reset to <code>Level</code> . | Generates a reset port in the HDL code. |
| Select Show enable port . | Generates an enable port in the HDL code. |
| For Initial condition , set Source to <code>Dialog</code> and enter the value. | Specifies an initial condition for the block. |
| Set Input processing to <code>Columns</code> as channels (frame based) or <code>Elements</code> as channels (sample based). | Expects vector input data, where each element of the vector represents a sample in time. |

Additional Settings When Using State Control Block

If you use a State Control block with the Delay block inside a subsystem in your Simulink model, use these additional settings.

| Block Parameter Setting | Description |
|---|--|
| Set External reset to <code>Level hold</code> for Synchronous mode and <code>Level</code> for Classic mode of the State Control block. | Generates a reset port in the HDL code. |
| Set Delay length to zero for a Delay block with an external enable port. | Treated as a wire in only Synchronous mode of the State Control block. |
| Set Delay length to zero for a Delay block with an external reset port. | Treated as a wire in Synchronous and Classic modes of the State Control block. |

For more information about the State Control block, see [State Control \(HDL Coder\)](#).

HDL Architecture

This block has a single, default HDL architecture.

HDL Block Properties

| | |
|-----------------------|--|
| InputPipeline | Number of input pipeline stages to insert in the generated code. Distributed pipelining and constrained output pipelining can move these registers. The default is 0. For more details, see "InputPipeline" (HDL Coder). |
| OutputPipeline | Number of output pipeline stages to insert in the generated code. Distributed pipelining and constrained output pipelining can move these registers. The default is 0. For more details, see "OutputPipeline" (HDL Coder). |
| ResetType | Suppress reset logic generation. The default is <code>default</code> , which generates reset logic. See also "ResetType" (HDL Coder). |

| | |
|---------------|--|
| UseRAM | Map delays to RAM instead of registers. The default is off. See also "UseRAM" (HDL Coder). |
|---------------|--|

Complex Data Support

This block supports code generation for complex signals.

Restrictions

For **Initial condition** and **Delay length**, **Source** set to Input port is not supported for HDL code generation.

PLC Code Generation

Generate Structured Text code using Simulink® PLC Coder™.

Fixed-Point Conversion

Design and simulate fixed-point systems using Fixed-Point Designer™.

See Also

Resettable Delay | Unit Delay | Variable Integer Delay | Tapped Delay

Topics

"Using Enabled Subsystems"

Introduced before R2006a

Demux

Extract and output elements of virtual vector signal

Library: Simulink / Commonly Used Blocks
 Simulink / Signal Routing
 HDL Coder / Commonly Used Blocks
 HDL Coder / Signal Routing



Description

The Demux block extracts the components of an input vector signal and outputs separate signals. The output signal ports are ordered from top to bottom. For information about creating and decomposing vectors, see “Mux Signal”.

Ports

Input

Port_1 — Accept nonbus vector signal to extract and output signals from
 real or complex values of any nonbus data type supported by Simulink

Vector input signal from which the Demux block selects scalar signals or smaller vectors.

Data Types: single | double | half | int8 | int16 | int32 | int64 | uint8 | uint16 | uint32 | uint64 | Boolean | fixed point | enumerated

Output

Port_1 — Output signals extracted from input vector signal
 nonbus signal with real or complex values of any data type supported by Simulink

Output signals extracted from the input vector. The output signal ports are ordered from top to bottom. See “Port Location After Rotating or Flipping” for a description of the port order for various block orientations.

Data Types: single | double | half | int8 | int16 | int32 | int64 | uint8 | uint16 | uint32 | uint64 | Boolean | fixed point | enumerated

Parameters

Number of outputs — Number of outputs
 2 (default) | scalar | vector

Specify the number and, optionally, the dimensionality of each output port. If you do not specify the dimensionality of the outputs, the block determines the dimensionality of the outputs.

The value can be a scalar specifying the number of outputs or a vector whose elements specify the widths of the block output ports. The block determines the size of its outputs from the size of the input signal and the value of the **Number of outputs** parameter.

If you specify a scalar for the **Number of outputs** parameter and all of the output ports are connected, as you draw a new signal line close to output side of a Demux block, Simulink adds a port and updates the **Number of outputs** parameter.

For an input vector of width n , here is what the block outputs.

| Parameter Value | Block outputs... | Examples and Comments |
|---|---|---|
| $p = n$ | p scalar signals | If the input is a three-element vector and you specify three outputs, the block outputs three scalar signals. |
| $p > n$ | Error | This value is not supported. |
| $p < n$ $n \bmod p = 0$ | p vector signals each having n/p elements | If the input is a six-element vector and you specify three outputs, the block outputs three two-element vectors. |
| $p < n$ $n \bmod p = m$ | m vector signals each having $(n/p) + 1$ elements and $p - m$ signals having n/p elements | If the input is a five-element vector and you specify three outputs, the block outputs two two-element vector signals and one scalar signal. |
| $[p_1 \ p_2 \ \dots \ p_m]$ $p_1 + p_2 + \dots + p_m = n$ $p_i > 0$ | m vector signals having widths p_1, p_2, \dots, p_m | If the input is a five-element vector and you specify $[3, 2]$ as the output, the block outputs three of the input elements on one port and the other two elements on the other port. |
| An array that has one or more of m elements with a value of -1, which specifies that Simulink infers the size for the element. For example, suppose that you have a four-element array with a total width of 14 and you specify the parameter to be $[p_1 \ p_2 \ -1 \ p_4]$. The value for the third element (the -1 element) is $14 - (p_1 + p_2 + p_4)$ | m vector signals | If p_i is greater than zero, the corresponding output has width p_i . If p_i is -1, the width of the corresponding output is computed dynamically. |
| $[p_1 \ p_2 \ \dots \ p_m]$ $p_1 + p_2 + \dots + p_m \neq n$ $p_i = > 0$ | Error | This value is not supported |

If you specify the number of outputs that is smaller than the number of input elements, the block distributes the elements as evenly as possible over the outputs. For examples, see "Extract Vector

Elements and Distribute Evenly Across Outputs” on page 12-153 and “Extract Vector Elements Using the Demux Block” on page 12-154.

Programmatic Use

Block Parameter: Outputs

Type: scalar or vector

Values: character vector

Default: { '2' } or vector

Display option — Displayed block icon

bar (default) | none

By default, the block icon is a solid bar of the block foreground color. To display the icon as a box containing the block type name, select none.

Programmatic Use

Block Parameter: Display option

Type: character vector

Values: 'bar' | 'none'

Default: 'bar'

Block Characteristics

| | |
|---------------------------------|---|
| Data Types | Boolean double enumerated fixed point half integer single |
| Direct Feedthrough | yes |
| Multidimensional Signals | no |
| Variable-Size Signals | no |
| Zero-Crossing Detection | no |

Extended Capabilities

C/C++ Code Generation

Generate C and C++ code using Simulink® Coder™.

Actual data type or capability support depends on block implementation.

HDL Code Generation

Generate Verilog and VHDL code for FPGA and ASIC designs using HDL Coder™.

HDL Coder provides additional configuration options that affect HDL implementation and synthesized logic.

HDL Architecture

This block has a single, default HDL architecture.

HDL Block Properties

| | |
|----------------------------------|--|
| ConstrainedOutputPipeline | Number of registers to place at the outputs by moving existing delays within your design. Distributed pipelining does not redistribute these registers. The default is 0. For more details, see “ConstrainedOutputPipeline” (HDL Coder). |
| InputPipeline | Number of input pipeline stages to insert in the generated code. Distributed pipelining and constrained output pipelining can move these registers. The default is 0. For more details, see “InputPipeline” (HDL Coder). |
| OutputPipeline | Number of output pipeline stages to insert in the generated code. Distributed pipelining and constrained output pipelining can move these registers. The default is 0. For more details, see “OutputPipeline” (HDL Coder). |

Complex Data Support

This block supports code generation for complex signals.

PLC Code Generation

Generate Structured Text code using Simulink® PLC Coder™.

Fixed-Point Conversion

Design and simulate fixed-point systems using Fixed-Point Designer™.

Actual data type or capability support depends on block implementation.

See Also

Mux | Bus Creator | Bus to Vector

Topics

“Virtual and Nonvirtual Signals”

“Simplify Subsystem and Model Interfaces with Buses”

“Composite Signals”

feedbacksystem

Introduced before R2006a

Derivative

Output time derivative of input

Library: Simulink / Continuous



Description

The Derivative block approximates the derivative of the input signal u with respect to the simulation time t . You obtain the approximation of

$$\frac{du}{dt},$$

by computing a numerical difference $\Delta u/\Delta t$, where Δu is the change in input value and Δt is the change in time since the previous simulation (major) time step.

This block accepts one input and generates one output. The initial output for the block is zero.

The precise relationship between the input and output of this block is:

$$y(t) = \frac{\Delta u}{\Delta t} = \frac{u(t) - u(T_{previous})}{t - T_{previous}} \Big|_{t > T_{previous}},$$

where t is the current simulation time and $T_{previous}$ is the time of the last output time of the simulation. The latter is the same as the time of the last major time step.

The Derivative block output might be sensitive to the dynamics of the entire model. The accuracy of the output signal depends on the size of the time steps taken in the simulation. Smaller steps allow for a smoother and more accurate output curve from this block. However, unlike with blocks that have continuous states, the solver does not take smaller steps when the input to this block changes rapidly. Depending on the dynamics of the driving signal and model, the output signal of this block might contain unexpected fluctuations. These fluctuations are primarily due to the driving signal output and solver step size.

Because of these sensitivities, structure your models to use integrators (such as Integrator blocks) instead of Derivative blocks. Integrator blocks have states that allow solvers to adjust the step size and improve simulation accuracy. See “Circuit Model” for an example of choosing the best-form mathematical model to avoid using Derivative blocks in your models.

If you must use the Derivative block with a variable step solver, set the solver maximum step size to a value such that the Derivative block can generate answers with adequate accuracy. To determine this value, you might need to repeatedly run the simulation using different solver settings.

If the input to this block is a discrete signal, the continuous derivative of the input exhibits an impulse when the value of the input changes. Otherwise, it is 0. Alternatively, you can define the discrete derivative of a discrete signal using the difference of the last two values of the signal:

$$y(k) = \frac{1}{\Delta t}(u(k) - u(k - 1))$$

Taking the z -transform of this equation results in:

$$\frac{Y(z)}{u(z)} = \frac{1 - z^{-1}}{\Delta t} = \frac{z - 1}{\Delta t \cdot z}$$

The Discrete Derivative block models this behavior. Use this block instead of the Derivative block to approximate the discrete-time derivative of a discrete signal.

Ports

Input

Port_1 – Input signal

real scalar or vector

Signal to be differentiated, specified as a real scalar or vector.

Data Types: double

Output

Port_1 – Time derivative of input signal

real scalar or vector

Time derivative of input signal, specified as a real scalar or vector. The input signal is differentiated with respect to time as:

$$y(t) = \frac{\Delta u}{\Delta t} = \frac{u(t) - u(T_{previous})}{t - T_{previous}} \Big|_{t > T_{previous}}$$

where t is the current simulation time and $T_{previous}$ is the time of the last output time of the simulation. The latter is the same as the time of the last major time step.

Data Types: double

Parameters

Coefficient c in the transfer function approximation $s/(c*s + 1)$ used for linearization – Specify the time constant c to approximate the linearization of your system

inf (default)

The exact linearization of the Derivative block is difficult because the dynamic equation for the block is $y = \dot{u}$, which you cannot represent as a state-space system. However, you can approximate the linearization by adding a pole to the Derivative block to create a transfer function $s/(c * s + 1)$. The addition of a pole filters the signal before differentiating it, which removes the effect of noise.

The default value `inf` corresponds to a linearization of θ .

Tips

- As a best practice, change the value of c to $\frac{1}{f_b}$, where f_b is the break frequency of the filter.

- The parameter must be a finite positive value.

Programmatic Use**Block Parameter:** CoefficientInTFapproximation**Type:** character vector, string**Values:** 'inf'**Default:** 'inf'**Block Characteristics**

| | |
|---------------------------------|--------|
| Data Types | double |
| Direct Feedthrough | no |
| Multidimensional Signals | no |
| Variable-Size Signals | no |
| Zero-Crossing Detection | no |

Extended Capabilities**C/C++ Code Generation**

Generate C and C++ code using Simulink® Coder™.

Consider using the Model Discretizer to map the continuous blocks into discrete equivalents that support code generation. To access the Model Discretizer, in the **Apps** tab, under **Control Systems**, click **Model Discretizer**.

Not recommended for production code.

See Also

Discrete Derivative

Topics

“Improved Linearization with Transfer Fcn Blocks” on page 12-29

Introduced before R2006a

Descriptor State-Space

Model linear implicit systems

Library: Simulink / Continuous

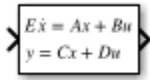

Description

The Descriptor State-Space block allows you to model linear implicit systems that can be expressed in the form $E\dot{x} = Ax + Bu$ where E is the mass matrix of the system. When E is nonsingular and therefore invertible, the system can be written in its explicit form $\dot{x} = E^{-1}Ax + E^{-1}Bu$ and modeled using the State-Space block.

When the mass matrix E is singular, one or more derivatives of the dependent variables of the system are not present in the equations. These variables are called algebraic variables. Differential equations that contain such algebraic variables are called differential algebraic equations. Their state space representation is of the form

$$\begin{aligned} E\dot{x} &= Ax + Bu \\ y &= Cx + Du \end{aligned}$$

where the variables have the following meanings:

- x is the state vector
- u is the input vector
- y is the output vector

Ports

Input

Input 1 — Input signal

scalar | vector

Real-valued input vector of type `double` whose width is the number of columns in the **B** and **D** matrices.

Data Types: `double`

Output

Output 1 — Output vector

scalar | vector

Real-valued input vector of type `double` whose width is the number of rows in the **C** and **D** matrices.

Data Types: `double`

Parameters

E — Mass matrix

1 (default) | scalar | matrix

Specify the mass matrix E as a real-valued n -by- n matrix, where n is the number of states in the system. E must be the same size as A . E can be singular or non-singular.

Programmatic Use

Block Parameter: E

Type: character vector, string

Values: scalar | matrix

Default: ' 1 '

A — Matrix coefficient, A

1 (default) | scalar | matrix

Specify the matrix coefficient A as a real-valued n -by- n matrix, where n is the number of states in the system. A must be the same size as E .

Programmatic Use

Block Parameter: A

Type: character vector, string

Values: scalar | matrix

Default: ' 1 '

B — Matrix coefficient, B

1 (default) | scalar | vector | matrix

Specify the matrix coefficient B as a real-valued n -by- m matrix, where n is the number of states in the system and m is the number of inputs.

Programmatic Use

Block Parameter: B

Type: character vector, string

Values: scalar | vector | matrix

Default: ' 1 '

C — Matrix coefficient, C

1 (default) | scalar | vector | matrix

Specify the matrix coefficient C as a real-valued r -by- n matrix, where n is the number of states in the system and r is the number of outputs.

Programmatic Use

Block Parameter: C

Type: character vector, string

Values: scalar | vector | matrix

Default: ' 1 '

D — Matrix coefficient, D

1 (default) | scalar | vector | matrix

Specify the matrix coefficient D as a real-valued r -by- m matrix, where r is the number of outputs of the system and m is the number of inputs to the system.

Programmatic Use**Block Parameter:** D**Type:** character vector, string**Values:** scalar | vector | matrix**Default:** '1'**Initial condition — Initial condition of states**

0 (default) | scalar | vector | matrix

Specify initial condition of the block states. The minimum and maximum values are bound by the **Output minimum** and **Output maximum** block parameters.

Tip Simulink software does not allow the initial condition of this block to be `inf` or `NaN`.

Dependencies

To enable this parameter, set the **Initial condition source** to `internal`.

Programmatic Use**Block Parameter:** InitialCondition**Type:** character vector, string**Values:** scalar | vector | matrix**Default:** '0'**Direct feedthrough — Set output signal dependency on input**

true (default) | false

Specify whether the output of the block has a direct dependency on the input signal. Use this parameter for systems having more than 500 continuous states in order to speed up simulation. For systems with 500 continuous states or less, Simulink automatically determines this setting.

Programmatic Use**Block Parameter:** DirectFeedthrough**Type:** character vector, string**Values:** 'True' | 'False'**Default:** 'True'**Linearize to sparse model — Linearize states to sparse matrices**

on (default) | off

For Simulink Control Design™ workflows, linearize the system represented by the Descriptor State-Space block to a sparse model during linearization.

Disable this parameter to linearize the system to a non-sparse explicit state-space model.

Data Types: Boolean

Absolute tolerance — Absolute tolerance for computing block states

auto (default) | scalar | vector

Absolute tolerance for computing block states, specified as a positive, real-valued, scalar or vector. To inherit the absolute tolerance from the Configuration Parameters, specify `auto` or `-1`.

- If you enter a real scalar, then that value overrides the absolute tolerance in the Configuration Parameters dialog box for computing all block states.

- If you enter a real vector, then the dimension of that vector must match the dimension of the continuous states in the block. These values override the absolute tolerance in the Configuration Parameters dialog box.
- If you enter `auto` or `-1`, then Simulink uses the absolute tolerance value in the Configuration Parameters dialog box (see “Solver Pane”) to compute block states.

Programmatic Use

Block Parameter: `AbsoluteTolerance`

Type: character vector, string

Values: `'auto'` | `-1` | any positive real-valued scalar or vector

Default: `'auto'`

State Name (e.g., 'position') – Assign unique name to each state

`' '` (default) | `'position'` | `{'a', 'b', 'c'}` | `a` | ...

Assign a unique name to each state. If this field is blank (`' '`), no name assignment occurs.

- To assign a name to a single state, enter the name between quotes, for example, `'position'`.
- To assign names to multiple states, enter a comma-delimited list surrounded by braces, for example, `{'a', 'b', 'c'}`. Each name must be unique.
- To assign state names with a variable in the MATLAB workspace, enter the variable without quotes. A variable can be a character vector, string, cell array, or structure.

Limitations

- The state names apply only to the selected block.
- The number of states must divide evenly among the number of state names.
- You can specify fewer names than states, but you cannot specify more names than states.

For example, you can specify two names in a system with four states. The first name applies to the first two states and the second name to the last two states.

Programmatic Use

Block Parameter: `ContinuousStateAttributes`

Type: character vector, string

Values: `' '` | user-defined

Default: `' '`

Block Characteristics

| | |
|---------------------------------|--------|
| Data Types | double |
| Direct Feedthrough | yes |
| Multidimensional Signals | no |
| Variable-Size Signals | no |
| Zero-Crossing Detection | no |

Extended Capabilities

C/C++ Code Generation

Generate C and C++ code using Simulink® Coder™.

- 1 Consider using the Model Discretizer to map these continuous blocks into discrete equivalents that support code generation. To access the Model Discretizer, in the **Apps** tab, under **Control Systems**, click **Model Discretizer**.
- 2 Not recommended for production code.

See Also

Blocks

State-Space | Algebraic Constraint

Functions

dss | sparss

Topics

“Solve Differential Algebraic Equations (DAEs)”

“Model Differential Algebraic Equations”

External Websites

<https://www.mathworks.com/matlabcentral/fileexchange/7481-manuscript-of-solving-index-1-daes-in-matlab-and-simulink>

Introduced in R2018b

Detect Change

Detect change in signal value

Library: Simulink / Logic and Bit Operations
HDL Coder / Logic and Bit Operations

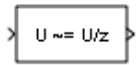

Description

The Detect Change block determines if an input signal does not equal its previous value. The initial condition determines the initial value of the previous input U/z .

This block supports only discrete sample times.

Ports

Input

Port_1 — Input signal

signal value

Input signal, specified as a scalar, vector, or matrix.

Data Types: `single` | `double` | `int8` | `int16` | `int32` | `int64` | `uint8` | `uint16` | `uint32` | `uint64` | `Boolean` | `fixed point` | `enumerated` | `built-in integer` | `floating point`

Output

Port_1 — Output signal

0 | 1

Output signal, true (equal to 1) when the input signal does not equal its previous value; false (equal to 0) when the input signal equals its previous value.

Data Types: `single` | `double` | `int8` | `int16` | `int32` | `int64` | `uint8` | `uint16` | `uint32` | `uint64` | `Boolean` | `fixed point` | `enumerated` | `bus`

Parameters

Initial condition — Initial condition for the previous input

0 (default) | scalar | vector

Set the initial condition for the previous input U/z .

Programmatic Use

Block Parameter: `vinit`

Type: character vector

Values: scalar | vector

Default: '0'

Input processing — Specify sample- or frame-based processing

Elements as channels (sample based) (default) | Columns as channels (frame based)

Specify whether the block performs sample- or frame-based processing:

- Columns as channels (frame based) — Treat each column of the input as a separate channel (frame-based processing).

Note Frame-based processing requires a DSP System Toolbox license.

For more information, see “Sample- and Frame-Based Concepts” (DSP System Toolbox).

- Elements as channels (sample based) — Treat each element of the input as a separate channel (sample-based processing).

Use **Input processing** to specify whether the block performs sample- or frame-based processing. For more information about these two processing modes, see “Sample- and Frame-Based Concepts” (DSP System Toolbox).

Programmatic Use

Block Parameter: InputProcessing

Type: character vector

Values: 'Columns as channels (frame based)' | 'Elements as channels (sample based)'

Default: 'Elements as channels (sample based)'

Output data type — Data type of the output

boolean (default) | uint8

Set the output data type to boolean or uint8.

Programmatic Use

Block Parameter: OutDataTypeStr

Type: character vector

Values: 'boolean' | 'uint8'

Default: 'boolean'

Block Characteristics

| | |
|---------------------------------|--|
| Data Types | Boolean double enumerated fixed point integer single |
| Direct Feedthrough | yes |
| Multidimensional Signals | yes |
| Variable-Size Signals | yes |
| Zero-Crossing Detection | no |

Extended Capabilities

C/C++ Code Generation

Generate C and C++ code using Simulink® Coder™.

Generated code relies on `memcpy` or `memset` functions (`string.h`) under certain conditions.

HDL Code Generation

Generate Verilog and VHDL code for FPGA and ASIC designs using HDL Coder™.

HDL Coder provides additional configuration options that affect HDL implementation and synthesized logic.

HDL Architecture

This block has a single, default HDL architecture.

HDL Block Properties

| | |
|----------------------------------|--|
| ConstrainedOutputPipeline | Number of registers to place at the outputs by moving existing delays within your design. Distributed pipelining does not redistribute these registers. The default is 0. For more details, see “ConstrainedOutputPipeline” (HDL Coder). |
| InputPipeline | Number of input pipeline stages to insert in the generated code. Distributed pipelining and constrained output pipelining can move these registers. The default is 0. For more details, see “InputPipeline” (HDL Coder). |
| OutputPipeline | Number of output pipeline stages to insert in the generated code. Distributed pipelining and constrained output pipelining can move these registers. The default is 0. For more details, see “OutputPipeline” (HDL Coder). |

PLC Code Generation

Generate Structured Text code using Simulink® PLC Coder™.

Fixed-Point Conversion

Design and simulate fixed-point systems using Fixed-Point Designer™.

See Also

Detect Decrease | Detect Fall Negative | Detect Fall Nonpositive | Detect Increase | Detect Rise Nonnegative | Detect Rise Positive

Introduced before R2006a

Detect Decrease

Detect decrease in signal value

Library: Simulink / Logic and Bit Operations
HDL Coder / Logic and Bit Operations

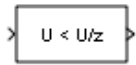

Description

The Detect Decrease block determines if an input is strictly less than its previous value.

This block supports only discrete sample times.

Ports

Input

Port_1 — Input signal

scalar | vector | matrix

Input signal, specified as a scalar, vector, or matrix.

Data Types: single | double | int8 | int16 | int32 | int64 | uint8 | uint16 | uint32 | uint64 | Boolean | fixed point | enumerated

Output

Port_1 — Output signal

0 | 1

Output signal, true (equal to 1) when the input signal is less than its previous value; false (equal to 0) when the input signal is greater than or equal to its previous value.

Data Types: single | double | int8 | int16 | int32 | int64 | uint8 | uint16 | uint32 | uint64 | Boolean | fixed point | enumerated

Parameters

Initial condition — Initial condition for the previous input

0 (default) | scalar | vector

Set the initial condition for the previous input U/z.

Programmatic Use

Block Parameter: vinit

Type: character vector

Values: scalar | vector

Default: '0'

Input processing — Specify sample- or frame-based processing

Elements as channels (sample based) (default) | Columns as channels (frame based)

Specify whether the block performs sample- or frame-based processing:

- Columns as channels (frame based) — Treat each column of the input as a separate channel (frame-based processing).

Note Frame-based processing requires a DSP System Toolbox license.

For more information, see “Sample- and Frame-Based Concepts” (DSP System Toolbox).

- Elements as channels (sample based) — Treat each element of the input as a separate channel (sample-based processing).

Use **Input processing** to specify whether the block performs sample- or frame-based processing. For more information about these two processing modes, see “Sample- and Frame-Based Concepts” (DSP System Toolbox).

Programmatic Use

Block Parameter: InputProcessing

Type: character vector

Values: 'Columns as channels (frame based)' | 'Elements as channels (sample based)'

Default: 'Elements as channels (sample based)'

Output data type — Data type of the output

boolean (default) | uint8

Set the output data type to boolean or uint8.

Programmatic Use

Block Parameter: OutDataTypeStr

Type: character vector

Values: 'boolean' | 'uint8'

Default: 'boolean'

Block Characteristics

| | |
|---------------------------------|--|
| Data Types | Boolean double enumerated fixed point integer single |
| Direct Feedthrough | yes |
| Multidimensional Signals | yes |
| Variable-Size Signals | yes |
| Zero-Crossing Detection | no |

Extended Capabilities

C/C++ Code Generation

Generate C and C++ code using Simulink® Coder™.

Generated code relies on `memcpy` or `memset` functions (`string.h`) under certain conditions.

HDL Code Generation

Generate Verilog and VHDL code for FPGA and ASIC designs using HDL Coder™.

HDL Coder provides additional configuration options that affect HDL implementation and synthesized logic.

HDL Architecture

This block has a single, default HDL architecture.

HDL Block Properties

| | |
|----------------------------------|--|
| ConstrainedOutputPipeline | Number of registers to place at the outputs by moving existing delays within your design. Distributed pipelining does not redistribute these registers. The default is 0. For more details, see “ConstrainedOutputPipeline” (HDL Coder). |
| InputPipeline | Number of input pipeline stages to insert in the generated code. Distributed pipelining and constrained output pipelining can move these registers. The default is 0. For more details, see “InputPipeline” (HDL Coder). |
| OutputPipeline | Number of output pipeline stages to insert in the generated code. Distributed pipelining and constrained output pipelining can move these registers. The default is 0. For more details, see “OutputPipeline” (HDL Coder). |

PLC Code Generation

Generate Structured Text code using Simulink® PLC Coder™.

Fixed-Point Conversion

Design and simulate fixed-point systems using Fixed-Point Designer™.

See Also

Detect Change | Detect Fall Negative | Detect Fall Nonpositive | Detect Increase | Detect Rise Nonnegative | Detect Rise Positive

Introduced before R2006a

Detect Fall Negative

Detect falling edge when signal value decreases to strictly negative value, and its previous value was nonnegative

Library: Simulink / Logic and Bit Operations

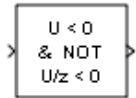

Description

The Detect Fall Negative block determines if the input is less than zero, and its previous value is greater than or equal to zero.

This block supports only discrete sample times.

Ports

For more information, see “Data Types Supported by Simulink” in the Simulink documentation.

Input

Port_1 — Input signal

signal value

Input signal, specified as a scalar, vector, or matrix.

Data Types: `single` | `double` | `int8` | `int16` | `int32` | `int64` | `uint8` | `uint16` | `uint32` | `uint64` | `Boolean` | `fixed point` | `enumerated`

Output

Port_1 — Output signal

0 | 1

Output signal, true (equal to 1) when the input signal is less than zero, and its previous value was greater than or equal to zero; false (equal to 0) when the input signal is greater than or equal to zero, or if the input signal is negative, its previous value was also negative.

Data Types: `single` | `double` | `int8` | `int16` | `int32` | `int64` | `uint8` | `uint16` | `uint32` | `uint64` | `Boolean` | `fixed point` | `enumerated` | `bus`

Parameters

Initial condition — Initial condition for the previous input

0 (default) | scalar | vector

Set the initial condition of the Boolean expression $U/z < 0$.

Programmatic Use**Block Parameter:** vinit**Type:** character vector**Values:** scalar | vector**Default:** '0'**Input processing — Specify sample- or frame-based processing**

Elements as channels (sample based) (default) | Columns as channels (frame based)

Specify whether the block performs sample- or frame-based processing:

- Columns as channels (frame based) — Treat each column of the input as a separate channel (frame-based processing).

Note Frame-based processing requires a DSP System Toolbox license.

For more information, see “Sample- and Frame-Based Concepts” (DSP System Toolbox).

- Elements as channels (sample based) — Treat each element of the input as a separate channel (sample-based processing).

Use **Input processing** to specify whether the block performs sample- or frame-based processing. For more information about these two processing modes, see “Sample- and Frame-Based Concepts” (DSP System Toolbox).

Programmatic Use**Block Parameter:** InputProcessing**Type:** character vector**Values:** 'Columns as channels (frame based)' | 'Elements as channels (sample based)'**Default:** 'Elements as channels (sample based)'**Output data type — Data type of the output**

boolean (default) | uint8

Set the output data type to boolean or uint8.

Programmatic Use**Block Parameter:** OutDataTypeStr**Type:** character vector**Values:** 'boolean' | 'uint8'**Default:** 'boolean'**Block Characteristics**

| | |
|---------------------------------|---|
| Data Types | Boolean double fixed point integer single |
| Direct Feedthrough | yes |
| Multidimensional Signals | yes |
| Variable-Size Signals | yes |
| Zero-Crossing Detection | no |

Extended Capabilities

C/C++ Code Generation

Generate C and C++ code using Simulink® Coder™.

Generated code relies on `memcpy` or `memset` functions (`string.h`) under certain conditions.

HDL Code Generation

Generate Verilog and VHDL code for FPGA and ASIC designs using HDL Coder™.

HDL Coder provides additional configuration options that affect HDL implementation and synthesized logic.

HDL Architecture

This block has a single, default HDL architecture.

HDL Block Properties

| | |
|----------------------------------|--|
| ConstrainedOutputPipeline | Number of registers to place at the outputs by moving existing delays within your design. Distributed pipelining does not redistribute these registers. The default is 0. For more details, see “ConstrainedOutputPipeline” (HDL Coder). |
| InputPipeline | Number of input pipeline stages to insert in the generated code. Distributed pipelining and constrained output pipelining can move these registers. The default is 0. For more details, see “InputPipeline” (HDL Coder). |
| OutputPipeline | Number of output pipeline stages to insert in the generated code. Distributed pipelining and constrained output pipelining can move these registers. The default is 0. For more details, see “OutputPipeline” (HDL Coder). |

PLC Code Generation

Generate Structured Text code using Simulink® PLC Coder™.

Fixed-Point Conversion

Design and simulate fixed-point systems using Fixed-Point Designer™.

See Also

Detect Decrease | Detect Change | Detect Fall Nonpositive | Detect Increase | Detect Rise Nonnegative | Detect Rise Positive

Introduced before R2006a

Detect Fall Nonpositive

Detect falling edge when signal value decreases to nonpositive value, and its previous value was strictly positive

Library: Simulink / Logic and Bit Operations

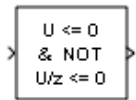

Description

The Detect Fall Nonpositive block determines if the input is less than or equal to zero, and its previous value was greater than zero.

- The output is true (equal to 1) when the input signal is less than or equal to zero, and its previous value was greater than zero.
- The output is false (equal to 0) when the input signal is greater than zero, or if it is nonpositive, its previous value was also nonpositive.

This block supports only discrete sample times.

Ports

Input

Port_1 — Input signal

scalar | vector | matrix

Input signal, specified as a scalar, vector, or matrix.

Data Types: single | double | int8 | int16 | int32 | int64 | uint8 | uint16 | uint32 | uint64 | Boolean | fixed point

Output

Port_1 — Output signal

scalar | vector | matrix

Output signal that detects a falling edge, specified as a scalar, vector, or matrix.

- The output is true (equal to 1) when the input signal is less than or equal to zero, and its previous value was greater than zero.
- The output is false (equal to 0) when the input signal is greater than zero, or if it is nonpositive, its previous value was also nonpositive.

Data Types: uint8 | Boolean

Parameters

Initial condition — Initial condition of Boolean expression $U/z \leq 0$

0 (default) | scalar | vector | matrix

Set the initial condition of the Boolean expression $U/z \leq 0$.

Programmatic Use

Block Parameter: vinit

Type: character vector

Values: scalar | vector | matrix

Default: '0'

Input processing — Specify sample- or frame-based processing

Elements as channels (sample based) (default) | Columns as channels (frame based)

Specify whether the block performs sample- or frame-based processing:

- Columns as channels (frame based) — Treat each column of the input as a separate channel (frame-based processing).

Note Frame-based processing requires a DSP System Toolbox license.

For more information, see “Sample- and Frame-Based Concepts” (DSP System Toolbox).

- Elements as channels (sample based) — Treat each element of the input as a separate channel (sample-based processing).

Use **Input processing** to specify whether the block performs sample- or frame-based processing. For more information about these two processing modes, see “Sample- and Frame-Based Concepts” (DSP System Toolbox).

Programmatic Use

Block Parameter: InputProcessing

Type: character vector

Values: 'Columns as channels (frame based)' | 'Elements as channels (sample based)'

Default: 'Elements as channels (sample based)'

Output data type — Output data type

boolean (default) | uint8

Specify the output data type as boolean or uint8.

Programmatic Use

Block Parameter: OutDataTypeStr

Type: character vector

Values: 'boolean' | 'uint8'

Default: 'boolean'

Block Characteristics

| | |
|-------------------|---|
| Data Types | Boolean double fixed point integer single |
|-------------------|---|

| | |
|---------------------------------|-----|
| Direct Feedthrough | yes |
| Multidimensional Signals | yes |
| Variable-Size Signals | yes |
| Zero-Crossing Detection | no |

Extended Capabilities

C/C++ Code Generation

Generate C and C++ code using Simulink® Coder™.

Generated code relies on `memcpy` or `memset` functions (`string.h`) under certain conditions.

HDL Code Generation

Generate Verilog and VHDL code for FPGA and ASIC designs using HDL Coder™.

HDL Coder provides additional configuration options that affect HDL implementation and synthesized logic.

HDL Architecture

This block has a single, default HDL architecture.

HDL Block Properties

| | |
|----------------------------------|--|
| ConstrainedOutputPipeline | Number of registers to place at the outputs by moving existing delays within your design. Distributed pipelining does not redistribute these registers. The default is 0. For more details, see “ConstrainedOutputPipeline” (HDL Coder). |
| InputPipeline | Number of input pipeline stages to insert in the generated code. Distributed pipelining and constrained output pipelining can move these registers. The default is 0. For more details, see “InputPipeline” (HDL Coder). |
| OutputPipeline | Number of output pipeline stages to insert in the generated code. Distributed pipelining and constrained output pipelining can move these registers. The default is 0. For more details, see “OutputPipeline” (HDL Coder). |

PLC Code Generation

Generate Structured Text code using Simulink® PLC Coder™.

Fixed-Point Conversion

Design and simulate fixed-point systems using Fixed-Point Designer™.

See Also

Detect Change | Detect Decrease | Detect Fall Negative | Detect Increase | Detect Rise Nonnegative | Detect Rise Positive

Introduced before R2006a

Detect Increase

Detect increase in signal value

Library: Simulink / Logic and Bit Operations
HDL Coder / Logic and Bit Operations

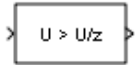

Description

The Detect Increase block determines if an input is strictly greater than its previous value.

- The output is true (equal to 1) when the input signal is greater than its previous value.
- The output is false (equal to 0) when the input signal is less than or equal to its previous value.

This block supports only discrete sample times.

Ports

Input

Port_1 — Input signal

scalar | vector | matrix

Input signal, specified as a scalar, vector, or matrix.

Data Types: single | double | int8 | int16 | int32 | int64 | uint8 | uint16 | uint32 | uint64 | Boolean | fixed point | enumerated

Output

Port_1 — Output signal

scalar | vector | matrix

Output signal, detecting an increase in signal value, specified as a scalar, vector, or matrix.

- The output is true (equal to 1) when the input signal is greater than its previous value.
- The output is false (equal to 0) when the input signal is less than or equal to its previous value.

Data Types: uint8 | Boolean

Parameters

Initial condition — Initial condition of previous input

0.0 (default) | scalar | vector | matrix

Set the initial condition for the previous input U/z.

Programmatic Use**Block Parameter:** vinit**Type:** character vector**Values:** scalar | vector | matrix**Default:** '0.0'**Input processing — Specify sample- or frame-based processing**

Elements as channels (sample based) (default) | Columns as channels (frame based)

Specify whether the block performs sample- or frame-based processing:

- Columns as channels (frame based) — Treat each column of the input as a separate channel (frame-based processing).

Note Frame-based processing requires a DSP System Toolbox license.

For more information, see “Sample- and Frame-Based Concepts” (DSP System Toolbox).

- Elements as channels (sample based) — Treat each element of the input as a separate channel (sample-based processing).

Use **Input processing** to specify whether the block performs sample- or frame-based processing. For more information about these two processing modes, see “Sample- and Frame-Based Concepts” (DSP System Toolbox).

Programmatic Use**Block Parameter:** InputProcessing**Type:** character vector**Values:** 'Columns as channels (frame based)' | 'Elements as channels (sample based)'**Default:** 'Elements as channels (sample based)'**Output data type — Output data type**

boolean (default) | uint8

Specify the output data type as boolean or uint8.

Programmatic Use**Block Parameter:** OutDataTypeStr**Type:** character vector**Values:** 'boolean' | 'uint8'**Default:** 'boolean'**Block Characteristics**

| | |
|---------------------------------|--|
| Data Types | Boolean double enumerated fixed point integer single |
| Direct Feedthrough | yes |
| Multidimensional Signals | yes |
| Variable-Size Signals | yes |
| Zero-Crossing Detection | no |

Extended Capabilities

C/C++ Code Generation

Generate C and C++ code using Simulink® Coder™.

Generated code relies on `memcpy` or `memset` functions (`string.h`) under certain conditions.

HDL Code Generation

Generate Verilog and VHDL code for FPGA and ASIC designs using HDL Coder™.

HDL Coder provides additional configuration options that affect HDL implementation and synthesized logic.

HDL Architecture

This block has a single, default HDL architecture.

HDL Block Properties

| | |
|----------------------------------|--|
| ConstrainedOutputPipeline | Number of registers to place at the outputs by moving existing delays within your design. Distributed pipelining does not redistribute these registers. The default is 0. For more details, see “ConstrainedOutputPipeline” (HDL Coder). |
| InputPipeline | Number of input pipeline stages to insert in the generated code. Distributed pipelining and constrained output pipelining can move these registers. The default is 0. For more details, see “InputPipeline” (HDL Coder). |
| OutputPipeline | Number of output pipeline stages to insert in the generated code. Distributed pipelining and constrained output pipelining can move these registers. The default is 0. For more details, see “OutputPipeline” (HDL Coder). |

PLC Code Generation

Generate Structured Text code using Simulink® PLC Coder™.

Fixed-Point Conversion

Design and simulate fixed-point systems using Fixed-Point Designer™.

See Also

Detect Change | Detect Decrease | Detect Fall Negative | Detect Fall Nonpositive | Detect Rise Nonnegative | Detect Rise Positive

Introduced before R2006a

Detect Rise Nonnegative

Detect rising edge when signal value increases to nonnegative value, and its previous value was strictly negative

Library: Simulink / Logic and Bit Operations

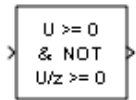

Description

The Detect Rise Nonnegative block determining if the input is greater than or equal to zero, and its previous value was less than zero.

- The output is true (equal to 1) when the input signal is greater than or equal to zero, and its previous value was less than zero.
- The output is false (equal to 0) when the input signal is less than zero, or if the input signal is nonnegative, its previous value was also nonnegative.

This block supports only discrete sample times.

Ports

Input

Port_1 — Input signal

scalar | vector | matrix

Input signal, specified as a scalar, vector, or matrix.

Data Types: single | double | int8 | int16 | int32 | int64 | uint8 | uint16 | uint32 | uint64 | Boolean | fixed point

Output

Port_1 — Output signal

scalar | vector | matrix

Output signal that indicates a rising edge whenever the signal value increases to a nonnegative value, and its previous value was strictly negative. The output can be a scalar, vector, or matrix.

- The output is true (equal to 1) when the input signal is greater than or equal to zero, and its previous value was less than zero.
- The output is false (equal to 0) when the input signal is less than zero, or if the input signal is nonnegative, its previous value was also nonnegative.

Data Types: uint8 | Boolean

Parameters

Initial condition — Initial condition of Boolean expression $U/z \geq 0$

0 (default) | scalar | vector | matrix

Set the initial condition of the Boolean expression $U/z \geq 0$.

Programmatic Use

Block Parameter: vinit

Type: character vector

Values: scalar | vector | matrix

Default: '0'

Input processing — Specify sample- or frame-based processing

Elements as channels (sample based) (default) | Columns as channels (frame based)

Specify whether the block performs sample- or frame-based processing:

- Columns as channels (frame based) — Treat each column of the input as a separate channel (frame-based processing).

Note Frame-based processing requires a DSP System Toolbox license.

For more information, see “Sample- and Frame-Based Concepts” (DSP System Toolbox).

- Elements as channels (sample based) — Treat each element of the input as a separate channel (sample-based processing).

Use **Input processing** to specify whether the block performs sample- or frame-based processing. For more information about these two processing modes, see “Sample- and Frame-Based Concepts” (DSP System Toolbox).

Programmatic Use

Block Parameter: InputProcessing

Type: character vector

Values: 'Columns as channels (frame based)' | 'Elements as channels (sample based)'

Default: 'Elements as channels (sample based)'

Output data type — Output data type

boolean (default) | uint8

Specify the output data type as boolean or uint8.

Programmatic Use

Block Parameter: OutDataTypeStr

Type: character vector

Values: 'boolean' | 'uint8'

Default: 'boolean'

Block Characteristics

| | |
|-------------------|---|
| Data Types | Boolean double fixed point integer single |
|-------------------|---|

| | |
|---------------------------------|-----|
| Direct Feedthrough | yes |
| Multidimensional Signals | yes |
| Variable-Size Signals | yes |
| Zero-Crossing Detection | no |

Extended Capabilities

C/C++ Code Generation

Generate C and C++ code using Simulink® Coder™.

Generated code relies on `memcpy` or `memset` functions (`string.h`) under certain conditions.

HDL Code Generation

Generate Verilog and VHDL code for FPGA and ASIC designs using HDL Coder™.

HDL Coder provides additional configuration options that affect HDL implementation and synthesized logic.

HDL Architecture

This block has a single, default HDL architecture.

HDL Block Properties

| | |
|----------------------------------|--|
| ConstrainedOutputPipeline | Number of registers to place at the outputs by moving existing delays within your design. Distributed pipelining does not redistribute these registers. The default is 0. For more details, see “ConstrainedOutputPipeline” (HDL Coder). |
| InputPipeline | Number of input pipeline stages to insert in the generated code. Distributed pipelining and constrained output pipelining can move these registers. The default is 0. For more details, see “InputPipeline” (HDL Coder). |
| OutputPipeline | Number of output pipeline stages to insert in the generated code. Distributed pipelining and constrained output pipelining can move these registers. The default is 0. For more details, see “OutputPipeline” (HDL Coder). |

PLC Code Generation

Generate Structured Text code using Simulink® PLC Coder™.

Fixed-Point Conversion

Design and simulate fixed-point systems using Fixed-Point Designer™.

See Also

Detect Change | Detect Decrease | Detect Fall Negative | Detect Fall Nonpositive | Detect Increase | Detect Rise Positive

Introduced before R2006a

Detect Rise Positive

Detect rising edge when signal value increases to strictly positive value, and its previous value was nonpositive

Library: Simulink / Logic and Bit Operations

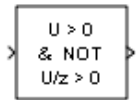

Description

The Detect Rise Positive block detects a rising edge by determining if the input is strictly positive, and its previous value was nonpositive.

- The output is true (equal to 1) when the input signal is greater than zero, and the previous value was less than or equal to zero.
- The output is false (equal to 0) when the input is negative or zero, or if the input is positive, the previous value was also positive.

This block supports only discrete sample times.

Ports

Input

Port_1 — Input signal

scalar | vector | matrix

Input signal, specified as a scalar, vector, or matrix.

Data Types: single | double | int8 | int16 | int32 | int64 | uint8 | uint16 | uint32 | uint64 | Boolean | fixed point

Output

Port_1 — Output signal

scalar | vector | matrix

Output signal that detects a rising edge whenever the input is strictly positive, and its previous value was nonpositive. The output can be a scalar, vector, or matrix.

- The output is true (equal to 1) when the input signal is greater than zero, and the previous value was less than or equal to zero.
- The output is false (equal to 0) when the input is negative or zero, or if the input is positive, the previous value was also positive.

Data Types: uint8 | Boolean

Parameters

Initial condition — Initial condition of Boolean expression $U/z > 0$

0 (default) | scalar | vector | matrix

Set the initial condition of the Boolean expression $U/z > 0$.

Programmatic Use

Block Parameter: vinit

Type: character vector

Values: scalar | vector | matrix

Default: '0'

Input processing — Specify sample- or frame-based processing

Elements as channels (sample based) (default) | Columns as channels (frame based)

Specify whether the block performs sample- or frame-based processing:

- Columns as channels (frame based) — Treat each column of the input as a separate channel (frame-based processing).

Note Frame-based processing requires a DSP System Toolbox license.

For more information, see “Sample- and Frame-Based Concepts” (DSP System Toolbox).

- Elements as channels (sample based) — Treat each element of the input as a separate channel (sample-based processing).

Use **Input processing** to specify whether the block performs sample- or frame-based processing. For more information about these two processing modes, see “Sample- and Frame-Based Concepts” (DSP System Toolbox).

Programmatic Use

Block Parameter: InputProcessing

Type: character vector

Values: 'Columns as channels (frame based)' | 'Elements as channels (sample based)'

Default: 'Elements as channels (sample based)'

Output data type — Output data type

boolean (default) | uint8

Specify the output data type as boolean or uint8.

Programmatic Use

Block Parameter: OutDataTypeStr

Type: character vector

Values: 'boolean' | 'uint8'

Default: 'boolean'

Block Characteristics

| | |
|-------------------|---|
| Data Types | Boolean double fixed point integer single |
|-------------------|---|

| | |
|---------------------------------|-----|
| Direct Feedthrough | yes |
| Multidimensional Signals | yes |
| Variable-Size Signals | yes |
| Zero-Crossing Detection | no |

Extended Capabilities

C/C++ Code Generation

Generate C and C++ code using Simulink® Coder™.

Generated code relies on `memcpy` or `memset` functions (`string.h`) under certain conditions.

HDL Code Generation

Generate Verilog and VHDL code for FPGA and ASIC designs using HDL Coder™.

HDL Coder provides additional configuration options that affect HDL implementation and synthesized logic.

HDL Architecture

This block has a single, default HDL architecture.

HDL Block Properties

| | |
|----------------------------------|--|
| ConstrainedOutputPipeline | Number of registers to place at the outputs by moving existing delays within your design. Distributed pipelining does not redistribute these registers. The default is 0. For more details, see “ConstrainedOutputPipeline” (HDL Coder). |
| InputPipeline | Number of input pipeline stages to insert in the generated code. Distributed pipelining and constrained output pipelining can move these registers. The default is 0. For more details, see “InputPipeline” (HDL Coder). |
| OutputPipeline | Number of output pipeline stages to insert in the generated code. Distributed pipelining and constrained output pipelining can move these registers. The default is 0. For more details, see “OutputPipeline” (HDL Coder). |

PLC Code Generation

Generate Structured Text code using Simulink® PLC Coder™.

Fixed-Point Conversion

Design and simulate fixed-point systems using Fixed-Point Designer™.

See Also

Detect Change | Detect Decrease | Detect Fall Negative | Detect Fall Nonpositive | Detect Increase | Detect Rise Nonnegative

Introduced before R2006a

Difference

Calculate change in signal over one time step

Library: Simulink / Discrete

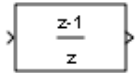

Description

The Difference block outputs the current input value minus the previous input value.

Ports

Input

Port_1 — Input signal

scalar | vector | matrix | N-D array

Input signal, specified as a scalar, vector, matrix, or N-D array.

Dependencies

When you set **Input processing** to `Columns as channels (frame based)`, the input signal must have two dimensions or less.

Data Types: half | single | double | int8 | int16 | int32 | int64 | uint8 | uint16 | uint32 | uint64 | Boolean | fixed point

Output

Port_1 — Current input minus previous input

scalar | vector | matrix | N-D array

Current input minus previous input, specified as a scalar, vector, matrix, or N-D array.

Data Types: half | single | double | int8 | int16 | int32 | int64 | uint8 | uint16 | uint32 | uint64 | Boolean | fixed point

Parameters

Main

Initial condition for previous input — Initial condition

0.0 (default) | scalar | vector | matrix | N-D array

Set the initial condition for the previous input.

Programmatic Use

Parameter: ICPprevInput

Type: character vector

Values: scalar | vector | matrix | N-D array

Default: '0.0'

Input processing — Specify sample- or frame-based processing

Elements as channels (sample based) (default) | Columns as channels (frame based)

Specify whether the block performs sample- or frame-based processing:

- Columns as channels (frame based) — Treat each column of the input as a separate channel (frame-based processing).

Note Frame-based processing requires a DSP System Toolbox license.

For more information, see “Sample- and Frame-Based Concepts” (DSP System Toolbox).

- Elements as channels (sample based) — Treat each element of the input as a separate channel (sample-based processing).

Use **Input processing** to specify whether the block performs sample- or frame-based processing. For more information about these two processing modes, see “Sample- and Frame-Based Concepts” (DSP System Toolbox).

Programmatic Use

Block Parameter: InputProcessing

Type: character vector

Values: 'Columns as channels (frame based)' | 'Elements as channels (sample based)'

Default: 'Elements as channels (sample based)'

Signal Attributes

Output minimum — Minimum output value for range checking

[] (default) | scalar

Lower value of the output range that Simulink checks.

Simulink uses the minimum to perform:

- Parameter range checking (see “Specify Minimum and Maximum Values for Block Parameters”) for some blocks.
- Simulation range checking (see “Specify Signal Ranges” and “Enable Simulation Range Checking”).
- Automatic scaling of fixed-point data types.
- Optimization of the code that you generate from the model. This optimization can remove algorithmic code and affect the results of some simulation modes such as SIL or external mode. For more information, see “Optimize using the specified minimum and maximum values” (Embedded Coder).

Note Output minimum does not saturate or clip the actual output signal. Use the Saturation block instead.

Programmatic Use**Block Parameter:** OutMin**Type:** character vector**Values:** ' [] ' | scalar**Default:** ' [] '**Output maximum — Maximum output value for range checking**

[] (default) | scalar

Upper value of the output range that Simulink checks.

Simulink uses the maximum value to perform:

- Parameter range checking (see “Specify Minimum and Maximum Values for Block Parameters”) for some blocks.
- Simulation range checking (see “Specify Signal Ranges” and “Enable Simulation Range Checking”).
- Automatic scaling of fixed-point data types.
- Optimization of the code that you generate from the model. This optimization can remove algorithmic code and affect the results of some simulation modes such as SIL or external mode. For more information, see “Optimize using the specified minimum and maximum values” (Embedded Coder).

Note **Output maximum** does not saturate or clip the actual output signal. Use the Saturation block instead.

Programmatic Use**Block Parameter:** OutMax**Type:** character vector**Values:** ' [] ' | scalar**Default:** ' [] '**Output data type — Output data type**

Inherit: `Inherit via internal rule (default)` | `Inherit via back propagation` | `double` | `single` | `int8` | `uint8` | `int16` | `uint16` | `int32` | `uint32` | `int64` | `uint64` | `fixdt(1,16)` | `fixdt(1,16,0)` | `fixdt(1,16,2^0,0)` | `<data type expression>`

Specify the output data type. You can set it to:

- A rule that inherits a data type, for example, `Inherit: Inherit via back propagation`
- The name of a built-in data type, for example, `single`
- The name of a data type object, for example, a `Simulink.NumericType` object
- An expression that evaluates to a data type, for example, `fixdt(1,16,0)`

Click the **Show data type assistant** button  to display the **Data Type Assistant**, which helps you set the data type attributes. For more information, see “Specify Data Types Using Data Type Assistant”.

Dependencies

When input is a floating-point data type smaller than single precision, the `Inherit: Inherit via internal` rule output data type depends on the setting of the “Inherit floating-point output type

smaller than single precision” configuration parameter. Data types are smaller than single precision when the number of bits needed to encode the data type is less than the 32 bits needed to encode the single-precision data type. For example, half and int16 are smaller than single precision.

Programmatic Use

Parameter: OutDataTypeStr

Type: character vector

Values: 'Inherit: Inherit via internal rule' | 'Inherit: Inherit via back propagation' | 'double' | 'single' | 'int8' | 'uint8' | 'int16' | 'uint16' | 'int32' | 'uint32' | 'int64' | 'uint64' | 'boolean' | 'fixdt(1,16)' | 'fixdt(1,16,0)' | 'fixdt(1,16,2^0,0)' | '<data type expression>'

Default: 'Inherit: Inherit via internal rule'

Lock output data type setting against changes by the fixed-point tools — Prevent fixed-point tools from overriding Output data type

off (default) | on

Select this parameter to prevent the fixed-point tools from overriding the **Output** data type you specify on the block. For more information, see “Use Lock Output Data Type Setting” (Fixed-Point Designer).

Programmatic Use

Block Parameter: LockScale

Type: character vector

Values: 'off' | 'on'

Default: 'off'

Integer rounding mode — Rounding mode for fixed-point operations

Floor (default) | Ceiling | Convergent | Nearest | Round | Simplest | Zero

Specify the rounding mode for fixed-point operations. For more information, see “Rounding” (Fixed-Point Designer).

Block parameters always round to the nearest representable value. To control the rounding of a block parameter, enter an expression using a MATLAB rounding function into the mask field.

Programmatic Use

Block Parameter: RndMeth

Type: character vector

Values: 'Ceiling' | 'Convergent' | 'Floor' | 'Nearest' | 'Round' | 'Simplest' | 'Zero'

Default: 'Floor'

Saturate to max or min when overflows occur — Method of overflow action

off (default) | on

When you select this check box, overflows saturate to the maximum or minimum value that the data type can represent. Otherwise, overflows wrap.

When you select this check box, saturation applies to every internal operation on the block, not just the output or result. In general, the code generation process can detect when overflow is not possible. In this case, the code generator does not produce saturation code.

Programmatic Use

Block Parameter: DoSatur

Type: character vector
Values: 'off' | 'on'
Default: 'off'

Block Characteristics

| | |
|---------------------------------|---|
| Data Types | Boolean ^a double fixed point half integer single |
| Direct Feedthrough | no |
| Multidimensional Signals | no |
| Variable-Size Signals | yes |
| Zero-Crossing Detection | no |

a. This block is not recommended for use with Boolean signals.

Extended Capabilities

C/C++ Code Generation

Generate C and C++ code using Simulink® Coder™.

- The code generator does not explicitly group primitive blocks that constitute a nonatomic masked subsystem block in the generated code. This flexibility allows for more efficient code generation. In certain cases, you can achieve grouping by configuring the masked subsystem block to execute as an atomic unit by selecting the Treat as atomic unit option.

PLC Code Generation

Generate Structured Text code using Simulink® PLC Coder™.

Fixed-Point Conversion

Design and simulate fixed-point systems using Fixed-Point Designer™.

See Also

diff

Topics

“Sample- and Frame-Based Concepts” (DSP System Toolbox)

Introduced before R2006a

Digital Clock

Output simulation time at specified sampling interval

Library: Simulink / Sources

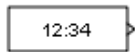

Description

The Digital Clock block outputs the simulation time only at the specified sampling interval. At other times, the block holds the output at the previous value. To control the precision of this block, use the **Sample time** parameter in the block dialog box.

Use this block rather than the Clock block (which outputs continuous time) when you need the current simulation time within a discrete system.

Ports

Output

Port_1 — Sample time

scalar

Sample time, in seconds, at the specified sampling interval. At other times, the block holds the output at the previous value.

Data Types: double

Parameters

Sample time — Sampling interval

1 (default) | scalar | vector

Specify the sampling interval in seconds. You can specify the sampling interval in one of two ways:

- As the period, specified as a real-valued scalar with data type double.
- As the period and offset, specified as a real-valued vector of length 2 with data type double. The period and offset must be finite and non-negative, and the offset value must be less than the period.

For more information, see [Specifying Sample Time](#).

Tip Do not specify a continuous sample time, either 0 or [0, 0]. Also, avoid specifying -1 (inheriting the sample time) because this block is a source.

Programmatic Use**Block Parameter:** SampleTime**Type:** character vector**Values:** scalar | vector**Default:** '1'**Block Characteristics**

| | |
|---------------------------------|--------|
| Data Types | double |
| Direct Feedthrough | no |
| Multidimensional Signals | no |
| Variable-Size Signals | no |
| Zero-Crossing Detection | no |

Extended Capabilities**C/C++ Code Generation**

Generate C and C++ code using Simulink® Coder™.

Not recommended for production code. Relates to resource limits and restrictions on speed and memory often found in embedded systems. Generated code can contain dynamic allocation and freeing of memory, recursion, additional memory overhead, and widely-varying execution times. While the code is functionally valid and generally acceptable in resource-rich environments, smaller embedded targets often cannot support such code. Usually, blocks evolve toward being suitable for production code. Thus, blocks suitable for production code remain suitable.

See Also

Clock

Topics

"Sample Time"

Introduced before R2006a

Direct Lookup Table (n-D)

Index into n-dimensional table to retrieve element, vector, or 2-D matrix

Library: Simulink / Lookup Tables
HDL Coder / Lookup Tables

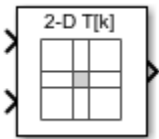

Description

The Direct Lookup Table (n-D) block indexes into an n-dimensional table to retrieve an element, vector, or 2-D matrix. The first selection index corresponds to the top (or left) input port. You can choose to provide the table data as an input to the block, or define the table data on the block dialog box. The number of input ports and the size of the output depend on the number of table dimensions and the output slice you select.

If you select a vector from a 2-D table, the output vector can be a column or a row, depending on the model configuration parameter setting **Math and Data Types > Use algorithms optimized for row-major array layout**. The block inputs are zero-based indices (for more information, see the **Inputs select this object from table** parameter).

The Direct Lookup Table block supports symbolic dimensions.

Block Inputs and Outputs

The Direct Lookup Table (n-D) block uses inputs as zero-based indices into an n -dimensional table. The number of inputs varies with the shape of the output: an element, vector, or 2-D matrix.

You define a set of output values as the **Table data** parameter. For the default column-major algorithm behavior, the first input specifies the zero-based index to the table dimension that is one higher than the output dimensionality. The next input specifies the zero-based index to the next table dimension, and so on.

| Output Shape | Output Dimensionality | Table Dimension that Maps to the First Input |
|--------------|-----------------------|--|
| Element | 0 | 1 |
| Vector | 1 | 2 |
| Matrix | 2 | 3 |

Suppose that you want to select a vector of values from a 4-D table.

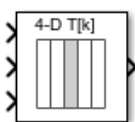

The following mapping of block input port to table dimension applies.

| This input port... | Is the index for this table dimension... |
|--------------------|--|
| 1 | 2 |
| 2 | 3 |
| 3 | 4 |



Changes in Block Icon Appearance

Depending on parameters you set, the block icon changes appearance. For table dimensions higher than 4, the icon matches the 4-D version but shows the exact number of dimensions at the top.

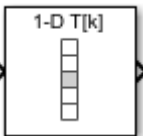
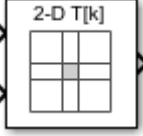
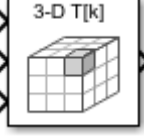
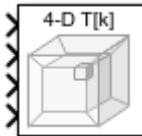
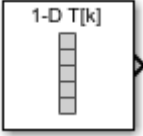
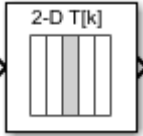
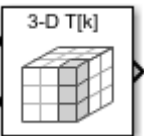
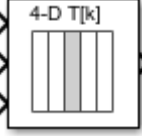
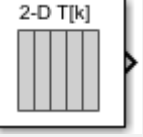
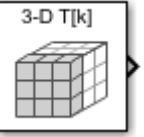
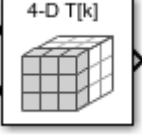
When you use the **Table data** parameter, you see these icons for the default column-major behavior. Some icons are different when you select the configuration parameter **Math and Data Types > Use algorithms optimized for row-major array layout**.

| Object that Inputs Select from the Table | Number of Table Dimensions | | | |
|--|---|---|--|---|
| | 1 | 2 | 3 | 4 |
| Element |  |  |  |  |
| Vector |  |  |  |  |
| 2-D Matrix | Not applicable |  |  |  |

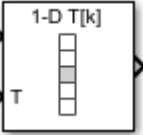
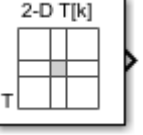
When you use the table input port, you see these icons.

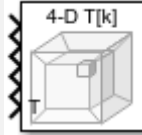
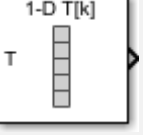
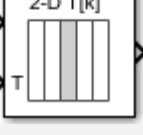
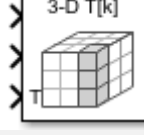
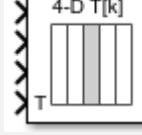
| Object that Inputs Select from the Table | Number of Table Dimensions | | | |
|--|---|---|--|---|
| | 1 | 2 | 3 | 4 |
| Element |  |  |  |  |
| Vector |  |  |  |  |

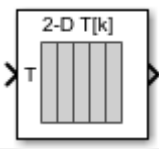
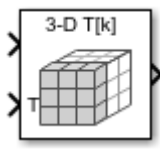
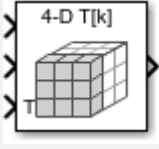
| Object that Inputs Select from the Table | Number of Table Dimensions | | | |
|--|----------------------------|---|--|---|
| | 1 | 2 | 3 | 4 |
| 2-D Matrix | Not applicable |  |  |  |

Ports

Input

Port_1 – Index i1 input values

scalar | vector

For the default column-major algorithm, the first input port, specifying the zero-based index to the table dimension that is one higher than the output dimensionality (0, 1, or 2). The next input specifies the zero-based index to the next table dimension, and so on. All index inputs must be real-valued.

Data Types: single | double | int8 | int16 | int32 | int64 | uint8 | uint16 | uint32 | uint64 | Boolean | fixed point | enumerated

Port_N – Index N input values

scalar | vector

For the default column-major algorithm, the N-th input port, specifying the zero-based index to the table dimension that is N higher than the output dimensionality (0, 1, or 2). The number of inputs varies with the shape of the output. All index inputs must be real-valued.

Data Types: single | double | int8 | int16 | int32 | int64 | uint8 | uint16 | uint32 | uint64 | Boolean | fixed point | enumerated

T – Table data

vector | matrix | N-D array

Table data, specified as a vector, matrix, or N-D array. The table size must match the dimensions of the **Number of dimensions** parameter. The block's output data type is the same as the table data type.

Dependencies

To enable this port, select the **Make table an input** check box.

Data Types: single | double | int8 | int16 | int32 | int64 | uint8 | uint16 | uint32 | uint64 | Boolean | fixed point | enumerated

Output

Port_1 – Output element, vector, or 2-D matrix

scalar | vector | 2-D matrix

Output slice, provided as a scalar, vector, or 2-D matrix. The size of the block output is determined by the setting of the **Inputs select this object from table** parameter. The output data type is the same as the table data type.

Data Types: single | double | int8 | int16 | int32 | int64 | uint8 | uint16 | uint32 | uint64 | Boolean | fixed point | enumerated

Parameters

Main

Table

Number of table dimensions — Number of dimensions of table data

2 (default) | 1 | 3 | 4

Number of dimensions that the **Table data** parameter must have. This value determines the number of independent variables for the table and the number of inputs to the block.

| To specify... | Do this... |
|-------------------------------------|---|
| 1, 2, 3, or 4 | Select the value from the drop-down list. |
| A higher number of table dimensions | Enter a positive integer directly in the field. The maximum number of table dimensions that this block supports is 30. |

Programmatic Use

Block Parameter: NumberOfTableDimensions

Type: character vector

Values: '1' | '2' | '3' | '4' | ... | '30'

Default: '2'

Make table an input — Provide table data as a block input

off (default) | on

Select this check box to provide table data to the Direct Lookup Table (n-D) block as a block input. When you select this check box, a new input port, T, appears. Use this port to input the table data.

Programmatic Use

Block Parameter: TableIsInput

Type: character vector

Values: 'off' | 'on'

Default: 'off'

Table data — Table of output values

[4 5 6; 16 19 20; 10 18 23] (default) | scalar, vector, matrix, or N-D array

Specify the table of output values. The table size must match the dimensions of the **Number of table dimensions** parameter.

Tip During block diagram editing, you can leave the **Table data** field empty. But for simulation, you must match the number of dimensions in **Table data** to the **Number of table dimensions**. For details on how to construct multidimensional MATLAB arrays, see “Multidimensional Arrays”.

Click **Edit** to open the Lookup Table Editor. For more information, see “Edit Lookup Tables”.

Dependencies

To enable the **Table data** field, clear the **Make table an input** check box.

Programmatic Use

Block Parameter: Table

Type: character vector

Values: scalar, vector, matrix, or N-D array

Default: '[4 5 6;16 19 20;10 18 23]'

Algorithm

Inputs select this object from table — Specify whether output is an element, vector, or 2-D matrix

Element (default) | Vector | 2-D Matrix

Specify whether the output data is a single element, a vector, or a 2-D matrix. The number of input ports for indexing depends on your selection.

| Selection | Number of Input Ports for Indexing |
|------------|------------------------------------|
| Element | Number of table dimensions |
| Vector | Number of table dimensions -1 |
| 2-D Matrix | Number of table dimensions -2 |

This numbering matches MATLAB indexing. For example, if you have a 4-D table of data, follow these guidelines.

| To access... | Specify... | As in... |
|--------------|---------------|---|
| An element | Four indices | array(1,2,3,4) |
| A vector | Three indices | array(:,2,3,4) (default column-major algorithm) |
| A 2-D matrix | Two indices | array(:, :, 3,4) (default column-major algorithm) |

Tips

When the **Math and Data Types > Use algorithms optimized for row-major array layout** configuration parameter is set, the Direct Lookup Table block behavior changes from column-major to row-major. For this block, the column-major and row-major algorithms may differ semantically in output calculations, resulting in different numerical values. For example, assume that **Inputs select this object from table** parameter is set to **Vector**. The elements of the selected vector are contiguous in the table storage memory. This table shows the column-major and row-major algorithm depending on the table dimension:

| Table Dimension | Column-Major Algorithm | Row-Major Algorithm |
|----------------------|---|--|
| 2-D table | Column vector is selected | Row vector is selected |
| 3-D and higher table | Output vector is selected from the first dimension of the table | Output vector is selected from the last dimension of the table |

Consider the row-major and column-major direct lookup algorithms with vector output from a 3-D table. The last dimension is the third dimension of a 3-D table. Due to semantic changes, column-major and row-major direct lookup may output different vector size and numerical values.

This figure shows a Direct Lookup Table (n-D) block configured with a 3-D table and a vector output. By default, the block icon shows the column-major algorithm.

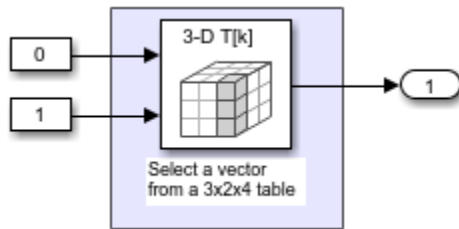

To have the same block use the row-major algorithm, change the **Math and Data Types > Use algorithm optimized for row-major layout** configuration parameter of the model and recompile. The block icon changes to reflect the change to the algorithm optimized for row-major behavior.

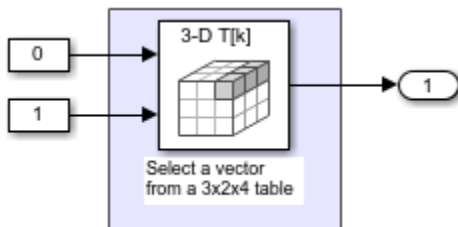

For more information on row-major support, see “Row-Major Array Layout: Simplify integration with external C/C++ code for Lookup Table and other blocks” (Simulink Coder).

Programmatic Use

Block Parameter: InputsSelectThisObjectFromTable

Type: character vector

Values: 'Element' | 'Vector' | '2-D Matrix'

Default: 'Element'

Diagnostic for out-of-range input – Block action when input is out of range

Warning (default) | None | Error

Specify whether to show a warning or error when an index is out of range with respect to the table dimension. Options include:

- None — Produce no response.
- Warning — Display a warning and continue the simulation.
- Error — Terminate the simulation and display an error.

When you select None or Warning, the block clamps out-of-range indices to fit table dimensions. For example, if the specified index is 5.3 and the maximum index for that table dimension is 4, the block clamps the index to 4.

Programmatic Use

Block Parameter: DiagnosticForOutOfRangeInput

Type: character vector

Values: 'None' | 'Warning' | 'Error'

Default: 'Warning'

Sample time — Specify sample time as a value other than -1

-1 (default) | scalar | vector

Specify the sample time as a value other than -1. For more information, see “Specify Sample Time”.

Dependencies

This parameter is not visible unless it is explicitly set to a value other than -1. To learn more, see “Blocks for Which Sample Time Is Not Recommended”.

Programmatic Use**Block Parameter:** SampleTime**Type:** character vector**Values:** scalar or vector**Default:** '-1'**Code generation****Remove protection against out-of-range input in generated code — Remove code that checks for out-of-range input values**

off (default) | on

Specify whether or not to include code that checks for out-of-range input values.

| Check Box | Result | When to Use |
|-----------|--|----------------------------------|
| on | Generated code does not include conditional statements to check for out-of-range breakpoint inputs. When the input is out-of-range, it may cause undefined behavior for generated code. | For code efficiency |
| off | Generated code includes conditional statements to check for out-of-range inputs. | For safety-critical applications |

If your input is not out of range, you can select the **Remove protection against out-of-range index in generated code** check box for code efficiency. By default, this check box is cleared. For safety-critical applications, do not select this check box. If you want to select the **Remove protection against out-of-range index in generated code** check box, first check that your model inputs are in range. For example:

- 1 Clear the **Remove protection against out-of-range index in generated code** check box.
- 2 Set the **Diagnostic for out-of-range input** parameter to Error.
- 3 Simulate the model in normal mode.
- 4 If there are out-of-range errors, fix them to be in range and run the simulation again.
- 5 When the simulation no longer generates out-of-range input errors, select the **Remove protection against out-of-range index in generated code** check box.

Note When you select the **Remove protection against out-of-range index in generated code** check box and the input is out of range, the behavior is undefined for generated code.

Depending on your application, you can run the following Model Advisor checks to verify the usage of this check box:

- **By Product > Embedded Coder > Identify lookup table blocks that generate expensive out-of-range checking code**
- **By Product > Simulink Check > Modeling Standards > DO-178C/DO-331 Checks > Check usage of lookup table blocks**

For more information about the Model Advisor, see “Run Model Advisor Checks”.

Additionally, to determine if it is safe to select this check box, if you have a Simulink Design Verifier license, consider using the “Detect Block Input Range Violations” (Simulink Design Verifier) check.

Programmatic Use

Block Parameter: RemoveProtectionInput

Type: character vector

Values: 'off' | 'on'

Default: 'off'

Table Attributes

Note The parameters in the **Table Attributes** pane are not available if you select **Make table an input**. In this case, the block inherits all table attributes from the input port with the label T.

Table minimum — Minimum value table data can have

[] (default) | finite, real, double, scalar

Specify the minimum value for table data. The default value is [] (unspecified).

Programmatic Use

Block Parameter: TableMin

Type: character vector

Values: scalar

Default: '[]'

Table maximum — Maximum value table data can have

[] (default) | finite, real, double, scalar

Specify the maximum value for table data. The default value is [] (unspecified).

Programmatic Use

Block Parameter: TableMax

Type: character vector

Values: scalar

Default: '[]'

Table data type — Data type of table data

Inherit: Inherit from 'Table data' (default) | double | single | half | int8 | uint8 | int16 | uint16 | int32 | uint32 | int64 | uint64 | boolean | fixdt(1,16) | fixdt(1,16,0) | fixdt(1,16,2^0,0) | Enum: <class name> | <data type expression>

Specify the table data type. You can set it to:

- A rule that inherits a data type, for example, `Inherit: Inherit from 'Table data'`
- The name of a built-in data type, for example, `single`
- The name of a data type class, for example, an enumerated data type class
- An expression that evaluates to a data type, for example, `fixdt(1,16,0)`

Click the **Show data type assistant** button  to display the **Data Type Assistant**, which helps you set the data type attributes. For more information, see “Specify Data Types Using Data Type Assistant”.

Programmatic Use

Block Parameter: `TableDataTypeStr`

Type: character vector

Values: `'Inherit: Inherit from 'Table data'' | 'double' | 'single' | 'half' | 'int8' | 'uint8' | 'int16' | 'uint16' | 'int32' | 'uint32' | 'int64' | 'uint64' | 'boolean' | 'fixdt(1,16)' | 'fixdt(1,16,0)' | 'fixdt(1,16,2^0,0)' | 'Enum: <class name>' | '<data type expression>'`

Default: `'Inherit: Inherit from 'Table data''`

Lock data type settings against changes by the fixed-point tools — Prevent fixed-point tools from overriding data types

`off (default) | on`

Select this parameter to prevent the fixed-point tools from overriding the data types you specify on this block. For more information, see “Lock the Output Data Type Setting” (Fixed-Point Designer).

Programmatic Use

Block Parameter: `LockScale`

Type: character vector

Values: `'off' | 'on'`

Default: `'off'`

Block Characteristics

| | |
|---------------------------------|--|
| Data Types | Boolean double enumerated fixed point ^a half integer single |
| Direct Feedthrough | yes |
| Multidimensional Signals | yes |
| Variable-Size Signals | no |
| Zero-Crossing Detection | no |

a. This block supports fixed-point data types for 'Table' data only.

Extended Capabilities

C/C++ Code Generation

Generate C and C++ code using Simulink® Coder™.

HDL Code Generation

Generate Verilog and VHDL code for FPGA and ASIC designs using HDL Coder™.

HDL Coder provides additional configuration options that affect HDL implementation and synthesized logic.

HDL Architecture

This block has a single, default HDL architecture.

HDL Block Properties

| | |
|----------------------------------|--|
| ConstrainedOutputPipeline | Number of registers to place at the outputs by moving existing delays within your design. Distributed pipelining does not redistribute these registers. The default is 0. For more details, see "ConstrainedOutputPipeline" (HDL Coder). |
| InputPipeline | Number of input pipeline stages to insert in the generated code. Distributed pipelining and constrained output pipelining can move these registers. The default is 0. For more details, see "InputPipeline" (HDL Coder). |
| OutputPipeline | Number of output pipeline stages to insert in the generated code. Distributed pipelining and constrained output pipelining can move these registers. The default is 0. For more details, see "OutputPipeline" (HDL Coder). |

Restrictions

MAX 10 Device Settings

If you use Intel® MAX 10 device, to map the lookup table to RAM, add this Tcl command when creating the project in the Quartus tool:

```
set_global_assignment -name INTERNAL_FLASH_UPDATE_MODE "SINGLE IMAGE WITH ERAM"
```

Required Block Settings

- **Number of table dimensions:** HDL Coder supports a maximum dimension of 5.
- **Inputs select this object from table:** Select Element.
- **Make table an input:** Clear this check box.
- **Diagnostic for out-of-range input:** Select None, Warning (default), or Error (recommended). Select Error for efficient HDL code generation. If you select None or Warning, HDL Coder generates additional logic to handle out-of-range inputs.

Table Data Typing and Sizing

- It is good practice to size each dimension in the table to be a power of two. If the length of a dimension (*except* the innermost dimension) is not a power of two, HDL Coder issues a warning. By following this practice, you can avoid multiplications during table indexing operations and realize a more efficient table in hardware.
- All ports on the block require scalar values.

Fixed-Point Conversion

Design and simulate fixed-point systems using Fixed-Point Designer™.

This block supports fixed-point data types for **Table data** only. In addition to built-in data types, the index input also supports fixed-point data type with bias equal to 0, slope equal to 1.0, fractional length equal to 0, and word length less than or equal to 128.

See Also

n-D Lookup Table

Topics

[“About Lookup Table Blocks”](#)

[“Anatomy of a Lookup Table”](#)

[“Enter Breakpoints and Table Data”](#)

[“Guidelines for Choosing a Lookup Table”](#)

[“Direct Lookup Table Algorithm for Row-Major Array Layout”](#) (Simulink Coder)

[“Column-Major Layout to Row-Major Layout Conversion of Models with Lookup Table Blocks”](#) (Simulink Coder)

Introduced before R2006a

Discrete Derivative

Compute discrete-time derivative

Library: Simulink / Discrete

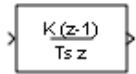

Description

The Discrete Derivative block computes an optionally scaled discrete time derivative as follows

$$y(t_n) = K \left(\frac{u(t_n) - u(t_{n-1})}{T_s} \right)$$

where

- $u(t_n)$ and $y(t_n)$ are the block input and output at the current time step, respectively.
- $u(t_{n-1})$ is the block input at the previous time step.
- K is an optional scaling factor, specified using the **Gain value** parameter.
- T_s is the simulation's discrete step size, which must be fixed.

Note Do not use this block in subsystems with a nonperiodic trigger (for example, nonperiodic function-call subsystems). This configuration produces inaccurate results.

Ports

Input

Port_1 – Input signal

scalar | vector | matrix

Input signal, specified as a scalar, vector, or matrix.

Data Types: single | double | int8 | int16 | int32 | int64 | uint8 | uint16 | uint32 | uint64 | fixed point

Output

Port_1 – Scaled discrete time derivative

scalar | vector | matrix

Optionally scaled discrete-time derivative, specified as a scalar, vector, or matrix. For more information on how the block computes the discrete-time derivative, see “Description” on page 1-339. You specify the data type of the output signal with the **Output data type** parameter.

Data Types: single | double | int8 | int16 | int32 | int64 | uint8 | uint16 | uint32 | uint64 | fixed point

Parameters

Main

Gain value — Scaling factor

1.0 (default) | scalar

Scaling factor applied to the computed derivative, specified as a real scalar value.

Programmatic Use

Block Parameter: gainval

Type: character vector

Values: scalar

Default: '1.0'

Initial condition for previous weighted input $K*u/Ts$ — Initial condition

0.0 (default) | scalar

Initial condition for the previous scaled input, specified as a scalar.

Programmatic Use

Block Parameter: ICPprevScaledInput

Type: character vector

Values: scalar

Default: '0.0'

Input processing — Specify sample- or frame-based processing

Elements as channels (sample based) (default) | Columns as channels (frame based)

Specify whether the block performs sample- or frame-based processing:

- Columns as channels (frame based) — Treat each column of the input as a separate channel (frame-based processing).

Note Frame-based processing requires a DSP System Toolbox license.

For more information, see “Sample- and Frame-Based Concepts” (DSP System Toolbox).

- Elements as channels (sample based) — Treat each element of the input as a separate channel (sample-based processing).

Use **Input processing** to specify whether the block performs sample- or frame-based processing. For more information about these two processing modes, see “Sample- and Frame-Based Concepts” (DSP System Toolbox).

Programmatic Use

Block Parameter: InputProcessing

Type: character vector

Values: 'Columns as channels (frame based)' | 'Elements as channels (sample based)'

Default: 'Elements as channels (sample based)'

Signal Attributes

Output minimum — Minimum output value for range checking

[] (default) | scalar

Lower value of the output range that Simulink checks.

Simulink uses the minimum to perform:

- Parameter range checking (see “Specify Minimum and Maximum Values for Block Parameters”) for some blocks.
- Simulation range checking (see “Specify Signal Ranges” and “Enable Simulation Range Checking”).
- Automatic scaling of fixed-point data types.
- Optimization of the code that you generate from the model. This optimization can remove algorithmic code and affect the results of some simulation modes such as SIL or external mode. For more information, see “Optimize using the specified minimum and maximum values” (Embedded Coder).

Note Output minimum does not saturate or clip the actual output signal. Use the Saturation block instead.

Programmatic Use

Block Parameter: OutMin

Type: character vector

Values: ' [] ' | scalar

Default: ' [] '

Output maximum — Maximum output value for range checking

[] (default) | scalar

Upper value of the output range that Simulink checks.

Simulink uses the maximum value to perform:

- Parameter range checking (see “Specify Minimum and Maximum Values for Block Parameters”) for some blocks.
- Simulation range checking (see “Specify Signal Ranges” and “Enable Simulation Range Checking”).
- Automatic scaling of fixed-point data types.
- Optimization of the code that you generate from the model. This optimization can remove algorithmic code and affect the results of some simulation modes such as SIL or external mode. For more information, see “Optimize using the specified minimum and maximum values” (Embedded Coder).

Note Output maximum does not saturate or clip the actual output signal. Use the Saturation block instead.

Programmatic Use**Block Parameter:** OutMax**Type:** character vector**Values:** '[]' | scalar**Default:** '[]'**Output data type — Output data type**

Inherit: Inherit via internal rule (default) | Inherit: Inherit via back propagation | double | single | int8 | uint8 | int16 | uint16 | int32 | uint32 | int64 | uint64 | fixdt(1,16,0) | fixdt(1,16,2^0,0)

Specify the output data type. You can set it to:

- A rule that inherits a data type, for example, Inherit: Inherit via back propagation
- The name of a built-in data type, for example, single
- The name of a data type object, for example, a Simulink.NumericType object
- An expression that evaluates to a data type, for example, fixdt(1,16,0)

Click the **Show data type assistant** button  to display the **Data Type Assistant**, which helps you set the data type attributes. For more information, see “Specify Data Types Using Data Type Assistant”.

Programmatic Use**Block Parameter:** OutDataTypeStr**Type:** character vector

Values: 'Inherit: Inherit via internal rule' | 'Inherit: Inherit via back propagation' | 'double' | 'single' | 'int8' | 'uint8' | 'int16' | 'uint16' | 'int32' | 'uint32' | 'int64' | 'uint64' | 'fixdt(1,16,0)' | 'fixdt(1,16,2^0,0)'

Default: 'Inherit: Inherit via internal rule'**Lock output data type setting against changes by the fixed-point tools — Prevent fixed-point tools from overriding Output data type**

off (default) | on

Select this parameter to prevent the fixed-point tools from overriding the **Output** data type you specify on the block. For more information, see “Use Lock Output Data Type Setting” (Fixed-Point Designer).

Programmatic Use**Block Parameter:** LockScale**Type:** character vector**Values:** 'off' | 'on'**Default:** 'off'**Integer rounding mode — Rounding mode for fixed-point operations**

Floor (default) | Ceiling | Convergent | Nearest | Round | Simplest | Zero

Specify the rounding mode for fixed-point operations. For more information, see “Rounding” (Fixed-Point Designer).

Block parameters always round to the nearest representable value. To control the rounding of a block parameter, enter an expression using a MATLAB rounding function into the mask field.

Programmatic Use**Block Parameter:** RndMeth**Type:** character vector**Values:** 'Ceiling' | 'Convergent' | 'Floor' | 'Nearest' | 'Round' | 'Simplest' | 'Zero'**Default:** 'Floor'**Saturate to max or min when overflows occur – Method of overflow action**

off (default) | on

When you select this check box, overflows saturate to the maximum or minimum value that the data type can represent. Otherwise, overflows wrap.

When you select this check box, saturation applies to every internal operation on the block, not just the output or result. In general, the code generation process can detect when overflow is not possible. In this case, the code generator does not produce saturation code.

Programmatic Use**Block Parameter:** DoSatur**Type:** character vector**Values:** 'off' | 'on'**Default:** 'off'**Block Characteristics**

| | |
|---------------------------------|---|
| Data Types | double fixed point integer single |
| Direct Feedthrough | no |
| Multidimensional Signals | no |
| Variable-Size Signals | yes |
| Zero-Crossing Detection | no |

Extended Capabilities**C/C++ Code Generation**

Generate C and C++ code using Simulink® Coder™.

- Depends on absolute time when used inside a triggered subsystem hierarchy.
- Generated code relies on memcpy or memset functions (string.h) under certain conditions.

PLC Code Generation

Generate Structured Text code using Simulink® PLC Coder™.

Fixed-Point Conversion

Design and simulate fixed-point systems using Fixed-Point Designer™.

See Also

Derivative | Discrete-Time Integrator

Introduced before R2006a

Discrete Filter

Model Infinite Impulse Response (IIR) filters

Library: Simulink / Discrete

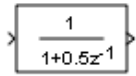

Description

The Discrete Filter block independently filters each channel of the input signal with the specified digital IIR filter. You can specify the filter structure as **Direct form I**, **Direct form I transposed**, **Direct form II**, or **Direct form II transposed**. The block implements static filters with fixed coefficients. You can tune the coefficients of these static filters.

This block filters each channel of the input signal independently over time. The **Input processing** parameter allows you to specify how the block treats each element of the input. You can specify treating input elements as an independent channel (sample-based processing), or treating each column of the input as an independent System channel (frame-based processing). To perform frame-based processing, you must have a DSP System Toolbox license.

The output dimensions equal the input dimensions, except when you specify a matrix of filter taps for the **Numerator coefficients** parameter. When you do so, the output dimensions depend on the number of different sets of filter taps you specify.

Use the **Numerator coefficients** parameter to specify the coefficients of the discrete filter numerator polynomial. Use the **Denominator coefficients** parameter to specify the coefficients of the denominator polynomial of the function. The **Denominator coefficients** parameter must be a vector of coefficients.

Specify the coefficients of the numerator and denominator polynomials in ascending powers of z^{-1} . The Discrete Filter block lets you use polynomials in z^{-1} (the delay operator) to represent a discrete system. Signal processing engineers typically use this method. Conversely, the Discrete Transfer Fcn block lets you use polynomials in z to represent a discrete system. Control engineers typically use this method. When the numerator and denominator polynomials have the same length, the two methods are identical.

Specifying Initial States

In **Dialog parameters** and **Input port(s)** modes, the block initializes the internal filter states to zero by default, which is equivalent to assuming past inputs and outputs are zero. You can optionally use the **Initial states** parameter to specify nonzero initial states for the filter delays.

To determine the number of initial state values you must specify, and how to specify them, see the following table on valid initial states and Number of Delay Elements (Filter States). The **Initial states** parameter can take one of four forms as described in the following table.

Valid Initial States

| Initial state | Examples | Description |
|---|--|---|
| Scalar | 5 Each delay element for each channel is set to 5. | The block initializes all delay elements in the filter to the scalar value. |
| Vector (for applying the same delay elements to each channel) | For a filter with two delay elements: [$d_1 d_2$] The delay elements for all channels are d_1 and d_2 . | Each vector element specifies a unique initial condition for a corresponding delay element. The block applies the same vector of initial conditions to each channel of the input signal. The vector length must equal the number of delay elements in the filter (specified in the table Number of Delay Elements (Filter States)). |
| Vector or matrix (for applying different delay elements to each channel) | For a three-channel input signal and a filter with two delay elements: [$d_1 d_2 D_1 D_2 d_1 d_2$] or $\begin{bmatrix} d_1 & D_1 & d_1 \\ d_2 & D_2 & d_2 \end{bmatrix}$ <ul style="list-style-type: none"> The delay elements for channel 1 are d_1 and d_2. The delay elements for channel 2 are D_1 and D_2. The delay elements for channel 3 are d_1 and d_2. | Each vector or matrix element specifies a unique initial condition for a corresponding delay element in a corresponding channel: <ul style="list-style-type: none"> The vector length must be equal to the product of the number of input channels and the number of delay elements in the filter (specified in the table Number of Delay Elements (Filter States)). The matrix must have the same number of rows as the number of delay elements in the filter (specified in the table Number of Delay Elements (Filter States)), and must have one column for each channel of the input signal. |
| Empty matrix | [] Each delay element for each channel is set to θ . | The empty matrix, [], is equivalent to setting the Initial conditions parameter to the scalar value θ . |

The number of delay elements (filter states) per input channel depends on the filter structure, as indicated in the following table.

Number of Delay Elements (Filter States)

| Filter Structure | Number of Delay Elements Per Channel |
|---|--|
| Direct form I Direct form I transposed | <ul style="list-style-type: none"> number of zeros - 1 number of poles - 1 |
| Direct form II Direct form II transposed | $\max(\text{number of zeros, number of poles}) - 1$ |

The following tables describe the valid initial states for different sizes of input and different number of channels depending on whether you set the **Input processing** parameter to frame based or sample based.

Frame-Based Processing

| Input | Number of Channels | Valid Initial States (Dialog Box) | Valid Initial States (Input Port) |
|---|--------------------|--|---|
| <ul style="list-style-type: none"> Column vector (K-by-1) Unoriented vector (K) | 1 | <ul style="list-style-type: none"> Scalar Column vector (M-by-1) Row vector (1-by-M) | <ul style="list-style-type: none"> Scalar Column vector (M-by-1) |
| <ul style="list-style-type: none"> Row vector (1-by-N) Matrix (K-by-N) | N | <ul style="list-style-type: none"> Scalar Column vector (M-by-1) Row vector (1-by-M) Matrix (M-by-N) | <ul style="list-style-type: none"> Scalar Matrix (M-by-N) |

Sample-Based Processing

| Input | Number of Channels | Valid Initial States (Dialog Box) | Valid Initial States (Input Port) |
|---|--------------------|---|---|
| <ul style="list-style-type: none"> Scalar | 1 | <ul style="list-style-type: none"> Scalar Column vector (M-by-1) Row vector (1-by-M) | <ul style="list-style-type: none"> Scalar Column vector (M-by-1) Row vector (1-by-M) |
| <ul style="list-style-type: none"> Row vector (1-by-N) Column vector (N-by-1) Unoriented vector (N) | N | <ul style="list-style-type: none"> Scalar Column vector (M-by-1) Row vector (1-by-M) Matrix (M-by-N) | <ul style="list-style-type: none"> Scalar |
| <ul style="list-style-type: none"> Matrix (K-by-N) | $K \times N$ | <ul style="list-style-type: none"> Scalar Column vector (M-by-1) Row vector (1-by-M) Matrix (M-by-$(K \times N)$) | <ul style="list-style-type: none"> Scalar |

When the **Initial states** is a scalar, the block initializes all filter states to the same scalar value. Enter 0 to initialize all states to zero. When the **Initial states** is a vector or a matrix, each vector or matrix element specifies a unique initial state. This unique state corresponds to a delay element in a corresponding channel:

- The vector length must equal the number of delay elements in the filter, $M = \max(\text{number of zeros, number of poles})$.
- The matrix must have the same number of rows as the number of delay elements in the filter, $M = \max(\text{number of zeros, number of poles})$. The matrix must also have one column for each channel of the input signal.

The “Specify a Vector of Initial Conditions for a Discrete Filter Block” on page 12-140 example shows the relationship between the initial filter output and the initial input and state. Given an initial input u_1 , the first output y_1 is related to the initial state $[x_1, x_2]$ and initial input by:

$$y_1 = b_1 \left[\frac{(u_1 - a_2x_1 - a_3x_2)}{a_1} \right] + b_2x_1 + b_3x_2$$

Ports

Input

u — Input signal

scalar | vector | matrix

Input signal to filter, specified as a scalar, vector, or matrix.

Dependencies

The name of this port depends on the source you specify for the numerator coefficients, denominator coefficients and initial states. When you set **Numerator**, **Denominator**, and **Initial states** to **Dialog**, there is only one input port, and the port is unlabeled. When you set **Numerator**, **Denominator**, or **Initial states** to **Input** port, this port is labeled **u**.

Data Types: single | double | int8 | int16 | int32 | fixed point

Num — Numerator coefficients

scalar | vector | matrix

Numerator coefficients of the discrete filter, specified as descending powers of z . Use a row vector to specify the coefficients for a single numerator polynomial.

Dependencies

To enable this port, set **Numerator** to **Input** port.

Data Types: single | double | int8 | int16 | int32 | fixed point

Den — Denominator coefficients

scalar | vector

Specify the denominator coefficients of the discrete filter as descending powers of z . Use a row vector to specify the coefficients for a single denominator polynomial.

Dependencies

To enable this port, set **Denominator** to **Input** port.

Data Types: single | double | int8 | int16 | int32 | fixed point

x0 — Initial states

scalar | vector | matrix

Initial states, specified as a scalar, vector, or matrix. For more information about specifying states, see “Specifying Initial States” on page 1-345.

Dependencies

To enable this port, set the **Filter structure** to **Direct form II** or **Direct form II transposed**, and set **Initial states** to **Input** port.

Data Types: single | double | int8 | int16 | int32 | fixed point

Output

Port_1 — Filtered output signal

scalar | vector | matrix

Filtered output signal. The output dimensions equal the input dimensions, except when you specify a matrix of filter taps for the **Numerator coefficients** parameter. When you do so, the output dimensions depend on the number of different sets of filter taps you specify.

Data Types: single | double | int8 | int16 | int32 | fixed point

Parameters

Main

Filter structure — Filter structure

Direct form II (default) | Direct form I transposed | Direct form I | Direct form II transposed

Specify the discrete IIR filter structure.

Dependencies

To use any filter structure other than Direct form II, you must have an available DSP System Toolbox license.

Programmatic Use

Block Parameter: FilterStructure

Type: character vector

Values: 'Direct form II' | 'Direct form I transposed' | 'Direct form I' | 'Direct form II transposed'

Default: 'Direct form II'

Numerator Source — Source of numerator coefficients

Dialog (default) | Input port

Specify the source of the numerator coefficients as Dialog or Input port.

Programmatic Use

Block Parameter: NumeratorSource

Type: character vector

Values: 'Dialog' | 'Input port'

Default: 'Dialog'

Numerator Value — Numerator coefficients

[1] (default) | scalar | vector | matrix

Specify the numerator coefficients of the discrete filter as descending powers of z . Use a row vector to specify the coefficients for a single numerator polynomial.

Dependencies

To enable this parameter, set the **Numerator Source** to Dialog.

Programmatic Use

Block Parameter: Numerator

Type: character vector
Values: scalar | vector | matrix
Default: '[1]'

Denominator Source — Source of denominator coefficients

Dialog (default) | Input port

Specify the source of the denominator coefficients as Dialog or Input port.

Programmatic Use

Block Parameter: DenominatorSource

Type: character vector

Values: 'Dialog' | 'Input port'

Default: 'Dialog'

Denominator Value — Denominator coefficients

[1 0.5] (default) | vector

Specify the denominator coefficients of the discrete filter as descending powers of z . Use a row vector to specify the coefficients for a single denominator polynomial.

Dependencies

To enable this parameter, set the **Denominator Source** to Dialog.

Programmatic Use

Block Parameter: Denominator

Type: character vector

Values: scalar | vector

Default: '[1 0.5]'

Initial states Source — Source of initial states

Dialog (default) | Input port

Specify the source of the initial states as Dialog or Input port.

Programmatic Use

Block Parameter: InitialStatesSource

Type: character vector

Values: 'Dialog' | 'Input port'

Default: 'Dialog'

Initial states Value — Initial filter states

0 (default) | scalar | vector | matrix

Specify the initial filter states as a scalar, vector, or matrix. To learn how to specify initial states, see “Specifying Initial States” on page 1-345.

Dependencies

To enable this parameter, set the **Filter structure** to Direct form II or Direct form II transposed, and set **Initial states Source** to Dialog.

Programmatic Use

Block Parameter: InitialStates

Type: character vector

Values: scalar | vector | matrix

Default: '0'

Initial states on numerator side — Initial numerator states

0 (default) | scalar | vector | matrix

Specify the initial numerator filter states as a scalar, vector, or matrix. To learn how to specify initial states, see “Specifying Initial States” on page 1-345.

Dependencies

To enable this port, set the **Filter structure** to Direct form I or Direct form I transposed.

Programmatic Use

Block Parameter: InitialStates

Type: character vector

Values: scalar | vector | matrix

Default: '0'

Initial states on denominator side — Initial denominator states

0 (default) | scalar | vector | matrix

Specify the initial denominator filter states as a scalar, vector, or matrix. To learn how to specify initial states, see “Specifying Initial States” on page 1-345.

Dependencies

To enable this port, set the **Filter structure** to Direct form I or Direct form I transposed.

Programmatic Use

Block Parameter: InitialDenominatorStates

Type: character vector

Values: scalar | vector | matrix

Default: '0'

External reset — External state reset

None (default) | Rising | Falling | Either | Level | Level hold

Specify the trigger event to use to reset the states to the initial conditions.

| Reset Mode | Behavior |
|------------|--|
| None | No reset |
| Rising | Reset on a rising edge |
| Falling | Reset on a falling edge |
| Either | Reset on either a rising or falling edge |
| Level | Reset in either of these cases: <ul style="list-style-type: none"> When the reset signal is nonzero at the current time step When the reset signal value changes from nonzero at the previous time step to zero at the current time step |

| Reset Mode | Behavior |
|------------|---|
| Level hold | Reset when the reset signal is nonzero at the current time step |

Programmatic Use**Block Parameter:** ExternalReset**Type:** character vector**Values:** 'None' | 'Rising' | 'Falling' | 'Either' | 'Level' | 'Level hold'**Default:** 'None'**Input processing — Sample- or frame-based processing**

Elements as channels (sample based) (default) | Columns as channels (frame based)

Specify whether the block performs sample- or frame-based processing.

- Elements as channels (sample based) — Process each element of the input as an independent channel.
- Columns as channels (frame based) — Process each column of the input as an independent channel.

Dependencies

Frame-based processing requires a DSP System Toolbox license.

For more information, see “Sample- and Frame-Based Concepts” (DSP System Toolbox).

Programmatic Use**Block Parameter:** InputProcessing**Type:** character vector**Values:** 'Columns as channels (frame based)' | 'Elements as channels (sample based)'**Default:** 'Elements as channels (sample based)'**Optimize by skipping divide by leading denominator coefficient (a_0) — Skip divide by a_0**

off (default) | on

Select when the leading denominator coefficient, a_0 , equals one. This parameter optimizes your code.When you select this check box, the block does not perform a divide-by- a_0 either in simulation or in the generated code. An error occurs if a_0 is not equal to one.When you clear this check box, the block is fully tunable during simulation. It performs a divide-by- a_0 in both simulation and code generation.**Programmatic Use****Block Parameter:** a0EqualsOne**Type:** character vector**Values:** 'off' | 'on'**Default:** 'off'**Sample time (-1 for inherited) — Interval between samples**

-1 (default) | scalar | vector

Specify the time interval between samples. To inherit the sample time, set this parameter to -1. For more information, see “Specify Sample Time”.

Programmatic Use

Block Parameter: SampleTime

Type: character vector

Values: scalar | vector

Default: '-1'

Data Types

State — State data type

Inherit: Same as input (default) | int8 | int16 | int32 | int64 | fixdt(1,16,0) | <data type expression>

Specify the state data type. You can set this parameter to:

- A rule that inherits a data type, for example, Inherit: Same as input
- A built-in integer, for example, int8
- A data type object, for example, a Simulink.NumericType object
- An expression that evaluates to a data type, for example, fixdt(1,16,0)

Click the **Show data type assistant** button  to display the **Data Type Assistant**, which helps you set the data type attributes. For more information, see “Specify Data Types Using Data Type Assistant”.

Programmatic Use

Block Parameter: StateDataTypeStr

Type: character vector

Values: 'Inherit: Same as input' | 'int8' | 'int16' | 'int32' | 'int64' | 'fixdt(1,16,0)' | '<data type expression>'

Default: 'Inherit: Same as input'

Numerator coefficients — Numerator coefficient data type

Inherit: Inherit via internal rule (default) | int8 | int16 | int32 | int64 | fixdt(1,16) | fixdt(1,16,0) | <data type expression>

Specify the numerator coefficient data type. You can set this parameter to:

- A rule that inherits a data type, for example, Inherit: Inherit via internal rule
- A built-in signed integer, for example, int8
- A data type object, for example, a Simulink.NumericType object
- An expression that evaluates to a data type, for example, fixdt(1,16,0)

Click the **Show data type assistant** button  to display the **Data Type Assistant**, which helps you set the data type attributes. For more information, see “Specify Data Types Using Data Type Assistant”.

Programmatic Use

Block Parameter: NumCoeffDataTypeStr

Type: character vector

Values: 'Inherit: Inherit via internal rule' | 'int8' | 'int16' | 'int32' | 'int64' | 'fixdt(1,16)' | 'fixdt(1,16,0)' | '<data type expression>
Default: 'Inherit: Inherit via internal rule'

Numerator coefficient minimum – Minimum value of numerator coefficients

[] (default) | scalar

Specify the minimum value that a numerator coefficient can have. The default value is [] (unspecified). Simulink software uses this value to perform:

- Parameter range checking (see “Specify Minimum and Maximum Values for Block Parameters”)
- Automatic scaling of fixed-point data types

Programmatic Use

Block Parameter: NumCoeffMin

Type: character vector

Values: scalar

Default: '[]'

Numerator coefficient maximum – Maximum value of numerator coefficients

[] (default) | scalar

Specify the maximum value that a numerator coefficient can have. The default value is [] (unspecified). Simulink software uses this value to perform:

- Parameter range checking (see “Specify Minimum and Maximum Values for Block Parameters”)
- Automatic scaling of fixed-point data types

Programmatic Use

Block Parameter: NumCoeffMax

Type: character vector

Values: scalar

Default: '[]'

Numerator product output – Numerator product output data type

Inherit: Inherit via internal rule (default) | Inherit: Same as input | int8 | int16 | int32 | int64 | fixdt(1,16,0) | <data type expression>

Specify the product output data type for the numerator coefficients. You can set this parameter to:

- A rule that inherits a data type, for example, Inherit: Inherit via internal rule
- A built-in data type, for example, int8
- A data type object, for example, a Simulink.NumericType object
- An expression that evaluates to a data type, for example, fixdt(1,16,0)

Click the **Show data type assistant** button  to display the **Data Type Assistant**, which helps you set the data type attributes. For more information, see “Specify Data Types Using Data Type Assistant”.

Programmatic Use

Block Parameter: NumProductDataTypeStr

Type: character vector

Values: 'Inherit: Inherit via internal rule' | 'Inherit: Same as input' | 'int8' | 'int16' | 'int32' | 'int64' | 'fixdt(1,16,0)' | '<data type expression>'

Default: 'Inherit: Inherit via internal rule'

Numerator accumulator — Numerator accumulator data type

Inherit: Inherit via internal rule (default) | Inherit: Same as input | Inherit: Same as product output | int8 | int16 | int32 | int64 | fixdt(1,16,0) | <data type expression>

Specify the accumulator data type for the numerator coefficients. You can set this parameter to:

- A rule that inherits a data type, for example, Inherit: Inherit via internal rule
- A built-in data type, for example, int8
- A data type object, for example, a Simulink.NumericType object
- An expression that evaluates to a data type, for example, fixdt(1,16,0)

Click the **Show data type assistant** button  to display the **Data Type Assistant**, which helps you set the data type attributes. For more information, see “Specify Data Types Using Data Type Assistant”.

Programmatic Use

Block Parameter: NumAccumDataTypeStr

Type: character vector

Values: 'Inherit: Inherit via internal rule' | 'Inherit: Same as input' | 'Inherit: Same as product output' | 'int8' | 'int16' | 'int32' | 'int64' | 'fixdt(1,16,0)' | '<data type expression>'

Default: 'Inherit: Inherit via internal rule'

Denominator coefficients — Denominator coefficient data type

Inherit: Inherit via internal rule (default) | int8 | int16 | int32 | int64 | fixdt(1,16) | fixdt(1,16,0) | <data type expression>

Specify the denominator coefficient data type. You can set this parameter to:

- A rule that inherits a data type, for example, Inherit: Inherit via internal rule
- A built-in integer, for example, int8
- A data type object, for example, a Simulink.NumericType object
- An expression that evaluates to a data type, for example, fixdt(1,16,0)

Click the **Show data type assistant** button  to display the **Data Type Assistant**, which helps you set the data type attributes. For more information, see “Specify Data Types Using Data Type Assistant”.

Programmatic Use

Block Parameter: DenCoeffDataTypeStr

Type: character vector

Values: 'Inherit: Inherit via internal rule' | 'int8' | 'int16' | 'int32' | 'int64' | 'fixdt(1,16)' | 'fixdt(1,16,0)' | '<data type expression>'

Default: 'Inherit: Inherit via internal rule'

Denominator coefficient minimum — Minimum value of denominator coefficients

[] (default) | scalar

Specify the minimum value that a denominator coefficient can have. The default value is [] (unspecified). Simulink software uses this value to perform:

- Parameter range checking (see “Specify Minimum and Maximum Values for Block Parameters”)
- Automatic scaling of fixed-point data types

Programmatic Use**Block Parameter:** DenCoeffMin**Type:** character vector**Values:** scalar**Default:** ' [] '**Denominator coefficient maximum — Maximum value of denominator coefficients**

[] (default) | scalar

Specify the maximum value that a denominator coefficient can have. The default value is [] (unspecified). Simulink software uses this value to perform:

- Parameter range checking (see “Specify Minimum and Maximum Values for Block Parameters”)
- Automatic scaling of fixed-point data types

Programmatic Use**Block Parameter:** DenCoeffMax**Type:** character vector**Values:** scalar**Default:** ' [] '**Denominator product output — Denominator product output data type**

Inherit: Inherit via internal rule (default) | Inherit: Same as input | int8 | int16 | int32 | int64 | fixdt(1,16,0) | <data type expression>

Specify the product output data type for the denominator coefficients. You can set this parameter to:

- A rule that inherits a data type, for example, Inherit: Inherit via internal rule
- A built-in data type, for example, int8
- A data type object, for example, a Simulink.NumericType object
- An expression that evaluates to a data type, for example, fixdt(1,16,0)

Click the **Show data type assistant** button  to display the **Data Type Assistant**, which helps you set the data type attributes. For more information, see “Specify Data Types Using Data Type Assistant”.

Programmatic Use**Block Parameter:** DenProductDataTypeStr**Type:** character vector

Values: 'Inherit: Inherit via internal rule' | 'Inherit: Same as input' | 'int8' | 'int16' | 'int32' | 'int64' | 'fixdt(1,16,0)' | '<data type expression>'

Default: 'Inherit: Inherit via internal rule'

Denominator accumulator — Denominator accumulator data type

Inherit: Inherit via internal rule (default) | Inherit: Same as input | Inherit: Same as product output | int8 | int16 | int32 | int64 | fixdt(1,16,0) | <data type expression>

Specify the accumulator data type for the denominator coefficients. You can set this parameter to:

- A rule that inherits a data type, for example, Inherit: Inherit via internal rule
- A built-in data type, for example, int8
- A data type object, for example, a Simulink.NumericType object
- An expression that evaluates to a data type, for example, fixdt(1,16,0)

Click the **Show data type assistant** button  to display the **Data Type Assistant**, which helps you set the data type attributes. For more information, see “Specify Data Types Using Data Type Assistant”.

Programmatic Use

Block Parameter: DenAccumDataTypeStr

Type: character vector

Values: 'Inherit: Inherit via internal rule' | 'Inherit: Same as input' | 'Inherit: Same as product output' | 'int8' | 'int16' | 'int32' | 'int64' | 'fixdt(1,16,0)' | '<data type expression>'

Default: 'Inherit: Inherit via internal rule'

Output — Output data type

Inherit: Inherit via internal rule (default) | int8 | int16 | int32 | int64 | fixdt(1,16) | fixdt(1,16,0) | <data type expression>

Specify the output data type. You can set this parameter to:

- A rule that inherits a data type, for example, Inherit: Inherit via internal rule
- A built-in data type, for example, int8
- A data type object, for example, a Simulink.NumericType object
- An expression that evaluates to a data type, for example, fixdt(1,16,0)

Click the **Show data type assistant** button  to display the **Data Type Assistant**, which helps you set the data type attributes. For more information, see “Specify Data Types Using Data Type Assistant”.

Programmatic Use

Block Parameter: OutDataTypeStr

Type: character vector

Values: 'Inherit: Inherit via internal rule' | 'int8' | 'int16' | 'int32' | 'int64' | 'fixdt(1,16)' | 'fixdt(1,16,0)' | '<data type expression>'

Default: 'Inherit: Inherit via internal rule'

Output minimum — Minimum value of output

[] (default) | scalar

Specify the minimum value that the block can output. The default value is [] (unspecified). Simulink software uses this value to perform:

- Simulation range checking (see “Specify Signal Ranges”)
- Automatic scaling of fixed-point data types

Programmatic Use**Block Parameter:** OutMin**Type:** character vector**Values:** scalar**Default:** ' [] '**Output maximum — Maximum value of output**

[] (default) | scalar

Specify the maximum value that the block can output. The default value is [] (unspecified). Simulink software uses this value to perform:

- Simulation range checking (see “Specify Signal Ranges”)
- Automatic scaling of fixed-point data types

Programmatic Use**Block Parameter:** OutMax**Type:** character vector**Values:** scalar**Default:** ' [] '**Multiplicand data type — Multiplicand data type**

Inherit: Same as input (default) | int8 | int16 | int32 | int64 | fixdt(1,16,0) | <data type expression>

Specify the multiplicand data type. You can set this parameter to:

- A rule that inherits a data type, for example, Inherit: Same as input
- A built-in data type, for example, int8
- A data type object, for example, a Simulink.NumericType object
- An expression that evaluates to a data type, for example, fixdt(1,16,0)

Click the **Show data type assistant** button  to display the **Data Type Assistant**, which helps you set the data type attributes. For more information, see “Specify Data Types Using Data Type Assistant”.

Dependencies

To enable this parameter, set the **Filter structure** to Direct form I transposed

Programmatic Use**Block Parameter:** MultiplicandDataTypeStr**Type:** character vector**Values:** 'Inherit: Same as input' | 'int8' | 'int16' | 'int32' | 'int64' | 'fixdt(1,16,0)' | '<data type expression>'**Default:** 'Inherit: Same as input'**Lock data type settings against changes by the fixed-point tools — Prevent fixed-point tools from overriding data types**

off (default) | on

Select to lock data type settings of this block against changes by the Fixed-Point Tool and the Fixed-Point Advisor. For more information, see “Lock the Output Data Type Setting” (Fixed-Point Designer).

Programmatic Use

Block Parameter: LockScale

Values: 'off' | 'on'

Default: 'off'

Integer rounding mode — Rounding mode for fixed-point operations

Floor (default) | Ceiling | Convergent | Nearest | Round | Simplest | Zero

Specify the rounding mode for fixed-point operations. For more information, see “Rounding” (Fixed-Point Designer).

Programmatic Use

Block Parameter: RndMeth

Type: character vector

Values: 'Ceiling' | 'Convergent' | 'Floor' | 'Nearest' | 'Round' | 'Simplest' | 'Zero'

Default: 'Floor'

Saturate on integer overflow — Method of overflow action

off (default) | on

Specify whether overflows saturate or wrap.

| Action | Rationale | Impact on Overflows | Example |
|-----------------------------|--|---|--|
| Select this check box (on). | Your model has possible overflow, and you want explicit saturation protection in the generated code. | Overflows saturate to either the minimum or maximum value that the data type can represent. | The maximum value that the <code>int8</code> (signed, 8-bit integer) data type can represent is 127. Any block operation result greater than this maximum value causes overflow of the 8-bit integer. With the check box selected, the block output saturates at 127. Similarly, the block output saturates at a minimum output value of -128. |

| Action | Rationale | Impact on Overflows | Example |
|-------------------------------------|--|---|---|
| Do not select this check box (off). | <p>You want to optimize efficiency of your generated code.</p> <p>You want to avoid overspecifying how a block handles out-of-range signals. For more information, see “Troubleshoot Signal Range Errors”.</p> | Overflows wrap to the appropriate value that is representable by the data type. | The maximum value that the <code>int8</code> (signed, 8-bit integer) data type can represent is 127. Any block operation result greater than this maximum value causes overflow of the 8-bit integer. With the check box cleared, the software interprets the overflow-causing value as <code>int8</code> , which can produce an unintended result. For example, a block result of 130 (binary 1000 0010) expressed as <code>int8</code> , is -126. |

When you select this check box, saturation applies to every internal operation on the block, not just the output, or result. Usually, the code generation process can detect when overflow is not possible. In this case, the code generator does not produce saturation code.

Programmatic Use

Block Parameter: `SaturateOnIntegerOverflow`

Type: character vector

Values: 'off' | 'on'

Default: 'off'

State Attributes

State name — Assign unique name to each state

' ' (default) | 'position' | {'a', 'b', 'c'} | a | ...

Assign a unique name to each state. If this field is blank (' '), no name assignment occurs.

- To assign a name to a single state, enter the name between quotes, for example, 'position'.
- To assign names to multiple states, enter a comma-delimited list surrounded by braces, for example, {'a', 'b', 'c'}. Each name must be unique.
- To assign state names with a variable in the MATLAB workspace, enter the variable without quotes. A variable can be a character vector, cell array, or structure.

Limitations

- The state names apply only to the selected block.
- The number of states must divide evenly among the number of state names.
- You can specify fewer names than states, but you cannot specify more names than states.

For example, you can specify two names in a system with four states. The first name applies to the first two states and the second name to the last two states.

Dependencies

To enable this parameter, set **Filter structure** to `Direct form II`.

Programmatic Use**Block Parameter:** StateName**Type:** character vector**Values:** ' ' | user-defined**Default:** ' '**State name must resolve to Simulink signal object – Require state name resolve to a signal object**

off (default) | on

Select this check box to require that the state name resolves to a Simulink signal object.

Dependencies

To enable this parameter, set **Filter structure** to `Direct form II` and specify a value for **State name**. This parameter appears only if you set the model configuration parameter **Signal resolution** to a value other than `None`.

Programmatic Use**Block Parameter:** StateMustResolveToSignalObject**Type:** character vector**Values:** 'off' | 'on'**Default:** 'off'**Block Characteristics**

| | |
|---------------------------------|---|
| Data Types | double fixed point ^a integer ^a single |
| Direct Feedthrough | no |
| Multidimensional Signals | no |
| Variable-Size Signals | no |
| Zero-Crossing Detection | no |

a. This block only supports signed fixed-point data types.

Extended Capabilities**C/C++ Code Generation**

Generate C and C++ code using Simulink® Coder™.

PLC Code Generation

Generate Structured Text code using Simulink® PLC Coder™.

Fixed-Point Conversion

Design and simulate fixed-point systems using Fixed-Point Designer™.

This block only supports signed fixed-point data types.

The Discrete Filter block accepts and outputs real and complex signals of any signed numeric data type that Simulink supports. The block supports the same types for the numerator and denominator coefficients.

Numerator and denominator coefficients must have the same complexity. They can have different word lengths and fraction lengths.

The following diagrams show the filter structure and the data types used within the Discrete Filter block for fixed-point signals.

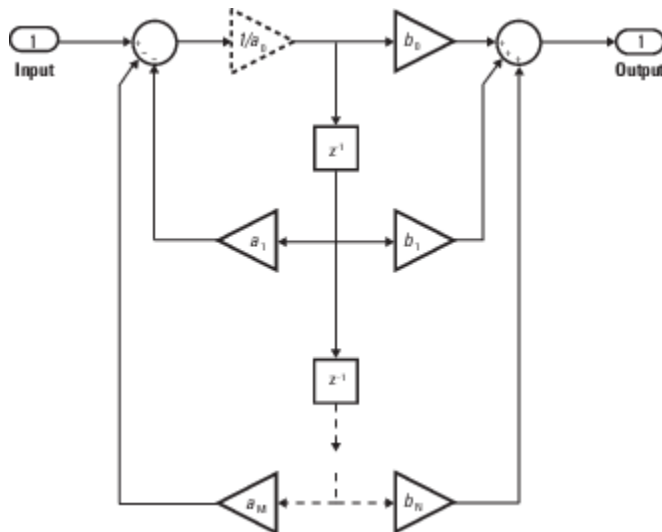

The block omits the dashed divide when you select the **Optimize by skipping divide by leading denominator coefficient (a0)** parameter.

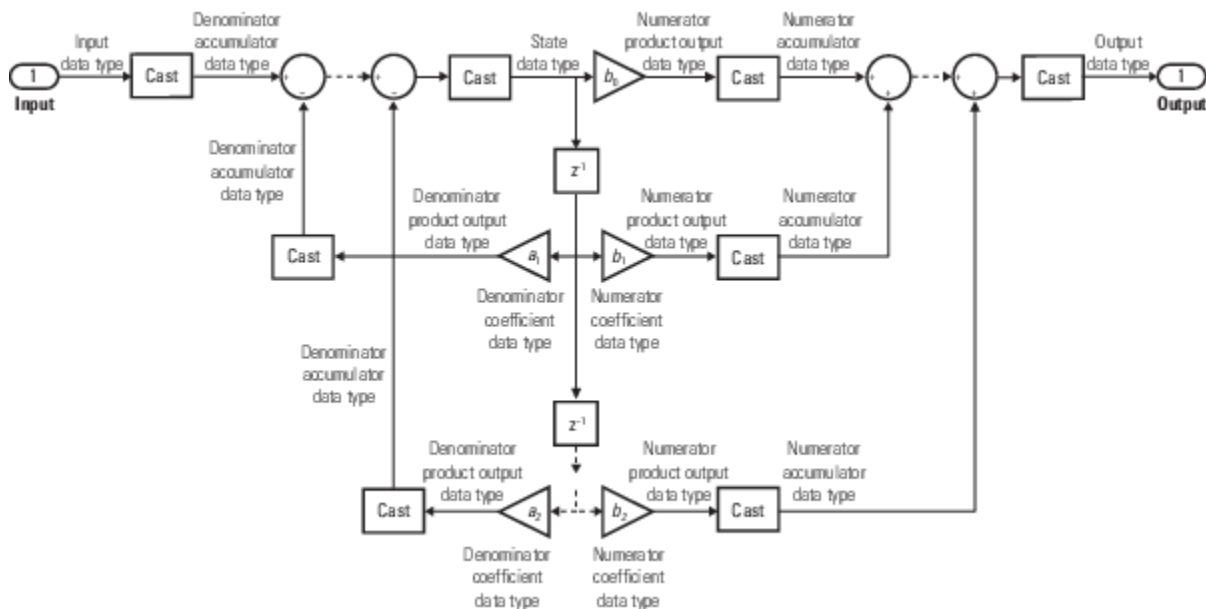

See Also

Discrete FIR Filter | Allpole Filter | Digital Filter Design | Filter Realization Wizard | dsp.IIRFilter | dsp.AllpoleFilter | filterDesigner | fvtool

Topics

“Sample- and Frame-Based Concepts” (DSP System Toolbox)

“Working with States” on page 11-21

Introduced before R2006a

Discrete FIR Filter

Model FIR filters

Library: Simulink / Discrete
HDL Coder / Discrete
HDL Coder / HDL Floating Point Operations

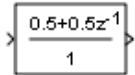

Description

The Discrete FIR Filter block independently filters each channel of the input signal with the specified digital FIR filter. The block can implement static filters with fixed coefficients, and time-varying filters with coefficients that change over time. You can tune the coefficients of a static filter during simulation.

This block filters each channel of the input signal independently over time. The **Input processing** parameter allows you to specify whether the block treats each element of the input as an independent channel (sample-based processing), or each column of the input as an independent channel (frame-based processing). To perform frame-based processing, you must have a DSP System Toolbox license.

The output dimensions equal the input dimensions, except when you specify a matrix of filter taps for the **Coefficients** parameter. When you do so, the output dimensions depend on the number of different sets of filter taps you specify.

This block supports custom state attributes to customize and generate code more efficiently. For an example, see “Custom State Attributes in Discrete FIR Filter block”. Under certain conditions, the block also supports SIMD code generation. For details, see “Code Generation” on page 1-375.

The outputs of this block numerically match the outputs of the DSP System Toolbox Digital Filter Design block.

This block supports the Simulink state logging feature. For more information, see “State”.

Filter Structure Support

You can change the filter structure implemented with the Discrete FIR Filter block by selecting one of the following from the **Filter structure** parameter:

- Direct form
- Direct form symmetric
- Direct form antisymmetric
- Direct form transposed
- Lattice MA

You must have an available DSP System Toolbox license to run a model with any of these filter structures other than `Direct form`.

Specifying Initial States

The Discrete FIR Filter block initializes the internal filter states to zero by default, which has the same effect as assuming that past inputs and outputs are zero. You can optionally use the **Initial states** parameter to specify nonzero initial conditions for the filter delays.

To determine the number of initial states you must specify and how to specify them, see the table on valid initial states. The **Initial states** parameter can take one of the forms described in the next table.

Valid Initial States

| Initial Condition | Description |
|---|---|
| Scalar | The block initializes all delay elements in the filter to the scalar value. |
| Vector or matrix (for applying different delay elements to each channel) | <p>Each vector or matrix element specifies a unique initial condition for a corresponding delay element in a corresponding channel:</p> <ul style="list-style-type: none"> The vector length equals the product of the number of input channels and the number of delay elements in the filter, <code>#_of_filter_coeffs-1</code> (or <code>#_of_reflection_coeffs</code> for Lattice MA). The matrix must have the same number of rows as the number of delay elements in the filter, <code>#_of_filter_coeffs-1</code> (<code>#_of_reflection_coeffs</code> for Lattice MA), and must have one column for each channel of the input signal. |

Ports

Input

In — Input signal

scalar | vector | matrix

Input signal to filter, specified as a scalar, vector, or matrix.

Dependencies

When you set **Coefficient source** to Dialog parameters, the port for the input signal is unlabeled. When you set **Coefficient source** to Input port, the port for the input signal is labeled **In**.

Data Types: single | double | int8 | int16 | int32 | int64 | uint8 | uint16 | uint32 | uint64 | fixed point

Num — Filter coefficients

scalar | vector | matrix

Specify the filter coefficients as a scalar, vector, or matrix. When you specify a row vector of filter taps, the block applies a single filter to the input. To apply multiple filters to the same input, specify a matrix of coefficients, where each row represents a different set of filter taps.

Dependencies

To enable this port, set **Coefficient source** to Input port.

To implement multiple filters, **Filter structure** must be Direct form, and the input must be a scalar.

Data Types: single | double | int8 | int16 | int32 | int64 | uint8 | uint16 | uint32 | uint64 | fixed point

External reset — External reset signal

scalar

External reset signal, specified as a scalar. When the specified trigger event occurs, the block resets the states to their initial conditions.

Tip The icon for this port changes based on the value of the **External reset** parameter.

Dependencies

To enable this port, set **External reset** to Rising, Falling, Either, Level, or Level hold.

Data Types: single | double | int8 | int16 | int32 | int64 | uint8 | uint16 | uint32 | uint64 | fixed point

□ — Enable signal

scalar

Enable signal, specified as a scalar. This port can control execution of the block. The block is enabled when the input to this port is nonzero, and is disabled when the input is 0. The value of the input is checked at the same time step as the block execution.

Dependencies

To enable this port, select the **Show enable port** check box.

Data Types: single | double | int8 | int16 | int32 | int64 | uint8 | uint16 | uint32 | uint64 | fixed point

Output

Port_1 — Filtered output signal

scalar | vector | matrix

Filtered output signal.

Data Types: single | double | int8 | int16 | int32 | int64 | uint8 | uint16 | uint32 | uint64 | fixed point

Parameters

Main

Coefficient source — Source of coefficients

Dialog parameters (default) | Input port

Choose to specify the filter coefficients using tunable dialog parameters or through an input port, which is useful for time-varying coefficients.

Programmatic Use

Block Parameter: CoefSource

Type: character vector

Values: 'Dialog parameters' | 'Input port'

Default: 'Dialog parameters'

Filter structure — Filter structure

Direct form (default) | Direct form symmetric | Direct form antisymmetric | Direct form transposed | Lattice MA

Select the filter structure you want the block to implement.

Dependencies

You must have an available DSP System Toolbox license to run a model with a Discrete FIR Filter block that implements any filter structure other than Direct form.

Programmatic Use

Block Parameter: FilterStructure

Type: character vector

Values: 'Direct form' | 'Direct form symmetric' | 'Direct form antisymmetric' | 'Direct form transposed' | 'Lattice MA'

Default: 'Direct form'

Coefficients — Filter coefficients

[0.5 0.5] (default) | vector | matrix

Specify the coefficient vector for the transfer function. Filter coefficients must be specified as a row vector. When you specify a row vector of filter taps, the block applies a single filter to the input. To apply multiple filters to the same input, specify a matrix of coefficients, where each row represents a different set of filter taps.

Dependencies

To enable this parameter, set **Coefficient source** to Dialog parameters.

To implement multiple filters, **Filter structure** must be Direct form, and the input must be a scalar.

Programmatic Use

Block Parameter: Coefficients

Type: character vector

Values: vector

Default: '[0.5 0.5]'

Input processing — Sample- or frame-based processing

Elements as channels (sample based) (default) | Columns as channels (frame based)

Specify whether the block performs sample- or frame-based processing. You can select one of the following options:

- Elements as channels (sample based) — Treat each element of the input as an independent channel (sample-based processing).
- Columns as channels (frame based) — Treat each column of the input as an independent channel (frame-based processing).

Note Frame-based processing requires a DSP System Toolbox license.

For more information, see “Sample- and Frame-Based Concepts” (DSP System Toolbox).

Programmatic Use

Block Parameter: InputProcessing

Type: character vector

Values: 'Columns as channels (frame based)' | 'Elements as channels (sample based)'

Default: 'Elements as channels (sample based)'

Initial states — Initial conditions of filter states

0 (default) | scalar | vector | matrix

Specify the initial conditions of the filter states. To learn how to specify initial states, see “Specifying Initial States” on page 1-365.

Programmatic Use

Block Parameter: InitialStates

Type: character vector

Values: scalar | vector | matrix

Default: '0'

Show enable port — Create enable port

off (default) | on

Select to control execution of this block with an enable port. The block is considered enabled when the input to this port is nonzero, and is disabled when the input is 0. The value of the input is checked at the same time step as the block execution.

Programmatic Use

Block Parameter: ShowEnablePort

Type: character vector

Values: 'off' | 'on'

Default: 'off'

External reset — External state reset

None (default) | Rising | Falling | Either | Level | Level hold

Specify the trigger event to use to reset the states to the initial conditions.

| Reset Mode | Behavior |
|------------|--|
| None | No reset |
| Rising | Reset on a rising edge |
| Falling | Reset on a falling edge |
| Either | Reset on either a rising or falling edge |
| Level | Reset in either of these cases: <ul style="list-style-type: none"> When the reset signal is nonzero at the current time step When the reset signal value changes from nonzero at the previous time step to zero at the current time step |

| Reset Mode | Behavior |
|------------|---|
| Level hold | Reset when the reset signal is nonzero at the current time step |

Programmatic Use**Block Parameter:** ExternalReset**Type:** character vector**Values:** 'None' | 'Rising' | 'Falling' | 'Either' | 'Level' | 'Level hold'**Default:** 'None'**Sample time (-1 for inherited) – Time interval between samples**

-1 (default) | scalar | vector

Specify the time interval between samples. To inherit the sample time, set this parameter to -1. For more information, see “Specify Sample Time”.

Programmatic Use**Block Parameter:** SampleTime**Type:** character vector**Values:** scalar | vector**Default:** '-1'**Data Types****Tap sum – Tap sum data type**

Inherit: Same as input (default) | Inherit: Inherit via internal rule | int8 | uint8 | int16 | uint16 | int32 | uint32 | int64 | uint64 | fixdt(1,16,0) | <data type expression>

Specify the tap sum data type of a direct form symmetric or direct form antisymmetric filter, which is the data type the filter uses when it sums the inputs prior to multiplication by the coefficients. You can set it to:

- A rule that inherits a data type, for example, Inherit: Inherit via internal rule
- A built-in integer, for example, int8
- A data type object, for example, a Simulink.NumericType object
- An expression that evaluates to a data type, for example, fixdt(1,16,0)

Click the **Show data type assistant** button  to display the **Data Type Assistant**, which helps you set the data type attributes. For more information, see “Specify Data Types Using Data Type Assistant”.

Dependencies

This parameter is only visible when you set the **Filter structure** to Direct form symmetric or Direct form antisymmetric.

Programmatic Use**Block Parameter:** TapSumDataTypeStr**Type:** character vector

Values: 'Inherit: Same as input' | 'int8' | 'uint8' | 'int16' | 'uint16' | 'int32' | 'uint32' | 'int64' | 'uint64' | 'fixdt(1,16,0)' | '<data type expression>'

Default: 'Inherit: Same as input'

Coefficients — Coefficient data type

Inherit: Same wordlength as input (default) | int8 | uint8 | int16 | uint16 | int32 | uint32 | int64 | uint64 | fixdt(1,16,0) | <data type expression>

Specify the coefficient data type. You can set it to:

- A rule that inherits a data type, for example, Inherit: Same word length as input
- A built-in integer, for example, int8
- A data type object, for example, a Simulink.NumericType object
- An expression that evaluates to a data type, for example, fixdt(1,16,0)

Click the **Show data type assistant** button  to display the **Data Type Assistant**, which helps you set the data type attributes. For more information, see “Specify Data Types Using Data Type Assistant”.

Programmatic Use

Block Parameter: CoeffDataTypeStr

Type: character vector

Values: 'Inherit: Same word length as input' | 'int8' | 'uint8' | 'int16' | 'uint16' | 'int32' | 'uint32' | 'int64' | 'uint64' | 'fixdt(1,16)' | 'fixdt(1,16,0)' | '<data type expression>'

Default: 'Inherit: Same wordlength as input'

Coefficients minimum — Minimum value of coefficients

[] (default) | scalar

Specify the minimum value that a filter coefficient should have. The default value is [] (unspecified). Simulink software uses this value to perform:

- Parameter range checking (see “Specify Minimum and Maximum Values for Block Parameters”)
- Automatic scaling of fixed-point data types

Programmatic Use

Block Parameter: CoeffMin

Type: character vector

Values: scalar

Default: '[]'

Coefficients maximum — Maximum value of coefficients

[] (default) | scalar

Specify the maximum value that a filter coefficient should have. The default value is [] (unspecified). Simulink software uses this value to perform:

- Parameter range checking (see “Specify Minimum and Maximum Values for Block Parameters”)
- Automatic scaling of fixed-point data types

Programmatic Use**Block Parameter:** CoeffMax**Type:** character vector**Values:** scalar**Default:** '[]'**Product output — Product output data type**

Inherit: Inherit via internal rule (default) | Inherit: Same as input | int8 | uint8 | int16 | uint16 | int32 | uint32 | int64 | uint64 | fixdt(1,16,0) | <data type expression>

Specify the product output data type. You can set it to:

- A rule that inherits a data type, for example, Inherit: Inherit via internal rule
- A built-in data type, for example, int8
- A data type object, for example, a Simulink.NumericType object
- An expression that evaluates to a data type, for example, fixdt(1,16,0)

Click the **Show data type assistant** button  to display the **Data Type Assistant**, which helps you set the data type attributes. For more information, see “Specify Data Types Using Data Type Assistant”.

Programmatic Use**Block Parameter:** ProductDataTypeStr**Type:** character vector

Values: 'Inherit: Inherit via internal rule' | 'Inherit: Same as input' | 'int8' | 'uint8' | 'int16' | 'uint16' | 'int32' | 'uint32' | 'int64' | 'uint64' | 'fixdt(1,16,0)' | '<data type expression>'

Default: 'Inherit: Inherit via internal rule'**Accumulator — Accumulator data type**

Inherit: Inherit via internal rule (default) | Inherit: Same as input | Inherit: Same as product output | int8 | uint8 | int16 | uint16 | int32 | uint32 | int64 | uint64 | fixdt(1,16,0) | <data type expression>

Specify the accumulator data type. You can set it to:

- A rule that inherits a data type, for example, Inherit: Inherit via internal rule
- A built-in data type, for example, int8
- A data type object, for example, a Simulink.NumericType object
- An expression that evaluates to a data type, for example, fixdt(1,16,0)

Click the **Show data type assistant** button  to display the **Data Type Assistant**, which helps you set the data type attributes. For more information, see “Specify Data Types Using Data Type Assistant”.

Programmatic Use**Block Parameter:** AccumDataTypeStr**Type:** character vector

Values: 'Inherit: Inherit via internal rule' | 'Inherit: Same as input' | 'Inherit: Same as product output' | 'int8' | 'uint8' | 'int16' | 'uint16' | 'int32' | 'uint32' | 'int64' | 'uint64' | 'fixdt(1,16,0)' | '<data type expression>'

Default: 'Inherit: Inherit via internal rule'

State — State data type

Inherit: Same as accumulator (default) | Inherit: Same as input | int8 | uint8 | int16 | uint16 | int32 | uint32 | int64 | uint64 | fixdt(1,16,0) | <data type expression>

Specify the state data type. You can set it to:

- A rule that inherits a data type, for example, Inherit: Same as accumulator
- A built-in integer, for example, int8
- A data type object, for example, a Simulink.NumericType object
- An expression that evaluates to a data type, for example, fixdt(1,16,0)

Dependencies

To enable this parameter, set the **Filter structure** to Lattice MA.

Programmatic Use

Block Parameter: StateDataTypeStr

Type: character vector

Values: 'Inherit: Same as accumulator' | 'Inherit: Same as input' | 'int8' | 'uint8' | 'int16' | 'uint16' | 'int32' | 'uint32' | 'int64' | 'uint64' | 'fixdt(1,16,0)' | '<data type expression>'

Default: 'Inherit: Same as accumulator'

Output — Output data type

Inherit: Same as accumulator (default) | Inherit: Same as input | int8 | uint8 | int16 | uint16 | int32 | uint32 | int64 | uint64 | fixdt(1,16) | fixdt(1,16,0) | <data type expression>

Specify the output data type. You can set it to:

- A rule that inherits a data type, for example, Inherit: Same as accumulator
- A built-in data type, for example, int8
- A data type object, for example, a Simulink.NumericType object
- An expression that evaluates to a data type, for example, fixdt(1,16,0)

Click the **Show data type assistant** button  to display the **Data Type Assistant**, which helps you set the data type attributes. For more information, see “Specify Data Types Using Data Type Assistant”.

Programmatic Use

Block Parameter: OutDataTypeStr

Type: character vector

Values: 'Inherit: Same as accumulator' | 'Inherit: Same as input' | 'int8' | 'uint8' | 'int16' | 'uint16' | 'int32' | 'uint32' | 'int64' | 'uint64' | 'fixdt(1,16)' | 'fixdt(1,16,0)' | '<data type expression>'

Default: 'Inherit: Same as accumulator'

Output minimum — Minimum output value for range checking

[] (default) | scalar

Lower value of the output range that Simulink checks.

Simulink uses the minimum to perform:

- Parameter range checking (see “Specify Minimum and Maximum Values for Block Parameters”) for some blocks.
- Simulation range checking (see “Specify Signal Ranges” and “Enable Simulation Range Checking”).
- Automatic scaling of fixed-point data types.
- Optimization of the code that you generate from the model. This optimization can remove algorithmic code and affect the results of some simulation modes such as SIL or external mode. For more information, see “Optimize using the specified minimum and maximum values” (Embedded Coder).

Note Output minimum does not saturate or clip the actual output signal. Use the Saturation block instead.

Programmatic Use**Block Parameter:** OutMin**Type:** character vector**Values:** ' [] ' | scalar**Default:** ' [] '**Output maximum — Maximum output value for range checking**

[] (default) | scalar

Upper value of the output range that Simulink checks.

Simulink uses the maximum value to perform:

- Parameter range checking (see “Specify Minimum and Maximum Values for Block Parameters”) for some blocks.
- Simulation range checking (see “Specify Signal Ranges” and “Enable Simulation Range Checking”).
- Automatic scaling of fixed-point data types.
- Optimization of the code that you generate from the model. This optimization can remove algorithmic code and affect the results of some simulation modes such as SIL or external mode. For more information, see “Optimize using the specified minimum and maximum values” (Embedded Coder).

Note Output maximum does not saturate or clip the actual output signal. Use the Saturation block instead.

Programmatic Use**Block Parameter:** OutMax

Type: character vector

Values: '[]' | scalar

Default: '[]'

Lock data type settings against changes by the fixed-point tools – Prevent fixed-point tools from overriding data types

off (default) | on

Select to lock data type settings of this block against changes by the Fixed-Point Tool and the Fixed-Point Advisor. For more information, see “Lock the Output Data Type Setting” (Fixed-Point Designer).

Programmatic Use

Block Parameter: LockScale

Values: 'off' | 'on'

Default: 'off'

Integer rounding mode – Rounding mode for fixed-point operations

Floor (default) | Ceiling | Convergent | Nearest | Round | Simplest | Zero

Specify the rounding mode for fixed-point operations. For more information, see “Rounding” (Fixed-Point Designer).

Programmatic Use

Block Parameter: RndMeth

Type: character vector

Values: 'Ceiling' | 'Convergent' | 'Floor' | 'Nearest' | 'Round' | 'Simplest' | 'Zero'

Default: 'Floor'

Saturate on integer overflow – Method of overflow action

off (default) | on

Specify whether overflows saturate or wrap.

| Action | Rationale | Impact on Overflows | Example |
|-----------------------------|--|---|--|
| Select this check box (on). | Your model has possible overflow, and you want explicit saturation protection in the generated code. | Overflows saturate to either the minimum or maximum value that the data type can represent. | The maximum value that the <code>int8</code> (signed, 8-bit integer) data type can represent is 127. Any block operation result greater than this maximum value causes overflow of the 8-bit integer. With the check box selected, the block output saturates at 127. Similarly, the block output saturates at a minimum output value of -128. |

| Action | Rationale | Impact on Overflows | Example |
|-------------------------------------|--|---|---|
| Do not select this check box (off). | <p>You want to optimize efficiency of your generated code.</p> <p>You want to avoid overspecifying how a block handles out-of-range signals. For more information, see “Troubleshoot Signal Range Errors”.</p> | Overflows wrap to the appropriate value that is representable by the data type. | The maximum value that the <code>int8</code> (signed, 8-bit integer) data type can represent is 127. Any block operation result greater than this maximum value causes overflow of the 8-bit integer. With the check box cleared, the software interprets the overflow-causing value as <code>int8</code> , which can produce an unintended result. For example, a block result of 130 (binary 1000 0010) expressed as <code>int8</code> , is -126. |

When you select this check box, saturation applies to every internal operation on the block, not just the output, or result. Usually, the code generation process can detect when overflow is not possible. In this case, the code generator does not produce saturation code.

Programmatic Use

Block Parameter: SaturateOnIntegerOverflow

Type: character vector

Values: 'off' | 'on'

Default: 'off'

Block Characteristics

| | |
|---------------------------------|---|
| Data Types | double fixed point integer single |
| Direct Feedthrough | no |
| Multidimensional Signals | no |
| Variable-Size Signals | yes |
| Zero-Crossing Detection | no |

Extended Capabilities

C/C++ Code Generation

Generate C and C++ code using Simulink® Coder™.

This block supports custom state attributes to customize and generate code more efficiently. To access or set these attributes, open the Model Data Editor. On the **Modeling** tab, click **Model Data Editor**. For an example, see “Custom State Attributes in Discrete FIR Filter block”.

The Discrete FIR Filter block supports SIMD code generation using Intel AVX2 technology under these conditions:

- **Filter structure** is set to `Direct form` or `Direct form transposed`.

- **Input processing** is set to `Columns as channels (frame based)`.
- Input signal is real-valued with real filter coefficients.
- Input signal is complex-valued with real or complex filter coefficients.
- Input signal has a data type of `single` or `double`.

The SIMD technology significantly improves the performance of the generated code.

HDL Code Generation

Generate Verilog and VHDL code for FPGA and ASIC designs using HDL Coder™.

HDL Coder provides additional configuration options that affect HDL implementation and synthesized logic.

For hardware-friendly valid and reset control signals, and to model exact hardware latency behavior in Simulink, use the Discrete FIR Filter HDL Optimized block instead.

To reduce area or increase speed, the Discrete FIR Filter block supports either block-level optimizations or subsystem-level optimizations. For details of available block-level optimization parameters, see “Block Optimizations” on page 1-377. When you enable block optimizations, the block cannot participate in subsystem optimizations. Use block optimizations when your design is a single one-channel filter. Use subsystem optimizations to share resources across multiple channels or multiple filters. For the block to participate in subsystem-level optimizations, set the **Architecture** to `Fully parallel`. See “Subsystem Optimizations for Filters” (HDL Coder).

Multichannel Filter Support

HDL Coder supports the use of vector inputs to Discrete FIR Filter blocks, where each element of the vector represents an independent channel.

- 1** Connect a vector signal to the Discrete FIR Filter block input port.
- 2** Specify **Input processing** as `Elements as channels (sample based)`.
- 3** To reduce area by sharing the filter kernel between channels, set the **ChannelSharing** property to the number of channels.

Programmable Filter Support

HDL Coder supports programmable filters for Discrete FIR Filter blocks.

- 1** On the filter block mask, set **Coefficient source** to **Input port**.
- 2** Connect a vector signal to the Num coefficient port.

Programmable filters are not supported for:

- distributed arithmetic (DA)
- **CoeffMultipliers** set to `csd` or `factored-csd`

Frame-Based Input Support

HDL Coder supports the use of vector inputs to Discrete FIR Filter blocks, where each element of the vector represents a sample in time. You can use an input vector of up to 512 samples. The frame-based implementation supports fixed-point input and output data types, and uses full-precision internal data types. You can use real input signals with real coefficients, complex input signals with real coefficients, or real input signals with complex coefficients. You can also use frame-based input with programmable coefficients.

- 1 Connect a vector signal to the Discrete FIR Filter block input port.
- 2 Specify **Input processing** as Columns as channels (frame based), and set **Filter structure** to Direct form.
- 3 Right-click the block and open **HDL Code > HDL Block Properties**. Set the **Architecture** to Frame Based. The block implements a direct form parallel HDL architecture. Other architectures, including fully- or partly-serial, are not supported. See “Frame-Based Architecture” (HDL Coder).

Frame-based input filters are not supported for:

- Optional block-level reset and enable control signals
- Resettable and enabled subsystems
- Complex input signals with complex coefficients. You can use either complex input signals and real coefficients, or complex coefficients and real input signals.
- Multichannel input
- Sharing and streaming optimizations
- distributed arithmetic (DA)

Control Ports

You can generate HDL code for filters with or without the optional enable port, and with or without the optional reset port.

Complex Data Support

You can use any combination of complex input and complex coefficients with fully-parallel filter structures, when you use non-frame-based input data.

Complex coefficients are not supported with serial filter architectures.

When you use frame-based input data you can use either complex input signals and real coefficients, or complex coefficients and real input signals.

You cannot use distributed arithmetic (DA) or **CoeffMultipliers** set to csd or factored-csd with complex coefficients.

Block Optimizations

| Area and Speed Optimizations | |
|------------------------------|---|
| Serial Architecture | <p>To use block-level optimizations to reduce hardware resources, set Architecture to one of the serial options. See “HDL Filter Architectures” (HDL Coder).</p> <p>When you specify SerialPartition and ReuseAccum for a Discrete FIR Filter block, set Filter structure to Direct form, Direct form symmetric, or Direct form antisymmetric. The Direct form transposed structure is not supported with serial architectures.</p> |

| Area and Speed Optimizations | |
|------------------------------|--|
| Distributed Arithmetic | <p>To minimize multipliers by replacing them with LUTs and shift registers, use a distributed arithmetic (DA) filter implementation. See “Distributed Arithmetic for HDL Filters” (HDL Coder).</p> <p>When you select the Distributed Arithmetic (DA) architecture and use the DALUTPartition and DARadix distributed arithmetic properties, set Filter structure to Direct form, Direct form symmetric, or Direct form antisymmetric. The Direct form transposed structure is not supported with distributed arithmetic.</p> |
| Multichannel Area Reduction | <p>To share filter logic between channels, set the ChannelSharing property to the number of channels. Using ChannelSharing excludes the filter from other optimizations.</p> <p>You can achieve the same logic sharing across all eligible logic in a subsystem by using the StreamingFactor property. This option also enables the filter to participate in other subsystem optimizations. See the Streaming section of “Subsystem Optimizations for Filters” (HDL Coder).</p> |
| Pipelining | <p>To improve clock speed, use AddPipelineRegisters to use a pipelined adder tree rather than the default linear adder. You can also specify the number of pipeline stages before and after the multipliers. See “HDL Filter Architectures” (HDL Coder).</p> |

| HDL Filter Properties | |
|---------------------------------|--|
| AddPipelineRegisters | Insert a pipeline register between stages of computation in a filter. See also AddPipelineRegisters (HDL Coder). |
| ChannelSharing | For a multichannel filter, generate a single filter implementation to be shared between channels. See also ChannelSharing (HDL Coder). |
| CoeffMultipliers | Specify the use of canonical signed digit (CSD) optimization to decrease filter area by replacing coefficient multipliers with shift-and-add logic. When you choose a fully parallel filter implementation, you can set CoeffMultipliers to csd or factored-csd . The default is multipliers , which retains multipliers in the HDL. See also CoeffMultipliers (HDL Coder). |
| DALUTPartition | Specify distributed arithmetic partial-product LUT partitions as a vector of the sizes of each partition. The sum of all vector elements must be equal to the filter length. The maximum size for a partition is 12 taps. Set DALUTPartition to a scalar value equal to the filter length to generate DA code without LUT partitions. See also DALUTPartition (HDL Coder). |
| DARadix | Specify how many distributed arithmetic bit sums are computed in parallel. A DA radix of 8 (2^3) generates a DA implementation that computes three sums at a time. The default value is 2^1 , which generates a fully serial DA implementation. See also DARadix (HDL Coder). |
| MultiplierInputPipeline | Specify the number of pipeline stages to add at filter multiplier inputs. See also MultiplierInputPipeline (HDL Coder). |
| MultiplierOutputPipeline | Specify the number of pipeline stages to add at filter multiplier outputs. See also MultiplierOutputPipeline (HDL Coder). |

| HDL Filter Properties | |
|------------------------|--|
| ReuseAccum | Enable or disable accumulator reuse in a serial filter implementation. Set ReuseAccum to on to use a cascade-serial implementation. See also ReuseAccum (HDL Coder). |
| SerialPartition | Specify partitions for partly serial or cascade-serial filter implementations as a vector of the lengths of each partition. For a fully serial implementation, set this parameter to the length of the filter. See also SerialPartition (HDL Coder). |

| HDL Block Properties | |
|----------------------------------|--|
| ConstrainedOutputPipeline | Number of registers to place at the outputs by moving existing delays within your design. Distributed pipelining does not redistribute these registers. The default is 0. For more details, see "ConstrainedOutputPipeline" (HDL Coder). |
| InputPipeline | Number of input pipeline stages to insert in the generated code. Distributed pipelining and constrained output pipelining can move these registers. The default is 0. For more details, see "InputPipeline" (HDL Coder). |
| OutputPipeline | Number of output pipeline stages to insert in the generated code. Distributed pipelining and constrained output pipelining can move these registers. The default is 0. For more details, see "OutputPipeline" (HDL Coder). |

Restrictions

- HDL code generation is not supported for:
 - Unsigned input data.
 - Nonzero initial states. You must set **Initial states** to 0.
 - **Filter Structure:** Lattice MA.
- **CoeffMultipliers** options are supported only when using a fully parallel architecture. When you select a serial architecture, **CoeffMultipliers** is hidden from the HDL Block Properties dialog box.

PLC Code Generation

Generate Structured Text code using Simulink® PLC Coder™.

Fixed-Point Conversion

Design and simulate fixed-point systems using Fixed-Point Designer™.

The Discrete FIR Filter block accepts and outputs real and complex signals of any numeric data type supported by Simulink. The block supports the same types for the coefficients.

The following diagrams show the filter structure and the data types used within the Discrete FIR Filter block for fixed-point signals.

Direct Form

You cannot specify the state data type on the block mask for this structure because the input states have the same data types as the input.

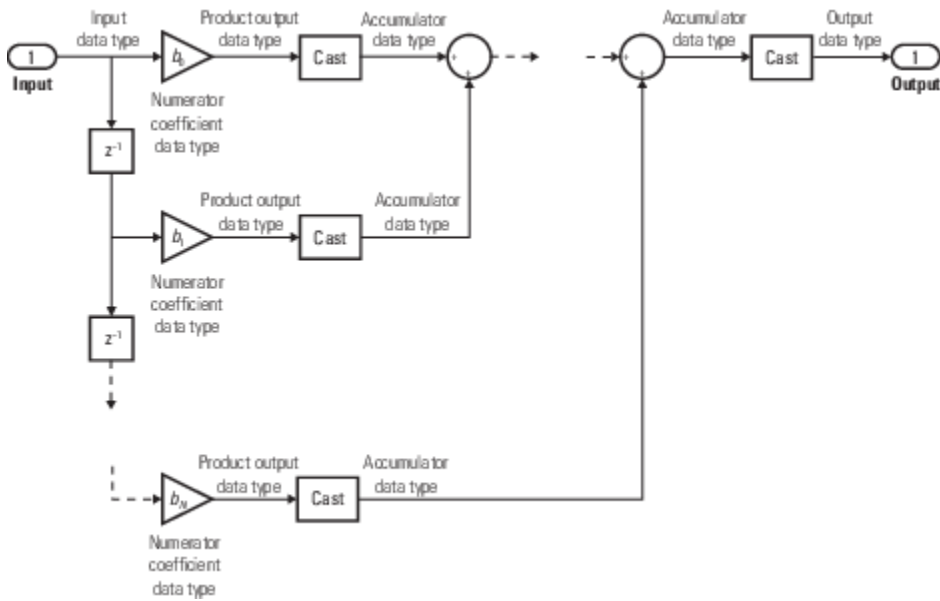
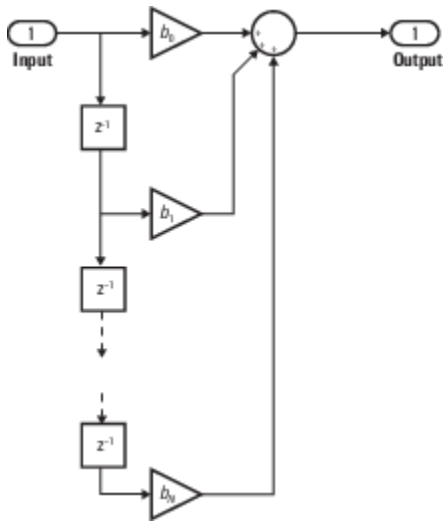

Direct Form Symmetric

You cannot specify the state data type on the block mask for this structure because the input states have the same data types as the input.

It is assumed that the filter coefficients are symmetric. The block only uses the first half of the coefficients for filtering.

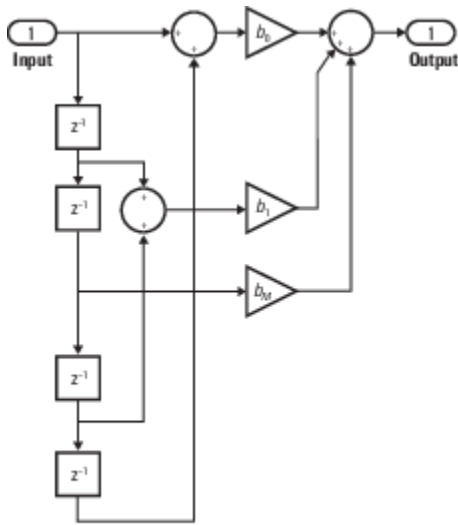

Even Order - Type I

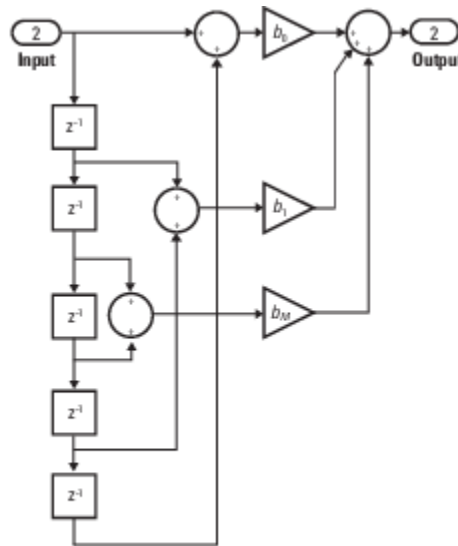

Odd Order - Type II

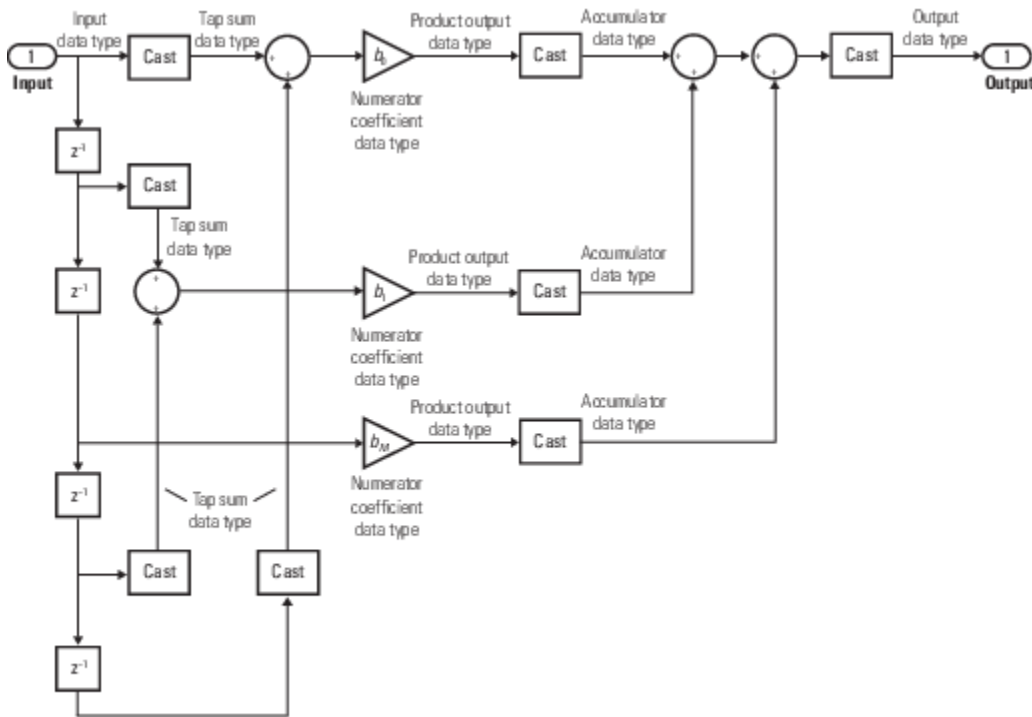

Even Order - Type I

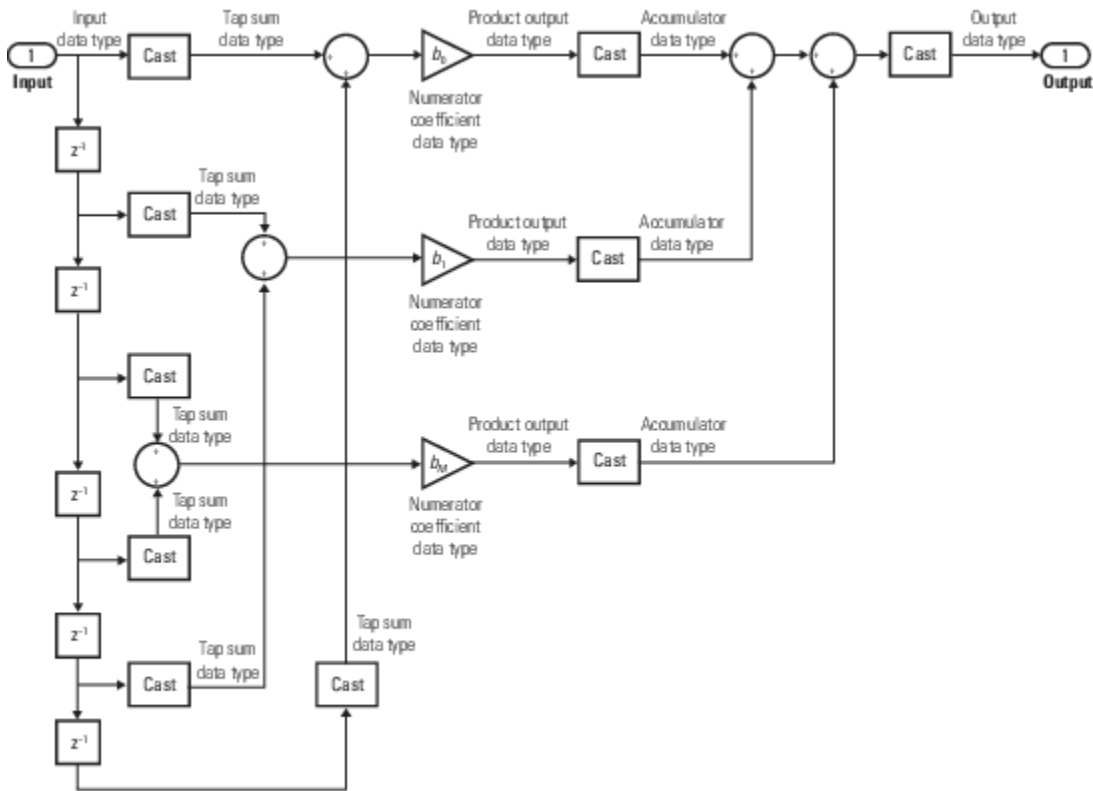

Odd Order - Type II

Direct Form Antisymmetric

You cannot specify the state data type on the block mask for this structure because the input states have the same data types as the input.

It is assumed that the filter coefficients are antisymmetric. The block only uses the first half of the coefficients for filtering.

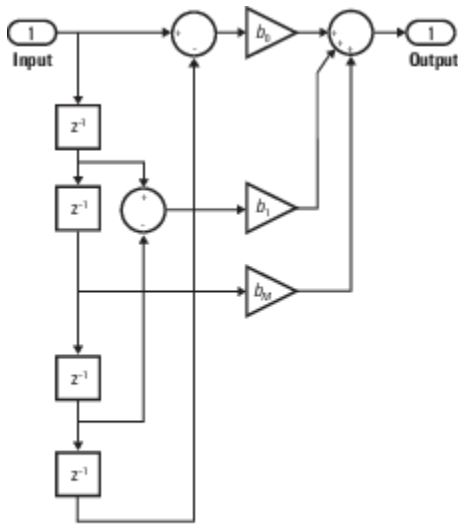

Even Order - Type III

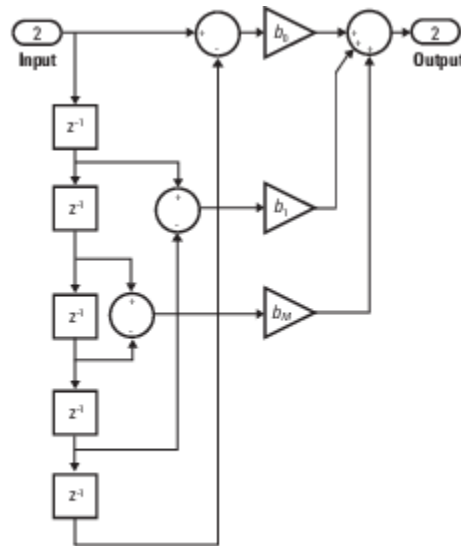

Odd Order - Type IV

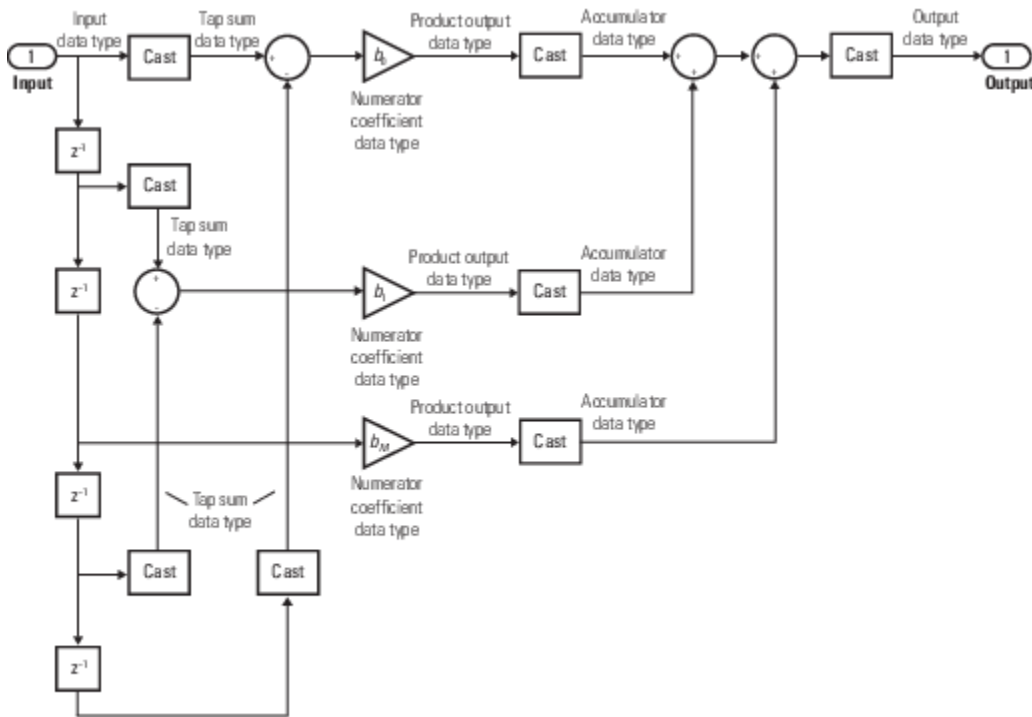

Even Order - Type III

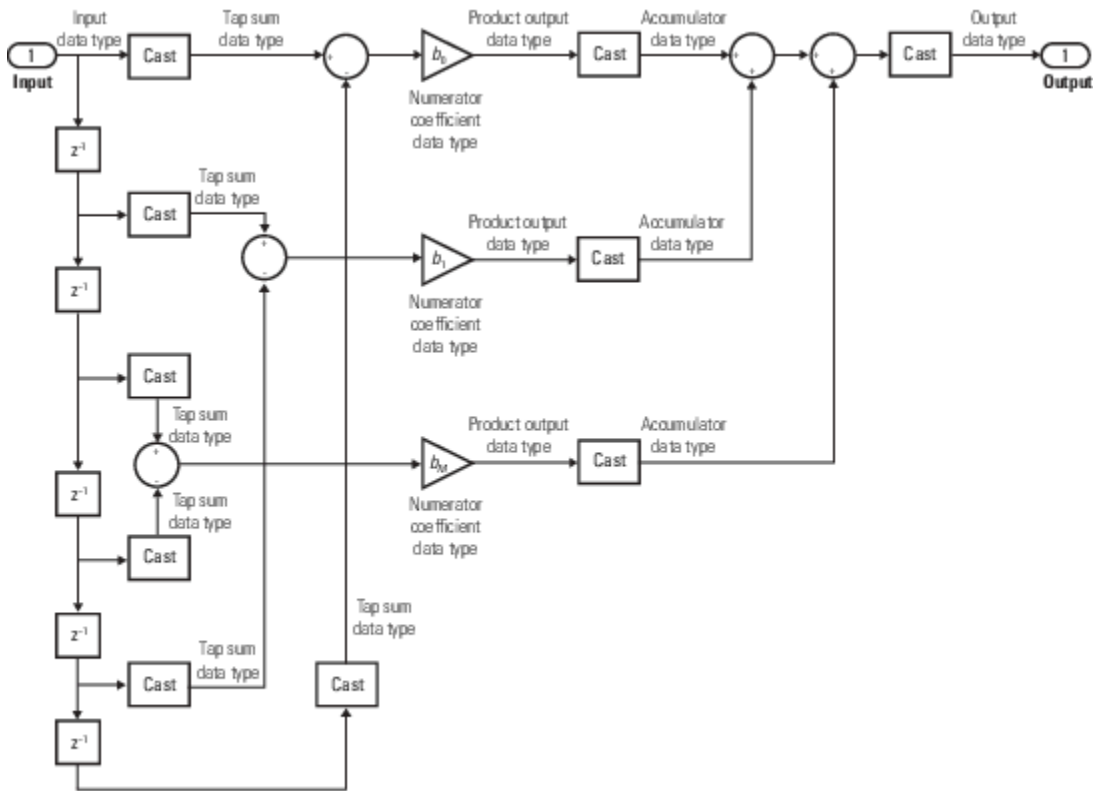

Odd Order - Type IV

Direct Form Transposed

States are complex when either the inputs or the coefficients are complex.

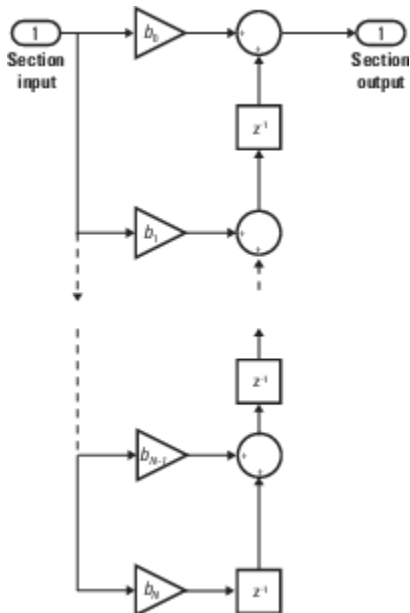

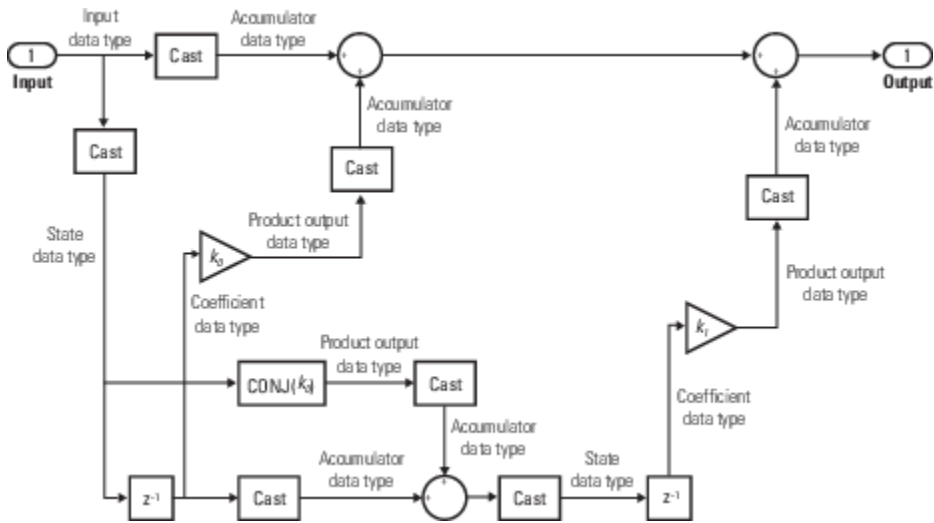

See Also

Discrete Filter | Digital Filter Design

Topics

“Sample- and Frame-Based Concepts” (DSP System Toolbox)

“Custom State Attributes in Discrete FIR Filter block”

“Working with States” on page 11-21

Introduced in R2008a

Discrete PID Controller

Discrete-time or continuous-time PID controller

Library: Simulink / Discrete
 HDL Coder / Discrete
 HDL Coder / HDL Floating Point Operations

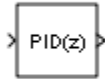

Description

The Discrete PID Controller block implements a PID controller (PID, PI, PD, P only, or I only). The block is identical to the PID Controller block with the **Time domain** parameter set to **Discrete-time**.

The block output is a weighted sum of the input signal, the integral of the input signal, and the derivative of the input signal. The weights are the proportional, integral, and derivative gain parameters. A first-order pole filters the derivative action.

The block supports several controller types and structures. Configurable options in the block include:

- Controller type (PID, PI, PD, P only, or I only) — See the **Controller** parameter.
- Controller form (Parallel or Ideal) — See the **Form** parameter.
- Time domain (continuous or discrete) — See the **Time domain** parameter.
- Initial conditions and reset trigger — See the **Source** and **External reset** parameters.
- Output saturation limits and built-in anti-windup mechanism — See the **Limit output** parameter.
- Signal tracking for bumpless control transfer and multiloop control — See the **Enable tracking mode** parameter.

As you change these options, the internal structure of the block changes by activating different variant subsystems. (For more information, see “Variant Subsystems”). To examine the internal structure of the block and its variant subsystems, right-click the block and select **Mask > Look Under Mask**.

Control Configuration

In one common implementation, the PID Controller block operates in the feedforward path of a feedback loop.

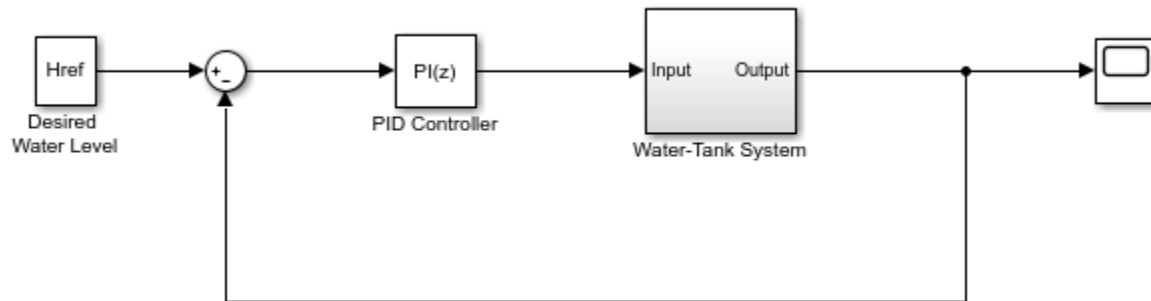

The input of the block is typically an error signal, which is the difference between a reference signal and the system output. For a two-input block that permits setpoint weighting, see Discrete PID Controller (2DOF).

PID Gain Tuning

The PID controller gains are tunable either manually or automatically. Automatic tuning requires Simulink Control Design software. For more information about automatic tuning, see the **Select tuning method** parameter.

Ports

Input

Port_1(u) – Error signal input

scalar | vector

Difference between a reference signal and the output of the system under control, as shown.

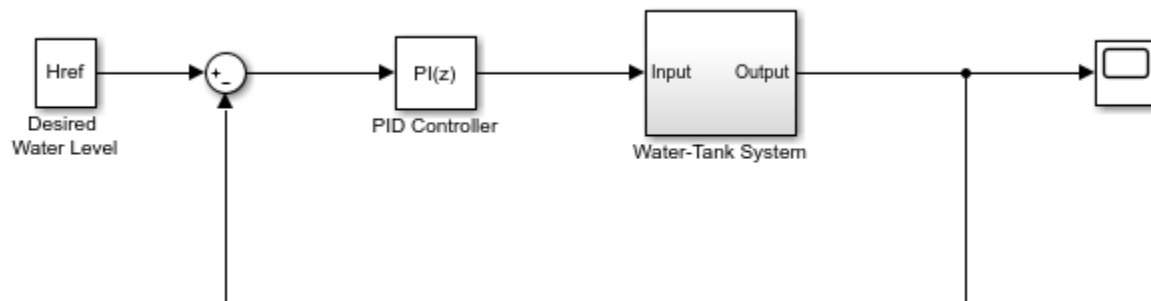

Data Types: single | double | int8 | int16 | int32 | int64 | uint8 | uint16 | uint32 | uint64 | fixed point

P – Proportional gain

scalar | vector

Proportional gain, provided from a source external to the block. External gain input is useful, for example, when you want to map a different PID parameterization to the PID gains of the block. You can also use external gain input to implement gain-scheduled PID control. In gain-scheduled control, you determine the PID coefficients by logic or other calculation in your model and feed them to the block.

Dependencies

To enable this port, set **Controller parameters Source** to external.

Data Types: single | double | int8 | int16 | int32 | int64 | uint8 | uint16 | uint32 | uint64 | fixed point

I — Integral gain

scalar | vector

Integral gain, provided from a source external to the block. External gain input is useful, for example, when you want to map a different PID parameterization to the PID gains of the block. You can also use external gain input to implement gain-scheduled PID control. In gain-scheduled control, you determine the PID coefficients by logic or other calculation in your model and feed them to the block.

When you supply gains externally, time variations in the integral gain are also integrated. This result occurs because of the way the PID gains are implemented within the block. For details, see the **Controller parameters Source** parameter.

Dependencies

To enable this port, set **Controller parameters Source** to external, and set **Controller** to a controller type that has integral action.

Data Types: single | double | int8 | int16 | int32 | int64 | uint8 | uint16 | uint32 | uint64 | fixed point

D — Derivative gain

scalar | vector

Derivative gain, provided from a source external to the block. External gain input is useful, for example, when you want to map a different PID parameterization to the PID gains of the block. You can also use external gain input to implement gain-scheduled PID control. In gain-scheduled control, you determine the PID coefficients by logic or other calculation in your model and feed them to the block.

When you supply gains externally, time variations in the derivative gain are also differentiated. This result occurs because of the way the PID gains are implemented within the block. For details, see the **Controller parameters Source** parameter.

Dependencies

To enable this port, set **Controller parameters Source** to external, and set **Controller** to a controller type that has derivative action.

Data Types: single | double | int8 | int16 | int32 | int64 | uint8 | uint16 | uint32 | uint64 | fixed point

N — Filter coefficient

scalar | vector

Derivative filter coefficient, provided from a source external to the block. External coefficient input is useful, for example, when you want to map a different PID parameterization to the PID gains of the block. You can also use the external input to implement gain-scheduled PID control. In gain-scheduled control, you determine the PID coefficients by logic or other calculation in your model and feed them to the block.

Dependencies

To enable this port, set **Controller parameters Source** to `external`, and set **Controller** to a controller type that has a filtered derivative.

Data Types: `single` | `double` | `int8` | `int16` | `int32` | `int64` | `uint8` | `uint16` | `uint32` | `uint64` | `fixed point`

Reset — External reset trigger

scalar

Trigger to reset the integrator and filter to their initial conditions. The value of the **External reset** parameter determines whether reset occurs on a rising signal, a falling signal, or a level signal. The port icon indicates the selected trigger type. For example, the following illustration shows a continuous-time PID block with **External reset** set to `rising`.



When the trigger occurs, the block resets the integrator and filter to the initial conditions specified by the **Integrator Initial condition** and **Filter Initial condition** parameters or the **I₀** and **D₀** ports.

Note To be compliant with the Motor Industry Software Reliability Association (MISRA®) software standard, your model must use Boolean signals to drive the external reset ports of the PID controller block.

Dependencies

To enable this port, set **External reset** to any value other than `none`.

Data Types: `single` | `double` | `int8` | `int16` | `int32` | `int64` | `uint8` | `uint16` | `uint32` | `uint64` | `fixed point` | `Boolean`

I₀ — Integrator initial condition

scalar | vector

Integrator initial condition, provided from a source external to the block.

Dependencies

To enable this port, set **Initial conditions Source** to `external`, and set **Controller** to a controller type that has integral action.

Data Types: `single` | `double` | `int8` | `int16` | `int32` | `int64` | `uint8` | `uint16` | `uint32` | `uint64` | `fixed point`

D₀ — Filter initial condition

scalar | vector

Initial condition of the derivative filter, provided from a source external to the block.

Dependencies

To enable this port, set **Initial conditions Source** to `external`, and set **Controller** to a controller type that has derivative action.

Data Types: `single` | `double` | `int8` | `int16` | `int32` | `int64` | `uint8` | `uint16` | `uint32` | `uint64` | `fixed point`

up — Output saturation upper limit

scalar | vector

Upper limit of the block output, provided from a source external to the block. If the weighted sum of the proportional, integral, and derivative actions exceeds the value provided at this port, the block output is held at that value.

Dependencies

To enable this port, select **Limit output** and set the output saturation **Source** to `external`.

Data Types: `single` | `double` | `int8` | `int16` | `int32` | `int64` | `uint8` | `uint16` | `uint32` | `uint64` | `fixed point`

Lo — Output saturation lower limit

scalar | vector

Lower limit of the block output, provided from a source external to the block. If the weighted sum of the proportional, integral, and derivative actions goes below the value provided at this port, the block output is held at that value.

Dependencies

To enable this port, select **Limit output** and set the output saturation **Source** to `external`.

Data Types: `single` | `double` | `int8` | `int16` | `int32` | `int64` | `uint8` | `uint16` | `uint32` | `uint64` | `fixed point`

TR — Tracking signal

scalar | vector

Signal for controller output to track. When signal tracking is active, the difference between the tracking signal and the block output is fed back to the integrator input. Signal tracking is useful for implementing bumpless control transfer in systems that switch between two controllers. It can also be useful to prevent block windup in multiloop control systems. For more information, see the **Enable tracking mode** parameter.

Dependencies

To enable this port, select the **Enable tracking mode** parameter.

Data Types: `single` | `double` | `int8` | `int16` | `int32` | `int64` | `uint8` | `uint16` | `uint32` | `uint64` | `fixed point`

T_{DTI} — Discrete-integrator time

scalar

Discrete-integrator time, provided as a scalar to the block. You can use your own value of discrete-time integrator sample time that defines the rate at which the block is going to be run either in Simulink or on external hardware. The value of the discrete-time integrator time should match the

average sampling rate of the external interrupts, when the block is used inside a conditionally-executed subsystem.

In other words, you can specify T_s for any of the integrator methods below such that the value matches the average sampling rate of the external interrupts. In discrete time, the derivative term of the controller transfer function is:

$$D \left[\frac{N}{1 + N\alpha(z)} \right],$$

where $\alpha(z)$ depends on the integrator method you specify with this parameter.

Forward Euler

$$\alpha(z) = \frac{T_s}{z - 1}.$$

Backward Euler

$$\alpha(z) = \frac{T_s z}{z - 1} \cdot$$

Trapezoidal

$$\alpha(z) = \frac{T_s z + 1}{2 z - 1} \cdot$$

For more information about discrete-time integration, see the Discrete-Time Integrator block reference page. For more information on conditionally executed subsystems, see “Conditionally Executed Subsystems Overview”.

Dependencies

To enable this port, set **Time Domain** to Discrete-time and select the **PID Controller is inside a conditionally executed subsystem** option.

Data Types: single | double | int8 | int16 | int32 | int64 | uint8 | uint16 | uint32 | uint64

Output

Port_1(y) – Controller output

scalar | vector

Controller output, generally based on a sum of the input signal, the integral of the input signal, and the derivative of the input signal, weighted by the proportional, integral, and derivative gain parameters. A first-order pole filters the derivative action. Which terms are present in the controller signal depends on what you select for the **Controller** parameter. The base controller transfer function for the current settings is displayed in the **Compensator formula** section of the block parameters and under the mask. Other parameters modify the block output, such as saturation limits specified by the **Upper Limit** and **Lower Limit** saturation parameters.

The controller output is a vector signal when any of the inputs is a vector signal. In that case, the block acts as N independent PID controllers, where N is the number of signals in the input vector.

Data Types: `single` | `double` | `int8` | `int16` | `int32` | `int64` | `uint8` | `uint16` | `uint32` | `uint64` | `fixed point`

Parameters

Controller — Controller type

PID (default) | PI | PD | P | I

Specify which of the proportional, integral, and derivative terms are in the controller.

PID

Proportional, integral, and derivative action.

PI

Proportional and integral action only.

PD

Proportional and derivative action only.

P

Proportional action only.

I

Integral action only.

Tip The controller transfer function for the current setting is displayed in the **Compensator formula** section of the block parameters and under the mask.

Programmatic Use

Block Parameter: Controller

Type: string, character vector

Values: "PID", "PI", "PD", "P", "I"

Default: "PID"

Form — Controller structure

Parallel (default) | Ideal

Specify whether the controller structure is parallel or ideal.

Parallel

The controller output is the sum of the proportional, integral, and derivative actions, weighted independently by **P**, **I**, and **D**, respectively. For example, for a continuous-time parallel-form PID controller, the transfer function is:

$$C_{par}(s) = P + I\left(\frac{1}{s}\right) + D\left(\frac{Ns}{s+N}\right).$$

For a discrete-time parallel-form controller, the transfer function is:

$$C_{par}(z) = P + I\alpha(z) + D\left[\frac{N}{1 + N\beta(z)}\right],$$

where the **Integrator method** and **Filter method** parameters determine $\alpha(z)$ and $\beta(z)$, respectively.

Ideal

The proportional gain **P** acts on the sum of all actions. For example, for a continuous-time ideal-form PID controller, the transfer function is:

$$C_{id}(s) = P \left[1 + I \left(\frac{1}{s} \right) + D \left(\frac{Ns}{s + N} \right) \right].$$

For a discrete-time ideal-form controller, the transfer function is:

$$C_{id}(z) = P \left[1 + I\alpha(z) + D \frac{N}{1 + N\beta(z)} \right],$$

where the **Integrator method** and **Filter method** parameters determine $a(z)$ and $b(z)$, respectively.

Tip The controller transfer function for the current settings is displayed in the **Compensator formula** section of the block parameters and under the mask.

Programmatic Use

Block Parameter: Controller

Type: string, character vector

Values: "Parallel", "Ideal"

Default: "Parallel"

Time domain — Specify discrete-time or continuous-time controller

Discrete-time (default) | Continuous-time

When you select **Discrete-time**, it is recommended that you specify an explicit sample time for the block. See the **Sample time (-1 for inherited)** parameter. Selecting **Discrete-time** also enables the **Integrator method**, and **Filter method** parameters.

When the PID Controller block is in a model with synchronous state control (see the State Control block), you cannot select **Continuous-time**.

Note The PID Controller and Discrete PID Controller blocks are identical except for the default value of this parameter.

Programmatic Use

Block Parameter: TimeDomain

Type: string, character vector

Values: "Continuous-time", "Discrete-time"

Default: "Continuous-time"

PID Controller is inside a conditionally executed subsystem – Enable the discrete-integrator time port

off (default) | on

For discrete-time PID controllers, enable the discrete-time integrator port to use your own value of discrete-time integrator sample time. To ensure proper integration, Use the T_{DTI} port to provide a scalar value of Δt for accurate discrete-time integration.

Dependencies

To enable this parameter, set **Time Domain** to Discrete-time.

Programmatic Use**Block Parameter:** UseExternalTs**Type:** string, character vector**Values:** "on", "off"**Default:** "off"**Sample time (-1 for inherited) – Discrete interval between samples**

-1 (default) | positive scalar

Specify a sample time by entering a positive scalar value, such as 0.1. The default discrete sample time of -1 means that the block inherits its sample time from upstream blocks. However, it is recommended that you set the controller sample time explicitly, especially if you expect the sample time of upstream blocks to change. The effect of the controller coefficients P, I, D, and N depend on the sample time. Thus, for a given set of coefficient values, changing the sample time changes the performance of the controller.

See “Specify Sample Time” for more information.

To implement a continuous-time controller, set **Time domain** to Continuous-time.

Tip If you want to run the block with an externally specified or variable sample time, set this parameter to -1 and put the block in a Triggered Subsystem. Then, trigger the subsystem at the desired sample time.

Dependencies

To enable this parameter, set **Time domain** to Discrete-time.

Programmatic Use**Block Parameter:** SampleTime**Type:** scalar**Values:** -1, positive scalar**Default:** -1**Integrator method – Method for computing integral in discrete-time controller**

Forward Euler (default) | Backward Euler | Trapezoidal

In discrete time, the integral term of the controller transfer function is $I\alpha(z)$, where $\alpha(z)$ depends on the integrator method you specify with this parameter.

Forward Euler

Forward rectangular (left-hand) approximation,

$$\alpha(z) = \frac{T_s}{z - 1} \cdot$$

This method is best for small sampling times, where the Nyquist limit is large compared to the bandwidth of the controller. For larger sampling times, the Forward Euler method can result in instability, even when discretizing a system that is stable in continuous time.

Backward Euler

Backward rectangular (right-hand) approximation,

$$\alpha(z) = \frac{T_s z}{z - 1} \cdot$$

An advantage of the Backward Euler method is that discretizing a stable continuous-time system using this method always yields a stable discrete-time result.

Trapezoidal

Bilinear approximation,

$$\alpha(z) = \frac{T_s z + 1}{2 z - 1} \cdot$$

An advantage of the Trapezoidal method is that discretizing a stable continuous-time system using this method always yields a stable discrete-time result. Of all available integration methods, the Trapezoidal method yields the closest match between frequency-domain properties of the discretized system and the corresponding continuous-time system.

Tip The controller formula for the current setting is displayed in the **Compensator formula** section of the block parameters and under the mask.

Note For the BackwardEuler or Trapezoidal methods, you cannot generate HDL code for the block if either:

- **Limit output** is selected and **Anti-Windup Method** is anything other than none.
 - **Enable tracking mode** is selected.
-

For more information about discrete-time integration, see the Discrete-Time Integrator block reference page.

Dependencies

To enable this parameter, set **Time Domain** to Discrete-time and set **Controller** to a controller type with integral action.

Programmatic Use

Block Parameter: IntegratorMethod

Type: string, character vector

Values: "Forward Euler", "Backward Euler", "Trapezoidal"

Default: "Forward Euler"

Filter method — Method for computing derivative in discrete-time controller

Forward Euler (default) | Backward Euler | Trapezoidal

In discrete time, the derivative term of the controller transfer function is:

$$D \left[\frac{N}{1 + N\alpha(z)} \right],$$

where $\alpha(z)$ depends on the filter method you specify with this parameter.

Forward Euler

Forward rectangular (left-hand) approximation,

$$\alpha(z) = \frac{T_s}{z - 1}.$$

This method is best for small sampling times, where the Nyquist limit is large compared to the bandwidth of the controller. For larger sampling times, the Forward Euler method can result in instability, even when discretizing a system that is stable in continuous time.

Backward Euler

Backward rectangular (right-hand) approximation,

$$\alpha(z) = \frac{T_s z}{z - 1}.$$

An advantage of the Backward Euler method is that discretizing a stable continuous-time system using this method always yields a stable discrete-time result.

Trapezoidal

Bilinear approximation,

$$\alpha(z) = \frac{T_s z + 1}{2 z - 1}.$$

An advantage of the Trapezoidal method is that discretizing a stable continuous-time system using this method always yields a stable discrete-time result. Of all available integration methods, the Trapezoidal method yields the closest match between frequency-domain properties of the discretized system and the corresponding continuous-time system.

Tip The controller formula for the current setting is displayed in the **Compensator formula** section of the block parameters and under the mask.

For more information about discrete-time integration, see the Discrete-Time Integrator block reference page.

Dependencies

To enable this parameter, set **Time Domain** to Discrete-time and enable **Use filtered derivative**.

Programmatic Use

Block Parameter: FilterMethod

Type: string, character vector

Values: "Forward Euler", "Backward Euler", "Trapezoidal"

Default: "Forward Euler"

Main

Source — Source for controller gains and filter coefficient

internal (default) | external

Enabling external inputs for the parameters allows you to compute PID gains and filter coefficients externally to the block and provide them to the block as signal inputs.

internal

Specify the controller gains and filter coefficient using the block parameters **P**, **I**, **D**, and **N**.

external

Specify the PID gains and filter coefficient externally using block inputs. An additional input port appears on the block for each parameter that is required for the current controller type.

External gain input is useful, for example, when you want to map a different PID parameterization to the PID gains of the block. You can also use external gain input to implement gain-scheduled PID control. In gain-scheduled control, you determine the PID gains by logic or other calculation in your model and feed them to the block.

When you supply gains externally, time variations in the integral and derivative gain values are integrated and differentiated, respectively. This result occurs because in both continuous time and discrete time, the gains are applied to the signal before integration or differentiation. For example, for a continuous-time PID controller with external inputs, the integrator term is implemented as shown in the following illustration.

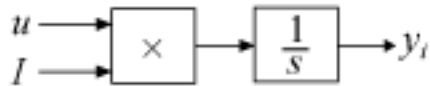

Within the block, the input signal u is multiplied by the externally supplied integrator gain, I , before integration. This implementation yields:

$$y_i = \int uI dt.$$

Thus, the integrator gain is included in the integral. Similarly, in the derivative term of the block, multiplication by the derivative gain precedes the differentiation, which causes the derivative gain D to be differentiated.

Programmatic Use

Block Parameter: ControllerParametersSource

Type: string, character vector

Values: "internal", "external"

Default: "internal"

Proportional (P) — Proportional gain

1 (default) | scalar | vector

Specify a finite, real gain value for the proportional gain. When **Controller form** is:

- **Parallel** — Proportional action is independent of the integral and derivative actions. For instance, for a continuous-time parallel PID controller, the transfer function is:

$$C_{par}(s) = P + I\left(\frac{1}{s}\right) + D\left(\frac{Ns}{s+N}\right).$$

For a discrete-time parallel-form controller, the transfer function is:

$$C_{par}(z) = P + I\alpha(z) + D\left[\frac{N}{1+N\beta(z)}\right],$$

where the **Integrator method** and **Filter method** parameters determine $\alpha(z)$ and $\beta(z)$, respectively.

- **Ideal** — The proportional gain multiplies the integral and derivative terms. For instance, for a continuous-time ideal PID controller, the transfer function is:

$$C_{id}(s) = P\left[1 + I\left(\frac{1}{s}\right) + D\left(\frac{Ns}{s+N}\right)\right].$$

For a discrete-time ideal-form controller, the transfer function is:

$$C_{id}(z) = P\left[1 + I\alpha(z) + D\frac{N}{1+N\beta(z)}\right],$$

where the **Integrator method** and **Filter method** parameters determine $\alpha(z)$ and $\beta(z)$, respectively.

Tunable: Yes

Dependencies

To enable this parameter, in the **Main** tab, set the controller-parameters **Source** to **internal** and set **Controller** to **PID**, **PD**, **PI**, or **P**.

Programmatic Use

Block Parameter: P

Type: scalar, vector

Default: 1

Integral (I) — Integral gain

1 (default) | scalar | vector

Specify a finite, real gain value for the integral gain.

Tunable: Yes

Dependencies

To enable this parameter, in the **Main** tab, set the controller-parameters **Source** to **internal**, and set **Controller** to a type that has integral action.

Programmatic Use**Block Parameter:** I**Type:** scalar, vector**Default:** 1**Derivative (D) — Derivative gain**

0 (default) | scalar | vector

Specify a finite, real gain value for the derivative gain.

Tunable: Yes**Dependencies**To enable this parameter, in the **Main** tab, set the controller-parameters **Source** to `internal`, and set **Controller** to `PID` or `PD`.**Programmatic Use****Block Parameter:** D**Type:** scalar, vector**Default:** 0**Use filtered derivative — Apply filter to derivative term**`on` (default) | `off`

For discrete-time PID controllers only, clear this option to replace the filtered derivative with an unfiltered discrete-time differentiator. When you do so, the derivative term of the controller transfer function becomes:

$$D \frac{z - 1}{zT_s} \cdot$$

For continuous-time PID controllers, the derivative term is always filtered.

Dependencies

To enable this parameter, set **Time domain** to Discrete-time, and set **Controller** to a type that has derivative action.

Programmatic Use

Block Parameter: UseFilter

Type: string, character vector

Values: "on", "off"

Default: "on"

Filter coefficient (N) — Derivative filter coefficient

100 (default) | scalar | vector

Specify a finite, real gain value for the filter coefficient. The filter coefficient determines the pole location of the filter in the derivative action of the block. The location of the filter pole depends on the **Time domain** parameter.

- When **Time domain** is Continuous-time, the pole location is $s = -N$.
- When **Time domain** is Discrete-time, the pole location depends on the **Filter method** parameter.

| Filter Method | Location of Filter Pole |
|----------------|--|
| Forward Euler | $z_{pole} = 1 - NT_s$ |
| Backward Euler | $z_{pole} = \frac{1}{1 + NT_s}$ |
| Trapezoidal | $z_{pole} = \frac{1 - NT_s/2}{1 + NT_s/2}$ |

The block does not support $N = \text{Inf}$ (ideal unfiltered derivative). When the **Time domain** is Discrete-time, you can clear **Use filtered derivative** to remove the derivative filter.

Tunable: Yes

Dependencies

To enable this parameter, in the **Main** tab, set the controller-parameters **Source** to internal and set **Controller** to PID or PD.

Programmatic Use

Block Parameter: N

Type: scalar, vector

Default: 100

Select tuning method — Tool for automatic tuning of controller coefficients

Transfer Function Based (PID Tuner App) (default) | Frequency Response Based

If you have Simulink Control Design software, you can automatically tune the PID coefficients. To do so, use this parameter to select a tuning tool, and click **Tune**.

Transfer Function Based (PID Tuner App)

Use **PID Tuner**, which lets you interactively tune PID coefficients while examining relevant system responses to validate performance. By default, **PID Tuner** works with a linearization of

your plant model. For models that cannot be linearized, you can tune PID coefficients against a plant model estimated from simulated or measured response data. For more information, see “Introduction to Model-Based PID Tuning in Simulink” (Simulink Control Design).

Frequency Response Based

Use **Frequency Response Based PID Tuner**, which tunes PID controller coefficients based on frequency-response estimation data obtained by simulation. This tuning approach is especially useful for plants that are not linearizable or that linearize to zero. For more information, see “Design PID Controller from Plant Frequency-Response Data” (Simulink Control Design).

Both of these tuning methods assume a single-loop control configuration. Simulink Control Design software includes other tuning approaches that suit more complex configurations. For information about other ways to tune a PID Controller block, see “Choose a Control Design Approach” (Simulink Control Design).

Enable zero-crossing detection — Detect zero crossings on reset and on entering or leaving a saturation state

on (default) | off

Zero-crossing detection can accurately locate signal discontinuities without resorting to excessively small time steps that can lead to lengthy simulation times. If you select **Limit output** or activate **External reset** in your PID Controller block, activating zero-crossing detection can reduce computation time in your simulation. Selecting this parameter activates zero-crossing detection:

- At initial-state reset
- When entering an upper or lower saturation state
- When leaving an upper or lower saturation state

For more information about zero-crossing detection, see “Zero-Crossing Detection”.

Programmatic Use

Block Parameter: ZeroCross

Type: string, character vector

Values: "on", "off"

Default: "on"

Initialization

Source — Source for integrator and derivative initial conditions

internal (default) | external

Simulink uses initial conditions to initialize the integrator and derivative-filter (or the unfiltered derivative) output at the start of a simulation or at a specified trigger event. (See the **External reset** parameter.) These initial conditions determine the initial block output. Use this parameter to select how to supply the initial condition values to the block.

internal

Specify the initial conditions using the **Integrator Initial condition** and **Filter Initial condition** parameters. If **Use filtered derivative** is not selected, use the **Differentiator** parameter to specify the initial condition for the unfiltered differentiator instead of a filter initial condition.

external

Specify the initial conditions externally using block inputs. Additional input ports **I₀** and **D₀** appear on the block. If **Use filtered derivative** is not selected, supply the initial condition for the unfiltered differentiator at **D₀** instead of a filter initial condition.

Programmatic Use

Block Parameter: InitialConditionSource

Type: string, character vector

Values: "internal", "external"

Default: "internal"

Integrator — Integrator initial condition

0 (default) | scalar | vector

Simulink uses the integrator initial condition to initialize the integrator at the start of a simulation or at a specified trigger event (see **External reset**). The integrator initial condition and the filter initial condition determine the initial output of the PID controller block.

The integrator initial condition cannot be NaN or Inf.

Dependencies

To use this parameter, in the **Initialization** tab, set **Source** to `internal`, and set **Controller** to a type that has integral action.

Programmatic Use

Block Parameter: InitialConditionForIntegrator

Type: scalar, vector

Default: 0

Filter — Filter initial condition

0 (default) | scalar | vector

Simulink uses the filter initial condition to initialize the derivative filter at the start of a simulation or at a specified trigger event (see **External reset**). The integrator initial condition and the filter initial condition determine the initial output of the PID controller block.

The filter initial condition cannot be NaN or Inf.

Dependencies

To use this parameter, in the **Initialization** tab, set **Source** to `internal`, and use a controller that has a derivative filter.

Programmatic Use

Block Parameter: InitialConditionForFilter

Type: scalar, vector

Default: 0

Differentiator — Initial condition for unfiltered derivative

0 (default) | scalar | vector

When you use an unfiltered derivative, Simulink uses this parameter to initialize the differentiator at the start of a simulation or at a specified trigger event (see **External reset**). The integrator initial condition and the derivative initial condition determine the initial output of the PID controller block.

The derivative initial condition cannot be NaN or Inf.

Dependencies

To use this parameter, set **Time domain** to Discrete-time, clear the **Use filtered derivative** check box, and in the **Initialization** tab, set **Source** to internal.

Programmatic Use

Block Parameter: DifferentiatorICPrevScaledInput

Type: scalar, vector

Default: 0

Initial condition setting — Location at which initial condition is applied

State (most efficient) (default) | Output

Use this parameter to specify whether to apply the **Integrator Initial condition** and **Filter Initial condition** parameter to the corresponding block state or output. You can change this parameter at the command line only, using `set_param` to set the `InitialConditionSetting` parameter of the block.

State (most efficient)

Use this option in all situations except when the block is in a triggered subsystem or a function-call subsystem and simplified initialization mode is enabled.

Output

Use this option when the block is in a triggered subsystem or a function-call subsystem and simplified initialization mode is enabled.

For more information about the **Initial condition setting** parameter, see the Discrete-Time Integrator block.

This parameter is only accessible through programmatic use.

Programmatic Use

Block Parameter: InitialConditionSetting

Type: string, character vector

Values: "state", "output"

Default: "state"

External reset — Trigger for resetting integrator and filter values

none (default) | rising | falling | either | level

Specify the trigger condition that causes the block to reset the integrator and filter to initial conditions. (If **Use filtered derivative** is not selected, the trigger resets the integrator and differentiator to initial conditions.) Selecting any option other than **none** enables the **Reset** port on the block for the external reset signal.

none

The integrator and filter (or differentiator) outputs are set to initial conditions at the beginning of simulation, and are not reset during simulation.

rising

Reset the outputs when the reset signal has a rising edge.

falling

Reset the outputs when the reset signal has a falling edge.

either

Reset the outputs when the reset signal either rises or falls.

level

Reset the outputs when the reset signal either:

- Is nonzero at the current time step
- Changes from nonzero at the previous time step to zero at the current time step

This option holds the outputs to the initial conditions while the reset signal is nonzero.

Dependencies

To enable this parameter, set **Controller** to a type that has derivative or integral action.

Programmatic Use

Block Parameter: ExternalReset

Type: string, character vector

Values: "none", "rising", "falling", "either", "level"

Default: "none"

Ignore reset when linearizing — Force linearization to ignore reset

off (default) | on

Select to force Simulink and Simulink Control Design linearization commands to ignore any reset mechanism specified in the **External reset** parameter. Ignoring reset states allows you to linearize a model around an operating point even if that operating point causes the block to reset.

Programmatic Use

Block Parameter: IgnoreLimit

Type: string, character vector

Values: "off", "on"

Default: "off"

Enable tracking mode — Activate signal tracking

off (default) | on

Signal tracking lets the block output follow a tracking signal that you provide at the **TR** port. When signal tracking is active, the difference between the tracking signal and the block output is fed back to the integrator input with a gain K_t , specified by the **Tracking gain (Kt)** parameter. Signal tracking has several applications, including bumpless control transfer and avoiding windup in multiloop control structures.

Bumpless control transfer

Use signal tracking to achieve bumpless control transfer in systems that switch between two controllers. Suppose you want to transfer control between a PID controller and another controller. To do so, connecting the controller output to the **TR** input as shown in the following illustration.

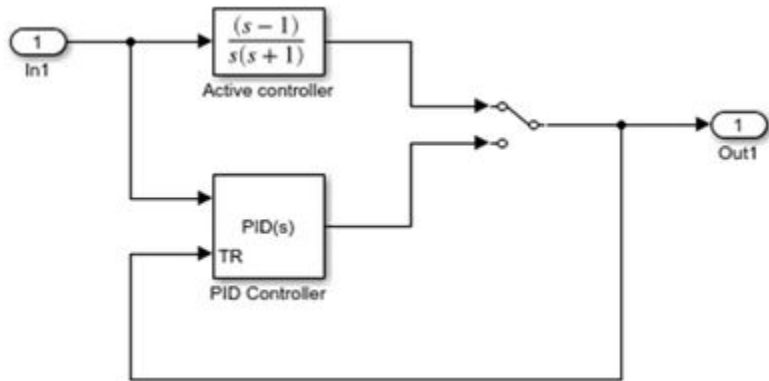

For more information, see “Bumpless Control Transfer” on page 12-100.

Multiloop control

Use signal tracking to prevent block windup in multiloop control approaches, as in the following model.

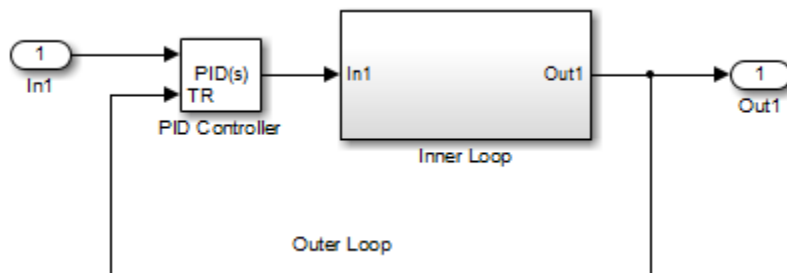

The Inner Loop subsystem contains the blocks shown in the following diagram.

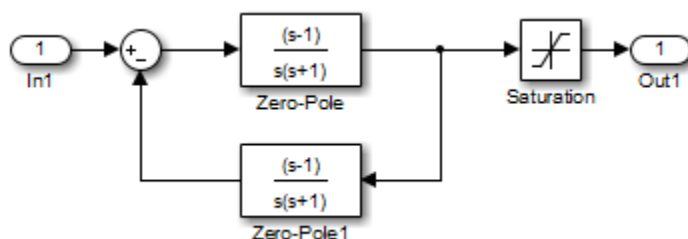

Because the PID controller tracks the output of the inner loop, its output never exceeds the saturated inner-loop output. For more details, see “Prevent Block Windup in Multiloop Control” on page 12-99.

Dependencies

To enable this parameter, set **Controller** to a type that has integral action.

Programmatic Use

Block Parameter: TrackingMode

Type: string, character vector

Values: "off", "on"

Default: "off"

Tracking coefficient (Kt) — Gain of signal-tracking feedback loop

1 (default) | scalar

When you select **Enable tracking mode**, the difference between the signal **TR** and the block output is fed back to the integrator input with a gain **Kt**. Use this parameter to specify the gain in that feedback loop.

Dependencies

To enable this parameter, select **Enable tracking mode**.

Programmatic Use

Block Parameter: Kt

Type: scalar

Default: 1

Output saturation

Limit Output — Limit block output to specified saturation values

off (default) | on

Activating this option limits the block output, so that you do not need a separate Saturation on page 1-1512 block after the controller. It also allows you to activate the anti-windup mechanism built into the block (see the **Anti-windup method** parameter). Specify the output saturation limits using the **Lower limit** and **Upper limit** parameters. You can also specify the saturation limits externally as block input ports.

Programmatic Use

Block Parameter: LimitOutput

Type: string, character vector

Values: "off", "on"

Default: "off"

Source — Source for output saturation limits

internal (default) | external

Use this parameter to specify how to supply the upper and lower saturation limits of the block output.

internal

Specify the output saturation limits using the **Upper limit** and **Lower limit** parameters.

external

Specify the output saturation limits externally using block input ports. The additional input ports **up** and **lo** appear on the block. You can use the input ports to implement the upper and lower output saturation limits determined by logic or other calculations in the Simulink model and passed to the block.

Programmatic Use

Block Parameter: SatLimitsSource

Type: string, character vector

Values: "internal", "external"

Default: "internal"

Upper limit — Upper saturation limit for block output

Inf (default) | scalar

Specify the upper limit for the block output. The block output is held at the **Upper saturation limit** whenever the weighted sum of the proportional, integral, and derivative actions exceeds that value.

Dependencies

To enable this parameter, select **Limit output**.

Programmatic Use

Block Parameter: UpperSaturationLimit

Type: scalar

Default: Inf

Lower limit — Lower saturation limit for block output

-Inf (default) | scalar

Specify the lower limit for the block output. The block output is held at the **Lower saturation limit** whenever the weighted sum of the proportional, integral, and derivative actions goes below that value.

Dependencies

To enable this parameter, select **Limit output**.

Programmatic Use

Block Parameter: LowerSaturationLimit

Type: scalar

Default: -Inf

Ignore saturation when linearizing — Force linearization to ignore output limits

off (default) | on

Force Simulink and Simulink Control Design linearization commands to ignore block output limits specified in the **Upper limit** and **Lower limit** parameters. Ignoring output limits allows you to linearize a model around an operating point even if that operating point causes the block to exceed the output limits.

Dependencies

To enable this parameter, select the **Limit output** parameter.

Programmatic Use

Block Parameter: LinearizeAsGain

Type: string, character vector

Values: "off", "on"

Default: "off"

Anti-windup method — Integrator anti-windup method

none (default) | back-calculation | clamping

When you select **Limit output** and the weighted sum of the controller components exceeds the specified output limits, the block output holds at the specified limit. However, the integrator output can continue to grow (integrator windup), increasing the difference between the block output and the sum of the block components. In other words, the internal signals in the block can be unbounded

even if the output appears bounded by saturation limits. Without a mechanism to prevent integrator windup, two results are possible:

- If the sign of the input signal never changes, the integrator continues to integrate until it overflows. The overflow value is the maximum or minimum value for the data type of the integrator output.
- If the sign of the input signal changes once the weighted sum has grown beyond the output limits, it can take a long time to unwind the integrator and return the weighted sum within the block saturation limit.

In either case, controller performance can suffer. To combat the effects of windup without an anti-windup mechanism, it may be necessary to detune the controller (for example, by reducing the controller gains), resulting in a sluggish controller. To avoid this problem, activate an anti-windup mechanism using this parameter.

none

Do not use an anti-windup mechanism.

back-calculation

Unwind the integrator when the block output saturates by feeding back to the integrator the difference between the saturated and unsaturated control signal. The following diagram represents the back-calculation feedback circuit for a continuous-time controller. To see the actual feedback circuit for your controller configuration, right-click on the block and select **Mask > Look Under Mask**.

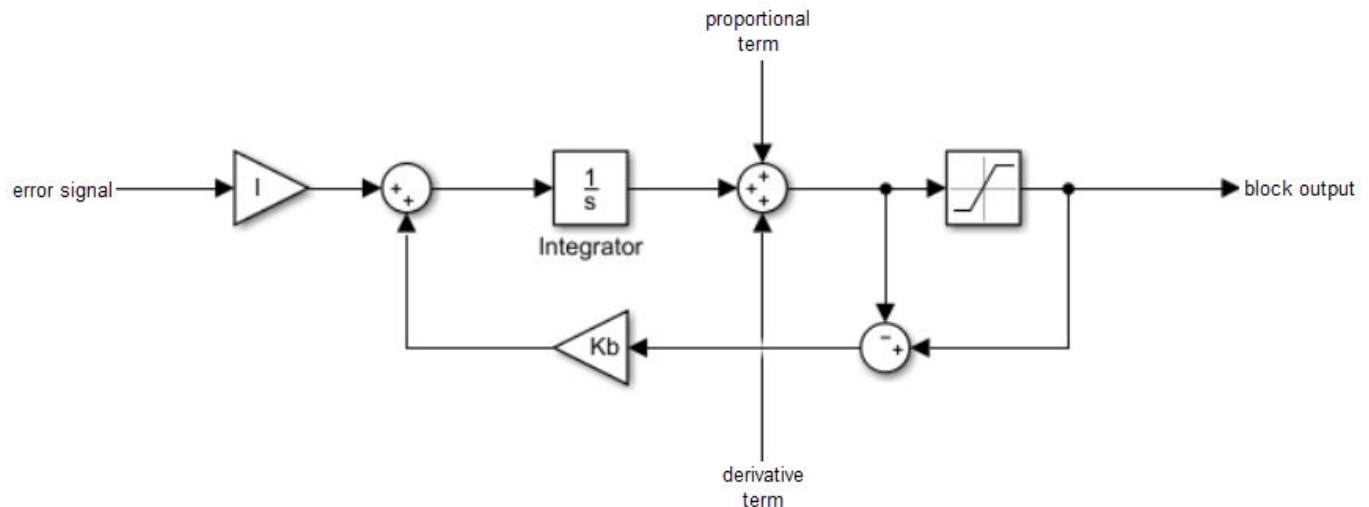

Use the **Back-calculation coefficient (Kb)** parameter to specify the gain of the anti-windup feedback circuit. It is usually satisfactory to set $K_b = I$, or for controllers with derivative action, $K_b = \sqrt{I \cdot D}$. Back-calculation can be effective for plants with relatively large dead time [1].

clamping

Integration stops when the sum of the block components exceeds the output limits and the integrator output and block input have the same sign. Integration resumes when the sum of the block components exceeds the output limits and the integrator output and block input have opposite sign. Clamping is sometimes referred to as conditional integration.

Clamping can be useful for plants with relatively small dead times, but can yield a poor transient response for large dead times [1].

Dependencies

To enable this parameter, select the **Limit output** parameter.

Programmatic Use

Block Parameter: AntiWindupMode

Type: string, character vector

Values: "none", "back-calculation", "clamping"

Default: "none"

Back-calculation coefficient (Kb) — Gain coefficient of anti-windup feedback loop

1 (default) | scalar

The **back-calculation** anti-windup method unwinds the integrator when the block output saturates. It does so by feeding back to the integrator the difference between the saturated and unsaturated control signal. Use the **Back-calculation coefficient (Kb)** parameter to specify the gain of the anti-windup feedback circuit. For more information, see the **Anti-windup method** parameter.

Dependencies

To enable this parameter, select the **Limit output** parameter, and set the **Anti-windup method** parameter to **back-calculation**.

Programmatic Use

Block Parameter: Kb

Type: scalar

Default: 1

Data Types

The parameters in this tab are primarily of use in fixed-point code generation using Fixed-Point Designer. They define how numeric quantities associated with the block are stored and processed when you generate code.

If you need to configure data types for fixed-point code generation, click **Open Fixed-Point Tool** and use that tool to configure the rest of the parameters in the tab. For information about using Fixed-Point Tool, see “Autoscaling Data Objects Using the Fixed-Point Tool” (Fixed-Point Designer).

After you use Fixed-Point Tool, you can use the parameters in this tab to make adjustments to fixed-point data-type settings if necessary. For each quantity associated with the block, you can specify:

- Floating-point or fixed-point data type, including whether the data type is inherited from upstream values in the block.
- The minimum and maximum values for the quantity, which determine how the quantity is scaled for fixed-point representation.

For assistance in selecting appropriate values, click  to open the Data Type Assistant for the corresponding quantity. For more information, see “Specify Data Types Using Data Type Assistant”.

| Main | | Initialization | | Output saturation | | Data Types | | State Attributes | |
|------------------------------------|------------------------------------|--|---------|-------------------|---------|------------|--|--------------------------|--|
| Fixed-point operational parameters | | | | | | | | | |
| Integer rounding mode: | | Floor | | | | | | | |
| <input type="checkbox"/> | | Saturate on integer overflow | | | | | | | |
| <input type="checkbox"/> | | Lock data type settings against changes by the fixed-point tools | | | | | | | |
| | | | | | | | | Open Fixed-Point Tool... | |
| Data Type | | | Minimum | | Maximum | | | | |
| P product output: | Inherit: Inherit via internal rule | >> | | : | | : | | : | |
| I product output: | Inherit: Inherit via internal rule | >> | | : | | : | | : | |
| D product output: | Inherit: Inherit via internal rule | >> | | : | | : | | : | |
| N product output: | Inherit: Inherit via internal rule | >> | | : | | : | | : | |
| b product output: | Inherit: Inherit via internal rule | >> | | : | | : | | : | |
| c product output: | Inherit: Inherit via internal rule | >> | | : | | : | | : | |
| Sum output: | Inherit: Inherit via internal rule | >> | | : | | : | | : | |
| ▶ Additional data types | | | | | | | | | |

The specific quantities listed in the Data Types tab vary depending on how you configure the PID controller block. In general, you can configure data types for the following types of quantities:

- Product output — Stores the result of a multiplication carried out under the block mask. For example, **P product output** stores the output of the gain block that multiplies the block input with the proportional gain **P**.
- Parameter — Stores the value of a numeric block parameter, such as **P**, **I**, or **D**.
- Block output — Stores the output of a block that resides under the PID controller block mask. For example, use **Integrator output** to specify the data type of the output of the block called Integrator. This block resides under the mask in the Integrator subsystem, and computes integrator term of the controller action.
- Accumulator — Stores values associated with a sum block. For example, **SumI2 Accumulator** sets the data type of the accumulator associated with the sum block SumI2. This block resides under the mask in the Back Calculation subsystem of the Anti-Windup subsystem.

In general, you can find the block associated with any listed parameter by looking under the PID Controller block mask and examining its subsystems. You can also use the Model Explorer to search under the mask for the listed parameter name, such as SumI2. (See **Model Explorer**.)

Matching Input and Internal Data Types

By default, all data types in the block are set to `Inherit: Inherit via internal rule`. With this setting, Simulink chooses data types to balance numerical accuracy, performance, and generated code size, while accounting for the properties of the embedded target hardware.

Under some conditions, incompatibility can occur between data types within the block. For instance, in continuous time, the Integrator block under the mask can accept only signals of type `double`. If the block input signal is a type that cannot be converted to `double`, such as `uint16`, the internal rules for type inheritance generate an error when you generate code.

To avoid such errors, you can use the Data Types settings to force a data type conversion. For instance, you can explicitly set **P product output**, **I product output**, and **D product output** to `double`, ensuring that the signals reaching the continuous-time integrators are of type `double`.

In general, it is not recommended to use the block in continuous time for code generation applications. However, similar data type errors can occur in discrete time, if you explicitly set some values to data types that are incompatible with downstream signal constraints within the block. In such cases, use the Data Types settings to ensure that all data types are internally compatible.

Fixed-Point Operational Parameters

Integer rounding mode — Rounding mode for fixed-point operations

Floor (default) | Ceiling | Convergent | Nearest | Round | Simplest | Zero

Specify the rounding mode for fixed-point operations. For more information, see “Rounding” (Fixed-Point Designer).

Block parameters always round to the nearest representable value. To control the rounding of a block parameter, enter an expression using a MATLAB rounding function into the mask field.

Programmatic Use

Block Parameter: RndMeth

Type: character vector

Values: 'Ceiling' | 'Convergent' | 'Floor' | 'Nearest' | 'Round' | 'Simplest' | 'Zero'

Default: 'Floor'

Saturate on integer overflow — Method of overflow action

off (default) | on

Specify whether overflows saturate or wrap.

- `off` — Overflows wrap to the appropriate value that the data type can represent.
For example, the number 130 does not fit in a signed 8-bit integer and wraps to -126.
- `on` — Overflows saturate to either the minimum or maximum value that the data type can represent.

For example, an overflow associated with a signed 8-bit integer can saturate to -128 or 127.

Tip

- Consider selecting this check box when your model has a possible overflow and you want explicit saturation protection in the generated code.
- Consider clearing this check box when you want to optimize efficiency of your generated code.

Clearing this check box also helps you to avoid overspecifying how a block handles out-of-range signals. For more information, see “Troubleshoot Signal Range Errors”.

- When you select this check box, saturation applies to every internal operation on the block, not just the output or result.
 - In general, the code generation process can detect when overflow is not possible. In this case, the code generator does not produce saturation code.
-

Programmatic Use**Block Parameter:** SaturateOnIntegerOverflow**Type:** character vector**Values:** 'off' | 'on'**Default:** 'off'**Lock data type settings against changes by the fixed-point tools – Prevent fixed-point tools from overriding data types**

off (default) | on

Select this parameter to prevent the fixed-point tools from overriding the data types you specify on this block. For more information, see “Lock the Output Data Type Setting” (Fixed-Point Designer).

Programmatic Use**Block Parameter:** LockScale**Type:** character vector**Values:** 'off' | 'on'**Default:** 'off'**State Attributes**

The parameters in this tab are primarily of use in code generation.

State name (e.g., 'position') – Name for continuous-time filter and integrator states

' ' (default) | character vector

Assign a unique name to the state associated with the integrator or the filter, for continuous-time PID controllers. (For information about state names in a discrete-time PID controller, see the **State name** parameter.) The state name is used, for example:

- For the corresponding variable in generated code
- As part of the storage name when logging states during simulation
- For the corresponding state in a linear model obtain by linearizing the block

A valid state name begins with an alphabetic or underscore character, followed by alphanumeric or underscore characters.

Dependencies

To enable this parameter, set **Time domain** to Continuous-time.

Programmatic Use**Parameter:** IntegratorContinuousStateAttributes, FilterContinuousStateAttributes**Type:** character vector**Default:** ' '**State name – Names for discrete-time filter and integrator states**

empty string (default) | string | character vector

Assign a unique name to the state associated with the integrator or the filter, for discrete-time PID controllers. (For information about state names in a continuous-time PID controller, see the **State name (e.g., 'position')** parameter.)

A valid state name begins with an alphabetic or underscore character, followed by alphanumeric or underscore characters. The state name is used, for example:

- For the corresponding variable in generated code
- As part of the storage name when logging states during simulation
- For the corresponding state in a linear model obtain by linearizing the block

For more information about the use of state names in code generation, see “C Code Generation Configuration for Model Interface Elements” (Simulink Coder).

Dependencies

To enable this parameter, set **Time domain** to Discrete-time.

Programmatic Use

Parameter: IntegratorStateIdentifier, FilterStateIdentifier

Type: string, character vector

Default: ""

State name must resolve to Simulink signal object — Require that state name resolve to a signal object

off (default) | on

Select this parameter to require that the discrete-time integrator or filter state name resolves to a Simulink signal object.

Dependencies

To enable this parameter for the discrete-time integrator or filter state:

- 1 Set **Time domain** to Discrete-time.
- 2 Specify a value for the integrator or filter **State name**.
- 3 Set the model configuration parameter **Signal resolution** to a value other than None.

Programmatic Use

Block Parameter: IntegratorStateMustResolveToSignalObject, FilterStateMustResolveToSignalObject

Type: string, character vector

Values: "off", "on"

Default: "off"

Block Characteristics

| | |
|---------------------------------|---|
| Data Types | double fixed point integer single |
| Direct Feedthrough | no |
| Multidimensional Signals | no |
| Variable-Size Signals | no |

| | |
|--------------------------------|----|
| Zero-Crossing Detection | no |
|--------------------------------|----|

Compatibility Considerations

ReferenceBlock parameter returns different path

Behavior changed in R2021b

Starting in R2021b, the `get_param` function returns a different value for the `ReferenceBlock` parameter. The `ReferenceBlock` parameter is a property common to all Simulink blocks and gives the path of the library block to which a block links. The PID Controller and Discrete PID Controller blocks now link to `'slpidlib/PID Controller'`. Previously, the blocks linked to `'pid_lib/PID Controller'`.

This change does not affect any other functionality or workflows. You can still use the previous path with the `set_param` function.

ReferenceBlock parameter returns different path

Behavior changed in R2020b

Starting in R2020b, the `get_param` function returns a different value for the `ReferenceBlock` parameter. The `ReferenceBlock` parameter is a property common to all Simulink blocks and gives the path of the library block to which a block links. The PID Controller and Discrete PID Controller blocks now link to `'pid_lib/PID Controller'`. Previously, the blocks linked to `'simulink/Continuous/PID Controller'`.

This change does not affect any other functionality or workflows. You can still use the previous path with the `set_param` function.

References

- [1] Visioli, A., "Modified Anti-Windup Scheme for PID Controllers," *IEE Proceedings - Control Theory and Applications*, Vol. 150, Number 1, January 2003

Extended Capabilities

C/C++ Code Generation

Generate C and C++ code using Simulink® Coder™.

For continuous-time PID controllers (**Time domain** set to `Continuous-time`):

- Consider using "Model Discretizer" to map continuous-time blocks to discrete equivalents that support code generation. To access Model Discretizer, from your model, in the **Apps** tab, under **Control Systems**, click **Model Discretizer**.
- Not recommended for production code.

For discrete-time PID controllers (**Time domain** set to `Discrete-time`):

- Depends on absolute time when placed inside a triggered subsystem hierarchy.
- Generated code relies on `memcpy` or `memset` functions (`string.h`) under certain conditions.

HDL Code Generation

Generate Verilog and VHDL code for FPGA and ASIC designs using HDL Coder™.

HDL Coder provides additional configuration options that affect HDL implementation and synthesized logic.

HDL Architecture

This block has a single, default HDL architecture.

HDL Block Properties

| | |
|----------------------------------|--|
| ConstrainedOutputPipeline | Number of registers to place at the outputs by moving existing delays within your design. Distributed pipelining does not redistribute these registers. The default is 0. For more details, see “ConstrainedOutputPipeline” (HDL Coder). |
| InputPipeline | Number of input pipeline stages to insert in the generated code. Distributed pipelining and constrained output pipelining can move these registers. The default is 0. For more details, see “InputPipeline” (HDL Coder). |
| OutputPipeline | Number of output pipeline stages to insert in the generated code. Distributed pipelining and constrained output pipelining can move these registers. The default is 0. For more details, see “OutputPipeline” (HDL Coder). |

Restrictions

- HDL code generation is supported for discrete-time PID controllers only (**Time domain** set to Discrete-time).
- If the **Integrator method** is set to BackwardEuler or Trapezoidal, you cannot generate HDL code for the block under either of the following conditions:
 - **Limit output** is selected and the **Anti-Windup Method** is anything other than none.
 - **Enable tracking mode** is selected.
- To generate HDL code:
 - Use a discrete-time PID controller. On the **Time domain** section, specify **Discrete-time**.
 - Leave the **Use filtered derivative** check box selected.
 - Specify the initial conditions of the filter and integrator internally. On the **Initialization** tab, specify **Source** as internal.

You can specify the filter coefficients internally and externally for HDL code generation. On the **Main** tab, for **Source**, you can use internal or external.

- Set **External reset** to none.
- When you use double inputs, do not set **Anti-windup Method** to clamping.

PLC Code Generation

Generate Structured Text code using Simulink® PLC Coder™.

Fixed-Point Conversion

Design and simulate fixed-point systems using Fixed-Point Designer™.

Fixed-point code generation is supported for discrete-time PID controllers only (**Time domain** set to **Discrete-time**).

See Also

Gain | Discrete-Time Integrator | Discrete Derivative | PID Controller | Discrete PID Controller (2DOF)

Introduced in R2009b

Discrete PID Controller (2DOF)

Discrete-time or continuous-time two-degree-of-freedom PID controller

Library: Simulink / Discrete

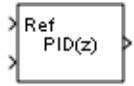

Description

The Discrete PID Controller (2DOF) block implements a two-degree-of-freedom PID controller (PID, PI, or PD). The block is identical to the PID Controller (2DOF) block with the **Time domain** parameter set to **Discrete-time**.

The block generates an output signal based on the difference between a reference signal and a measured system output. The block computes a weighted difference signal for the proportional and derivative actions according to the setpoint weights (**b** and **c**) that you specify. The block output is the sum of the proportional, integral, and derivative actions on the respective difference signals, where each action is weighted according to the gain parameters **P**, **I**, and **D**. A first-order pole filters the derivative action.

The block supports several controller types and structures. Configurable options in the block include:

- Controller type (PID, PI, or PD) — See the **Controller** parameter.
- Controller form (Parallel or Ideal) — See the **Form** parameter.
- Time domain (discrete or continuous) — See the **Time domain** parameter.
- Initial conditions and reset trigger — See the **Source** and **External reset** parameters.
- Output saturation limits and built-in anti-windup mechanism — See the **Limit output** parameter.
- Signal tracking for bumpless control transfer and multiloop control — See the **Enable tracking mode** parameter.

As you change these options, the internal structure of the block changes by activating different variant subsystems. (See “Variant Subsystems”.) To examine the internal structure of the block and its variant subsystems, right-click the block and select **Mask > Look Under Mask**.

Control Configuration

In one common implementation, the PID Controller block operates in the feedforward path of a feedback loop.

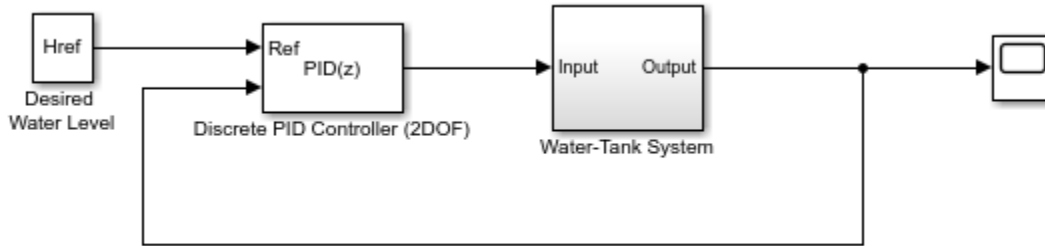

For a single-input block that accepts an error signal (a difference between a setpoint and a system output), see Discrete PID Controller.

PID Gain Tuning

The PID controller coefficients and the setpoint weights are tunable either manually or automatically. Automatic tuning requires Simulink Control Design software. For more information about automatic tuning, see the **Select tuning method** parameter.

Ports

Input

Ref — Reference signal

scalar | vector

Reference signal for plant to follow, as shown.

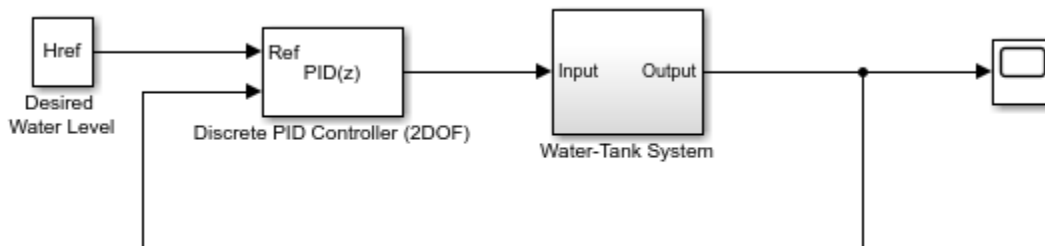

When the reference signal is a vector, the block acts separately on each signal, vectorizing the PID coefficients and producing a vector output signal of the same dimensions. You can specify the PID coefficients and some other parameters as vectors of the same dimensions as the input signal. Doing so is equivalent to specifying a separate PID controller for each entry in the input signal.

Data Types: single | double | int8 | int16 | int32 | int64 | uint8 | uint16 | uint32 | uint64 | fixed point

Port_1(y) — Measured system output

scalar | vector

Feedback signal for the controller, from the plant output.

Data Types: single | double | int8 | int16 | int32 | int64 | uint8 | uint16 | uint32 | uint64 | fixed point

P — Proportional gain

scalar | vector

Proportional gain, provided from a source external to the block. External gain input is useful, for example, when you want to map a different PID parameterization to the PID gains of the block. You can also use external gain input to implement gain-scheduled PID control. In gain-scheduled control, you determine the PID coefficients by logic or other calculation in your model and feed them to the block.

Dependencies

To enable this port, set **Controller parameters Source** to external.

Data Types: single | double | int8 | int16 | int32 | int64 | uint8 | uint16 | uint32 | uint64 | fixed point

I — Integral gain

scalar | vector

Integral gain, provided from a source external to the block. External gain input is useful, for example, when you want to map a different PID parameterization to the PID gains of the block. You can also use external gain input to implement gain-scheduled PID control. In gain-scheduled control, you determine the PID coefficients by logic or other calculation in your model and feed them to the block.

When you supply gains externally, time variations in the integral gain are also integrated. This result occurs because of the way the PID gains are implemented within the block. For details, see the **Controller parameters Source** parameter.

Dependencies

To enable this port, set **Controller parameters Source** to external, and set **Controller** to a controller type that has integral action.

Data Types: single | double | int8 | int16 | int32 | int64 | uint8 | uint16 | uint32 | uint64 | fixed point

D — Derivative gain

scalar | vector

Derivative gain, provided from a source external to the block. External gain input is useful, for example, when you want to map a different PID parameterization to the PID gains of the block. You can also use external gain input to implement gain-scheduled PID control. In gain-scheduled control, you determine the PID coefficients by logic or other calculation in your model and feed them to the block.

When you supply gains externally, time variations in the derivative gain are also differentiated. This result occurs because of the way the PID gains are implemented within the block. For details, see the **Controller parameters Source** parameter.

Dependencies

To enable this port, set **Controller parameters Source** to external, and set **Controller** to a controller type that has derivative action.

Data Types: single | double | int8 | int16 | int32 | int64 | uint8 | uint16 | uint32 | uint64 | fixed point

N – Filter coefficient

scalar | vector

Derivative filter coefficient, provided from a source external to the block. External coefficient input is useful, for example, when you want to map a different PID parameterization to the PID gains of the block. You can also use the external input to implement gain-scheduled PID control. In gain-scheduled control, you determine the PID coefficients by logic or other calculation in your model and feed them to the block.

Dependencies

To enable this port, set **Controller parameters Source** to `external`, and set **Controller** to a controller type that has a filtered derivative.

Data Types: `single` | `double` | `int8` | `int16` | `int32` | `int64` | `uint8` | `uint16` | `uint32` | `uint64` | `fixed point`

b – Proportional setpoint weight

scalar | vector

Proportional setpoint weight, provided from a source external to the block. External input is useful, for example, when you want to map a different PID parameterization to the PID gains of the block. You can also use the external input to implement gain-scheduled PID control. In gain-scheduled control, you determine the PID coefficients by logic or other calculation in your model and feed them to the block.

Dependencies

To enable this port, set **Controller parameters Source** to `external`.

Data Types: `single` | `double` | `int8` | `int16` | `int32` | `int64` | `uint8` | `uint16` | `uint32` | `uint64` | `fixed point`

c – Derivative setpoint weight

scalar | vector

Derivative setpoint weight, provided from a source external to the block. External input is useful, for example, when you want to map a different PID parameterization to the PID gains of the block. You can also use the external input to implement gain-scheduled PID control. In gain-scheduled control, you determine the PID coefficients by logic or other calculation in your model and feed them to the block.

Dependencies

To enable this port, set **Controller parameters Source** to `external`, and set **Controller** to a controller type that has derivative action.

Data Types: `single` | `double` | `int8` | `int16` | `int32` | `int64` | `uint8` | `uint16` | `uint32` | `uint64` | `fixed point`

Reset – External reset trigger

scalar

Trigger to reset the integrator and filter to their initial conditions. Use the **External reset** parameter to specify what kind of signal triggers a reset. The port icon indicates the trigger type specified in that parameter. For example, the following illustration shows a continuous-time PID Controller (2DOF) block with **External reset** set to `rising`.

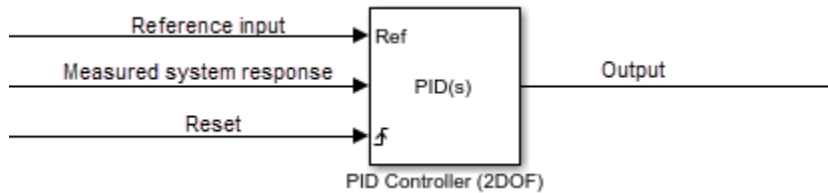

When the trigger occurs, the block resets the integrator and filter to the initial conditions specified by the **Integrator Initial condition** and **Filter Initial condition** parameters or the I_0 and D_0 ports.

Note To be compliant with the Motor Industry Software Reliability Association (MISRA) software standard, your model must use Boolean signals to drive the external reset ports of the PID controller block.

Dependencies

To enable this port, set **External reset** to any value other than none.

Data Types: single | double | int8 | int16 | int32 | int64 | uint8 | uint16 | uint32 | uint64 | fixed point | Boolean

I_0 – Integrator initial condition

scalar | vector

Integrator initial condition, provided from a source external to the block.

Dependencies

To enable this port, set **Initial conditions Source** to external, and set **Controller** to a controller type that has integral action.

Data Types: single | double | int8 | int16 | int32 | int64 | uint8 | uint16 | uint32 | uint64 | fixed point

D_0 – Filter initial condition

scalar | vector

Initial condition of the derivative filter, provided from a source external to the block.

Dependencies

To enable this port, set **Initial conditions Source** to external, and set **Controller** to a controller type that has derivative action.

Data Types: single | double | int8 | int16 | int32 | int64 | uint8 | uint16 | uint32 | uint64 | fixed point

up – Output saturation upper limit

scalar | vector

Upper limit of the block output, provided from a source external to the block. If the weighted sum of the proportional, integral, and derivative actions exceeds the value provided at this port, the block output is held at that value.

Dependencies

To enable this port, select **Limit output** and set the output saturation **Source** to **external**.

Data Types: `single` | `double` | `int8` | `int16` | `int32` | `int64` | `uint8` | `uint16` | `uint32` | `uint64` | `fixed point`

Lo — Output saturation lower limit

scalar | vector

Lower limit of the block output, provided from a source external to the block. If the weighted sum of the proportional, integral, and derivative actions goes below the value provided at this port, the block output is held at that value.

Dependencies

To enable this port, select **Limit output** and set the output saturation **Source** to **external**.

Data Types: `single` | `double` | `int8` | `int16` | `int32` | `int64` | `uint8` | `uint16` | `uint32` | `uint64` | `fixed point`

TR — Tracking signal

scalar | vector

Signal for controller output to track. When signal tracking is active, the difference between the tracking signal and the block output is fed back to the integrator input. Signal tracking is useful for implementing bumpless control transfer in systems that switch between two controllers. It can also be useful to prevent block windup in multiloop control systems. For more information, see the **Enable tracking mode** parameter.

Dependencies

To enable this port, select the **Enable tracking mode** parameter.

Data Types: `single` | `double` | `int8` | `int16` | `int32` | `int64` | `uint8` | `uint16` | `uint32` | `uint64` | `fixed point`

T_{DTI} — Discrete-integrator time

scalar

Discrete-integrator time, provided as a scalar to the block. You can use your own value of discrete-time integrator sample time that defines the rate at which the block is going to be run either in Simulink or on external hardware. The value of the discrete-time integrator time should match the average sampling rate of the external interrupts, when the block is used inside a conditionally-executed subsystem.

In other words, you can specify T_s for any of the integrator methods below such that the value matches the average sampling rate of the external interrupts. In discrete time, the derivative term of the controller transfer function is:

$$D \left[\frac{N}{1 + N\alpha(z)} \right],$$

where $\alpha(z)$ depends on the integrator method you specify with this parameter.

Forward Euler

$$\alpha(z) = \frac{T_s}{z - 1}.$$

Backward Euler

$$\alpha(z) = \frac{T_s z}{z - 1}.$$

Trapezoidal

$$\alpha(z) = \frac{T_s z + 1}{2 z - 1} \cdot$$

For more information about discrete-time integration, see the Discrete-Time Integrator block reference page. For more information on conditionally executed subsystems, see “Conditionally Executed Subsystems Overview”.

Dependencies

To enable this port, set **Time Domain** to Discrete-time and select the **PID Controller is inside a conditionally executed subsystem** option.

Data Types: single | double | int8 | int16 | int32 | int64 | uint8 | uint16 | uint32 | uint64

Output

Port_1(u) – Controller output

scalar | vector

Controller output, generally based on a sum of the input signal, the integral of the input signal, and the derivative of the input signal, weighted by the setpoint weights and by the proportional, integral, and derivative gain parameters. A first-order pole filters the derivative action. Which terms are present in the controller signal depends on what you select for the **Controller** parameter. The base controller transfer function for the current settings is displayed in the **Compensator formula** section of the block parameters and under the mask. Other parameters modify the block output, such as saturation limits specified by the **Upper Limit** and **Lower Limit** saturation parameters.

The controller output is a vector signal when any of the inputs is a vector signal. In that case, the block acts as N independent PID controllers, where N is the number of signals in the input vector.

Data Types: single | double | int8 | int16 | int32 | int64 | uint8 | uint16 | uint32 | uint64 | fixed point

Parameters

Controller – Controller type

PID (default) | PI | PD

Specify which of the proportional, integral, and derivative terms are in the controller.

PID

Proportional, integral, and derivative action.

PI

Proportional and integral action only.

PD

Proportional and derivative action only.

Tip The controller output for the current setting is displayed in the **Compensator formula** section of the block parameters and under the mask.

Programmatic Use

Block Parameter: Controller

Type: string, character vector

Values: "PID", "PI", "PD"

Default: "PID"

Form – Controller structure

Parallel (default) | Ideal

Specify whether the controller structure is parallel or ideal.

Parallel

The proportional, integral, and derivative gains **P**, **I**, and **D**, are applied independently. For example, for a continuous-time 2-DOF PID controller in parallel form, the controller output u is:

$$u = P(br - y) + I\frac{1}{s}(r - y) + D\frac{N}{1 + N\frac{1}{s}}(cr - y),$$

where r is the reference signal, y is the measured plant output signal, and b and c are the setpoint weights.

For a discrete-time 2-DOF controller in parallel form, the controller output is:

$$u = P(br - y) + I\alpha(z)(r - y) + D\frac{N}{1 + N\beta(z)}(cr - y),$$

where the **Integrator method** and **Filter method** parameters determine $\alpha(z)$ and $\beta(z)$, respectively.

Ideal

The proportional gain **P** acts on the sum of all actions. For example, for a continuous-time 2-DOF PID controller in ideal form, the controller output is:

$$u = P\left[(br - y) + I\frac{1}{s}(r - y) + D\frac{N}{1 + N\frac{1}{s}}(cr - y)\right].$$

For a discrete-time 2-DOF PID controller in ideal form, the transfer function is:

$$u = P\left[(br - y) + I\alpha(z)(r - y) + D\frac{N}{1 + N\beta(z)}(cr - y)\right],$$

where the **Integrator method** and **Filter method** parameters determine $\alpha(z)$ and $\beta(z)$, respectively.

Tip The controller output for the current settings is displayed in the **Compensator formula** section of the block parameters and under the mask.

Programmatic Use

Block Parameter: Controller

Type: string, character vector

Values: "Parallel", "Ideal"

Default: "Parallel"

Time domain — Specify discrete-time or continuous-time controller

Discrete-time (default) | Continuous-time

When you select **Discrete-time**, it is recommended that you specify an explicit sample time for the block. See the **Sample time (-1 for inherited)** parameter. Selecting **Discrete-time** also enables the **Integrator method**, and **Filter method** parameters.

When the PID Controller block is in a model with synchronous state control (see the State Control block), you cannot select **Continuous-time**.

Note The PID Controller (2DOF) and Discrete PID Controller (2DOF) blocks are identical except for the default value of this parameter.

Programmatic Use

Block Parameter: TimeDomain

Type: string, character vector

Values: "Continuous-time", "Discrete-time"

Default: "Discrete-time"

PID Controller is inside a conditionally executed subsystem — Enable the discrete-integrator time port

off (default) | on

For discrete-time PID controllers, enable the discrete-time integrator port to use your own value of discrete-time integrator sample time. To ensure proper integration, Use the T_{DTI} port to provide a scalar value of Δt for accurate discrete-time integration.

Dependencies

To enable this parameter, set **Time Domain** to **Discrete-time**.

Programmatic Use

Block Parameter: UseExternalTs

Type: string, character vector

Values: "on", "off"

Default: "off"

Sample time (-1 for inherited) — Discrete interval between samples

-1 (default) | positive scalar

Specify a sample time by entering a positive scalar value, such as 0.1. The default discrete sample time of -1 means that the block inherits its sample time from upstream blocks. However, it is recommended that you set the controller sample time explicitly, especially if you expect the sample time of upstream blocks to change. The effect of the controller coefficients P, I, D, and N depend on

the sample time. Thus, for a given set of coefficient values, changing the sample time changes the performance of the controller.

See “Specify Sample Time” for more information.

To implement a continuous-time controller, set **Time domain** to Continuous -time.

Tip If you want to run the block with an externally specified or variable sample time, set this parameter to -1 and put the block in a Triggered Subsystem. Then, trigger the subsystem at the desired sample time.

Dependencies

To enable this parameter, set **Time domain** to Discrete-time.

Programmatic Use

Block Parameter: SampleTime

Type: scalar

Values: -1, positive scalar

Default: -1

Integrator method — Method for computing integral in discrete-time controller

Forward Euler (default) | Backward Euler | Trapezoidal

In discrete time, the integral term of the controller transfer function is $Ia(z)$, where $a(z)$ depends on the integrator method you specify with this parameter.

Forward Euler

Forward rectangular (left-hand) approximation,

$$\alpha(z) = \frac{T_s}{z - 1} \cdot$$

This method is best for small sampling times, where the Nyquist limit is large compared to the bandwidth of the controller. For larger sampling times, the Forward Euler method can result in instability, even when discretizing a system that is stable in continuous time.

Backward Euler

Backward rectangular (right-hand) approximation,

$$\alpha(z) = \frac{T_s z}{z - 1} \cdot$$

An advantage of the Backward Euler method is that discretizing a stable continuous-time system using this method always yields a stable discrete-time result.

Trapezoidal

Bilinear approximation,

$$\alpha(z) = \frac{T_s z + 1}{2 z - 1} \cdot$$

An advantage of the Trapezoidal method is that discretizing a stable continuous-time system using this method always yields a stable discrete-time result. Of all available integration methods, the Trapezoidal method yields the closest match between frequency-domain properties of the discretized system and the corresponding continuous-time system.

Tip The controller formula for the current setting is displayed in the **Compensator formula** section of the block parameters and under the mask.

For more information about discrete-time integration, see the Discrete-Time Integrator block reference page.

Dependencies

To enable this parameter, set **Time Domain** to Discrete-time and set **Controller** to a controller type with integral action.

Programmatic Use

Block Parameter: IntegratorMethod

Type: string, character vector

Values: "Forward Euler", "Backward Euler", "Trapezoidal"

Default: "Forward Euler"

Filter method – Method for computing derivative in discrete-time controller

Forward Euler (default) | Backward Euler | Trapezoidal

In discrete time, the derivative term of the controller transfer function is:

$$D \left[\frac{N}{1 + N\alpha(z)} \right],$$

where $\alpha(z)$ depends on the filter method you specify with this parameter.

Forward Euler

Forward rectangular (left-hand) approximation,

$$\alpha(z) = \frac{T_s}{z - 1}.$$

This method is best for small sampling times, where the Nyquist limit is large compared to the bandwidth of the controller. For larger sampling times, the Forward Euler method can result in instability, even when discretizing a system that is stable in continuous time.

Backward Euler

Backward rectangular (right-hand) approximation,

$$\alpha(z) = \frac{T_s z}{z - 1} \cdot$$

An advantage of the Backward Euler method is that discretizing a stable continuous-time system using this method always yields a stable discrete-time result.

Trapezoidal

Bilinear approximation,

$$\alpha(z) = \frac{T_s z + 1}{2 z - 1} \cdot$$

An advantage of the Trapezoidal method is that discretizing a stable continuous-time system using this method always yields a stable discrete-time result. Of all available integration methods, the Trapezoidal method yields the closest match between frequency-domain properties of the discretized system and the corresponding continuous-time system.

Tip The controller formula for the current setting is displayed in the **Compensator formula** section of the block parameters and under the mask.

For more information about discrete-time integration, see the Discrete-Time Integrator block reference page.

Dependencies

To enable this parameter, set **Time Domain** to Discrete-time and enable **Use filtered derivative**.

Programmatic Use

Block Parameter: FilterMethod

Type: string, character vector

Values: "Forward Euler", "Backward Euler", "Trapezoidal"

Default: "Forward Euler"

Main

Source — Source for controller gains and filter coefficient

internal (default) | external

internal

Specify the controller gains, filter coefficient, and setpoint weights using the block parameters **P**, **I**, **D**, **N**, **b**, and **c** respectively.

external

Specify the PID gains, filter coefficient, and setpoint weights externally using block inputs. An additional input port appears on the block for each parameter that is required for the current controller type.

Enabling external inputs for the parameters allows you to compute their values externally to the block and provide them to the block as signal inputs.

External input is useful, for example, when you want to map a different PID parameterization to the PID gains of the block. You can also use external gain input to implement gain-scheduled PID control. In gain-scheduled control, you determine the PID gains by logic or other calculation in your model and feed them to the block.

When you supply gains externally, time variations in the integral and derivative gain values are integrated and differentiated, respectively. The derivative setpoint weight c is also differentiated. This result occurs because in both continuous time and discrete time, the gains are applied to the signal before integration or differentiation. For example, for a continuous-time PID controller with external inputs, the integrator term is implemented as shown in the following illustration.



Within the block, the input signal u is multiplied by the externally supplied integrator gain, I , before integration. This implementation yields:

$$u_i = \int (r - y)I dt.$$

Thus, the integrator gain is included in the integral. Similarly, in the derivative term of the block, multiplication by the derivative gain precedes the differentiation, which causes the derivative gain D and the derivative setpoint weight c to be differentiated.

Programmatic Use

Block Parameter: ControllerParametersSource

Type: string, character vector

Values: "internal", "external"

Default: "internal"

Proportional (P) — Proportional gain

1 (default) | scalar | vector

Specify a finite, real gain value for the proportional gain. When **Controller form** is:

- **Parallel** — Proportional action is independent of the integral and derivative actions. For example, for a continuous-time 2-DOF PID controller in parallel form, the controller output u is:

$$u = P(br - y) + I\frac{1}{s}(r - y) + D\frac{N}{1 + N\frac{1}{s}}(cr - y),$$

where r is the reference signal, y is the measured plant output signal, and b and c are the setpoint weights.

For a discrete-time 2-DOF controller in parallel form, the controller output is:

$$u = P(br - y) + I\alpha(z)(r - y) + D\frac{N}{1 + N\beta(z)}(cr - y),$$

where the **Integrator method** and **Filter method** parameters determine $\alpha(z)$ and $\beta(z)$, respectively.

- **Ideal** — The proportional gain multiplies the integral and derivative terms. For example, for a continuous-time 2-DOF PID controller in ideal form, the controller output is:

$$u = P\left[(br - y) + I\frac{1}{s}(r - y) + D\frac{N}{1 + N\frac{1}{s}}(cr - y)\right].$$

For a discrete-time 2-DOF PID controller in ideal form, the transfer function is:

$$u = P\left[(br - y) + I\alpha(z)(r - y) + D\frac{N}{1 + N\beta(z)}(cr - y)\right],$$

where the **Integrator method** and **Filter method** parameters determine $\alpha(z)$ and $\beta(z)$, respectively.

Tunable: Yes

Dependencies

To enable this parameter, set the Controller parameters **Source** to `internal`.

Programmatic Use

Block Parameter: P

Type: scalar, vector

Default: 1

Integral (I) — Integral gain

1 (default) | scalar | vector

Specify a finite, real gain value for the integral gain.

Tunable: Yes

Dependencies

To enable this parameter, in the **Main** tab, set the controller-parameters **Source** to `internal`, and set **Controller** to a type that has integral action.

Programmatic Use**Block Parameter:** I**Type:** scalar, vector**Default:** 1**Derivative (D) – Derivative gain**

0 (default) | scalar | vector

Specify a finite, real gain value for the derivative gain.

Tunable: Yes**Dependencies**

To enable this parameter, in the **Main** tab, set the controller-parameters **Source** to **internal**, and set **Controller** to **PID** or **PD**.

Programmatic Use**Block Parameter:** D**Type:** scalar, vector**Default:** 0**Use filtered derivative – Apply filter to derivative term**

on (default) | off

For discrete-time PID controllers only, clear this option to replace the filtered derivative with an unfiltered discrete-time differentiator. When you do so, the derivative term of the controller output becomes:

$$D \frac{z - 1}{z T_s} (cr - y) .$$

For continuous-time PID controllers, the derivative term is always filtered.

Dependencies

To enable this parameter, set **Time domain** to **Discrete-time**, and set **Controller** to a type that has a derivative term.

Programmatic Use**Block Parameter:** UseFilter**Type:** string, character vector**Values:** "on", "off"**Default:** "on"

Filter coefficient (N) – Derivative filter coefficient

100 (default) | scalar | vector

Specify a finite, real gain value for the filter coefficient. The filter coefficient determines the pole location of the filter in the derivative action of the block. The location of the filter pole depends on the **Time domain** parameter.

- When **Time domain** is Continuous-time, the pole location is $s = -N$.
- When **Time domain** is Discrete-time, the pole location depends on the **Filter method** parameter.

| Filter Method | Location of Filter Pole |
|----------------|--|
| Forward Euler | $z_{pole} = 1 - NT_s$ |
| Backward Euler | $z_{pole} = \frac{1}{1 + NT_s}$ |
| Trapezoidal | $z_{pole} = \frac{1 - NT_s/2}{1 + NT_s/2}$ |

The block does not support $N = \text{Inf}$ (ideal unfiltered derivative). When the **Time domain** is Discrete-time, you can clear **Use filtered derivative** to remove the derivative filter.

Tunable: Yes

Dependencies

To enable this parameter, in the **Main** tab, set the controller-parameters **Source** to internal and set **Controller** to PID or PD.

Programmatic Use

Block Parameter: N

Type: scalar, vector

Default: 100

Setpoint weight (b) – Proportional setpoint weight

1 (default) | scalar | vector

Setpoint weight on the proportional term of the controller. The proportional term of a 2-DOF controller output is $P(br-y)$, where r is the reference signal and y is the measured plant output. Setting b to 0 eliminates proportional action on the reference signal, which can reduce overshoot in the system response to step changes in the setpoint. Changing the relative values of b and c changes the balance between disturbance rejection and setpoint tracking.

Tunable: Yes

Dependencies

To enable this parameter, in the **Main** tab, set the controller-parameters **Source** to internal.

Programmatic Use

Block Parameter: b

Type: scalar, vector

Default: 1

Setpoint weight (c) — Derivative setpoint weight

1 (default) | scalar | vector

Setpoint weight on the derivative term of the controller. The derivative term of a 2-DOF controller acts on $cr-y$, where r is the reference signal and y is the measured plant output. Thus, setting c to 0 eliminates derivative action on the reference signal, which can reduce transient response to step changes in the setpoint. Setting c to 0 can yield a controller that achieves both effective disturbance rejection and smooth setpoint tracking without excessive transient response. Changing the relative values of b and c changes the balance between disturbance rejection and setpoint tracking.

Tunable: Yes**Dependencies**

To enable this parameter, in the **Main** tab, set the controller-parameters **Source** to `internal` and set **Controller** to a type that has derivative action.

Programmatic Use**Block Parameter:** `c`**Type:** scalar, vector**Default:** 1**Select tuning method — Tool for automatic tuning of controller coefficients**

Transfer Function Based (PID Tuner App) (default) | Frequency Response Based

If you have Simulink Control Design software, you can automatically tune the PID coefficients when they are internal to the block. To do so, use this parameter to select a tuning tool, and click **Tune**.

Transfer Function Based (PID Tuner App)

Use **PID Tuner**, which lets you interactively tune PID coefficients while examining relevant system responses to validate performance. **PID Tuner** can tune all the coefficients **P**, **I**, **D**, and **N**, and the setpoint coefficients **b** and **c**. By default, **PID Tuner** works with a linearization of your plant model. For models that cannot be linearized, you can tune PID coefficients against a plant model estimated from simulated or measured response data. For more information, see “Design Two-Degree-of-Freedom PID Controllers” (Simulink Control Design).

Frequency Response Based

Use **Frequency Response Based PID Tuner**, which tunes PID controller coefficients based on frequency-response estimation data obtained by simulation. This tuning approach is especially useful for plants that are not linearizable or that linearize to zero. **Frequency Response Based PID Tuner** tunes the coefficients **P**, **I**, **D**, and **N**, but does not tune the setpoint coefficients **b** and **c**. For more information, see “Design PID Controller from Plant Frequency-Response Data” (Simulink Control Design).

Both of these tuning methods assume a single-loop control configuration. Simulink Control Design software includes other tuning approaches that suit more complex configurations. For information about other ways to tune a PID Controller block, see “Choose a Control Design Approach” (Simulink Control Design).

Dependencies

To enable this parameter, in the **Main** tab, set the controller-parameters **Source** to `internal`.

Enable zero-crossing detection — Detect zero crossings on reset and on entering or leaving a saturation state

on (default) | off

Zero-crossing detection can accurately locate signal discontinuities without resorting to excessively small time steps that can lead to lengthy simulation times. If you select **Limit output** or activate **External reset** in your PID Controller block, activating zero-crossing detection can reduce computation time in your simulation. Selecting this parameter activates zero-crossing detection:

- At initial-state reset
- When entering an upper or lower saturation state
- When leaving an upper or lower saturation state

For more information about zero-crossing detection, see “Zero-Crossing Detection”.

Programmatic Use

Block Parameter: ZeroCross

Type: string, character vector

Values: "on", "off"

Default: "on"

Initialization

Source — Source for integrator and derivative initial conditions

`internal` (default) | `external`

Simulink uses initial conditions to initialize the integrator and derivative-filter (or the unfiltered derivative) output at the start of a simulation or at a specified trigger event. (See the **External reset** parameter.) These initial conditions determine the initial block output. Use this parameter to select how to supply the initial condition values to the block.

`internal`

Specify the initial conditions using the **Integrator Initial condition** and **Filter Initial condition** parameters. If **Use filtered derivative** is not selected, use the **Differentiator** parameter to specify the initial condition for the unfiltered differentiator instead of a filter initial condition.

`external`

Specify the initial conditions externally using block inputs. Additional input ports **I_o** and **D_o** appear on the block. If **Use filtered derivative** is not selected, supply the initial condition for the unfiltered differentiator at **D_o** instead of a filter initial condition.

Programmatic Use

Block Parameter: InitialConditionSource

Type: string, character vector

Values: "internal", "external"

Default: "internal"

Integrator — Integrator initial condition

`0` (default) | `scalar` | `vector`

Simulink uses the integrator initial condition to initialize the integrator at the start of a simulation or at a specified trigger event (see **External reset**). The integrator initial condition and the filter initial condition determine the initial output of the PID controller block.

The integrator initial condition cannot be NaN or Inf.

Dependencies

To use this parameter, in the **Initialization** tab, set **Source** to `internal`, and set **Controller** to a type that has integral action.

Programmatic Use

Block Parameter: `InitialConditionForIntegrator`

Type: scalar, vector

Default: 0

Filter – Filter initial condition

0 (default) | scalar | vector

Simulink uses the filter initial condition to initialize the derivative filter at the start of a simulation or at a specified trigger event (see **External reset**). The integrator initial condition and the filter initial condition determine the initial output of the PID controller block.

The filter initial condition cannot be NaN or Inf.

Dependencies

To use this parameter, in the **Initialization** tab, set **Source** to `internal`, and use a controller that has a derivative filter.

Programmatic Use

Block Parameter: `InitialConditionForFilter`

Type: scalar, vector

Default: 0

Differentiator – Initial condition for unfiltered derivative

0 (default) | scalar | vector

When you use an unfiltered derivative, Simulink uses this parameter to initialize the differentiator at the start of a simulation or at a specified trigger event (see **External reset**). The integrator initial condition and the derivative initial condition determine the initial output of the PID controller block.

The derivative initial condition cannot be NaN or Inf.

Dependencies

To use this parameter, set **Time domain** to `Discrete-time`, clear the **Use filtered derivative** check box, and in the **Initialization** tab, set **Source** to `internal`.

Programmatic Use

Block Parameter: `DifferentiatorICPrevScaledInput`

Type: scalar, vector

Default: 0

Initial condition setting – Location at which initial condition is applied

State (most efficient) (default) | Output

Use this parameter to specify whether to apply the **Integrator Initial condition** and **Filter Initial condition** parameter to the corresponding block state or output. You can change this parameter at the command line only, using `set_param` to set the `InitialConditionSetting` parameter of the block.

State (most efficient)

Use this option in all situations except when the block is in a triggered subsystem or a function-call subsystem and simplified initialization mode is enabled.

Output

Use this option when the block is in a triggered subsystem or a function-call subsystem and simplified initialization mode is enabled.

For more information about the **Initial condition setting** parameter, see the Discrete-Time Integrator block.

This parameter is only accessible through programmatic use.

Programmatic Use

Block Parameter: InitialConditionSetting

Type: string, character vector

Values: "state", "output"

Default: "state"

External reset — Trigger for resetting integrator and filter values

none (default) | rising | falling | either | level

Specify the trigger condition that causes the block to reset the integrator and filter to initial conditions. (If **Use filtered derivative** is not selected, the trigger resets the integrator and differentiator to initial conditions.) Selecting any option other than **none** enables the **Reset** port on the block for the external reset signal.

none

The integrator and filter (or differentiator) outputs are set to initial conditions at the beginning of simulation, and are not reset during simulation.

rising

Reset the outputs when the reset signal has a rising edge.

falling

Reset the outputs when the reset signal has a falling edge.

either

Reset the outputs when the reset signal either rises or falls.

level

Reset the outputs when the reset signal either:

- Is nonzero at the current time step
- Changes from nonzero at the previous time step to zero at the current time step

This option holds the outputs to the initial conditions while the reset signal is nonzero.

Dependencies

To enable this parameter, set **Controller** to a type that has derivative or integral action.

Programmatic Use

Block Parameter: ExternalReset

Type: string, character vector

Values: "none", "rising", "falling", "either", "level"

Default: "none"

Ignore reset when linearizing – Force linearization to ignore reset

off (default) | on

Select to force Simulink and Simulink Control Design linearization commands to ignore any reset mechanism specified in the **External reset** parameter. Ignoring reset states allows you to linearize a model around an operating point even if that operating point causes the block to reset.

Programmatic Use

Block Parameter: IgnoreLimit

Type: string, character vector

Values: "off", "on"

Default: "off"

Enable tracking mode – Activate signal tracking

off (default) | on

Signal tracking lets the block output follow a tracking signal that you provide at the **TR** port. When signal tracking is active, the difference between the tracking signal and the block output is fed back to the integrator input with a gain K_t , specified by the **Tracking gain (Kt)** parameter. Signal tracking has several applications, including bumpless control transfer and avoiding windup in multiloop control structures.

Bumpless control transfer

Use signal tracking to achieve bumpless control transfer in systems that switch between two controllers. Suppose you want to transfer control between a PID controller and another controller. To do so, connecting the controller output to the **TR** input as shown in the following illustration.

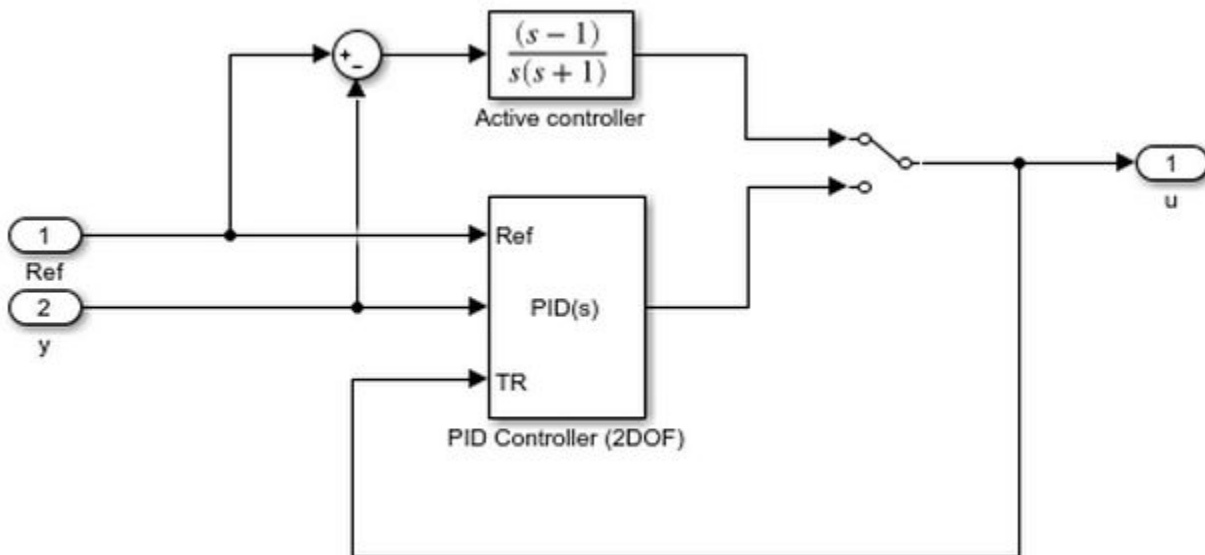

For more information, see “Bumpless Control Transfer with a Two-Degree-of-Freedom PID Controller” on page 12-101.

Multiloop control

Use signal tracking to prevent block windup in multiloop control approaches. For an example illustrating this approach with a 1DOF PID controller, see “Prevent Block Windup in Multiloop Control” on page 12-99.

Dependencies

To enable this parameter, set **Controller** to a type that has integral action.

Programmatic Use

Block Parameter: TrackingMode

Type: string, character vector

Values: "off", "on"

Default: "off"

Tracking coefficient (Kt) — Gain of signal-tracking feedback loop

1 (default) | scalar

When you select **Enable tracking mode**, the difference between the signal **TR** and the block output is fed back to the integrator input with a gain K_t . Use this parameter to specify the gain in that feedback loop.

Dependencies

To enable this parameter, select **Enable tracking mode**.

Programmatic Use

Block Parameter: Kt

Type: scalar

Default: 1

Output saturation

Limit Output — Limit block output to specified saturation values

off (default) | on

Activating this option limits the block output, so that you do not need a separate Saturation on page 1-1512 block after the controller. It also allows you to activate the anti-windup mechanism built into the block (see the **Anti-windup method** parameter). Specify the output saturation limits using the **Lower limit** and **Upper limit** parameters. You can also specify the saturation limits externally as block input ports.

Programmatic Use

Block Parameter: LimitOutput

Type: string, character vector

Values: "off", "on"

Default: "off"

Source — Source for output saturation limits

internal (default) | external

Use this parameter to specify how to supply the upper and lower saturation limits of the block output.

internal

Specify the output saturation limits using the **Upper limit** and **Lower limit** parameters.

external

Specify the output saturation limits externally using block input ports. The additional input ports **up** and **lo** appear on the block. You can use the input ports to implement the upper and lower output saturation limits determined by logic or other calculations in the Simulink model and passed to the block.

Programmatic Use

Block Parameter: SatLimitsSource

Type: string, character vector

Values: "internal", "external"

Default: "internal"

Upper limit — Upper saturation limit for block output

Inf (default) | scalar

Specify the upper limit for the block output. The block output is held at the **Upper saturation limit** whenever the weighted sum of the proportional, integral, and derivative actions exceeds that value.

Dependencies

To enable this parameter, select **Limit output**.

Programmatic Use

Block Parameter: UpperSaturationLimit

Type: scalar

Default: Inf

Lower limit — Lower saturation limit for block output

-Inf (default) | scalar

Specify the lower limit for the block output. The block output is held at the **Lower saturation limit** whenever the weighted sum of the proportional, integral, and derivative actions goes below that value.

Dependencies

To enable this parameter, select **Limit output**.

Programmatic Use

Block Parameter: LowerSaturationLimit

Type: scalar

Default: -Inf

Ignore saturation when linearizing — Force linearization to ignore output limits

off (default) | on

Force Simulink and Simulink Control Design linearization commands to ignore block output limits specified in the **Upper limit** and **Lower limit** parameters. Ignoring output limits allows you to linearize a model around an operating point even if that operating point causes the block to exceed the output limits.

Dependencies

To enable this parameter, select the **Limit output** parameter.

Programmatic Use**Block Parameter:** LinearizeAsGain**Type:** string, character vector**Values:** "off", "on"**Default:** "off"**Anti-windup method — Integrator anti-windup method**

none (default) | back-calculation | clamping

When you select **Limit output** and the weighted sum of the controller components exceeds the specified output limits, the block output holds at the specified limit. However, the integrator output can continue to grow (integrator windup), increasing the difference between the block output and the sum of the block components. In other words, the internal signals in the block can be unbounded even if the output appears bounded by saturation limits. Without a mechanism to prevent integrator windup, two results are possible:

- If the sign of the signal entering the integrator never changes, the integrator continues to integrate until it overflows. The overflow value is the maximum or minimum value for the data type of the integrator output.
- If the sign of the signal entering the integrator changes once the weighted sum has grown beyond the output limits, it can take a long time to unwind the integrator and return the weighted sum within the block saturation limit.

In either case, controller performance can suffer. To combat the effects of windup without an anti-windup mechanism, it may be necessary to detune the controller (for example, by reducing the controller gains), resulting in a sluggish controller. To avoid this problem, activate an anti-windup mechanism using this parameter.

none

Do not use an anti-windup mechanism.

back-calculation

Unwind the integrator when the block output saturates by feeding back to the integrator the difference between the saturated and unsaturated control signal. The following diagram represents the back-calculation feedback circuit for a continuous-time controller. To see the actual feedback circuit for your controller configuration, right-click on the block and select **Mask > Look Under Mask**.

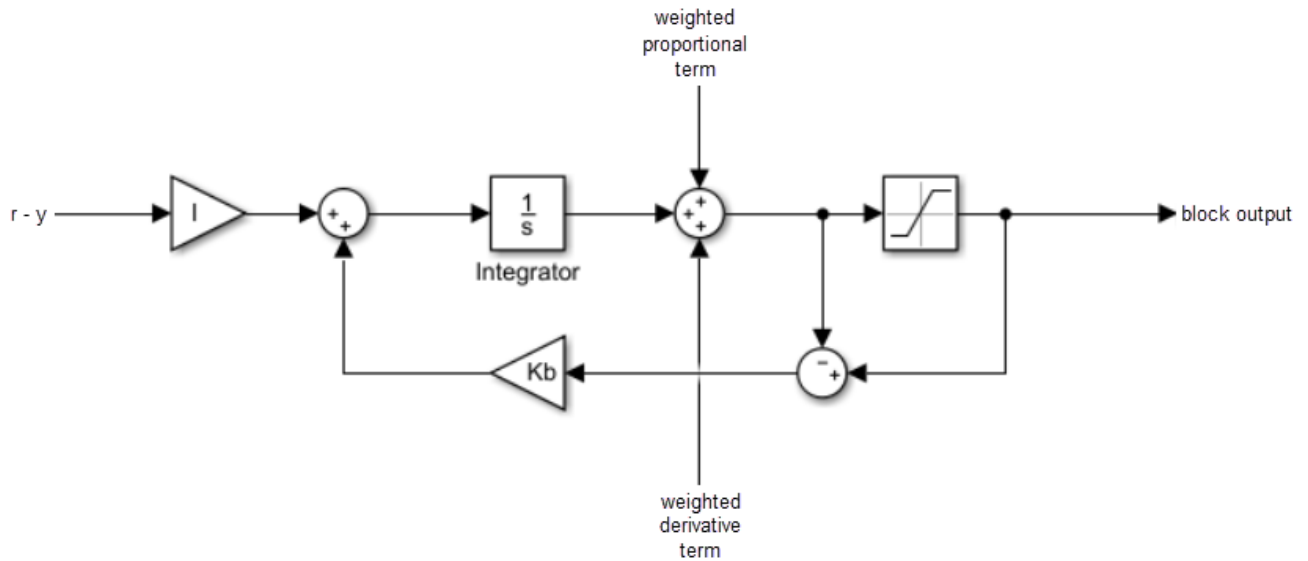

Use the **Back-calculation coefficient (Kb)** parameter to specify the gain of the anti-windup feedback circuit. It is usually satisfactory to set $Kb = I$, or for controllers with derivative action, $Kb = \sqrt{I \cdot D}$. Back-calculation can be effective for plants with relatively large dead time [1].

clamping

Integration stops when the sum of the block components exceeds the output limits and the integrator output and block input have the same sign. Integration resumes when the sum of the block components exceeds the output limits and the integrator output and block input have opposite sign. Clamping is sometimes referred to as conditional integration.

Clamping can be useful for plants with relatively small dead times, but can yield a poor transient response for large dead times [1].

Dependencies

To enable this parameter, select the **Limit output** parameter.

Programmatic Use

Block Parameter: AntiWindupMode

Type: string, character vector

Values: "none", "back-calculation", "clamping"

Default: "none"

Back-calculation coefficient (Kb) — Gain coefficient of anti-windup feedback loop

1 (default) | scalar

The **back-calculation** anti-windup method unwinds the integrator when the block output saturates. It does so by feeding back to the integrator the difference between the saturated and unsaturated control signal. Use the **Back-calculation coefficient (Kb)** parameter to specify the gain of the anti-windup feedback circuit. For more information, see the **Anti-windup method** parameter.

Dependencies

To enable this parameter, select the **Limit output** parameter, and set the **Anti-windup method** parameter to back-calculation.

Programmatic Use

Block Parameter: Kb

Type: scalar

Default: 1

Data Types

The parameters in this tab are primarily of use in fixed-point code generation using Fixed-Point Designer. They define how numeric quantities associated with the block are stored and processed when you generate code.

If you need to configure data types for fixed-point code generation, click **Open Fixed-Point Tool** and use that tool to configure the rest of the parameters in the tab. For information about using Fixed-Point Tool, see “Autoscaling Data Objects Using the Fixed-Point Tool” (Fixed-Point Designer).

After you use Fixed-Point Tool, you can use the parameters in this tab to make adjustments to fixed-point data-type settings if necessary. For each quantity associated with the block, you can specify:

- Floating-point or fixed-point data type, including whether the data type is inherited from upstream values in the block.
- The minimum and maximum values for the quantity, which determine how the quantity is scaled for fixed-point representation.

For assistance in selecting appropriate values, click  to open the Data Type Assistant for the corresponding quantity. For more information, see “Specify Data Types Using Data Type Assistant”.

| Main | | Initialization | | Output saturation | | Data Types | | State Attributes | |
|------------------------------------|------------------------------------|--|---------|-------------------|---------|------------|--|--------------------------|--|
| Fixed-point operational parameters | | | | | | | | | |
| Integer rounding mode: | | Floor | | | | | | | |
| <input type="checkbox"/> | | Saturate on integer overflow | | | | | | | |
| <input type="checkbox"/> | | Lock data type settings against changes by the fixed-point tools | | | | | | | |
| | | | | | | | | Open Fixed-Point Tool... | |
| Data Type | | | Minimum | | Maximum | | | | |
| P product output: | Inherit: Inherit via internal rule | >> | | : | | : | | : | |
| I product output: | Inherit: Inherit via internal rule | >> | | : | | : | | : | |
| D product output: | Inherit: Inherit via internal rule | >> | | : | | : | | : | |
| N product output: | Inherit: Inherit via internal rule | >> | | : | | : | | : | |
| b product output: | Inherit: Inherit via internal rule | >> | | : | | : | | : | |
| c product output: | Inherit: Inherit via internal rule | >> | | : | | : | | : | |
| Sum output: | Inherit: Inherit via internal rule | >> | | : | | : | | : | |
| ▶ Additional data types | | | | | | | | | |

The specific quantities listed in the Data Types tab vary depending on how you configure the PID controller block. In general, you can configure data types for the following types of quantities:

- Product output — Stores the result of a multiplication carried out under the block mask. For example, **P product output** stores the output of the gain block that multiplies the block input with the proportional gain **P**.
- Parameter — Stores the value of a numeric block parameter, such as **P**, **I**, or **D**.
- Block output — Stores the output of a block that resides under the PID controller block mask. For example, use **Integrator output** to specify the data type of the output of the block called Integrator. This block resides under the mask in the Integrator subsystem, and computes integrator term of the controller action.
- Accumulator — Stores values associated with a sum block. For example, **SumI2 Accumulator** sets the data type of the accumulator associated with the sum block SumI2. This block resides under the mask in the Back Calculation subsystem of the Anti-Windup subsystem.

In general, you can find the block associated with any listed parameter by looking under the PID Controller block mask and examining its subsystems. You can also use the Model Explorer to search under the mask for the listed parameter name, such as SumI2. (See **Model Explorer**.)

Matching Input and Internal Data Types

By default, all data types in the block are set to `Inherit: Inherit via internal rule`. With this setting, Simulink chooses data types to balance numerical accuracy, performance, and generated code size, while accounting for the properties of the embedded target hardware.

Under some conditions, incompatibility can occur between data types within the block. For instance, in continuous time, the Integrator block under the mask can accept only signals of type `double`. If the block input signal is a type that cannot be converted to `double`, such as `uint16`, the internal rules for type inheritance generate an error when you generate code.

To avoid such errors, you can use the Data Types settings to force a data type conversion. For instance, you can explicitly set **P product output**, **I product output**, and **D product output** to `double`, ensuring that the signals reaching the continuous-time integrators are of type `double`.

In general, it is not recommended to use the block in continuous time for code generation applications. However, similar data type errors can occur in discrete time, if you explicitly set some values to data types that are incompatible with downstream signal constraints within the block. In such cases, use the Data Types settings to ensure that all data types are internally compatible.

Fixed-Point Operational Parameters

Integer rounding mode — Rounding mode for fixed-point operations

Floor (default) | Ceiling | Convergent | Nearest | Round | Simplest | Zero

Specify the rounding mode for fixed-point operations. For more information, see “Rounding” (Fixed-Point Designer).

Block parameters always round to the nearest representable value. To control the rounding of a block parameter, enter an expression using a MATLAB rounding function into the mask field.

Programmatic Use

Block Parameter: RndMeth

Type: character vector

Values: 'Ceiling' | 'Convergent' | 'Floor' | 'Nearest' | 'Round' | 'Simplest' | 'Zero'

Default: 'Floor'

Saturate on integer overflow — Method of overflow action

off (default) | on

Specify whether overflows saturate or wrap.

- `off` — Overflows wrap to the appropriate value that the data type can represent.
For example, the number 130 does not fit in a signed 8-bit integer and wraps to -126.
- `on` — Overflows saturate to either the minimum or maximum value that the data type can represent.

For example, an overflow associated with a signed 8-bit integer can saturate to -128 or 127.

Tip

- Consider selecting this check box when your model has a possible overflow and you want explicit saturation protection in the generated code.
- Consider clearing this check box when you want to optimize efficiency of your generated code.

Clearing this check box also helps you to avoid overspecifying how a block handles out-of-range signals. For more information, see “Troubleshoot Signal Range Errors”.

- When you select this check box, saturation applies to every internal operation on the block, not just the output or result.
- In general, the code generation process can detect when overflow is not possible. In this case, the code generator does not produce saturation code.

Programmatic Use**Block Parameter:** SaturateOnIntegerOverflow**Type:** character vector**Values:** 'off' | 'on'**Default:** 'off'**Lock data type settings against changes by the fixed-point tools – Prevent fixed-point tools from overriding data types**

off (default) | on

Select this parameter to prevent the fixed-point tools from overriding the data types you specify on this block. For more information, see “Lock the Output Data Type Setting” (Fixed-Point Designer).

Programmatic Use**Block Parameter:** LockScale**Type:** character vector**Values:** 'off' | 'on'**Default:** 'off'**State Attributes**

The parameters in this tab are primarily of use in code generation.

State name (e.g., 'position') – Name for continuous-time filter and integrator states

' ' (default) | character vector

Assign a unique name to the state associated with the integrator or the filter, for continuous-time PID controllers. (For information about state names in a discrete-time PID controller, see the **State name** parameter.) The state name is used, for example:

- For the corresponding variable in generated code
- As part of the storage name when logging states during simulation
- For the corresponding state in a linear model obtain by linearizing the block

A valid state name begins with an alphabetic or underscore character, followed by alphanumeric or underscore characters.

Dependencies

To enable this parameter, set **Time domain** to Continuous-time.

Programmatic Use**Parameter:** IntegratorContinuousStateAttributes, FilterContinuousStateAttributes**Type:** character vector**Default:** ' '**State name – Names for discrete-time filter and integrator states**

empty string (default) | string | character vector

Assign a unique name to the state associated with the integrator or the filter, for discrete-time PID controllers. (For information about state names in a continuous-time PID controller, see the **State name (e.g., 'position')** parameter.)

A valid state name begins with an alphabetic or underscore character, followed by alphanumeric or underscore characters. The state name is used, for example:

- For the corresponding variable in generated code
- As part of the storage name when logging states during simulation
- For the corresponding state in a linear model obtain by linearizing the block

For more information about the use of state names in code generation, see “C Code Generation Configuration for Model Interface Elements” (Simulink Coder).

Dependencies

To enable this parameter, set **Time domain** to Discrete-time.

Programmatic Use

Parameter: IntegratorStateIdentifier, FilterStateIdentifier

Type: string, character vector

Default: ""

State name must resolve to Simulink signal object — Require that state name resolve to a signal object

off (default) | on

Select this parameter to require that the discrete-time integrator or filter state name resolves to a Simulink signal object.

Dependencies

To enable this parameter for the discrete-time integrator or filter state:

- 1 Set **Time domain** to Discrete-time.
- 2 Specify a value for the integrator or filter **State name**.
- 3 Set the model configuration parameter **Signal resolution** to a value other than None.

Programmatic Use

Block Parameter: IntegratorStateMustResolveToSignalObject, FilterStateMustResolveToSignalObject

Type: string, character vector

Values: "off", "on"

Default: "off"

Block Characteristics

| | |
|---------------------------------|---|
| Data Types | double fixed point integer single |
| Direct Feedthrough | no |
| Multidimensional Signals | no |
| Variable-Size Signals | no |

| | |
|--------------------------------|----|
| Zero-Crossing Detection | no |
|--------------------------------|----|

More About

Decomposition of 2-DOF PID Controllers

A 2-DOF PID controller can be interpreted as a PID controller with a prefilter, or a PID controller with a feedforward element.

Prefilter Decomposition

In parallel form, a two-degree-of-freedom PID controller can be equivalently modeled by the following block diagram, where C is a single degree-of-freedom PID controller and F is a prefilter on the reference signal.

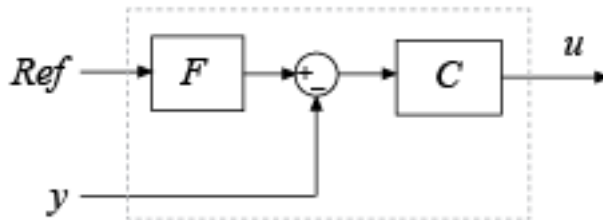

Ref is the reference signal, y is the feedback from the measured system output, and u is the controller output. For a continuous-time 2-DOF PID controller in parallel form, the transfer functions for F and C are

$$F_{par}(s) = \frac{(bP + cDN)s^2 + (bPN + I)s + IN}{(P + DN)s^2 + (PN + I)s + IN},$$

$$C_{par}(s) = \frac{(P + DN)s^2 + (PN + I)s + IN}{s(s + N)},$$

where b and c are the setpoint weights.

For a 2-DOF PID controller in ideal form, the transfer functions are

$$F_{id}(s) = \frac{(b + cDN)s^2 + (bN + I)s + IN}{(1 + DN)s^2 + (N + I)s + IN},$$

$$C_{id}(s) = P \frac{(1 + DN)s^2 + (N + I)s + IN}{s(s + N)}.$$

A similar decomposition applies for a discrete-time 2-DOF controller.

Feedforward Decomposition

Alternatively, the parallel two-degree-of-freedom PID controller can be modeled by the following block diagram.

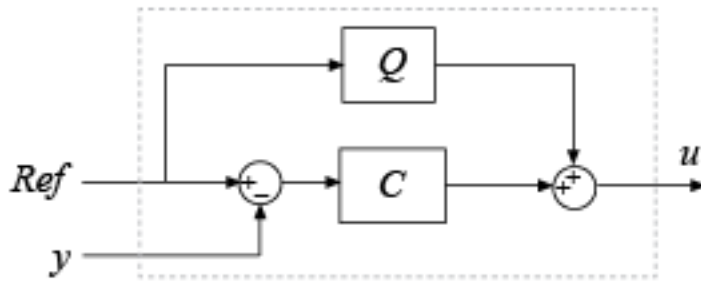

In this realization, Q acts as feed-forward conditioning on the reference signal. For a continuous-time 2-DOF PID controller in parallel form, the transfer function for Q is

$$Q_{par}(s) = \frac{((b-1)P + (c-1)DN)s + (b-1)PN}{s + N}.$$

For a 2-DOF PID controller in ideal form, the transfer function is

$$Q_{id}(s) = P \frac{((b-1) + (c-1)DN)s + (b-1)N}{s + N}.$$

The transfer functions for C are the same as in the filter decomposition.

A similar decomposition applies for a discrete-time 2-DOF controller.

Compatibility Considerations

ReferenceBlock parameter returns different path

Behavior changed in R2021b

Starting in R2021b, the `get_param` function returns a different value for the `ReferenceBlock` parameter. The `ReferenceBlock` parameter is a property common to all Simulink blocks and gives the path of the library block to which a block links. The PID Controller (2DOF) and Discrete PID Controller (2DOF) blocks now link to 'slpidlib/PID Controller (2DOF)'. Previously, the blocks linked to 'pid_lib/PID Controller (2DOF)'.

This change does not affect any other functionality or workflows. You can still use the previous path with the `set_param` function.

ReferenceBlock parameter returns different path

Behavior changed in R2020b

Starting in R2020b, the `get_param` function returns a different value for the `ReferenceBlock` parameter. The `ReferenceBlock` parameter is a property common to all Simulink blocks and gives the path of the library block to which a block links. The PID Controller (2DOF) and Discrete PID Controller (2DOF) blocks now link to 'pid_lib/PID Controller (2DOF)'. Previously, the blocks linked to 'simulink/Continuous/PID Controller (2DOF)'.

This change does not affect any other functionality or workflows. You can still use the previous path with the `set_param` function.

References

- [1] Visioli, A., "Modified Anti-Windup Scheme for PID Controllers," *IEE Proceedings - Control Theory and Applications*, Vol. 150, Number 1, January 2003

Extended Capabilities

C/C++ Code Generation

Generate C and C++ code using Simulink® Coder™.

For continuous-time PID controllers (**Time domain** set to **Continuous-time**):

- Consider using "Model Discretizer" to map continuous-time blocks to discrete equivalents that support code generation. To access Model Discretizer, in the **Apps** tab, under **Control Systems**, click **Model Discretizer**.
- Not recommended for production code.

For discrete-time PID controllers (**Time domain** set to **Discrete-time**):

- Depends on absolute time when placed inside a triggered subsystem hierarchy.
- Generated code relies on memcpy or memset functions (`string.h`) under certain conditions.

PLC Code Generation

Generate Structured Text code using Simulink® PLC Coder™.

Fixed-Point Conversion

Design and simulate fixed-point systems using Fixed-Point Designer™.

Fixed-point code generation is supported for discrete-time PID controllers only (**Time domain** set to **Discrete-time**).

See Also

Gain | Discrete-Time Integrator | Discrete Derivative | PID Controller (2DOF) | Discrete PID Controller

Introduced in R2009b

Discrete State-Space

Implement discrete state-space system

Library: Simulink / Discrete

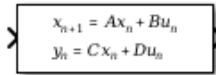

Description

Block Behavior for Non-Empty Matrices

The Discrete State-Space block implements the system described by

$$\begin{aligned}x(n+1) &= Ax(n) + Bu(n) \\ y(n) &= Cx(n) + Du(n),\end{aligned}$$

where u is the input, x is the state, and y is the output. The matrix coefficients must have these characteristics, as illustrated in the following diagram:

- **A** must be an n -by- n matrix, where n is the number of states.
- **B** must be an n -by- m matrix, where m is the number of inputs.
- **C** must be an r -by- n matrix, where r is the number of outputs.
- **D** must be an r -by- m matrix.

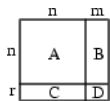

The block accepts one input and generates one output. The width of the input vector is the number of columns in the **B** and **D** matrices. The width of the output vector is the number of rows in the **C** and **D** matrices. To define the initial state vector, use the **Initial conditions** parameter.

To specify a vector or matrix of zeros for **A**, **B**, **C**, **D**, or **Initial conditions**, use the zeros function.

Block Behavior for Empty Matrices

When the matrices **A**, **B**, and **C** are empty (for example, `[]`), the functionality of the block becomes $y(n) = Du(n)$. If the **Initial conditions** vector is also empty, the block uses an initial state vector of zeros.

Ports

Input

Port_1 — Input signal

scalar | vector

Input vector, where the width equals the number of columns in the **B** and **D** matrices. For more information, see “Description” on page 1-456.

Tip For integer and fixed-point input signals, use the Fixed-Point State-Space block.

Data Types: `single` | `double`

Output

Port_1 — Output vector

scalar | vector

Output vector, with width equal to the number of rows in the **C** and **D** matrices. For more information, see “Description” on page 1-456.

Data Types: `single` | `double`

Parameters

Main

A — Matrix coefficient A

1 (default) | scalar | vector | matrix

Specify the matrix coefficient A, as a real-valued n -by- n matrix, where n is the number of states. For more information on the matrix coefficients, see “Description” on page 1-456.

Programmatic Use

Block Parameter: A

Type: character vector

Values: scalar | vector | matrix

Default: '1'

B — Matrix coefficient B

1 (default) | scalar | vector | matrix

Specify the matrix coefficient B, as a real-valued n -by- m matrix, where n is the number of states, and m is the number of inputs. For more information on the matrix coefficients, see “Description” on page 1-456.

Programmatic Use

Block Parameter: B

Type: character vector

Values: scalar | vector | matrix

Default: '1'

C — Matrix coefficient, C

1 (default) | scalar | vector | matrix

Specify the matrix coefficient C, as a real-valued r -by- n matrix, where r is the number of outputs, and n is the number of states. For more information on the matrix coefficients, see “Description” on page 1-456.

Programmatic Use

Block Parameter: C

Type: character vector

Values: scalar | vector | matrix

Default: '1'

D — Matrix coefficient, D

1 (default) | scalar | vector | matrix

Specify the matrix coefficient **D**, as a real-valued r -by- m matrix, where r is the number of outputs, and m is the number of inputs. For more information on the matrix coefficients, see “Description” on page 1-456.

Programmatic Use

Block Parameter: D

Type: character vector

Values: scalar | vector | matrix

Default: '1'

Initial conditions — Initial state vector

0 (default) | scalar | vector

Specify the initial state vector as a scalar or vector. The initial state vector cannot include `inf` or `NaN` values.

Programmatic Use

Block Parameter: InitialCondition

Type: character vector

Values: scalar | vector

Default: '0'

Sample time (-1 for inherited) — Interval between samples

-1 (default) | scalar | vector

Specify the time interval between samples. See “Specify Sample Time”.

Programmatic Use

Block Parameter: SampleTime

Type: character vector

Values: scalar | vector

Default: '-1'

State Attributes

State name — Unique name for block state

' ' (default) | alphanumeric string

Use this parameter to assign a unique name to the block state. The default is ' '. When this field is blank, no name is assigned. When using this parameter, remember these considerations:

- A valid identifier starts with an alphabetic or underscore character, followed by alphanumeric or underscore characters.
- The state name applies only to the selected block.

This parameter enables **State name must resolve to Simulink signal object** when you click **Apply**.

For more information, see “C Code Generation Configuration for Model Interface Elements” (Simulink Coder).

Programmatic Use**Block Parameter:** StateName**Type:** character vector**Values:** unique name**Default:** ''**State name must resolve to Simulink signal object – Require state name resolve to a signal object**

off (default) | on

Select this check box to require that the state name resolves to a Simulink signal object.

Dependencies

To enable this parameter, specify a value for **State name**. This parameter appears only if you set the model configuration parameter **Signal resolution** to a value other than None.

Programmatic Use**Block Parameter:** StateMustResolveToSignalObject**Type:** character vector**Values:** 'off' | 'on'**Default:** 'off'**Block Characteristics**

| | |
|---------------------------------|-----------------|
| Data Types | double single |
| Direct Feedthrough | yes |
| Multidimensional Signals | no |
| Variable-Size Signals | no |
| Zero-Crossing Detection | no |

Extended Capabilities**C/C++ Code Generation**

Generate C and C++ code using Simulink® Coder™.

Generated code relies on memcpy or memset functions (string.h) under certain conditions.

PLC Code Generation

Generate Structured Text code using Simulink® PLC Coder™.

See Also

State-Space | Fixed-Point State-Space

Topics

“C Code Generation Configuration for Model Interface Elements” (Simulink Coder)

“Organize Parameter Data into a Structure by Using Struct Storage Class” (Embedded Coder)

“Data Objects”

Introduced before R2006a

Discrete-Time Integrator

Perform discrete-time integration or accumulation of signal

Library: Simulink / Commonly Used Blocks
 Simulink / Discrete
 HDL Coder / Discrete
 HDL Coder / HDL Floating Point Operations



Description

Use the Discrete-Time Integrator block in place of the Integrator block to create a purely discrete model. With the Discrete-Time Integrator block, you can:

- Define initial conditions on the block dialog box or as input to the block
- Define an input gain (K) value
- Output the block state
- Define upper and lower limits on the integral
- Reset the state with an additional reset input

Output Equations

With the first time step, block state $n = 0$, with either initial output $y(0) = IC$ or initial state $x(0) = IC$, depending on the **Initial condition setting** parameter value.

For a given step $n > 0$ with simulation time $t(n)$, Simulink updates output $y(n)$ as follows:

- Forward Euler method:

$$y(n) = y(n-1) + K*[t(n) - t(n-1)]*u(n-1)$$

- Backward Euler method:

$$y(n) = y(n-1) + K*[t(n) - t(n-1)]*u(n)$$

- Trapezoidal method:

$$y(n) = y(n-1) + K*[t(n)-t(n-1)]*[u(n)+u(n-1)]/2$$

Simulink automatically selects a state-space realization of these output equations depending on the block sample time, which can be explicit or triggered. When using explicit sample time, $t(n) - t(n-1)$ reduces to the sample time T for all $n > 0$.

Integration and Accumulation Methods

This block can integrate or accumulate a signal using a forward Euler, backward Euler, or trapezoidal method. Assume that u is the input, y is the output, and x is the state. For a given step n , Simulink updates $y(n)$ and $x(n+1)$. In integration mode, T is the block sample time (delta T in the case of

triggered sample time). In accumulation mode, $T = 1$. The block sample time determines when the output is computed but not the output value. K is the gain value. Values clip according to upper or lower limits.

Forward Euler Method

Forward Euler method (default), also known as forward rectangular, or left-hand approximation

The software approximates $1/s$ as $T/(z-1)$. The expressions for the output of the block at step n are:

$$\begin{aligned}x(n+1) &= x(n) + K*T*u(n) \\ y(n) &= x(n)\end{aligned}$$

The block uses these steps to compute the output:

$$\begin{aligned}\text{Step } 0: & & y(0) &= \text{IC (clip if necessary)} \\ & & x(1) &= y(0) + K*T*u(0)\end{aligned}$$

$$\begin{aligned}\text{Step } 1: & & y(1) &= x(1) \\ & & x(2) &= x(1) + K*T*u(1)\end{aligned}$$

$$\begin{aligned}\text{Step } n: & & y(n) &= x(n) \\ & & x(n+1) &= x(n) + K*T*u(n) \text{ (clip if necessary)}\end{aligned}$$

Using this method, input port 1 does not have direct feedthrough.

Backward Euler Method

Backward Euler method, also known as backward rectangular or right-hand approximation

The software approximates $1/s$ as $T*z/(z-1)$. The resulting expression for the output of the block at step n is

$$y(n) = y(n-1) + K*T*u(n).$$

Let $x(n) = y((n) - 1)$. The block uses these steps to compute the output.

- If the parameter **Initial condition setting** is set to Output or Auto for triggered and function-call subsystems:

$$\begin{aligned}\text{Step } 0: & & y(0) &= \text{IC (clipped if necessary)} \\ & & x(1) &= y(0)\end{aligned}$$

- If the parameter **Initial condition setting** is set to Auto for non-triggered subsystems:

$$\begin{aligned}\text{Step } 0: & & x(0) &= \text{IC (clipped if necessary)} \\ & & x(1) &= y(0) = x(0) + K*T*u(0)\end{aligned}$$

$$\begin{aligned}\text{Step } 1: & & y(1) &= x(1) + K*T*u(1) \\ & & x(2) &= y(1)\end{aligned}$$

$$\begin{aligned}\text{Step } n: & & y(n) &= x(n) + K*T*u(n) \\ & & x(n+1) &= y(n)\end{aligned}$$

Using this method, input port 1 has direct feedthrough.

Trapezoidal Method

For this method, the software approximates $1/s$ as $T/2*(z+1)/(z-1)$.

When T is fixed (equal to the sampling period), the expressions to compute the output are:

$$\begin{aligned}x(n) &= y(n-1) + K*T/2*u(n-1) \\y(n) &= x(n) + K*T/2*u(n)\end{aligned}$$

- If the parameter **Initial condition setting** is set to Output or Auto for triggered and function-call subsystems:

$$\begin{aligned}\text{Step } 0: \quad & y(0) = \text{IC (clipped if necessary)} \\ & x(1) = y(0) + K*T/2*u(0)\end{aligned}$$

- If the parameter **Initial condition setting** is set to Auto for non-triggered subsystems:

$$\begin{aligned}\text{Step } 0: \quad & x(0) = \text{IC (clipped if necessary)} \\ & y(0) = x(0) + K*T/2*u(0) \\ & x(1) = y(0) + K*T/2*u(0)\end{aligned}$$

$$\begin{aligned}\text{Step } 1: \quad & y(1) = x(1) + K*T/2*u(1) \\ & x(2) = y(1) + K*T/2*u(1)\end{aligned}$$

$$\begin{aligned}\text{Step } n: \quad & y(n) = x(n) + K*T/2*u(n) \\ & x(n+1) = y(n) + K*T/2*u(n)\end{aligned}$$

Here, $x(n+1)$ is the best estimate of the next output. It is not the same as the state, in that $x(n)$ is not equal to $y(n)$.

Using this method, input port 1 has direct feedthrough.

When T is a Variable

When T is a variable (for example, obtained from the triggering times), the block uses these steps to compute the output.

- If the parameter **Initial condition setting** is set to Output or Auto for triggered and function-call subsystems:

$$\begin{aligned}\text{Step } 0: \quad & y(0) = \text{IC (clipped if necessary)} \\ & x(1) = y(0)\end{aligned}$$

- If the parameter **Initial condition setting** is set to Auto for non-triggered subsystems:

$$\begin{aligned}\text{Step } 0: \quad & x(0) = \text{IC (clipped if necessary)} \\ & x(1) = y(0) = x(0) + K*T/2*u(0)\end{aligned}$$

$$\begin{aligned}\text{Step } 1: \quad & y(1) = x(1) + T/2*(u(1) + u(0)) \\ & x(2) = y(1)\end{aligned}$$

$$\begin{aligned}\text{Step } n: \quad & y(n) = x(n) + T/2*(u(n) + u(n-1)) \\ & x(n+1) = y(n)\end{aligned}$$

Define Initial Conditions

You can define the initial conditions as a parameter on the block dialog box or input them from an external signal:

- To define the initial conditions as a block parameter, set the **Initial condition source** parameter to `internal` and enter the value in the **Initial condition** text box.
- To provide the initial conditions from an external source, set the **Initial condition source** parameter to `external`. An additional input port appears on the block.

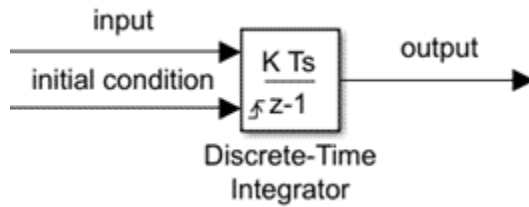

When to Use the State Port

Use the state port instead of the output port:

- When the output of the block is fed back into the block through the reset port or the initial condition port, causing an algebraic loop. For an example, see the `sldemo_bounce_two_integrators` model.
- When you want to pass the state from one conditionally executed subsystem to another, which can cause timing problems. For an example, see “Building a Clutch Lock-Up Model” on page 13-144.

You can work around these problems by passing the state through the state port rather than the output port. Simulink generates the state at a slightly different time from the output, which protects your model from these problems. To output the block state, select the **Show state port** check box. The state port appears on the top of the block.

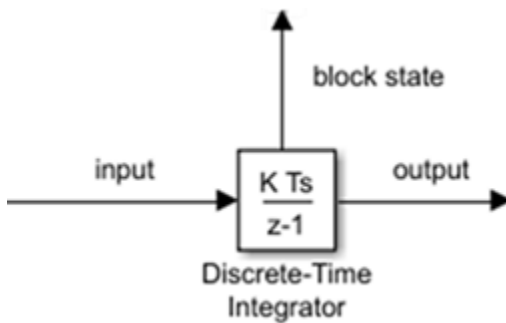

Limit the Integral

To keep the output within certain levels, select the **Limit output** check box and enter the limits in the corresponding text box. Doing so causes the block to function as a limited integrator. When the output reaches the limits, the integral action turns off to prevent integral windup. During a simulation, you can change the limits but you cannot change whether the output is limited. The table shows how the block determines output.

| Integral | Output |
|--|---|
| Less than or equal to the Lower saturation limit and the input is negative | Held at the Lower saturation limit |
| Between the Lower saturation limit and the Upper saturation limit | The integral |
| Greater than or equal to the Upper saturation limit and the input is positive | Held at the Upper saturation limit |

To generate a signal that indicates when the state is being limited, select the **Show saturation port** check box. A new saturation port appears below the block output port.

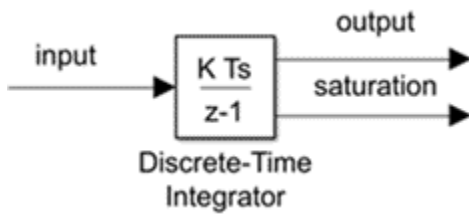

The saturation signal has one of three values:

- 1 indicates that the upper limit is being applied.
- 0 indicates that the integral is not limited.
- -1 indicates that the lower limit is being applied.

Reset the State

The block resets its state to the specified initial condition, based on an external signal. To cause the block to reset its state, select one of the **External reset** parameter options. A reset port appears that indicates the reset trigger type.

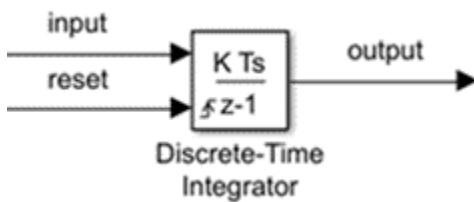

The reset port has direct feedthrough. If the block output feeds back into this port, either directly or through a series of blocks with direct feedthrough, an algebraic loop results. To resolve this loop, feed the output of the block state port into the reset port instead. To access the block state, select the **Show state port** check box.

Reset Trigger Types

The **External reset** parameter lets you determine the attribute of the reset signal that triggers the reset. The trigger options include:

- **rising** - Resets the state when the reset signal has a rising edge. For example, this figure shows the effect that a rising reset trigger has on backward Euler integration.

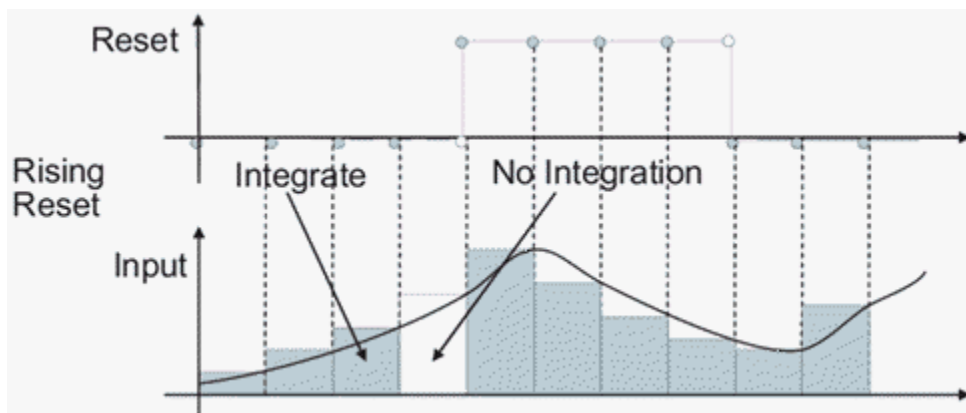

- falling — Resets the state when the reset signal has a falling edge. For example, this figure shows the effect that a falling reset trigger has on backward Euler integration.

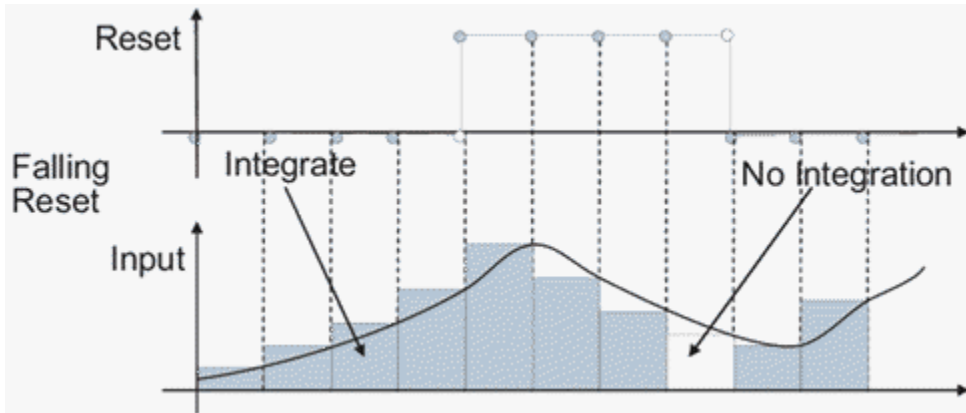

- either — Resets the state when the reset signal rises or falls. For example, the following figure shows the effect that an either reset trigger has on backward Euler integration.

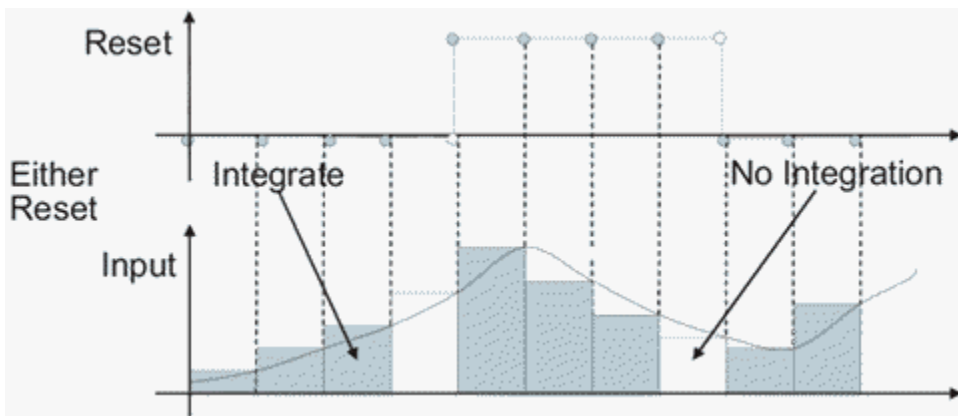

- level — Resets and holds the output to the initial condition while the reset signal is nonzero. For example, this figure shows the effect that a level reset trigger has on backward Euler integration.

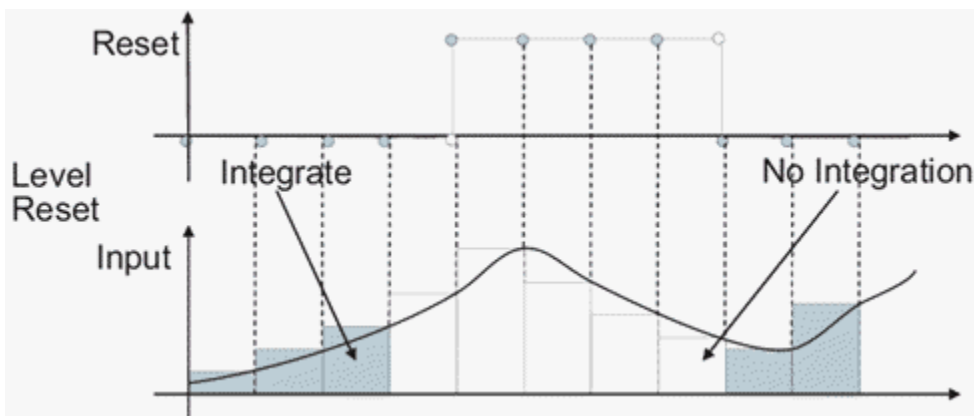

- sampled level — Resets the output to the initial condition when the reset signal is nonzero. For example, this figure shows the effect that a sampled level reset trigger has on backward Euler integration.

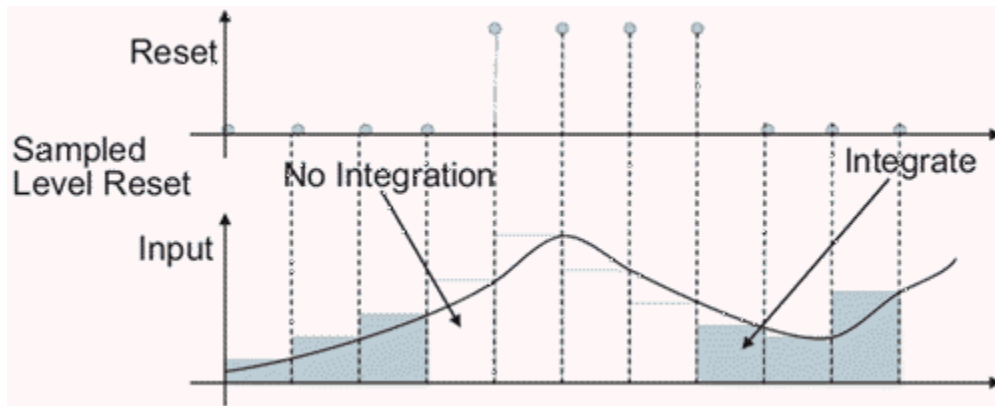

The sampled level reset option requires fewer computations, making it more efficient than the level reset option.

Note For the Discrete-Time Integrator block, all trigger detections are based on signals with positive values. For example, a signal changing from -1 to 0 is not considered a rising edge, but a signal changing from 0 to 1 is.

Behavior in Simplified Initialization Mode

Simplified initialization mode is enabled when you set **Underspecified initialization detection** to **Simplified** in the Configuration Parameters dialog box. If you use simplified initialization mode, the behavior of the Discrete-Time Integrator block differs from classic initialization mode. The new initialization behavior is more robust and provides more consistent behavior in these cases:

- In algebraic loops
- On enable and disable
- When comparing results using triggered sample time against explicit sample time, where the block is triggered at the same rate as the explicit sample time

Simplified initialization mode enables easier conversion from Continuous-Time Integrator blocks to Discrete-Time Integrator blocks, because the initial conditions have the same meaning for both blocks.

For more information on classic and simplified initialization modes, see “Underspecified initialization detection”.

Enable and Disable Behavior with Initial Condition Setting set to Output

When you use simplified initialization mode with **Initial condition setting** set to **Output** for triggered and function-call subsystems, the enable and disable behavior of the block is simplified as follows.

At disable time t_d :

$$y(t_d) = y(t_d - 1)$$

At enable time t_e :

- If the parent subsystem control port has **States when enabling** set to **reset**:

$$y(t_e) = IC.$$

- If the parent subsystem control port has **States when enabling** set to held:

$$y(t_e) = y(t_d).$$

The following figure shows this condition.

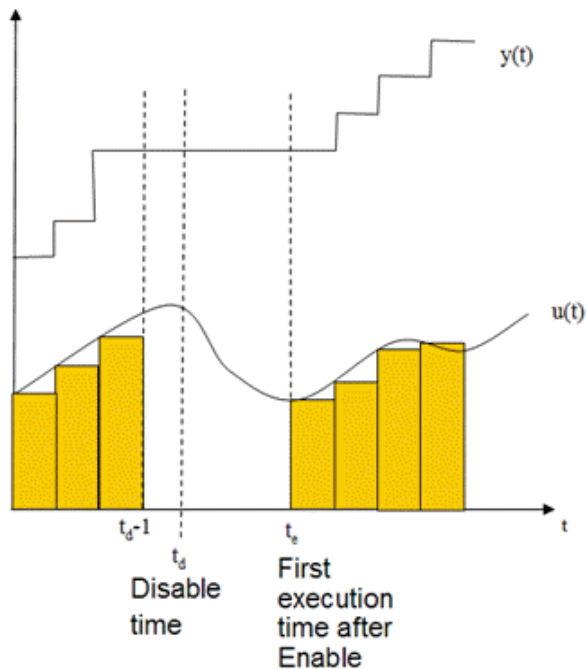

Iterator Subsystems

When using simplified initialization mode, you cannot place the Discrete-Time Integrator block in an iterator subsystem block.

In simplified initialization mode, Iterator subsystems do not maintain elapsed time. Thus, if a Discrete-Time Integrator block, which needs elapsed time, is placed inside an iterator subsystem block, Simulink reports an error.

Behavior in an Enabled Subsystem Inside a Function-Call Subsystem

Suppose you have a function-call subsystem that includes an enabled subsystem, which contains a Discrete-Time Integrator block. The following behavior applies.

| Integrator Method | Sample Time Type of Function-Call Trigger Port | Value of delta T When Function-Call Subsystem Executes for the First Time After Enabled | Reason for Behavior |
|--|--|---|---|
| Forward Euler | Triggered | $t - t_{start}$ | When the function-call subsystem executes for the first time, the integrator algorithm uses t_{start} as the previous simulation time. |
| Backward Euler and Trapezoidal | Triggered | $t - t_{previous}$ | When the function-call subsystem executes for the first time, the integrator algorithm uses $t_{previous}$ as the previous simulation time. |
| Forward Euler, Backward Euler, and Trapezoidal | Periodic | Sample time of the function-call generator | In periodic mode, the Discrete-Time Integrator block uses sample time of the function-call generator for ΔT . |

Ports

Input

Port_1 – Input signal

scalar | vector | matrix

Input signal, specified as a scalar, vector, or matrix

Data Types: single | double | int8 | int16 | int32 | int64 | uint8 | uint16 | uint32 | uint64 | fixed point

IC – Initial conditions of the states

scalar | vector | matrix

Initial conditions of the states, specified as a finite scalar, vector, or matrix.

Dependencies

To enable this port, set **Initial condition source** to external.

Data Types: single | double | int8 | int16 | int32 | int64 | uint8 | uint16 | uint32 | uint64 | fixed point

Output

Port_1 – Discrete-time integration or accumulation of input

scalar | vector | matrix

Discrete-time integration or accumulation of the input signal, specified as a scalar, vector, or matrix.

Data Types: `single` | `double` | `int8` | `int16` | `int32` | `int64` | `uint8` | `uint16` | `uint32` | `uint64` | `fixed point`

Port_2 – Saturation output

`scalar` | `vector` | `matrix`

Signal indicating when the state is being limited, specified as a scalar, vector, or matrix. The signal has one of three values:

- 1 indicates that the upper limit is being applied.
- 0 indicates that the integral is not limited.
- -1 indicates that the lower limit is being applied.

Dependencies

To enable this port, select the **Show saturation port** check box.

Data Types: `single` | `double` | `int8`

Port_3 – State output

`scalar` | `vector` | `matrix`

Block states, output as a scalar, vector, or matrix. By default, the block adds this port to the top of the block icon. Use the state port when:

- The output of the block is fed back into the block through the reset port or the initial condition port, causing an algebraic loop. For an example, see the `sldemo_bounce_two_integrators` model.
- You want to pass the state from one conditionally executed subsystem to another, which can cause timing problems. For an example, see the `sldemo_clutch` model.

For more information, see “When to Use the State Port” on page 1-464.

Dependencies

To enable this port, select the **Show state port** check box.

Data Types: `single` | `double` | `int8` | `int16` | `int32` | `int64` | `uint8` | `uint16` | `uint32` | `uint64` | `fixed point`

Parameters

Main

Integrator method – Accumulation method

Integration: `Forward Euler (default)` | `Integration: Backward Euler` | `Integration: Trapezoidal` | `Accumulation: Forward Euler` | `Accumulation: Backward Euler` | `Accumulation: Trapezoidal`

Specify the integration or accumulation method. See “Output Equations” on page 1-461 and “Integration and Accumulation Methods” on page 1-461 for more information.

Programmatic Use

Block Parameter: `IntegratorMethod`

Type: character vector

Values: 'Integration: Forward Euler' | 'Integration: Backward Euler' | 'Integration: Trapezoidal' | 'Accumulation: Forward Euler' | 'Accumulation: Backward Euler' | 'Accumulation: Trapezoidal'
Default: 'Integration: Forward Euler'

Gain value — Value to multiply with integrator input

1.0 (default) | scalar | vector

Specify a scalar, vector, or matrix by which to multiply the integrator input. Each element of the gain must be a positive real number.

- Specifying a value other than 1.0 (the default) is semantically equivalent to connecting a Gain block to the input of the integrator.
- Valid entries include:
 - `double(1.0)`
 - `single(1.0)`
 - `[1.1 2.2 3.3 4.4]`
 - `[1.1 2.2; 3.3 4.4]`

Tip Using this parameter to specify the input gain eliminates a multiplication operation in the generated code. However, this parameter must be nontunable to realize this benefit. If you want to tune the input gain, set this parameter to 1.0 and use an external Gain block to specify the input gain.

Programmatic Use

Block Parameter: `gainval`

Type: character vector

Values: scalar | vector

Default: '1.0'

External reset — Select when to reset states to initial conditions

`none` (default) | `rising` | `falling` | `either` | `level` | `sampled level`

Select the type of trigger event that resets the states to their initial conditions:

- `none` — Do not reset the state to initial conditions.
- `rising` — Reset the state when the reset signal has a rising edge.
- `falling` — Reset the state when the reset signal has a falling edge.
- `either` — Reset the state when the reset signal rises or falls.
- `level` — Reset and hold the output to the initial condition while the reset signal is nonzero.
- `sampled level` — Reset the output to the initial condition when the reset signal is nonzero.

For more information, see “Reset the State” on page 1-465 and “Reset Trigger Types” on page 1-465.

Programmatic Use

Block Parameter: `ExternalReset`

Type: character vector

Values: 'none' | 'rising' | 'falling' | 'either' | 'level' | 'sampled level'

Default: 'none'

Initial condition source — Select source of initial condition`internal (default) | external`

Select source of initial condition:

- `internal` — Get the initial conditions of the states from the **Initial condition** block parameter.
- `external` — Get the initial conditions of the states from an external block, via the **IC** input port.

Dependencies

Selecting `internal` enables the **Initial condition** parameter.

Selecting `external` disables the **Initial condition** parameter and enables the **IC** input port.

Programmatic Use**Block Parameter:** `InitialConditionSource`**Type:** character vector, string**Values:** `'internal' | 'external'`**Default:** `'internal'`**Initial condition — Initial condition of states**`0 (default) | scalar | vector | matrix`

Specify initial condition of the block states. The minimum and maximum values are bound by the **Output minimum** and **Output maximum** block parameters.

Tip Simulink software does not allow the initial condition of this block to be `inf` or `NaN`.

Dependencies

To enable this parameter, set the **Initial condition source** to `internal`.

Programmatic Use**Block Parameter:** `InitialCondition`**Type:** character vector, string**Values:** `scalar | vector | matrix`**Default:** `'0'`**Initial condition setting — Select where to apply the initial condition**`Auto (default) | Output | Compatibility`

Select whether to apply the value of the **Initial condition** parameter to the block state or block output. The initial condition is also the reset value.

- `Auto` — Block chooses where to apply the **Initial condition** parameter.
 - If the block is in a non-triggered subsystem and **Integrator method** is set to an integration method, set initial conditions:

$$x(0) = IC$$

At reset:

$$x(n) = IC$$

- If the block is in a triggered or function-call subsystem and **Integrator method** is set to an integration method, set initial conditions as if **output** was selected.
- **Output** — Use this option when the block is in a triggered or a function-call subsystem and **Integrator method** is set to an integration method.

Set initial conditions:

$$y(0) = IC$$

At reset:

$$y(n) = IC$$

- **Compatibility** — This option is present to provide backward compatibility. You cannot select this option for Discrete-Time Integrator blocks in Simulink models but you can select it for Discrete-Time Integrator blocks in a library. Use this option to maintain compatibility with Simulink models created before R2014a.

Prior to R2014a, the option **Auto** was known as **State only (most efficient)**. The option **Output** was known as **State and output**. The behavior of the block with the option **Compatibility** is as follows.

- If **Underspecified initialization detection** is set to **Classic**, the **Initial condition setting** parameter behaves as **Auto**.
- If **Underspecified initialization detection** is set to **Simplified**, the **Initial condition setting** parameter behaves as **Output**.

Note This parameter was named **Use initial condition as initial and reset value for** in Simulink before R2014a.

Programmatic Use

Block Parameter: InitialConditionSetting

Type: character vector

Value: 'Auto' | 'Output' | 'Compatibility'

Default: 'Auto'

Sample time (-1 for inherited) — Interval between samples

-1 (default) | scalar | vector

Enter the discrete time interval between steps.

By default, the block uses a discrete sample time of 1. To set a different sample time, enter another discrete value, such as 0.1.

See “Specify Sample Time” for more information.

Tips

- Do not specify a sample time of 0. This value specifies a continuous sample time, which the Discrete-Time Integrator block does not support.
- Do not specify a sample time of `inf` or `NaN` because these values are not discrete.

- If you specify -1 to inherit the sample time from an upstream block, verify that the upstream block uses a discrete sample time. For example, the Discrete-Time Integrator block cannot inherit a sample time of 0.

Programmatic Use**Block Parameter:** SampleTime**Type:** character vector**Values:** scalar | vector**Default:** '-1'**Limit output — Limit block output values to specified range**

off (default) | on

Limit the block's output to a value between the **Lower saturation limit** and **Upper saturation limit** parameters.

- Selecting this check box limits the block's output to a value between the **Lower saturation limit** and **Upper saturation limit** parameters.
- Clearing this check box does not limit the block's output values.

Dependencies

Selecting this parameter enables the **Lower saturation limit** and **Upper saturation limit** parameters.

Programmatic Use**Block Parameter:** LimitOutput**Type:** character vector**Values:** 'off' | 'on'**Default:** 'off'**Upper saturation limit — Upper limit for the integral**

inf (default) | scalar | vector | matrix

Specify the upper limit for the integral as a scalar, vector, or matrix. You must specify a value between the **Output minimum** and **Output maximum** parameter values.

Dependencies

To enable this parameter, select the **Limit output** check box.

Programmatic Use**Block Parameter:** UpperSaturationLimit**Type:** character vector, string**Values:** scalar | vector | matrix**Default:** 'inf'**Lower saturation limit — Lower limit for the integral**

-inf (default) | scalar | vector | matrix

Specify the lower limit for the integral as a scalar, vector, or matrix. You must specify a value between the **Output minimum** and **Output maximum** parameter values.

Dependencies

To enable this parameter, select the **Limit output** check box.

Programmatic Use**Block Parameter:** LowerSaturationLimit**Type:** character vector , string**Values:** scalar | vector | matrix**Default:** '-inf'**Show saturation port — Enable saturation output port**

off (default) | on

Select this check box to add a saturation output port to the block. When you clear this check box, the block does not have a saturation output port.

Dependencies

Selecting this parameter enables a saturation output port.

Programmatic Use**Block Parameter:** ShowSaturationPort**Type:** character vector , string**Values:** 'off' | 'on'**Default:** 'off'**Show state port — Enable state output port**

off (default) | on

Select this check box to add a state output port to the block. When you clear this check box, the block does not have a state output port.

Dependencies

Selecting this parameter enables a state output port.

Programmatic Use**Block Parameter:** ShowStatePort**Type:** character vector , string**Values:** 'off' | 'on'**Default:** 'off'**Ignore limit and reset when linearizing — Treat block as not resettable**

off (default) | on

Select this check box to have Simulink linearization commands treat this block as not resettable and as having no limits on its output, regardless of the settings of the block reset and output limitation options.

Tip Ignoring the limit and resetting allows you to linearize a model around an operating point. This point may cause the integrator to reset or saturate.

Programmatic Use**Block Parameter:** IgnoreLimit**Type:** character vector**Values:** 'off' | 'on'**Default:** 'off'

Signal Attributes

Output minimum — Minimum output value for range checking

[] (default) | scalar

Lower value of the output range that Simulink checks.

Simulink uses the minimum to perform:

- Parameter range checking (see “Specify Minimum and Maximum Values for Block Parameters”) for some blocks.
- Simulation range checking (see “Specify Signal Ranges” and “Enable Simulation Range Checking”).
- Automatic scaling of fixed-point data types.
- Optimization of the code that you generate from the model. This optimization can remove algorithmic code and affect the results of some simulation modes such as SIL or external mode. For more information, see “Optimize using the specified minimum and maximum values” (Embedded Coder).

Note Output minimum does not saturate or clip the actual output signal. Use the Saturation block instead.

Programmatic Use

Block Parameter: OutMin

Type: character vector

Values: ' [] ' | scalar

Default: ' [] '

Output maximum — Maximum output value for range checking

[] (default) | scalar

Upper value of the output range that Simulink checks.

Simulink uses the maximum value to perform:

- Parameter range checking (see “Specify Minimum and Maximum Values for Block Parameters”) for some blocks.
- Simulation range checking (see “Specify Signal Ranges” and “Enable Simulation Range Checking”).
- Automatic scaling of fixed-point data types.
- Optimization of the code that you generate from the model. This optimization can remove algorithmic code and affect the results of some simulation modes such as SIL or external mode. For more information, see “Optimize using the specified minimum and maximum values” (Embedded Coder).

Note Output maximum does not saturate or clip the actual output signal. Use the Saturation block instead.

Programmatic Use**Block Parameter:** OutMax**Type:** character vector**Values:** '[]' | scalar**Default:** '[]'**Data type — Output data type**

Inherit: Inherit via internal rule (default) | Inherit: Inherit via back propagation | double | single | int8 | uint8 | int16 | uint16 | int32 | uint32 | int64 | uint64 | fixdt(1,16) | fixdt(1,16,0) | fixdt(1,16,2^0,0) | <data type expression>

Choose the data type for the output. The type can be inherited, specified directly, or expressed as a data type object such as Simulink.NumericType. For more information, see “Control Data Types of Signals”.

When you select an inherited option, the block behaves as follows:

- **Inherit: Inherit via internal rule** — Simulink chooses a data type to balance numerical accuracy, performance, and generated code size, while taking into account the properties of the embedded target hardware. If you change the embedded target settings, the data type selected by the internal rule might change. For example, if the block multiplies an input of type `int8` by a gain of `int16` and ASIC/FPGA is specified as the targeted hardware type, the output data type is `sfix24`. If `Unspecified (assume 32-bit Generic)`, i.e., a generic 32-bit microprocessor, is specified as the target hardware, the output data type is `int32`. If none of the word lengths provided by the target microprocessor can accommodate the output range, Simulink software displays an error in the Diagnostic Viewer.

It is not always possible for the software to optimize code efficiency and numerical accuracy at the same time. If the internal rule doesn't meet your specific needs for numerical accuracy or performance, use one of the following options:

- Specify the output data type explicitly.
- Use the simple choice of **Inherit: Same as input**.
- Explicitly specify a default data type such as `fixdt(1,32,16)` and then use the Fixed-Point Tool to propose data types for your model. For more information, see `fxptdlg`.
- To specify your own inheritance rule, use **Inherit: Inherit via back propagation** and then use a Data Type Propagation block. Examples of how to use this block are available in the Signal Attributes library Data Type Propagation Examples block.
- **Inherit: Inherit via back propagation** — Use data type of the driving block.

Programmatic Use**Block Parameter:** OutDataTypeStr**Type:** character vector

Values: 'Inherit: Inherit via internal rule' | 'Inherit: Inherit via back propagation' | 'double' | 'single' | 'int8' | 'uint8' | 'int16' | 'uint16' | 'int32' | 'uint32' | 'int64' | 'uint64' | 'fixdt(1,16)' | 'fixdt(1,16,0)' | 'fixdt(1,16,2^0,0)' | '<data type expression>'

Default: 'Inherit: Inherit via internal rule'**Lock output data type setting against changes by the fixed-point tools — Prevent fixed-point tools from overriding Output data type**

off (default) | on

Select this parameter to prevent the fixed-point tools from overriding the **Output** data type you specify on the block. For more information, see “Use Lock Output Data Type Setting” (Fixed-Point Designer).

Programmatic Use**Block Parameter:** LockScale**Type:** character vector**Values:** 'off' | 'on'**Default:** 'off'**Integer rounding mode — Specify the rounding mode for fixed-point operations**

Floor (default) | Ceiling | Convergent | Nearest | Round | Simplest | Zero

Choose one of these rounding modes.

Ceiling

Rounds both positive and negative numbers toward positive infinity. Equivalent to the MATLAB `ceil` function.

Convergent

Rounds number to the nearest representable value. If a tie occurs, rounds to the nearest even integer. Equivalent to the Fixed-Point Designer `convergent` function.

Floor

Rounds both positive and negative numbers toward negative infinity. Equivalent to the MATLAB `floor` function.

Nearest

Rounds number to the nearest representable value. If a tie occurs, rounds toward positive infinity. Equivalent to the Fixed-Point Designer `nearest` function.

Round

Rounds number to the nearest representable value. If a tie occurs, rounds positive numbers toward positive infinity and rounds negative numbers toward negative infinity. Equivalent to the Fixed-Point Designer `round` function.

Simplest

Automatically chooses between round toward floor and round toward zero to generate rounding code that is as efficient as possible.

Zero

Rounds number toward zero. Equivalent to the MATLAB `fix` function.

Programmatic Use**Block Parameter:** RndMeth**Type:** character vector**Values:** 'Ceiling' | 'Convergent' | 'Floor' | 'Nearest' | 'Round' | 'Simplest' | 'Zero'**Default:** 'Floor'**See Also**

For more information, see “Rounding” (Fixed-Point Designer).

Saturate on integer overflow — Method of overflow action

off (default) | on

Specify whether overflows saturate or wrap.

- **off** — Overflows wrap to the appropriate value that the data type can represent.

For example, the number 130 does not fit in a signed 8-bit integer and wraps to -126.

- **on** — Overflows saturate to either the minimum or maximum value that the data type can represent.

For example, an overflow associated with a signed 8-bit integer can saturate to -128 or 127.

Tip

- Consider selecting this check box when your model has a possible overflow and you want explicit saturation protection in the generated code.
- Consider clearing this check box when you want to optimize efficiency of your generated code.

Clearing this check box also helps you to avoid overspecifying how a block handles out-of-range signals. For more information, see “Troubleshoot Signal Range Errors”.

- When you select this check box, saturation applies to every internal operation on the block, not just the output or result.
 - In general, the code generation process can detect when overflow is not possible. In this case, the code generator does not produce saturation code.
-

Programmatic Use

Block Parameter: SaturateOnIntegerOverflow

Type: character vector

Values: 'off' | 'on'

Default: 'off'

State Attributes

State name — Unique name for block state

' ' (default) | alphanumeric string

Use this parameter to assign a unique name to the block state. The default is ' '. When this field is blank, no name is assigned. When using this parameter, remember these considerations:

- A valid identifier starts with an alphabetic or underscore character, followed by alphanumeric or underscore characters.
- The state name applies only to the selected block.

For more information, see “C Code Generation Configuration for Model Interface Elements” (Simulink Coder).

Dependencies

When you specify a value for **State name** and click **Apply**, you enable the **State name must resolve to Simulink signal object** parameter.

Programmatic Use

Parameter: StateName

Type: character vector

Values: unique name

Default: ''

State name must resolve to Simulink signal object — Require state names resolve to signal object

Off (default) | Boolean

Specify if requiring that state name resolve to Simulink signal objects or not. If selected, the software generates an error at run time if you specify a state name that does not match the name of a Simulink signal object.

Dependency

Enabled when you give the parameter **State name** a value and set the model configuration parameter **Signal resolution** to a value other than None.

Selecting this check box disables **Code generation storage class**.

Programmatic Use

Block Parameter: StateMustResolveToSignalObject

Type: character vector

Values: 'off' | 'on'

Default: 'off'

Block Characteristics

| | |
|---------------------------------|---|
| Data Types | double fixed point integer single |
| Direct Feedthrough | yes |
| Multidimensional Signals | no |
| Variable-Size Signals | no |
| Zero-Crossing Detection | no |

Extended Capabilities

C/C++ Code Generation

Generate C and C++ code using Simulink® Coder™.

Depends on absolute time when used inside a triggered subsystem hierarchy.

HDL Code Generation

Generate Verilog and VHDL code for FPGA and ASIC designs using HDL Coder™.

HDL Coder provides additional configuration options that affect HDL implementation and synthesized logic.

HDL Architecture

This block has a single, default HDL architecture.

HDL Block Properties

| General | |
|----------------------------------|--|
| ConstrainedOutputPipeline | Number of registers to place at the outputs by moving existing delays within your design. Distributed pipelining does not redistribute these registers. The default is 0. For more details, see “ConstrainedOutputPipeline” (HDL Coder). |
| InputPipeline | Number of input pipeline stages to insert in the generated code. Distributed pipelining and constrained output pipelining can move these registers. The default is 0. For more details, see “InputPipeline” (HDL Coder). |
| OutputPipeline | Number of output pipeline stages to insert in the generated code. Distributed pipelining and constrained output pipelining can move these registers. The default is 0. For more details, see “OutputPipeline” (HDL Coder). |
| Native Floating Point | |
| HandleDenormals | Specify whether you want HDL Coder to insert additional logic to handle denormal numbers in your design. Denormal numbers are numbers that have magnitudes less than the smallest floating-point number that can be represented without leading zeros in the mantissa. The default is <code>inherit</code> . See also “HandleDenormals” (HDL Coder). |
| LatencyStrategy | Specify whether to map the blocks in your design to <code>inherit</code> , <code>Max</code> , <code>Min</code> , or <code>Zero</code> for the floating-point operator. The default is <code>inherit</code> . See also “LatencyStrategy” (HDL Coder). |
| MantissaMultiplyStrategy | Specify how to implement the mantissa multiplication operation during code generation. By using different settings, you can control the DSP usage on the target FPGA device. The default is <code>inherit</code> . See also “MantissaMultiplyStrategy” (HDL Coder). |

Restrictions

- State ports are not supported for HDL code generation. Clear the **Show state port** option.
- External initial conditions are not supported for HDL code generation. Set **Initial condition source** to `Internal`.
- **External Reset** must be set to `none`, `rising`, or `falling`.
- Continuous sample time is not supported. Use a discrete sample time for the block.

PLC Code Generation

Generate Structured Text code using Simulink® PLC Coder™.

Fixed-Point Conversion

Design and simulate fixed-point systems using Fixed-Point Designer™.

See Also

Integrator

Topics

“C Code Generation Configuration for Model Interface Elements” (Simulink Coder)

"C Code Generation Configuration for Model Interface Elements" (Simulink Coder)
"Organize Parameter Data into a Structure by Using Struct Storage Class" (Embedded Coder)

Introduced before R2006a

Discrete Transfer Fcn

Implement discrete transfer function

Library: Simulink / Discrete
HDL Coder / Discrete
HDL Coder / HDL Floating Point Operations

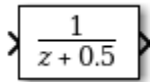

Description

The Discrete Transfer Fcn block implements the z -transform transfer function as follows:

$$H(z) = \frac{num(z)}{den(z)} = \frac{num_0 z^m + num_1 z^{m-1} + \dots + num_m}{den_0 z^n + den_1 z^{n-1} + \dots + den_n}$$

where $m+1$ and $n+1$ are the number of numerator and denominator coefficients, respectively. num and den contain the coefficients of the numerator and denominator in descending powers of z . num can be a vector or matrix, while den must be a vector. The order of the denominator must be greater than or equal to the order of the numerator.

Specify the coefficients of the numerator and denominator polynomials in descending powers of z . This block lets you use polynomials in z to represent a discrete system, a method that control engineers typically use. Conversely, the Discrete Filter block lets you use polynomials in z^{-1} (the delay operator) to represent a discrete system, a method that signal processing engineers typically use. The two methods are identical when the numerator and denominator polynomials have the same length.

The Discrete Transfer Fcn block applies the z -transform transfer function to each independent channel of the input. The **Input processing** parameter allows you to specify whether the block treats each column of the input as an individual channel (frame-based processing) or each element of the input as an individual channel (sample-based processing). To perform frame-based processing, you must have a DSP System Toolbox license.

Specifying Initial States

Use the **Initial states** parameter to specify initial filter states. To determine the number of initial states you must specify and how to specify them, use the following tables.

Frame-Based Processing

| Input | Number of Channels | Valid Initial States (Dialog Box) | Valid Initial States (Input Port) |
|---|--------------------|--|---|
| <ul style="list-style-type: none"> Column vector (K-by-1) Unoriented vector (K) | 1 | <ul style="list-style-type: none"> Scalar Column vector (M-by-1) Row vector (1-by-M) | <ul style="list-style-type: none"> Scalar Column vector (M-by-1) |
| <ul style="list-style-type: none"> Row vector (1-by-N) Matrix (K-by-N) | N | <ul style="list-style-type: none"> Scalar Column vector (M-by-1) Row vector (1-by-M) Matrix (M-by-N) | <ul style="list-style-type: none"> Scalar Matrix (M-by-N) |

Sample-Based Processing

| Input | Number of Channels | Valid Initial States (Dialog Box) | Valid Initial States (Input Port) |
|---|--------------------|---|---|
| <ul style="list-style-type: none"> Scalar | 1 | <ul style="list-style-type: none"> Scalar Column vector (M-by-1) Row vector (1-by-M) | <ul style="list-style-type: none"> Scalar Column vector (M-by-1) Row vector (1-by-M) |
| <ul style="list-style-type: none"> Row vector (1-by-N) Column vector (N-by-1) Unoriented vector (N) | N | <ul style="list-style-type: none"> Scalar Column vector (M-by-1) Row vector (1-by-M) Matrix (M-by-N) | <ul style="list-style-type: none"> Scalar |
| <ul style="list-style-type: none"> Matrix (K-by-N) | $K \times N$ | <ul style="list-style-type: none"> Scalar Column vector (M-by-1) Row vector (1-by-M) Matrix (M-by-$(K \times N)$) | <ul style="list-style-type: none"> Scalar |

When the **Initial states** is a scalar, the block initializes all filter states to the same scalar value. To initialize all states to zero, enter \emptyset . When the **Initial states** is a vector or a matrix, each vector or matrix element specifies a unique initial state for a corresponding delay element in a corresponding channel:

- The vector length must equal the number of delay elements in the filter, $M = \max(\text{number of zeros, number of poles})$.
- The matrix must have the same number of rows as the number of delay elements in the filter, $M = \max(\text{number of zeros, number of poles})$. The matrix must also have one column for each channel of the input signal.

The following example shows the relationship between the initial filter output and the initial input and state. Given an initial input u_1 , the first output y_1 is related to the initial state $[x_1, x_2]$ and initial input by as follows:

$$y1 = 4x1$$

$$x2 = 1/2(u1 - 3x1)$$

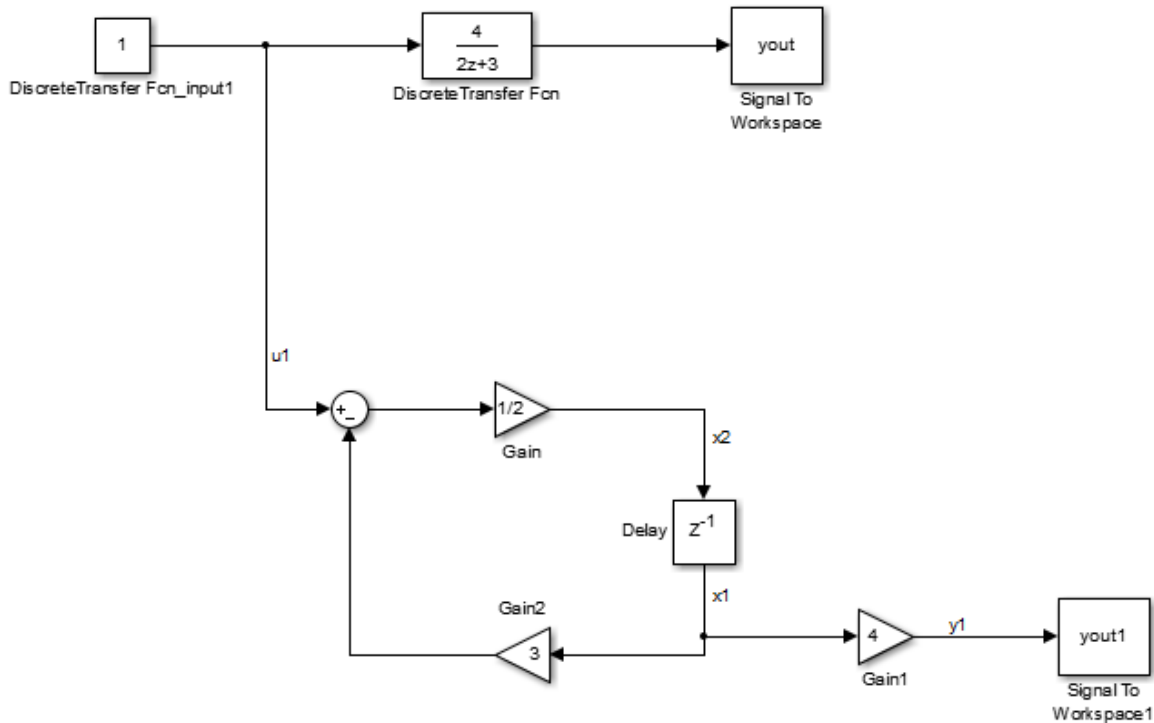

Ports

Input

u – Input signal

scalar | vector | matrix

Input signal, specified as a scalar, vector, or matrix.

Data Types: single | double | int8 | int16 | int32 | fixed point

Num – Numerator coefficients

scalar | vector | matrix

Coefficients of the numerator polynomial specified as a vector or matrix in descending powers of z . Use a row vector to specify the coefficients for a single numerator polynomial. Use a matrix to specify

coefficients for multiple filters to be applied to the same input. Each matrix row represents a set of filter taps. The order of the denominator must be greater than or equal to the order of the numerator.

Dependencies

To enable this port, set **Numerator Source** to Input port.

Numerator and denominator coefficients must have the same complexity. They can have different word lengths and fraction lengths.

Data Types: `single` | `double` | `int8` | `int16` | `int32` | `fixed point`

Den — Denominator coefficients

`scalar` | `vector` | `matrix`

Coefficients of the denominator polynomial specified as a vector in descending powers of z . Use a row vector to specify the coefficients for a single denominator polynomial. Use a matrix to specify coefficients for multiple filters to be applied to the same input. Each matrix row represents a set of filter taps. The order of the denominator must be greater than or equal to the order of the numerator.

Dependencies

To enable this port, set **Denominator Source** to Input port.

Numerator and denominator coefficients must have the same complexity. They can have different word lengths and fraction lengths.

Data Types: `single` | `double` | `int8` | `int16` | `int32` | `fixed point`

External reset — External reset signal

`scalar`

External reset signal, specified as a scalar. When the specified trigger event occurs, the block resets the states to their initial conditions.

Tip The icon for this port changes based on the value of the **External reset** parameter.

Dependencies

To enable this port, set **External reset** to Rising, Falling, Either, Level, or Level hold.

Limitations

The reset signal must be a scalar of type `single`, `double`, `Boolean`, or `integer`. Fixed-point data types, except for `ufix1`, are not supported.

Data Types: `single` | `double` | `Boolean` | `int8` | `int16` | `int32` | `fixed point`

x0 — Initial states

`scalar` | `vector` | `matrix`

Initial states, specified as a scalar, vector, or matrix. For more information about specifying states, see “Specifying Initial States” on page 1-483. States are complex when either the input or the coefficients are complex.

Dependencies

To enable this port, set **Initial states Source** to Input port.

Data Types: single | double | int8 | int16 | int32 | fixed point

Output**Port_1 — Output signal**

scalar | vector | matrix

Output signal specified as a scalar, vector, or matrix.

Data Types: single | double | int8 | int16 | int32 | fixed point

Parameters**Main****Numerator Source — Source of numerator coefficients**

Dialog (default) | Input port

Specify the source of the numerator coefficients as Dialog or Input port.

Programmatic Use

Block Parameter: NumeratorSource

Type: character vector

Values: 'Dialog' | 'Input port'

Default: 'Dialog'

Numerator Value — Numerator coefficients

[1] (default) | scalar | vector | matrix

Numerator coefficients of the discrete transfer function. To specify the coefficients, set the **Source** to Dialog. Then, enter the coefficients in **Value** as descending powers of z . Use a row vector to specify the coefficients for a single numerator polynomial. Use a matrix to specify coefficients for multiple filters to be applied to the same input. Each matrix row represents a set of filter taps.

Dependencies

To enable this parameter, set the **Numerator Source** to Dialog.

Programmatic Use

Block Parameter: Numerator

Type: character vector

Values: scalar | vector | matrix

Default: '[1]'

Denominator Source — Source of denominator coefficients

Dialog (default) | Input port

Specify the source of the denominator coefficients as Dialog or Input port.

Programmatic Use

Block Parameter: DenominatorSource

Type: character vector

Values: 'Dialog' | 'Input port'
Default: 'Dialog'

Denominator Value — Denominator coefficients

[1 0.5] (default) | scalar | vector | matrix

Denominator coefficients of the discrete transfer function. To specify the coefficients, set the **Source** to **Dialog**. Then, enter the coefficients in **Value** as descending powers of z . Use a row vector to specify the coefficients for a single denominator polynomial. Use a matrix to specify coefficients for multiple filters to be applied to the same input. Each matrix row represents a set of filter taps.

Dependencies

To enable this parameter, set the **Denominator Source** to **Dialog**.

Programmatic Use

Block Parameter: Denominator

Type: character vector

Values: scalar | vector | matrix

Default: '[1 0.5]'

Initial states Source — Source of initial states

Dialog (default) | Input port

Specify the source of the initial states as **Dialog** or **Input port**.

Programmatic Use

Block Parameter: InitialStatesSource

Type: character vector

Values: 'Dialog' | 'Input port'

Default: 'Dialog'

Initial states Value — Initial filter states

0 (default) | scalar | vector | matrix

Specify the initial filter states as a scalar, vector, or matrix. To learn how to specify initial states, see “Specifying Initial States” on page 1-483.

Dependencies

To enable this parameter, set **Initial states Source** to **Dialog**.

Programmatic Use

Block Parameter: InitialStates

Type: character vector

Values: scalar | vector | matrix

Default: '0'

External reset — External state reset

None (default) | Rising | Falling | Either | Level | Level hold

Specify the trigger event to use to reset the states to the initial conditions.

| Reset Mode | Behavior |
|------------|----------|
| None | No reset |

| Reset Mode | Behavior |
|------------|--|
| Rising | Reset on a rising edge |
| Falling | Reset on a falling edge |
| Either | Reset on either a rising or falling edge |
| Level | Reset in either of these cases: <ul style="list-style-type: none"> • When the reset signal is nonzero at the current time step • When the reset signal value changes from nonzero at the previous time step to zero at the current time step |
| Level hold | Reset when the reset signal is nonzero at the current time step |

Programmatic Use**Block Parameter:** ExternalReset**Type:** character vector**Values:** 'None' | 'Rising' | 'Falling' | 'Either' | 'Level' | 'Level hold'**Default:** 'None'**Input processing — Sample- or frame-based processing**

Elements as channels (sample based) (default) | Columns as channels (frame based)

Specify whether the block performs sample- or frame-based processing.

- Elements as channels (sample based) — Process each element of the input as an independent channel.
- Columns as channels (frame based) — Process each column of the input as an independent channel.

Note Frame-based processing requires a DSP System Toolbox license.

For more information, see “Sample- and Frame-Based Concepts” (DSP System Toolbox).

Programmatic Use**Block Parameter:** InputProcessing**Type:** character vector**Values:** 'Elements as channels (sample based)' | 'Columns as channels (frame based)'**Default:** 'Elements as channels (sample based)'**Optimize by skipping divide by leading denominator coefficient (a0) — Skip divide by a0**

off (default) | on

Select when the leading denominator coefficient, a_0 , equals 1. This parameter optimizes your code.When you select this check box, the block does not perform a divide-by- a_0 either in simulation or in the generated code. An error occurs if a_0 is not equal to one.

When you clear this check box, the block is fully tunable during simulation, and performs a divide-by- a_0 in both simulation and code generation.

Programmatic Use

Block Parameter: `a0EqualsOne`

Type: character vector

Values: 'off' | 'on'

Default: 'off'

Sample time (-1 for inherited) – Interval between samples

-1 (default) | scalar | vector

Specify the time interval between samples. To inherit the sample time, set this parameter to -1. For more information, see “Specify Sample Time”.

Programmatic Use

Block Parameter: `SampleTime`

Type: character vector

Values: scalar | vector

Default: '-1'

Data Types

State – State data type

Inherit: Same as input (default) | int8 | int16 | int32 | int64 | fixdt(1,16,0) | <data type expression>

Specify the state data type. You can set it to:

- A rule that inherits a data type, for example, `Inherit: Same as input`
- A built-in integer, for example, `int8`
- A data type object, for example, a `Simulink.NumericType` object
- An expression that evaluates to a data type, for example, `fixdt(1,16,0)`

Click the **Show data type assistant** button  to display the **Data Type Assistant**, which helps you set the data type attributes. For more information, see “Specify Data Types Using Data Type Assistant”.

Numerator coefficients – Numerator coefficient data type

Inherit: Inherit via internal rule (default) | int8 | int16 | int32 | int64 | fixdt(1,16) | fixdt(1,16,0) | <data type expression>

Specify the numerator coefficient data type. You can set it to:

- A rule that inherits a data type, for example, `Inherit: Inherit via internal rule`
- A built-in integer, for example, `int8`
- A data type object, for example, a `Simulink.NumericType` object
- An expression that evaluates to a data type, for example, `fixdt(1,16,0)`

Click the **Show data type assistant** button  to display the **Data Type Assistant**, which helps you set the data type attributes. For more information, see “Specify Data Types Using Data Type Assistant”.

Programmatic Use**Block Parameter:** NumCoeffDataTypeStr**Type:** character vector**Values:** 'Inherit: Inherit via internal rule' | 'int8' | 'int16' | 'int32' | 'int64' | 'fixdt(1,16)' | 'fixdt(1,16,0)' | '<data type expression>'**Default:** 'Inherit: Inherit via internal rule'**Numerator coefficient minimum — Minimum value of numerator coefficients**

[] (default) | scalar

Specify the minimum value that a numerator coefficient can have. The default value is [] (unspecified). Simulink software uses this value to perform:

- Parameter range checking (see “Specify Minimum and Maximum Values for Block Parameters”)
- Automatic scaling of fixed-point data types

Programmatic Use**Block Parameter:** NumCoeffMin**Type:** character vector**Values:** scalar**Default:** '[]'**Numerator coefficient maximum — Maximum value of numerator coefficients**

[] (default) | scalar

Specify the maximum value that a numerator coefficient can have. The default value is [] (unspecified). Simulink software uses this value to perform:

- Parameter range checking (see “Specify Minimum and Maximum Values for Block Parameters”)
- Automatic scaling of fixed-point data types

Programmatic Use**Block Parameter:** NumCoeffMax**Type:** character vector**Values:** scalar**Default:** '[]'**Numerator product output — Numerator product output data type**

Inherit: Inherit via internal rule (default) | Inherit: Same as input | int8 | int16 | int32 | int64 | fixdt(1,16,0) | <data type expression>

Specify the product output data type for the numerator coefficients. You can set it to:

- A rule that inherits a data type, for example, Inherit: Inherit via internal rule
- A built-in data type, for example, int8
- A data type object, for example, a Simulink.NumericType object
- An expression that evaluates to a data type, for example, fixdt(1,16,0)

Click the **Show data type assistant** button  to display the **Data Type Assistant**, which helps you set the data type attributes. For more information, see “Specify Data Types Using Data Type Assistant”.

Programmatic Use**Block Parameter:** NumProductDataTypeStr**Type:** character vector**Values:** 'Inherit: Inherit via internal rule' | 'Inherit: Same as input' | 'int8' | 'int16' | 'int32' | 'int64' | 'fixdt(1,16,0)' | '<data type expression>'**Default:** 'Inherit: Inherit via internal rule'**Numerator accumulator — Numerator accumulator data type**

Inherit: Inherit via internal rule (default) | Inherit: Same as input | Inherit: Same as product output | int8 | int16 | int32 | int64 | fixdt(1,16,0) | <data type expression>

Specify the accumulator data type for the numerator coefficients. You can set it to:

- A rule that inherits a data type, for example, Inherit: Inherit via internal rule
- A built-in data type, for example, int8
- A data type object, for example, a Simulink.NumericType object
- An expression that evaluates to a data type, for example, fixdt(1,16,0)

Click the **Show data type assistant** button  to display the **Data Type Assistant**, which helps you set the data type attributes. For more information, see “Specify Data Types Using Data Type Assistant”.

Programmatic Use**Block Parameter:** NumAccumDataTypeStr**Type:** character vector**Values:** 'Inherit: Inherit via internal rule' | 'Inherit: Same as input' | 'Inherit: Same as product output' | 'int8' | 'int16' | 'int32' | 'int64' | 'fixdt(1,16,0)' | '<data type expression>'**Default:** 'Inherit: Inherit via internal rule'**Denominator coefficients — Denominator coefficient data type**

Inherit: Inherit via internal rule (default) | int8 | int16 | int32 | int64 | fixdt(1,16) | fixdt(1,16,0) | <data type expression>

Specify the denominator coefficient data type. You can set it to:

- A rule that inherits a data type, for example, Inherit: Inherit via internal rule
- A built-in integer, for example, int8
- A data type object, for example, a Simulink.NumericType object
- An expression that evaluates to a data type, for example, fixdt(1,16,0)

Click the **Show data type assistant** button  to display the **Data Type Assistant**, which helps you set the data type attributes. For more information, see “Specify Data Types Using Data Type Assistant”.

Programmatic Use**Block Parameter:** DenCoeffDataTypeStr**Type:** character vector

Values: 'Inherit: Inherit via internal rule' | 'int8' | 'int16' | 'int32' | 'int64' | 'fixdt(1,16)' | 'fixdt(1,16,0)' | '<data type expression>
Default: 'Inherit: Same wordlength as input'

Denominator coefficient minimum — Minimum value of denominator coefficients

[] (default) | scalar

Specify the minimum value that a denominator coefficient can have. The default value is [] (unspecified). Simulink software uses this value to perform:

- Parameter range checking (see “Specify Minimum and Maximum Values for Block Parameters”)
- Automatic scaling of fixed-point data types

Programmatic Use

Block Parameter: DenCoeffMin

Type: character vector

Values: scalar

Default: '[]'

Denominator coefficient maximum — Maximum value of denominator coefficients

[] (default) | scalar

Specify the maximum value that a denominator coefficient can have. The default value is [] (unspecified). Simulink software uses this value to perform:

- Parameter range checking (see “Specify Minimum and Maximum Values for Block Parameters”)
- Automatic scaling of fixed-point data types

Programmatic Use

Block Parameter: DenCoeffMax

Type: character vector

Values: scalar

Default: '[]'

Denominator product output — Denominator product output data type

Inherit: Inherit via internal rule (default) | Inherit: Same as input | int8 | int16 | int32 | int64 | fixdt(1,16,0) | <data type expression>

Specify the product output data type for the denominator coefficients. You can set it to:

- A rule that inherits a data type, for example, Inherit: Inherit via internal rule
- A built-in data type, for example, int8
- A data type object, for example, a Simulink.NumericType object
- An expression that evaluates to a data type, for example, fixdt(1,16,0)

Click the **Show data type assistant** button  to display the **Data Type Assistant**, which helps you set the data type attributes. For more information, see “Specify Data Types Using Data Type Assistant”.

Programmatic Use

Block Parameter: DenProductDataTypeStr

Type: character vector

Values: 'Inherit: Inherit via internal rule' | 'Inherit: Same as input' | 'int8' | 'int16' | 'int32' | 'int64' | 'fixdt(1,16,0)' | '<data type expression>'

Default: 'Inherit: Inherit via internal rule'

Denominator accumulator — Denominator accumulator data type

Inherit: Inherit via internal rule (default) | Inherit: Same as input | Inherit: Same as product output | int8 | int16 | int32 | int64 | fixdt(1,16,0) | <data type expression>

Specify the accumulator data type for the denominator coefficients. You can set it to:

- A rule that inherits a data type, for example, Inherit: Inherit via internal rule
- A built-in data type, for example, int8
- A data type object, for example, a Simulink.NumericType object
- An expression that evaluates to a data type, for example, fixdt(1,16,0)

Click the **Show data type assistant** button  to display the **Data Type Assistant**, which helps you set the data type attributes. For more information, see “Specify Data Types Using Data Type Assistant”.

Programmatic Use

Block Parameter: DenAccumDataTypeStr

Type: character vector

Values: 'Inherit: Inherit via internal rule' | 'Inherit: Same as input' | 'Inherit: Same as product output' | 'int8' | 'int16' | 'int32' | 'int64' | 'fixdt(1,16,0)' | '<data type expression>'

Default: 'Inherit: Inherit via internal rule'

Output — Output data type

Inherit: Inherit via internal rule (default) | Inherit: Same as input | int8 | int16 | int32 | int64 | fixdt(1,16) | fixdt(1,16,0) | <data type expression>

Specify the output data type. You can set it to:

- A rule that inherits a data type, for example, Inherit: Inherit via internal rule
- A built-in data type, for example, int8
- A data type object, for example, a Simulink.NumericType object
- An expression that evaluates to a data type, for example, fixdt(1,16,0)

Click the **Show data type assistant** button  to display the **Data Type Assistant**, which helps you set the data type attributes. For more information, see “Specify Data Types Using Data Type Assistant”.

Programmatic Use

Block Parameter: OutDataTypeStr

Type: character vector

Values: 'Inherit: Inherit via internal rule' | 'Inherit: Same as input' | 'int8' | 'int16' | 'int32' | 'int64' | 'fixdt(1,16)' | 'fixdt(1,16,0)' | '<data type expression>'

Default: 'Inherit: Inherit via interal rule'

Output minimum — Minimum value of output

[] (default) | scalar

Specify the minimum value that the block can output. The default value is [] (unspecified). Simulink uses this value to perform:

- Simulation range checking (see “Specify Signal Ranges”)
- Automatic scaling of fixed-point data types

Programmatic Use

Block Parameter: OutMin

Type: character vector

Values: scalar

Default: ' [] '

Output maximum — Maximum value of output

[] (default) | scalar

Specify the maximum value that the block can output. The default value is [] (unspecified). Simulink uses this value to perform:

- Simulation range checking (see “Specify Signal Ranges”)
- Automatic scaling of fixed-point data types

Programmatic Use

Block Parameter: OutMax

Type: character vector

Values: scalar

Default: ' [] '

Lock data type settings against changes by the fixed-point tools — Prevent fixed-point tools from overriding data types

off (default) | on

Select this parameter to prevent the fixed-point tools from overriding the data types you specify on this block. For more information, see “Lock the Output Data Type Setting” (Fixed-Point Designer).

Programmatic Use

Block Parameter: LockScale

Type: character vector

Values: 'off' | 'on'

Default: 'off'

Integer rounding mode — Rounding mode for fixed-point operations

Floor (default) | Ceiling | Convergent | Nearest | Round | Simplest | Zero

Specify the rounding mode for fixed-point operations. For more information, see “Rounding” (Fixed-Point Designer).

Block parameters always round to the nearest representable value. To control the rounding of a block parameter, enter an expression using a MATLAB rounding function into the mask field.

Programmatic Use**Block Parameter:** RndMeth**Type:** character vector**Values:** 'Ceiling' | 'Convergent' | 'Floor' | 'Nearest' | 'Round' | 'Simplest' | 'Zero'**Default:** 'Floor'**Saturate on integer overflow — Method of overflow action**

off (default) | on

Specify whether overflows saturate or wrap.

| Action | Rationale | Impact on Overflows | Example |
|-------------------------------------|---|---|---|
| Select this check box (on). | Your model has possible overflow, and you want explicit saturation protection in the generated code. | Overflows saturate to either the minimum or maximum value that the data type can represent. | The maximum value that the <code>int8</code> (signed, 8-bit integer) data type can represent is 127. Any block operation result greater than this maximum value causes overflow of the 8-bit integer. With the check box selected, the block output saturates at 127. Similarly, the block output saturates at a minimum output value of -128. |
| Do not select this check box (off). | You want to optimize efficiency of your generated code. You want to avoid overspecifying how a block handles out-of-range signals. For more information, see "Troubleshoot Signal Range Errors". | Overflows wrap to the appropriate value that is representable by the data type. | The maximum value that the <code>int8</code> (signed, 8-bit integer) data type can represent is 127. Any block operation result greater than this maximum value causes overflow of the 8-bit integer. With the check box cleared, the software interprets the overflow-causing value as <code>int8</code> , which can produce an unintended result. For example, a block result of 130 (binary 1000 0010) expressed as <code>int8</code> , is -126. |

When you select this check box, saturation applies to every internal operation on the block, not just the output, or result. Usually, the code generation process can detect when overflow is not possible. In this case, the code generator does not produce saturation code.

Programmatic Use**Block Parameter:** SaturateOnIntegerOverflow**Type:** character vector**Values:** 'off' | 'on'**Default:** 'off'

State Attributes

State name — Unique name for block state

' ' (default) | alphanumeric string

Use this parameter to assign a unique name to the block state. The default is ' '. When this field is blank, no name is assigned. When using this parameter, remember these considerations:

- A valid identifier starts with an alphabetic or underscore character, followed by alphanumeric or underscore characters.
- The state name applies only to the selected block.

This parameter enables **State name must resolve to Simulink signal object** when you click **Apply**.

For more information, see “C Code Generation Configuration for Model Interface Elements” (Simulink Coder).

Programmatic Use

Block Parameter: StateName

Type: character vector

Values: unique name

Default: ' '

State name must resolve to Simulink signal object — Require state name resolve to a signal object

off (default) | on

Select this check box to require that the state name resolves to a Simulink signal object.

Dependencies

To enable this parameter, specify a value for **State name**. This parameter appears only if you set the model configuration parameter **Signal resolution** to a value other than None.

Programmatic Use

Block Parameter: StateMustResolveToSignalObject

Type: character vector

Values: 'off' | 'on'

Default: 'off'

Block Characteristics

| | |
|---------------------------------|---|
| Data Types | double fixed point ^a integer ^a single |
| Direct Feedthrough | no |
| Multidimensional Signals | no |
| Variable-Size Signals | no |
| Zero-Crossing Detection | no |

a. This block only supports signed fixed-point data types.

Extended Capabilities

C/C++ Code Generation

Generate C and C++ code using Simulink® Coder™.

HDL Code Generation

Generate Verilog and VHDL code for FPGA and ASIC designs using HDL Coder™.

HDL Coder provides additional configuration options that affect HDL implementation and synthesized logic.

HDL Architecture

This block has a single, default HDL architecture.

HDL Block Properties

| General | |
|------------------------------------|--|
| ConstMultiplierOptimization | Canonical signed digit (CSD) or factored CSD optimization. The default is none. See also “ConstMultiplierOptimization” (HDL Coder). |
| ConstrainedOutputPipeline | Number of registers to place at the outputs by moving existing delays within your design. Distributed pipelining does not redistribute these registers. The default is 0. For more details, see “ConstrainedOutputPipeline” (HDL Coder). |
| InputPipeline | Number of input pipeline stages to insert in the generated code. Distributed pipelining and constrained output pipelining can move these registers. The default is 0. For more details, see “InputPipeline” (HDL Coder). |
| OutputPipeline | Number of output pipeline stages to insert in the generated code. Distributed pipelining and constrained output pipelining can move these registers. The default is 0. For more details, see “OutputPipeline” (HDL Coder). |

| Native Floating Point | |
|---------------------------------|--|
| HandleDenormals | Specify whether you want HDL Coder to insert additional logic to handle denormal numbers in your design. Denormal numbers are numbers that have magnitudes less than the smallest floating-point number that can be represented without leading zeros in the mantissa. The default is inherit. See also “HandleDenormals” (HDL Coder). |
| LatencyStrategy | Specify whether to map the blocks in your design to inherit, Max, Min, or Zero for the floating-point operator. The default is inherit. See also “LatencyStrategy” (HDL Coder). |
| MantissaMultiplyStrategy | Specify how to implement the mantissa multiplication operation during code generation. By using different settings, you can control the DSP usage on the target FPGA device. The default is inherit. See also “MantissaMultiplyStrategy” (HDL Coder). |

Restrictions

- Double data types are not supported for this block. Use single data types instead.

- Frame, matrix, and vector input data types are not supported.
- The leading denominator coefficient (a0) must be 1 or -1.

The Discrete Transfer Fcn block is excluded from the following optimizations:

- Resource sharing
- Distributed pipelining

PLC Code Generation

Generate Structured Text code using Simulink® PLC Coder™.

Fixed-Point Conversion

Design and simulate fixed-point systems using Fixed-Point Designer™.

This block only supports signed fixed-point data types.

See Also

Discrete Filter | Transfer Fcn

Topics

“Working with States” on page 11-21

“C Code Generation Configuration for Model Interface Elements” (Simulink Coder)

Introduced before R2006a

Discrete Zero-Pole

Model system defined by zeros and poles of discrete transfer function

Library: Simulink / Discrete

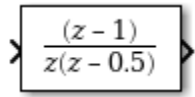

Description

The Discrete Zero-Pole block models a discrete system defined by the zeros, poles, and gain of a z-domain transfer function. This block assumes that the transfer function has the following form:

$$H(z) = K \frac{Z(z)}{P(z)} = K \frac{(z - Z_1)(z - Z_2)\dots(z - Z_m)}{(z - P_1)(z - P_2)\dots(z - P_n)},$$

where Z represents the zeros vector, P the poles vector, and K the gain. The number of poles must be greater than or equal to the number of zeros ($n \geq m$). If the poles and zeros are complex, they must be complex conjugate pairs.

The block displays the transfer function depending on how the parameters are specified. See Zero-Pole for more information.

Modeling a Single-Output System

For a single-output system, the input and the output of the block are scalar time-domain signals. To model this system:

- 1 Enter a vector for the zeros of the transfer function in the **Zeros** field.
- 2 Enter a vector for the poles of the transfer function in the **Poles** field.
- 3 Enter a 1-by-1 vector for the gain of the transfer function in the **Gain** field.

Modeling a Multiple-Output System

For a multiple-output system, the block input is a scalar and the output is a vector, where each element is an output of the system. To model this system:

- 1 Enter a matrix of zeros in the **Zeros** field.

Each *column* of this matrix contains the zeros of a transfer function that relates the system input to one of the outputs.

- 2 Enter a vector for the poles common to all transfer functions of the system in the **Poles** field.
- 3 Enter a vector of gains in the **Gain** field.

Each element is the gain of the corresponding transfer function in **Zeros**.

Each element of the output vector corresponds to a column in **Zeros**.

Ports

Input

Port_1 — Input signal

scalar

Input signal specified as a real-valued scalar.

Data Types: `single` | `double`

Output

Port_1 — Model of discrete system

scalar | vector

Model of system as defined by zeros, poles, and gain of discrete transfer function. The width of the output is equal to the number of columns in the **Zeros** matrix, or one if **Zeros** is a vector.

Data Types: `single` | `double`

Parameters

Main

Zeros — Matrix of zeros

[1] (default) | vector | matrix

Specify the vector or matrix of zeros. The number of zeros must be less than or equal to the number of poles. If the poles and zeros are complex, they must be complex conjugate pairs.

- For a single-output system, enter a vector for the zeros of the transfer function.
- For a multiple-output system, enter a matrix. Each column of the matrix contains the zeros of a transfer function that relates the system input to one of the outputs.

Programmatic Use

Block Parameter: Zeros

Type: character vector

Values: vector

Default: ' [1] '

Poles — Vector of poles

[0 0.5] (default) | vector

Specify the vector of poles. The number of poles must be greater than or equal to the number of zeros. If the poles and zeros are complex, they must be complex conjugate pairs.

- For a single-output system, enter a vector for the poles of the transfer function.
- For a multiple-output system, enter a vector for the poles common to all transfer functions of the system.

Programmatic Use

Block Parameter: Poles

Type: character vector

Values: vector

Default: '[0 0.5]'

Gain — Gain value

1 (default) | scalar | vector

Specify vector of gain values.

- For a single-output system, enter a scalar or 1-by-1 vector for the gain of the transfer function.
- For a multiple-output system, enter a vector of gains. Each element is the gain of the corresponding transfer function in **Zeros**.

Programmatic Use

Block Parameter: Gain

Type: character vector

Values: scalar | vector

Default: '1'

Sample time (-1 for inherited) — Interval between samples

-1 | scalar | vector

Specify the time interval between samples. For more information, see [Specifying Sample Time](#).

Programmatic Use

Block Parameter: SampleTime

Type: character vector

Values: scalar | vector

Default: '-1'

State Attributes

State name — Unique name for block state

' ' (default) | alphanumeric string

Use this parameter to assign a unique name to the block state. The default is ' '. When this field is blank, no name is assigned. When using this parameter, remember these considerations:

- A valid identifier starts with an alphabetic or underscore character, followed by alphanumeric or underscore characters.
- The state name applies only to the selected block.

This parameter enables **State name must resolve to Simulink signal object** when you click **Apply**.

For more information, see “C Code Generation Configuration for Model Interface Elements” (Simulink Coder).

Programmatic Use

Block Parameter: StateName

Type: character vector

Values: unique name

Default: ' '

State name must resolve to Simulink signal object — Require state name resolve to a signal object

off (default) | on

Select this check box to require that the state name resolves to a Simulink signal object.

Dependencies

To enable this parameter, specify a value for **State name**. This parameter appears only if you set the model configuration parameter **Signal resolution** to a value other than **None**.

Programmatic Use

Block Parameter: StateMustResolveToSignalObject

Type: character vector

Values: 'off' | 'on'

Default: 'off'

Block Characteristics

| | |
|---------------------------------|-----------------|
| Data Types | double single |
| Direct Feedthrough | yes |
| Multidimensional Signals | no |
| Variable-Size Signals | no |
| Zero-Crossing Detection | no |

Extended Capabilities

C/C++ Code Generation

Generate C and C++ code using Simulink® Coder™.

Generated code relies on memcpy or memset functions (string.h) under certain conditions.

See Also

Zero-Pole | Discrete Transfer Fcn

Topics

“C Code Generation Configuration for Model Interface Elements” (Simulink Coder)

“Organize Parameter Data into a Structure by Using Struct Storage Class” (Embedded Coder)

“Data Objects”

Introduced before R2006a

Display

Display signal value during simulation

Library: Simulink / Dashboard

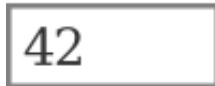

Description

The Display block connects to a signal in your model and displays its value during simulation. You can configure the appearance and format of the Display block to make intuitive sense for the value it displays. You can edit the parameters of the Display block during simulation. The Display block can display complex, vector, and 2-D matrix signals. Use the Display block with other dashboard blocks to build an interactive dashboard of controls and indicators for your model.

Connect Dashboard Blocks

Dashboard blocks do not use ports to connect to model elements. To connect dashboard blocks to signals in your model, use connect mode. Connect mode facilitates the process of connecting dashboard blocks in your model, especially when you want to connect multiple blocks at once. To connect a single dashboard block, you can also use the **Connection** table in the block dialog box.

Tip You can modify dashboard block connections during normal and accelerator mode simulations.

To enter connect mode, select a dashboard block to connect. Then, on the block tab, click **Connect**. In connect mode, when you select one or more signals or blocks, a list of signals that are available for connection appears. Select a signal from the list to connect to the selected dashboard block. To connect another dashboard block, pause on the block you want to connect and click the **Connect** button above it. Then, select one or more signals and blocks in the model and choose a signal to connect.

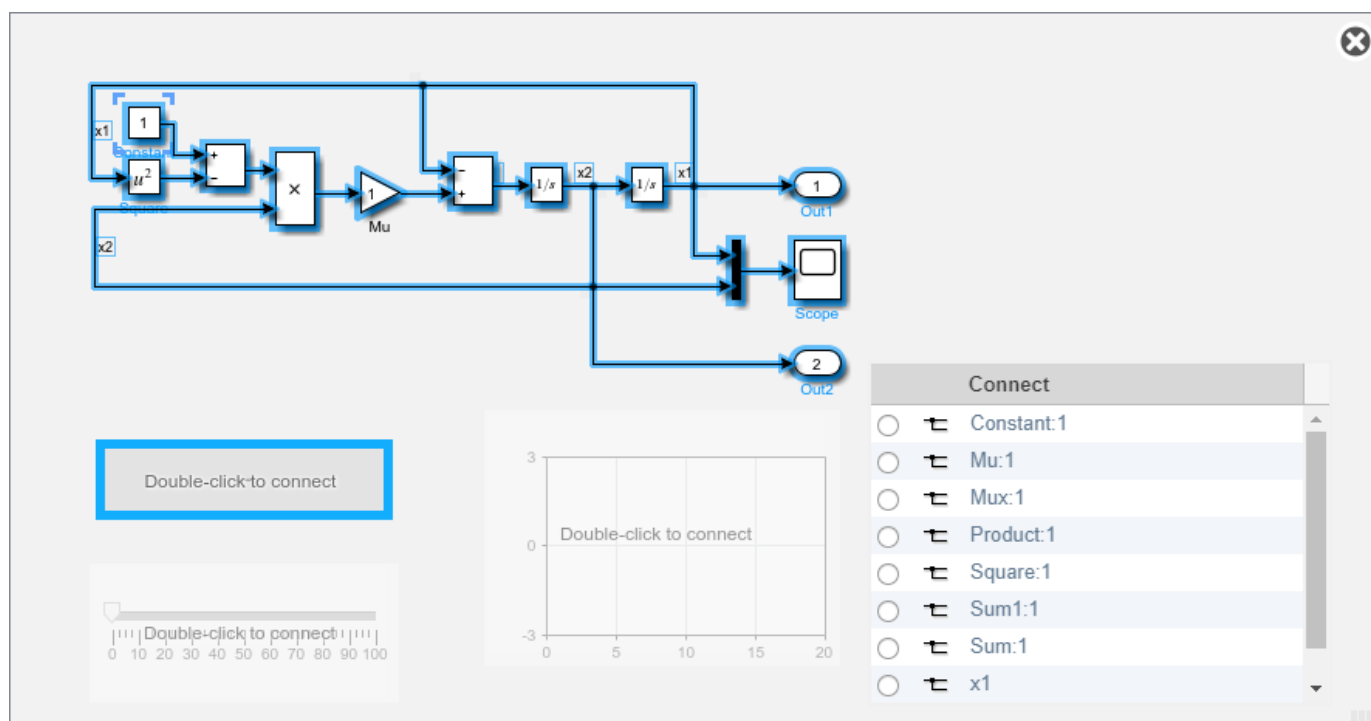

When you finish connecting the dashboard blocks in your model, on the block tab, click **Done Connecting**.

Tip You can hide the message shown on unconnected blocks using the `set_param` function with the `ShowInitialText` block parameter. The message also disappears when you connect the block.

Limitations

- You cannot use the **Connection** table to connect a Dashboard block to a block that is commented out. When you connect a Dashboard block to a commented block using connect mode, the Dashboard block does not display the connected value until you uncomment the block.
- The toolstrip does not support dashboard blocks that are in a panel.
- Dashboard blocks cannot connect to signals inside referenced models.
- When you simulate a model hierarchy, Dashboard blocks inside referenced models do not update.
- Dashboard blocks do not support rapid accelerator simulation.
- You cannot connect a dashboard block to data or activity in Stateflow during simulation.
- Some signals do not have data available during simulation due to block reduction or optimization for accelerator mode simulations. To view such a signal using a dashboard block, mark the signal for logging.

Parameters

Connection — Signal to connect and display

signal connection options

Use the connection table to select the signal to connect to the block. To connect the block to a signal:

- 1 Make a selection in the model that includes one or more signals.
- 2 In the table, select the signal you want to connect.
- 3 Click **Apply**.

Tip You can connect dashboard blocks to signals in the model during simulation.

Programmatic Use

Block Parameter: Binding

Type: Simulink.HMI.SignalSpecification

Default: []

Format — Format for displaying signal values

short (default) | long | shortE | longE | ...

Format for displaying signal values, specified as one of these values:

- short — Scaled fixed-decimal format with four digits after the decimal point
- long — Scaled fixed-decimal format with fifteen digits after the decimal point for **double** values and seven digits after the decimal point for **single** values
- shortE — Scientific notation format with four digits
- longE — Scientific notation format with fifteen digits after the decimal point for **double** values and seven digits after the decimal point for **single** values
- shortG — Data takes the more compact format between fixed-decimal or scientific notation, with a total of five digits
- longG — Data takes the more compact format between fixed-decimal or scientific notation, with a total of fifteen digits for **double** values and seven digits for **single** values
- shortEng — Engineering notation where the exponent is a multiple of 3, with 4 digits after the decimal point
- longEng — Engineering notation where the exponent is a multiple of 3, with 15 significant digits
- + — Positive/negative format. +, -, and blank characters are displayed for positive, negative, and zero values, respectively
- bank — Currency format with 2 digits after the decimal point
- hex — Hexadecimal representation
- rat — Ratio
- Custom — Custom string format. Data is displayed in a custom string that you specify using the **Format String** parameter.
- Integer — Data rounded to the nearest whole number.

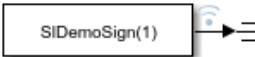

| | | | | | |
|---------------|-------------------------|-----------------|-----------------------|---|----------|
| short | 3.1416 | shortEng | 3.1416e+000 |  | |
| long | 3.141592653589793 | longEng | 3.14159265358979e+000 | string | Hello! |
| shortE | 3.1416e+00 | bank | 3.14 |  | |
| longE | 3.141592653589793e+00 | plus | + |  | |
| shortG | 3.1416 | hex | 400921FB54442D18 | enum | Positive |
| longG | 3.14159265358979 | rat | 355/113 | | |
| Custom | The value of pi is 3.14 | Integer | 3 | | |

Programmatic Use**Block Parameter:** Format**Type:** character array | string**Values:** 'short' | 'long' | 'shortE' | 'longE' | 'shortG' | 'longG' | 'shortEng' | 'longEng' | 'bank' | '+' | 'hex' | 'rat' | 'Custom' | 'Integer'**Default:** 'short'**Format String — Custom string to format data**

'%d' (default) | string

Custom string to format displayed signal data, specified as a string. The format string consists of text and format operators, which start with a % sign and end with a conversion character. Use the format operators at the place in the string where you want the signal data to display. For more information about supported formatting operators, see the `formatSpec` input of the `compose` function.

Example: The value of pi is %.2f displays the value of the connected signal within a sentence.

Example: \$%.2f displays the value of the connected signal with a dollar sign and two decimal places.

Dependencies

To enable this parameter, set the **Format** parameter to **Custom**.

Programmatic Use**Block Parameter:** FormatString**Type:** character array | string**Default:** '%d'**Alignment — Text alignment in block**

Center (default) | Left | Right

Text alignment in the Display block.

Programmatic Use**Block Parameter:** Alignment**Type:** character array**Values:** 'Left' | 'Center' | 'Right'**Default:** 'Center'**Label — Block label position**

Hide (default) | Bottom | Top

Position of the block label. When the block is connected to an element in the model, the label is the name of the connected element.

Programmatic Use**Block Parameter:** LabelPosition**Type:** character vector**Values:** 'Hide' | 'Bottom' | 'Top'**Default:** 'Hide'**Opacity — Block background opacity**

1 (default) | scalar

Block background opacity, specified as a scalar value between 0 and 1.

Example: 0.5

Programmatic Use**Block Parameter:** Opacity**Type:** scalar**Default:** 1**Layout — How to arrange elements of non-scalar data**

Preserve dimensions (default) | Fill available space

How to arrange elements of non-scalar data, specified as one of these options:

- Preserve dimensions — Display elements arranged to match signal dimensions.
- Fill available space — Display as many elements as possible within available space.

Programmatic Use**Block Parameter:** Layout**Type:** character array | string**Values:** 'Preserve dimensions' | 'Fill available space'**Default:** 'Preserve dimensions'**Show grid for non-scalar signals — Whether to show grid**

on (default) | off

Whether to show a grid on the block when the block displays non-scalar data. Specify the color of the grid using the **Grid Color** parameter.

Programmatic Use**Block Parameter:** ShowGrid**Type:** character array | string**Values:** 'on' | 'off'

Default: 'on'

Foreground Color — Block foreground color

[r g b] vector

Block foreground color, including the text. You can select a color from a palette of standard colors or specify a custom color.

Programmatic Use

Specify the `ForegroundColor` parameter for the block as a 1-by-3 [r g b] vector with values between 0 and 1.

Block Parameter: `ForegroundColor`

Type: [r g b] vector

Background Color — Block background color

[r g b] vector

Block background color. You can select a color from a palette of standard colors or specify a custom color.

Programmatic Use

Specify the `BackgroundColor` parameter for the block as a 1-by-3 [r g b] vector with values between 0 and 1.

Block Parameter: `BackgroundColor`

Type: [r g b] vector

Grid Color — Block grid color

[r g b] vector

Block grid color. The grid shows when the block displays non-scalar data. You can select a color from a palette of standard colors or specify a custom color.

Programmatic Use

Specify the `GridColor` parameter for the block as a 1-by-3 [r g b] vector with values between 0 and 1.

Block Parameter: `GridColor`

Type: [r g b] vector

Default: [0.502 0.502 0.502]

Block Characteristics

| | |
|---------------------------------|--|
| Data Types | Boolean double enumerated fixed point half integer single string |
| Direct Feedthrough | no |
| Multidimensional Signals | yes |
| Variable-Size Signals | no |
| Zero-Crossing Detection | no |

Extended Capabilities

C/C++ Code Generation

Generate C and C++ code using Simulink® Coder™.

Dashboard blocks are ignored for code generation.

See Also

Dashboard Scope | Gauge | Lamp | MultiStateImage

Topics

“Tune and Visualize Your Model with Dashboard Blocks”

“Decide How to Visualize Simulation Data”

Introduced in R2017b

Display

Show value of input

Library: Simulink / Sinks
HDL Coder / Sinks

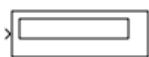

Description

The Display block shows the value of the input data. You can specify the frequency of the display. For numeric input data, you can also specify the format of display.

If the block input is an array, you can resize the block vertically or horizontally to show more than just the first element. If the block input is a vector, the block sequentially adds display fields from left to right and top to bottom. The block displays as many values as possible. A black triangle indicates that the block is not displaying all input array elements.

The Display block shows the first 200 elements of a vector signal and the first 20 rows and 10 columns of a matrix signal.

Note If you specify a numeric display format that is not large enough to display all the digits of a value, the displayed values may lose precision. The result depends on your computer hardware and operating system.

Display Abbreviations

The following abbreviations appear on the Display block to help you identify the format of the value.

| When You See... | The Value That Appears Is... |
|-----------------|--|
| (SI) | The stored integer value |
| | Note (SI) does not appear when the signal is of an integer data type. |
| hex | In hexadecimal format |
| bin | In binary format |
| oct | In octal format |

Displaying Strings

When working with strings, the Display block displays:

- Strings with double quotes.
- Special characters such as newline are shown as escaped sequences, for example '\n'.
- Non-displayable characters as escaped octal number, for example '\201'.

If the incoming signal is of type string, the **Numeric display format** parameter selection does not affect the display of the string.

Ports

Input

Port_1 – Input data

scalar | vector

Input data to display.

Data Types: single | double | half | int8 | int16 | int32 | int64 | uint8 | uint16 | uint32 | uint64 | string | Boolean | fixed point | enumerated

Parameters

Numeric display format – Format to display numeric input data

short (default) | long | short_e | long_e | bank | hex (Stored Integer) | binary (Stored Integer) | decimal (Stored Integer) | octal (Stored Integer)

Specify the format of the numeric data that appears.

| If You Select... | The Block Displays... |
|--------------------------|---|
| short | A 5-digit scaled value with fixed decimal point |
| long | A 15-digit scaled value with fixed decimal point |
| short_e | A 5-digit value with a floating decimal point |
| long_e | A 16-digit value with a floating decimal point |
| bank | A value in fixed dollars and cents format (but with no \$ or commas) |
| hex (Stored Integer) | The stored integer value of a fixed-point input in hexadecimal format |
| binary (Stored Integer) | The stored integer value of a fixed-point input in binary format |
| decimal (Stored Integer) | The stored integer value of a fixed-point input in decimal format |
| octal (Stored Integer) | The stored integer value of a fixed-point input in octal format |

If the numeric input to a Display block has an enumerated data type (see “Simulink Enumerations” and “Define Simulink Enumerations”):

- The block displays enumerated values, not the values of underlying integers.
- Setting **Numeric display format** to any of the Stored Integer settings causes an error.

If the incoming signal is of type string, the selection of the **Numeric display format** parameter does not affect the display of the string.

Programmatic Use**Block Parameter:** Format**Type:** character vector**Values:** 'short' | 'long' | 'short_e' | 'long_e' | 'bank' | 'hex (Stored Integer)' | 'binary (Stored Integer)' | 'decimal (Stored Integer)' | 'octal (Stored Integer)'**Default:** 'short'**Decimation — Display rate**

1 (default) | integer

Specify how often to display data.

The amount of data that appears and the time steps at which the data appears depend on the **Decimation** block parameter and the `SampleTime` property.

- The **Decimation** parameter enables you to display data at every n th sample, where n is the decimation factor. The default decimation, 1, displays data at every time step.

Note The Display block updates its display at the initial time, even when the **Decimation** value is greater than one.

- The `SampleTime` property, which you can set with `set_param`, enables you to specify a sampling interval at which to display points. This property is useful when you are using a variable-step solver where the interval between time steps is not the same. The default sample time, -1, causes the block to ignore the sampling interval when determining the points to display.

Note If the block inherits a sample time of `Inf`, the **Decimation** parameter is ignored.

Programmatic Use**Block Parameter:** Decimation**Type:** character vector**Values:** '1' | integer**Default:** '1'**Floating display — Floating display**

off (default) | on

To use the block as a floating display, select the **Floating display** check box. The block input port disappears and the block displays the value of the signal on a selected line.

If you select **Floating display**:

- Turn off signal storage reuse for your model. See “Signal storage reuse” (Simulink Coder) for more information.
- Do not connect a multidimensional signal to a floating display.

Programmatic Use**Block Parameter:** Floating**Type:** character vector**Values:** 'on' | 'off'**Default:** 'on'

Block Characteristics

| | |
|---------------------------------|--|
| Data Types | Boolean double enumerated fixed point half integer single string |
| Direct Feedthrough | yes |
| Multidimensional Signals | no |
| Variable-Size Signals | yes |
| Zero-Crossing Detection | no |

Extended Capabilities

C/C++ Code Generation

Generate C and C++ code using Simulink® Coder™.

Ignored for code generation.

HDL Code Generation

Generate Verilog and VHDL code for FPGA and ASIC designs using HDL Coder™.

This block can be used for simulation visibility in subsystems that generate HDL code, but is not included in the hardware implementation.

PLC Code Generation

Generate Structured Text code using Simulink® PLC Coder™.

Fixed-Point Conversion

Design and simulate fixed-point systems using Fixed-Point Designer™.

See Also

[Scope](#) | [To File](#) | [To Workspace](#)

Introduced before R2006a

Divide

Divide one input by another

Library: Simulink / Math Operations
 HDL Coder / HDL Floating Point Operations
 HDL Coder / Math Operations



Description

The Divide block outputs the result of dividing its first input by its second. The inputs can be scalars, a scalar and a nonscalar, or two nonscalars that have the same dimensions. This block supports only complex input values at division ports when all ports have the same single or double data type.

The Divide block is functionally a Product block that has two block parameter values preset:

- **Multiplication** — `Element-wise(.*)`
- **Number of Inputs** — `*/`

Setting nondefault values for either of those parameters can change a Divide block to be functionally equivalent to a Product block or a Product of Elements block.

Ports

Input

X — Input signal to multiply

scalar | vector | matrix | N-D array

Input signal to be multiplied with other inputs.

Dependencies

To enable one or more **X** ports, specify one or more `*` characters for the **Number of inputs** parameter and set the **Multiplication** parameter to `Element-wise(.*)`.

Data Types: `half` | `single` | `double` | `int8` | `int16` | `int32` | `int64` | `uint8` | `uint16` | `uint32` | `uint64` | `Boolean` | `fixed point`

÷ — Input signal to divide or invert

scalar | vector | matrix | N-D array

Input signal for division or inversion operations.

Dependencies

To enable one or more **÷** ports, specify one or more `/` characters for the **Number of inputs** parameter and set the **Multiplication** parameter to `Element-wise(.*)`.

Data Types: half | single | double | int8 | int16 | int32 | int64 | uint8 | uint16 | uint32 | uint64 | Boolean | fixed point

Port_1 – First input to multiply or divide

scalar | vector | matrix | N-D array

First input to multiply or divide, provided as a scalar, vector, matrix, or N-D array.

Data Types: half | single | double | int8 | int16 | int32 | int64 | uint8 | uint16 | uint32 | uint64 | Boolean | fixed point

Port_N – Nth input to multiply or divide

scalar | vector | matrix | N-D array

Nth input to multiply or divide, provided as a scalar, vector, matrix, or N-D array.

Data Types: half | single | double | int8 | int16 | int32 | int64 | uint8 | uint16 | uint32 | uint64 | Boolean | fixed point

*** – Input signal to multiply**

scalar | vector | matrix | N-D array

Input signal to be multiplied with other inputs.

Dependencies

To enable one or more * ports, specify one or more * characters for the **Number of inputs** parameter and set the **Multiplication** parameter to `Matrix(*)`.

Data Types: half | single | double | int8 | int16 | int32 | int64 | uint8 | uint16 | uint32 | uint64 | Boolean | fixed point

Inv – Input signal to divide or invert

scalar | vector | matrix | N-D array

Input signal for division or inversion operations.

Dependencies

To enable one or more **Inv** ports, specify one or more / characters for the **Number of inputs** parameter and set the **Multiplication** parameter to `Matrix(*)`.

Data Types: half | single | double | int8 | int16 | int32 | int64 | uint8 | uint16 | uint32 | uint64 | Boolean | fixed point

Output**Port_1 – Output computed by multiplying, dividing, or inverting inputs**

scalar | vector | matrix | N-D array

Output computed by multiplying, dividing, or inverting inputs.

Data Types: half | single | double | int8 | int16 | int32 | int64 | uint8 | uint16 | uint32 | uint64 | Boolean | fixed point

Parameters

Main

Number of inputs — Control number of inputs and type of operation

`*/` (default) | positive integer scalar | `*` or `/` for each input port

Control two properties of the block:

- The number of input ports on the block
- Whether each input is multiplied or divided into the output

When you specify:

- **1 or * or /**

The block has one input port. In element-wise mode, the block processes the input as described for the Product of Elements block. In matrix mode, if the parameter value is 1 or `*`, the block outputs the input value. If the value is `/`, the input must be a square matrix (including a scalar as a degenerate case) and the block outputs the matrix inverse. See “Element-Wise Mode” on page 1-1279 and “Matrix Mode” on page 1-1280 for more information.

- **Integer value > 1**

The block has the number of inputs given by the integer value. The inputs are multiplied together in element-wise mode or matrix mode, as specified by the **Multiplication** parameter. See “Element-Wise Mode” on page 1-1279 and “Matrix Mode” on page 1-1280 for more information.

- **Unquoted string of two or more * and / characters**

The block has the number of inputs given by the length of the character vector. Each input that corresponds to a `*` character is multiplied into the output. Each input that corresponds to a `/` character is divided into the output. The operations occur in element-wise mode or matrix mode, as specified by the **Multiplication** parameter. See “Element-Wise Mode” on page 1-1279 and “Matrix Mode” on page 1-1280 for more information.

Programmatic Use

Block Parameter: Inputs

Type: character vector

Values: `'2'` | `'*'` | `'**'` | `'*/'` | `'*/*'` | ...

Default: `'*/'`

Multiplication — Element-wise (.*) or Matrix (*) multiplication

`Element-wise(.*)` (default) | `Matrix(*)`

Specify whether the block performs `Element-wise(.*)` or `Matrix(*)` multiplication.

Programmatic Use

Block Parameter: Multiplication

Type: character vector

Values: `'Element-wise(.*)'` | `'Matrix(*)'`

Default: `'Element-wise(.*)'`

Multiply over — All dimensions or specified dimension

All dimensions (default) | Specified dimension

Specify the dimension to multiply over as **All dimensions**, or **Specified dimension**. When you select **Specified dimension**, you can specify the **Dimension** as 1 or 2.

Dependencies

To enable this parameter, set **Number of inputs** to * and **Multiplication** to **Element-wise (.*)**.

Programmatic Use

Block Parameter: CollapseMode

Type: character vector

Values: 'All dimensions' | 'Specified dimension'

Default: 'All dimensions'

Dimension — Dimension to multiply over

1 (default) | 2 | ... | N

Specify the dimension to multiply over as an integer less than or equal to the number of dimensions of the input signal.

Dependencies

To enable this parameter, set:

- **Number of inputs** to *
- **Multiplication** to **Element-wise (.*)**
- **Multiply over** to **Specified dimension**

Programmatic Use

Block Parameter: CollapseDim

Type: character vector

Values: '1' | '2' | ...

Default: '1'

Sample time — Specify sample time as a value other than -1

-1 (default) | scalar | vector

Specify the sample time as a value other than -1. For more information, see “Specify Sample Time”.

Dependencies

This parameter is not visible unless it is explicitly set to a value other than -1. To learn more, see “Blocks for Which Sample Time Is Not Recommended”.

Programmatic Use

Block Parameter: SampleTime

Type: character vector

Values: scalar or vector

Default: '-1'

Signal Attributes**Require all inputs to have the same data type — Require that all inputs have the same data type**

off (default) | on

Specify if input signals must all have the same data type. If you enable this parameter, then an error occurs during simulation if the input signal types are different.

Programmatic Use**Block Parameter:** InputSameDT**Type:** character vector**Values:** 'off' | 'on'**Default:** 'off'**Output minimum — Minimum output value for range checking**

[] (default) | scalar

Lower value of the output range that Simulink checks.

Simulink uses the minimum to perform:

- Parameter range checking (see “Specify Minimum and Maximum Values for Block Parameters”) for some blocks.
- Simulation range checking (see “Specify Signal Ranges” and “Enable Simulation Range Checking”).
- Automatic scaling of fixed-point data types.
- Optimization of the code that you generate from the model. This optimization can remove algorithmic code and affect the results of some simulation modes such as SIL or external mode. For more information, see “Optimize using the specified minimum and maximum values” (Embedded Coder).

Note **Output minimum** does not saturate or clip the actual output signal. Use the Saturation block instead.

Programmatic Use**Block Parameter:** OutMin**Type:** character vector**Values:** '[]' | scalar**Default:** '[]'**Output maximum — Maximum output value for range checking**

[] (default) | scalar

Upper value of the output range that Simulink checks.

Simulink uses the maximum value to perform:

- Parameter range checking (see “Specify Minimum and Maximum Values for Block Parameters”) for some blocks.
- Simulation range checking (see “Specify Signal Ranges” and “Enable Simulation Range Checking”).
- Automatic scaling of fixed-point data types.
- Optimization of the code that you generate from the model. This optimization can remove algorithmic code and affect the results of some simulation modes such as SIL or external mode. For more information, see “Optimize using the specified minimum and maximum values” (Embedded Coder).

Note Output maximum does not saturate or clip the actual output signal. Use the Saturation block instead.

Programmatic Use

Block Parameter: OutMax

Type: character vector

Values: '[]' | scalar

Default: '[]'

Output data type — Specify the output data type

Inherit: Inherit via internal rule (default) | Inherit: Inherit via back propagation | Inherit: Same as first input | double | single | int8 | uint8 | int16 | uint16 | int32 | uint32 | int64 | uint64 | fixdt(1,16) | fixdt(1,16,0) | fixdt(1,16,2^0,0) | <data type expression>

Choose the data type for the output. The type can be inherited, specified directly, or expressed as a data type object such as `Simulink.NumericType`. For more information, see “Control Data Types of Signals”.

When you select an inherited option, the block behaves as follows:

- **Inherit: Inherit via internal rule** — Simulink chooses a data type to balance numerical accuracy, performance, and generated code size, while taking into account the properties of the embedded target hardware. If you change the embedded target settings, the data type selected by the internal rule might change. For example, if the block multiplies an input of type `int8` by a gain of `int16` and ASIC/FPGA is specified as the targeted hardware type, the output data type is `sfix24`. If `Unspecified (assume 32-bit Generic)`, in other words, a generic 32-bit microprocessor, is specified as the target hardware, the output data type is `int32`. If none of the word lengths provided by the target microprocessor can accommodate the output range, Simulink software displays an error in the Diagnostic Viewer.

It is not always possible for the software to optimize code efficiency and numerical accuracy at the same time. If the internal rule doesn't meet your specific needs for numerical accuracy or performance, use one of the following options:

- Specify the output data type explicitly.
- Use the simple choice of **Inherit: Same as input**.
- Explicitly specify a default data type such as `fixdt(1,32,16)` and then use the Fixed-Point Tool to propose data types for your model. For more information, see `fxptdlg`.
- To specify your own inheritance rule, use **Inherit: Inherit via back propagation** and then use a Data Type Propagation block. Examples of how to use this block are available in the Signal Attributes library Data Type Propagation Examples block.
- **Inherit: Inherit via back propagation** — Use data type of the driving block.
- **Inherit: Same as first input** — Use data type of first input signal.

Dependencies

When input is a floating-point data type smaller than single precision, the **Inherit: Inherit via internal rule** output data type depends on the setting of the “Inherit floating-point output type smaller than single precision” configuration parameter. Data types are smaller than single precision when the number of bits needed to encode the data type is less than the 32 bits needed to encode the single-precision data type. For example, `half` and `int16` are smaller than single precision.

Programmatic Use**Block Parameter:** OutDataTypeStr**Type:** character vector**Values:** 'Inherit: Inherit via internal rule' | 'Inherit: Same as first input' | 'Inherit: Inherit via back propagation' | 'double' | 'single' | 'int8' | 'uint8' | 'int16' | 'uint16' | 'int32' | 'uint32' | 'int64' | 'uint64' | 'fixdt(1,16)' | 'fixdt(1,16,0)' | 'fixdt(1,16,2^0,0)' | '<data type expression>'**Default:** 'Inherit: Inherit via internal rule'**Lock output data type setting against changes by the fixed-point tools — Prevent fixed-point tools from overriding Output data type**

off (default) | on

Select this parameter to prevent the fixed-point tools from overriding the **Output** data type you specify on the block. For more information, see “Use Lock Output Data Type Setting” (Fixed-Point Designer).

Programmatic Use**Block Parameter:** LockScale**Type:** character vector**Values:** 'off' | 'on'**Default:** 'off'**Integer rounding mode — Rounding mode for fixed-point operations**

Floor (default) | Ceiling | Convergent | Nearest | Round | Simplest | Zero

Select the rounding mode for fixed-point operations. You can select:

Ceiling

Rounds positive and negative numbers toward positive infinity. Equivalent to the MATLAB `ceil` function.

Convergent

Rounds number to the nearest representable value. If a tie occurs, rounds to the nearest even integer. Equivalent to the Fixed-Point Designer `convergent` function.

Floor

Rounds positive and negative numbers toward negative infinity. Equivalent to the MATLAB `floor` function.

Nearest

Rounds number to the nearest representable value. If a tie occurs, rounds toward positive infinity. Equivalent to the Fixed-Point Designer `nearest` function.

Round

Rounds number to the nearest representable value. If a tie occurs, rounds positive numbers toward positive infinity and rounds negative numbers toward negative infinity. Equivalent to the Fixed-Point Designer `round` function.

Simplest

Chooses between rounding toward floor and rounding toward zero to generate rounding code that is as efficient as possible.

Zero

Rounds number toward zero. Equivalent to the MATLAB `fix` function.

For more information, see “Rounding” (Fixed-Point Designer).

Block parameters always round to the nearest representable value. To control the rounding of a block parameter, enter an expression using a MATLAB rounding function into the mask field.

Programmatic Use

Block Parameter: RndMeth

Type: character vector

Values: 'Ceiling' | 'Convergent' | 'Floor' | 'Nearest' | 'Round' | 'Simplest' | 'Zero'

Default: 'Floor'

Saturate on integer overflow — Method of overflow action

off (default) | on

Specify whether overflows saturate or wrap.

| Action | Rationale | Impact on Overflows | Example |
|-------------------------------------|---|---|---|
| Select this check box (on). | Your model has possible overflow, and you want explicit saturation protection in the generated code. | Overflows saturate to either the minimum or maximum value that the data type can represent. | The maximum value that the <code>int8</code> (signed, 8-bit integer) data type can represent is 127. Any block operation result greater than this maximum value causes overflow of the 8-bit integer. With the check box selected, the block output saturates at 127. Similarly, the block output saturates at a minimum output value of -128. |
| Do not select this check box (off). | You want to optimize efficiency of your generated code. You want to avoid overspecifying how a block handles out-of-range signals. For more information, see “Troubleshoot Signal Range Errors”. | Overflows wrap to the appropriate value that is representable by the data type. | The maximum value that the <code>int8</code> (signed, 8-bit integer) data type can represent is 127. Any block operation result greater than this maximum value causes overflow of the 8-bit integer. With the check box cleared, the software interprets the overflow-causing value as <code>int8</code> , which can produce an unintended result. For example, a block result of 130 (binary 1000 0010) expressed as <code>int8</code> , is -126. |

When you select this check box, saturation applies to every internal operation on the block, not just the output, or result. Usually, the code generation process can detect when overflow is not possible. In this case, the code generator does not produce saturation code.

Programmatic Use**Block Parameter:** SaturateOnIntegerOverflow**Type:** character vector**Values:** 'off' | 'on'**Default:** 'off'**Block Characteristics**

| | |
|---------------------------------|--|
| Data Types | Boolean double fixed point half integer single |
| Direct Feedthrough | yes |
| Multidimensional Signals | yes |
| Variable-Size Signals | yes |
| Zero-Crossing Detection | no |

Extended Capabilities**C/C++ Code Generation**

Generate C and C++ code using Simulink® Coder™.

Expected Differences Between Simulation and Code Generation

These conditions may yield different results between simulation and the generated code:

- The Divide block inputs contain a NaN or inf value
- The Divide block generates NaN or inf during execution

This difference is due to the nonfinite NaN or inf values. In such cases, inspect your model configuration and eliminate the conditions that produce NaN or inf.

Code Optimizations

The Simulink Coder build process provides efficient code for matrix inverse and division operations. This table describes the benefits and when each benefit is available.

| Benefit | Small Matrices (2-by-2 to 5-by-5) | Medium Matrices (6-by-6 to 20-by-20) | Large Matrices (larger than 20-by-20) |
|---|--|---|--|
| Faster code execution time, compared to R2011a and earlier releases | Yes | No | Yes |
| Reduced ROM and RAM usage, compared to R2011a and earlier releases | Yes, for real values | Yes, for real values | Yes, for real values |
| Reuse of variables | Yes | Yes | Yes |
| Dead code elimination | Yes | Yes | Yes |

| Benefit | Small Matrices (2-by-2 to 5-by-5) | Medium Matrices (6-by-6 to 20-by-20) | Large Matrices (larger than 20- by-20) |
|--|--|---|---|
| Constant folding | Yes | Yes | Yes |
| Expression folding | Yes | Yes | Yes |
| Consistency with MATLAB Coder results | Yes | Yes | Yes |

For blocks that have three or more inputs of different dimensions, the code might include an extra buffer to store temporary variables for intermediate results.

HDL Code Generation

Generate Verilog and VHDL code for FPGA and ASIC designs using HDL Coder™.

HDL Coder provides additional configuration options that affect HDL implementation and synthesized logic.

Note When you deploy the generated HDL code onto the target hardware, make sure that you set the **signed integer division rounds to** parameter in the **Hardware Implementation** pane of the Configuration Parameters dialog box to **Zero** or **Floor**.

To perform an HDL-optimized divide operation, connect a Product block to a Divide block in reciprocal mode.

HDL Architecture

The Divide block is the same as a Product block with **Number of Inputs** set to */.

| Architecture | Parameters | Description |
|---------------------|-------------------|---|
| Linear (Default) | None | Generate a divide (/) operator in the HDL code. |

| Architecture | Parameters | Description |
|--------------|--------------|--|
| ShiftAdd | UsePipelines | <p>Perform divide operations on fixed-point types by using a non-restoring division algorithm that performs multiple shift and add operations to compute the quotient. This architecture provides improved accuracy compared to the Newton-Raphson approximation method.</p> <p>When you use this architecture, to achieve a higher maximum clock frequency on the target FPGA device, leave the UsePipelines HDL block property to on.</p> <p>When you use fixed-point data types, following criteria must be satisfied for generating the HDL code:</p> <ul style="list-style-type: none"> Inputs word length (WL) must be less than 63. [Max(WL input1, WL input2) + Abs(FL Difference)] must be less than 63. Where, Fractional length (FL) Difference is given by, $\text{FL Difference} = \text{FL input1} - (\text{FL input2} + \text{FL output})$ |

Reciprocal Mode

When **Number of Inputs** is set to /, the Divide block is in reciprocal mode.

This block has multi-cycle implementations that introduce additional latency in the generated code. To see the added latency, view the generated model or validation model. See “Generated Model and Validation Model” (HDL Coder).

In reciprocal mode, the Divide block has the HDL block implementations described in the following table.

| Architectures | Parameters | Additional cycles of latency | Description |
|-----------------|------------|------------------------------|---|
| Linear(default) | None | 0 | When you compute a reciprocal, use the HDL divide (/) operator to implement the division. |

| Architectures | Parameters | Additional cycles of latency | Description |
|-------------------------------------|------------|--|--|
| ReciprocalRsqrBasedNewton | Iterations | Signed input: Iterations + 5 Unsigned input: Iterations + 3 | Use the iterative Newton method. Select this option to optimize area. The default value for Iterations is 3. The recommended value for Iterations is between 2 and 10. If Iterations is outside the recommended range, HDL Coder displays a message. |
| ReciprocalRsqrBasedNewtonSingleRate | Iterations | Signed input: (Iterations * 4) + 8 Unsigned input: (Iterations * 4) + 6 | Use the single rate pipelined Newton method. Select this option to optimize speed, or if you want a single rate implementation. The default value for Iterations is 3. The recommended value for Iterations is between 2 and 10. If Iterations is outside the recommended range, the coder displays a message. |

| Architectures | Parameters | Additional cycles of latency | Description |
|---------------|--------------|--|--|
| ShiftAdd | UsePipelines | Signed input: (Input wordlength + 4) Unsigned input: (Input wordlength + 4) | <p>Perform reciprocal operation on a fixed-point input by using a non-restoring division algorithm that performs multiple shift and add operations to compute the reciprocal. This architecture provides improved accuracy compared to the Newton-Raphson approximation method.</p> <p>When you use this architecture, to achieve a higher maximum clock frequency on the target FPGA device, leave the UsePipelines HDL block property to on.</p> <p>When you use fixed-point data types, following criteria must be satisfied for generating the HDL code:</p> <ul style="list-style-type: none"> • Input word length (WL) must be less than or equal to 63. • [WL input + Abs (FL Sum)] must be less than or equal to 63. Where, FL Sum is given by, <p>FL sum = FL input + FL output</p> |

The Newton-Raphson iterative method:

$$x_{i+1} = x_i - \frac{f(x_i)}{f'(x_i)} = x_i(1.5 - 0.5ax_i^2)$$

ReciprocalRsqrBasedNewton and ReciprocalRsqrBasedNewtonSingleRate implement the Newton-Raphson method with:

$$f(x) = \frac{1}{x^2} - 1$$

HDL code generation supports different output data types for `divide` (`*/`) and `reciprocal` (`/`) operations in `ShiftAdd`. You can use these output data types for the blocks:

- Inherit: Inherit via internal rule
- Inherit: Keep MSB
- Inherit: Match scaling
- Inherit: Inherit via back propagation
- Inherit: Same as first input
- Integer types (`uint8`, `int8`, `uint16`, `int16`, `uint32`, `int32`, `uint64`, `int64`)
- Fixed point types

HDL Block Properties

| General | |
|----------------------------------|--|
| ConstrainedOutputPipeline | Number of registers to place at the outputs by moving existing delays within your design. Distributed pipelining does not redistribute these registers. The default is 0. For more details, see “ConstrainedOutputPipeline” (HDL Coder). |
| DSPStyle | Synthesis attributes for multiplier mapping. The default is none. See also “DSPStyle” (HDL Coder). Use this property with: <ul style="list-style-type: none"> • Product block • Divide and Reciprocal blocks with Linear architecture |
| InputPipeline | Number of input pipeline stages to insert in the generated code. Distributed pipelining and constrained output pipelining can move these registers. The default is 0. For more details, see “InputPipeline” (HDL Coder). |
| OutputPipeline | Number of output pipeline stages to insert in the generated code. Distributed pipelining and constrained output pipelining can move these registers. The default is 0. For more details, see “OutputPipeline” (HDL Coder). |
| LatencyStrategy | To enable this property, set HDL architecture to <code>ShiftAdd</code> . Specify whether to map the blocks in your design to <code>MAX</code> , <code>CUSTOM</code> , or <code>ZERO</code> latency for fixed-point and floating-point types. The default is <code>MAX</code> . See also “LatencyStrategy” (HDL Coder). |
| CustomLatency | To enable this property, set HDL architecture to <code>ShiftAdd</code> . When LatencyStrategy is set to <code>CUSTOM</code> , use this property to specify a custom latency value between <code>ZERO</code> and <code>MAX</code> for fixed-point types. See also “LatencyStrategy” (HDL Coder). |

| Native Floating Point | |
|---------------------------------|--|
| HandleDenormals | Specify whether you want HDL Coder to insert additional logic to handle denormal numbers in your design. Denormal numbers are numbers that have magnitudes less than the smallest floating-point number that can be represented without leading zeros in the mantissa. The default is <code>inherit</code> . See also “HandleDenormals” (HDL Coder). |
| NFPCustomLatency | To specify a value, set LatencyStrategy to <code>Custom</code> . HDL Coder adds latency equal to the value that you specify for the NFPCustomLatency setting. See also “NFPCustomLatency” (HDL Coder). |
| MantissaMultiplyStrategy | Specify how to implement the mantissa multiplication operation during code generation. By using different settings, you can control the DSP usage on the target FPGA device. The default is <code>inherit</code> . See also “MantissaMultiplyStrategy” (HDL Coder). |
| DivisionAlgorithm | Specify whether to use the Radix-2 or Radix-4 algorithm to perform the floating-point division. The Radix-2 mode offers a trade-off between latency and frequency. The Radix-4 mode offers a trade-off between latency and resource usage. For more information, see “DivisionAlgorithm” (HDL Coder). |

To see the latency calculation for fixed-point types with Divide and Reciprocal blocks, at the MATLAB command prompt, enter:

```
HDLMathLib
```

Complex Data Support

This block does not support code generation for division with complex signals.

Restrictions

When you use the Divide block in reciprocal mode, the following restrictions apply:

- When you use fixed-point types, the input and output must be scalar. To use vector inputs, specify the `Math` architecture and input a floating-point value.
- Only the Zero rounding mode is supported.
- You must select the **Saturate on integer overflow** option on the block.

For the Divide block, only the Zero and Simplest rounding modes are supported.

PLC Code Generation

Generate Structured Text code using Simulink® PLC Coder™.

Fixed-Point Conversion

Design and simulate fixed-point systems using Fixed-Point Designer™.

See Also

Product | Dot Product | Product of Elements

Introduced before R2006a

DocBlock

Create text that documents model and save text with model

Library: Simulink / Model-Wide Utilities
HDL Coder / Model-Wide Utilities



Description

The DocBlock allows you to create and edit text that documents a model, and save that text with the model. Double-clicking an instance of the block creates a temporary file containing the text associated with this block and opens the file in an editor. Use the editor to modify the text and save the file. Simulink software stores the contents of the saved file in the model file.

The DocBlock supports HTML, Rich Text Format (RTF), and ASCII text document types. The default editors for these different document types are

- HTML — Microsoft® Word (if available). Otherwise, the DocBlock opens HTML documents using the editor specified on the **Editor/Debugger Preferences** pane of the Preferences dialog box.
- RTF — Microsoft Word (if available). Otherwise, the DocBlock opens RTF documents using the editor specified on the **Editor/Debugger Preferences** pane of the Preferences dialog box.
- Text — The DocBlock opens text documents using the editor specified on the **Editor/Debugger Preferences** pane of the Preferences dialog box.

Use the `docblock` command to change the default editors.

Tip To edit the block parameters of the DocBlock, right-click the block icon and select **Mask > Mask Parameters...**

Parameters

Code generation template symbol — Template symbol for generated code

' ' | Abstract | Description | History | Modified History | Notes

Enter a template symbol name in this field. Embedded Coder® software uses this symbol to add comments to the code generated from the model. For more information, see “Add Global Comments in the Generated Code” (Embedded Coder).

Dependencies

For comments to appear in the generated code, you must also set the **Document type** to Text.

Programmatic Use

Block Parameter: `ECoderFlag`

Type: character vector

Values: Abstract | Description | History | Modified History | Notes

Default: '0'

Document type — Type of document

Text (default) | RTF | HTML

Select the type of document associated with the DocBlock. The options are:

- Text
- RTF
- HTML

Dependencies

If you are using a DocBlock to add comments to your code during code generation, ensure that you set the **Document Type** as Text. If you set the **Document Type** as RTF or HTML, your comments will not appear in the code.

Programmatic Use

Block Parameter: DocumentType

Type: character vector

Values: Text | RTF | HTML

Default: 'Text'

Block Characteristics

| | |
|---------------------------------|----|
| Data Types | |
| Direct Feedthrough | no |
| Multidimensional Signals | no |
| Variable-Size Signals | no |
| Zero-Crossing Detection | no |

Extended Capabilities

C/C++ Code Generation

Generate C and C++ code using Simulink® Coder™.

Uses the template symbol you specify for the Embedded Coder Flag block parameter to add comments to generated code. Requires an Embedded Coder license. For more information, see “Use a Simulink DocBlock to Add a Comment” (Embedded Coder).

HDL Code Generation

Generate Verilog and VHDL code for FPGA and ASIC designs using HDL Coder™.

HDL Coder provides additional configuration options that affect HDL implementation and synthesized logic. See also “Generate Code with Annotations or Comments” (HDL Coder) and “Integrate Custom HDL Code Using DocBlock” (HDL Coder).

HDL Architecture

| Architecture | Description |
|----------------------|---|
| Annotation (default) | Insert text as comment in the generated code. |
| HDLText | Integrate text as custom HDL code. |
| No HDL | Do not generate HDL code for this block. |

HDL Block Properties

| | |
|----------------------------------|--|
| ConstrainedOutputPipeline | Number of registers to place at the outputs by moving existing delays within your design. Distributed pipelining does not redistribute these registers. The default is 0. For more details, see “ConstrainedOutputPipeline” (HDL Coder). |
| InputPipeline | Number of input pipeline stages to insert in the generated code. Distributed pipelining and constrained output pipelining can move these registers. The default is 0. For more details, see “InputPipeline” (HDL Coder). |
| OutputPipeline | Number of output pipeline stages to insert in the generated code. Distributed pipelining and constrained output pipelining can move these registers. The default is 0. For more details, see “OutputPipeline” (HDL Coder). |
| TargetLanguage | Language of the text, either Verilog [®] or VHDL [®] . The default is VHDL. When Architecture is HDLText, this property is available. To learn more, see “Integrate Custom HDL Code Using DocBlock” (HDL Coder). |

Restrictions

- **Document type** must be Text.

HDL Coder does not support the HTML or RTF options.

- You can have a maximum of two DocBlock blocks with **Architecture** set to HDLText in the same subsystem.

If you have two DocBlock blocks, one must have **TargetLanguage** set to VHDL, and the other must have **TargetLanguage** set to Verilog. When generating code, HDL Coder only integrates the custom code from the DocBlock that matches the target language for code generation.

PLC Code Generation

Generate Structured Text code using Simulink[®] PLC Coder[™].

See Also

Model Info | docblock

Topics

“Add Global Comments in the Generated Code” (Embedded Coder)

Introduced before R2006a

Dot Product

Generate dot product of two vectors

Library: Simulink / Math Operations
HDL Coder / Math Operations



Description

The Dot Product block generates the dot product of the input vectors. The scalar output, y , is equal to the MATLAB operation

$$y = \text{sum}(\text{conj}(u1) .* u2)$$

where $u1$ and $u2$ represent the input vectors. The inputs can be vectors, column vectors (single-column matrices), or scalars. If both inputs are vectors or column vectors, they must be the same length. If $u1$ and $u2$ are both column vectors, the block outputs the equivalent of the MATLAB expression $u1' * u2$.

The elements of the input vectors can be real- or complex-valued signals. The signal type (complex or real) of the output depends on the signal types of the inputs.

| Input 1 | Input 2 | Output |
|---------|---------|---------|
| real | real | real |
| real | complex | complex |
| complex | real | complex |
| complex | complex | complex |

Ports

Input

Port_1 — First operand input signal

scalar | vector

Signal representing the first operand to the dot product calculation.

Data Types: single | double | half | int8 | int16 | int32 | int64 | uint8 | uint16 | uint32 | uint64 | fixed point

Port_2 — Second operand input signal

scalar | vector

Signal representing the second operand to the dot product calculation.

Data Types: single | double | half | int8 | int16 | int32 | int64 | uint8 | uint16 | uint32 | uint64 | fixed point

Output

Port_1 — Dot product output signal

scalar | vector

Output signal resulting from the dot product calculation of the two input signals.

Data Types: single | double | half | int8 | int16 | int32 | int64 | uint8 | uint16 | uint32 | uint64 | fixed point

Parameters

Require all inputs to have the same data type — Require all inputs to have the same data type

on (default) | off

Clear this check box for all the inputs to have different data types.

Programmatic Use

Block Parameter: InputSameDT

Type: character vector

Values: 'on' | 'off'

Default: 'on'

Output minimum — Minimum output value for range checking

[] (default) | scalar

Lower value of the output range that Simulink checks.

Simulink uses the minimum to perform:

- Parameter range checking (see “Specify Minimum and Maximum Values for Block Parameters”) for some blocks.
- Simulation range checking (see “Specify Signal Ranges” and “Enable Simulation Range Checking”).
- Automatic scaling of fixed-point data types.
- Optimization of the code that you generate from the model. This optimization can remove algorithmic code and affect the results of some simulation modes such as SIL or external mode. For more information, see “Optimize using the specified minimum and maximum values” (Embedded Coder).

Note **Output minimum** does not saturate or clip the actual output signal. Use the Saturation block instead.

Programmatic Use

Block Parameter: OutMin

Type: character vector

Values: '[]' | scalar

Default: '[]'

Output maximum — Maximum output value for range checking

[] (default) | scalar

Specify the upper value of the output range that Simulink checks as a finite, real, double, scalar value.

Note If you specify a bus object as the data type for this block, do not set the maximum value for bus data on the block. Simulink ignores this setting. Instead, set the maximum values for bus elements of the bus object specified as the data type. For information on the Maximum parameter for a bus element, see `Simulink.BusElement`.

Simulink uses the maximum value to perform:

- Parameter range checking (see “Specify Minimum and Maximum Values for Block Parameters”) for some blocks.
- Simulation range checking (see “Specify Signal Ranges” and “Enable Simulation Range Checking”).
- Automatic scaling of fixed-point data types.
- Optimization of the code that you generate from the model. This optimization can remove algorithmic code and affect the results of some simulation modes such as SIL or external mode. For more information, see “Optimize using the specified minimum and maximum values” (Embedded Coder).

Note **Output maximum** does not saturate or clip the actual output signal. Use the Saturation block instead.

Programmatic Use

Block Parameter: OutMax

Type: character vector

Values: scalar

Default: '[]'

Output data type — Specify the output data type

Inherit: Inherit via internal rule (default) | Inherit: Inherit via back propagation | Inherit: Same as first input | double | single | half | int8 | uint8 | int16 | uint16 | int32 | uint32 | int64 | uint64 | fixdt(1,16) | fixdt(1,16,0) | fixdt(1,16,2^0,0) | <data type expression>

Choose the data type for the output. The type can be inherited, specified directly, or expressed as a data type object such as `Simulink.NumericType`. For more information, see “Control Data Types of Signals”.

When you select an inherited option, the block behaves as follows:

- **Inherit: Inherit via internal rule** — Simulink chooses a data type to balance numerical accuracy, performance, and generated code size, while taking into account the properties of the embedded target hardware. If you change the embedded target settings, the data type selected by the internal rule might change. For example, if the block multiplies an input of type `int8` by a

gain of int16 and ASIC/FPGA is specified as the targeted hardware type, the output data type is sfix24. If Unspecified (assume 32-bit Generic), in other words, a generic 32-bit microprocessor, is specified as the target hardware, the output data type is int32. If none of the word lengths provided by the target microprocessor can accommodate the output range, Simulink software displays an error in the Diagnostic Viewer.

It is not always possible for the software to optimize code efficiency and numerical accuracy at the same time. If the internal rule doesn't meet your specific needs for numerical accuracy or performance, use one of the following options:

- Specify the output data type explicitly.
- Use the simple choice of `Inherit: Same as input`.
- Explicitly specify a default data type such as `fixdt(1,32,16)` and then use the Fixed-Point Tool to propose data types for your model. For more information, see `fxptdlg`.
- To specify your own inheritance rule, use `Inherit: Inherit via back propagation` and then use a Data Type Propagation block. Examples of how to use this block are available in the Signal Attributes library Data Type Propagation Examples block.

Note When input is a floating-point data type smaller than single precision, `Inherit: Inherit via internal rule` depends on the setting of the “Inherit floating-point output type smaller than single precision” configuration parameter. Data types are smaller than single precision when the number of bits needed to encode the data type is less than the 32 bits needed to encode the single-precision data type. For example, `half` and `int16` are smaller than single precision.

- `Inherit: Inherit via back propagation` — Use data type of the driving block.
- `Inherit: Same as first input` — Use data type of first input signal.

Programmatic Use

Block Parameter: `OutDataTypeStr`

Type: character vector

Values: `'Inherit: Inherit via internal rule'` | `'Inherit: Same as first input'` | `'Inherit: Inherit via back propagation'` | `'double'` | `'single'` | `'half'` | `'int8'` | `'uint8'` | `'int16'` | `'uint16'` | `'int32'` | `'uint32'` | `'int64'` | `'uint64'` | `'fixdt(1,16)'` | `'fixdt(1,16,0)'` | `'fixdt(1,16,2^0,0)'` | `'<data type expression>'`

Default: `'Inherit: Inherit via internal rule'`

Lock output data type setting against changes by the fixed-point tools — Prevent fixed-point tools from overriding data types

`off` (default) | `on`

Select to lock the output data type setting of this block against changes by the Fixed-Point Tool and the Fixed-Point Advisor. For more information, see “Use Lock Output Data Type Setting” (Fixed-Point Designer).

Programmatic Use

Block Parameter: `LockScale`

Type: character vector

Values: `'off'` | `'on'`

Default: `'off'`

Integer rounding mode — Rounding mode for fixed-point operations

`Floor` (default) | `Ceiling` | `Convergent` | `Nearest` | `Round` | `Simplest` | `Zero`

Specify the rounding mode for fixed-point operations. For more information, see “Rounding” (Fixed-Point Designer).

Block parameters always round to the nearest representable value. To control the rounding of a block parameter, enter an expression using a MATLAB rounding function into the mask field.

Programmatic Use

Block Parameter: RndMeth

Type: character vector

Values: 'Ceiling' | 'Convergent' | 'Floor' | 'Nearest' | 'Round' | 'Simplest' | 'Zero'

Default: 'Floor'

Saturate on integer overflow – Method of overflow action

off (default) | on

Specify whether overflows saturate or wrap.

- **off** — Overflows wrap to the appropriate value that the data type can represent.

For example, the number 130 does not fit in a signed 8-bit integer and wraps to -126.

- **on** — Overflows saturate to either the minimum or maximum value that the data type can represent.

For example, an overflow associated with a signed 8-bit integer can saturate to -128 or 127.

Tip

- Consider selecting this check box when your model has a possible overflow and you want explicit saturation protection in the generated code.
- Consider clearing this check box when you want to optimize efficiency of your generated code.

Clearing this check box also helps you to avoid overspecifying how a block handles out-of-range signals. For more information, see “Troubleshoot Signal Range Errors”.

- When you select this check box, saturation applies to every internal operation on the block, not just the output or result.
 - In general, the code generation process can detect when overflow is not possible. In this case, the code generator does not produce saturation code.
-

Programmatic Use

Block Parameter: SaturateOnIntegerOverflow

Type: character vector

Values: 'off' | 'on'

Default: 'off'

Block Characteristics

| | |
|---------------------------|--|
| Data Types | Boolean double fixed point half integer single |
| Direct Feedthrough | yes |

| | |
|---------------------------------|-----|
| Multidimensional Signals | yes |
| Variable-Size Signals | no |
| Zero-Crossing Detection | no |

Extended Capabilities

C/C++ Code Generation

Generate C and C++ code using Simulink® Coder™.

HDL Code Generation

Generate Verilog and VHDL code for FPGA and ASIC designs using HDL Coder™.

HDL Coder provides additional configuration options that affect HDL implementation and synthesized logic.

HDL Architecture

| Architecture | Description |
|------------------|--|
| Linear (default) | Generates a linear chain of adders to compute the sum of products. |
| Tree | Generates a tree structure of adders to compute the sum of products. |

HDL Block Properties

| | |
|----------------------------------|--|
| ConstrainedOutputPipeline | Number of registers to place at the outputs by moving existing delays within your design. Distributed pipelining does not redistribute these registers. The default is 0. For more details, see “ConstrainedOutputPipeline” (HDL Coder). |
| InputPipeline | Number of input pipeline stages to insert in the generated code. Distributed pipelining and constrained output pipelining can move these registers. The default is 0. For more details, see “InputPipeline” (HDL Coder). |
| OutputPipeline | Number of output pipeline stages to insert in the generated code. Distributed pipelining and constrained output pipelining can move these registers. The default is 0. For more details, see “OutputPipeline” (HDL Coder). |

PLC Code Generation

Generate Structured Text code using Simulink® PLC Coder™.

Fixed-Point Conversion

Design and simulate fixed-point systems using Fixed-Point Designer™.

See Also

Product | Product of Elements

Introduced before R2006a

Edit

Enter new value for parameter

Library: Simulink / Dashboard



Description

The Edit block allows you to type in new values for block parameters during simulation. Use the Edit block with other Dashboard blocks to build an interactive dashboard of controls and indicators for your model.

Double-clicking the Edit block does not open its dialog box during simulation and when the block is selected. To edit the block parameters, you can use the **Property Inspector**, or you can right-click the block and select **Block Parameters** from the context menu.

Connect Dashboard Blocks

Dashboard blocks do not use ports to connect to model elements. To connect dashboard blocks to variables and block parameters, use connect mode. Connect mode facilitates the process of connecting dashboard blocks in your model, especially when you want to connect multiple blocks at once. To connect a single dashboard block, you can also use the **Connection** table in the block dialog box.

Tip You can modify dashboard block connections in your model during normal and accelerator mode simulations.

Note Dashboard blocks cannot connect to variables until you update the model diagram. To connect dashboard blocks to variables or modify variable values between opening your model and running a simulation, update the model diagram using **Ctrl+D**.

To enter connect mode, select the block. Then, on the block tab, click **Connect**. In connect mode, when you select one or more blocks, a list of parameters and variables available for connection appears. Select a variable or parameter from the list to connect to the selected dashboard block.

When the value of the selected variable or block parameter is nonscalar, use the text box at the bottom of the **Connection** table to specify the element you want to connect to the dashboard block. To connect to an element of a vector, matrix, or array, specify the element index, for example, 3 or (1, 3). To connect to an element in a bus or structure, specify the element in the context of the bus or structure hierarchy by using dots to indicate different levels in the hierarchy, and omit the top level. For example, specify a.b to connect to scalar element b of the structure or bus a nested inside the selected composite variable or parameter.

To connect another dashboard block, pause on another dashboard block and click the **Connect** button above it. Then, make a selection of signals and blocks in your model and choose a model element to connect.

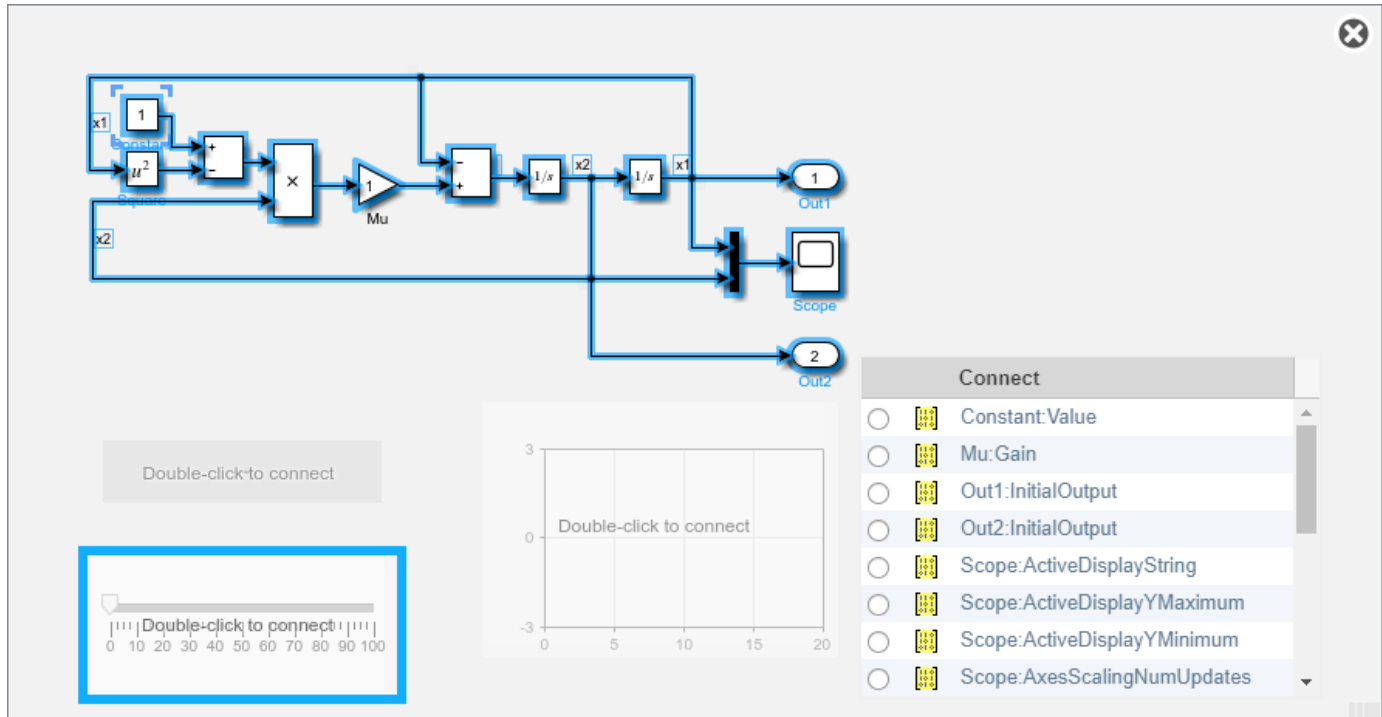

When you finish connecting the dashboard blocks in your model, on the block tab, click **Done Connecting**.

Tip You can hide the message shown on unconnected blocks using the `set_param` function with the `ShowInitialText` block parameter. The message also disappears when you connect the block.

Parameter Logging

Tunable parameters connected to dashboard blocks are logged to the Simulation Data Inspector, where you can view the parameter values along with logged signal data. You can access logged parameter data in the MATLAB workspace by exporting the parameter data from the Simulation Data Inspector by using the UI or the `Simulink.sdi.exportRun` function. For more information about exporting data using the Simulation Data Inspector UI, see “Export Data to the Workspace or a File”. The parameter data is stored in a `Simulink.SimulationData.Parameter` object, accessible as an element in the exported `Simulink.SimulationData.Dataset`.

Limitations

- Except for the Dashboard Scope block and the Display block, dashboard blocks can only connect to real scalar signals.
- The toolstrip does not support blocks that are inside a panel.
- You cannot use the **Connection** table in the block dialog to connect a dashboard block to a block that is commented out. When you connect a dashboard block to a commented block using connect

mode, the dashboard block does not display the connected value until the you uncomment the block.

- Dashboard blocks cannot connect to model elements inside referenced models.
- When you simulate a model hierarchy, dashboard blocks inside referenced models do not update.
- Dashboard blocks do not support rapid accelerator simulation.
- When you connect a dashboard block to a variable or parameter during simulation, the data for that variable or parameter is not logged to the Simulation Data Inspector. To log variable and parameter data to the Simulation Data Inspector, connect the dashboard block to the variable or parameter prior to simulation.
- When you simulate a model in external mode with the **Default parameter behavior** set to **Inlined**, dashboard blocks can appear to change parameter and variable values. However, the change does not propagate to the simulation. For example, Gain blocks display changes made to the **Gain** parameter using the dashboard blocks, but the **Gain** value used in the simulation does not change.

Parameters

Connection — Select a variable or block parameter to connect

variable and parameter connection options

Select the variable or block parameter to control using the **Connection** table. To connect the block to a signal:

- 1 Make a selection in the model that includes one or more blocks.
- 2 Select the variable or parameter you want to connect.

When the value of the selected variable or block parameter is nonscalar, use the text box at the bottom of the **Connection** table to specify the element you want to connect to the dashboard block. To connect to an element of a vector, matrix, or array, specify the element index, for example, 3 or (1, 3). To connect to an element in a bus or structure, specify the element in the context of the bus or structure hierarchy by using dots to indicate different levels in the hierarchy, and omit the top level. For example, specify a.b to connect to scalar element b of the structure or bus a nested inside the selected composite variable or parameter.

- 3 Click **Apply**.

To facilitate understanding and debugging your model, you can connect Dashboard blocks to variables and parameters in your model during simulation.

Note To see workspace variables in the connection table, update the model diagram using **Ctrl+D**.

Programmatic Use

To programmatically connect a dashboard block to a tunable parameter or a variable, use a `Simulink.HMI.ParamSourceInfo` object. The `Simulink.HMI.ParamSourceInfo` object contains four properties. Some of the properties apply to connecting dashboard blocks to parameters, and some apply to connecting dashboard blocks to variables. Not all fields have a value for a connection because a given dashboard block connects to either a parameter or a variable.

Block Parameter: Binding

Type: Simulink.HMI.ParamSourceInfo

Default: []

Align — Text alignment

Center (default) | Left | Right

Alignment of the text in the Edit block.

Programmatic Use

Block Parameter: Alignment

Type: string or character vector

Values: 'Center' | 'Left' | 'Right'

Default: 'Center'

Label — Block label position

Hide (default) | Bottom | Top

Position of the block label. When the block is connected to an element in the model, the label is the name of the connected element.

Programmatic Use

Block Parameter: LabelPosition

Type: character vector

Values: 'Hide' | 'Bottom' | 'Top'

Default: 'Hide'

Opacity — Block background opacity

1 (default) | scalar

Block background opacity, specified as a scalar value between 0 and 1.

Example: 0.5

Programmatic Use

Block Parameter: Opacity

Type: scalar

Default: 1

ForegroundColor — Block foreground color

[r g b] vector

Block foreground color, including the text. You can select a color from a palette of standard colors or specify a custom color.

Programmatic Use

Specify the ForegroundColor parameter for the block as a 1-by-3 [r g b] vector with values between 0 and 1.

Block Parameter: ForegroundColor

Type: [r g b] vector

BackgroundColor — Block background color

[r g b] vector

Block background color. You can select a color from a palette of standard colors or specify a custom color.

Programmatic Use

Specify the `BackgroundColor` parameter for the block as a 1-by-3 [r g b] vector with values between 0 and 1.

Block Parameter: `BackgroundColor`

Type: [r g b] vector

Block Characteristics

| | |
|---------------------------------|----------------------------------|
| Data Types | double half integer single |
| Direct Feedthrough | no |
| Multidimensional Signals | no |
| Variable-Size Signals | no |
| Zero-Crossing Detection | no |

Extended Capabilities**C/C++ Code Generation**

Generate C and C++ code using Simulink® Coder™.

Dashboard blocks are ignored for code generation.

See Also

Knob | Slider | Display

Topics

“Tune and Visualize Your Model with Dashboard Blocks”

“Decide How to Visualize Simulation Data”

Introduced in R2017b

Enable

Add enable port to subsystem or model

Library: Simulink / Ports & Subsystems
HDL Coder / Ports & Subsystems



Description

The Enable block allows an external signal to control execution of a subsystem or a model. To enable this functionality, add the block to a Subsystem block or at the root level of a model that is referenced in a Model block.

If you use an enable port at the root-level of a model:

- For multi-rate models, set the solver to single-tasking.
- For models with a fixed-step size, at least one block in the model must run at the specified fixed-step size rate.

Ports

Output

Enable signal — External enable signal for a subsystem or model

scalar

Enable signal attached externally to the outside of an Enabled Subsystem block and passed to the inside of the subsystem. An enable signal port is added to an Enable block when you select the **Show output port** parameter.

Data Types: `single` | `double` | `int8` | `int16` | `int32` | `int64` | `uint8` | `uint16` | `uint32` | `uint64` | `Boolean` | `fixed point` | `expression`

Parameters

States when enabling — Select block states when subsystem or model is disabled

`held` (default) | `reset`

When a Subsystem block or Model block is disabled, select what happens to block states for the blocks within the subsystem or model.

`held`

Hold block states at their previous values.

`reset`

Reset block states to their initial conditions (zero if not defined).

Programmatic Use**Block parameter:** StatesWhenEnabling**Type:** character vector**Values:** 'held' | 'reset'**Default:** 'held'**Propagate sizes of variable-size signals — Select when to propagate a variable-size signal**

Only when enabling (default) | During execution

Select when to propagate a variable-size signal.

Only when enabling

Propagate a variable-size signal when reenabling a Subsystem block or Model block containing an Enable port block. When you select this option, sample time must be periodic.

During execution

Propagate variable-size signals at each time step.

Programmatic Use**Block parameter:** PropagateVarSize**Type:** character vector**Values:** 'Only when enabling' | 'During execution'**Default:** 'Only when enabling'**Show output port — Control display of output port for enable signal**

off (default) | on

The output port passes the enable signal attached externally to the outside of an Enabled Subsystem block or enabled Model block to the inside.

 off

Remove the output port on the Enable port block.

 on

Display an output port on the Enable port block. Selecting this option allows the subsystem or model to process the enable signal.

Programmatic Use**Block parameter:** ShowOutputPort**Type:** character vector**Values:** 'off' | 'on'**Default:** 'off'**Enable zero-crossing detection — Control zero-crossing detection**

on (default) | off

Control zero-crossing detection for a model.

 on

Detect zero crossings.

off

Do not detect zero crossings.

Programmatic Use

Block parameter: ZeroCross

Type: character vector

Values: 'on' | 'off'

Default: 'on'

Port dimensions — Specify dimensions for the enable signal

1 (default) | [n] | [m n]

Specify dimensions for the enable signal attached externally to a Model block and passed to the inside of the block.

1

Scalar signal.

[n]

Vector signal of width n.

[m n]

Matrix signal having m rows and n columns.

Programmatic Use

Block parameter: PortDimensions

Type: character vector

Values: '1' | '[n]' | '[m n]'

Default: '1'

Sample time — Specify time interval

-1 (default) | Ts | [Ts, To]

Specify time interval between block method execution. See “Specify Sample Time”.

-1

Sample time inherited from the model.

Ts

Scalar where Ts is the time interval.

[Ts, To]

Vector where Ts is the time interval and To is the initial time offset.

Programmatic Use

Block parameter: SampleTime

Type: character vector

Values: '-1' | 'Ts' | '[Ts, To]'

Default: '-1'

Minimum — Specify minimum output value for the enable signal

[] (default) | real scalar

Specify minimum value for the enable signal attached externally to a Model block and passed to the inside of the block.

Simulink uses this value to perform:

- Simulation range checking. See “Specify Signal Ranges”.
- Automatic scaling of fixed-point data types.
- Optimization of generated code. This optimization can remove algorithmic code and affect the results of some simulation modes such as SIL or external mode. See “Optimize using the specified minimum and maximum values” (Embedded Coder).

[]

Unspecified minimum value.

real scalar

Real double scalar value.

Programmatic Use

Block parameter: OutMin

Type: character vector

Values: '[]' | '<real scalar>'

Default: '[]'

Maximum — Specify maximum output value for the enable signal

[] (default) | real scalar

Specify maximum value for the enable signal attached externally to a Model block and passed to the inside of the block.

Simulink uses this value to perform:

- Simulation range checking. See “Specify Signal Ranges”.
- Automatic scaling of fixed-point data types.
- Optimization of generated code. This optimization can remove algorithmic code and affect the results of some simulation modes such as SIL or external mode. See “Optimize using the specified minimum and maximum values” (Embedded Coder).

[]

Unspecified maximum value.

real scalar

Real double scalar value.

Programmatic Use

Block parameter: OutMax

Type: character vector

Values: '[]' | '<real scalar>'

Default: '[]'

Data type — Specify output data type for the enable signal

double (default) | single | int8 | uint8 | int16 | uint16 | int32 | uint32 | int64 | uint64 | boolean | fixdt(1,16) | fixdt(1,16,0) | fixdt(1,16,2^,0) | <data type expression>

Specify data type for the enable signal attached externally to a Model block and passed to the inside of the block.

`double`

Double-precision floating point.

`single`

Single-precision floating point.

`int8`

Signed 8-bit integer.

`uint8`

Unsigned 8-bit integer.

`int16`

Signed 16-bit integer.

`uint16`

Unsigned 16-bit integer.

`int32`

Signed 32-bit integer.

`uint32`

Unsigned 32-bit integer.

`int64`

Signed 64-bit integer.

`uint64`

Unsigned 64-bit integer.

`boolean`

Boolean with a value of `true` or `false`.

`fixdt(1,16)`

Signed 16-bit fixed point number with binary point undefined.

`fixdt(1,16,0)`

Signed 16-bit fixed point number with binary point set to zero.

`fixdt(1,16,2^0,0)`

Signed 16-bit fixed point number with slope set to 2^0 and bias set to 0.

`<data type expression>`

Data type object, for example `Simulink.NumericType`. You cannot enter the name of a `Simulink.Bus` object as a data type expression.

Programmatic Use

Block parameter: `OutDataTypeStr`

Type: character vector

Values: `'double'` | `'single'` | `'int8'` | `'uint8'` | `'int16'` | `'uint16'` | `'int32'` | `'uint32'` | `'int64'` | `'uint64'` | `'boolean'` | `'<fixdt(1,16)>'` | `'<fixdt(1,16,0)>'` | `'<fixdt(1,16,2^0,0)>'` | `'<data type expression>'`

Default: `'double'`

Mode — Select data type category

`Build in (default)` | `Fixed point` | `Expression`

Select data type category and display drop-down lists to help you define the data type.

Build in

Display drop-down lists for data type and Data type override.

Fixed point

Display drop-down lists for Signedness, Scaling, and Data type override.

Expression

Display text box for entering an expression.

Dependency

To enable this parameter, select the Show data type assistant button.

Programmatic Use

No equivalent command-line parameter.

Interpolate data — Specify value of missing workspace data

on (default) | off

Specify value of missing workspace data when loading data from the workspace.

on

Linearly Interpolate output at time steps for which no corresponding workspace data exists.

off

Do not interpolate output at time steps. The current output equals the output at the most recent time step for which data exists.

Programmatic Use

Block parameter: Interpolate

Type: character vector

Values: 'on' | 'off'

Default: 'on'

Block Characteristics

| | |
|---------------------------------|---|
| Data Types | Boolean double fixed point integer single |
| Direct Feedthrough | no |
| Multidimensional Signals | yes |
| Variable-Size Signals | no |
| Zero-Crossing Detection | yes |

Extended Capabilities**C/C++ Code Generation**

Generate C and C++ code using Simulink® Coder™.

HDL Code Generation

Generate Verilog and VHDL code for FPGA and ASIC designs using HDL Coder™.

HDL Coder provides additional configuration options that affect HDL implementation and synthesized logic.

HDL Architecture

This block has a single, default HDL architecture.

HDL Block Properties

| | |
|----------------------------------|--|
| ConstrainedOutputPipeline | Number of registers to place at the outputs by moving existing delays within your design. Distributed pipelining does not redistribute these registers. The default is 0. For more details, see “ConstrainedOutputPipeline” (HDL Coder). |
| InputPipeline | Number of input pipeline stages to insert in the generated code. Distributed pipelining and constrained output pipelining can move these registers. The default is 0. For more details, see “InputPipeline” (HDL Coder). |
| OutputPipeline | Number of output pipeline stages to insert in the generated code. Distributed pipelining and constrained output pipelining can move these registers. The default is 0. For more details, see “OutputPipeline” (HDL Coder). |

PLC Code Generation

Generate Structured Text code using Simulink® PLC Coder™.

Fixed-Point Conversion

Design and simulate fixed-point systems using Fixed-Point Designer™.

See Also

Subsystem | Enabled and Triggered Subsystem | Enabled Subsystem

Topics

“Conditionally Executed Subsystems Overview”

“Using Enabled Subsystems”

“Using Enabled and Triggered Subsystems”

Introduced before R2006a

Enabled and Triggered Subsystem

Subsystem whose execution is enabled and triggered by external inputs

Library: Simulink / Ports & Subsystems

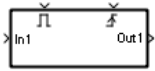

Description

The Enabled and Triggered Subsystem block is a Subsystem block preconfigured as a starting point for creating a subsystem that executes when both of these conditions occur:

- Enable control signal has a positive value.
- Trigger control signal has a trigger value.

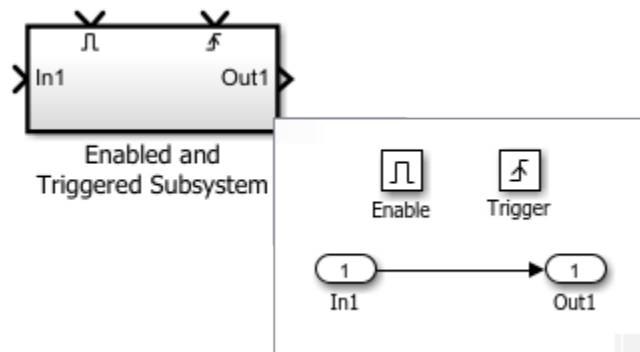

Use Enabled and Triggered Subsystem blocks to model:

- Optional functionality.
- Alternative functionality.

Ports

Input

In — Signal input to a subsystem block

scalar | vector | matrix

Placing an Inport block in a subsystem block adds an external input port to the block. The port label matches the name of the Inport block.

Use Inport blocks to get signals from the local environment.

Data Types: half | single | double | int8 | int16 | int32 | int64 | uint8 | uint16 | uint32 | uint64 | Boolean | fixed point | enumerated | bus

Enable — Control signal input to a subsystem block

scalar

Placing an Enable block in a subsystem block adds an external input port to the block.

Data Types: single | double | int8 | int16 | int32 | int64 | uint8 | uint16 | uint32 | uint64 | fixed point

Trigger — Control signal input to a subsystem block

scalar

Placing a Trigger block in a subsystem block adds an external input port to the block.

Data Types: single | double | int8 | int16 | int32 | int64 | uint8 | uint16 | uint32 | uint64 | fixed point

Output**Out — Signal output from a subsystem**

scalar | vector | matrix

Placing an Outport block in a subsystem block adds an output port from the block. The port label on the subsystem block is the name of the Outport block.

Use Outport blocks to send signals to the local environment.

Data Types: half | single | double | int8 | int16 | int32 | int64 | uint8 | uint16 | uint32 | uint64 | Boolean | fixed point | enumerated | bus

Block Characteristics

| | |
|---------------------------------|---|
| Data Types | Boolean ^a bus ^a double ^a enumerated ^a fixed point ^a half ^a integer ^a single ^a string ^a |
| Direct Feedthrough | no |
| Multidimensional Signals | limited ^a |
| Variable-Size Signals | limited ^a |
| Zero-Crossing Detection | no |

a. Actual data type or capability support depends on block implementation.

Extended Capabilities**C/C++ Code Generation**

Generate C and C++ code using Simulink® Coder™.

Actual code generation support depends on block implementation.

Fixed-Point Conversion

Design and simulate fixed-point systems using Fixed-Point Designer™.

Actual data type support depends on block implementation.

See Also

Blocks

Triggered Subsystem | Enabled Subsystem | Function-Call Subsystem | Subsystem | Enable | Trigger

Topics

“Conditionally Executed Subsystems Overview”

“Using Enabled Subsystems”

“Using Triggered Subsystems”

“Using Enabled and Triggered Subsystems”

“Using Function-Call Subsystems”

Introduced before R2006a

Enabled Subsystem

Subsystem whose execution is enabled by external input

Library: Simulink / Ports & Subsystems
HDL Coder / Ports & Subsystems

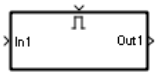

Description

The Enabled Subsystem block is a Subsystem block preconfigured as a starting point for creating a subsystem that executes when a control signal has a positive value.

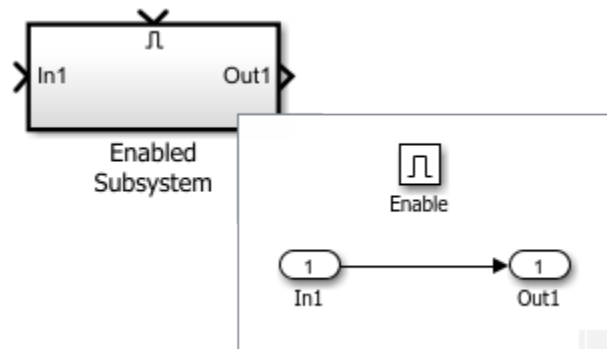

Use Enabled Subsystem blocks to model:

- Discontinuities
- Optional functionality
- Alternative functionality

Ports

Input

In — Signal input to Subsystem block

scalar | vector | matrix

Signal input to a Subsystem block, specified as a scalar, vector, or matrix. Placing an Inport block in a Subsystem block adds an external input port to the block. The port label matches the name of the Inport block.

Use Inport blocks to receive signals from the local environment.

Data Types: half | single | double | int8 | int16 | int32 | int64 | uint8 | uint16 | uint32 | uint64 | Boolean | fixed point | enumerated | bus

Enable — Control signal input to Subsystem block

scalar | vector | matrix

An Enable block in a Subsystem block adds an external input port to the block and makes the block an Enabled Subsystem block.

Data Types: single | double | int8 | int16 | int32 | int64 | uint8 | uint16 | uint32 | uint64 | Boolean | fixed point

Output**Out — Signal output from Subsystem block**

scalar | vector | matrix

Signal output from a Subsystem block, returned as a scalar, vector, or matrix. Placing an Output block in a Subsystem block adds an external output port to the block. The port label matches the name of the Output block.

Use Output blocks to send signals to the local environment.

Data Types: half | single | double | int8 | int16 | int32 | int64 | uint8 | uint16 | uint32 | uint64 | Boolean | fixed point | enumerated | bus

Block Characteristics

| | |
|---------------------------------|---|
| Data Types | Boolean ^a bus ^a double ^a enumerated ^a fixed point ^a half ^a integer ^a single ^a string ^a |
| Direct Feedthrough | no |
| Multidimensional Signals | limited ^a |
| Variable-Size Signals | limited ^a |
| Zero-Crossing Detection | no |

a. Actual data type or capability support depends on block implementation.

Extended Capabilities**C/C++ Code Generation**

Generate C and C++ code using Simulink® Coder™.

Actual code generation support depends on block implementation.

HDL Code Generation

Generate Verilog and VHDL code for FPGA and ASIC designs using HDL Coder™.

HDL Coder provides additional configuration options that affect HDL implementation and synthesized logic.

Best Practices

When using enabled subsystems in models targeted for HDL code generation, it is good practice to consider the following:

- For synthesis results to match Simulink results, the Enable port must be driven by registered logic (with a synchronous clock) on the FPGA.
- Put unit delays on Enabled Subsystem output signals. Doing so prevents the code generator from inserting extra bypass registers in the HDL code.
- Enabled subsystems can affect synthesis results in the following ways:
 - In some cases, the system clock speed can drop by a small percentage.
 - Generated code uses more resources, scaling with the number of enabled subsystem instances and the number of output ports per subsystem.

HDL Architecture

| Architecture | Description |
|------------------|---|
| Module (default) | Generate code for the subsystem and the blocks within the subsystem. |
| BlackBox | <p>Generate a black box interface. The generated HDL code includes only the input/output port definitions for the subsystem. Therefore, you can use a subsystem in your model to generate an interface to existing, manually written HDL code.</p> <p>The black-box interface generation for subsystems is similar to the Model block interface generation without the clock signals.</p> |
| No HDL | Remove the subsystem from the generated code. You can use the subsystem in simulation, however, treat it as a “no-op” in the HDL code. |

HDL Block Properties

| General | |
|----------------------------------|--|
| AdaptivePipelining | Automatic pipeline insertion based on the synthesis tool, target frequency, and multiplier word-lengths. The default is <code>inherit</code> . See also “AdaptivePipelining” (HDL Coder). |
| BalanceDelays | Detects introduction of new delays along one path and inserts matching delays on the other paths. The default is <code>inherit</code> . See also “BalanceDelays” (HDL Coder). |
| ClockRatePipelining | Insert pipeline registers at a faster clock rate instead of the slower data rate. The default is <code>inherit</code> . See also “ClockRatePipelining” (HDL Coder). |
| ConstrainedOutputPipeline | Number of registers to place at the outputs by moving existing delays within your design. Distributed pipelining does not redistribute these registers. The default is 0. For more details, see “ConstrainedOutputPipeline” (HDL Coder). |
| DistributedPipelining | Pipeline register distribution, or register retiming. The default is <code>off</code> . See also “DistributedPipelining” (HDL Coder). |
| DSPStyle | Synthesis attributes for multiplier mapping. The default is <code>none</code> . See also “DSPStyle” (HDL Coder). |
| FlattenHierarchy | Remove subsystem hierarchy from generated HDL code. The default is <code>inherit</code> . See also “FlattenHierarchy” (HDL Coder). |

| General | |
|------------------------|--|
| InputPipeline | Number of input pipeline stages to insert in the generated code. Distributed pipelining and constrained output pipelining can move these registers. The default is 0. For more details, see “InputPipeline” (HDL Coder). |
| OutputPipeline | Number of output pipeline stages to insert in the generated code. Distributed pipelining and constrained output pipelining can move these registers. The default is 0. For more details, see “OutputPipeline” (HDL Coder). |
| SharingFactor | Number of functionally equivalent resources to map to a single shared resource. The default is 0. See also “Resource Sharing” (HDL Coder). |
| StreamingFactor | Number of parallel data paths, or vectors, that are time multiplexed to transform into serial, scalar data paths. The default is 0, which implements fully parallel data paths. See also “Streaming” (HDL Coder). |

Target Specification

This block cannot be the DUT, so the block property settings in the **Target Specification** tab are ignored.

Restrictions

HDL Coder supports HDL code generation for enabled subsystems that meet the following conditions:

- The enabled subsystem is not the DUT.
- The subsystem is not *both* triggered *and* enabled.
- The enable signal is a scalar.
- Outputs of the enabled subsystem have an initial value of 0.
- All inputs and outputs of the enabled subsystem (including the enable signal) run at the same rate.
- The **Show output port** parameter of the Enable block is set to **Off**.
- The **States when enabling** parameter of the Enable block is set to **held** (i.e., the Enable block does not reset states when enabled).
- The **Output when disabled** parameter for the enabled subsystem output ports is set to **held** (i.e., the enabled subsystem does not reset output values when disabled).
- If the DUT contains the following blocks, **RAMArchitecture** is set to **WithClockEnable**:
 - Dual Port RAM
 - Simple Dual Port RAM
 - Single Port RAM
- The enabled subsystem does not contain the following blocks:
 - CIC Decimation
 - CIC Interpolation
 - FIR Decimation
 - FIR Interpolation
 - Downsample

- Upsample
- HDL FIFO
- HDL Cosimulation blocks (HDL Verifier™)
- Rate Transition
- NR Polar Encoder and NR Polar Decoder (Wireless HDL Toolbox™)

Example

The Automatic Gain Controller example shows how you can use enabled subsystems in HDL code generation. To open the example, enter:

```
hdlcoder_agc
```

PLC Code Generation

Generate Structured Text code using Simulink® PLC Coder™.

Fixed-Point Conversion

Design and simulate fixed-point systems using Fixed-Point Designer™.

Actual data type support depends on block implementation.

See Also**Blocks**

Triggered Subsystem | Enabled and Triggered Subsystem | Function-Call Subsystem | Subsystem | Enable

Topics

“Conditionally Executed Subsystems Overview”

“Using Enabled Subsystems”

“Using Triggered Subsystems”

“Using Enabled and Triggered Subsystems”

“Using Function-Call Subsystems”

Introduced before R2006a

Enumerated Constant

Generate enumerated constant value

Library: Simulink / Sources
HDL Coder / Sources



Description

The Enumerated Constant block outputs a scalar, array, or matrix of enumerated values. You can also use the Constant block to output enumerated values, but it provides block parameters that do not apply to enumerated types, such as **Output minimum** and **Output maximum**. When you need a block that outputs only constant enumerated values, use Enumerated Constant rather than Constant. For more information, see “Simulink Enumerations”.

Ports

Output

Port_1 — Enumerated constant

scalar | vector | matrix

Enumerated constant value, specified as a scalar, vector, or matrix.

Data Types: enumerated

Parameters

Output data type — Output data type

Enum: SlDemoSign (default) | Enum:<ClassName>

Specify the enumerated type from which you want the block to output one or more values. The initial value, Enum:SlDemoSign, is a dummy enumerated type that prevents a newly cloned block from causing an error. To specify the desired enumerated type, select it from the drop-down list or enter Enum:<ClassName> in the **Output data type** field, where <ClassName> is the name of the MATLAB class that defines the type.

Programmatic Use

Block Parameter: OutDataTypeStr

Type: character vector

Values: 'Enum:<ClassName>'

Default: 'Enum: SlDemoSign'

Mode — Category of data to specify

Enumerated (default)

Select the category of data to specify.

Enumerated

Enumerated data types. Selecting Enumerated enables a second menu/text box to the right, where you can enter the class name.

Value — Enumerated value

`SlDemoSign.Positive` (default) | Enum:<ClassName.Value>

Specify the value or values that the block outputs. The output of the block has the same dimensions and elements as the **Value** parameter. The initial value, `SlDemoSign.Positive`, is a dummy enumerated value that prevents a newly cloned block from causing an error.

To specify the desired enumerated values, select from the drop-down list or enter any MATLAB expression that evaluates to the desired result, including an expression that uses tunable parameters. All specified values must be of the type indicated by the **Output data type**. To specify an array that includes every value in the enumerated type, use the enumeration function.

Programmatic Use

Block Parameter: Value

Type: character vector

Values: 'Enum:<ClassName.Value>'

Default: 'SlDemoSign.Positive'

Sample time — Sample time

`inf` (default) | scalar | vector

Specify the interval between times that the block output can change during simulation (for example, due to tuning the **Value** parameter). The default value of `inf` indicates that the block output can never change. A sample time of `inf` speeds the simulation and generated code by avoiding the need to recompute the block output. For more information, see “Specify Sample Time”.

Programmatic Use

Block Parameter: SampleTime

Type: character vector

Values: scalar | vector

Default: 'inf'

Block Characteristics

| | |
|---------------------------------|------------|
| Data Types | enumerated |
| Direct Feedthrough | no |
| Multidimensional Signals | yes |
| Variable-Size Signals | no |
| Zero-Crossing Detection | no |

Extended Capabilities

C/C++ Code Generation

Generate C and C++ code using Simulink® Coder™.

HDL Code Generation

Generate Verilog and VHDL code for FPGA and ASIC designs using HDL Coder™.

HDL Coder provides additional configuration options that affect HDL implementation and synthesized logic.

HDL Architecture

This block has a single, default HDL architecture.

HDL Block Properties

| | |
|----------------------------------|--|
| ConstrainedOutputPipeline | Number of registers to place at the outputs by moving existing delays within your design. Distributed pipelining does not redistribute these registers. The default is 0. For more details, see “ConstrainedOutputPipeline” (HDL Coder). |
| OutputPipeline | Number of output pipeline stages to insert in the generated code. Distributed pipelining and constrained output pipelining can move these registers. The default is 0. For more details, see “OutputPipeline” (HDL Coder). |

PLC Code Generation

Generate Structured Text code using Simulink® PLC Coder™.

See Also

Constant | enumeration

Topics

“Use Enumerated Data in Simulink Models”

“Simulink Enumerations”

“Code Generation for Enumerations”

“Specify Sample Time”

Introduced in R2009b

Environment Controller

(Removed) Create branches of block diagram that apply only to simulation or only to code generation

Note Environment Controller block has been removed. Use the Variant Source block instead. For more information, see “Compatibility Considerations”.

Library: Simulink / Signal Routing

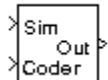

Description

The Environment Controller block outputs the signal at its **Sim** port only if the model that contains it is being simulated. It outputs the signal at its **Coder** port only if code is being generated from the model. This option enables you to create branches of a block diagram that apply only to simulation or code generation. This table describes various scenarios where either the **Sim** or **Coder** port applies.

| Scenario | Output |
|--|---|
| Normal mode simulation | Sim |
| Accelerator mode simulation | Sim |
| Rapid accelerator mode simulation | Sim |
| Simulation of a referenced model in normal or accelerator modes | Sim |
| Simulation of a referenced model in processor-in-the-loop (PIL) mode | Coder (uses the same code generated for a referenced model) |
| External mode simulation | Coder |
| Standard code generation | Coder |
| Code generation of a referenced model | Coder |

Simulink Coder software does not generate code for blocks connected to the **Sim** port if these conditions hold:

- On the **Code Generation > Optimization** pane of the Configuration Parameters dialog box, you set **Default parameter behavior** to **Inlined**.
- The blocks connected to the Sim port do not have external signals.
- The Sim port input path does not contain an S-function or an Interpreted MATLAB Function block.

If you enable block reduction optimization, Simulink eliminates blocks in the branch connected to the Coder port when compiling the model for simulation. For more information, see “Block reduction”.

Note Simulink Coder code generation eliminates the blocks connected to the Sim branch only if the Sim branch has the same signal dimensions as the Coder branch. Regardless of whether it eliminates

the Sim branch, Simulink Coder uses the sample times on the Sim branch as well as the Coder branch to determine the fundamental sample time of the generated code and might, in some cases, generate sample-time handling code that applies only to sample times specified on the Sim branch.

Ports

Input

Sim — Simulation input

scalar | vector | matrix

Simulation input values, specified as a scalar, vector, or matrix. Input signal must have the same width as the input to the **Coder** port.

Data Types: single | double | half | int8 | int16 | int32 | int64 | uint8 | uint16 | uint32 | uint64 | Boolean | fixed point | enumerated | bus

Coder — Code generation input

scalar | vector | matrix

Code generation input values, specified as a scalar, vector, or matrix. Input signal must have the same width as the input to the **Sim** port.

Data Types: single | double | half | int8 | int16 | int32 | int64 | uint8 | uint16 | uint32 | uint64 | Boolean | fixed point | enumerated | bus

Output

Out — Values from Sim or Coder input port

scalar | vector | matrix

Values from the **Sim** or **Coder** input port, depending on the current environment. For more information on what the block outputs in various simulation and code generation modes, see “Description” on page 1-563.

Data Types: single | double | half | int8 | int16 | int32 | int64 | uint8 | uint16 | uint32 | uint64 | Boolean | fixed point | enumerated | bus

Block Characteristics

| | |
|---------------------------------|---|
| Data Types | Boolean bus double enumerated fixed point half integer single |
| Direct Feedthrough | no |
| Multidimensional Signals | yes |
| Variable-Size Signals | no |
| Zero-Crossing Detection | no |

Compatibility Considerations

Environment Controller block has been removed

Warns starting in R2021b

The Environment Controller block has been removed from the Signal Routing library. Existing models that use this block continue to work with a warning. Use the Variant Source block with the **Variant control mode** parameter set to `sim_codegen_switching` instead. You can use Model Advisor or Upgrade Advisor to automatically identify and replace all instances of the Environment Controller block with the Variant Source block. For information on the Model advisor check, see “Identify Environment Controller Blocks and Replace Them with Variant Source Blocks” on page 9-66.

Variant blocks offer these advantages over the Environment Controller block:

- Variant Source block with the **Variant control mode** parameter set to `sim_codegen_switching` allows you to automatically switch between simulation and code generation workflows. In this mode, Variant Source block supports these activation times:

| Variant activation time | Behavior |
|------------------------------------|--|
| update diagram | Simulink sets the active choice during update diagram before the propagation of signal attributes. Inactive choices are removed prior to propagation of signal attributes, so the generated code contains only the active choice. |
| update diagram analyze all choices | Simulink sets the active choice during update diagram after the propagation of signal attributes. Signal attributes are propagated to both active and inactive choices to check for consistency. Inactive choices are removed at the end of update diagram before model start occurs. The generated code contains only active choices. |

- Variant Sink block enables branching on the output side (destination of a signal).
- Variant blocks highlight the path of the active variant choice during simulation and code generation.
- Variant Source block offers optimal code generation compared to the Environment Controller block. The Environment Controller block can retain blocks connected to the `Sim` port in the generated code.
- Variant blocks can be centrally managed using the Variant Manager tool, which offers these key capabilities:
 - Visualize the variant model hierarchy.
 - Define and validate multiple variant configurations of the model.
 - Generate a simplified model for a variant configuration using the Variant Reducer tool. For variant blocks with the **Variant control mode** parameter set to `sim_codegen_switching`, you can choose to retain the simulation branch or the code generation branch in the reduced model.
 - Compare variant configurations using the Variant Configuration Analysis tool.

For more information, see “Variant Manager Overview”.

Extended Capabilities

C/C++ Code Generation

Generate C and C++ code using Simulink® Coder™.

Not recommended for production code. Relates to resource limits and restrictions on speed and memory often found in embedded systems. Generated code can contain dynamic allocation and freeing of memory, recursion, additional memory overhead, and widely-varying execution times. While the code is functionally valid and generally acceptable in resource-rich environments, smaller embedded targets often cannot support such code. Usually, blocks evolve toward being suitable for production code. Thus, blocks suitable for production code remain suitable.

Fixed-Point Conversion

Design and simulate fixed-point systems using Fixed-Point Designer™.

See Also

Variant Source | “Default parameter behavior” (Simulink Coder)

Topics

“Spawn and Synchronize Execution of RTOS Task” (Simulink Coder)

“Dual-Model Approach: Code Generation” (Simulink Coder)

“Block reduction”

Introduced before R2006a

Event Listener

Event port for Initialize Function, Reset Function, and Terminate Function blocks

Description

The Event Listener block serves as an event port for the Initialize Function, Reset Function, and Terminate Function blocks.

Parameters

Event type — Select event type for subsystem

Initialize (default) | Terminate | Reset

Select event type for subsystem to execute initialize, reset, or terminate algorithms.

Initialize

Select to trigger the execution of an Initialize Function block with an initialize event.

Terminate

Select to trigger the execution of a Terminate Function block with a terminate event.

Reset

Select to trigger the execution of an Initialize Function block reconfigured as a Reset Function block with a reset event.

Programmatic Use

Block Parameter: EventType

Type: character vector

Value: 'Initialize' | 'Terminate' | 'Reset'

Default: 'Initialize'

Event name — Specify event name

Reset (default) | event name

Specify event name for Reset Function block

Reset

Default name on the face of the Reset Function block.

event name

User entered name displayed on the face of the Reset Function block, and the name of the reset event port on the Model block containing the Reset Function block.

When entering the name for a reset function, the auto-completion list provides some suggestions. The list is not complete.

Dependency

To enable this parameter, set the **Event type** parameter to Reset.

Programmatic Use**Block Parameter:** EventName**Type:** character vector**Value:** 'reset' | '<event name>'**Default:** 'reset'**Enable variant condition – Control activating the variant control (condition)**

off (default) | on

Control activating the variant control (condition) defined with the **Variant Control** parameter. off

Deactivate variant control of subsystem.

 on

Activate variant control of subsystem.

DependencySelecting this parameter, enables the **Variant control** and **Generate preprocessor conditionals** parameters.When you select **Enable variant condition** parameter, the badge indicates the change.**Programmatic Use****Block Parameter:** Variant**Type:** character vector**Value:** 'off' | 'on'**Default:** 'off'**Note**

- The Reset event port of a Model block can be conditional and propagates the net Variant conditions defined on the corresponding Reset Function block(s) in the referenced model.
- Initialize and Terminate event ports are always unconditional because they control both the model default and block-specific initialize and terminate events of the referenced model. If you define an Initialize Function block in the referenced model, it corresponds to an explicit initialize event.

Variant control – Specify variant control (condition) expression

Variant (default) | logical expression

Specify variant control (condition) expression that executes a variant Initialize Function, Reset Function, or Terminate Function block when the expression evaluates to true.

Variant

Default name for a logical (Boolean) expression.

logical expression

A logical (Boolean) expression or a Simulink.Variant object representing a Boolean expression.

If you want to generate code for your model, define the variables in the expression as Simulink.Parameter objects.

Dependency

To enable this parameter, select the **Enable variant condition** parameter.

Programmatic Use

Block Parameter: VariantControl

Type: character vector

Value: 'Variant' | '<logical expression>'

Default: 'Variant'

Generate preprocessor conditionals — Select if variant choices are enclosed within C preprocessor conditional statements

off (default) | on

Select if variant choices are enclosed within C preprocessor conditional statements.

off

Does not enclose variant choices within C preprocessor conditional statements.

on

When generating code for an ERT target, encloses variant choices within C preprocessor conditional statements (#if).

Dependency

To enable this parameter, select the **Enable variant condition** parameter.

When you select **Generate preprocessor conditionals** parameter, the badge indicates the change.



Programmatic Use

Block Parameter: GeneratePreprocessorConditionals

Type: character vector

Value: 'off' | 'on'

Default: 'off'

See Also

[Initialize Function](#) | [Reset Function](#) | [Terminate Function](#) | [State Reader](#) | [State Writer](#)

Topics

“Using Initialize, Reset, and Terminate Functions”

“Create Test Harness to Generate Function Calls”

Extract Bits

Output selection of contiguous bits from input signal

Library: Simulink / Logic and Bit Operations
HDL Coder / Logic and Bit Operations

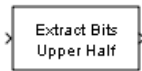

Description

The Extract Bits block allows you to output a contiguous selection of bits from the stored integer value of the input signal. Use the **Bits to extract** parameter to define the method for selecting the output bits.

- Select **Upper half** to output the half of the input bits that contain the most significant bit. If there is an odd number of bits in the input signal, the number of output bits is given by the equation

$$\text{number of output bits} = \text{ceil}(\text{number of input bits}/2)$$
- Select **Lower half** to output the half of the input bits that contain the least significant bit. If there is an odd number of bits in the input signal, the number of output bits is given by the equation

$$\text{number of output bits} = \text{ceil}(\text{number of input bits}/2)$$
- Select **Range starting with most significant bit** to output a certain number of the most significant bits of the input signal. Specify the number of most significant bits to output in the **Number of bits** parameter.
- Select **Range ending with least significant bit** to output a certain number of the least significant bits of the input signal. Specify the number of least significant bits to output in the **Number of bits** parameter.
- Select **Range of bits** to indicate a series of contiguous bits of the input to output in the **Bit indices** parameter. You indicate the range in `[start end]` format, and the indices of the input bits are labeled contiguously starting at 0 for the least significant bit.

This block does not report wrap on overflow warnings during simulation. To report these warnings, see the `Simulink.restoreDiagnostic` reference page. The block does report errors due to wrap on overflow.

Ports

Input

Port_1 – Input signal

scalar | vector | matrix | N-D array

Input signal, specified as a scalar, vector, matrix, or N-D array. Floating-point inputs are passed through the block unchanged. `boolean` inputs are treated as `uint8` signals.

Note Performing bit operations on a signed integer is difficult. You can avoid difficulty by converting the data type of your input signals to unsigned integer types.

Data Types: `single` | `double` | `int8` | `int16` | `int32` | `int64` | `uint8` | `uint16` | `uint32` | `uint64` | `Boolean` | `fixed point`

Output

Port_1 – Extracted bits

scalar | vector | matrix | N-D array

Contiguous selection of extracted bits, specified as a scalar, vector, matrix, or N-D array. Floating-point inputs are passed through the block unchanged.

Data Types: `single` | `double` | `int8` | `int16` | `int32` | `int64` | `uint8` | `uint16` | `uint32` | `uint64` | `fixed point`

Parameters

Bits to extract – Method for extracting bits

Upper half (default) | Lower half | Range starting with most significant bit | Range ending with least significant bit | Range of bits

Select the method for extracting bits from the input signal.

Consider an input signal that is represented in binary by 110111001:

- If you select `Upper half` for the **Bits to extract** parameter, the output is 11011 in binary.
- If you select `Lower half` for the **Bits to extract** parameter, the output is 11001 in binary.
- If you select `Range starting with most significant bit` for the **Bits to extract** parameter, and specify 3 for the **Number of bits** parameter, the output is 110 in binary.
- If you select `Range ending with least significant bit` for the **Bits to extract** parameter, and specify 8 for the **Number of bits** parameter, the output is 10111001 in binary.
- If you select `Range of bits` for the **Bits to extract** parameter, and specify [4 7] for the **Bit indices** parameter, the output is 1011 in binary.

Programmatic Use

Block Parameter: `bitsToExtract`

Type: character vector

Values: `'Upper half'` | `'Lower half'` | `'Range starting with most significant bit'` | `'Range ending with least significant bit'` | `'Range of bits'`

Default: `'Upper half'`

Number of bits – Number of bits to output

8 (default) | positive integer

Select the number of bits to output from the input signal. Signed integer data types must have at least two bits. Unsigned data integer types can be as short as a single bit.

Dependencies

To enable this parameter, set **Bits to extract** to `Range starting with most significant bit` or `Range ending with least significant bit`.

Programmatic Use**Block Parameter:** numBits**Type:** character vector**Values:** positive integer**Default:** '8'**Bit indices — Contiguous range of bits to output**

[0 7] (default) | contiguous range

Specify a contiguous range of bits of the input signal to output. Specify the range in [start end] format. The indices are assigned to the input bits starting with 0 at the least significant bit.

Dependencies

To enable this parameter, set **Bits to extract** to Range of bits.

Programmatic Use**Block Parameter:** bitIdxRange**Type:** character vector**Values:** contiguous range**Default:** '[0 7]'**Output scaling mode — Output scaling mode**

Preserve fixed-point scaling (default) | Treat bit field as an integer

Select the scaling mode to use on the output bit selection:

- When you select `Preserve fixed-point scaling`, the fixed-point scaling of the input is used to determine the output scaling during the data type conversion.
- When you select `Treat bit field as an integer`, the fixed-point scaling of the input is ignored, and only the stored integer is used to compute the output data type.

Programmatic Use**Block Parameter:** outScalingMode**Type:** character vector**Values:** 'Preserve fixed-point scaling' | 'Treat bit field as an integer'**Default:** 'Preserve fixed-point scaling'**Block Characteristics**

| | |
|---------------------------------|---|
| Data Types | Boolean double fixed point integer single |
| Direct Feedthrough | yes |
| Multidimensional Signals | yes |
| Variable-Size Signals | no |
| Zero-Crossing Detection | no |

Extended Capabilities**C/C++ Code Generation**

Generate C and C++ code using Simulink® Coder™.

HDL Code Generation

Generate Verilog and VHDL code for FPGA and ASIC designs using HDL Coder™.

HDL Coder provides additional configuration options that affect HDL implementation and synthesized logic.

HDL Architecture

This block has a single, default HDL architecture.

HDL Block Properties

| | |
|----------------------------------|--|
| ConstrainedOutputPipeline | Number of registers to place at the outputs by moving existing delays within your design. Distributed pipelining does not redistribute these registers. The default is 0. For more details, see “ConstrainedOutputPipeline” (HDL Coder). |
| InputPipeline | Number of input pipeline stages to insert in the generated code. Distributed pipelining and constrained output pipelining can move these registers. The default is 0. For more details, see “InputPipeline” (HDL Coder). |
| OutputPipeline | Number of output pipeline stages to insert in the generated code. Distributed pipelining and constrained output pipelining can move these registers. The default is 0. For more details, see “OutputPipeline” (HDL Coder). |

PLC Code Generation

Generate Structured Text code using Simulink® PLC Coder™.

Fixed-Point Conversion

Design and simulate fixed-point systems using Fixed-Point Designer™.

See Also

Bitwise Operator | Bit Clear | Bit Set

Introduced before R2006a

Find Nonzero Elements

Find nonzero elements in array

Library: Simulink / Math Operations

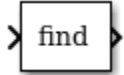

Description

The Find Nonzero Elements block locates all nonzero elements of the input signal and returns the linear indices of those elements. If the input is a multidimensional signal, the Find Nonzero Elements block can also return the subscripts of the nonzero input elements. In both cases, you can show an output port with the nonzero input values.

The Find Nonzero Elements block outputs a variable-size signal. The sample time for any variable-size signal must be discrete. If your model does not already use a fixed-step solver, you may need to select a fixed-step solver in the Configuration Parameters dialog. For more information, see “Compare Solvers” and “Choose a Solver”.

Ports

Input

Port_1 – Input signal

scalar | vector | matrix | N-D array

Input signal from which the block finds all nonzero elements.

Data Types: single | double | int8 | int16 | int32 | int64 | uint8 | uint16 | uint32 | uint64 | Boolean | fixed point

Output

Port_1 – Indices of nonzero elements

variable-size signal

The Find Nonzero Elements block outputs the indices of nonzero elements as a variable-size signal. You control the data type of the output using the **Output data type** block parameter.

Dependencies

By default, the block outputs linear indices from the first output port. When you change the **Index output format** to Subscripts, the block instead provides the element indices of a two-dimension or larger signal in a subscript form. In this mode, you must specify the **Number of input dimensions**, and the block creates a separate output port for each dimension.

Data Types: single | double | int8 | int16 | int32 | int64 | uint8 | uint16 | uint32 | uint64 | Boolean | fixed point

Port_2 – Values of nonzero elements

variable-size signal

The Find block can optionally output the values of all nonzero elements as a variable-size signal.

Dependencies

To enable this port, select **Show output port for nonzero input values**.

Data Types: `single` | `double` | `int8` | `int16` | `int32` | `int64` | `uint8` | `uint16` | `uint32` | `uint64` | `Boolean` | `fixed point`

Parameters

Main

Index output format — Format for indices of nonzero elements

`Linear indices` (default) | `Subscripts`

Select the output format for the indices of the nonzero input values.

- Selecting `Linear indices` provides the element indices of any dimension signal in a vector form. For one dimension (vector) signals, indices correspond to the position of nonzero values within the vector. For signals with more than one dimension, the conversion of subscripts to indices is along the first dimension. You do not need to know the signal dimension of the input signal.
- Selecting `Subscripts` provides the element indices of a two-dimension or larger signal in a subscript form. Because the block shows an output port for each dimension, this option requires you to specify the **Number of input dimensions**.

Programmatic Use

Block Parameter: `IndexOutputFormat`

Type: character vector

Values: `'Linear indices'` | `'Subscripts'`

Default: `'Linear indices'`

Number of input dimensions — Number of dimensions for the input signal

`1` (default) | scalar

Specify the number of dimensions for the input signal as a positive integer value from 1 to 32.

Dependencies

To enable this parameter, set **Index output format** to `Subscripts`.

Programmatic Use

Block Parameter: `NumberOfInputDimensions`

Type: character vector

Values: scalar

Default: `'1'`

Index mode — Specify zero- or one-based indexing

`Zero-based` (default) | `One-based`

Specify the indexing mode as `Zero-based` or `One-based`.

- For `Zero-based` indexing, an index of 0 specifies the first element of the input vector. An index of 1 specifies the second element, and so on.

- For One-based indexing, an index of 1 specifies the first element of the input vector. An index of 2, specifies the second element, and so on.

Programmatic Use**Block Parameter:** IndexMode**Type:** character vector**Values:** 'Zero-based' | 'One-based'**Default:** 'Zero-based'**Show output port for nonzero input values — Enable output port for nonzero values**

off (default) | on

Show or hide the output port for nonzero input values.

- When you clear this check box (off), the block hides the output port for nonzero input values.
- When you select this check box (on), the block displays the output port for nonzero input values. The additional output port provides values of the nonzero input elements.

Programmatic Use**Block Parameter:** ShowOutputPortForNonzeroInputValues**Type:** character vector**Values:** 'on' | 'off'**Default:** 'off'**Sample time — Specify sample time as a value other than -1**

-1 (default) | scalar | vector

Specify the sample time as a value other than -1. For more information, see “Specify Sample Time”.

Dependencies

This parameter is not visible unless it is explicitly set to a value other than -1. To learn more, see “Blocks for Which Sample Time Is Not Recommended”.

Programmatic Use**Block Parameter:** SampleTime**Type:** character vector**Values:** scalar or vector**Default:** '-1'**Data Types****Output data type — Output data type**

Inherit: Inherit via internal rule (default) | int8 | uint8 | int16 | uint16 | int32 | uint32 | int64 | uint64 | fixdt(1,16) | <data type expression>

Specify the output data type.

Click the **Show data type assistant** button  to display the **Data Type Assistant**, which helps you set the data type attributes. For more information, see “Specify Data Types Using Data Type Assistant”.

Programmatic Use**Block Parameter:** OutDataTypeStr

Type: character vector

Values: 'Inherit: Inherit via internal rule' | 'int8' | 'uint8' | 'int16' | 'uint16' | 'int32' | 'uint32' | 'int64' | 'uint64' | 'fixdt(1,16)' | '<data type expression>'

Default: 'Inherit: Inherit via internal rule'

Block Characteristics

| | |
|---------------------------------|---|
| Data Types | Boolean double fixed point integer single |
| Direct Feedthrough | yes |
| Multidimensional Signals | yes |
| Variable-Size Signals | yes |
| Zero-Crossing Detection | no |

Extended Capabilities

C/C++ Code Generation

Generate C and C++ code using Simulink® Coder™.

Fixed-Point Conversion

Design and simulate fixed-point systems using Fixed-Point Designer™.

See Also

find

Topics

“Array Indexing”

“Variable-Size Signal Basics”

“Inspect Variable-Size Signals on Simulink Models”

“Control Data Types of Signals”

Introduced in R2010a

First Order Hold

Implement linearly extrapolated first order hold on input signal

Library: Simulink / Continuous



Description

The First Order Hold block outputs a continuous piecewise linear approximation of its input signal. Use the First Order Hold block to convert a sampled discrete signal to a continuous signal without triggering a solver reset.

You can also use the First Order Hold block to break algebraic loops in your model.

Ports

Input

Port 1 – Input signal

scalar | vector | matrix

Input signal, specified as a real-valued scalar, vector, or matrix.

Data Types: double

Output

Port 1 – Linearly approximated output signal

scalar | vector | matrix

Piecewise linear approximation of the input signal.

Data Types: double

Parameters

Initial output – Initial output

0 (default) | scalar | vector

Specify the output that the block generates until the simulation time exceeds the first sample hit time of the discrete input.

Dependencies

- The initial output of this block cannot be `inf` or `NaN`.
- A Run-to-run tunable parameter cannot be changed during simulation run time. However, changing it before a simulation begins does not cause Accelerator or Rapid Accelerator to regenerate code.

Programmatic Use**Block Parameter:** InitialOutput**Type:** character vector, string**Values:** scalar | vector**Default:** '0'**Output algorithm — Approximation technique for output signal**

Slow (Avoid Overshoot) (default) | Fast (Minimize Error)

Specify the approximation technique to use to smooth the input signal. The slow, or low pass algorithm aims to avoid overshoots when smoothing the input signal. The fast, or high pass algorithm minimizes error by attempting to predict the next input during the update method of the block. This error reduction in predicted output of the block is traded off against a tendency to overshoot the reference, or input signal.

Programmatic Use**Block Parameter:** OutputAlgorithm**Type:** character vector, string**Values:** Slow (Avoid Overshoot) | Fast (Minimize Error)**Default:** 'Slow (Avoid Overshoot)'**Reset if relative extrapolation error exceeds — Error tolerance for solver reset**

inf (default) | nonnegative real scalar

Specify the tolerance level for the extrapolation error of the Output Algorithm. Extrapolation error greater than this value will cause Simulink to reset the solver for the model.

Tip Enabling the **Allow continuous input** parameter when this parameter is set to inf can lead to numerical inaccuracies in simulation.

Programmatic Use**Block Parameter:** ErrorTolerance**Type:** character vector, string**Values:** scalar**Default:** 'inf'**Allow continuous input — Apply hold on continuous signals**

off (default) | on

Select this parameter to enable the block to accept continuous signals as input. Enabling this parameter creates a delay between the input and output continuous signals.

Note Enable this parameter when using this block to break an algebraic loop.

Programmatic Use**Block Parameter:** AllowContinuousInput**Type:** character vector, string**Values:** 'off' | 'on'**Default:** 'off'

Block Characteristics

| | |
|---------------------------------|--------|
| Data Types | double |
| Direct Feedthrough | no |
| Multidimensional Signals | no |
| Variable-Size Signals | no |
| Zero-Crossing Detection | no |

Algorithms

Slow (Avoid overshoot)

The linear extrapolation performed by the slow or low pass algorithm can be described as:

$$y(t) = M_k(t - T_k) + C_k \quad \forall \quad T_k \leq t < t_{k+1}$$

where:

- T_k is the time at k^{th} major step.
- U_k is the input at k^{th} major step.
- C_k and M_k are the linear extrapolation coefficients.
- y_k is the continuous output at time T_k .

The coefficients, or slope M_k and y-intercept C_k , are calculated as follows

$$H_k = T_k - T_{k-1}$$

$$M_{k+1} = \frac{U_k - U_{k-1}}{H_k}$$

$$C_k = y_k$$

Fast (Minimize Error)

The linear extrapolation performed by the fast, or high pass, algorithm can be described as:

$$y(t) = N_k(t - T_k) + C_k \quad \forall \quad T_k \leq t < T_{k+1}$$

where:

- T_k is the time at k^{th} major step.
- U_k is the input at k^{th} major step.
- \hat{U} is the predicted value of the input at $(k+1)^{\text{th}}$ major step.
- (C_k and N_k are the linear extrapolation coefficients.
- y_k is the continuous output at time T_k .

The coefficients, or slope N_k and y-intercept C_k , are calculated as follows

$$H_k = T_k - T_{k-1}$$

$$M_{k+1} = \frac{U_k - U_{k-1}}{H_k}$$

$$\widehat{U} = U_k + M_{k+1}(H_K)$$

$$N_{k+1} = \frac{\widehat{U} - y_k}{H_K}$$

$$C_k = y_k$$

The fast algorithm minimizes error by attempting to predict the next input during the update method of the block. This error reduction in predicted output of the block is traded off against a tendency to overshoot the input signal.

Extended Capabilities

C/C++ Code Generation

Generate C and C++ code using Simulink® Coder™.

Not recommended for production code generation.

Consider discretizing your model.

See Also

Memory | Zero-Order Hold

Introduced in R2019b

Fixed-Point State-Space

Implement discrete-time state space

Library: Simulink / Additional Math & Discrete / Additional Discrete

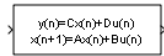

Description

The Fixed-Point State-Space block implements the system described by

$$y(n) = Cx(n) + Du(n)$$

$$x(n + 1) = Ax(n) + Bu(n)$$

where u is the input, x is the state, and y is the output. Both equations have the same data type.

- **A** must be an n -by- n matrix, where n is the number of states.
- **B** must be an n -by- m matrix, where m is the number of inputs.
- **C** must be an r -by- n matrix, where r is the number of outputs.
- **D** must be an r -by- m matrix.

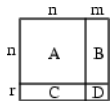

In addition:

- The state x must be an n -by-1 vector.
- The input u must be an m -by-1 vector.
- The output y must be an r -by-1 vector.

The block accepts one input and generates one output. The width of the input vector is the number of columns in the **B** and **D** matrices. The width of the output vector is the number of rows in the **C** and **D** matrices. To define the initial state vector, use the **Initial conditions** parameter.

Ports

Input

Port_1 — Input signal

scalar | vector | matrix

Input vector, where the width equals the number of columns in the **B** and **D** matrices. For more information, see “Description” on page 1-583.

Data Types: single | double | int8 | int16 | int32 | int64 | uint8 | uint16 | uint32 | uint64 | Boolean | fixed point

Output

Port_1 — Output signal

scalar | vector | matrix

Output signal, with width equal to the number of rows in the **C** and **D** matrices. For more information, see “Description” on page 1-583.

Data Types: single | double | int8 | int16 | int32 | int64 | uint8 | uint16 | uint32 | uint64 | Boolean | fixed point

Parameters

Main

State Matrix A — Matrix of states

[2.6020 -2.2793 0.6708; 1 0 0; 0 1 0] (default) | scalar | vector | matrix

Specify the matrix of states as an n -by- n matrix of real or complex values, where n is the number of states. For more information on the matrix coefficients, see “Description” on page 1-583.

Programmatic Use

Block Parameter: A

Type: character vector

Values: scalar | vector | matrix

Default: '[2.6020 -2.2793 0.6708; 1 0 0; 0 1 0]'

Input Matrix B — Column vector of inputs

[1; 0; 0] (default) | scalar | vector | matrix

Specify the column vector of inputs as an n -by- m matrix of real or complex values, where n is the number of states, and m is the number of inputs. For more information on the matrix coefficients, see “Description” on page 1-583.

Programmatic Use

Block Parameter: B

Type: character vector

Values: scalar | vector | matrix

Default: '[1; 0; 0]'

Output Matrix C — Column vector of outputs

[0.0184 0.0024 0.0055] (default) | scalar | vector | matrix

Specify the column vector of outputs as an r -by- n matrix of real or complex values, where r is the number of outputs, and n is the number of states. For more information on the matrix coefficients, see “Description” on page 1-583.

Programmatic Use

Block Parameter: C

Type: character vector

Values: scalar | vector | matrix

Default: '[0.0184 0.0024 0.0055]'

Direct Feedthrough Matrix D — Matrix for direct feedthrough

[0.0033] (default) | scalar | vector | matrix

Specify the matrix for direct feedthrough as an r -by- m matrix of real or complex values, where r is the number of outputs, and m is the number of inputs. For more information on the matrix coefficients, see “Description” on page 1-583.

Programmatic Use**Block Parameter:** D**Type:** character vector**Values:** scalar | vector | matrix**Default:** ' [0.0033] '**Initial condition for state — Initial state vector**

0.0 (default) | scalar | vector | matrix

Specify the initial condition for the state.

Limitations

The initial state cannot be `inf` or `NaN`.

Programmatic Use**Block Parameter:** X0**Type:** character vector**Values:** scalar | vector | matrix**Default:** '0.0'**Signal Attributes****Data type for internal calculations — Data type for internal calculations**

fixdt('double') (default) | data type string

Specify the data type the block uses for internal calculations.

Programmatic Use**Block Parameter:** InternalDataType**Type:** character vector**Values:** data type string**Default:** 'fixdt('double')'**Scaling for State Equation AX+BU — Scaling for state equations**

2^0 (default) | scalar

Specify the scaling for the state equation **AX+BU**.

Programmatic Use**Block Parameter:** StateEqScaling**Type:** character vector**Values:** scalar**Default:** '2^0'**Scaling for Output Equation CX+DU — Scaling for output equations**

2^0 (default) | scalar

Specify the scaling for the output equation **CX+DU**.

Programmatic Use**Block Parameter:** InternalDataType

Type: character vector

Values: scalar

Default: '2^0'

Lock output data type setting against changes by the fixed-point tools – Prevent fixed-point tools from overriding data types

off (default) | on

Select to lock the output data type setting of this block against changes by the Fixed-Point Tool and the Fixed-Point Advisor. For more information, see “Use Lock Output Data Type Setting” (Fixed-Point Designer).

Programmatic Use

Block Parameter: LockScale

Type: character vector

Values: 'off' | 'on'

Default: 'off'

Integer rounding mode — Rounding mode for fixed-point operations

Floor (default) | Ceiling | Convergent | Nearest | Round | Simplest | Zero

Specify the rounding mode for fixed-point operations. For more information, see “Rounding” (Fixed-Point Designer).

Programmatic Use

Block Parameter: RndMeth

Type: character vector

Values: 'Ceiling' | 'Convergent' | 'Floor' | 'Nearest' | 'Round' | 'Simplest' | 'Zero'

Default: 'Floor'

Saturate to max or min when overflows occur — Method of overflow action

off (default) | on

When you select this check box, overflows saturate to the maximum or minimum value that the data type can represent. Otherwise, overflows wrap.

When you select this check box, saturation applies to every internal operation on the block, not just the output or result. In general, the code generation process can detect when overflow is not possible. In this case, the code generator does not produce saturation code.

Programmatic Use

Block Parameter: DoSatur

Type: character vector

Values: 'off' | 'on'

Default: 'off'

Block Characteristics

| | |
|---------------------------------|--|
| Data Types | Boolean ^a double fixed point integer single |
| Direct Feedthrough | no |
| Multidimensional Signals | no |

| | |
|--------------------------------|-----|
| Variable-Size Signals | yes |
| Zero-Crossing Detection | no |

a. This block is not recommended for use with Boolean signals.

Extended Capabilities

C/C++ Code Generation

Generate C and C++ code using Simulink® Coder™.

HDL Code Generation

Generate Verilog and VHDL code for FPGA and ASIC designs using HDL Coder™.

HDL Coder provides additional configuration options that affect HDL implementation and synthesized logic.

HDL Architecture

This block has a single, default HDL architecture.

HDL Block Properties

If you use the block in matrix multiplication mode, you can specify the **DotProductStrategy**. This setting determines whether you want to implement the matrix multiplication by using a tree of adders and multipliers, or use the Multiply-Accumulate block implementation. The default is Fully Parallel.

Note The **DotProductStrategy** must be set to Fully Parallel when you use the Native Floating Point mode.

For more information, see “DotProductStrategy” (HDL Coder).

| General | |
|----------------------------------|--|
| ConstrainedOutputPipeline | Number of registers to place at the outputs by moving existing delays within your design. Distributed pipelining does not redistribute these registers. The default is 0. For more details, see “ConstrainedOutputPipeline” (HDL Coder). |
| DSPStyle | Synthesis attributes for multiplier mapping. The default is none. See also “DSPStyle” (HDL Coder). |
| InputPipeline | Number of input pipeline stages to insert in the generated code. Distributed pipelining and constrained output pipelining can move these registers. The default is 0. For more details, see “InputPipeline” (HDL Coder). |
| OutputPipeline | Number of output pipeline stages to insert in the generated code. Distributed pipelining and constrained output pipelining can move these registers. The default is 0. For more details, see “OutputPipeline” (HDL Coder). |

Fixed-Point Conversion

Design and simulate fixed-point systems using Fixed-Point Designer™.

See Also

Discrete State-Space | State-Space

Topics

“State”

“Fixed-Point Numbers”

Introduced before R2006a

Floating Scope and Scope Viewer

Display signals generated during simulation without signal lines

Library: Simulink / Sinks
HDL Coder / Sinks



Description

The Simulink Scope Viewer and Floating Scope block display time domain signals with respect to simulation time. The Scope Viewer and Floating Scope block have the same functionality as the Scope block, but they are not connected to signal lines.

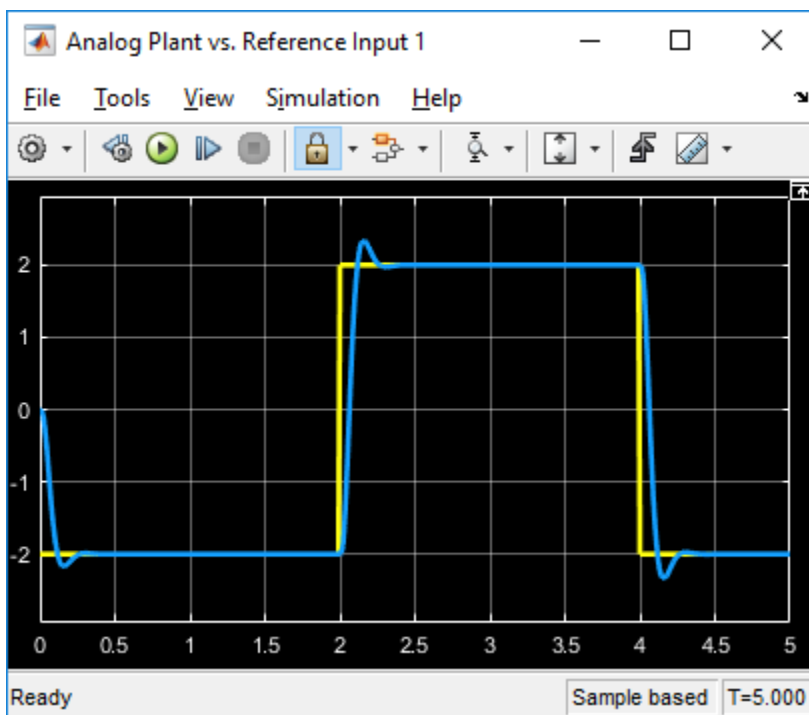

For information on controlling a Floating Scope block from the command line, see “Control Scope Blocks Programmatically” in the Simulink documentation.

Connect Signals

In the Floating Scope window or Scope viewer window, use the  button to connect signals.

To add a viewer with a connected signal, select a signal in the model. Then, on the **Simulation** tab, in the **Prepare** gallery, click **Add Viewer**.

For more details, see “Add Signals to an Existing Floating Scope or Scope Viewer”.

Key Features

- Multiple y-axes (displays) — Display multiple y-axes with multiple input ports. All the y-axes have a common time range on the x-axis.
- Multiple signals — Show multiple signals on the same y-axis (display) from one or more input ports.
- Modify parameters — Modify scope parameter values before and during a simulation.
- Display data after simulation — If a scope is closed at the start of a simulation, scope data is still written to the scope during the simulation. If you open the scope after a simulation, the scope displays simulation results for input signals.

Oscilloscope Measurements

- Triggers — Set triggers on repeating signals and pause the display when events occur.
- Cursor Measurements — Measure signal values using vertical and horizontal cursors.
- Signal Statistics¹ — Display the maximum, minimum, peak-to-peak difference, mean, median, and RMS values of a selected signal.
- Peak Finder^a — Find maxima, showing the x-axis values at which they occur.
- Bilevel Measurements^a — Measure transitions, overshoots, undershoots, and cycles.

Limitations

When you use model configuration parameters that optimize the simulation, such as **Signal storage reuse** or **Block reduction**, Simulink eliminates storage for some signals during simulation. You are unable to apply a Floating Scope to these eliminated signals. To work around this issue, configure an eliminated signal as a test point. You can then apply a Floating Scope to the signal regardless of optimization settings. To configure test points, see “Configure Signals as Test Points”.

- If you step back the simulation after adding or removing a signal, the Floating Scope clears the existing data. New data does not appear until the simulation steps forward again.
- When connected to a constant signal, the scope plots a single point.
- Simulink messages are not supported for Floating Scope block and Scope Viewer.
- You cannot connect signals from ForEach subsystems.
- Scope displays have limitations in Rapid Accelerator mode. See “Behavior of Scopes and Viewers with Rapid Accelerator Mode”

Ports

Input

Port_1 — Signal or signals to visualize

scalar | vector | matrix | array | bus | nonvirtual bus

Connect the signals you want to visualize. You can have up to 96 input ports. Input signals can have these characteristics:

1. You must have a Simscape™ or DSP System Toolbox license to use the Peak Finder, Bilevel Measurements, and Signal Statistics.

- **Type** — Continuous (sample-based) or discrete (sample-based and frame-based).
- **Data type** — Any data type that Simulink supports. See “Data Types Supported by Simulink”.
- **Dimension** — Scalar, one dimensional (vector), two dimensional (matrix), or multidimensional (array). Display multiple channels within one signal depending on the dimension. See “Signal Dimensions” and “Determine Signal Dimensions”.

Input Limitations

- When the input is a constant signal, the scope plots a single point.
- The scope shows gaps in the display when the signal value is NaN.
- When you visualize multiple frame-based signals in the scope, some samples of signals with a frame size of 1 might not be displayed. To visualize these signals, move the signals with frame size of 1 to a separate scope.

Bus Support

You can connect nonvirtual bus and arrays of bus signals to a scope. To display the bus signals, use normal or accelerator simulation mode. The scope displays each bus element signal in the order the elements appear in the bus, from the top to the bottom. Nested bus elements are flattened.

To log nonvirtual bus signals with a scope, set the **Save format** parameter to `Dataset`. You can use any **Save format** to log virtual bus signals.

Data Types: `single` | `double` | `half` | `int8` | `int16` | `int32` | `int64` | `uint8` | `uint16` | `uint32` | `uint64` | `Boolean` | `fixed point` | `enumerated` | `bus`

Properties

Configuration Properties

The Configuration Properties dialog box controls various properties about the scope displays. From the scope menu, select **View > Configuration Properties**.

Main

Open at simulation start — Specify when scope window opens

`off` (default) | `on`

Select this check box to open the scope window when simulation starts.

Programmatic Use

See `OpenAtSimulationStart`.

Display the full path — Display block path on scope title bar

`off` (default) | `on`

Select this check box to display the block path in addition to the block name.

Layout — Number and arrangement of displays

1-by-1 display (default) | an arrangement of m -by- n displays

Specify number and arrangement of displays. To expand the layout grid beyond 4 by 4, click within the dialog box and drag. The maximum layout is 16 rows by 16 columns.

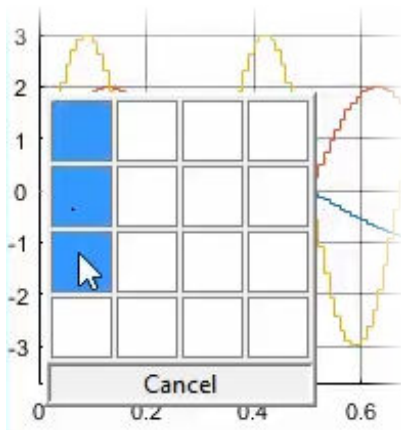

If the number of displays is equal to the number of ports, signals from each port appear on separate displays. If the number of displays is less than the number of ports, signals from additional ports appear on the last display. For layouts with multiple columns and rows, ports are mapped down and then across.

Programmatic Use

See `LayoutDimensions`.

Input processing — Channel or element signal processing

Elements as channels (sample based) (default) | Columns as channels (frame based)

- Elements as channels (sample based) — Process each element as a unique sample.
- Columns as channels (frame based) — Process signal values in a column as a group of values from multiple time intervals. Frame-based processing is available only with discrete input signals.

Programmatic Use

See `FrameBasedProcessing`.

Maximize axes — Maximize size of plots

Off (default) | Auto | On

- Auto — If “Title” on page 1-0 and “Y-label” on page 1-0 properties are not specified, maximize all plots.
- On — Maximize all plots. Values in **Title** and **Y-label** are hidden.
- Off — Do not maximize plots.

Programmatic Use

See `MaximizeAxes`.

Time

Time span — Length of x-axis to display

Auto (default) | User defined | One frame period

- Auto — Difference between the simulation start and stop times.

The block calculates the beginning and end times of the time range using the “Time display offset” on page 1-0 and “Time span” on page 1-0 properties. For example, if you set the **Time display offset** to 10 and the **Time span** to 20, the scope sets the time range from 10 to 30.

- **User defined** — Enter any value less than the total simulation time.
- **One frame period** — Use the frame period of the input signal to the Time Scope block. This option is only available when the **Input processing** parameter is set to **Columns as channels** (frame based).

Programmatic Use

See `TimeSpan`.

Time span overrun action — Display data beyond visible x-axis

`Wrap` (default) | `Scroll`

Specify how to display data beyond the visible x-axis range.

You can see the effects of this option only when plotting is slow with large models or small step sizes.

- **Wrap** — Draw a full screen of data from left to right, clear the screen, and then restart drawing the data from the left.
- **Scroll** — Move data to the left as new data is drawn on the right. This mode is graphically intensive and can affect run-time performance.

Programmatic Use

See `TimeSpanOverrunAction`.

Time units — x-axis units

`None` (default for Scope) | `Metric` (default for Time Scope) | `Seconds`

- **Metric** — Display time units based on the length of “Time span” on page 1-0 .
- **Seconds** — Display time in seconds.
- **None** — Do not display time units.

Programmatic Use

See `TimeUnits`.

Time display offset — x-axis offset

`0` (default) | `scalar` | `vector`

Offset the x-axis by a specified time value, specified as a real number or vector of real numbers.

For input signals with multiple channels, you can enter a scalar or vector:

- **Scalar** — Offset all channels of an input signal by the same time value.
- **Vector** — Independently offset the channels.

Programmatic Use

See `TimeDisplayOffset`.

Time-axis labels — Display of x-axis labels

`Bottom Displays Only` (default for Scope) | `All` (default for Time Scope) | `None`

Specify how x-axis (time) labels display:

- All — Display x-axis labels on all y-axes.
- None — Do not display labels. Selecting None also clears the **Show time-axis label** check box.
- Bottom displays only — Display x-axis label on the bottom y-axis.

Dependencies

To enable this property, set:

- “Show time-axis label” on page 1-0 to on.
- “Maximize axes” on page 1-0 to off.

The “Active display” on page 1-0 property determines which display is affected.

Programmatic Use

See TimeAxisLabels.

Show time-axis label — Display or hide x-axis labels

off (default for Scope) | on (default for Time Scope)

Select this check box to show the x-axis label for the active display

Dependencies

To enable this property, set “Time-axis labels” on page 1-0 to All or Bottom Displays Only.

The “Active display” on page 1-0 property determines which display is affected.

Programmatic Use

See ShowTimeAxisLabel.

Display

Active display — Selected display

1 (default) | positive integer

Selected display. Use this property to control which display is changed when changing style properties and axes-specific properties.

Specify the desired display using a positive integer that corresponds to the column-wise placement index. For layouts with multiple columns and rows, display numbers are mapped down and then across.

Programmatic Use

See ActiveDisplay.

Title — Display name

%<SignalLabel> (default) | string

Title for a display. The default value %<SignalLabel> uses the input signal name for the title.

Dependency

The “Active display” on page 1-0 property determines which display is affected.

Programmatic Use

See Title.

Show Legend — Display signal legend

off (default) | on

Toggle signal legend. The names listed in the legend are the signal names from the model. For signals with multiple channels, a channel index is appended after the signal name. Continuous signals have straight lines before their names, and discrete signals have step-shaped lines.

From the legend, you can control which signals are visible. This control is equivalent to changing the visibility in the **Style** properties. In the scope legend, click a signal name to hide the signal in the scope. To show the signal, click the signal name again. To show only one signal, right-click the signal name, which hides all other signals. To show all signals, press **Esc**.

Note The legend only shows the first 20 signals. Any additional signals cannot be controlled from the legend.

Dependency

The “Active display” on page 1-0 property determines which display is affected.

Programmatic Use

See ShowLegend.

Show grid — Show internal grid lines

on (default) | off

Select this check box to show grid lines.

Dependency

The “Active display” on page 1-0 property determines which display is affected.

Programmatic Use

See ShowGrid.

Plot signals as magnitude and phase — Split display into magnitude and phase plots

off (default) | on

- On — Display magnitude and phase plots. If the signal is real, plots the absolute value of the signal for the magnitude. The phase is 0 degrees for positive values and 180 degrees for negative values. This feature is useful for complex-valued input signals. If the input is a real-valued signal, selecting this check box returns the absolute value of the signal for the magnitude.
- Off — Display signal plot. If the signal is complex, plots the real and imaginary parts on the same y-axis.

Dependency

The “Active display” on page 1-0 property determines which display is affected.

Programmatic Use

See `PlotAsMagnitudePhase`.

Y-limits (Minimum) — Minimum y-axis value

-10 (default) | real scalar

Specify the minimum value of the y-axis as a real number.

Tunable: Yes

Dependency

If you select **Plot signals as magnitude and phase**, this property only applies to the magnitude plot. The y-axis limits of the phase plot are always [-180 180].

The “Active display” on page 1-0 `property` determines which display is affected.

Programmatic Use

See `YLimits`.

Y-limits (Maximum) — Maximum y-axis value

10 (default) | real scalar

Specify the maximum value of the y-axis as a real number.

Tunable: Yes

Dependency

If you select **Plot signals as magnitude and phase**, this property only applies to the magnitude plot. The y-axis limits of the phase plot are always [-180 180].

The “Active display” on page 1-0 `property` determines which display is affected.

Programmatic Use

See `YLimits`.

Y-label — Y-axis label

none (default for Scope) | Amplitude (default for Time Scope) | string

Specify the text to display on the y-axis. To display signal units, add (`%<SignalUnits>`) to the label. At the beginning of a simulation, Simulink replaces (`%SignalUnits`) with the units associated with the signals.

Example: For a velocity signal with units of m/s, enter `Velocity (%<SignalUnits>)`.

Dependency

If you select **Plot signals as magnitude and phase**, this property does not apply. The y-axes are labeled Magnitude and Phase.

The “Active display” on page 1-0 `property` determines which display is affected.

Programmatic Use

See `YLabel`.

Logging

Limit data points to last — Limit buffered data values

off (default) | on

Limit buffered data values before plotting and saving signals. Data values are from the end of a simulation. To use this property, you must also specify the number of data values by entering a positive integer in the text box.

- On — Specify the number of data values saved for each signal (5000 by default). If the signal is frame-based, the number of buffered data values is the specified number of data values multiplied by the frame size.

For simulations with **Stop time** set to `inf`, consider selecting **Limit data points to last**.

Sometimes, selecting this parameter cause signals to be plotted for less than the entire time range of a simulation. For example, where the sample time is small. If a scope plots a portion of your signals, consider increasing the number of data values the simulation saves.

- Off — Save and plot all data values. Clearing **Limit data points to last** can cause an out-of-memory error for simulations that generate a large amount of data or for systems without enough available memory.

Dependency

To enable this property, select “Log data to workspace” on page 1-0 .

This property limits the data values plotted in the scope and the data values saved to a MATLAB variable specified in “Variable name” on page 1-0 .

Programmatic Use

See `DataLoggingLimitDataPoints` and `DataLoggingMaxPoints`.

Decimation — Reduce amount of scope data to display and save

off (default) | on

- On — Plot and log (save) scope data every N^{th} data point, where N is the decimation factor entered in the text box. The default decimation factor is 2. A value of 1 buffers all data values.
- Off — Save all scope data values.

Dependency

To enable this property, select “Log data to workspace” on page 1-0 .

This property limits the data values plotted in the scope and the data values saved to a MATLAB variable specified in “Variable name” on page 1-0 .

Programmatic Use

See `DataLoggingDecimateData` and `DataLoggingDecimation`.

Log/Unlog Viewed Signals to Workspace — Toggle logging

on | off

For signals selected with the Signal Selector, clicking this button toggles the state of the **Log signal data** check boxes in the Signals Properties dialog boxes.

Axes Scaling Properties

The Axes Scaling Properties dialog controls the axes limits of the scope. To open the Axes Scaling properties, in the scope menu, select **Tools > Axes Scaling > Axes Scaling Properties**.

Axes scaling — Y-axis scaling mode

Manual (default) | Auto | After N Updates

- Manual — Manually scale the y-axis range with the **Scale Y-axis Limits** toolbar button.
- Auto — Scale the y-axis range during and after simulation. Selecting this option displays the **Do not allow Y-axis limits to shrink** check box. If you want the y-axis range to increase and decrease with the maximum value of a signal, set **Axes scaling** to Auto and clear the **Do not allow Y-axis limits to shrink** check box.
- After N Updates — Scale y-axis after the number of time steps specified in the **Number of updates** text box (10 by default). Scaling occurs only once during each run.

Programmatic Use

See AxesScaling.

Do not allow Y-axis limits to shrink — When y-axis limits can change

on (default) | off

Allow y-axis range limits to increase but not decrease during a simulation.

Dependency

To use this property, set **Axes scaling** to Auto.

Number of updates — Number of updates before scaling

10 (default) | integer

Set this property to delay auto scaling the y-axis.

Dependency

To use this property, set **Axes scaling** to After N Updates.

Programmatic Use

See AxesScalingNumUpdates.

Scale axes limits at stop — When y-axis limits can change

on (default) | off

- On — Scale axes when simulation stops.
- Off — Scale axes continually.

Dependency

To use this property, set **Axes scaling** to Auto.

Y-axis Data range (%) — Percent of y-axis to use for plotting

80 (default) | integer between [1, 100]

Specify the percentage of the y-axis range used for plotting data. If you set this property to 100, the plotted data uses the entire y-axis range.

Y-axis Align — Alignment along y-axis

Center (default) | Top | Bottom

Specify where to align plotted data along the y-axis data range when **Y-axis Data range** is set to less than 100 percent.

- Top — Align signals with the maximum values of the y-axis range.
- Center — Center signals between the minimum and maximum values.
- Bottom — Align signals with the minimum values of the y-axis range.

Autoscale X-axis limits — Scale x-axis range limits

off (default) | on

Scale x-axis range to fit all signal values. If **Axes scaling** is set to Auto, the data currently within the axes is scaled, not the entire signal in the data buffer.

X-axis Data range (%) — Percent of x-axis to use for plotting

100 (default) | integer in the range [1, 100]

Specify the percentage of the x-axis range to plot data on. For example, if you set this property to 100, plotted data uses the entire x-axis range.

X-axis Align — Alignment along x-axis

Center (default) | Top | Bottom

Specify where to align plotted data along the x-axis data range when **X-axis Data range** is set to less than 100 percent.

- Top — Align signals with the maximum values of the x-axis range.
- Center — Center signals between the minimum and maximum values.
- Bottom — Align signals with the minimum values of the x-axis range.

Style Properties

To open the Style dialog box, from the scope menu, select **View > Style**.

Figure color — Background color for window

black (default) | color

Background color for the scope.

Plot type — How to plot signal

Auto (default for Scope) | Line (default for Time Scope) | Stairs | Stem

When you select Auto, the plot type is a line graph for continuous signals, a stair-step graph for discrete signals, and a stem graph for Simulink message signals.

Axes colors — Background and axes color for individual displays

black (default) | color

Select the background color for axes (displays) with the first color palette. Select the grid and label color with the second color palette.

Preserve colors for copy to clipboard — Copy scope without changing colors

off (default) | on

Specify whether to use the displayed color of the scope when copying.

When you select **File > Copy to Clipboard**, the software changes the color of the scope to be printer friendly (white background, visible lines). If you want to copy and paste the scope with the colors displayed, select this check box.

Properties for line – Line to change

Channel 1 (default)

Select active line for setting line style properties.

Visible – Line visibility

on (default) | off

Show or hide a signal on the plot.

Dependency

The values of “Active display” on page 1-0 and “Properties for line” on page 1-0 determine which line is affected.

Line – Line style

solid line (default style) | 0.75 (default width) | yellow (default color)

Select line style, width, and color.

Dependency

The values of “Active display” on page 1-0 and “Properties for line” on page 1-0 determine which line is affected.

Marker – Data point marker style

None (default) | marker shape

Select marker shape.

Dependency

The values of “Active display” on page 1-0 and “Properties for line” on page 1-0 determine which line is affected.

Block Characteristics

| | |
|---------------------------------|--|
| Data Types | Boolean double enumerated fixed point integer single |
| Direct Feedthrough | no |
| Multidimensional Signals | yes |
| Variable-Size Signals | yes |
| Zero-Crossing Detection | no |

Extended Capabilities

C/C++ Code Generation

Generate C and C++ code using Simulink® Coder™.

This block can be used for simulation visibility in systems that generate code, but is not included in the generated code.

HDL Code Generation

Generate Verilog and VHDL code for FPGA and ASIC designs using HDL Coder™.

This block can be used for simulation visibility in subsystems that generate HDL code, but is not included in the hardware implementation.

PLC Code Generation

Generate Structured Text code using Simulink® PLC Coder™.

This block can be used for simulation visibility in systems that generate code, but is not included in the generated code.

Fixed-Point Conversion

Design and simulate fixed-point systems using Fixed-Point Designer™.

This block accepts fixed-point input, but converts it to `double` for display.

See Also

Blocks

Scope

Topics

“Scope Blocks and Scope Viewer Overview”

“Common Scope Block Tasks”

“Simulate a Model Interactively”

“Step Through a Simulation”

“Monitor Test Points in Stateflow Charts” (Stateflow)

Introduced in R2015b

For Each

Control block for For Each subsystem

Description

The For Each block serves as a control block for the For Each Subsystem block. Specifically, the For Each block enables the blocks inside the For Each subsystem to process the elements of either input signals or mask parameters independently. Each block inside this subsystem that has states maintains a separate set of states for each element or subarray that it processes. As the set of blocks in the subsystem processes the elements or subarrays, the subsystem concatenates the results to form output signals.

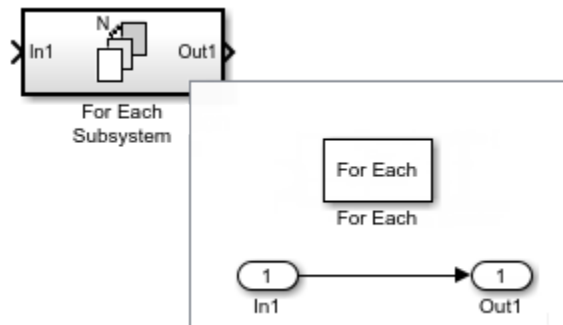

Use a For Each subsystem to iteratively compute outputs after changing inputs or mask parameters. To do so, configure the partitioning of input signals or mask parameters in the For Each block dialog box.

Partition Input Signals to the Subsystem

To specify which input signals to partition for each iteration in a For Each subsystem, use the **Input Partition** tab in the dialog box of the For Each block. When specifying a signal to be partitioned, specify the **Partition Dimension**, **Partition Width**, and **Partition Offset** parameters.

Partition Mask Parameters of the Subsystem

You can partition the mask parameters of a For Each Subsystem block. Partitioning is useful for systems that have identical structures in each iteration but different parameter values. In this case, changing the model to partition extra input signals for each parameter is cumbersome. Instead, add a mask parameter to a For Each subsystem. For more information, see "Create a Simple Mask". To select the mask parameter for partitioning, use the **Parameter Partition** tab of the For Each block dialog box. For more information, see "Select Partition Parameters" on page 1-603, below.

Concatenate Output

Define the dimension along which to concatenate the results by specifying the **Concatenation Dimension** in the **Output Concatenation** tab.

The results generated by the block for each subarray are stacked along the concatenation dimension. By default, dimension 1 (y-axis) is used, meaning that the results are stacked vertically. However, if you specify a concatenation dimension of 2, the results concatenate along the horizontal direction (x-

axis). Thus, if the process generates row vectors, then the concatenated result is a matrix in the first case and a row vector in the second case.

Select Partition Parameters

When selecting an input signal or subsystem mask parameter for partitioning, you need to specify how to decompose it into elements or subarrays for each iteration. Do this by setting integer values for the **Partition Dimension**, **Partition Width**, and **Partition Offset** parameters.

As an illustration, consider an input signal matrix A of the form:

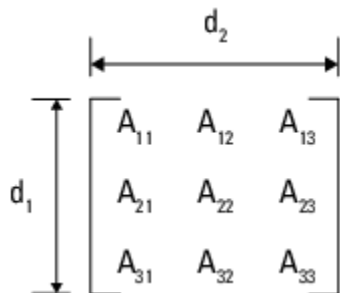

The labels d_1 and d_2 , respectively, define dimensions 1 and 2. If you retain the default setting of 1 for both the partition dimension and the partition width, and 0 for the partition offset, then Simulink slices perpendicular to partition dimension 1 at a width equal to the partition width, that is one element:

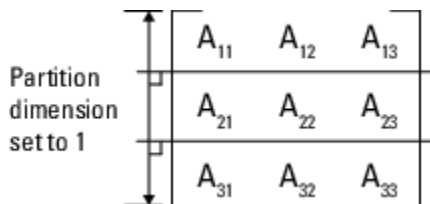

Matrix A decomposes into these three row vectors:

$$\begin{bmatrix} A_{11} & A_{12} & A_{13} \end{bmatrix}$$

$$\begin{bmatrix} A_{21} & A_{22} & A_{23} \end{bmatrix}$$

$$\begin{bmatrix} A_{31} & A_{32} & A_{33} \end{bmatrix}$$

If instead you specify 2 as the partition dimension, Simulink slices perpendicular to dimension 2 to form three column vectors:

$$\begin{bmatrix} A_{11} \\ A_{21} \\ A_{31} \end{bmatrix} \quad \begin{bmatrix} A_{12} \\ A_{22} \\ A_{32} \end{bmatrix} \quad \begin{bmatrix} A_{13} \\ A_{23} \\ A_{33} \end{bmatrix}$$

In addition to setting the **Partition Dimension** to 2, if you set the **Partition Width** to 2 and the **Partition Offset** to -1, Simulink uses two overlapping 3-by-2 partitions for processing.

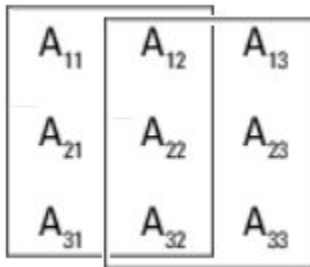

For an example using the **Partition Offset** parameter, see “Neighborhood Processing Using For Each Subsystems” on page 13-480.

By default, all partitions of the input signal or mask parameter are processed. To process a subset of the partitions, enter the number of partitions to process as the **Number of iterations**. In the matrix examples above, if **Partition Offset** is set to 0 (the default) and **Number of iterations** is set to 2, only the first 2 rows or columns of the input matrix A are processed.

Note Only signals are considered one-dimensional in Simulink. Mask parameters are row or column vectors, according to their orientation. To partition a row vector, specify the partition dimension as 2 (along the columns). To partition a column vector, specify the partition dimension as 1 (along the rows).

Ports

Output

Partition index — Index of current partition

scalar

Index of current partition (starting at zero), returned as a scalar.

Dependencies

To enable this port, select **Show partition index output port**.

Data Types: int32 | double

Parameters

Input Partition Tab

Select each input signal you want to partition and specify the corresponding **Partition Dimension**, **Partition Width**, and **Partition offset** parameters. See the Inport block reference page for more information.

Port — List of input ports

no default (default) | input port name

This property is read-only.

List of input ports connected to the For Each Subsystem block.

Partition — Select input port signals to partition

off (default) | on

Select input port signals connected to the For Each Subsystem block to partition into subarrays or elements. For each port listed in the **Port** column, select the corresponding check box to partition that signal.

Programmatic Use

Block Parameter: InputPartition

Type: character vector

Values: 'off' | 'on'

Default: 'off'

Partition Dimension — Specify dimension

1 (default) | 2 | positive integer

Specify the dimension through which to slice the selected input signal array. The resulting slices are perpendicular to the dimension that you specify. The slices partition the array into subarrays or elements, as appropriate.

1

Slice input array along the columns.

2

Slice input array along the rows.

n

Slice input array along dimension n.

Dependencies

To enable this parameter, select **Partition** for the relevant input port.

Programmatic Use

Block Parameter: InputPartitionDimension

Type: character vector

Values: '1' | '2' | '<positive integer>'

Default: '1'

Partition Width — Specify width

1 (default) | positive integer

Specify the width of each partition slice of the selected input signal.

Dependencies

To enable this parameter, select **Partition** for the relevant input port.

Programmatic Use

Block Parameter: InputPartitionWidth

Type: character vector

Values: '1' | '<integer>'

Default: '1'

Partition Offset — Specify partition offset

0 (default) | integer

Specify the offset for each partition slice of the selected input signal.

0

No offset between partition slices, that is, partition slices have no gaps between them and do not overlap.

integer

Specify partition offset, using a positive integer to specify a gap between slices or a negative integer to indicate an overlap. The sum of the **Partition Width** and the **Partition Offset** must be a positive integer.

For example, a **Partition Width** of 3 and a **Partition Offset** of -2 indicates that each 3-element slice overlaps its neighboring slices by 2 elements; whereas a **Partition Width** of 2 and a **Partition Offset** of 1 indicates that there is a 1-element-wide gap between each pair of neighboring 2-element-wide slices.

Dependencies

To enable this parameter, select **Partition** for the relevant input port.

Programmatic Use

Block Parameter: InputPartitionOffset

Type: character vector

Values: '0' | '<integer>'

Default: '0'

Parameter Partition Tab

Select each mask parameter you want to partition and specify the corresponding **Partition Dimension** and **Partition Width** parameters.

Parameter — List of mask parameters

parameter name

This property is read-only.

List of mask parameters for the For Each Subsystem block. Mask parameters appear in the list only if you have added an editable parameter to the mask of the For Each Subsystem block. See “Create Block Masks”.

Partition — Select mask parameters to partition

off (default) | on

Select mask parameters for the For Each Subsystem block to partition into subarrays or elements. For each port listed in the **Parameter** column, select the corresponding check box to partition that mask parameter.

Programmatic Use

Block Parameter: SubsysMaskParameterPartition

Type: character vector

Values: 'off' | 'on'

Default: 'off'

Partition Dimension — Specify dimension

1 (default) | 2 | positive integer

Specify the dimension through which to slice the selected mask parameter array. The resulting slices are perpendicular to the dimension that you specify. The slices partition the array into subarrays or elements, as appropriate.

1

Slice mask parameter array along the columns.

2

Slice mask parameter array along the rows.

n

Slice mask parameter array along dimension n.

Dependencies

To enable this parameter, select **Partition** for the relevant mask parameter.

Programmatic Use

Block Parameter: SubsysMaskParameterPartitionDimension

Type: character vector

Values: '1' | '<integer>'

Default: '1'

Partition Width — Specify partition width

1 (default) | positive integer

Specify the width of each partition slice of the selected mask parameter array.

Dependencies

To enable this parameter, select **Partition** for the relevant mask parameter.

Programmatic Use

Block Parameter: SubsysMaskParameterPartitionWidth

Type: character vector

Values: '1' | '<positive integer>'

Default: '1'

Output Concatenation Tab

For each output port, specify the dimension along which to stack (concatenate) the For Each Subsystem block results. See the Outputport block reference page for more information.

Port — List of output ports

none (default) | output port name

This property is read-only.

List of output ports connected to the For Each Subsystem block.

Concatenation Dimension — Specify dimension

1 (default) | 2 | positive integer

For each output port, specify the dimension along which to stack the results of the For Each Subsystem block .

1

Stack the results in the d_1 direction, that is, vertically. If the block generates column vectors, the concatenation process results in a single column vector. If the block generates row vectors, the concatenation process results in a matrix.

2

Stack the results in the d_2 direction, that is, horizontally. If the block generates row vectors, the concatenation process results in a single row vector. If the block generates row vectors, the concatenation process results in a matrix.

n

Stack the results in the d_n direction.

Programmatic Use

Block Parameter: OutputConcatenationDimension

Type: character vector

Values: '1' | '<integer>'

Default: '1'

Other Parameters

Show partition index output port (zero-based indexing) — Control display of output port

off (default) | on

Control display of output port for partition index.

off

Hide output port.

on

Display output port on block.

Programmatic Use

Block Parameter: ShowIterationIndex

Type: character vector

Values: 'off' | 'on'

Default: 'off'

Partition index output data type — Specify partition index data type

'int32' (default) | 'double'

Specify partition index data type for output port.

int32

Select signed 32-bit integer.

double

Select double real.

Dependencies

To enable this parameter, select **Show partition index output port**.

Programmatic Use**Block Parameter:** IterationIndexDataType**Type:** character vector**Values:** 'int32' | 'double'**Default:** 'int32'**Number of iterations — Specify number of partitions to process**

-1 (default) | integer

To process a subset of data, specify the number of partition slices of the input signal or mask parameter array to process, else specify -1 to process all slices. The number must not be greater than the total number of slices available.

-1

Process all slices

integer

Number of slices to process

For example, a **Number of iterations** of 3 indicates that only the first 3 slices are to be processed.

Programmatic Use**Block Parameter:** SpecifiedNumIters**Type:** character vector**Values:** '-1' | '<integer>'**Default:** '-1'**See Also****Blocks**

For Each Subsystem | Subsystem

Topics

"Repeat an Algorithm Using a For Each Subsystem"

"Log Signals in For Each Subsystems"

Introduced in R2010a

For Each Subsystem

Apply algorithm to individual elements or subarrays of input signals or mask parameters

Library: Simulink / Ports & Subsystems
HDL Coder / Ports & Subsystems



Description

The For Each Subsystem block is a Subsystem block preconfigured as a starting point for creating a subsystem that repeats execution during a simulation time step on each element or subarray of an input signal or mask parameter array.

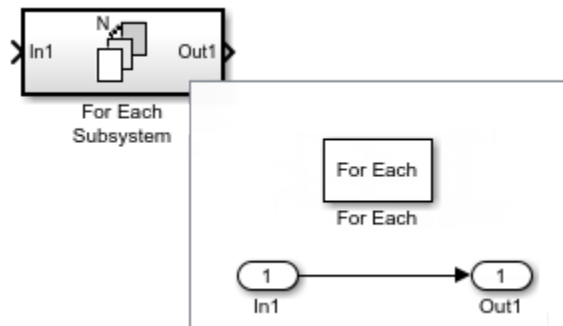

The set of blocks within the subsystem represents the algorithm applied to a single element or subarray of the original signal or mask parameter array. Inside the subsystem, each block that has states maintains separate sets of states for each element or subarray that it processes. Consequently, the operation of this subsystem is similar in behavior to copying the contents of the subsystem for each element in the original input signal or mask parameter array and then processing each element using its respective copy of the subsystem. As the set of blocks in the subsystem processes the elements or subarrays, the subsystem concatenates the results to form output signals.

Configuring the Subsystem

The For Each Subsystem block contains a For Each block that acts as a control block for the subsystem. Specify the parameters of the For Each block to configure the decomposition of the subsystem inputs or mask parameters into elements or subarrays and to configure the concatenation of the individual results into output signals. The block parameters **Partition Dimension** and **Partition Width** specify the dimension through which to slice the input signal or mask parameter array and the width of each slice, respectively. To partition a row vector, specify the **Partition Dimension** as 2. To partition a column vector, specify the **Partition Dimension** as 1. Use the parameter **Partition Offset** to specify a gap or an overlap between partitions. Specify a **Number of iterations** to limit processing to a subset of the data. To learn more about the block parameters, see For Each.

Partition Input Signals to the Subsystem

To specify which input signals to partition for each iteration in a For Each subsystem, use the **Input Partition** tab in the dialog box of the For Each block. When specifying a signal to be partitioned, specify the **Partition Dimension**, **Partition Width**, and **Partition Offset** parameters.

Partition Mask Parameters of the Subsystem

You can partition the mask parameters of a For Each Subsystem block. Partitioning is useful for systems that have identical structures in each iteration but different parameter values. In this case, changing the model to partition extra input signals for each parameter is cumbersome. Instead, add a mask parameter to a For Each subsystem. For more information, see “Create a Simple Mask”. To select the mask parameter for partitioning, use the **Parameter Partition** tab of the For Each block dialog box. For more information, see “Select Partition Parameters” on page 1-603, below.

Concatenate Output

Define the dimension along which to concatenate the results by specifying the **Concatenation Dimension** in the **Output Concatenation** tab.

The results generated by the block for each subarray are stacked along the concatenation dimension. By default, dimension 1 (y-axis) is used, meaning that the results are stacked vertically. However, if you specify a concatenation dimension of 2, the results concatenate along the horizontal direction (x-axis). Thus, if the process generates row vectors, then the concatenated result is a matrix in the first case and a row vector in the second case.

Select Partition Parameters

When selecting an input signal or subsystem mask parameter for partitioning, you must specify how to decompose it into elements or subarrays for each iteration. Set integer values for the **Partition Dimension**, **Partition Width**, and **Partition Offset** parameters.

As an illustration, consider an input signal matrix A of the form:

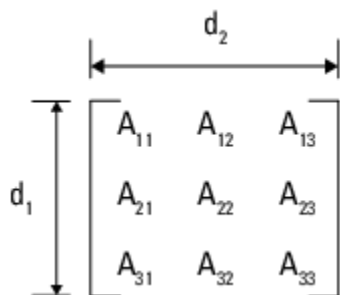

The labels d_1 and d_2 define dimensions 1 and 2, respectively. If you retain the default setting of 1 for both the partition dimension and the partition width and 0 for the partition offset, then Simulink slices perpendicular to partition dimension 1 at a width equal to the partition width, that is one element:

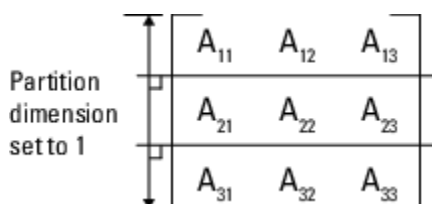

Matrix A decomposes into these three row vectors:

$$\begin{bmatrix} A_{11} & A_{12} & A_{13} \end{bmatrix}$$

$$\begin{bmatrix} A_{21} & A_{22} & A_{23} \end{bmatrix}$$

$$\begin{bmatrix} A_{31} & A_{32} & A_{33} \end{bmatrix}$$

If you specify 2 as the partition dimension instead, Simulink slices perpendicular to dimension 2 to form three column vectors:

$$\begin{bmatrix} A_{11} \\ A_{21} \\ A_{31} \end{bmatrix} \quad \begin{bmatrix} A_{12} \\ A_{22} \\ A_{32} \end{bmatrix} \quad \begin{bmatrix} A_{13} \\ A_{23} \\ A_{33} \end{bmatrix}$$

In addition to setting the **Partition Dimension** to 2, if you set the **Partition Width** to 2 and the **Partition Offset** to -1, Simulink uses two overlapping 3-by-2 partitions for processing.

$$\begin{array}{|c|c|c|} \hline A_{11} & A_{12} & A_{13} \\ \hline A_{21} & A_{22} & A_{23} \\ \hline A_{31} & A_{32} & A_{33} \\ \hline \end{array}$$

For an example using the **Partition Offset** parameter, open the model `slxForEachOverlapExample`.

By default, all partitions of the input signal or mask parameter are processed. To process a subset of the partitions, enter the number of partitions to process as the **Number of iterations**. In the matrix examples above, if **Partition Offset** is set to 0 (the default) and **Number of iterations** is set to 2, only the first 2 rows or columns of the input matrix A are processed.

Note Only signals are considered one-dimensional in Simulink. Mask parameters are row or column vectors, according to their orientation. To partition a row vector, specify the partition dimension as 2, along the columns. To partition a column vector, specify the partition dimension as 1, along the rows.

Code Reuse Support

For certain models, the For Each Subsystem block improves code reuse in Simulink Coder generated code. Consider a model containing two reusable Atomic Subsystem blocks with the same scalar algorithm applied to each element of the signal. If the input signal dimensions of these subsystems are different, Simulink Coder generated code includes two distinct functions. You can replace these two subsystems with two identical For Each Subsystem blocks that are configured to process each

element of their respective inputs using the same algorithm. In this case, Simulink Coder generated code consists of a single function parameterized by the number of input signal elements. This function is invoked twice, once for each unique instance of the For Each Subsystem block in the model. For each of these cases, the input signal elements have different values.

Multicore Execution Support

When you simulate your model in rapid accelerator mode, Simulink uses multicore execution for faster simulation of For Each subsystems. Simulink automatically profiles each eligible For Each subsystem the first two time steps it runs in rapid accelerator mode to compare parallel and serial execution times. Simulink then designates the For Each subsystem for parallel, multicore execution in subsequent time steps of the simulation run if doing so would speed up execution time. For nested For Each subsystems, multicore execution applies only to the top-level subsystem. Multicore execution does not apply to For Each subsystems containing continuous states or Function Caller blocks.

To suppress multicore execution for a given For Each subsystem, set the `MultithreadedSim` parameter of the For Each block within the subsystem to `'off'`.

```
set_param(ForEachBlockName, 'MultithreadedSim', 'off')
```

Note that this is a parameter of the For Each block within the subsystem, not the For Each Subsystem block itself. To suppress multicore execution for all For Each subsystems in a model, set the `MultithreadedSim` parameter of the model to `'off'`.

```
set_param(ModelName, 'MultithreadedSim', 'off')
```

To re-enable multicore execution, set the relevant `MultithreadedSim` parameter to its default value of `'auto'`.

For an example, see “Multithreaded Simulation using For Each Subsystem”.

Note If you simulate your model in rapid accelerator mode or generate code from your model, and you partition mask parameters in a For Each subsystem, then any expression inside the For Each subsystem that references a partitioned parameter must be a tunable expression. See “Tunable Expression Limitations” (Simulink Coder).

S-Function Support

The For Each Subsystem block supports both C-MEX S-functions and Level-2 MATLAB S-functions, provided that the S-function supports multiple execution instances using one of these techniques:

- A C-MEX S-function must declare `ssSupportsMultipleExecInstances(S, true)` in the `mdlSetWorkWidths` method.
- A Level-2 MATLAB S-function must declare `block.SupportsMultipleExecInstances = true` in the `setup` method.

If you use these specifications:

- Do not cache run-time data such as `DWork` and Block I/O using global or persistent variables or within the user data of the S-function.
- In a For Each Subsystem block, every S-function execution method from `mdlStart` up to `mdlTerminate` is called once for each element processed by the S-function. Consequently, you

must make sure not to free the same memory on repeated calls to `mdlTerminate`. For example, consider a C-MEX S-function that allocates memory for a run-time parameter within `mdlSetWorkWidths`. The memory only needs to be freed once in `mdlTerminate`. As a solution, set the pointer to be empty after the first call to `mdlTerminate`.

Limitations

For information regarding limitations of the For Each Subsystem block, see “Limitations of For Each Subsystem”.

Ports

Input

In — Signal input to Subsystem block

scalar | vector | matrix

Signal input to a Subsystem block, specified as a scalar, vector, or matrix. Placing an Inport block in a Subsystem block adds an external input port to the block. The port label matches the name of the Inport block.

Use Inport blocks to receive signals from the local environment.

Data Types: half | single | double | int8 | int16 | int32 | int64 | uint8 | uint16 | uint32 | uint64 | Boolean | fixed point | enumerated | bus

Output

Out — Signal output from Subsystem block

scalar | vector | matrix

Signal output from a Subsystem block, returned as a scalar, vector, or matrix. Placing an Outport block in a Subsystem block adds an external output port to the block. The port label matches the name of the Outport block.

Use Outport blocks to send signals to the local environment.

Data Types: half | single | double | int8 | int16 | int32 | int64 | uint8 | uint16 | uint32 | uint64 | Boolean | fixed point | enumerated | bus

Block Characteristics

| | |
|---------------------------------|---|
| Data Types | Boolean ^a bus ^a double ^a enumerated ^a fixed point ^a half ^a integer ^a single ^a |
| Direct Feedthrough | no |
| Multidimensional Signals | limited ^a |
| Variable-Size Signals | no |
| Zero-Crossing Detection | no |

a. Actual data type or capability support depends on block implementation.

Extended Capabilities

C/C++ Code Generation

Generate C and C++ code using Simulink® Coder™.

Actual code generation support depends on block implementation.

HDL Code Generation

Generate Verilog and VHDL code for FPGA and ASIC designs using HDL Coder™.

HDL Coder provides additional configuration options that affect HDL implementation and synthesized logic.

When you generate HDL code for the For Each Subsystem, the code generator attempts to use a **for-generate** loop that iterates through elements of the input and output signals. The for-generate loop improves readability and reduces the number of lines of code, which could otherwise be hundreds of lines of code for large vector signals. The subsystem supports vector and 2D matrix input signals. See “Generate HDL Code for Blocks Inside For Each Subsystem” (HDL Coder).

You can use a nonzero partition offset for HDL code generation. The code generator supports a scalar, vector, or matrix as mask parameter values. You can generate HDL code for element, 1D, and 2D partitions of mask parameters inside a For Each Subsystem block. Inside the For Each Subsystem block, use the mask parameter as the **Constant value** parameter in Constant blocks or as the **Gain** parameter in Gain blocks.

Limitations

- You cannot use the For Each Subsystem block as the DUT.
- You must clear the **Show partition index output port (zero-based indexing)** check box on the For Each block for HDL code generation.
- You cannot set the `SpecifiedNumIters` parameter of the For Each block for HDL code generation. HDL code generation returns an error when the value of `SpecifiedNumIters` is not equal to the default value of -1.

HDL Architecture

| Architecture | Description |
|------------------|--|
| Module (default) | Generate code for the subsystem and the blocks within the subsystem. |
| BlackBox | Generate a black box interface. The generated HDL code includes only the input/output port definitions for the subsystem. Therefore, you can use a subsystem in your model to generate an interface to existing, manually written HDL code. The black-box interface generation for subsystems is similar to the Model block interface generation without the clock signals. |
| No HDL | Remove the subsystem from the generated code. You can use the subsystem in simulation, however, treat it as a “no-op” in the HDL code. |

Black Box Interface Customization

For the BlackBox architecture, you can customize port names and set attributes of the external component interface. See “Customize Black Box or HDL Cosimulation Interface” (HDL Coder).

HDL Block Properties

| General | |
|----------------------------------|--|
| AdaptivePipelining | Automatic pipeline insertion based on the synthesis tool, target frequency, and multiplier word-lengths. The default is <code>inherit</code> . See also “AdaptivePipelining” (HDL Coder). |
| BalanceDelays | Detects introduction of new delays along one path and inserts matching delays on the other paths. The default is <code>inherit</code> . See also “BalanceDelays” (HDL Coder). |
| ClockRatePipelining | Insert pipeline registers at a faster clock rate instead of the slower data rate. The default is <code>inherit</code> . See also “ClockRatePipelining” (HDL Coder). |
| ConstrainedOutputPipeline | Number of registers to place at the outputs by moving existing delays within your design. Distributed pipelining does not redistribute these registers. The default is <code>0</code> . For more details, see “ConstrainedOutputPipeline” (HDL Coder). |
| DistributedPipelining | Pipeline register distribution, or register retiming. The default is <code>off</code> . See also “DistributedPipelining” (HDL Coder). |
| DSPStyle | Synthesis attributes for multiplier mapping. The default is <code>none</code> . See also “DSPStyle” (HDL Coder). |
| FlattenHierarchy | Remove subsystem hierarchy from generated HDL code. The default is <code>inherit</code> . See also “FlattenHierarchy” (HDL Coder). |
| InputPipeline | Number of input pipeline stages to insert in the generated code. Distributed pipelining and constrained output pipelining can move these registers. The default is <code>0</code> . For more details, see “InputPipeline” (HDL Coder). |
| OutputPipeline | Number of output pipeline stages to insert in the generated code. Distributed pipelining and constrained output pipelining can move these registers. The default is <code>0</code> . For more details, see “OutputPipeline” (HDL Coder). |
| SharingFactor | Number of functionally equivalent resources to map to a single shared resource. The default is <code>0</code> . See also “Resource Sharing” (HDL Coder). |
| StreamingFactor | Number of parallel data paths, or vectors, that are time multiplexed to transform into serial, scalar data paths. The default is <code>0</code> , which implements fully parallel data paths. See also “Streaming” (HDL Coder). |

Target Specification

This block cannot be the DUT, so the block property settings in the **Target Specification** tab are ignored.

Complex Data Support

The block does not support complex data signals for HDL code generation. To input complex signals, convert the complex signal to an array of signals, and then input to the block. To learn more, see “Generate HDL Code for Blocks Inside For Each Subsystem” (HDL Coder).

Fixed-Point Conversion

Design and simulate fixed-point systems using Fixed-Point Designer™.

Actual data type support depends on block implementation.

See Also

Blocks

For Each | Subsystem

Topics

“Repeat an Algorithm Using a For Each Subsystem”

“Log Signals in For Each Subsystems”

Introduced in R2010a

For Iterator

Control block for For Iterator subsystem

Description

The For Iterator block, when placed in a Subsystem block, repeats the execution of a subsystem during the current time step until an iteration variable exceeds the specified iteration limit. You can use this block to implement the block diagram equivalent of a `for` loop in a programming language.

The output of a For Iterator Subsystem block cannot be a function-call signal. Simulink displays an error message when the model updates.

Ports

Input

Number of Iterations — External value for iterator variable

scalar | vector, size 1 | matrix, size 1x1

- The input port accepts data of mixed numeric types.
- If the input port value is non-integer, it is first truncated to an integer.
- Internally, the input value is cast to an integer of the type specified for the iteration variable output port.
- If no output port is specified, the input port value is cast to type `int32`.
- If the input port value exceeds the maximum value of the output port type, the overflow wraps around.

Data Types: `single` | `double` | `int8` | `int16` | `int32` | `uint8` | `uint16` | `uint32`

Output

Iterator value — Value of iterator variable during time step

scalar | vector, size 1 | matrix, size 1-by-1

Selecting the **Show iteration variable** parameter check box adds an output port to this block.

Data Types: `double` | `int8` | `int16` | `int32` | `uint8` | `uint16` | `uint32`

Parameters

States when starting — Select block states between time steps

`held` (default) | `reset`

Select how to handle block states between time steps.

`held`

Hold block states between time steps. Block state values persist across time steps.

reset

Reset block states to their initial values at the beginning of each time step and before the first iteration loop.

Programmatic Use

Block Parameter: ResetStates

Type: character vector

Values: 'held' | 'reset'

Default: 'held'

Iteration limit source — Select source for number of iterations

internal (default) | external

Select source for number of iterations.

internal

Value of the **Iteration limit** parameter determines the number of iterations.

external

Value of the signal at the **N** port determines the number of iterations. The signal source must reside outside the For Iterator Subsystem block.

Dependencies

Selecting `internal` displays and enables the **Iteration limit** parameter. Selecting `external` adds an input port labeled **N**.

Programmatic Use

Block Parameter: IterationSource

Type: character vector

Values: 'internal' | 'external'

Default: 'internal'

Iteration limit — Specify number of iterations

5 (default) | integer

Specify the number of iterations. This parameter supports storage classes. You can define the named constant in the base workspace of the Model Explorer as a `Simulink.Parameter` object of the built-in storage class `Define` (custom) type.

5

Iterate blocks in the For Iterator Subsystem block 5 times.

integer

Specify an integer or a named constant variable.

Dependencies

To enable this parameter, select `internal` from the **Iteration limit source** drop-down list.

Programmatic Use

Block Parameter: IterationLimit

Type: character vector

Values: '5' | '<integer>'

Default: '5'

Set Next i (iteration variable) externally – Control display of input port

off (default) | on

Control display of an input port.

off

Remove input port.

on

Add input port labeled **Next_i** for connecting to an external iteration variable source. The value of the input at the current iteration is used as the value of the iteration variable at the next iteration.

Dependencies

To enable this parameter, select the **Show iteration variable** parameter which also displays an output port labeled **1:N**.

Programmatic Use

Block Parameter: ExternalIncrement

Type: character vector

Values: 'off' | 'on'

Default: 'off'

Show iteration variable – Control display of output port

on (default) | off

Control the display of an output port with the current iterator value for a loop.

on

Add output port labeled **1:N** to the For Iterator block.

off

Remove output port.

Dependencies

Selecting this parameter enables the **Set next i (iteration variable) externally** parameter.

Programmatic Use

Block Parameter: ShowIterationPort

Type: character vector

Value: 'on' | 'off'

Default: 'on'

Index mode – Select initial iteration number

One-based (default) | Zero-based

Select an initial iteration number of 0 or 1.

One-based

Iteration number starts at one.

Zero-based

Iteration number starts at zero.

Programmatic Use**Block Parameter:** IndexMode**Type:** character vector**Values:** 'One-based' | 'Zero-based'**Default:** 'One-based'**Iteration variable data type — Select data type**

int32 (default) | uint32 | int16 | uint16 | int8 | uint8 | double

Set the data type for the iteration value output from the iteration number port.

int32

Set data type to int32.

uint32

Set data type to uint32.

int16

Set data type to int16.

uint16

Set data type to uint16.

int8

Set data type to int8.

uint8

Set data type to uint8.

double

Set data type to double.

Programmatic Use**Block Parameter:** IterationVariableDataType**Type:** character vector**Value:** 'int32' | 'uint32' | 'int16' | 'uint16' | 'int8' | 'uint8' | 'double'**Default:** 'int32'**See Also****Blocks**

For Iterator Subsystem | Subsystem

Topics

Iterator Subsystem Execution

Introduced before R2006a

For Iterator Subsystem

Repeat subsystem execution during simulation time step for specified number of iterations

Library: Simulink / Ports & Subsystems

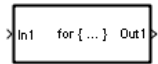

Description

The For Iterator Subsystem block is a Subsystem block preconfigured as a starting point for creating a subsystem that repeats the execution during a simulation time step for a specified number of iterations. The number of iterations is controlled by a For Iterator block inside the subsystem. For an example, see `ex_for_iterator_block`.

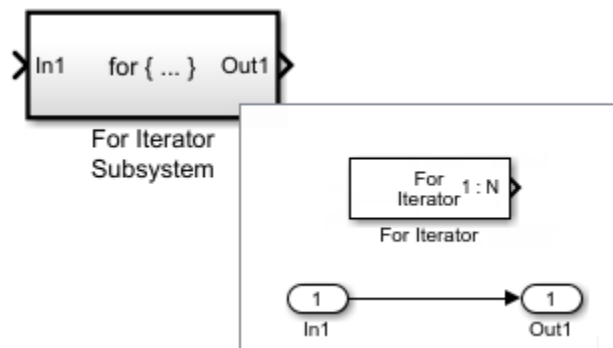

When using simplified initialization mode, if you place a block that needs elapsed time (such as a Discrete-Time Integrator block) in a For Iterator Subsystem block, Simulink displays an error.

Ports

Input

In — Signal input to a subsystem block

scalar | vector | matrix

Placing an Inport block in a Subsystem block adds an external input port to the block. The port label matches the name of the Inport block.

Use Inport blocks to get signals from the local environment.

Data Types: half | single | double | int8 | int16 | int32 | int64 | uint8 | uint16 | uint32 | uint64 | Boolean | fixed point | enumerated | bus

Output

Out — Signal output from a subsystem

scalar | vector | matrix

Placing an Outputport block in a Subsystem block adds an output port from the block. The port label on the Subsystem block is the name of the Outputport block.

Use Outputport blocks to send signals to the local environment.

Data Types: half | single | double | int8 | int16 | int32 | int64 | uint8 | uint16 | uint32 | uint64 | Boolean | fixed point | enumerated | bus

Block Characteristics

| | |
|---------------------------------|---|
| Data Types | Boolean ^a bus ^a double ^a enumerated ^a fixed point ^a half ^a integer ^a single ^a string ^a |
| Direct Feedthrough | no |
| Multidimensional Signals | limited ^a |
| Variable-Size Signals | limited ^a |
| Zero-Crossing Detection | no |

a. Actual data type or capability support depends on block implementation.

Extended Capabilities

C/C++ Code Generation

Generate C and C++ code using Simulink® Coder™.

Actual data type or capability support depends on block implementation.

Fixed-Point Conversion

Design and simulate fixed-point systems using Fixed-Point Designer™.

Actual data type or capability support depends on block implementation.

See Also

Blocks

For Iterator | Subsystem

Topics

“Iterate Subsystem Execution with While Iterator and For Iterator Subsystems”

Introduced before R2006a

From

Accept input from Goto block

Library: Simulink / Signal Routing
HDL Coder / Signal Routing



Description

The From block accepts a signal from a corresponding Goto block, then passes it as output. The data type of the output is the same as that of the input from the Goto block. From and Goto blocks allow you to pass a signal from one block to another without actually connecting them.

For example, this model uses a Goto block and a From block.



An equivalent model passes the Sine Wave block signal directly to the Gain block.

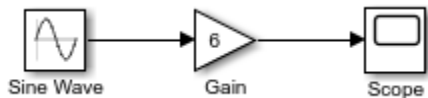

A From block can receive its signal from only one Goto block, although a Goto block can pass its signal to more than one From block.

To associate a Goto block with a From block, enter the Goto block tag in the **Goto Tag** parameter.

The visibility of a Goto block tag determines the From blocks that can receive its signal. For more information, see [Goto and Goto Tag Visibility](#). The block indicates the visibility of the Goto block tag:

- A local tag name is enclosed in brackets ([]).
- A scoped tag name is enclosed in braces ({}).
- A global tag name appears without additional characters.

The From block supports signal label propagation. For more information, see [“Signal Label Propagation”](#).

Ports

Output

Port_1 — Signal from connected Goto block

scalar | vector | matrix | N-D array

Signal from connected Goto block, output with the same dimensions and data type as the input to the Goto block.

Data Types: single | double | half | int8 | int16 | int32 | int64 | uint8 | uint16 | uint32 | uint64 | Boolean | fixed point | enumerated | bus

Parameters

Goto Tag — Tag of the Goto block that forwards its signal to this block

A (default) | <More Tags...> | ...

Specify the tag of the Goto block that forwards its signal to this From block. To change the tag, select a new tag from the drop-down list.

The drop-down list displays the Goto tags that the From block can currently see. An item labeled <More Tags...> appears at the end of the list the first time you display the list in a Simulink session. Selecting this item causes the block to update the tags list to include the tags of Goto blocks residing in library subsystems referenced by the model containing this From block. Simulink software displays a progress bar while building the list of library tags. Simulink saves the updated tags list for the duration of the Simulink session or until the next time you select the adjacent **Update Tags** button. You need to update the tags list again in the current session only if the libraries referenced by the model have changed since the last time you updated the list.

Tip If you use multiple From and Goto Tag Visibility blocks to refer to the same Goto tag, you can simultaneously rename the tag in all of the blocks. To do so, use the **Rename All** button in the Goto block dialog box. Alternatively, when you change the tag on the Goto block icon, propagate the new name to all corresponding From and Goto Tag Visibility blocks by pressing **Shift+Enter**.

To find the relevant Goto block, use the **Goto Source** hyperlink in the From block dialog box.

Programmatic Use

Block Parameter: GotoTag

Type: character vector

Values: 'A' | ...

Default: 'A'

Update Tags — Update list of visible tags

Updates the list of tags visible to this From block, including tags residing in libraries referenced by the model containing this From block. Update the tags list again in the current session only if the libraries referenced by the model have changed since the last time you updated the list.

Goto Source — Path to connected Goto block

block path

Path of the Goto block connected to this From block. Clicking the path displays and highlights the Goto block in your model.

In the Simulink Editor, selecting the From block highlights the corresponding Goto and Goto Tag Visibility blocks.



When a corresponding Goto or Goto Tag Visibility block is not in the current diagram, the Subsystem block that contains the block is highlighted.

To show a corresponding block in an open diagram or new tab, select the From block and pause on the ellipsis. Then, select **Related Blocks**  from the action bar. When multiple blocks correspond to the selected block, a list of related blocks opens. You can filter the list of related blocks by entering a search term in the text box. After you select a related block from the list, window focus goes to the open diagram or new tab that shows the related block.

Icon Display — Text to display on block icon

Tag | Tag and signal name | Signal name

Specifies the text to display on the From block icon. The options are the block tag, the name of the signal that the block represents, or both the tag and the signal name.

Programmatic Use

Block Parameter: IconDisplay

Type: character vector

Values: 'Signal name' | 'Tag' | 'Tag and signal name'

Default: 'Tag'

Block Characteristics

| | |
|---------------------------------|--|
| Data Types | Boolean bus double enumerated fixed point half integer single string |
| Direct Feedthrough | no |
| Multidimensional Signals | yes |
| Variable-Size Signals | yes |
| Zero-Crossing Detection | no |

More About

Search for Goto Tags

To search for Goto tags in libraries referenced by the model when opening the From block dialog box, use the FollowLinksWhenOpeningFromGotoBlocks model parameter with the set_param function.

- 'off' — Do not search for Goto tags (default).
- 'on' — Search for Goto tags.

Extended Capabilities

C/C++ Code Generation

Generate C and C++ code using Simulink® Coder™.

HDL Code Generation

Generate Verilog and VHDL code for FPGA and ASIC designs using HDL Coder™.

HDL Coder provides additional configuration options that affect HDL implementation and synthesized logic. See also “Required HDL Settings for Goto and From Blocks” (HDL Coder).

HDL Architecture

This block has a single, default HDL architecture.

HDL Block Properties

| | |
|----------------------------------|--|
| ConstrainedOutputPipeline | Number of registers to place at the outputs by moving existing delays within your design. Distributed pipelining does not redistribute these registers. The default is 0. For more details, see “ConstrainedOutputPipeline” (HDL Coder). |
| OutputPipeline | Number of output pipeline stages to insert in the generated code. Distributed pipelining and constrained output pipelining can move these registers. The default is 0. For more details, see “OutputPipeline” (HDL Coder). |

PLC Code Generation

Generate Structured Text code using Simulink® PLC Coder™.

Fixed-Point Conversion

Design and simulate fixed-point systems using Fixed-Point Designer™.

See Also

Goto | Goto Tag Visibility

Topics

“Signal Label Propagation”

Introduced before R2006a

From File

Load data from MAT file into Simulink model

Library: Simulink / Sources



Description

The From File block reads data into a Simulink model from a MAT file and provides the data as a signal or bus at the block output. You can load data from a MAT file that is on or off the MATLAB path. A model can contain multiple From File blocks that load data from the same MAT file.

You can specify how the block constructs the output from the data in the file, including the sample time for the output, interpolation and extrapolation behavior, and whether to use zero-crossing detection.

The From File block icon shows the name of the MAT file that supplies the data to the block. For example, if you use the From File block to load data from the file `myData.mat`, the block displays `myData.mat`.

MAT File Data

The From File block can load data from a MAT file that is stored in a `timeseries` object or in an array where the first row contains time data and subsequent rows contain data for a scalar or vector signal. Loading data stored in a `timeseries` object supports a wider range of data and output types and requires that the MAT file is Version 7.3.

Note Logging outputs or states or a signal connected to a To Workspace block using the Array format generates an array in a different format than the From File block expects. In the Array format for logging, the first column contains time values, and in the array format for the From File block, the first row contains time values. The From File block and To File block use the same array format.

| Data Consideration | timeseries Format | Array Format |
|-----------------------------|--|---|
| Supported signal data types | <ul style="list-style-type: none"> Any built-in data types except <code>half</code>, <code>int64</code>, and <code>uint64</code> Enumerated data type Fixed-point data type with up to a 32-bit word length | double |
| Signal data complexity | Real or complex | Real |
| Signal data requirements | Must not contain NaN, Inf, or -Inf values | Must not contain NaN, Inf, or -Inf values |

| Data Consideration | timeseries Format | Array Format |
|------------------------|---|---|
| Type of output | <ul style="list-style-type: none"> Scalar, vector, or multidimensional signal Bus | Scalar or vector signal |
| Time data requirements | <ul style="list-style-type: none"> Data type must be double Values must increase monotonically | <ul style="list-style-type: none"> Data type must be double Values must increase monotonically |
| MAT file version | Version 7.3 | All versions |

The From File block loads data from only one variable in the MAT file, regardless of the number of variables the MAT file contains. When you load data from a Version 7.3 MAT file that contains multiple variables, the From File block loads the data in the variable that is first alphabetically. The ordering algorithm used by Version 7.0 and earlier MAT files is more complicated, so ensure that the MAT file only contains data for a single variable when you load data from a Version 7.0 or earlier MAT file.

MAT File Version

The version of the MAT file also affects how the From File block loads the data. When you load data from a Version 7.3 MAT file, data is loaded incrementally during simulation. When you load data from a Version 7.0 or earlier MAT file, all the data is loaded into memory at the start of simulation.

To convert a MAT file to Version 7.3, use the `load` function to load the data in the Version 7.0 or earlier MAT file into the base workspace, then save the data to a Version 7.3 MAT file using the `save` function with the version specified as `'-v7.3'`. For example, suppose you want to convert the file `myData.mat` that contains the variable `inputData` to Version 7.3. Use these commands:

```
load('myData.mat');
save('myData.mat','inputData','-v7.3');
```

For more information, see “MAT-File Versions”.

Ports

Output

Port_1 — Output created using MAT file data

scalar | vector | matrix | N-D array | bus

Output created using data loaded from the specified MAT file. Depending on the data you load, the output may be a scalar or multidimensional signal or a bus. The From File block supports loading real and complex data of all built-in data types except `half`, `int64`, and `uint64`.

Data Types: `single` | `double` | `int8` | `int16` | `int32` | `uint8` | `uint16` | `uint32` | `Boolean` | `fixed point` | `enumerated` | `bus`

Parameters

File name — MAT file name or path to MAT file

`untitled.mat` (default) | MAT file name | path to MAT file

MAT file name or path to MAT file with data you want to load. Specify the path to the file when the file is not on the MATLAB path or in the current working directory.

You can type the path or file name into the text box, or you can browse to the MAT file by clicking the

Browse for a MAT-file button.  On UNIX® systems, the path can start with a tilde (~), which indicates your home folder.

You cannot load data from a file to which the model logs data.

Tips

- The From File block supports loading data from a file created using a To File block without any modification to the data or file.
- To determine the current working directory, enter `pwd` into the MATLAB Command Window.
- For information about data requirements for C/C++ code generation with the From File block, see “Code Generation” on page 1-638.

Programmatic Use

Block Parameter: FileName

Type: character vector

Values: MAT file name | path to MAT file

Default: 'untitled.mat'

Output data type — Data type of data in MAT file

Inherit: auto (default) | double | single | int8 | uint8 | int16 | uint16 | int32 | uint32 | boolean | fixdt(1,16,0) | fixdt(1,16,2^0,0) | Enum: <class_name> | Bus: <bus_object> | <data type expression>

Data type of the data in the MAT file loaded by the From File block. By default, the From File block inherits the output signal data type from the data in the file or from a downstream block that defines the data type for the signal. An error occurs if the data type of the data in the MAT file does not match the inherited data type.

When you load data for a scalar or multidimensional signal, you can choose to inherit the output data type, or you can specify the output data type to match the data type of the data in the MAT file.

To load data for a bus, set the **Output data type** to Bus: <bus object> and specify the name of the Simulink.Bus object that defines the output bus.

To load enumerated data, set the **Output data type** to Enum: <class name> and specify the name of the enumeration class that defines the enumerated data values.

Click the **Show data type assistant** button  to display the **Data Type Assistant**, which helps you set the data type attributes. For more information, see “Specify Data Types Using Data Type Assistant”.

Programmatic Use

Block Parameter: OutDataTypeStr

Type: character vector

Values: 'Inherit: auto' | 'double' | 'single' | 'int8' | 'uint8' | 'int16' | 'uint16' | 'int32' | 'uint32' | 'boolean' | 'fixdt(1,16,0)' |

'fixdt(1,16,2^0,0)' | 'Enum: <class name>' | 'Bus: <object name>' | '<data type expression>'

Default: 'Inherit: auto'

Sample time — Output sample period and optional time offset

0 | scalar | vector

The **Sample time** parameter specifies when the block computes a new output value during simulation. For details, see “Specify Sample Time”.

Specify the **Sample time** parameter as a scalar when you do not want the output to have a time offset. To add a time offset to the output, specify the **Sample time** parameter as a 1-by-2 vector where the first element is the sampling period and the second element is the offset.

By default, the **Sample time** parameter value is 0, which indicates continuous sample time with no time offset. For a discrete signal, specify the **Sample time** as the discrete sampling interval. For example, specify the **Sample time** as 0.1 to model a discrete signal sampled every 100ms. Specify the **Sample time** as -1 to inherit the value.

Programmatic Use

Block Parameter: SampleTime

Type: character vector

Values: scalar | vector

Default: '0'

Data extrapolation before first data point — Method to determine block output before first data point in MAT file

Linear extrapolation (default) | Hold first value | Ground value

Extrapolation method used to determine output values for simulation times before the first sample in the MAT file data.

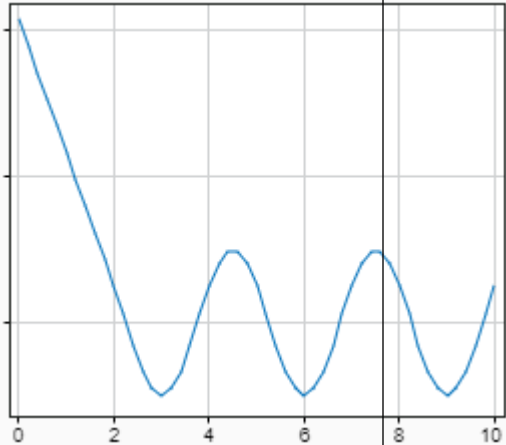
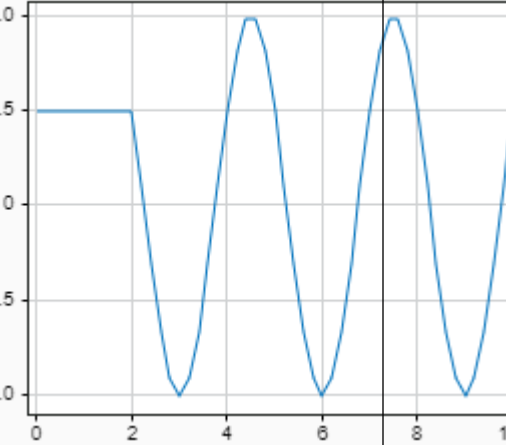
| Method | Description | Example |
|-----------------------------|---|---|
| <p>Linear extrapolation</p> | <p>How the block determines the output value depends on the type of data in the MAT file.</p> <ul style="list-style-type: none"> • For double data, the From File block linearly extrapolates the output value using the first two samples. • For Boolean data, the From File block uses the first value in MAT file data for the output value. • For all other built-in data types, the From File block: <ol style="list-style-type: none"> 1 Upcasts the data to double. 2 Linearly extrapolates the output value using the first two samples in the MAT file data. 3 Downcasts the extrapolated data value to the original data type. <p>If the MAT file data only contains one sample, the From File block provides that value at the output.</p> <p>Do not use the Linear extrapolation option when the From File block loads enumerated or fixed-point data.</p> <p>The extrapolation setting is applied to all signals in a bus. If any signal in the bus contains enumerated or fixed-point data, do not use the Linear extrapolation option.</p> |  |
| <p>Hold first value</p> | <p>The From File block uses the first data value in the MAT file as the output value.</p> |  |

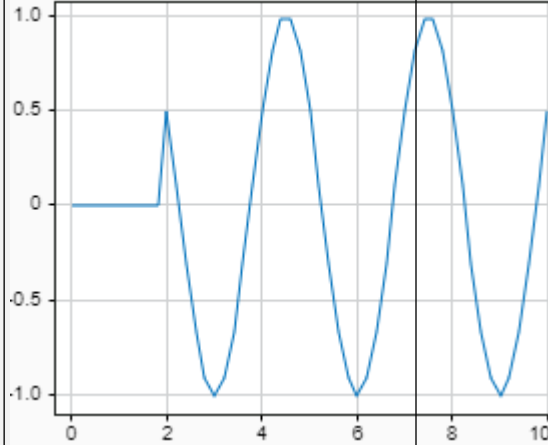
| Method | Description | Example |
|--------------|---|---|
| Ground value | <p>The From File block output value depends on the type of data in the MAT file.</p> <ul style="list-style-type: none"> • Built-in numeric types — 0 • Boolean — false • Fixed-point data types — Representation for value of 0, which may not be exactly 0 due to scaling and limited precision. • Enumerated data types — Default value |  |

Tips

To generate code that builds ERT or GRT targets or uses SIL or PIL simulation modes, specify **Data extrapolation before first data point** as **Linear extrapolation**. For more information about C/C++ code generation with the From File block, see “Code Generation” on page 1-638.

Programmatic Use

Block Parameter: ExtrapolationBeforeFirstDataPoint

Type: character vector

Values: 'Linear extrapolation' | 'Hold first value' | 'Ground value'

Default: 'Linear extrapolation'

Data interpolation within time range — Interpolation method

Linear interpolation (default) | Zero order hold

Interpolation method used to determine output values for simulation times between samples in the MAT file data.

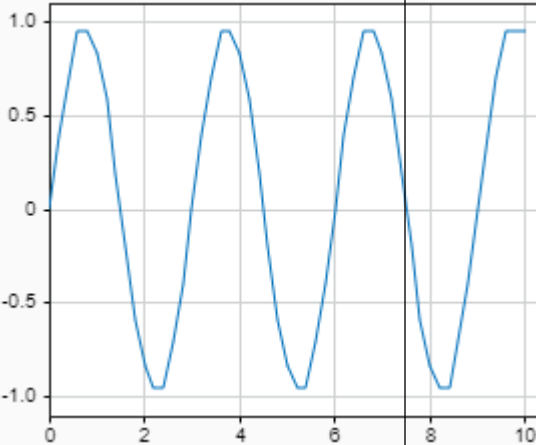
| Method | Description | Example |
|-----------------------------|---|---|
| <p>Linear interpolation</p> | <p>How the block determines the output value depends on the type of data in the MAT file.</p> <ul style="list-style-type: none"> • For <code>double</code> data, the From File block linearly interpolates the output value using data values before and after the simulation time that needs an output value. • For all other built-in numeric data types, the From File block: <ol style="list-style-type: none"> 1 Upcasts the data to <code>double</code>. 2 Linearly interpolates the output value using the MAT file data values before and after the simulation time that needs an output value. 3 Downcasts the extrapolated data value to the original data type. • For <code>Boolean</code> data, if the simulation time is between two workspace data points with different values, the From File block positions the value transition halfway between the MAT file data points. For example, if the data transitions from <code>true</code> to <code>false</code>, the From File block provides an output value of <code>true</code> for simulation times in the first half of the interval between the MAT file data points and an output value of <code>false</code> for simulation times in the latter half of the interval. <p>If the MAT file data only contains one sample, the From File block provides that value at the output.</p> <p>Do not use the <code>Linear interpolation</code> option when the From File block loads enumerated data.</p> <p>The interpolation setting is applied to all signals in a bus. If any signal in the bus contains enumerated data, do not use the <code>Linear interpolation</code> option.</p> |  |

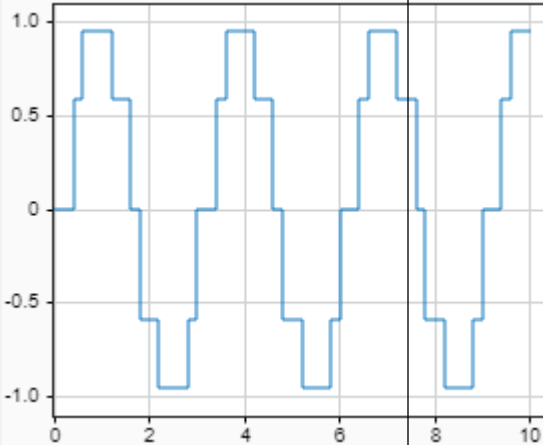
| Method | Description | Example |
|-----------------|--|---|
| Zero order hold | The From File block holds each data value from one sample to the next. The output value for a simulation time between two samples in the MAT file data is the value of the sample that precedes the simulation time. |  |

Tips

To generate code that builds ERT or GRT targets or uses SIL or PIL simulation modes, specify **Data interpolation within time range** as `Linear interpolation`. For more information on C/C++ code generation with the From File block, see “Code Generation” on page 1-638.

Programmatic Use

Block Parameter: `InterpolationWithinTimeRange`

Type: character vector

Values: `'Linear interpolation'` | `'Zero order hold'`

Default: `'Linear interpolation'`

Data extrapolation after last data point – Method to determine block output after final data point in MAT file

`Linear extrapolation (default)` | `Hold last value` | `Ground value`

Extrapolation method used to determine output values for simulation times after the last sample in the MAT file data.

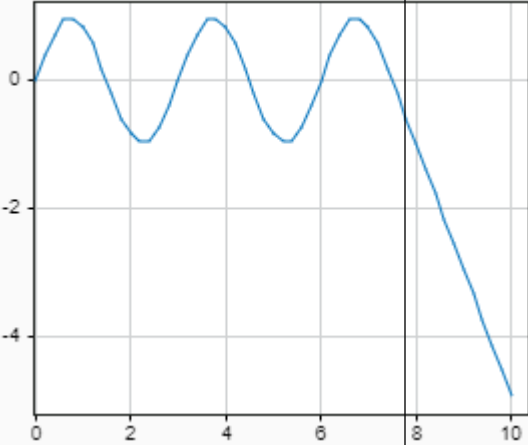
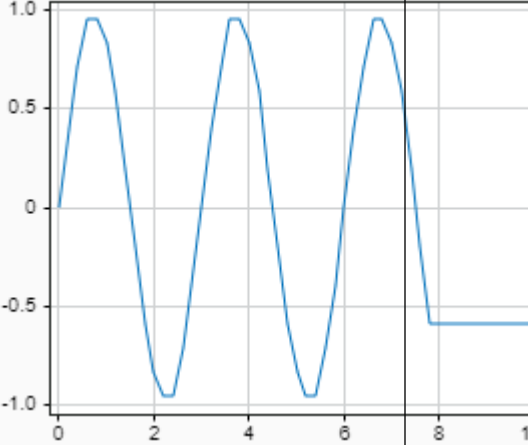
| Method | Description | Example |
|-----------------------------|---|---|
| <p>Linear extrapolation</p> | <p>How the block determines the output value depends on the type of data in the MAT file.</p> <ul style="list-style-type: none"> • For double data, the From File block linearly extrapolates the output value using the last two samples in the MAT file. • For Boolean data, the From File block uses the sample value in MAT file for the output value. • For all other built-in data types, the From File block: <ol style="list-style-type: none"> 1 Upcasts the data to double. 2 Linearly extrapolates the output value using the last two samples in the MAT file data. 3 Downcasts the extrapolated data value to the original data type. <p>If the MAT file data only contains one sample, the From File block uses that value as the output.</p> <p>Do not use the Linear extrapolation option when the From File block loads enumerated data.</p> <p>The extrapolation setting is applied to all signals in a bus. If any signal in the bus contains enumerated data, do not use the Linear extrapolation option.</p> |  |
| <p>Hold last value</p> | <p>The From File block uses the last data value in the MAT file as the output value.</p> |  |

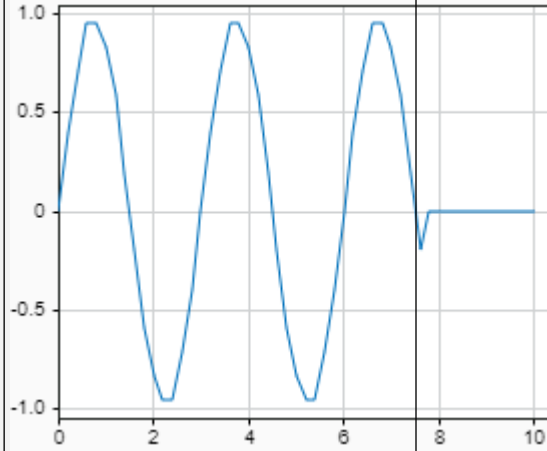
| Method | Description | Example |
|--------------|---|---|
| Ground value | <p>The From File block output value depends on the type of data in the MAT file.</p> <ul style="list-style-type: none"> Built-in numeric types — 0 Boolean — false Fixed-point data types — Representation for value of 0, which may not be exactly 0 due to scaling and limited precision. Enumerated data types — Default value |  |

Tips

To generate code that builds ERT or GRT targets or uses SIL or PIL simulation modes, specify **Data extrapolation after last data point** as `Linear extrapolation`. For more information on C/C++ code generation with the From File block, see “Code Generation” on page 1-638.

Programmatic Use

Block Parameter: `ExtrapolationAfterLastDataPoint`

Type: character vector

Values: 'Linear extrapolation' | 'Hold last value' | 'Ground value'

Default: 'Linear extrapolation'

Enable zero-crossing detection — Zero-crossing detection

off (default) | on

Zero-crossing detection locates discontinuities, or zero crossings, in the block output and prevents excessively small time steps near the discontinuities, which can slow down a simulation. You can enable zero-crossing detection for the From File block when the **Sample time** parameter is set to 0 for continuous sample time.

The loaded data creates a discontinuity in the block output when the data includes multiple samples with the same time. For example, for this input data, a discontinuity occurs at time 2.

```
time:    0 1 2 2 3
signal:  2 3 4 5 6
```

The From File block can also create discontinuities in the output based on how you configure interpolation and extrapolation.

- Setting **Data extrapolation before first data point** to `Ground value` can create a discontinuity at the first sample in the loaded data.
- Setting **Data extrapolation after the last data point** to `Ground value` can create a discontinuity at the last sample in the loaded data.
- Setting **Data interpolation within time range** to `Zero-order hold` creates a discontinuity at each sample in the loaded data, including the last.

For more information, see “Zero-Crossing Detection”.

Tips

To generate code that builds ERT or GRT targets or uses SIL or PIL simulation modes, clear this check box. For more information on C/C++ code generation with the From File block, see “Code Generation” on page 1-638.

Programmatic Use

Block Parameter: ZeroCross

Type: character vector

Values: 'off' | 'on'

Default: 'on'

Block Characteristics

| | |
|---------------------------------|---|
| Data Types | Boolean bus double enumerated fixed point ^a integer single |
| Direct Feedthrough | no |
| Multidimensional Signals | yes |
| Variable-Size Signals | no |
| Zero-Crossing Detection | yes |

a. Supports up to 32-bit fixed-point data types.

Extended Capabilities**C/C++ Code Generation**

Generate C and C++ code using Simulink® Coder™.

Not recommended for production code.

Generating code for an RSim target has no special requirements or limitations. All other code generation targets only support loading real, double, one-dimensional signal data from an array in a MAT file where the first column contains time data and subsequent columns contain the signal data. Generating code that builds ERT or GRT targets or uses SIL or PIL simulation modes requires that:

- The loaded MAT file contains an array with at least two rows and no NaN, Inf, or -Inf values.
- The **Data extrapolation before first data point** and **Data extrapolation after last data point** parameters are set to `Linear` extrapolation.
- The **Data interpolation within time range** parameter is set to `Linear` interpolation.
- The **Enable zero-crossing detection** parameter is cleared.

Fixed-Point Conversion

Design and simulate fixed-point systems using Fixed-Point Designer™.

The From File block supports fixed-point data types up to 32 bits.

See Also

Blocks

To File | From Workspace | To Workspace | From Spreadsheet

Objects

timeseries | Simulink.Bus | Simulink.BusElement

Functions

save

Topics

“Overview of Signal Loading Techniques”
“Comparison of Signal Loading Techniques”
“MAT-File Versions”

Introduced before R2006a

From Spreadsheet

Read data from spreadsheet

Library: Simulink / Sources

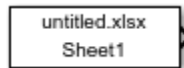

Description

The From Spreadsheet block reads data from Microsoft Excel® (all platforms) or CSV (MicrosoftWindows® platform with Microsoft Office installed only) spreadsheets and outputs the data as a signal. The From Spreadsheet block does not support Microsoft Excel spreadsheet charts.

The From Spreadsheet icon displays the spreadsheet file name and sheet name specified in the block **File name** and **Sheet name** parameters.

Storage Formats

The data that the From Spreadsheet block reads from a spreadsheet must be appropriately formatted.

For Microsoft Excel spreadsheets:

- The From Spreadsheet block interprets the first row as a signal name. If you do not specify a signal name, the From Spreadsheet block assigns a default one with the format Signal #, where # increments with each additional unnamed signal.
- The From Spreadsheet block interprets the first column as time. In this column, the time values must monotonically increase.
- The From Spreadsheet block interprets the remaining columns as signals.

This example shows an acceptably formatted Microsoft Excel spreadsheet. The first column is Time and the first row contains signal names. Each worksheet contains a signal group.

| 1 | Time | DC In | Trigger | AC In |
|----|------|-------|---------|-------|
| 2 | 0 | 1 | 2 | 3 |
| 3 | 1 | 2 | 3 | 4 |
| 4 | 2 | 3 | 4 | 5 |
| 5 | 3 | 4 | 5 | 6 |
| 6 | 4 | 5 | 6 | 7 |
| 7 | 5 | 6 | 7 | 8 |
| 8 | 6 | 7 | 8 | 9 |
| 9 | 7 | 8 | 9 | 10 |
| 10 | 8 | 9 | 10 | 11 |
| 11 | 9 | 10 | 11 | 12 |
| 12 | 10 | 11 | 12 | 13 |
| 13 | 11 | 12 | 13 | 14 |
| 14 | 12 | 13 | 14 | 15 |
| 15 | 13 | 14 | 15 | 16 |
| 16 | 14 | 15 | 16 | 17 |
| 17 | 15 | 16 | 17 | 18 |
| 18 | | | | |

Navigation: < > Group1 Group2 Group3

For CSV text files (Microsoft platform with Microsoft Office installed only):

- The From Spreadsheet block interprets the first column as time. In this column, the time values must increase.
- The From Spreadsheet block interprets the remaining columns as signals.
- Each column must have the same number of entries.
- The From Spreadsheet block interprets each file as one signal group.

This example shows an acceptably formatted CSV file. The contents represent one signal group.

```
0,0,0,5,0
1,0,1,5,0
2,0,1,5,0
3,0,1,5,0
4,5,1,5,0
5,5,1,5,0
6,5,1,5,0
7,0,1,5,0
8,0,1,5,1
9,0,1,5,1
10,0,1,5,0
```

Block Behavior During Simulation

The From Spreadsheet block incrementally reads data from the spreadsheet during simulation.

The **Sample time** parameter specifies the sample time that the From Spreadsheet block uses to read data from the spreadsheet. For details, see “Parameters” on page 1-643. The time stamps in the file must be monotonically nondecreasing.

For each simulation time hit for which the spreadsheet contains no matching time stamp, Simulink software interpolates or extrapolates to obtain the needed data using the selected method. For details, see “Simulation Time Hits That Have No Corresponding Spreadsheet Time Stamps” on page 1-642.

Simulation Time Hits That Have No Corresponding Spreadsheet Time Stamps

If the simulation time hit does not have a corresponding spreadsheet time stamp, the From Spreadsheet block output depends on:

- Whether the simulation time hit occurs before the first time stamp, within the range of time stamps, or after the last time stamp
- The interpolation or extrapolation methods that you select
- The data type of the spreadsheet data

For details about interpolation and extrapolation options, see the descriptions of these parameters:

- “Data extrapolation before first data point” on page 1-0
- “Data interpolation within time range” on page 1-0
- “Data extrapolation after last data point” on page 1-0

Sometimes the spreadsheet includes two or more data values that have the same time stamp. In such cases, the From Spreadsheet block action depends on when the simulation time hit occurs, relative to the duplicate time stamps in the spreadsheet.

For example, suppose that the spreadsheet contains this data. Three data values have a time stamp value of 2.

```
time stamps:    0 1 2 2 2 3 4
data values:   2 3 6 4 9 1 5
```

The table describes the From Spreadsheet block output.

| Simulation Time, Relative to Duplicate Time Stamp Values in Spreadsheet | From Spreadsheet Block Action |
|---|---|
| Before the duplicate time stamps | Performs the same actions as when the time stamps are distinct, using the first of the duplicate time stamp values as the basis for interpolation. (In this example, the time stamp value is 6.) |
| At or after the duplicate time stamps | Performs the same actions as when the times stamps are distinct, using the last of the duplicate time stamp values as the basis for interpolation. (In this example, that time stamp value is 9.) |

Ports

Output

Port_1 — Data from spreadsheet

scalar | vector | matrix

Incremental data from the specified spreadsheet.

The **Sample time** parameter specifies the sample time that the From Spreadsheet block uses to read data from the spreadsheet. For details, see “Parameters” on page 1-643. The time stamps in the file must be monotonically nondecreasing.

For each simulation time hit for which the spreadsheet contains no matching time stamp, Simulink software interpolates or extrapolates to obtain the needed data using the selected method. For details, see “Simulation Time Hits That Have No Corresponding Spreadsheet Time Stamps” on page 1-642.

The From Spreadsheet block accepts data type specifications at a block level. If you want to specify different data types for each signal, consider selecting **Output Data Type > Inherit: Auto**. This option resolves back signal data types using back propagation. For example, assume that there are two signals in the From Spreadsheet block, In1 and In2, which the block sends to ports that have int8 and Boolean data types. With back propagation, the block recasts In1 as int8 and In2 as Boolean.

Data Types: `single` | `double` | `int8` | `int16` | `int32` | `int64` | `uint8` | `uint16` | `uint32` | `uint64` | `Boolean` | `fixed point` | `enumerated`

Parameters

File name — Full path and file name

`untitled.xlsx` (default) | full path and file name

Enter full path and file name of a spreadsheet file, including the file extension. If you do not include a file extension, the block assumes `.xlsx` as the extension.

This block supports non-English full paths and file names only on Microsoft platforms.

Programmatic Use

Block Parameter: `FileName`

Type: character vector

Value: full path and file name

Default: `'untitled.xlsx'`

Sheet name — Name of sheet in spreadsheet

`Sheet1` (default) | sheet name

Enter the name of the sheet in the spreadsheet. You can type the sheet name in this edit box or select the sheet name after you open the sheet.

If your spreadsheet is the CSV format, the block populates this parameter with the name of the CSV file without the extension. Do not change this value.

To open the sheet, click . In the sheet, you can select the range of data by dragging over the desired range of values.

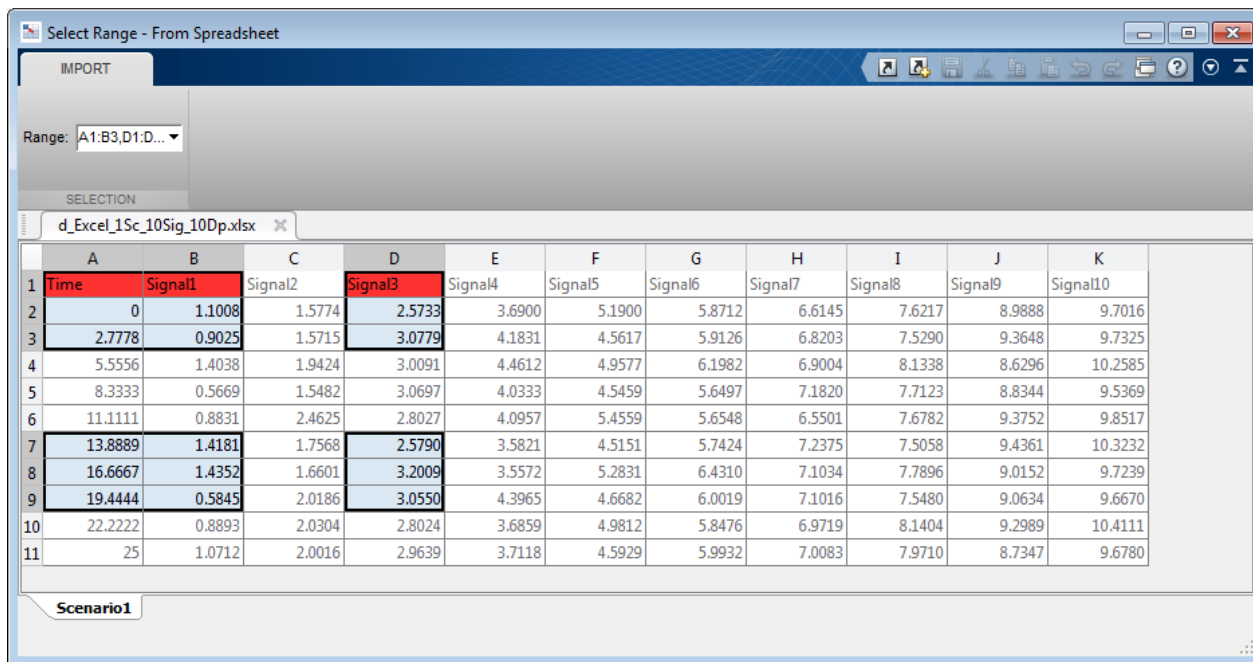

Alternatively, you can select the range of data by specifying the range of values in the **Range** parameter.

Programmatic Use

Block Parameter: SheetName

Type: character vector

Value: Sheet name

Default: 'Sheet1'

Range — Cell range

entire range of used cells in sheet (default) | A1:B3,D1:D3,A7:B9,D7:D9 | comma-separated list of *column:row*

To specify the range, use the format *column:row*, with multiple specifications separated by commas. For example, A1:B3,D1:D3,A7:B9,D7:D9. If unspecified, or empty, the block automatically detects the used range, which is all the data in the sheet.

| A | B | C | D | E | F | G | H | I | J | K |
|---------|---------|---------|---------|---------|---------|---------|---------|---------|---------|----------|
| Time | Signal1 | Signal2 | Signal3 | Signal4 | Signal5 | Signal6 | Signal7 | Signal8 | Signal9 | Signal10 |
| 0 | 1.1008 | 1.5774 | 2.5733 | 3.6900 | 5.1900 | 5.8712 | 6.6145 | 7.6217 | 8.9888 | 9.7016 |
| 2.7778 | 0.9025 | 1.5715 | 3.0779 | 4.1831 | 4.5617 | 5.9126 | 6.8203 | 7.5290 | 9.3648 | 9.7325 |
| 5.5556 | 1.4038 | 1.9424 | 3.0091 | 4.4612 | 4.9577 | 6.1982 | 6.9004 | 8.1338 | 8.6296 | 10.2585 |
| 8.3333 | 0.5669 | 1.5482 | 3.0697 | 4.0333 | 4.5459 | 5.6497 | 7.1820 | 7.7123 | 8.8344 | 9.5369 |
| 11.1111 | 0.8831 | 2.4625 | 2.8027 | 4.0957 | 5.4559 | 5.6548 | 6.5501 | 7.6782 | 9.3752 | 9.8517 |
| 13.8889 | 1.4181 | 1.7568 | 2.5790 | 3.5821 | 4.5151 | 5.7424 | 7.2375 | 7.5058 | 9.4361 | 10.3232 |
| 16.6667 | 1.4352 | 1.6601 | 3.2009 | 3.5572 | 5.2831 | 6.4310 | 7.1034 | 7.7896 | 9.0152 | 9.7239 |
| 19.4444 | 0.5845 | 2.0186 | 3.0550 | 4.3965 | 4.6682 | 6.0019 | 7.1016 | 7.5480 | 9.0634 | 9.6670 |
| 22.2222 | 0.8893 | 2.0304 | 2.8024 | 3.6859 | 4.9812 | 5.8476 | 6.9719 | 8.1404 | 9.2989 | 10.4111 |
| 25 | 1.0712 | 2.0016 | 2.9639 | 3.7118 | 4.5929 | 5.9932 | 7.0083 | 7.9710 | 8.7347 | 9.6780 |

If the selections overlap, the block resolves the selection information as appropriate. For example, if you specify multiple ranges that overlap, such as A1:B4,B1:E7, the block resolves the selection to A1 to E7, inclusive.

An alternate to using the **Range** parameter is to open the sheet, by clicking . In the sheet, you can select the range of data by dragging over the desired range of values.

Programmatic Use

Block Parameter: Range

Type: character vector

Value: Cell range

Default: ''

Output data type — Output data type

Inherit: auto (default) | double | single | int8 | uint8 | int16 | uint16 | int32 | uint32 | int64 | uint64 | boolean | fixdt(1,16,0) | fixdt(1,16,2^0,0) | Enum: <class_name> | <data type expression>

The data type for the From Spreadsheet block output. The From Spreadsheet block accepts spreadsheets that contain many data types. However, the block reads the spreadsheet data type as doubles. It then outputs the data type according to the value of **Output data type**.

If you want to specify different data types for each signal, consider selecting **Output Data Type > Inherit: auto**. This option resolves back signal data types using back propagation. For example, assume that there are two signals in the From Spreadsheet block, In1 and In2, which the block sends to ports that have int8 and Boolean data types. With back propagation, the block recasts In1 as int8 and In2 as boolean.

To allow the block to cast the output data type to match that of the receiving block, use **Inherit: auto**.

For more information, see “Control Data Types of Signals”.

Programmatic Use

Block Parameter: OutDataTypeStr

Type: character vector

Values: 'Inherit: auto' | 'double' | 'single' | 'int8' | 'uint8' | 'int16' | 'uint16' | 'int32' | 'uint32' | 'int64' | 'uint64' | 'boolean' | 'fixdt(1,16,0)' | 'fixdt(1,16,2^0,0)' | 'Enum: <class name>' | '<data type expression>'

Default: 'Inherit: auto'

Treat first column as — Time or data

Time (default) | Data

Select how the block should treat the first column of the spreadsheet:

- Time — Treat first column as time.
- Data — Treat first column as data.

Dependencies

When you select Data, the block disables:

- **Data extrapolation before first data point**
- **Data interpolation within time range**
- **Data extrapolation after last data point**

And enables:

- **Output after last data point**

Programmatic Use

Block Parameter: TreatFirstColumnAs

Type: character vector

Value: 'Time' | 'Data'

Default: 'Time'

Sample time — Sampling period and offset

0 (default) | scalar | vector

The sample period and offset.

The From Spreadsheet block reads data from a spreadsheet using a sample time that either:

- You specify for the From Spreadsheet block
- The From Spreadsheet block inherits from the blocks into which the From Spreadsheet block feeds data

The default is 0, which specifies a continuous sample time. The spreadsheet is read at the base (fastest) rate of the model. For details, see “Specify Sample Time”.

Programmatic Use

Parameter: SampleTime

Type: character vector

Values: scalar | vector

Default: '0'

Data extrapolation before first data point — Extrapolation method for simulation times before initial time stamp in MAT-file

Linear extrapolation (default) | Hold first value | Ground value

Extrapolation method that Simulink uses for a simulation time hit that is before the first time stamp in the spreadsheet. Choose one of these extrapolation methods.

| Method | Description |
|----------------------|---|
| Linear extrapolation | <p>(Default)</p> <p>If the spreadsheet contains only one sample, the From Spreadsheet block outputs the corresponding data value.</p> <p>If the spreadsheet contains more than one sample, the From Spreadsheet block linearly extrapolates using the first two samples:</p> <ul style="list-style-type: none"> • For <code>double</code> data, linearly extrapolates the value using the first two samples • For <code>Boolean</code> data, outputs the first data value • For a built-in data type other than <code>double</code> or <code>Boolean</code>: <ul style="list-style-type: none"> • Upcasts the data to <code>double</code> • Performs linear extrapolation (as described above for <code>double</code> data) • Downcasts the extrapolated data value to the original data type <p>You cannot use the <code>Linear extrapolation</code> option with enumerated (<code>enum</code>) data.</p> |
| Hold first value | Uses the first data value in the file |
| Ground value | <p>Uses a value that depends on the data type of spreadsheet sample data values:</p> <ul style="list-style-type: none"> • Fixed-point data types — Uses the ground value • Numeric types other than fixed-point — Uses 0 • <code>Boolean</code> — Uses <code>false</code> • Enumerated data types — Uses default value |

Dependencies

To enable this parameter, set **Treat first column as** to `Time`.

Programmatic Use

Parameter: `ExtrapolationBeforeFirstDataPoint`

Type: character vector

Values: `'Linear extrapolation'` | `'Hold first value'` | `'Ground value'`

Default: `'Linear extrapolation'`

Data interpolation within time range — Interpolation method for simulation times that fall between two time stamps in the MAT-file

`Linear interpolation (default)` | `Zero order hold`

The interpolation method that Simulink uses for a simulation time hit between two time stamps in the spreadsheet. Choose one of the following interpolation methods.

| Method | Description |
|----------------------|--|
| Linear interpolation | <p>(Default)</p> <p>The From Spreadsheet block interpolates using the two corresponding spreadsheet samples:</p> <ul style="list-style-type: none"> For <code>double</code> data, linearly interpolates the value using the two corresponding samples For Boolean data, if the simulation time is between two spreadsheet data points with different values, the From Spreadsheet block positions the value transition halfway between the spreadsheet data points. For example, if the spreadsheet data transitions from true to false, the From Spreadsheet data provides an output value of true for simulation times in the first half of the interval between the spreadsheet data points. It provides an output value of false for simulation times in the latter half of the interval. For a built-in data type other than <code>double</code> or <code>Boolean</code>: <ul style="list-style-type: none"> Upcasts the data to <code>double</code> Performs linear interpolation (as described above for <code>double</code> data) Downcasts the interpolated value to the original data type <p>You cannot use the <code>Linear interpolation</code> option with enumerated (<code>enum</code>) data.</p> |
| Zero order hold | Uses the data from the first of the two samples |

Dependencies

To enable this parameter, set **Treat first column as** to `Time`.

Programmatic Use

Parameter: `InterpolationWithinTimeRange`

Type: character vector

Values: `'Linear interpolation'` | `'Zero order hold'`

Default: `'Linear interpolation'`

Data extrapolation after last data point — Extrapolation method for simulation times after last time stamp in MAT-file

`Linear extrapolation (default)` | `Hold last value` | `Ground value`

The extrapolation method that Simulink uses for a simulation time hit that is after the last time stamp in the spreadsheet. Choose one of the following extrapolation methods.

| Method | Description |
|----------------------|--|
| Linear extrapolation | <p>(Default)</p> <p>If the spreadsheet contains only one sample, the From Spreadsheet block outputs the corresponding data value.</p> <p>If the spreadsheet contains more than one sample, the From Spreadsheet block linearly extrapolates using data values of the last two samples:</p> <ul style="list-style-type: none"> • For double data, extrapolates the value using the last two samples • For Boolean data, outputs the last data value • For a built-in data type other than double or Boolean: <ul style="list-style-type: none"> • Upcasts the data to double. • Performs linear extrapolation (as described above for double data). • Downcasts the extrapolated value to the original data type. <p>You cannot use the Linear extrapolation option with enumerated (enum) data.</p> |
| Hold last value | Uses the last data value in the file |
| Ground value | <p>Uses a value that depends on the data type of spreadsheet sample data values:</p> <ul style="list-style-type: none"> • Fixed-point data types — Uses the ground value • Numeric types other than fixed-point — uses 0 • Boolean — Uses false • Enumerated data types — Uses default value |

Dependencies

To enable this parameter, set **Treat first column as** to **Time**.

Programmatic Use

Parameter: ExtrapolationAfterLastDataPoint

Type: character vector

Values: 'Linear extrapolation' | 'Hold last value' | 'Ground value'

Default: 'Linear extrapolation'

Output after last data point — Action after last data point

Repeating sequence (default) | Hold final value | Ground value

Select action after last data point:

- **Repeating sequence** — Repeat the sequence by reading the data from the first row of the range specified in **Range**
- **Hold final value** — Output the last defined value for the remainder of the simulation.
- **Ground value** — Output a ground value depending on the data type value specified in **Output data type**.

Dependencies

To enable this parameter, set **Treat first column as** to Data.

Programmatic Use

Parameter: OutputAfterLastPoint

Type: character vector

Values: 'Repeating sequence' | 'Hold final value' | 'Ground value'

Default: 'Repeating sequence'

Enable zero-crossing detection — Enable zero-crossing detection

off (default) | on

Select to enable zero-crossing detection.

The “Zero-Crossing Detection” parameter applies only if the **Sample time** parameter is set to 0 (continuous).

Simulink uses a technique known as zero-crossing detection to locate accurately a discontinuity, without resorting to excessively small time steps. In this context, zero-crossing is used to represent discontinuities.

For the From Spreadsheet block, zero-crossing detection can only occur at time stamps in the file. Simulink examines only the time stamps, not the data values.

If the input array contains duplicate time stamps (more than one entry with the same time stamp), Simulink detects a zero crossing at that time stamp. For example, suppose that the input array has this data.

```
time:    0 1 2 2 3
signal:  2 3 4 5 6
```

At time 2, there is a zero crossing from the input signal discontinuity.

For data with nonduplicate time stamps, zero-crossing detection depends on the settings of the following parameters:

- **Data extrapolation before first data point**
- **Data interpolation within time range**
- **Data extrapolation after last data point**

The block applies the following rules when determining when:

- Zero-crossing occurs for the first time stamp
- For time stamps between the first and last time stamp
- For the last time stamp

| Time Stamp | When Zero-Crossing Detection Occurs |
|------------------------|---|
| First | Data extrapolation before first data point is set to Ground value. |
| Between first and last | Data interpolation within time range is set to Zero-order hold. |

| Time Stamp | When Zero-Crossing Detection Occurs |
|------------|--|
| Last | One or both of these settings occur: <ul style="list-style-type: none"> • Data extrapolation after last data point is set to Ground value. • Data interpolation within time range is set to Zero-order hold. |

The following figure illustrates zero-crossing detection for data accessed by a From Spreadsheet block that has these settings:

- **Data extrapolation before first data point** – Linear extrapolation
- **Data interpolation within time range** (for internal points) – Zero order hold
- **Data extrapolation after last data point** – Linear extrapolation

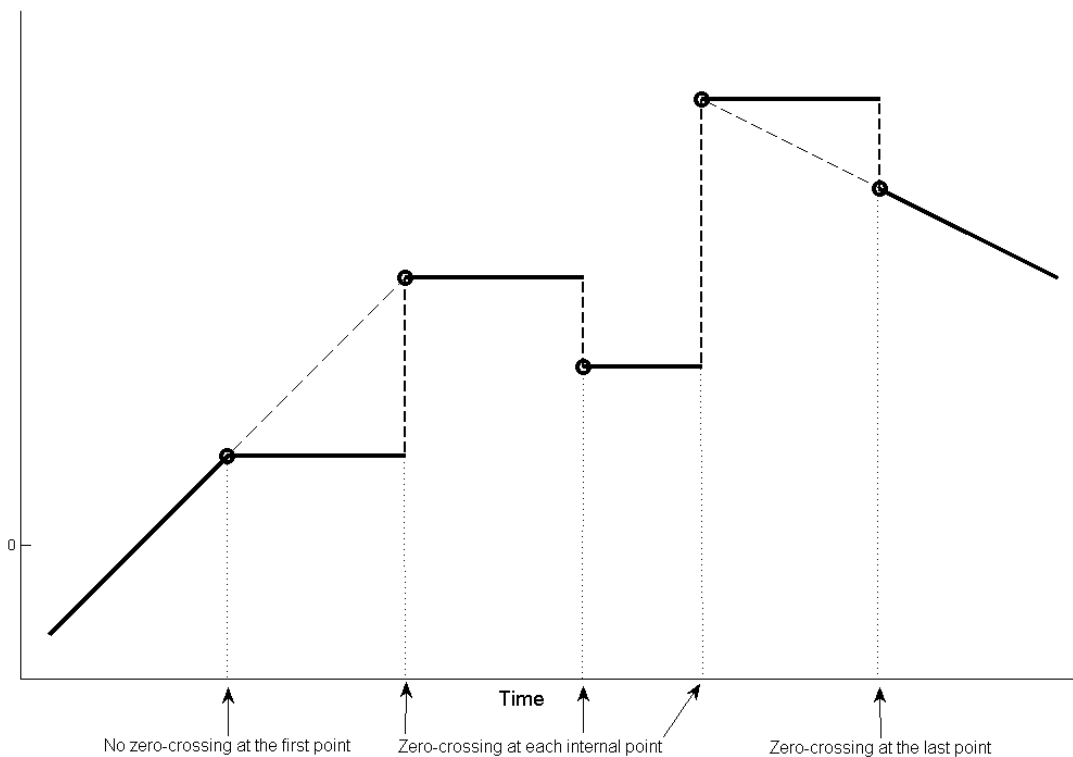

The following figure is another illustration of zero-crossing detection for data accessed by a From Spreadsheet block. The block has these settings for the time stamps (points):

- **Data extrapolation before first data point** – Hold first value
- **Data interpolation within time range** – Zero order hold
- **Data extrapolation after last data point** – Hold last value

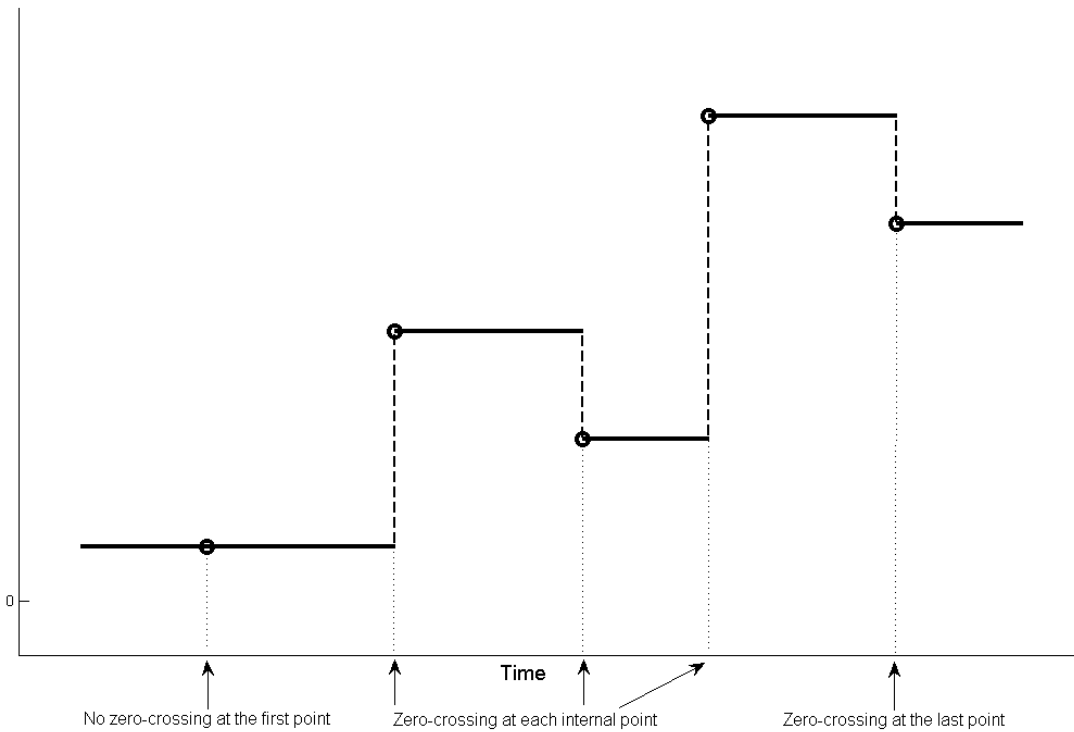

Programmatic Use
Block Parameter: ZeroCross
Type: character vector
Values: 'off' | 'on'
Default: 'off'

Block Characteristics

| | |
|---------------------------------|---|
| Data Types | Boolean double enumerated fixed point ^a integer single |
| Direct Feedthrough | no |
| Multidimensional Signals | no |
| Variable-Size Signals | no |
| Zero-Crossing Detection | yes |

a. Supports up to 32-bit fixed-point data types.

Algorithms

When the From Spreadsheet block reads data from a spreadsheet, it reads all signals with double precision and then casts them to the data type specified in the **Output data type** parameter for the output signal. During casting, the block uses rounding mode and saturation on integer overflow as follows.

Rounding Mode

The From Spreadsheet block rounds positive and negative numbers toward negative infinity. This mode is equivalent to the MATLAB `floor` function.

Saturation on Integer Overflow

For data type conversion, the From Spreadsheet block deals with saturation overflow by wrapping to the appropriate value that the data type can represent. For example, the number 130 does not fit in a signed 8-bit integer and wraps to -126.

Extended Capabilities

C/C++ Code Generation

Generate C and C++ code using Simulink® Coder™.

- Not recommended for production code.
- Code generation for RSim target provides identical support as Simulink; all other code generation targets support only double, one-dimensional, real signals in array with time format.
- Simulating in accelerator, rapid accelerator, model reference accelerator mode, or model reference rapid accelerator mode behaves the same way, and has the same requirements, as simulating in normal mode.
- The From Spreadsheet block does not support generating code that involves building ERT or GRT targets, or using SIL or PIL simulation modes.

Fixed-Point Conversion

Design and simulate fixed-point systems using Fixed-Point Designer™.

Supports up to 32-bit fixed-point data types.

See Also

From File | From Workspace

Topics

“Overview of Signal Loading Techniques”
“Comparison of Signal Loading Techniques”
“Spreadsheets”

Introduced in R2015b

From Workspace

Load signal data from workspace into Simulink model

Library: Simulink / Sources

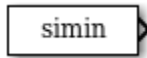

Description

The From Workspace block reads data into a Simulink model from a workspace and provides the data as a signal or bus at the block's output. You can load data from the base workspace, model workspace, or mask workspace. You can use the From Workspace block to load signal data into any model or subsystem in a model hierarchy from a workspace accessible to the referenced model or subsystem.

You can specify how the block constructs the output from the workspace data, including the output sample period, interpolation and extrapolation behavior, and whether to use zero-crossing detection.

The From Workspace block icon shows the value of the **Data** parameter. For example, if you use the From Workspace block to load data in the variable *x*, you specify *x* as the value for the **Data** parameter, and the block displays *x*.

Specify Data to Load

Specify data for the From Workspace block to load using the **Data** parameter. You can specify the value of the **Data** parameter as a MATLAB expression, such as a variable name. The expression in the **Data** parameter must evaluate to data in a format that the From Workspace block supports. For details about how the expression is evaluated, see “Symbol Resolution”.

The From Workspace block does not load data from a data dictionary. Use a data dictionary to store only design data for a model, not simulation input data. You can store design data related to the From Workspace block, such as the value for the **Sample time** parameter, in a data dictionary.

Ports

Output

Port_1 — Data loaded from workspace

scalar | matrix | bus | array of buses

Data loaded from workspace, provided at the block output as a signal or bus. Depending on the data you load, the output signal may be a scalar, multidimensional, or variable-size signal, a bus, or an array of buses. The From Workspace block supports loading real and complex data of all built-in data types except `int64` and `uint64`.

Data Types: `single` | `double` | `half` | `int8` | `int16` | `int32` | `uint8` | `uint16` | `uint32` | `Boolean` | `fixed point` | `enumerated` | `bus`

Parameters

Data — Data to load from workspace

`timeseries` object | `timetable` object | structure | 2-D array | MATLAB expression

Data to load from workspace, specified as a variable name or MATLAB expression that evaluates to data in a format supported by the From Workspace block. The expression could create the data the From Workspace block provides at its output, or it could reference a workspace variable that contains the data to load. For more information about how the expression is evaluated, see “Symbol Resolution”.

The From Workspace block can load data for scalar, multidimensional, and variable-size signals as well as data for a bus or array of buses. The From Workspace block supports loading data in these formats:

- `timeseries` object
- `timetable` object
- `Simulink.SimulationData.Signal` object
- Structure that represents bus data. The structure hierarchy must match the hierarchy of the bus and use `timeseries` and `timetable` objects to represent the signal data.
- Structure that represents data for a single signal, with fields and hierarchy that match the `Structure` or `Structure with time` logging format.
- Two-dimensional array that represents data for a single signal. The first column in the array represents time and one or more additional columns contain the signal data.

For details, see “Load Data Using the From Workspace Block”.

When you load data for a bus, specify the **Output data type** parameter as the `Simulink.Bus` object that defines the bus.

Real signals of type `double` can be in any data format that the From Workspace block supports. For complex signals and real signals of a data type other than `double`, use any format except `Array`.

The From Workspace block supports loading variable-size signal data in the `Structure` or `Structure with time` formats.

Programmatic Use

Block Parameter: `VariableName`

Type: character vector

Values: MATLAB expression | `timeseries` object | `timetable` object | structure | 2-D array

Default: `'simin'`

Output data type — Loaded workspace data type

Inherit: `auto` (default) | `double` | `single` | `half` | `int8` | `uint8` | `int16` | `uint16` | `int32` | `uint32` | `boolean` | `fixdt(1,16,0)` | `fixdt(1,16,2^0,0)` | Enum: `<class_name>` | Bus: `<bus_object>` | `<data type expression>`

Data type of the workspace data the From Workspace block loads. By default, the From Workspace block inherits the output signal data type from the workspace data or from a downstream block that defines the data type for the signal.

When you load data for a scalar or multidimensional signal, you can choose to inherit the output data type or you can specify the output data type to match the data type of the workspace data.

To load data for a bus or an array of buses, set the **Output data type** to Bus: <bus_object> and specify the name of the Simulink.Bus object that defines the output bus.

When you load enumerated data, set the **Output data type** to Enum: <class_name> and specify the name of the enumeration class that defines the enumerated data values.

Click the **Show data type assistant** button  to display the **Data Type Assistant**, which helps you set the data type attributes. For more information, see “Specify Data Types Using Data Type Assistant”.

Programmatic Use

Block Parameter: OutDataTypeStr

Type: character vector

Values: 'Inherit: auto' | 'double' | 'single' | 'half' | 'int8' | 'uint8' | 'int16' | 'uint16' | 'int32' | 'uint32' | 'boolean' | 'fixdt(1,16,0)' | 'fixdt(1,16,2^0,0)' | 'Enum: <class name>' | 'Bus: <object name>' | '<data type expression>'

Default: 'Inherit: auto'

Sample time — Output sample period and optional time offset

0 (default) | scalar | vector

The **Sample time** parameter specifies when the block computes a new output value during simulation. For details, see “Specify Sample Time”.

Specify the **Sample time** parameter as a scalar when you do not want the output to have a time offset. To add a time offset to the output, specify the **Sample time** parameter as a 1-by-2 vector where the first element is the sampling period and the second element is the offset.

By default, the **Sample time** parameter value is 0, which indicates continuous sample time with no time offset. For a discrete signal, specify the **Sample time** as the discrete sampling interval. For example, specify the **Sample time** as 0.1 to model a discrete signal sampled every 100ms. Specify the **Sample time** as -1 to inherit the value.

Programmatic Use

Block Parameter: SampleTime

Type: character vector

Values: scalar | vector

Default: '0'

Interpolate data — Interpolation method

on (default) | off

Interpolation method used to provide output values for simulation times that are in between time values in the loaded workspace data. When you select **Interpolate data**, the From Workspace block linearly interpolates an output value using adjacent values in the loaded workspace data. When **Interpolate data** is not selected, the From Workspace block provides the value of the previous data point in the loaded workspace data. For more information about the interpolation algorithm, see “Interpolation” on page 1-659.

When you load enumerated, fixed-point, or variable-size signal data, clear the **Interpolate data** parameter.

To provide output values after the last value in the loaded workspace data, the From Workspace block uses a combination of the **Interpolate data** parameter and the **Form output after final data value by** parameter.

The **Interpolate data** parameter value also affects how the From Workspace block extrapolates output values for simulation times prior to the first data point in the loaded workspace data. When **Interpolate data** is selected, the From Workspace block uses the first two data points in the workspace data to linearly extrapolate output values for simulation times prior to the first data point. When **Interpolate data** is not selected, the block provides ground as the output value for simulation times prior to the first workspace data point. For complete information regarding the From Workspace block extrapolation behavior, see “Extrapolation” on page 1-660.

Programmatic Use

Block Parameter: Interpolate

Type: character vector

Values: 'off' | 'on'

Default: 'on'

Enable zero-crossing detection — Zero-crossing detection

on (default) | off

Zero-crossing detection is a technique used to locate discontinuities in the block output and avoid using excessively small time steps near the discontinuities, which can slow down a simulation. A zero crossing refers to a discontinuity in the data. You can enable zero-crossing detection for the From Workspace block when the sample time is continuous (0).

The loaded workspace data creates a discontinuity in the block output when the data includes multiple samples with the same time. For example, for this input data, a discontinuity occurs at time 2.

```
time:    0 1 2 2 3
signal:  2 3 4 5 6
```

The From Workspace block can also create a discontinuity in the output at the last sample in the workspace data when you set **Form output after final data value by** to Setting to zero.

When you load input data for a bus, the From Workspace block detects zero crossings for all bus elements.

For more information, see “Zero-Crossing Detection”.

Programmatic Use

Block Parameter: ZeroCross

Type: character vector

Values: 'off' | 'on'

Default: 'on'

Form output after final data value by — Method to determine block output after final data point

Extrapolation (default) | Setting to zero | Holding final value | Cyclic repetition

The From Workspace block uses the **Interpolate data** and **Form output after final data value by** settings to determine the block output for simulation times after the last sample available in the workspace data.

| Setting for Form output after final data value by | Setting for Interpolate data | Block Output After Final Data |
|---|------------------------------|--|
| Extrapolation | On | Extrapolated from final data value |
| | Off | Error |
| Setting to zero | On | Zero |
| | Off | |
| Holding final value | On | Final value from workspace |
| | Off | |
| Cyclic repetition | On | Error |
| | Off | When the loaded workspace data uses the structure without time format, repeats workspace data from the first value. Errors for workspace data formats other than structure with time. |

For complete information regarding the From Workspace block extrapolation behavior, see “Extrapolation” on page 1-660.

Programmatic Use

Block Parameter: OutputAfterFinalValue

Type: character vector

Values: 'Extrapolation' | 'Setting to zero' | 'Holding final value' | 'Cyclic repetition'

Default: 'Extrapolation'

Block Characteristics

| | |
|---------------------------------|---|
| Data Types | Boolean bus double enumerated fixed point ^a half integer single string |
| Direct Feedthrough | no |
| Multidimensional Signals | yes |
| Variable-Size Signals | yes |
| Zero-Crossing Detection | yes |

a. Supports input via fi objects created using Fixed-Point Designer.

Tips

- The From Workspace block supports loading partially specified data for a bus. To partially specify bus data, set bus elements for which you do not need to load data to [].
- To load data that was logged in array format using the To File block, transpose the array so that the time values are in a single column rather than a single row. You can use the transpose function and save the transposed data to a new file.
- For programmatic simulations using the sim, parsim, or batchsim functions, you can use the Simulink.SimulationInput object to specify the data for the From Workspace block to load.

Algorithms

Interpolation

Interpolation is the process the From Workspace block uses to provide output values for simulation times that are between sample times in the loaded workspace data. When you select **Interpolate data**, the From Workspace block linearly interpolates the output value using two adjacent points in the workspace data. When you do not select **Interpolate data**, the From Workspace block uses the value of the prior workspace data point as the output value. For example, this model has one From Workspace block with **Interpolate data** selected and another with **Interpolate data** cleared. Both blocks load the same sine wave data from the base workspace.

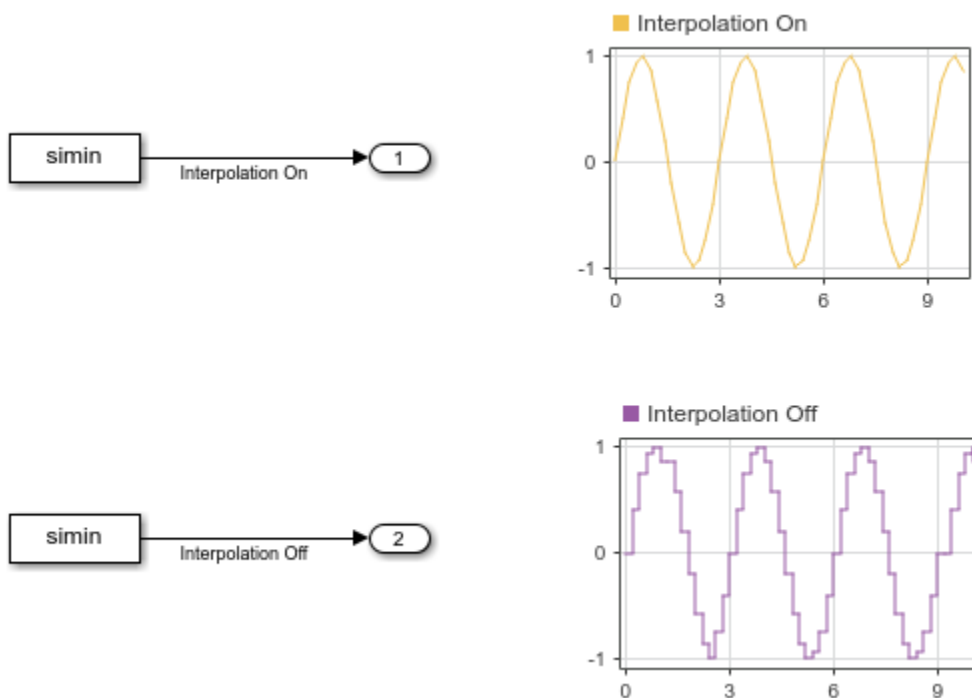

When you select the **Interpolate data** parameter, the From Workspace block performs different steps, depending on the type of data you load.

For **double** data, the From Workspace block linearly interpolates the value using the workspace data values before and after the simulation time.

For **Boolean** data, if the simulation time is between two workspace data points with different values, the From Workspace block positions the value transition halfway between the workspace data points. For example, if the workspace data transitions from **true** to **false**, the From Workspace data provides an output value of **true** for simulation times in the first half of the interval between the workspace data points and provides an output value of **false** for simulation times in the latter half of the interval.

For built-in data types other than **double** and **Boolean**, the From Workspace block performs these steps:

- 1 Upcast the data to **double** data type.

- 2 Linearly interpolate the output value using the double values.
- 3 Downcast the interpolated value to the original data type.

Extrapolation

Extrapolation is the process the From Workspace block uses to provide output values for simulation times that are before the first data point and after the last data point in the loaded workspace data. You can control how the From Workspace block extrapolates output values before the first workspace data value using the **Interpolate data** parameter. Use the **Interpolate data** and **Form output after final data value by** parameters to specify how the block extrapolates output values for simulation times after the final workspace data point.

| Interpolate data | Output Before First Data Point | Form output value after final data by | Output After Final Data Point |
|------------------|---|---------------------------------------|--|
| On | Linearly extrapolated using first two workspace data points | Extrapolation | Linearly extrapolated using final two workspace data values |
| | | Setting to zero | Zero |
| | | Holding final value | Final workspace data value |
| | | Cyclic repetition | Error |
| Off | Zero | Extrapolation | Error |
| | | Setting to zero | Zero |
| | | Holding final data value | Final workspace data value |
| | | Cyclic repetition | When the loaded workspace data uses the structure without time format, repeats workspace data from the first value. Errors for workspace data formats other than structure with time. |

For example, consider this model that has a From Workspace block with **Interpolate data** enabled and **Form output after final data value by** set to **Extrapolation**. The From Workspace block reads workspace data that was created by logging the output of the Sine Wave block for a 16-second simulation. The Dashboard Scope blocks display the Sine Wave block output and the From Workspace block output for a 20-second simulation. After the simulation reaches 16 seconds, the From Workspace block output diverges from the Sine Wave block output as the From Workspace block linearly extrapolates output values for the remainder of the simulation.

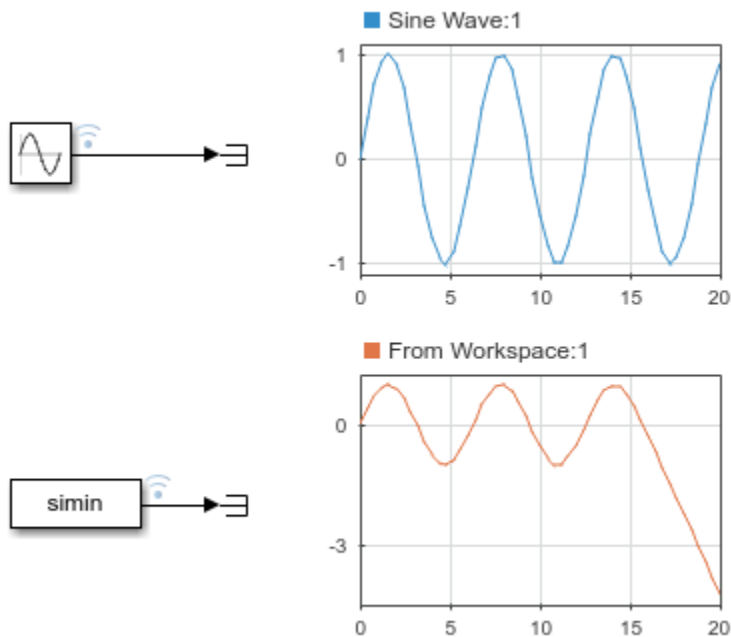

Extended Capabilities

C/C++ Code Generation

Generate C and C++ code using Simulink® Coder™.

Not recommended for production code.

The workspace data the From Workspace block loads is hard coded in the generated code.

Fixed-Point Conversion

Design and simulate fixed-point systems using Fixed-Point Designer™.

Supports input via `fi` objects created using Fixed-Point Designer.

See Also

[To Workspace](#) | [From File](#) | [To File](#) | [From Spreadsheet](#) | [Inport](#) | [Outport](#)

Topics

- “Comparison of Signal Loading Techniques”
- “Load Data to Test a Discrete Algorithm”
- “Use From Workspace Block for Test Case”
- “Load Signal Data That Uses Units”
- “Load Signal Data for Simulation”

Introduced before R2006a

Function-Call Feedback Latch

Break feedback loop involving data signals between function-call blocks

Library: Simulink / Ports & Subsystems



Description

Use the Function-Call Feedback Latch block to break a feedback loop of data signals between one or more function-call blocks. Specifically, break a feedback loop formed in one of the following ways.

- **When function-call blocks connect to branches of the same function-call signal**

Place the Function-Call Feedback Latch block on the feedback signal between the branched blocks. As a result, the latch block delays the signal at the input of the destination function-call block, and the destination function-call block executes prior to the source function-call block of the latch block.

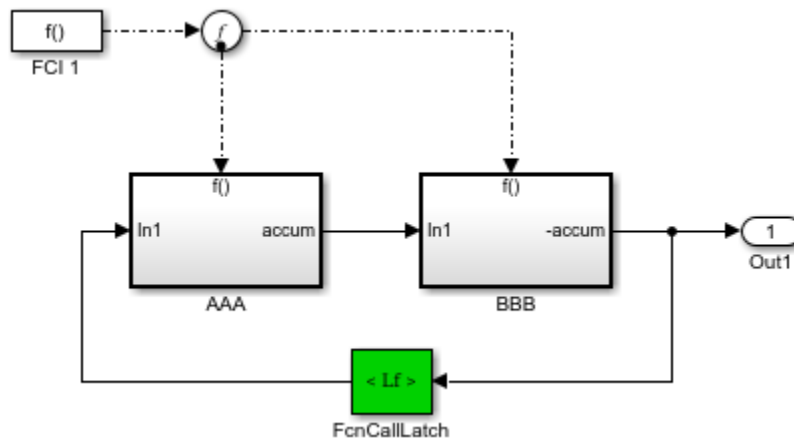

To run this model, see “Function-Call Blocks Connected to Branches of the Same Function-Call Signal” on page 12-158.

- **When the loop involves parent and child function-call blocks, where the child initiator is inside the parent**

Place the Function-Call Feedback Latch block on the feedback signal between the child and the parent. This arrangement prevents the signal value, read by the parent (FCSS1), from changing during execution of the child. In other words, the parent reads the value from the previous execution of the child (FCSS2).

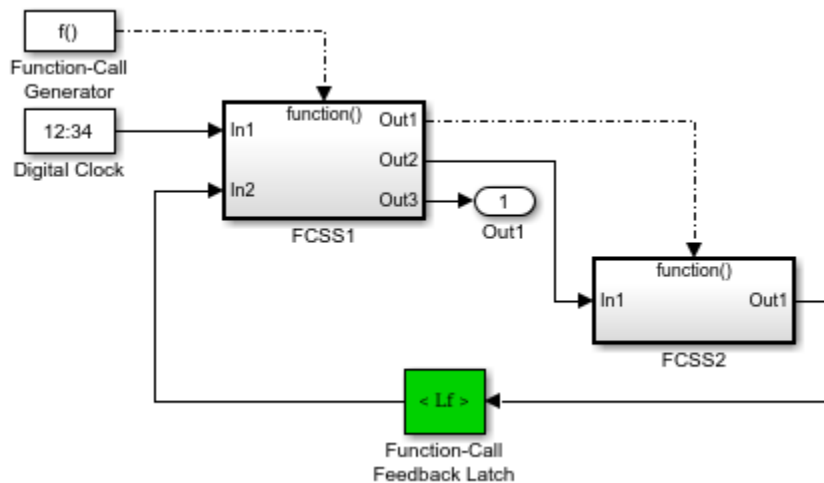

To run this model, see “Function-Call Feedback Latch on Feedback Signal Between Child and Parent” on page 12-159.

Using the latch block is equivalent to selecting the **Latch input for function-call feedback signals** check box on the Inport block in the destination function-call subsystem or model. However, an advantage of the latch block over using the dialog parameter is that one can design the destination function-call subsystem or model in a modular fashion and then use it either in or out of the context of loops.

The Function-Call Feedback Latch block is better suited than Unit Delay or Memory blocks in breaking function-call feedback loops for the following reasons:

- The latch block delays the feedback signal for exactly one execution of the source function-call block. This behavior is different from the Unit Delay or Memory blocks for cases where the function-call subsystem blocks may execute multiple times in a given simulation step.
- Unlike the Unit Delay or Memory blocks, the latch block may be used to break loops involving asynchronous function-call subsystems.
- The latch block can result in better performance, in terms of memory optimization, for generated code.

Ports

Input

In — Signal from a function-call subsystem block

scalar | vector | matrix

Data Types: single | double | int8 | int16 | int32 | int64 | uint8 | uint16 | uint32 | uint64 | Boolean | fixed point | enumerated | bus

Output

Out — Signal to a function-call subsystem

scalar | vector | matrix

Data Types: single | double | int8 | int16 | int32 | int64 | uint8 | uint16 | uint32 | uint64 | Boolean | fixed point | enumerated | bus

Block Characteristics

| | |
|---------------------------------|--|
| Data Types | Boolean bus double enumerated fixed point integer single |
| Direct Feedthrough | no |
| Multidimensional Signals | yes |
| Variable-Size Signals | no |
| Zero-Crossing Detection | no |

Extended Capabilities

C/C++ Code Generation

Generate C and C++ code using Simulink® Coder™.

Fixed-Point Conversion

Design and simulate fixed-point systems using Fixed-Point Designer™.

See Also

Function-Call Subsystem | Function-Call Generator | Function-Call Feedback Latch | Function-Call Split | Trigger

Topics

“Using Function-Call Subsystems”

Introduced in R2011a

Function-Call Generator

Provide function-call events to control execution of subsystem or model

Library: Simulink / Ports & Subsystems



Description

The Function-Call Generator block provides function-call events that execute a function-call subsystem or function-call model at the rate you specify with the **Sample time** parameter. A function-call subsystem or function-call model is a subsystem or model containing a Trigger block with its **Trigger type** parameter set to `function-call`.

To iteratively execute each function-call subsystem or function-call model multiple times at each time step, use the **Number of iterations** parameter.

To execute multiple function-call subsystems or function-call models in a specified order, use the Function-Call Generator block with a Function-Call Split block. For an example, see Function-Call Split.

To execute a function-call subsystem or function-call model intermittently, meaning not at every time step, select the **Show enable port** parameter. You can then use the input at the enable port to control when the block outputs function-call events. In effect, you can turn the block on and off as needed.

Ports

Input

Enable — Control signal input

scalar

The block outputs function-call events only when the input at this port is a positive number.

Dependencies

To enable this port, select the **Show enable port** check box.

Output

Function Call — Function-call event output

scalar | vector

Sends function-call events to the function-call input port of a function-call subsystem or function-call model.

Parameters

Sample time — Specify time interval

1 (default) | scalar | vector | -1

Specify the time interval between function-call events to a function-call subsystem or function-call model. If the actual calling rate for the subsystem or model differs from the time interval this parameter specifies, Simulink displays an error.

By default, the block uses a time interval of 1. To set a different interval, enter a valid sample time based on the table in “Types of Sample Time”, or specify -1 to inherit the time interval from the model.

Dependencies

To enable this parameter, clear the **Show enable port** check box. If you select **Show enable port**, sample time is automatically set to -1 (inherited).

Programmatic Use

Block Parameter: sample_time

Type: character vector

Values: '1' | scalar expression | vector expression | '-1'

Default: '1'

Number of iterations — Specify number of times to provide a function-call at each time step

1 (default) | integer

The value of this parameter can be a vector, where each element of the vector specifies a number of times to execute a function-call subsystem or model. If a vector is specified, then the block outputs a vector of function-call events, which can be split into individual function-call events using a Demux block and used to drive multiple function-call subsystems or models.

Suppose that you specify **Number of iterations** to be [3 2] and connect the output of this block to a Demux block, which is connected to the control ports of two function-call subsystems. In this case, the first function-call subsystem executes three times at each time step, and the second function-call subsystem executes two times at each time step.

If, however, you connect the output of this block to a single function-call subsystem or model, the total number of times that the function-call subsystem or model executes per time step is equal to the sum of the vector element values. So in the example above, specifying **Number of iterations** to be [3 2] and connecting the output of this block to a single function-call subsystem results in the function-call subsystem executing five times at each time step.

Settings

1

Provide function-call once during each time step.

integer

Signed or unsigned integer number. Provide the specified number of function calls at each time step.

Programmatic Use

Block Parameter: numberOfIterations

Type: character vector

Values: '1' | '<integer>' '<vector of integers>'

Default: '1'

Disallow wide output — Prevent implicit expansion of output signal

off (default) | on

Unless this parameter is selected, the output of this block is expanded into a vector, if necessary, to drive the blocks to which it is connected. For example, if **Number of iterations** is set to 2 and **Disallow wide output** is not selected, and the output of this block is connected to a Demux block, which is in turn connected to three separate function-call subsystems, then each function-call subsystem receives two function-call events at each time step. A similar result occurs if the output of this block is connected to a Stateflow chart with multiple events. If **Disallow wide output** is selected in these situations, Simulink produces an error.

Select this parameter to prevent implicit expansion of the output signal.

Clear this parameter to allow implicit expansion of the output signal when appropriate.

Programmatic Use

Block Parameter: DisallowWideOutput

Type: character vector

Values: 'off' | 'on'

Default: 'off'

Show enable port — Add input port for control signal

off (default) | on

Select this parameter to add a control signal input port to the block. The block outputs function-call events only when the value at the control signal input port is a positive number.

Clear this parameter to remove the control signal input port. The block outputs function-call events at every time step.

Programmatic Use

Block Parameter: ShowEnablePort

Type: character vector

Values: 'off' | 'on'

Default: 'off'

Block Characteristics

| | |
|---------------------------------|----|
| Data Types | |
| Direct Feedthrough | no |
| Multidimensional Signals | no |
| Variable-Size Signals | no |
| Zero-Crossing Detection | no |

Extended Capabilities

C/C++ Code Generation

Generate C and C++ code using Simulink® Coder™.

See Also

Function-Call Subsystem | Function-Call Feedback Latch | Function-Call Split | Trigger

Topics

“Using Function-Call Subsystems”

Introduced before R2006a

Function-Call Split

Provide junction for splitting function-call line

Library: Simulink / Ports & Subsystems



Description

The Function-Call Split block allows a function-call line to branch and connect to several function-call subsystems or function-call models.

The function-call subsystem or function-call model connected to the output port of the Function-Call Split block that is marked with a dot executes before the subsystems or models connected to other output ports. If data dependencies between subsystems or models do not support the specified execution order, the Function-Call Split block returns an error. To eliminate this error, consider selecting the **Latch input for feedback signals of function-call subsystem outputs** parameter on one or more Inport blocks of the function-call subsystems or models involved in a data-dependency loop. Selecting this option delays the corresponding function-call, thereby eliminating the data-dependency loop.

If you select the model menu option **Display > Blocks > Sorted Execution Order**, then the execution order of function-call subsystems connected to branches of a given function-call signal appears on the blocks. Each subsystem has an execution order of the form $s : [B\#]$, where $\#$ is a number that ranges from 0 to one less than the total number of subsystems or models connected to branches of a given signal. The subsystems execute in ascending order based on this number.

The Function-Call Split block supports "Signal Label Propagation".

The following model shows how to apply the **Latch input for feedback signals of function-call subsystem outputs** parameter to work around a data-dependency error caused by a Function-Call Split block. By turning this parameter on in the f1 subsystem's Inport block, the Function-Call Split block ignores the data dependency of signal b. The block breaks the loop of data dependencies between subsystems f1 and g1. The model achieves the behavior of consistently calling f1 to execute before g1. For a given execution step, subsystem f1 uses the g1 output computed at the previous execution step.

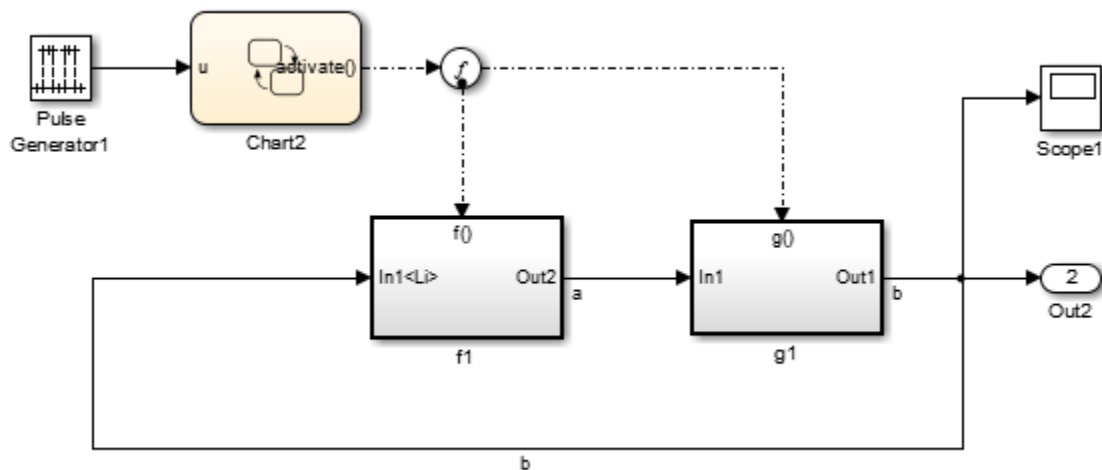

Limitations

The Function-Call Split block has these limitations:

- All function-call subsystems and models connected to a given function-call signal must reside within the same nonvirtual layer of the model hierarchy.
- You cannot connect branched function-call subsystems or models and their children directly back to the function-call initiator.
- Function-call subsystems and models connected to branches of a function-call signal cannot have multiple (muxed) initiators.
- A Function-Call Split block cannot have its input from a signal with multiple function-call elements.

Ports

Input

Function Call – Function-call line

scalar

A Function-Call Generator block, an S-Function block, a Hit Crossing block, or a Stateflow chart can provide function-call events.

Output

Function Call – Function-call signal

scalar

Function-call line connected to a function-call subsystem or function-call model.

Parameters

Icon shape — Select block icon shape

`distinctive` (default) | `round`

Select block icon shape.

Settings

`distinctive`

Rectangular block icon.

`round`

Circular block icon.

Programmatic Use

Block Parameter: `IconShape`

Type: character vector

Values: `'distinctive'` | `'round'`

Default: `'distinctive'`

Number of output ports — Specify number of output ports

`2` (default) | `integer`

Specify the number of function-call signal output ports.

Settings

`2`

Two function-call output ports.

`integer`

Integer number

Programmatic Use

Block Parameter: `NumOutputPorts`

Type: character vector

Values: `'2'` | `'<integer>'`

Default: `'2'`

Output port layout — Select order of output ports

`default` (default) | `reverse`

Select the order of function-call output ports with respect to which port provides a function-call first.

Settings

`default`

Top port provides function-call first.

`reverse`

Bottom port provides function-call first.

Programmatic Use

Block Parameter: `OutputPortLayout`

Type: character vector

Values: 'default' | 'reverse'

Default: 'default'

Block Characteristics

| | |
|---------------------------------|--------|
| Data Types | double |
| Direct Feedthrough | no |
| Multidimensional Signals | no |
| Variable-Size Signals | no |
| Zero-Crossing Detection | no |

Extended Capabilities

C/C++ Code Generation

Generate C and C++ code using Simulink® Coder™.

See Also

Function-Call Subsystem | Function-Call Generator | Function-Call Feedback Latch

Topics

“Using Function-Call Subsystems”

Introduced in R2010a

Function-Call Subsystem

Subsystem whose execution is controlled by external function-call input

Library: Simulink / Ports & Subsystems

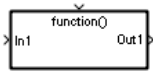

Description

The Function-Call Subsystem block is a Subsystem block preconfigured as a starting point for creating a subsystem that executes when a function-call input port receives a function-call event. A Stateflow chart, Function-Call Generator block, S-Function block, or Hit Crossing block can provide function-call events. See “Using Function-Call Subsystems”.

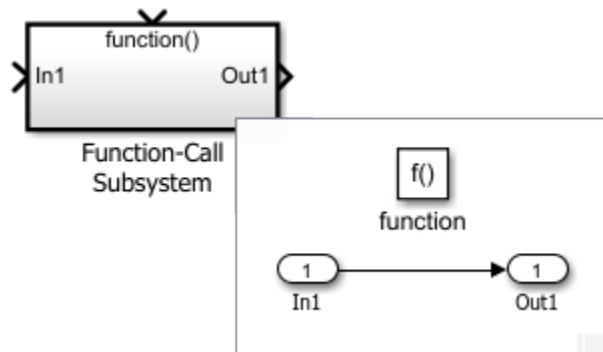

Use Function-Call Subsystem blocks to:

- Schedule the execution order of model components.
- Control the rate of model component execution.

Simulink ignores any priority set on a Function-Call Subsystem block, but you can set the priority on a block connected to the subsystem's function-call port. The function-call port can receive a function-call event from a Stateflow chart, MATLAB Function block, Function-Call Generator block, S-Function block, or Hit Crossing block.

For an explanation of the Function-Call Subsystem block parameters, see Subsystem.

Ports

Input

In — Signal input to Subsystem block

scalar | vector | matrix

Signal input to a Subsystem block, specified as a scalar, vector, or matrix. Placing an Inport block in a Subsystem block adds an external input port to the block. The port label matches the name of the Inport block.

Use Inport blocks to receive signals from the local environment.

Data Types: `single` | `double` | `int8` | `int16` | `int32` | `int64` | `uint8` | `uint16` | `uint32` | `uint64` | `Boolean` | `fixed point` | `enumerated` | `bus`

Function Call – Function-call input to Subsystem block

scalar

A Trigger block in a Subsystem block adds an external input port to the block. A **Trigger type** of `function-call` makes the block a Function-Call port block that accepts function-call events.

Output

Out – Signal output from Subsystem block

scalar | vector | matrix

Signal output from a Subsystem block, returned as a scalar, vector, or matrix. Placing an Outport block in a Subsystem block adds an external output port to the block. The port label matches the name of the Outport block.

Use Outport blocks to send signals to the local environment.

Data Types: `single` | `double` | `int8` | `int16` | `int32` | `int64` | `uint8` | `uint16` | `uint32` | `uint64` | `Boolean` | `fixed point` | `enumerated` | `bus`

Block Characteristics

| | |
|---------------------------------|---|
| Data Types | <code>Boolean^a</code> <code>bus^a</code> <code>double^a</code> <code>enumerated^a</code> <code>fixed point^a</code> <code>half^a</code> <code>integer^a</code> <code>single^a</code> <code>string^a</code> |
| Direct Feedthrough | no |
| Multidimensional Signals | limited ^a |
| Variable-Size Signals | limited ^a |
| Zero-Crossing Detection | no |

a. Actual data type or capability support depends on block implementation.

Extended Capabilities

C/C++ Code Generation

Generate C and C++ code using Simulink® Coder™.

Actual code generation support depends on block implementation.

PLC Code Generation

Generate Structured Text code using Simulink® PLC Coder™.

Fixed-Point Conversion

Design and simulate fixed-point systems using Fixed-Point Designer™.

Actual data type support depends on block implementation.

See Also

[Function-Call Generator](#) | [Function-Call Feedback Latch](#) | [Function-Call Split](#) | [Subsystem](#)

Topics

[“Using Function-Call Subsystems”](#)

Introduced before R2006a

Function Caller

Call Simulink or exported Stateflow function

Library: Simulink / User-Defined Functions

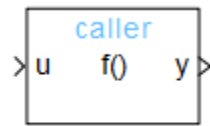

Function Caller

Description

A Function Caller block calls and executes a function defined with a Simulink Function block or an exported Stateflow function. Using Function Caller blocks, you can call a function from anywhere in a model or chart hierarchy.

You can select a Simulink Function or Function Caller block to highlight blocks related to it. To show a related block in an open diagram or new tab, pause on the ellipsis that appears after selection.

Then, select **Related Blocks**  from the action bar. When multiple blocks correspond to the selected block, a list of related blocks opens. You can filter the list of related blocks by entering a search term in the text box. After you select a related block from the list, window focus goes to the open diagram or new tab that shows the related block.

Ports

Input

Input argument — Input signal for an input argument

scalar | vector | matrix

Input signal for an input argument that is sent to the function.

The function prototype determines the number and name of input ports that appear on the Function Caller block. Connect signal lines to the input ports to send data to a function through the function input arguments.

For example, `y = myfunction(u)` creates one input port (u) on the Function Caller block.

Data Types: single | double | int8 | int16 | int32 | int64 | uint8 | uint16 | uint32 | uint64 | Boolean | fixed point | enumerated | bus

Output

Output argument — Output signal for an output argument

scalar | vector | matrix

Output signal for an output argument that the function returns.

The function prototype determines the number and name of output ports that appear on the Function Caller block. Connect signal lines to the output ports to receive data from a function through the function output arguments.

For example, `y = myfunction(u)` creates one output port (`y`) on the Function Caller block.

Data Types: `single` | `double` | `int8` | `int16` | `int32` | `int64` | `uint8` | `uint16` | `uint32` | `uint64` | `Boolean` | `fixed point` | `enumerated` | `bus`

Parameters

Function prototype — Specify function interface

`y=f(u)` (default) | `<function prototype>`

Specify the function interface between a Function Caller block and a Simulink function. A Simulink function can be a Simulink Function block, an exported Stateflow graphical function, or an exported Stateflow MATLAB function. For a call to a Simulink Function block:

- Function call argument names must match the function arguments.
- Function names, input arguments, and output arguments must be valid MATLAB identifiers.

Programmatic Use

Block Parameter: `FunctionPrototype`

Type: character vector

Values: `'y=f(u)'` | `'<function prototype>'`

Default: `'y=f(u)'`

Input argument specifications — Specify input argument data type, dimensions, and complexity

`<Enter example>` (default) | `<MATLAB expression>`

Specify a comma-separated list of MATLAB expressions that combine data type, dimensions, and complexity (real or imaginary) for each input argument. For examples, see “Argument Specification for Simulink Function Blocks”.

This specification must match the Simulink Function block data type specified with the **Data type** parameter of the Argument Inport block.

Programmatic Use

Block Parameter: `'InputArgumentSpecifications'`

Type: character vector

Values: `''` | `'<MATLAB expression>'`

Default: `''`

Output argument specifications — Specify output argument data type, dimensions, and complexity

`<Enter example>` (default) | `<MATLAB Expression>`

Specify a comma-separated list of MATLAB expressions that combine data type, dimensions, and complexity (real or imaginary) for each output argument. For examples, see “Argument Specification for Simulink Function Blocks”.

This specification must match the Simulink Function block data type specified with the **Data type** parameter of the Argument Outport Block.

Programmatic Use

Block Parameter: `'OutputArgumentSpecifications'`

Type: character vector

Values: '' | '<MATLAB expression>'

Default: ''

Sample time — Time interval between function calls

-1 (default) | <sample time>

Specify the interval between times that the Function Caller block calls the specified Simulink function.

By default, the block inherits its sample time based on the context of the block in the model.

To set a different sample time, enter a value using a sample time format from the table in “Specify Sample Time”.

If the Function Caller block has any inputs, it is a nonsource block, and you must set the sample time to -1.

Programmatic Use

Block Parameter: SampleTime

Type: character vector

Values: '-1' | *sample time*

Default: '-1'

Block Characteristics

| | |
|---------------------------------|--|
| Data Types | Boolean bus double enumerated fixed point integer single |
| Direct Feedthrough | yes |
| Multidimensional Signals | yes |
| Variable-Size Signals | no |
| Zero-Crossing Detection | no |

Extended Capabilities

C/C++ Code Generation

Generate C and C++ code using Simulink® Coder™.

Fixed-Point Conversion

Design and simulate fixed-point systems using Fixed-Point Designer™.

See Also

Argument Inport | Argument Output | Trigger | Simulink Function | MATLAB Function | Chart | Subsystem | Function-Call Subsystem | Inport | Output

Topics

“Simulink Functions Overview”

“Scoped Simulink Function Blocks in Models”

“Add a Simulink Function to a Model”

Gain

Multiply input by constant

Library: Simulink / Commonly Used Blocks
 Simulink / Math Operations
 HDL Coder / Commonly Used Blocks
 HDL Coder / HDL Floating Point Operations
 HDL Coder / Math Operations



Description

The Gain block multiplies the input by a constant value (gain). The input and the gain can each be a scalar, vector, or matrix.

You specify the value of gain in the **Gain** parameter. The **Multiplication** parameter lets you specify element-wise or matrix multiplication. For matrix multiplication, this parameter also lets you indicate the order of the multiplicands.

Gain is converted from doubles to the data type specified in the block mask offline using round-to-nearest and saturation. The input and gain are then multiplied, and the result is converted to the output data type using the specified rounding and overflow modes.

Ports

Input

Port_1 — Input signal

scalar | vector | matrix

The Gain block accepts real or complex-valued scalar, vector, or matrix input. The Gain block supports fixed-point data types. If the input of the Gain block is real and gain is complex, the output is complex.

Data Types: half | single | double | int8 | int16 | int32 | int64 | uint8 | uint16 | uint32 | uint64 | Boolean | fixed point

Output

Port_1 — Input multiplied by gain

scalar | vector | matrix

The Gain block outputs the input multiplied by a constant gain value. When the input to the Gain block is real and gain is complex, the output is complex.

Data Types: half | single | double | int8 | int16 | int32 | int64 | uint8 | uint16 | uint32 | uint64 | Boolean | fixed point

Parameters

Main

Gain — Value by which to multiply the input

1 (default) | real or complex-valued scalar, vector, or matrix

Specify the value by which to multiply the input. Gain can be a real or complex-valued scalar, vector, or matrix.

Programmatic Use

Block Parameter: Gain

Type: character vector

Values: '1' | real- or complex-valued scalar, vector, or matrix

Default: '1'

Multiplication — Specify the multiplication mode

Element-wise(K.*u) (default) | Matrix(K*u) | Matrix(u*K) | Matrix(K*u) (u vector)

Specify one of these multiplication modes:

- **Element-wise(K.*u)** — Each element of the input is multiplied by each element of the gain. The block performs expansions, if necessary, so that the input and gain have the same dimensions.
- **Matrix(K*u)** — The input and gain are matrix-multiplied with the input as the second operand.
- **Matrix(u*K)** — The input and gain are matrix-multiplied with the input as the first operand.
- **Matrix(K*u) (u vector)** — The input and gain are matrix multiplied with the input as the second operand. This mode is identical to **Matrix(K*u)**, except for how dimensions are determined.

Suppose that K is an m-by-n matrix. **Matrix(K*u) (u vector)** sets the input to a vector of length n and the output to a vector of length m. In contrast, **Matrix(K*u)** uses propagation to determine dimensions for the input and output. For an m-by-n gain matrix, the input can propagate to an n-by-q matrix, and the output becomes an m-by-q matrix.

Programmatic Use

Parameter: Multiplication

Type: character vector

Value: 'Element-wise(K.*u)' | 'Matrix(K*u)' | 'Matrix(u*K)' | 'Matrix(K*u) (u vector)'

Default: 'Element-wise(K.*u)'

Sample time — Specify sample time as a value other than -1

-1 (default) | scalar | vector

Specify the sample time as a value other than -1. For more information, see “Specify Sample Time”.

Dependencies

This parameter is not visible unless it is explicitly set to a value other than -1. To learn more, see “Blocks for Which Sample Time Is Not Recommended”.

Programmatic Use

Block Parameter: SampleTime

Type: character vector

Values: scalar or vector

Default: '-1'

Signal Attributes

Output minimum — Minimum output value for range checking

[] (default) | scalar

Lower value of the output range that Simulink checks.

Simulink uses the minimum to perform:

- Parameter range checking (see “Specify Minimum and Maximum Values for Block Parameters”) for some blocks.
- Simulation range checking (see “Specify Signal Ranges” and “Enable Simulation Range Checking”).
- Automatic scaling of fixed-point data types.
- Optimization of the code that you generate from the model. This optimization can remove algorithmic code and affect the results of some simulation modes such as SIL or external mode. For more information, see “Optimize using the specified minimum and maximum values” (Embedded Coder).

Note Output minimum does not saturate or clip the actual output signal. Use the Saturation block instead.

Programmatic Use

Block Parameter: OutMin

Type: character vector

Values: '[]' | scalar

Default: '[]'

Output maximum — Maximum output value for range checking

[] (default) | scalar

Upper value of the output range that Simulink checks.

Simulink uses the maximum value to perform:

- Parameter range checking (see “Specify Minimum and Maximum Values for Block Parameters”) for some blocks.
- Simulation range checking (see “Specify Signal Ranges” and “Enable Simulation Range Checking”).
- Automatic scaling of fixed-point data types.
- Optimization of the code that you generate from the model. This optimization can remove algorithmic code and affect the results of some simulation modes such as SIL or external mode. For more information, see “Optimize using the specified minimum and maximum values” (Embedded Coder).

Note Output maximum does not saturate or clip the actual output signal. Use the Saturation block instead.

Programmatic Use**Block Parameter:** OutMax**Type:** character vector**Values:** '[]' | scalar**Default:** '[]'**Output data type — Specify the output data type**

Inherit: Inherit via internal rule (default) | Inherit: Keep MSB | Inherit: Match scaling | Inherit: Inherit via back propagation | Inherit: Same as input | double | single | half | int8 | uint8 | int16 | uint16 | int32 | int64 | uint64 | uint32 | fixdt(1,16) | fixdt(1,16,0) | fixdt(1,16,2^0,0) | <data type expression>

Choose the data type for the output. The type can be inherited, specified directly, or expressed as a data type object such as `Simulink.NumericType`.

When you select an inherited option, the block exhibits these behaviors:

- **Inherit: Inherit via internal rule** — Simulink chooses a data type to balance numerical accuracy, performance, and generated code size, while taking into account the properties of the embedded target hardware. If you change the embedded target settings, the data type selected by the internal rule might change. For example, if the block multiplies an input of type `int8` by a gain of `int16` and ASIC/FPGA is specified as the targeted hardware type, the output data type is `sfix24`. If `Unspecified (assume 32-bit Generic)`, in other words, a generic 32-bit microprocessor, is specified as the target hardware, the output data type is `int32`. If none of the word lengths provided by the target microprocessor can accommodate the output range, Simulink software displays an error in the Diagnostic Viewer.
- **Inherit: Keep MSB**— Simulink chooses a data type that maintains the full range of the operation, then reduces the precision of the output to a size appropriate for the embedded target hardware.

Tip For more efficient generated code, deselect the **Saturate on integer overflow** parameter.

This rule never produces overflows.

- **Inherit: Match scaling**— Simulink chooses a data type whose scaling matches the scaling of the input types. If the full range of the type does not fit on the embedded target hardware, the range is reduced yielding a type appropriate for the embedded target hardware. This rule can produce overflows.

It is not always possible for the software to optimize code efficiency and numerical accuracy at the same time. If these internal rules do not meet your specific needs for numerical accuracy or performance, use one of the following options:

- Specify the output data type explicitly.
- Use the simple choice of **Inherit: Same as input**.
- Explicitly specify a default data type such as `fixdt(1,32,16)` and then use the Fixed-Point Tool to propose data types for your model. For more information, see `fxptdlg`.
- To specify your own inheritance rule, use **Inherit: Inherit via back propagation** and then use a Data Type Propagation block. Examples of how to use this block are available in the Signal Attributes library Data Type Propagation Examples block.
- **Inherit: Inherit via back propagation** — Use data type of the driving block.

- **Inherit:** Same as input — Use data type of input signal.

Dependencies

When input is a floating-point data type smaller than single precision, the **Inherit: Inherit via internal** rule output data type depends on the setting of the “Inherit floating-point output type smaller than single precision” configuration parameter. Data types are smaller than single precision when the number of bits needed to encode the data type is less than the 32 bits needed to encode the single-precision data type. For example, `half` and `int16` are smaller than single precision.

Programmatic Use

Block Parameter: `OutDataTypeStr`

Type: character vector

Values: `'Inherit: Inherit via internal rule'` | `'Inherit: Keep MSB'` | `'Inherit: Match scaling'` | `'Inherit: Same as input'` | `'Inherit: Inherit via back propagation'` | `'single'` | `'half'` | `'int8'` | `'uint8'` | `'int16'` | `'uint16'` | `'int32'` | `'uint32'` | `'int64'` | `'uint64'` | `'fixdt(1,16)'` | `'fixdt(1,16,0)'` | `'fixdt(1,16,2^0,0)'` | `'<data type expression>'`

Default: `'Inherit: Inherit via internal rule'`

Lock output data type setting against changes by the fixed-point tools — Prevent fixed-point tools from overriding Output data type

`off` (default) | `on`

Select this parameter to prevent the fixed-point tools from overriding the **Output** data type you specify on the block. For more information, see “Use Lock Output Data Type Setting” (Fixed-Point Designer).

Programmatic Use

Block Parameter: `LockScale`

Type: character vector

Values: `'off'` | `'on'`

Default: `'off'`

Integer rounding mode — Rounding mode for fixed-point operations

`Floor` (default) | `Ceiling` | `Convergent` | `Nearest` | `Round` | `Simplest` | `Zero`

Specify the rounding mode for fixed-point operations. For more information, see “Rounding” (Fixed-Point Designer).

Block parameters always round to the nearest representable value. To control the rounding of a block parameter, enter an expression using a MATLAB rounding function into the mask field.

Programmatic Use

Block Parameter: `RndMeth`

Type: character vector

Values: `'Ceiling'` | `'Convergent'` | `'Floor'` | `'Nearest'` | `'Round'` | `'Simplest'` | `'Zero'`

Default: `'Floor'`

Saturate on integer overflow — Method of overflow action

`off` (default) | `on`

Specify whether overflows saturate or wrap.

| Action | Rationale | Impact on Overflows | Example |
|-------------------------------------|---|---|---|
| Select this check box (on). | Your model has possible overflow, and you want explicit saturation protection in the generated code. | Overflows saturate to either the minimum or maximum value that the data type can represent. | The maximum value that the <code>int8</code> (signed, 8-bit integer) data type can represent is 127. Any block operation result greater than this maximum value causes overflow of the 8-bit integer. With the check box selected, the block output saturates at 127. Similarly, the block output saturates at a minimum output value of -128. |
| Do not select this check box (off). | You want to optimize efficiency of your generated code. You want to avoid overspecifying how a block handles out-of-range signals. For more information, see “Troubleshoot Signal Range Errors”. | Overflows wrap to the appropriate value that is representable by the data type. | The maximum value that the <code>int8</code> (signed, 8-bit integer) data type can represent is 127. Any block operation result greater than this maximum value causes overflow of the 8-bit integer. With the check box cleared, the software interprets the overflow-causing value as <code>int8</code> , which can produce an unintended result. For example, a block result of 130 (binary 1000 0010) expressed as <code>int8</code> , is -126. |

When you select this check box, saturation applies to every internal operation on the block, not just the output, or result. Usually, the code generation process can detect when overflow is not possible. In this case, the code generator does not produce saturation code.

Programmatic Use

Block Parameter: `SaturateOnIntegerOverflow`

Type: character vector

Values: 'off' | 'on'

Default: 'off'

Parameter Attributes

Parameter `minimum` — Specify the minimum value of gain

[] (default) | scalar

Specify the minimum value of gain. The default value is [] (unspecified). Simulink uses this value to perform:

- Parameter range checking (see “Specify Minimum and Maximum Values for Block Parameters”)
- Automatic scaling of fixed-point data types

Programmatic Use**Block Parameter:** ParamMin**Type:** character vector**Value:** scalar**Default:** '[]'**Parameter maximum — Specify the maximum value of gain**

[] (default) | scalar

Specify the maximum value of gain. The default value is [] (unspecified). Simulink uses this value to perform:

- Parameter range checking (see “Specify Minimum and Maximum Values for Block Parameters”)
- Automatic scaling of fixed-point data types

Programmatic Use**Block Parameter:** ParamMax**Type:** character vector**Value:** scalar**Default:** '[]'**Parameter data type — Specify the data type of the Gain parameter**

Inherit: Inherit via internal rule (default) | Inherit: Same as input | Inherit: Inherit from 'Gain' | double | single | half | int8 | uint8 | int16 | uint16 | int32 | uint32 | int64 | uint64 | fixdt(1,16) | fixdt(1,16,0) | fixdt(1,16,2^0,0) | <data type expression>

Specify the data type of the **Gain** parameter.

Programmatic Use**Block Parameter:** ParamDataTypeStr**Type:** character vector

Values: 'Inherit: Inherit via internal rule' | 'Inherit: Same as input' | 'Inherit: Inherit via back propagation' | 'single' | 'half' | 'int8' | 'uint8' | 'int16' | 'uint16', 'int32' | 'uint32' | 'int64' | 'uint64' | 'fixdt(1,16)' | 'fixdt(1,16,0)' | 'fixdt(1,16,2^0,0)' | '<data type expression>'

Default: 'Inherit: Inherit via internal rule'**Block Characteristics**

| | |
|---------------------------------|--|
| Data Types | Boolean double fixed point half integer single |
| Direct Feedthrough | yes |
| Multidimensional Signals | yes |
| Variable-Size Signals | yes |
| Zero-Crossing Detection | no |

Extended Capabilities**C/C++ Code Generation**

Generate C and C++ code using Simulink® Coder™.

HDL Code Generation

Generate Verilog and VHDL code for FPGA and ASIC designs using HDL Coder™.

HDL Coder provides additional configuration options that affect HDL implementation and synthesized logic.

Tunable Parameters

You can use a tunable parameter in a Gain block intended for HDL code generation. For details, see “Generate DUT Ports for Tunable Parameters” (HDL Coder).

HDL Architecture

| ConstMultiplierOptimization | Description |
|-----------------------------|--|
| <code>none</code> (Default) | By default, HDL Coder does not perform CSD or FCSD optimizations. Code generated for the Gain block retains multiplier operations. |
| <code>csd</code> | When you specify this option, the generated code decreases the area used by the model while maintaining or increasing clock speed, using canonical signed digit (CSD) techniques. CSD replaces multiplier operations with add and subtract operations. CSD minimizes the number of addition operations required for constant multiplication by representing binary numbers with a minimum count of nonzero digits. |
| <code>fcsd</code> | This option uses factored CSD (FCSD) techniques, which replace multiplier operations with shift and add/subtract operations on certain factors of the operands. These factors are generally prime but can also be a number close to a power of 2, which favors area reduction. You can achieve a greater area reduction with FCSD at the cost of decreasing clock speed. |
| <code>auto</code> | When you specify this option, the coder chooses between the CSD or FCSD optimizations. The coder chooses the optimization that yields the most area-efficient implementation, based on the number of adders required. When you specify <code>auto</code> , the coder does not use multipliers, unless conditions are such that CSD or FCSD optimizations are not possible (for example, if the design uses floating-point arithmetic). |

HDL Block Properties

| General | |
|------------------------------------|--|
| ConstMultiplierOptimization | Canonical signed digit (CSD) or factored CSD optimization. The default is <code>none</code> . See also “ConstMultiplierOptimization” (HDL Coder). |
| ConstrainedOutputPipeline | Number of registers to place at the outputs by moving existing delays within your design. Distributed pipelining does not redistribute these registers. The default is 0. For more details, see “ConstrainedOutputPipeline” (HDL Coder). |
| DSPStyle | Synthesis attributes for multiplier mapping. The default is <code>none</code> . See also “DSPStyle” (HDL Coder). |

| General | |
|-----------------------|--|
| InputPipeline | Number of input pipeline stages to insert in the generated code. Distributed pipelining and constrained output pipelining can move these registers. The default is 0. For more details, see “InputPipeline” (HDL Coder). |
| OutputPipeline | Number of output pipeline stages to insert in the generated code. Distributed pipelining and constrained output pipelining can move these registers. The default is 0. For more details, see “OutputPipeline” (HDL Coder). |

Note For certain values of the **Gain** parameter, native floating point implements the algorithm differently instead of using multipliers. For example, if you set the **Gain** parameter to 1, the generated model uses a wire to pass the input to the output. If you set the **Gain** parameter to -1, the generated model shows a Unary Minus block that inverts the polarity of the input signal. This implementation reduces the latency and resource usage on the target platform.

| Native Floating Point | |
|---------------------------------|--|
| HandleDenormals | Specify whether you want HDL Coder to insert additional logic to handle denormal numbers in your design. Denormal numbers are numbers that have magnitudes less than the smallest floating-point number that can be represented without leading zeros in the mantissa. The default is <code>inherit</code> . See also “HandleDenormals” (HDL Coder). |
| LatencyStrategy | Specify whether to map the blocks in your design to <code>inherit</code> , <code>Max</code> , <code>Min</code> , <code>Zero</code> , or <code>Custom</code> for the floating-point operator. The default is <code>inherit</code> . See also “LatencyStrategy” (HDL Coder). |
| NFPCustomLatency | To specify a value, set LatencyStrategy to <code>Custom</code> . HDL Coder adds latency equal to the value that you specify for the NFPCustomLatency setting. See also “NFPCustomLatency” (HDL Coder). |
| MantissaMultiplyStrategy | Specify how to implement the mantissa multiplication operation during code generation. By using different settings, you can control the DSP usage on the target FPGA device. The default is <code>inherit</code> . See also “MantissaMultiplyStrategy” (HDL Coder). |

Complex Data Support

This block supports code generation for complex signals.

PLC Code Generation

Generate Structured Text code using Simulink® PLC Coder™.

Fixed-Point Conversion

Design and simulate fixed-point systems using Fixed-Point Designer™.

See Also

Slider Gain | Product

Topics

“Model a Continuous System”

Introduced before R2006a

Gauge

Display signal value on circular scale

Library: Simulink / Dashboard



Description

The Gauge block displays the connected signal on a circular scale during simulation. You can use the Gauge block with other Dashboard blocks to build an interactive dashboard of controls and indicators for your model. The Gauge block provides an indication of the instantaneous value of the connected signal throughout simulation. You can modify the range of the Gauge block to fit your data. You can also change the appearance of the dial to provide more information about your signal. For example, you can color-code in-specification and out-of-specification ranges.

Connect Dashboard Blocks

Dashboard blocks do not use ports to connect to model elements. To connect dashboard blocks to signals in your model, use connect mode. Connect mode facilitates the process of connecting dashboard blocks in your model, especially when you want to connect multiple blocks at once. To connect a single dashboard block, you can also use the **Connection** table in the block dialog box.

Tip You can modify dashboard block connections during normal and accelerator mode simulations.

To enter connect mode, select a dashboard block to connect. Then, on the block tab, click **Connect**. In connect mode, when you select one or more signals or blocks, a list of signals that are available for connection appears. Select a signal from the list to connect to the selected dashboard block. To connect another dashboard block, pause on the block you want to connect and click the **Connect** button above it. Then, select one or more signals and blocks in the model and choose a signal to connect.

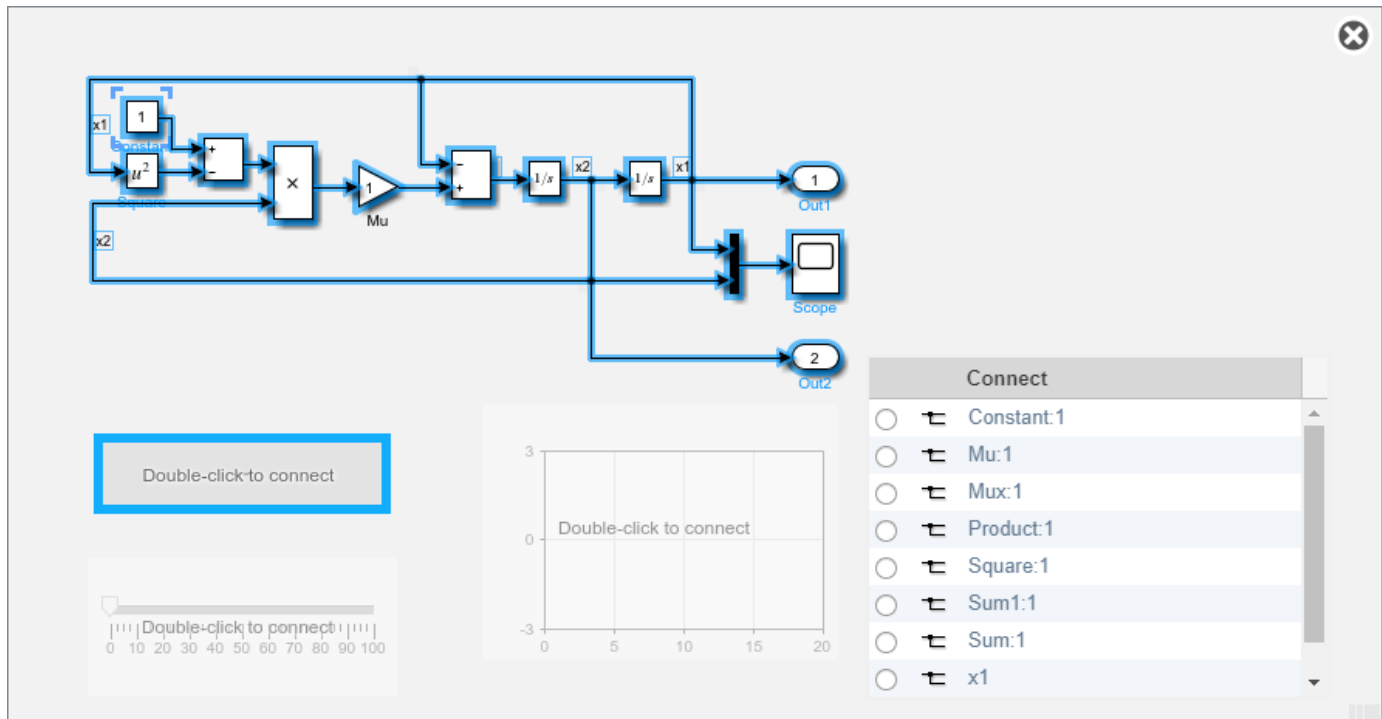

When you finish connecting the dashboard blocks in your model, on the block tab, click **Done Connecting**.

Tip You can hide the message shown on unconnected blocks using the `set_param` function with the `ShowInitialText` block parameter. The message also disappears when you connect the block.

Limitations

- Except for the Dashboard Scope block and the Display block, dashboard blocks can only connect to real scalar signals.
- The toolstrip does not support blocks that are inside a panel.
- You cannot use the **Connection** table in the block dialog to connect a dashboard block to a block that is commented out. When you connect a dashboard block to a commented block using connect mode, the dashboard block does not display the connected value until the you uncomment the block.
- Dashboard blocks cannot connect to model elements inside referenced models.
- When you simulate a model hierarchy, dashboard blocks inside referenced models do not update.
- Dashboard blocks do not support rapid accelerator simulation.
- You cannot connect a dashboard block to data or activity in Stateflow during simulation.
- Some signals do not have data available during simulation due to block reduction or optimization for accelerator mode simulations. To view such a signal using a dashboard block, mark the signal for logging.

Parameters

Signal

Connection — Signal to connect and display

signal connection options

Use the connection table to select the signal to connect to the block. To connect the block to a signal:

- 1 Make a selection in the model that includes one or more signals.
- 2 In the table, select the signal you want to connect.
- 3 Click **Apply**.

Tip You can connect dashboard blocks to signals in the model during simulation.

Programmatic Use

Block Parameter: Binding

Type: Simulink.HMI.SignalSpecification

Default: []

Main

Minimum — Minimum tick mark value

0 (default) | scalar

Finite, real, double, scalar value specifying the minimum tick mark value for the scale. The minimum must be less than the value of the **Maximum** parameter.

Programmatic Use

To programmatically set the Minimum parameter, use a 1-by-3 vector containing values for the Minimum, Tick Interval, and Maximum parameters, in that order. To use the auto value for the Tick Interval, leave the Tick Interval position in the vector empty or specify -1.

Block Parameter: Limits

Type: 1x3 vector

Default: [0 -1 100]

Maximum — Maximum tick mark value

100 (default) | scalar

Finite, real, double, scalar value specifying the maximum tick mark value for the scale. The maximum must be greater than the value of the **Minimum** parameter.

Programmatic Use

To programmatically set the Maximum parameter, use a 1-by-3 vector containing values for the Minimum, Tick Interval, and Maximum parameters, in that order. To use the auto value for the Tick Interval, leave the Tick Interval position in the vector empty or specify -1.

Block Parameter: Limits

Type: 1x3 vector

Default: [0 -1 100]

Tick Interval — Interval between major tick marks

auto (default) | scalar

Finite, real, positive, whole, scalar value specifying the interval of major tick marks on the scale. When set to `auto`, the block automatically adjusts the tick interval based on the values of the **Maximum** and **Minimum** parameters.

Programmatic Use

To programmatically set the `Tick Interval` parameter, use a 1-by-3 vector containing values for the `Minimum`, `Tick Interval`, and `Maximum` parameters, in that order. To use the `auto` value for the `Tick Interval`, leave the `Tick Interval` position in the vector empty or specify `-1`.

Block Parameter: Limits

Type: 1x3 vector

Default: [0 -1 100]

Scale Colors — Color indications on gauge scale

colors for scale ranges

Color specifications for value ranges on the scale. Press the **+** button to add a scale color. For each color added, specify the minimum and maximum values of the range in which you want to display that color.

Programmatic Use

To programmatically specify the `Scale Colors` parameter, use an array of structures with the fields:

- `Min` — Minimum value for the color range on the scale
- `Max` — Maximum value for the color range on the scale
- `Color` — 1-by-3 vector of double values between 0 and 1 that specify the color for the range in the form [r g b]

Include a structure in the array for each scale range for which you want to specify a color.

```
range1.Min = 0;  
range1.Max = 10;  
range1.Color = [0 0 1];  
range2.Min = 10;  
range2.Max = 15;  
range2.Color = [0 1 0];  
scaleRanges = [range1 range2];
```

Block Parameter: ScaleColors

Type: structure array

Default: 0x1 struct array

Label — Block label position

Top (default) | Bottom | Hide

Position of the block label. When the block is connected to an element in the model, the label is the name of the connected element.

Programmatic Use

Block Parameter: LabelPosition

Type: character vector

Values: 'Top' | 'Bottom' | 'Hide'

Default: 'Top'

Scale Direction — Gauge scale direction

Clockwise (default) | Counterclockwise

Gauge scale direction.

Programmatic Use**Block Parameter:** ScaleDirection**Type:** character vector**Values:** 'Clockwise' | 'Counterclockwise'**Default:** 'Clockwise'**Format****Opacity — Block background opacity**

1 (default) | scalar

Block background opacity, specified as a scalar value between 0 and 1.

Example: 0.5

Programmatic Use**Block Parameter:** Opacity**Type:** scalar**Default:** 1**Foreground Color — Block foreground color**

[r g b] vector

Block foreground color, excluding the text. The **Foreground Color** applies to the scale and the block name. You can select a color from a palette of standard colors or specify a custom color. To specify the color for the block text, use the **Font Color**.

Programmatic Use

Specify the `ForegroundColor` parameter for the block as a 1-by-3 [r g b] vector with values between 0 and 1.

Block Parameter: ForegroundColor**Type:** [r g b] vector**Background Color — Block background color**

[r g b] vector

Block background color. You can select a color from a palette of standard colors or specify a custom color.

Programmatic Use

Specify the `BackgroundColor` parameter for the block as a 1-by-3 [r g b] vector with values between 0 and 1.

Block Parameter: BackgroundColor**Type:** [r g b] vector**Font Color — Block font color**

[r g b] vector

Block font color. The **Font Color** applies to the tick labels on the scale. You can select a color from a palette of standard colors or specify a custom color.

Programmatic Use

Specify the `FontColor` parameter for the block as a 1-by-3 [r g b] vector with values between 0 and 1.

Block Parameter: `FontColor`

Type: [r g b] vector

Block Characteristics

| | |
|---------------------------------|---|
| Data Types | Boolean double enumerated fixed point half integer single |
| Direct Feedthrough | no |
| Multidimensional Signals | no |
| Variable-Size Signals | no |
| Zero-Crossing Detection | no |

Extended Capabilities**C/C++ Code Generation**

Generate C and C++ code using Simulink® Coder™.

Dashboard blocks are ignored for code generation.

See Also

Half Gauge | Quarter Gauge | Linear Gauge | Circular Gauge

Topics

“Tune and Visualize Your Model with Dashboard Blocks”

“Decide How to Visualize Simulation Data”

Introduced in R2015a

Goto

Pass block input to From blocks

Library: Simulink / Signal Routing
HDL Coder / Signal Routing



Description

The Goto block passes its input to its corresponding From blocks. The input can be a real- or complex-valued signal or vector of any data type. From and Goto blocks allow you to pass a signal from one block to another without actually connecting them.

A Goto block can pass its input signal to more than one From block, although a From block can receive a signal from only one Goto block. The input to that Goto block is passed to the From blocks associated with it as though the blocks were physically connected.

For example, this model uses a Goto block and a From block.



An equivalent model passes the Sine Wave block signal directly to the Gain block.

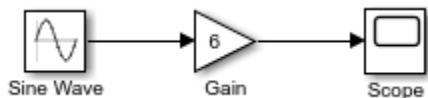

Goto blocks and From blocks are matched by the use of Goto tags.

The **Tag visibility** parameter determines where From blocks can access the signal.

The Goto block supports signal label propagation. For more information, see “Signal Label Propagation”.

Ports

Input

Port_1 – Input signal

scalar | vector | matrix | N-D array

Input signal to be passed to the corresponding From block, specified as a scalar, vector, matrix, or N-D array.

Data Types: `single` | `double` | `half` | `int8` | `int16` | `int32` | `int64` | `uint8` | `uint16` | `uint32` | `uint64` | `Boolean` | `fixed point` | `enumerated` | `bus`

Parameters

Goto tag — Block identifier

`A` (default) | ...

The Goto block identifier. This parameter identifies the Goto block whose scope is defined in this block.

Programmatic Use

Block Parameter: `GotoTag`

Type: character vector

Values: `'A'` | ...

Default: `'A'`

Tag visibility — Scope of the Goto block tag

`local` (default) | `scoped` | `global`

The scope of the Goto block tag, specified as `local`, `scoped`, or `global`. When you set this parameter to `scoped`, you must use a Goto Tag Visibility block to define the scope of tag visibility.

- `local` (default) — From and Goto blocks that use the same tag must be in the same subsystem. A local tag name is enclosed in brackets (`[]`).
- `scoped` — From and Goto blocks that use the same tag must be either:
 - In the same subsystem.
 - At any level in the model hierarchy below the Goto Tag Visibility block that does not entail crossing a nonvirtual subsystem boundary. In other words, they must be within the boundary of an atomic, conditionally executed, or function-call subsystem or a model reference.

A scoped tag name is enclosed in braces (`{}`).

- `global` — From and Goto blocks using the same tag can be anywhere in the model except in locations that span nonvirtual subsystem boundaries.

The rule that From-Goto block connections cannot cross nonvirtual subsystem boundaries has the following exception. A Goto block connected to a state port in one conditionally executed subsystem is visible to a From block inside another conditionally executed subsystem.

Note A `scoped` Goto block in a masked system is visible only in that subsystem and in the nonvirtual subsystems it contains. Simulink generates an error if you run or update a diagram that has a Goto Tag Visibility block at a higher level in the block diagram than the corresponding `scoped` Goto block in the masked subsystem.

Use local tags when the Goto and From blocks using the same tag name reside in the same subsystem. You must use `global` or `scoped` tags when the Goto and From blocks using the same tag name reside in different subsystems. When you define a tag as `global`, all uses of that tag access the same signal. A tag defined as `scoped` can be used in more than one place in the model.

Programmatic Use**Block Parameter:** TagVisibility**Type:** character vector**Values:** 'local' | 'scoped' | 'global'**Default:** 'local'**Icon display — Text to display on block icon**

Tag (default) | Signal name | Tag and signal name

Specifies the text to display on the block icon. The options are the block tag, the name of the signal that the block represents, or both the tag and the signal name.

Programmatic Use**Block Parameter:** IconDisplay**Type:** character vector**Values:** 'Signal name' | 'Tag' | 'Tag and signal name'**Default:** 'Tag'**Rename All — Propagate name throughout model**

button

Rename the Goto tag. The new name propagates to all From and Goto Tag Visibility blocks that are listed in the **Corresponding blocks** box.

Alternatively, when you change the tag on the Goto block icon, propagate the new name to all corresponding From and Goto Tag Visibility blocks by pressing **Shift+Enter**.

Corresponding blocks — Blocks connected to this Goto block

block path | ...

List of the From blocks and Goto Tag Visibility blocks connected to this Goto block. Click an entry in the list to display and highlight the corresponding From and Goto Tag Visibility blocks.

Alternatively, in the Simulink Editor, select the Goto block to highlight the corresponding From and Goto Tag Visibility blocks.

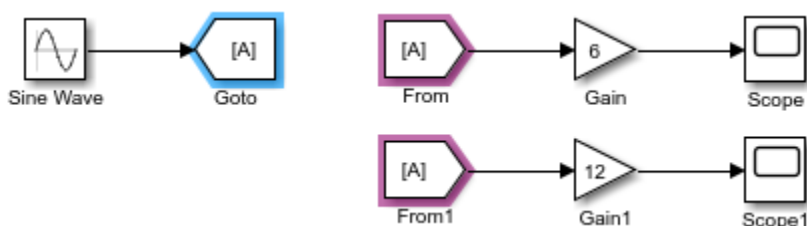

When a corresponding From or Goto Tag Visibility block is not in the current diagram, the Subsystem block that contains the block is highlighted.

To show a corresponding block in an open diagram or new tab, select the Goto block and pause on the ellipsis. Then, select **Related Blocks**  from the action bar. When multiple blocks correspond to the selected block, a list of related blocks opens. You can filter the list of related blocks by entering a search term in the text box. After you select a related block from the list, window focus goes to the open diagram or new tab that shows the related block.

Block Characteristics

| | |
|---------------------------------|--|
| Data Types | Boolean bus double enumerated fixed point half integer single string |
| Direct Feedthrough | no |
| Multidimensional Signals | yes |
| Variable-Size Signals | yes |
| Zero-Crossing Detection | no |

Extended Capabilities

C/C++ Code Generation

Generate C and C++ code using Simulink® Coder™.

HDL Code Generation

Generate Verilog and VHDL code for FPGA and ASIC designs using HDL Coder™.

HDL Coder provides additional configuration options that affect HDL implementation and synthesized logic. HDL code generation does not support **Tag Visibility** of the blocks set to `global`. See also “Required HDL Settings for Goto and From Blocks” (HDL Coder).

HDL Architecture

This block has a single, default HDL architecture.

HDL Block Properties

| | |
|----------------------|--|
| InputPipeline | Number of input pipeline stages to insert in the generated code. Distributed pipelining and constrained output pipelining can move these registers. The default is 0. For more details, see “InputPipeline” (HDL Coder). |
|----------------------|--|

PLC Code Generation

Generate Structured Text code using Simulink® PLC Coder™.

Fixed-Point Conversion

Design and simulate fixed-point systems using Fixed-Point Designer™.

See Also

From | Goto Tag Visibility

Topics

“Signal Label Propagation”

Introduced before R2006a

Goto Tag Visibility

Define scope of Goto block tag

Library: Simulink / Signal Routing



Description

The Goto Tag Visibility block defines the accessibility of Goto block tags that have **scoped** visibility. The value you specify for the **Goto tag** block parameter is accessible by From blocks in the same subsystem that contains the Goto Tag Visibility block and in subsystems below it in the model hierarchy.

A Goto Tag Visibility block is required for Goto blocks whose **Tag Visibility** parameter value is **scoped**. No Goto Tag Visibility block is needed if the tag visibility is either **local** or **global**. The block shows the tag name enclosed in braces ({}).

Note A **scoped** Goto block in a masked system is visible only in that subsystem and in the nonvirtual subsystems it contains. Simulink generates an error if you run or update a diagram that has a Goto Tag Visibility block at a lower level in the block diagram than the corresponding **scoped** Goto block in the masked subsystem.

In the Simulink Editor, select the Goto Tag Visibility block to highlight the corresponding Goto and From blocks. When a corresponding From or Goto block is not in the current diagram, the Subsystem block that contains the block is highlighted.

To show a corresponding block in an open diagram or new tab, select the Goto Tag Visibility block and pause on the ellipsis. Then, select **Related Blocks**  from the action bar. When multiple blocks correspond to the selected block, a list of related blocks opens. You can filter the list of related blocks by entering a search term in the text box. After you select a related block from the list, window focus goes to the open diagram or new tab that shows the related block.

Parameters

Goto tag — Goto block tag whose visibility is defined by the location of this block

A (default) | ...

The Goto block tag whose visibility is defined by the location of this block. From and Goto blocks using the specified tag must be in the same subsystem or at any level in the model hierarchy below the Goto Tag Visibility block that does not entail crossing a nonvirtual subsystem boundary, in other words, the boundary of an atomic, conditionally executed, or function-call subsystem or a model reference. A **scoped** tag name is enclosed in braces ({}).

Tip If you use multiple From and Goto Tag Visibility blocks to refer to the same Goto tag, you can simultaneously rename the tag in all of the blocks. Use the **Rename All** button in the Goto block dialog box. Alternatively, when you change the tag on the Goto block icon, propagate the new name to all corresponding From and Goto Tag Visibility blocks by pressing **Shift+Enter**.

Block Characteristics

| | |
|---------------------------------|--|
| Data Types | Boolean bus double enumerated fixed point integer single |
| Direct Feedthrough | no |
| Multidimensional Signals | no |
| Variable-Size Signals | no |
| Zero-Crossing Detection | no |

Extended Capabilities

C/C++ Code Generation

Generate C and C++ code using Simulink® Coder™.

PLC Code Generation

Generate Structured Text code using Simulink® PLC Coder™.

Fixed-Point Conversion

Design and simulate fixed-point systems using Fixed-Point Designer™.

See Also

Goto | From

Topics

“Signal Label Propagation”

Introduced before R2006a

Ground

Ground unconnected input port

Library: Simulink / Commonly Used Blocks
 Simulink / Sources
 HDL Coder / Sources



Description

The Ground block connects to blocks whose input ports do not connect to other blocks. If you run a simulation with blocks that have unconnected input ports, Simulink issues warnings. Using a Ground block to ground those unconnected blocks can prevent these warnings.

Working with Fixed-Point Data Types

When working with fixed-point data types, there may be instances where the fixed-point data type cannot represent zero exactly. In these cases, the Ground block outputs a nonzero value that is the closest possible value to zero. This behavior applies only to fixed-point data types with nonzero bias. These expressions are examples of fixed-point data types that cannot represent zero:

- `fixdt(0, 8, 1, 1)` — an unsigned 8-bit type with slope of 1 and bias of 1
- `fixdt(1, 8, 6, 3)` — a signed 8-bit type with slope of 6 and bias of 3

Working with Enumerated Data Types

When working with enumerated data types, the Ground block outputs the default value of the enumeration. This behavior applies whether:

- The enumeration can represent zero
- The default value of the enumeration is zero

If the enumerated type does not have a default value, the Ground block outputs the first enumeration value in the type definition.

Ports

Output

Port_1 — Ground signal

scalar

The Ground block outputs a scalar signal with zero value, and the same data type as the port to which it connects.

Data Types: `single` | `double` | `half` | `int8` | `int16` | `int32` | `int64` | `uint8` | `uint16` | `uint32` | `uint64` | `string` | `Boolean` | `fixed point` | `enumerated` | `bus`

Block Characteristics

| | |
|---------------------------------|--|
| Data Types | Boolean bus double enumerated fixed point half integer single string |
| Direct Feedthrough | no |
| Multidimensional Signals | yes |
| Variable-Size Signals | no |
| Zero-Crossing Detection | no |

Extended Capabilities

C/C++ Code Generation

Generate C and C++ code using Simulink® Coder™.

HDL Code Generation

Generate Verilog and VHDL code for FPGA and ASIC designs using HDL Coder™.

HDL Coder provides additional configuration options that affect HDL implementation and synthesized logic.

HDL Architecture

This block has a single, default HDL architecture.

HDL Block Properties

| | |
|----------------------------------|--|
| ConstrainedOutputPipeline | Number of registers to place at the outputs by moving existing delays within your design. Distributed pipelining does not redistribute these registers. The default is 0. For more details, see “ConstrainedOutputPipeline” (HDL Coder). |
| OutputPipeline | Number of output pipeline stages to insert in the generated code. Distributed pipelining and constrained output pipelining can move these registers. The default is 0. For more details, see “OutputPipeline” (HDL Coder). |

Complex Data Support

This block supports code generation for complex signals.

PLC Code Generation

Generate Structured Text code using Simulink® PLC Coder™.

Fixed-Point Conversion

Design and simulate fixed-point systems using Fixed-Point Designer™.

See Also

Topics

“Unconnected block input ports”

Introduced before R2006a

Half Gauge

Display input value on semicircular scale

Library: Simulink / Dashboard



Description

The Half Gauge block displays the connected signal on a semicircular scale during simulation. You can use the Half Gauge block with other Dashboard blocks to build an interactive dashboard of controls and indicators for your model. The Half Gauge block provides an indication of the instantaneous value of the connected signal throughout simulation. You can modify the range of the Half Gauge block to fit your data. You can also customize the appearance of the Half Gauge block to provide more information about your signal. For example, you can color-code in-specification and out-of-specification ranges.

Connect Dashboard Blocks

Dashboard blocks do not use ports to connect to model elements. To connect dashboard blocks to signals in your model, use connect mode. Connect mode facilitates the process of connecting dashboard blocks in your model, especially when you want to connect multiple blocks at once. To connect a single dashboard block, you can also use the **Connection** table in the block dialog box.

Tip You can modify dashboard block connections during normal and accelerator mode simulations.

To enter connect mode, select a dashboard block to connect. Then, on the block tab, click **Connect**. In connect mode, when you select one or more signals or blocks, a list of signals that are available for connection appears. Select a signal from the list to connect to the selected dashboard block. To connect another dashboard block, pause on the block you want to connect and click the **Connect** button above it. Then, select one or more signals and blocks in the model and choose a signal to connect.

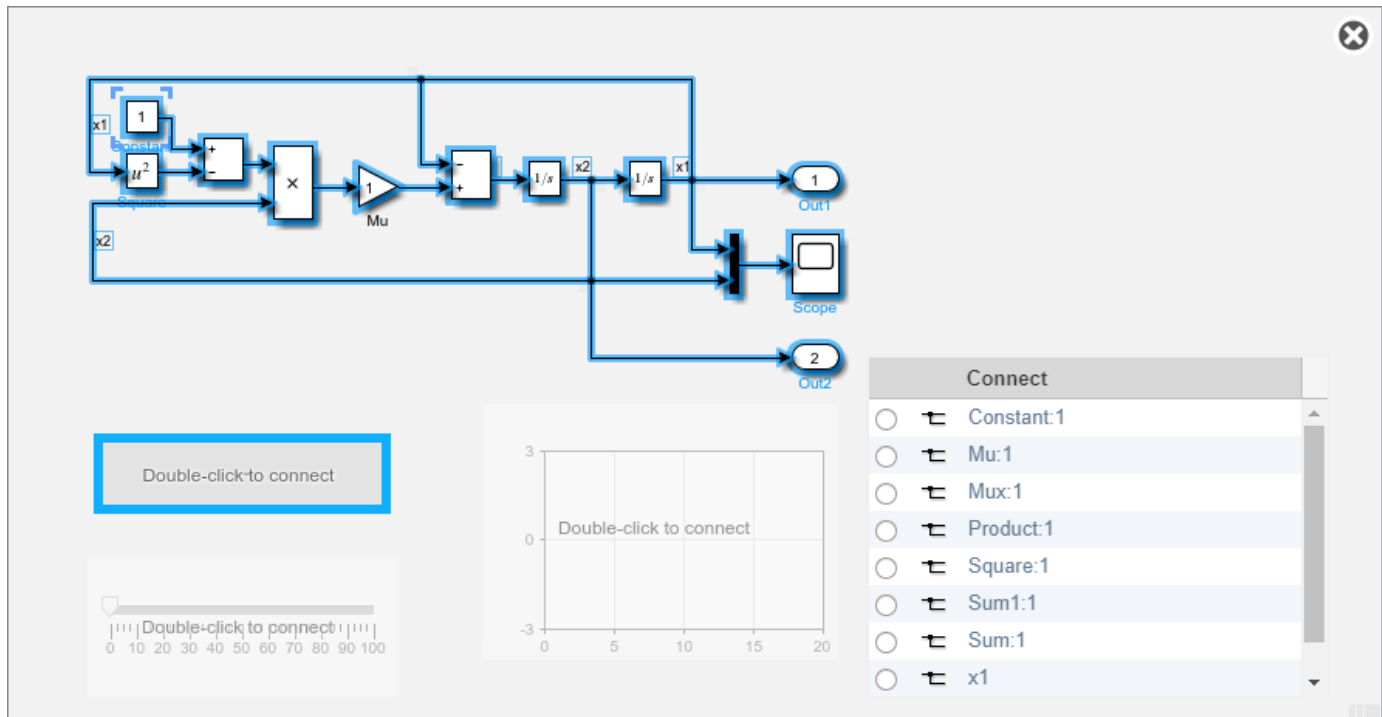

When you finish connecting the dashboard blocks in your model, on the block tab, click **Done Connecting**.

Tip You can hide the message shown on unconnected blocks using the `set_param` function with the `ShowInitialText` block parameter. The message also disappears when you connect the block.

Limitations

- Except for the Dashboard Scope block and the Display block, dashboard blocks can only connect to real scalar signals.
- The toolstrip does not support blocks that are inside a panel.
- You cannot use the **Connection** table in the block dialog to connect a dashboard block to a block that is commented out. When you connect a dashboard block to a commented block using connect mode, the dashboard block does not display the connected value until the you uncomment the block.
- Dashboard blocks cannot connect to model elements inside referenced models.
- When you simulate a model hierarchy, dashboard blocks inside referenced models do not update.
- Dashboard blocks do not support rapid accelerator simulation.
- You cannot connect a dashboard block to data or activity in Stateflow during simulation.
- Some signals do not have data available during simulation due to block reduction or optimization for accelerator mode simulations. To view such a signal using a dashboard block, mark the signal for logging.

Parameters

Signal

Connection — Signal to connect and display

signal connection options

Use the connection table to select the signal to connect to the block. To connect the block to a signal:

- 1 Make a selection in the model that includes one or more signals.
- 2 In the table, select the signal you want to connect.
- 3 Click **Apply**.

Tip You can connect dashboard blocks to signals in the model during simulation.

Programmatic Use

Block Parameter: Binding

Type: Simulink.HMI.SignalSpecification

Default: []

Main

Minimum — Minimum tick mark value

0 (default) | scalar

Finite, real, double, scalar value specifying the minimum tick mark value for the scale. The minimum must be less than the value of the **Maximum** parameter.

Programmatic Use

To programmatically set the Minimum parameter, use a 1-by-3 vector containing values for the Minimum, Tick Interval, and Maximum parameters, in that order. To use the `auto` value for the Tick Interval, leave the Tick Interval position in the vector empty or specify -1.

Block Parameter: Limits

Type: 1x3 vector

Default: [0 -1 100]

Maximum — Maximum tick mark value

100 (default) | scalar

Finite, real, double, scalar value specifying the maximum tick mark value for the scale. The maximum must be greater than the value of the **Minimum** parameter.

Programmatic Use

To programmatically set the Maximum parameter, use a 1-by-3 vector containing values for the Minimum, Tick Interval, and Maximum parameters, in that order. To use the `auto` value for the Tick Interval, leave the Tick Interval position in the vector empty or specify -1.

Block Parameter: Limits

Type: 1x3 vector

Default: [0 -1 100]

Tick Interval — Interval between major tick marks

auto (default) | scalar

Finite, real, positive, whole, scalar value specifying the interval of major tick marks on the scale. When set to `auto`, the block automatically adjusts the tick interval based on the values of the **Maximum** and **Minimum** parameters.

Programmatic Use

To programmatically set the `Tick Interval` parameter, use a 1-by-3 vector containing values for the `Minimum`, `Tick Interval`, and `Maximum` parameters, in that order. To use the `auto` value for the `Tick Interval`, leave the `Tick Interval` position in the vector empty or specify `-1`.

Block Parameter: `Limits`

Type: 1x3 vector

Default: `[0 -1 100]`

Scale Colors — Color indications on gauge scale

colors for scale ranges

Color specifications for value ranges on the scale. Press the **+** button to add a scale color. For each color added, specify the minimum and maximum values of the range in which you want to display that color.

Programmatic Use

To programmatically specify the `Scale Colors` parameter, use an array of structures with the fields:

- `Min` — Minimum value for the color range on the scale
- `Max` — Maximum value for the color range on the scale
- `Color` — 1-by-3 vector of double values between 0 and 1 that specify the color for the range in the form `[r g b]`

Include a structure in the array for each scale range for which you want to specify a color.

```
range1.Min = 0;
range1.Max = 10;
range1.Color = [0 0 1];
range2.Min = 10;
range2.Max = 15;
range2.Color = [0 1 0];
scaleRanges = [range1 range2];
```

Block Parameter: `ScaleColors`

Type: structure array

Default: 0x1 struct array

Label — Block label position

Top (default) | Bottom | Hide

Position of the block label. When the block is connected to an element in the model, the label is the name of the connected element.

Programmatic Use

Block Parameter: `LabelPosition`

Type: character vector

Values: `'Top'` | `'Bottom'` | `'Hide'`

Default: `'Top'`

Scale Direction — Gauge scale direction`Clockwise (default) | Counterclockwise`

Gauge scale direction.

Programmatic Use**Block Parameter:** `ScaleDirection`**Type:** character vector**Values:** `'Clockwise' | 'Counterclockwise'`**Default:** `'Clockwise'`**Format****Opacity — Block background opacity**`1 (default) | scalar`

Block background opacity, specified as a scalar value between 0 and 1.

Example: `0.5`

Programmatic Use**Block Parameter:** `Opacity`**Type:** scalar**Default:** `1`**Foreground Color — Block foreground color**`[r g b] vector`

Block foreground color, excluding the text. The **Foreground Color** applies to the scale and the block name. You can select a color from a palette of standard colors or specify a custom color. To specify the color for the block text, use the **Font Color**.

Programmatic Use

Specify the `ForegroundColor` parameter for the block as a 1-by-3 `[r g b]` vector with values between 0 and 1.

Block Parameter: `ForegroundColor`**Type:** `[r g b]` vector**Background Color — Block background color**`[r g b] vector`

Block background color. You can select a color from a palette of standard colors or specify a custom color.

Programmatic Use

Specify the `BackgroundColor` parameter for the block as a 1-by-3 `[r g b]` vector with values between 0 and 1.

Block Parameter: `BackgroundColor`**Type:** `[r g b]` vector**Font Color — Block font color**`[r g b] vector`

Block font color. The **Font Color** applies to the tick labels on the scale. You can select a color from a palette of standard colors or specify a custom color.

Programmatic Use

Specify the `FontColor` parameter for the block as a 1-by-3 [r g b] vector with values between 0 and 1.

Block Parameter: `FontColor`

Type: [r g b] vector

Block Characteristics

| | |
|---------------------------------|---|
| Data Types | Boolean double enumerated fixed point half integer single |
| Direct Feedthrough | no |
| Multidimensional Signals | no |
| Variable-Size Signals | no |
| Zero-Crossing Detection | no |

Extended Capabilities**C/C++ Code Generation**

Generate C and C++ code using Simulink® Coder™.

Dashboard blocks are ignored for code generation.

See Also

Gauge | Linear Gauge | Quarter Gauge | Circular Gauge

Topics

“Tune and Visualize Your Model with Dashboard Blocks”

“Decide How to Visualize Simulation Data”

Introduced in R2015a

Hermitian Transpose

Compute hermitian transpose of matrix

Library: Simulink / Matrix Operations

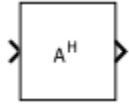

Description

The Hermitian Transpose block computes the hermitian transpose of an M -by- N matrix.

Ports

Input

Port_1 — Matrix

M -by- N matrix

Matrix, specified as an M -by- N matrix.

Data Types: `single` | `double` | `half` | `int8` | `int16` | `int32` | `int64` | `uint8` | `uint16` | `uint32` | `uint64` | `fixed point`

Output

Port_1 — Transposed matrix

N -by- M matrix

Transposed matrix, returned as an N -by- M matrix.

Data Types: `single` | `double` | `half` | `int8` | `int16` | `int32` | `int64` | `uint8` | `uint16` | `uint32` | `uint64` | `fixed point`

Block Characteristics

| | |
|---------------------------------|--|
| Data Types | Boolean double fixed point half integer single |
| Direct Feedthrough | yes |
| Multidimensional Signals | yes |
| Variable-Size Signals | yes |
| Zero-Crossing Detection | no |

Extended Capabilities

C/C++ Code Generation

Generate C and C++ code using Simulink® Coder™.

See Also

Cross Product | Identity Matrix | IsSymmetric | IsTriangular | Matrix Square | Transpose

Topics

“Compatible Array Sizes for Basic Operations”
MATLAB Matrix Operations

Introduced in R2021b

Hit Crossing

Detect crossing point

Library: Simulink / Discontinuities
 Simulink / Messages & Events
 HDL Coder / Discontinuities
 SimEvents



Description

The Hit Crossing block detects when the input reaches the **Hit crossing offset** parameter value in the direction specified by the **Hit crossing direction** property.

You can configure the block to output a 1 or 0 signal, a SimEvents® message, or a function-call event. See “Output” on page 1-712 for more information.

Ports

Input

Port_1 – Input signal

scalar | vector

Input signal that the block detects when it reaches the offset in the specified direction.

Data Types: double

Output

Port_1 – Output signal

scalar | vector | SimEvents message | function-call event

Output indicating if the input signal crossed the hit offset. This port is visible only when you select the **Show output port** parameter check box.

Signal Output

If you select the **Show output port** check box and set the **Output type** parameter to Signal, the block output indicates when the crossing occurs.

- If the input signal is exactly the value of the offset value after the hit crossing is detected in the specified direction, the block continues to output a value of 1.
- If the input signals at two adjacent points brackets the offset value, the block outputs a value of 1 at the second time step.
- If the **Show output port** check box is *not* selected, the block ensures that the simulation finds the crossing point but does not generate output.
- If the initial signal is equal to the offset value, the block outputs 1 only if the **Hit crossing direction** property is set to either.

- If Boolean logic signals are enabled, then the output is a Boolean.

SimEvents Message Output

The Hit Crossing block can also output a SimEvents message when the **Output type** parameter is set to Message.

- If the input signal crosses the offset value in the specified direction, the block outputs a message.
- If the input signal reaches the offset value in the specified direction and remains there, block outputs one message at the hit time and one message when the signal leaves the offset value.
- If the initial input signal is equal to the offset value, the block outputs a message with Crossing Type value None only if the **Hit crossing direction** is set to either.

The SimEvents message output signal is a struct with four fields.

Function-Call Output

The Hit Crossing block can also output a function-call event when the **Output type** parameter is set to Function-Call.

- Each time the input signal crosses the offset value in the specified direction, the block outputs a single function-call event.
- The function-call event can be sent to the function-call input port of a function-call subsystem or function-call model.
- The output is equivalent to the output of a Function-Call Generator block at each time step with the **Number of iterations** parameter of that block set to 1.

CrossingType — Direction of zero-crossing

None | NegativeToPositive | NegativeToZero | ZeroToPositive | PositiveToNegative | PositiveToZero | ZeroToNegative

This field shows the direction in which the signal crosses the **Hit crossing offset** value. Negative, Zero, and Positive are defined relative to the offset value. The data type is `slHitCrossingType` which is an enumerated data type. See “Use Enumerated Data in Simulink Models” for more information. For example, if `HitCrossingOffset` is set to 2, a rising signal crossing this offset value would be recorded as a `NegativeToPositive` hit crossing.

Note A hit crossing is recorded based on the **Hit crossing direction** setting. In other words, if you set **Hit crossing direction** to detect a falling hit crossing, a `NegativeToPositive` hit is not recorded.

Note In a SimEvents block, if the Crossing Type of an entity is a `NegativeToPositive` hitcrossing then `entity.CrossingType == slHitCrossingType.NegativeToPositive` returns logical 1 (true).

If the signal reaches the `HitCrossingOffset` value and holds it, a single `NegativeToZero` or `PositiveToZero`, depending on the direction, hit is registered at the time of the hit crossing.

Data Types: `slHitCrossingType`

Index — Index of the input signal at which the hit crossing event occurs

nonnegative integer

For n signals being passed to the Hit Crossing block, this field denotes which signal had a hit crossing event. For a matrix input, this field follows MATLAB linear indexing. See “Array Indexing”.

Data Types: `uint32`

Time — Time of hit crossing event

real, finite

Time T of the hit crossing event.

Data Types: `double`

Offset — Hit crossing value for detection

0 (default) | real values

Hit crossing offset value as specified by the “Hit crossing offset” on page 1-0 parameter.

Data Types: `double`

Data Types: `double` | `Boolean` | `struct`

Note If the SimEvents message output signal crosses model reference boundaries or is used as an input to a Stateflow chart, you need to create a bus object for the message. See “Tips” on page 1-716.

Parameters

Hit crossing offset — Hit crossing value for detection

0 (default) | real values

Specify the value the block detects when the input crosses in the direction specified by **Hit crossing direction**.

Programmatic Use

Block Parameter: `HitCrossingOffset`

Type: character vector

Values: real values

Default: '0'

Hit crossing direction — Input signal direction to hit crossing

either (default) | falling | rising

Direction from which the input signal approaches the hit crossing offset for a crossing to be detected.

When set to `either`, the block serves as an *almost equal* block, useful in working around limitations in finite mathematics and computer precision. Used for these reasons, this block might be more convenient than adding logic to your model to detect this condition.

When the **Hit crossing direction** property is set to `either` and the model uses a fixed-step solver, the block has the following behavior. If the output signal is 1, the block sets the output signal to 0 at the next time step, unless the input signal equals the offset value.

Programmatic Use

Block Parameter: `HitCrossingDirection`

Type: character vector
Values: 'either' | 'rising' | 'falling'
Default: 'either'

Show output port — Display an output port

off (default) | on

If selected, create an output port on the block icon.

Programmatic Use

Block Parameter: ShowOutputPort

Type: character vector

Values: 'off' | 'on'

Default: 'on'

Output type — Choose signal, message, or function-call output

Signal (default for Simulink) | Message (default for SimEvents) | Function-Call

When **Output type** is set to Signal, the output signal is set to one whenever the input signal crosses the **Hit crossing offset** value in the **Hit crossing direction** and is zero at other times.

When the **Output type** is set to Message, the output signal becomes a SimEvents message.

When **Output type** is set to Function-Call, the output signal becomes a function-call event.

Programmatic Use

Block Parameter: HitCrossingOutputType

Type: character vector

Values: 'Signal' | 'Message' | 'Function-Call'

Default: 'Signal'

Enable zero-crossing detection — Enable zero-crossing detection

on (default) | off

Select to enable zero-crossing detection. For more information, see “Zero-Crossing Detection”.

Programmatic Use

Parameter: ZeroCross

Type: character vector, string

Values: 'on' | 'off'

Default: 'on'

Block Characteristics

| | |
|---------------------------------|--------|
| Data Types | double |
| Direct Feedthrough | yes |
| Multidimensional Signals | no |
| Variable-Size Signals | no |
| Zero-Crossing Detection | yes |

Tips

If the Hit Crossing block is configured to output a SimEvents message and the output signal:

- Crosses into or out of a referenced model
- Is fed to the input of a Stateflow chart

then you need to create a bus object for the message signal. In the MATLAB Command Window, run `Simulink.createHitCrossMessage` to check for and, if needed, create a hit crossing message bus object in the base workspace.

Set the data type of the corresponding port to Bus: `HitCrossMessage`.

Extended Capabilities

C/C++ Code Generation

Generate C and C++ code using Simulink® Coder™.

Not recommended for production code.

Does not support non-floating data type for ert targets.

HDL Code Generation

Generate Verilog and VHDL code for FPGA and ASIC designs using HDL Coder™.

HDL Coder provides additional configuration options that affect HDL implementation and synthesized logic.

HDL Architecture

This block has a single, default HDL architecture.

HDL Block Properties

| | |
|----------------------------------|--|
| ConstrainedOutputPipeline | Number of registers to place at the outputs by moving existing delays within your design. Distributed pipelining does not redistribute these registers. The default is 0. For more details, see “ConstrainedOutputPipeline” (HDL Coder). |
| InputPipeline | Number of input pipeline stages to insert in the generated code. Distributed pipelining and constrained output pipelining can move these registers. The default is 0. For more details, see “InputPipeline” (HDL Coder). |
| OutputPipeline | Number of output pipeline stages to insert in the generated code. Distributed pipelining and constrained output pipelining can move these registers. The default is 0. For more details, see “OutputPipeline” (HDL Coder). |

Restriction

The Hit crossing direction must be rising or falling.

HDL code generation is not supported when the Output Type is set to Message.

See Also

“Zero-Crossing Detection” | “Implement logic signals as Boolean data (vs. double)”

Introduced before R2006a

Horizontal Gauge

Display signal value during simulation on horizontal gauge with customizable appearance

Library: Simulink / Dashboard / Customizable Blocks



Description

The Horizontal Gauge block displays the value of the connected signal on a linear gauge that you can customize to look like a gauge in a real system.

The Horizontal Gauge block displays the instantaneous value of the connected signal throughout simulation. You can modify the range and tick values on the Horizontal Gauge block to fit your data. Use the Horizontal Gauge block with other dashboard blocks to build an interactive dashboard of controls and indicators for your model.

Customize Horizontal Gauge Blocks

When you add a Horizontal Gauge block to your model, the block is preconfigured with a default design. You can use the block with the default design or customize the appearance of the block using design mode. You can enter design mode in one of three ways after selecting the block:

- On the **Gauge** tab, under **Design**, click **Edit**.
- In the **Property Inspector**, on the **Design** tab, click **Edit**.
- Pause on the ellipsis that appears above the block and click the **Edit Custom Block** button.

In design mode, you have access to block parameters and settings that allow you to design the appearance of the block. You can use the toolbar above the block to change the background image or needle image and to set the opacity and color for the scale, tick labels, and value bar. To design the appearance of the scale, select the aspect of the scale you want to edit in the middle section of the toolbar. Use the controls on the right of the toolbar to set the color and opacity. You can also click and drag to reposition the needle or the scale.

For fine control of the block design, use the **Design** tab in the **Property Inspector**. You can use the **Property Inspector** to enter exact values for design settings. The **Design** tab also includes design parameters that are not available through the toolbar or interactive editing, such as the ability to add a foreground image to the block.

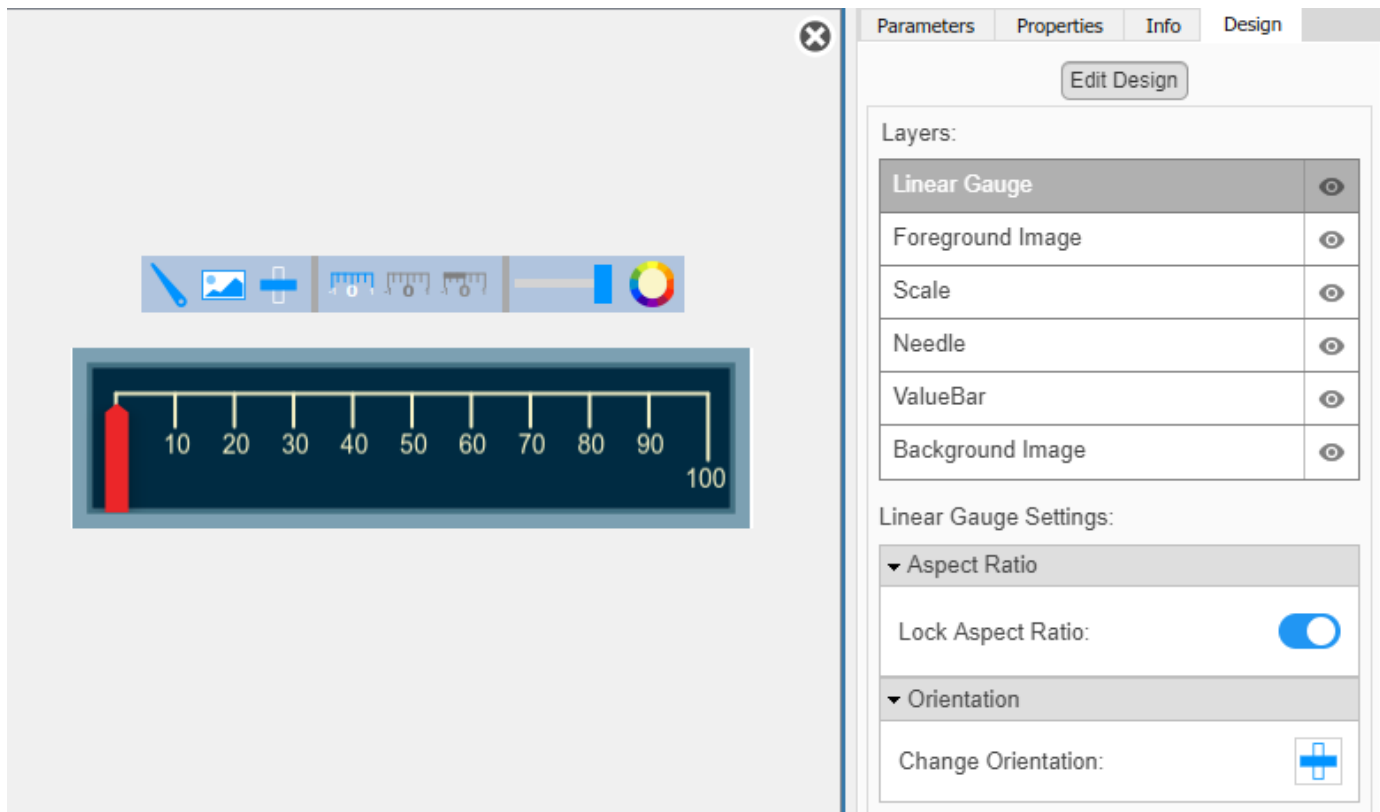

When you finish editing the design, click **Exit** in the upper-right of the canvas to exit design mode.

Connect Dashboard Blocks

Dashboard blocks do not use ports to connect to model elements. To connect dashboard blocks to signals in your model, use connect mode. Connect mode facilitates the process of connecting dashboard blocks in your model, especially when you want to connect multiple blocks at once. To connect a single dashboard block, you can also use the **Connection** table in the block dialog box.

Tip You can modify dashboard block connections during normal and accelerator mode simulations.

To enter connect mode, select a dashboard block to connect. Then, on the block tab, click **Connect**. In connect mode, when you select one or more signals or blocks, a list of signals that are available for connection appears. Select a signal from the list to connect to the selected dashboard block. To connect another dashboard block, pause on the block you want to connect and click the **Connect** button above it. Then, select one or more signals and blocks in the model and choose a signal to connect.

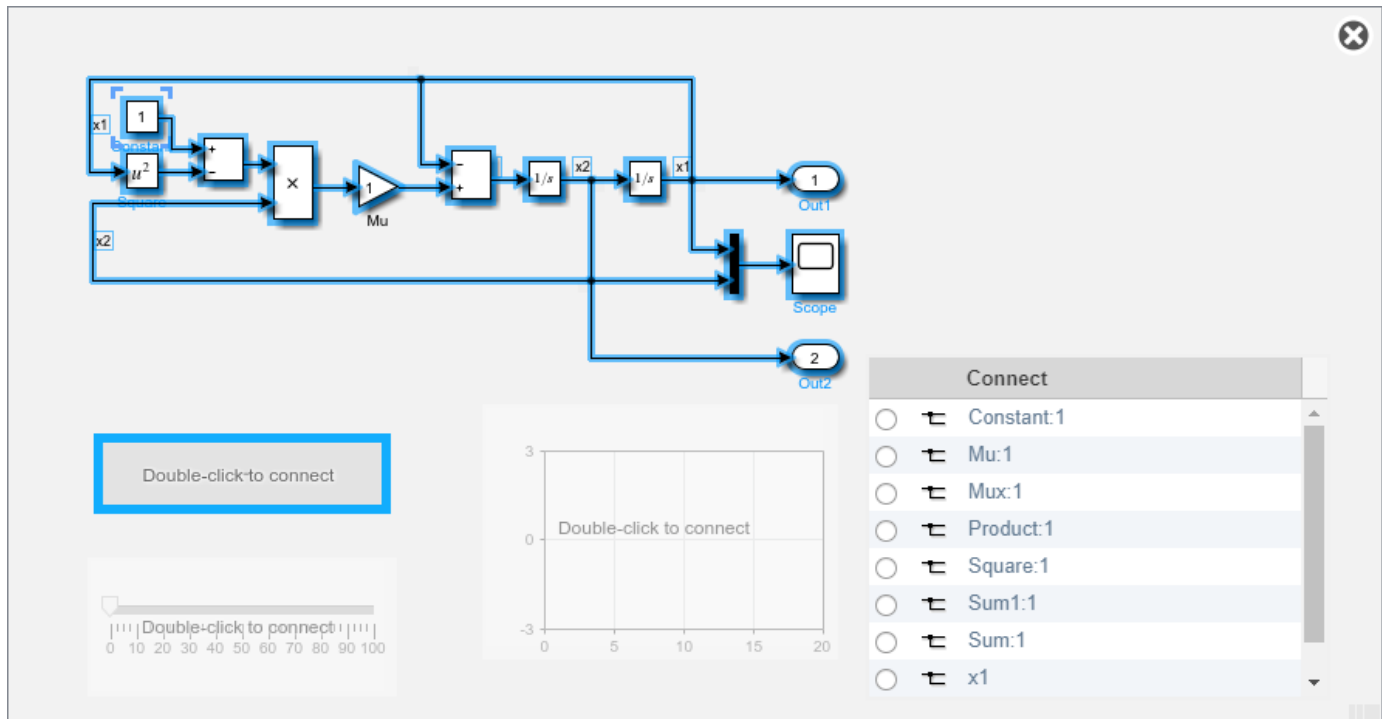

When you finish connecting the dashboard blocks in your model, on the block tab, click **Done Connecting**.

Tip You can hide the message shown on unconnected blocks using the `set_param` function with the `ShowInitialText` block parameter. The message also disappears when you connect the block.

Limitations

- Except for the Dashboard Scope block and the Display block, dashboard blocks can only connect to real scalar signals.
- The toolstrip does not support blocks that are inside a panel.
- You cannot use the **Connection** table in the block dialog to connect a dashboard block to a block that is commented out. When you connect a dashboard block to a commented block using connect mode, the dashboard block does not display the connected value until the you uncomment the block.
- Dashboard blocks cannot connect to model elements inside referenced models.
- When you simulate a model hierarchy, dashboard blocks inside referenced models do not update.
- Dashboard blocks do not support rapid accelerator simulation.
- You cannot connect a dashboard block to data or activity in Stateflow during simulation.
- Some signals do not have data available during simulation due to block reduction or optimization for accelerator mode simulations. To view such a signal using a dashboard block, mark the signal for logging.

Parameters

Connection — Signal to connect and display

signal connection options

Use the connection table to select the signal to connect to the block. To connect the block to a signal:

- 1 Make a selection in the model that includes one or more signals.
- 2 In the table, select the signal you want to connect.
- 3 Click **Apply**.

Tip You can connect dashboard blocks to signals in the model during simulation.

Programmatic Use

Block Parameter: Binding

Type: Simulink.HMI.SignalSpecification

Default: []

Minimum — Minimum tick mark value

0 (default) | scalar

Finite, real, double, scalar value specifying the minimum tick mark value for the scale. The minimum must be less than the value of the **Maximum** parameter.

Programmatic Use

To programmatically set the Minimum parameter, use a 1-by-3 vector containing values for the Minimum, Tick Interval, and Maximum parameters, in that order. To use the **auto** value for the Tick Interval, leave the Tick Interval position in the vector empty or specify -1.

Block Parameter: Limits

Type: 1x3 vector

Default: [0 -1 100]

Maximum — Maximum tick mark value

100 (default) | scalar

Finite, real, double, scalar value specifying the maximum tick mark value for the scale. The maximum must be greater than the value of the **Minimum** parameter.

Programmatic Use

To programmatically set the Maximum parameter, use a 1-by-3 vector containing values for the Minimum, Tick Interval, and Maximum parameters, in that order. To use the **auto** value for the Tick Interval, leave the Tick Interval position in the vector empty or specify -1.

Block Parameter: Limits

Type: 1x3 vector

Default: [0 -1 100]

Tick Interval — Interval between major tick marks

auto (default) | scalar

Finite, real, positive, whole, scalar value specifying the interval of major tick marks on the scale. When set to `auto`, the block automatically adjusts the tick interval based on the values of the **Maximum** and **Minimum** parameters.

Programmatic Use

To programmatically set the `Tick Interval` parameter, use a 1-by-3 vector containing values for the `Minimum`, `Tick Interval`, and `Maximum` parameters, in that order. To use the `auto` value for the `Tick Interval`, leave the `Tick Interval` position in the vector empty or specify `-1`.

Block Parameter: Limits

Type: 1x3 vector

Default: [0 -1 100]

Scale Colors — Color indications on gauge scale

colors for scale ranges

Color specifications for value ranges on the scale. Press the **+** button to add a scale color. For each color added, specify the minimum and maximum values of the range in which you want to display that color.

Programmatic Use

To programmatically specify the `Scale Colors` parameter, use an array of structures with the fields:

- `Min` — Minimum value for the color range on the scale
- `Max` — Maximum value for the color range on the scale
- `Color` — 1-by-3 vector of double values between 0 and 1 that specify the color for the range in the form [r g b]

Include a structure in the array for each scale range for which you want to specify a color.

```
range1.Min = 0;  
range1.Max = 10;  
range1.Color = [0 0 1];  
range2.Min = 10;  
range2.Max = 15;  
range2.Color = [0 1 0];  
scaleRanges = [range1 range2];
```

Block Parameter: ScaleColors

Type: structure array

Default: 0x1 struct array

Lock Aspect Ratio — Whether to maintain block aspect ratio

on (default) | off

Whether to maintain the block aspect ratio when resizing the block and when you specify a new background image.

Label — Block label position

Top (default) | Bottom | Hide

Position of the block label. When the block is connected to an element in the model, the label is the name of the connected element.

Programmatic Use**Block Parameter:** LabelPosition**Type:** character vector**Values:** 'Top' | 'Bottom' | 'Hide'**Default:** 'Top'**Opacity — Block background opacity**

1 (default) | scalar

Block background opacity, specified as a scalar value between 0 and 1. Specify the background opacity using the **Design** tab in the Property Inspector.

- 1 On the **Design** tab, click **Edit Design**.
- 2 Select the **Background** component.
- 3 In the **Background Color** section, specify the desired opacity.

Example: 0.5

Programmatic Use**Block Parameter:** Opacity**Type:** scalar**Default:** 1**Foreground Color — Block foreground color**

[r g b] vector

Block foreground color, excluding the text. The **Foreground Color** applies to the scale and the block name. To specify the color for the block text, use the **Font Color**.

Specify the **Foreground Color** for the block using the **Design** tab in the Property Inspector.

- 1 On the **Design** tab, click **Edit Design**.
- 2 Select the **Scale** component.
- 3 In the **Ticks** section, open the **Color** menu. You can choose from the palette of standard colors or specify a custom color.

Programmatic Use

Specify the `ForegroundColor` parameter for the block as a 1-by-3 [r g b] vector with values between 0 and 1.

Block Parameter: ForegroundColor**Type:** [r g b] vector**Background Color — Block background color**

[r g b] vector

Block background color. You can choose to select a solid background color instead of providing a background image. To design a block that uses a solid background, use the **Design** tab in the Property Inspector.

- 1 On the **Design** tab, click **Edit Design**.
- 2 Select the **Background** component.
- 3 Select **Use background color**.

- 4 Choose a background color from the palette of standard colors or specify a custom color.
- 5 Adjust the **Offset from scale** option until the solid background is the desired size.

Changing the background color using the toolstrip removes the background image and enables the **Use background color** option.

Programmatic Use

Specify the `BackgroundColor` parameter for the block as a 1-by-3 [r g b] vector with values between 0 and 1.

Block Parameter: `BackgroundColor`

Type: [r g b] vector

Font Color — Block font color

[r g b] vector

Block font color. The **Font Color** applies to the scale labels. To specify the color of the scale, use the **Foreground Color**.

Specify the **Font Color** for the block using the **Design** tab in the Property Inspector.

- 1 On the **Design** tab, click **Edit Design**.
- 2 Select the **Scale** component.
- 3 In the **Labels** section, open the **Color** menu. You can choose from the palette of standard colors or specify a custom color.

Block Characteristics

| | |
|---------------------------------|---|
| Data Types | Boolean double enumerated fixed point half integer single |
| Direct Feedthrough | no |
| Multidimensional Signals | no |
| Variable-Size Signals | no |
| Zero-Crossing Detection | no |

Extended Capabilities

C/C++ Code Generation

Generate C and C++ code using Simulink® Coder™.

Dashboard blocks are ignored for code generation.

See Also

Vertical Gauge | Linear Gauge | Circular Gauge

Topics

- “Tune and Visualize Your Model with Dashboard Blocks”
- “Simulation Pacing”

Introduced in R2020a

Horizontal Slider

Change parameter or variable value using horizontal slider with customizable appearance

Library: Simulink / Dashboard / Customizable Blocks



Description

Use the Horizontal Slider block to tune the value of a variable or block parameter during simulation. You can customize the appearance of the Horizontal Slider block to look like a control in a real system. You can adjust the scale range and tick values to fit the desired range for the value you want to tune. Use the Horizontal Slider block with other dashboard blocks to create an interactive dashboard to control your model.

Customize Horizontal Slider Blocks

When you add a Horizontal Slider block to your model, the block is preconfigured with a default design. You can use the block with the default design or customize the appearance of the block using design mode. You can enter design mode in one of three ways after selecting the block:

- On the **Slider** tab, under **Design**, click **Edit**.
- In the **Property Inspector**, on the **Design** tab, click **Edit**.
- Pause on the ellipsis that appears above the block and click the **Edit Custom Block** button.

In design mode, you have access to block parameters and settings that allow you to design the appearance of the block. You can use the toolbar above the block to change the background image or needle image and to set the opacity and color for the scale, tick labels, and value bar. To design the appearance of the scale, select the aspect of the scale you want to edit in the middle section of the toolbar. Use the controls on the right of the toolbar to set the color and opacity. You can also click and drag to reposition the needle or the scale.

For fine control of the block design, use the **Design** tab in the **Property Inspector**. You can use the **Property Inspector** to enter exact values for design settings. The **Design** tab also includes design parameters that are not available through the toolbar or interactive editing, such as the ability to add a foreground image to the block.

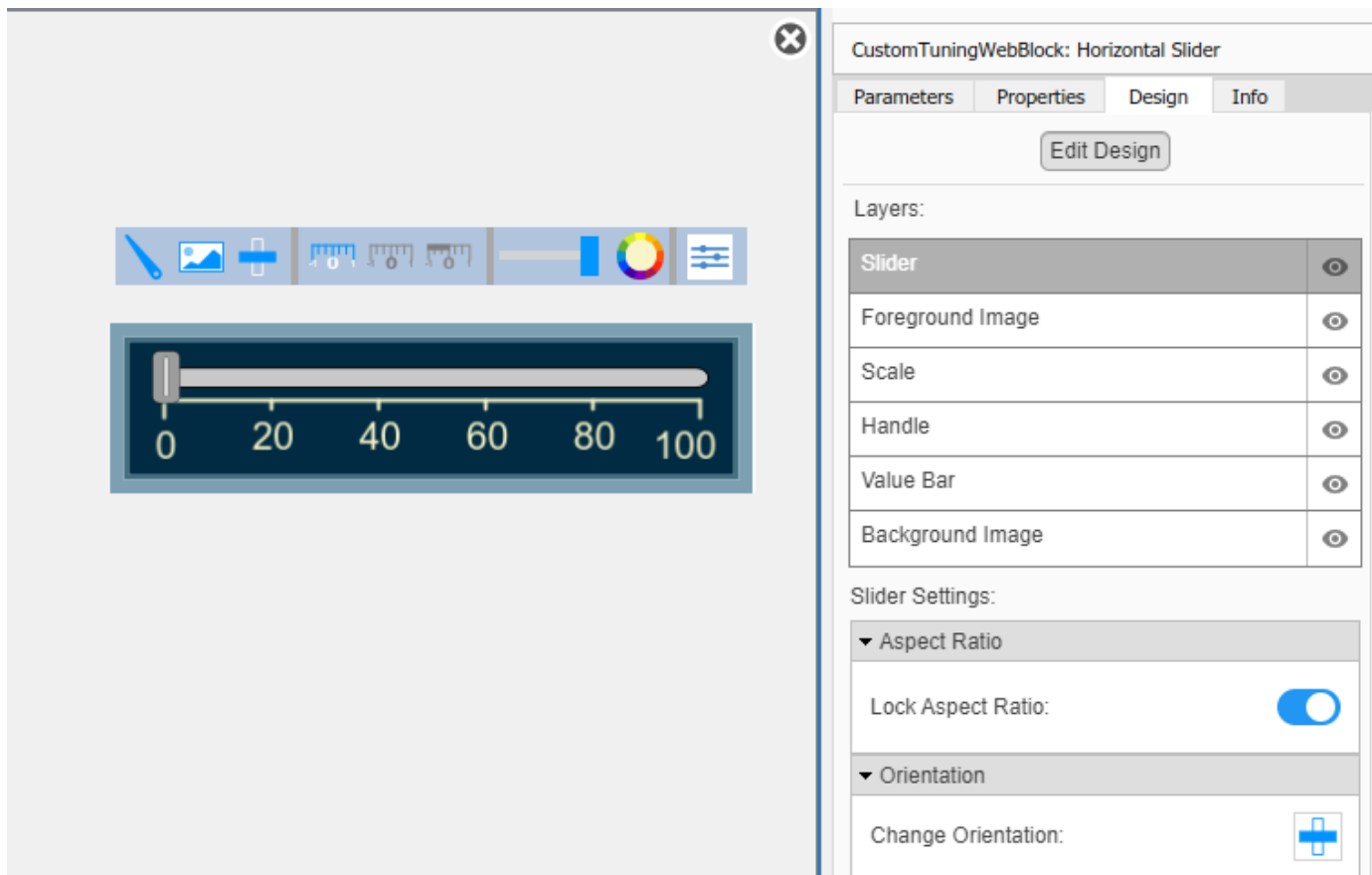

When you finish editing the design, click **Exit** in the upper-right of the canvas to exit design mode.

Connect Dashboard Blocks

Dashboard blocks do not use ports to connect to model elements. To connect dashboard blocks to variables and block parameters, use connect mode. Connect mode facilitates the process of connecting dashboard blocks in your model, especially when you want to connect multiple blocks at once. To connect a single dashboard block, you can also use the **Connection** table in the block dialog box.

Tip You can modify dashboard block connections in your model during normal and accelerator mode simulations.

Note Dashboard blocks cannot connect to variables until you update the model diagram. To connect dashboard blocks to variables or modify variable values between opening your model and running a simulation, update the model diagram using **Ctrl+D**.

To enter connect mode, select the block. Then, on the block tab, click **Connect**. In connect mode, when you select one or more blocks, a list of parameters and variables available for connection appears. Select a variable or parameter from the list to connect to the selected dashboard block.

When the value of the selected variable or block parameter is nonscalar, use the text box at the bottom of the **Connection** table to specify the element you want to connect to the dashboard block. To connect to an element of a vector, matrix, or array, specify the element index, for example, 3 or (1,3). To connect to an element in a bus or structure, specify the element in the context of the bus or structure hierarchy by using dots to indicate different levels in the hierarchy, and omit the top level. For example, specify a.b to connect to scalar element b of the structure or bus a nested inside the selected composite variable or parameter.

To connect another dashboard block, pause on another dashboard block and click the **Connect** button above it. Then, make a selection of signals and blocks in your model and choose a model element to connect.

When you finish connecting the dashboard blocks in your model, on the block tab, click **Done Connecting**.

Tip You can hide the message shown on unconnected blocks using the `set_param` function with the `ShowInitialText` block parameter. The message also disappears when you connect the block.

Parameter Logging

Tunable parameters connected to dashboard blocks are logged to the Simulation Data Inspector, where you can view the parameter values along with logged signal data. You can access logged parameter data in the MATLAB workspace by exporting the parameter data from the Simulation Data Inspector by using the UI or the `Simulink.sdi.exportRun` function. For more information about exporting data using the Simulation Data Inspector UI, see “Export Data to the Workspace or a File”. The parameter data is stored in a `Simulink.SimulationData.Parameter` object, accessible as an element in the exported `Simulink.SimulationData.Dataset`.

Limitations

- Except for the Dashboard Scope block and the Display block, dashboard blocks can only connect to real scalar signals.
- The toolstrip does not support blocks that are inside a panel.
- You cannot use the **Connection** table in the block dialog to connect a dashboard block to a block that is commented out. When you connect a dashboard block to a commented block using connect mode, the dashboard block does not display the connected value until the you uncomment the block.
- Dashboard blocks cannot connect to model elements inside referenced models.
- When you simulate a model hierarchy, dashboard blocks inside referenced models do not update.
- Dashboard blocks do not support rapid accelerator simulation.
- When you connect a dashboard block to a variable or parameter during simulation, the data for that variable or parameter is not logged to the Simulation Data Inspector. To log variable and parameter data to the Simulation Data Inspector, connect the dashboard block to the variable or parameter prior to simulation.
- When you simulate a model in external mode with the **Default parameter behavior** set to **Inlined**, dashboard blocks can appear to change parameter and variable values. However, the change does not propagate to the simulation. For example, Gain blocks display changes made to the **Gain** parameter using the dashboard blocks, but the **Gain** value used in the simulation does not change.

Parameters

Connection — Select a variable or block parameter to connect

variable and parameter connection options

Select the variable or block parameter to control using the **Connection** table. To connect the block to a signal:

- 1 Make a selection in the model that includes one or more blocks.
- 2 Select the variable or parameter you want to connect.

When the value of the selected variable or block parameter is nonscalar, use the text box at the bottom of the **Connection** table to specify the element you want to connect to the dashboard block. To connect to an element of a vector, matrix, or array, specify the element index, for example, 3 or (1,3). To connect to an element in a bus or structure, specify the element in the context of the bus or structure hierarchy by using dots to indicate different levels in the hierarchy, and omit the top level. For example, specify a.b to connect to scalar element b of the structure or bus a nested inside the selected composite variable or parameter.

- 3 Click **Apply**.

To facilitate understanding and debugging your model, you can connect Dashboard blocks to variables and parameters in your model during simulation.

Note To see workspace variables in the connection table, update the model diagram using **Ctrl+D**.

Programmatic Use

To programmatically connect a dashboard block to a tunable parameter or a variable, use a `Simulink.HMI.ParamSourceInfo` object. The `Simulink.HMI.ParamSourceInfo` object contains four properties. Some of the properties apply to connecting dashboard blocks to parameters, and some apply to connecting dashboard blocks to variables. Not all fields have a value for a connection because a given dashboard block connects to either a parameter or a variable.

Block Parameter: Binding

Type: `Simulink.HMI.ParamSourceInfo`

Default: `[]`

Minimum — Minimum tick mark value

0 (default) | scalar

Finite, real, double, scalar value specifying the minimum tick mark value for the scale. The minimum must be less than the value of the **Maximum** parameter.

Programmatic Use

To programmatically set the `Minimum` parameter, use a 1-by-3 vector containing values for the `Minimum`, `Tick Interval`, and `Maximum` parameters, in that order. To use the `auto` value for the `Tick Interval`, leave the `Tick Interval` position in the vector empty or specify `-1`.

Block Parameter: Limits

Type: 1x3 vector

Default: `[0 -1 100]`

Maximum — Maximum tick mark value

100 (default) | scalar

Finite, real, double, scalar value specifying the maximum tick mark value for the scale. The maximum must be greater than the value of the **Minimum** parameter.

Programmatic Use

To programmatically set the `Maximum` parameter, use a 1-by-3 vector containing values for the `Minimum`, `Tick Interval`, and `Maximum` parameters, in that order. To use the `auto` value for the `Tick Interval`, leave the `Tick Interval` position in the vector empty or specify `-1`.

Block Parameter: Limits

Type: 1x3 vector

Default: `[0 -1 100]`

Tick Interval — Interval between major tick marks

auto (default) | scalar

Finite, real, positive, whole, scalar value specifying the interval of major tick marks on the scale. When set to `auto`, the block automatically adjusts the tick interval based on the values of the **Maximum** and **Minimum** parameters.

Programmatic Use

To programmatically set the `Tick Interval` parameter, use a 1-by-3 vector containing values for the `Minimum`, `Tick Interval`, and `Maximum` parameters, in that order. To use the `auto` value for the `Tick Interval`, leave the `Tick Interval` position in the vector empty or specify `-1`.

Block Parameter: Limits

Type: 1x3 vector

Default: [0 -1 100]

Label — Block label position

Top (default) | Bottom | Hide

Position of the block label. When the block is connected to an element in the model, the label is the name of the connected element.

Programmatic Use

Block Parameter: LabelPosition

Type: character vector

Values: 'Top' | 'Bottom' | 'Hide'

Default: 'Top'

Foreground Color — Block foreground color

[r g b] vector

Block foreground color, excluding the text. The **Foreground Color** applies to the scale and the block name. To specify the color for the block text, use the **Font Color**.

Specify the **Foreground Color** for the block using the **Design** tab in the Property Inspector.

- 1 On the **Design** tab, click **Edit Design**.
- 2 Select the **Scale** component.
- 3 In the **Ticks** section, open the **Color** menu. You can choose from the palette of standard colors or specify a custom color.

Programmatic Use

Specify the `ForegroundColor` parameter for the block as a 1-by-3 [r g b] vector with values between 0 and 1.

Block Parameter: ForegroundColor

Type: [r g b] vector

Background Color — Block background color

[r g b] vector

Block background color. You can choose to select a solid background color instead of providing a background image. To design a block that uses a solid background, use the **Design** tab in the Property Inspector.

- 1 On the **Design** tab, click **Edit Design**.
- 2 Select the **Background** component.
- 3 Select **Use background color**.
- 4 Choose a background color from the palette of standard colors or specify a custom color.
- 5 Adjust the **Offset from scale** option until the solid background is the desired size.

Changing the background color using the toolbar removes the background image and enables the **Use background color** option.

Programmatic Use

Specify the `BackgroundColor` parameter for the block as a 1-by-3 [r g b] vector with values between 0 and 1.

Block Parameter: BackgroundColor

Type: [r g b] vector

Font Color — Block font color

[r g b] vector

Block font color. The **Font Color** applies to the scale labels. To specify the color of the scale, use the **Foreground Color**.

Specify the **Font Color** for the block using the **Design** tab in the Property Inspector.

- 1 On the **Design** tab, click **Edit Design**.
- 2 Select the **Scale** component.
- 3 In the **Labels** section, open the **Color** menu. You can choose from the palette of standard colors or specify a custom color.

Block Characteristics

| | |
|---------------------------------|----------------------------------|
| Data Types | double half integer single |
| Direct Feedthrough | no |
| Multidimensional Signals | no |
| Variable-Size Signals | no |
| Zero-Crossing Detection | no |

Extended Capabilities

C/C++ Code Generation

Generate C and C++ code using Simulink® Coder™.

Dashboard blocks are ignored for code generation.

See Also

Blocks

Vertical Slider | Slider | Knob | Circular Gauge | Horizontal Gauge | Vertical Gauge

Topics

“Tune and Visualize Your Model with Dashboard Blocks”

“Simulation Pacing”

Introduced in R2021a

IC

Set initial value of signal

Library: Simulink / Signal Attributes

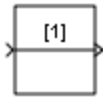

Description

The IC block sets the initial condition of the signal at its input port, for example, the value of the signal at the simulation start time (t_{start}). To do so, the block outputs the specified initial condition when you start the simulation, regardless of the actual value of the input signal. Thereafter, the block outputs the actual value of the input signal.

The IC block is useful for providing an initial guess for the algebraic state variables in a loop. For more information, see “Algebraic Loop Concepts”.

Behavior for Nonzero Sample Time Offset

If an IC block has a nonzero sample time offset (t_{offset}), the IC block outputs its initial value at time t ,

$$t = n * t_{period} + t_{offset}$$

where n is the smallest integer such that $t \geq t_{start}$.

That is, the IC block outputs its initial value the first-time blocks with sample time $[t_{period}, t_{offset}]$ execute, which can be after t_{start} .

Ports

Input

Port_1 – Input signal

scalar | vector | matrix | N-D array

Input signal, specified as a scalar, vector, matrix, or N-D array. The block sets the initial condition of this signal to the **Initial value** you specify.

Data Types: single | double | int8 | int16 | int32 | int64 | uint8 | uint16 | uint32 | uint64 | Boolean | fixed point | enumerated | bus

Output

Port_1 – Output signal

scalar | vector | matrix | N-D array

Output signal provided as the **Initial value** you specify, followed by the actual values of the input signal. See “Behavior for Nonzero Sample Time Offset” on page 1-733 for more information.

Data Types: `single` | `double` | `int8` | `int16` | `int32` | `int64` | `uint8` | `uint16` | `uint32` | `uint64` | `Boolean` | `fixed point` | `enumerated` | `bus`

Parameters

Initial value — Initial value

1 (default) | real, finite scalar, vector, matrix, or N-D array

Specify the initial value of the input signal as a finite, real-valued scalar, vector, matrix, or N-D array. The value must be a scalar, or have the same dimensions as the input signal.

Programmatic Use

Block Parameter: Value

Type: character vector

Values: scalar | vector | matrix | N-D array

Default: '1'

Sample time — Specify sample time as a value other than -1

-1 (default) | scalar | vector

Specify the sample time as a value other than -1. For more information, see “Specify Sample Time”.

Dependencies

This parameter is not visible unless it is explicitly set to a value other than -1. To learn more, see “Blocks for Which Sample Time Is Not Recommended”.

Programmatic Use

Block Parameter: SampleTime

Type: character vector

Values: scalar or vector

Default: '-1'

Block Characteristics

| | |
|---------------------------------|--|
| Data Types | Boolean bus double enumerated fixed point integer single |
| Direct Feedthrough | yes |
| Multidimensional Signals | yes |
| Variable-Size Signals | no |
| Zero-Crossing Detection | no |

Extended Capabilities

C/C++ Code Generation

Generate C and C++ code using Simulink® Coder™.

Not recommended for production code. Relates to resource limits and restrictions on speed and memory often found in embedded systems. Generated code can contain dynamic allocation and freeing of memory, recursion, additional memory overhead, and widely varying execution times. While the code is functionally valid and generally acceptable in resource-rich environments, smaller embedded targets often cannot support such code. Usually, blocks evolve toward being suitable for production code. Thus, blocks suitable for production code remain suitable.

Fixed-Point Conversion

Design and simulate fixed-point systems using Fixed-Point Designer™.

See Also**Topics**

“What Is Sample Time?”

“Algebraic Loop Concepts”

Introduced before R2006a

Identity Matrix

Generate matrix with ones on main diagonal and ground values elsewhere

Library: Simulink / Matrix Operations



Description

The Identity Matrix block outputs an identity matrix, similar to the MATLAB `eye` function. The block generates a square or rectangular matrix with ones on the main diagonal and zeros elsewhere.

Ports

Input

Port_1 – Input signal

scalar | vector | matrix

Input signal used to determine dimensions of the output matrix, specified as a scalar, vector, or matrix. When the input signal is an M -by- N matrix, the block generates an M -by- N matrix output with the same sample period as the input. The values in the input matrix are ignored.

Dependencies

To enable this port, select the **Inherit output port attributes from input port** check box.

Data Types: single | double | half | int8 | int16 | int32 | int64 | uint8 | uint16 | uint32 | uint64 | Boolean | fixed point

Output

Port_1 – Identity matrix

scalar | vector | matrix

Identity matrix, specified as a scalar, vector, or matrix.

Data Types: single | double | half | int8 | int16 | int32 | int64 | uint8 | uint16 | uint32 | uint64 | Boolean | fixed point

Parameters

Inherit output port attributes from input port – Option for output port to inherit attributes from input port

off (default) | on

Select this check box for the output port to inherit its dimensions, sample period, and data type from the input port. Otherwise, clear this check box.

Programmatic Use**Block Parameter:** InheritOutputPortAttributes**Type:** character vector**Values:** 'on' | 'off'**Default:** 'off'**Output dimensions — Size of output matrix**

5 (default) | scalar | two-element vector

The number of rows and columns in the output matrix. You can specify:

- A positive integer scalar M to create a square M -by- M output.
- A vector of positive integers, $[M\ N]$, to create an M -by- N output.

Dependencies

To enable this parameter, clear the **Inherit output port attributes from input port** check box.

Programmatic Use**Block Parameter:** OutputDimensions**Type:** character vector**Values:** scalar | two-element vector**Default:** '5'**Output data type — Output data type**

double (default) | single | int8 | uint8 | int16 | uint16 | int32 | uint32 | int64 | uint64 | boolean | fixdt(1,16,0) | Inherit: Inherit via back propagation | <data type expression>

Specify the output data type for this block. You can select one of these options:

- A rule that inherits a data type, for example, Inherit: Inherit via back propagation. When you select this option, the output data type and scaling matches that of the next downstream block.
- A built-in data type, such as double.
- An expression that evaluates to a valid data type, for example, fixdt(1,16).

For help setting data type parameters, display the **Data Type Assistant** by clicking the **Show data type assistant** button .

See “Control Data Types of Signals” for more information.

Programmatic Use**Block Parameter:** OutDataTypeStr**Type:** character vector

Values: 'Inherit: Inherit via back propagation' | 'double' | 'single' | 'half' | 'int8' | 'uint8' | 'int16' | 'uint16' | 'int32' | 'uint32' | 'int64' | 'uint64' | 'fixdt(1,16,0)' | '<data type expression>'

Default: 'double'**Mode — Data type mode**

Inherit (default) | Built in | Fixed point | Expression

Select how you would like to specify the data type properties of the **Output data type**. You can choose:

- **Inherit** — Specify a rule for inheriting a data type, for example, `Inherit: Same as input`.
- **Built in**— Specify a built-in data type, for example, `double`.
- **Fixed point** — Specify the fixed-point attributes of the data type.
- **Expression** — Specify an expression that evaluates to a valid data type, for example, `fixdt(1,16)`.

For more information, see “Specify Data Types Using Data Type Assistant”.

Signedness — Signedness of fixed-point data

`Signed (default) | Unsigned`

Specify whether the fixed-point data is signed or unsigned. **Signed** data can represent positive and negative values, but **Unsigned** data represents positive values only. For more information, see “Specify Data Types Using Data Type Assistant”.

Scaling — Method for scaling fixed-point data

`Best precision (default) | Binary point`

Specify the method for scaling your fixed-point data to avoid overflow conditions and minimize quantization errors. For more information, see “Specify Data Types Using Data Type Assistant”.

Dependencies

To enable this parameter, set **Mode** to `Fixed point`

Word length — Bit size of word that holds quantized integer

`16 (default) | integer from 2 to 128`

Specify the bit size of the word that holds the quantized integer as a positive integer from 2 to 128. For more information, see “Specify Data Types Using Data Type Assistant”.

Dependencies

To enable this parameter, set **Mode** to `Fixed point`.

Fraction length — Fraction length for fixed-point data type

`0 (default) | integer scalar`

Specify the fraction length of the fixed-point data type as a positive or negative integer scalar.

Dependencies

To enable this parameter, set **Mode** to `Fixed point` and **Scaling** to `Binary point`.

Data type override — Data type override mode

`Inherit (default) | Off`

Select the data type override mode for this signal. You can select:

- **Inherit** — Inherits the data type override setting specified for the model.
- **Off** — Ignores the data type override setting specified for the model and uses the fixed-point data type you specify.

Dependencies

To enable this parameter, set **Mode** to **Built in** or **Fixed point**. For more information, see “Specify Data Types Using Data Type Assistant”.

Sample time — Output sample period

1 (default) | scalar

The discrete sample period of the output, specified as a real-valued scalar.

Dependencies

To enable this parameter, clear the **Inherit output port attributes from input port** check box.

Programmatic Use

Block Parameter: SampleTime

Type: character vector

Values: scalar or vector

Default: '1'

Block Characteristics

| | |
|---------------------------------|--|
| Data Types | Boolean double fixed point half integer single |
| Direct Feedthrough | no |
| Multidimensional Signals | no |
| Variable-Size Signals | no |
| Zero-Crossing Detection | no |

Extended Capabilities**C/C++ Code Generation**

Generate C and C++ code using Simulink® Coder™.

See Also

eye | Cross Product | Hermitian Transpose | IsSymmetric | IsTriangular | Matrix Square | Transpose

Topics

“Compatible Array Sizes for Basic Operations”

MATLAB Matrix Operations

Introduced in R2021b

If

Select subsystem execution using logic similar to `if-else` statement

Library: Simulink / Ports & Subsystems



Description

The If block, along with If Action Subsystem blocks containing an Action Port block, implements if-else logic to control subsystem execution. For an example using the If block, see If Action Subsystems.

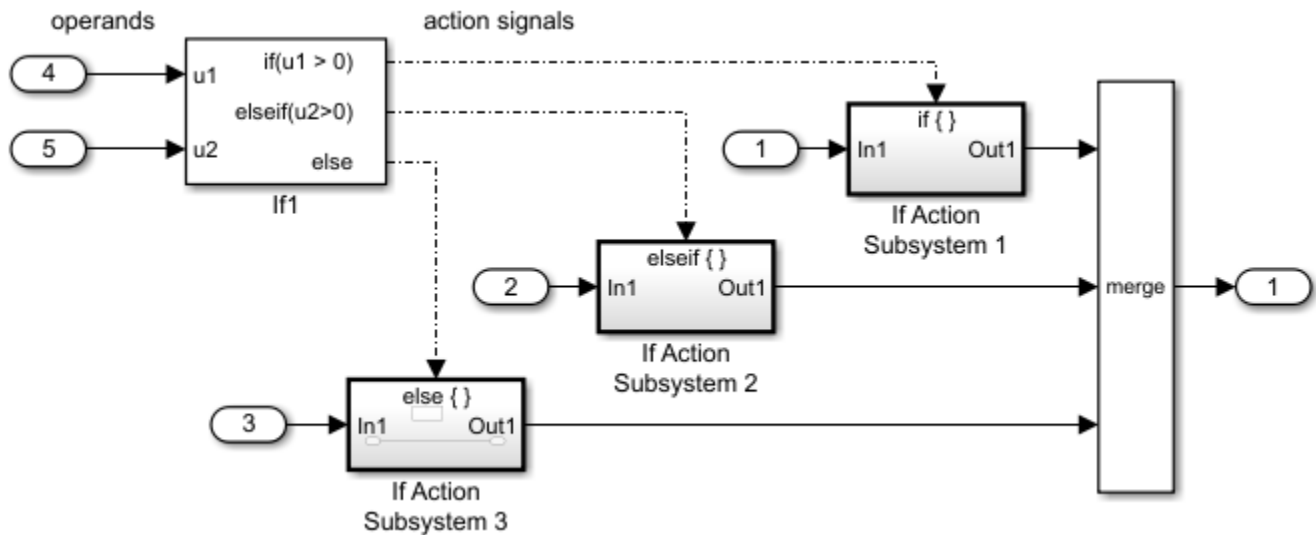

Limitations

The If block has the following limitations:

- It does not support tunable parameters. Values for an `if` or `elseif` expression cannot be tuned during a simulation in normal or accelerator mode, or when running generated code.

To implement tunable if-else expressions, tune the expression outside the If block. For example, use the Relational Operator block to evaluate the expression outside of the If block or add the tunable parameter as an input to the If block.

- It does not support custom storage classes. See “Organize Parameter Data into a Structure by Using Struct Storage Class” (Embedded Coder).
- The **If expression** and **Elseif expressions** cannot accept certain operators, such as `+`, `-`, `*`, and `/`.

Ports

Input

Logical operands — Values for evaluating logical expressions

scalar | vector

Inputs u_1, u_2, \dots, u_n must have the same data type. The inputs cannot be of any user-defined type, such as an enumerated type.

The If block does not directly support fixed-point data types. However, you can use the Compare To Constant block to work around this limitation. See Support for Fixed-Point Data Type in If Action Subsystems.

The If block does not support a boolean data type. If you want to input a boolean signal to an If block, convert the signal to an integer type using the Data Type Conversion block.

Data Types: `single` | `double` | `int8` | `int16` | `int32` | `uint8` | `uint16` | `uint32`

Output

Action — Action signal for an If Action Subsystem block

scalar

Outputs from the `if`, `else`, and `elseif` ports are action signals to If Action Subsystem blocks.

Support for Fixed-Point Data Type

Parameters

Number of inputs — Specify number of input ports

1 (default) | integer

1

Specify one input port.

integer

Specify the number of input ports. Block ports are labeled with a 'u' character followed by a number, $1, 2, \dots, n$, where n equals the number of inputs that you specify.

Programmatic Use

Block Parameter: NumInputs

Type: character vector

Values: '1' | '<integer>'

Default: '1'

if expression — Specify logical expression

$u_1 > 0$ (default) | logical expression

The If Action Subsystem attached to the `if` port executes when its associated expression evaluates to true.

$u_1 > 0$

Specify sending an action signal on the output port when the input u_1 is greater than 0.

logical expression

Specify logical expression. This expression appears on the If block adjacent to the **if** output port.

The expression can include only the operators `<`, `<=`, `==`, `~=`, `>`, `>=`, `&`, `|`, `~`, `()`, unary-minus. Operators such as `+`, `-`, `*`, `/`, and `^` are not allowed. The expression must not contain data type expressions, for example, `int8(6)`, and must not reference workspace variables whose data type is other than `double` or `single`.

Programmatic Use

Block Parameter: IfExpression

Type: character vector

Values: `'u1 > 0'` | `'<logical expression>'`

Default: `'u1 > 0'`

Elseif expressions — Specify logical expression

empty (default) | list of logical expressions

The If Action Subsystem attached to an **elseif** port executes when its expression evaluates to `true` and all `if` and `elseif` expressions are false.

empty

Logical expressions not specified.

list of logical expressions

Specify a list of logical expressions delimited by commas. The expressions appear on the If block below the **if** port and above the **else** port when you select the **Show else condition** check box.

Expressions can include only the operators `<`, `<=`, `==`, `~=`, `>`, `>=`, `&`, `|`, `~`, `()`, unary-minus. Operators such as `+`, `-`, `*`, `/`, and `^` are not allowed. The expressions must not contain data type expressions, for example, `int8(6)`, and must not reference workspace variables whose data type is other than `double` or `single`.

Programmatic Use

Block Parameter: ElseIfExpressions

Type: character vector

Values: `''` | `'<list of logical expressions>'`

Default: `''`

Show else condition — Control display of else port

on (default) | off

When the **if** port and all **elseif** port expressions are false, the **else** port sends an action signal to execute the attached If Action Subsystem block.



on

Display **else** port.



off

Hide **else** port.

Programmatic Use

Block Parameter: ShowElse

Type: character vector

Values: 'on' | 'off'

Default: 'on'

Enable zero-crossing detection — Control zero-crossing detection

on (default) | off

Control zero-crossing detection.

on

Detect zero crossings.

off

Do not detect zero crossings.

Programmatic Use

Block Parameter: ZeroCross

Type: character vector

Values: 'on' | 'off'

Default: 'on'

Block Characteristics

| | |
|---------------------------------|-------------------------------------|
| Data Types | Boolean double integer single |
| Direct Feedthrough | yes |
| Multidimensional Signals | no |
| Variable-Size Signals | no |
| Zero-Crossing Detection | yes |

Extended Capabilities

C/C++ Code Generation

Generate C and C++ code using Simulink® Coder™.

See Also

Blocks

Subsystem | Action Port | If Action Subsystem

Topics

Select Subsystem Execution

Introduced before R2006a

If Action Subsystem

Subsystem whose execution is enabled by If block

Library: Simulink / Ports & Subsystems

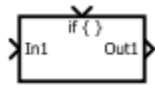

Description

The If Action Subsystem block is a Subsystem block preconfigured as a starting point for creating a subsystem whose execution is controlled by an If block. The If block evaluates a logical expression and then, depending on the result of the evaluation, outputs an action signal. Execution of the subsystem is controlled by an Action Port block placed inside the subsystem.

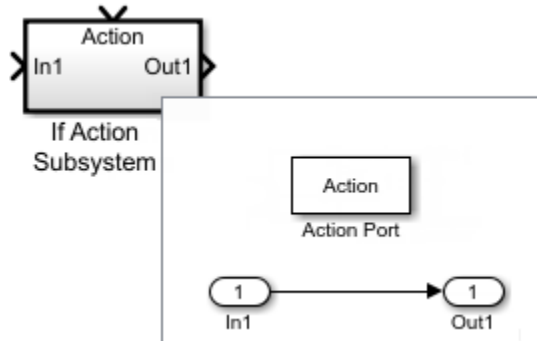

Simulink ignores a priority set on an If Action Subsystem block. Instead, set the priority on the If block that initiates execution of the subsystem.

Merge signals from If Action Subsystem blocks

This example shows how to merge signals controlled by an If block. The If block selects the execution of an If Action Subsystem block from a set of subsystems. Regardless of which subsystem the If block selects, you can create a single signal with a Merge block. To open the model, see `ex_if_block`.

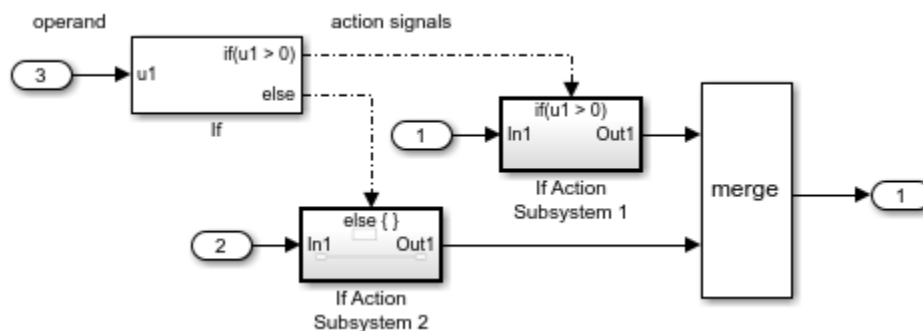

All blocks in an If Action Subsystem block must execute at the same rate as the driving If block. You can satisfy this requirement by setting the sample time parameter for each block to either inherited (-1) or the same value as the If block sample time.

Support for Fixed-Point Data Type

The If block does not directly support fixed-point data types. However, you can use the Compare To Constant block to work around this limitation.

Consider the following floating-point model without fixed-point data types. To open model, see `ex_if_block_floating_point`.

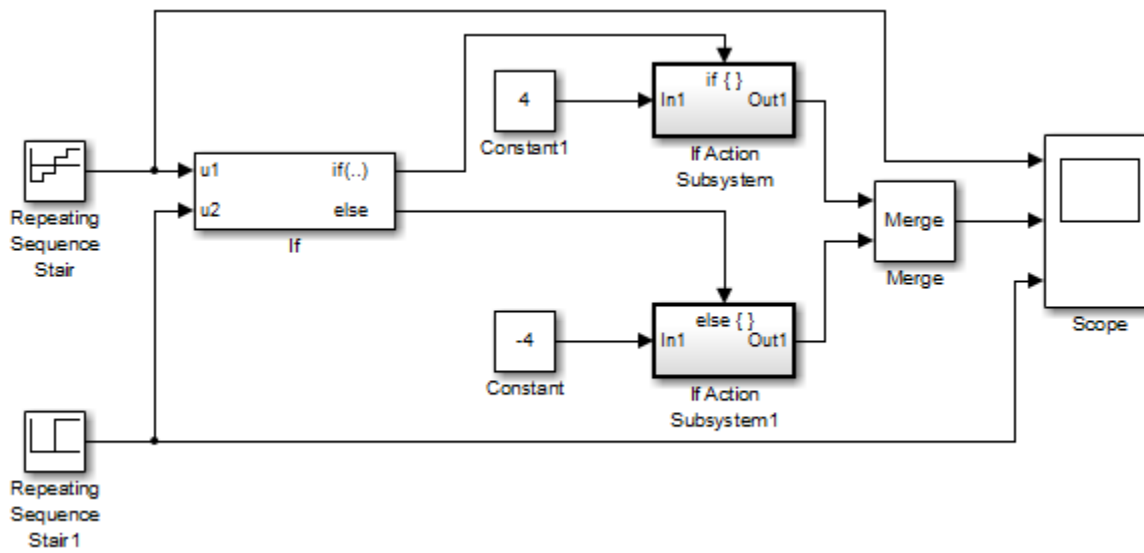

In this model, the If Action Subsystem blocks use their default configurations. The simulation parameters are set to their default values except for the parameters listed in the following table.

| Configuration Parameter Pane | Parameter | Setting |
|------------------------------|-----------------|---------------------------------|
| Solver | Start time | 0.0 |
| | Stop time | 1.0 |
| | Type | Fixed-step |
| | Solver | discrete (no continuous states) |
| | Fixed-step size | 0.1 |

The block parameters are set to their default values except for the parameters listed in the following table.

| Block | Parameter | Setting |
|---------------------------|-------------------------|--|
| Repeating Sequence Stair | Vector of output values | <code>[-2 -1 1 2].'</code> |
| Repeating Sequence Stair1 | Vector of output values | <code>[0 0 0 0 1 1 1 1].'</code> |
| If | Number of inputs | 2 |
| | If expression | <code>(u1 > 0) (u2 > 0.5)</code> |
| | Show else condition | Selected |

| Block | Parameter | Setting |
|-----------|----------------|---------|
| Constant | Constant value | -4 |
| Constant1 | Constant value | 4 |
| Scope | Number of axes | 3 |
| | Time range | 1 |

For this model, when input $u1$ is greater than 0 or input $u2$ is greater than 0.5, the output is 4. Otherwise, the output is -4. The Scope block displays the output from the Merge block with inputs $u1$, and $u2$.

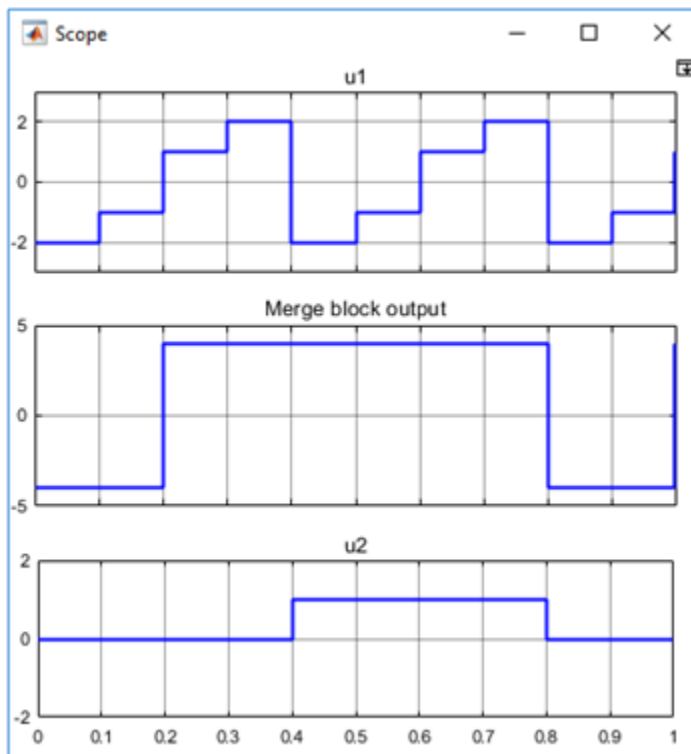

You can implement this block diagram as a model with fixed-point data types. To open model, see `ex_if_block_fixed_point`.

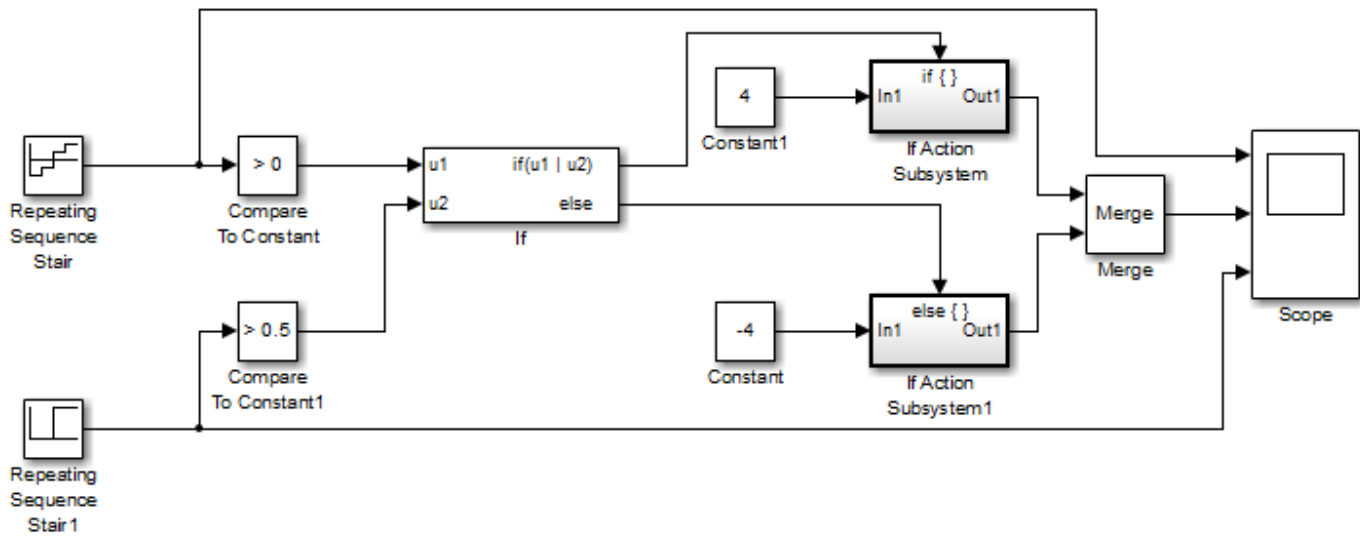

The Repeating Sequence Stair blocks output fixed-point data types.

The Compare To Constant blocks implement two parts of the **If expression** that is used in the If block in the floating-point version of the model, ($u1 > 0$) and ($u2 > 0.5$). The OR operation, ($u1 | u2$), can still be implemented inside the If block. For a fixed-point model, the expression must be partially implemented outside of the If block as it is in this model.

The block and simulation parameters for the fixed-point model are the same as for the floating-point model with the following exceptions and additions:

| Block | Parameter | Setting |
|----------------------|---------------------------------------|-----------|
| Compare To Constant | Operator | > |
| | Constant value | 0 |
| | Output data type mode | Boolean |
| | Enable zero-crossing detection | off |
| Compare To Constant1 | Operator | > |
| | Constant value | 0.5 |
| | Output data type mode | Boolean |
| | Enable zero-crossing detection | off |
| If | Number of inputs | 2 |
| | If expression | $u1 u2$ |

Ports

Input

In — Signal input to a subsystem block

scalar | vector | matrix

Placing an Inport block in a subsystem block adds an external input port to the block. The port label matches the name of the Inport block.

Use Inport blocks to get signals from the local environment.

Data Types: `half` | `single` | `double` | `int8` | `int16` | `int32` | `int64` | `uint8` | `uint16` | `uint32` | `uint64` | `Boolean` | `fixed point` | `enumerated` | `bus`

Action — Control signal input to a subsystem block

`scalar` | `vector` | `matrix`

Placing an Action Port block in a subsystem block adds an external input port to the block and changes the block to an If Action Subsystem.

Dot-dash lines from a Switch Case block to an Switch Case Action Subsystem block represent *action* signals. An action signal is a control signal connected to the action port of a Switch Case Action Subsystem block. A message on the action signal initiates execution of the subsystem.

Data Types: `action`

Output

Out — Signal output from a subsystem

`scalar` | `vector` | `matrix`

Placing an Outport block in a subsystem block adds an output port from the block. The port label on the subsystem block is the name of the Outport block.

Use Outport blocks to send signals to the local environment.

Data Types: `half` | `single` | `double` | `int8` | `int16` | `int32` | `int64` | `uint8` | `uint16` | `uint32` | `uint64` | `Boolean` | `fixed point` | `enumerated` | `bus`

Block Characteristics

| | |
|---------------------------------|---|
| Data Types | <code>Boolean^a</code> <code>bus^a</code> <code>double^a</code> <code>enumerated^a</code> <code>fixed point^a</code> <code>half^a</code> <code>integer^a</code> <code>single^a</code> <code>string^a</code> |
| Direct Feedthrough | no |
| Multidimensional Signals | limited ^a |
| Variable-Size Signals | limited ^a |
| Zero-Crossing Detection | no |

a. Actual data type or capability support depends on block implementation.

Extended Capabilities

C/C++ Code Generation

Generate C and C++ code using Simulink® Coder™.

Actual data type or capability support depends on block implementation.

Fixed-Point Conversion

Design and simulate fixed-point systems using Fixed-Point Designer™.

See Also

Blocks

Action Port | If | Subsystem

Topics

Select Subsystem Execution

Introduced before R2006a

In Bus Element, Bus Element In

Select input from external port

Library: Simulink / Ports & Subsystems
 Simulink / Sources
 HDL Coder / Ports & Subsystems
 HDL Coder / Sources

InBus.signal1 

Description

The In Bus Element block, also known as the Bus Element In block, combines the functionality of an Inport block and a Bus Selector block. This block is of the Inport block type and all In Bus Element blocks that use the same port share a Block Parameters dialog box.

You can use an In Bus Element block to select a bus element, bus, nonbus signal, or message associated with the port. To select multiple elements from a bus, use multiple In Bus Element blocks.

Create Port and Related Blocks

When you insert an In Bus Element block, the block label populates with default values. The label consists of two interactive text fields: the port name and the bus element. To change the name of the port associated with the block, edit the first text field in the label by clicking in it.

InBus. signal1 

To create related In Bus Element blocks, in the Block Parameters dialog box, you can select the **Add blocks for selected signals**  button.

If multiple blocks are associated with the same port and you change the name of the port, all blocks that share the port update to reflect the new port name.

You can create additional ports by holding **Ctrl** while you drag an existing In Bus Element block to a new location. Upon releasing the mouse, you have the option to create a port or use the existing port associated with the block being copied.

Examine Port Input

You can view the elements associated with a port in the Block Parameters dialog box for any of the related In Bus Element blocks.

▼ InBus

a

b

c

d

Black element names are already associated with an In Bus Element block. Grey element names are available, but are not being used. Red element names are not available in the input bus, despite being specified by an In Bus Element block.

You can create In Bus Element blocks for each selected element by clicking the **Add blocks for selected signals** button .

To remove blocks associated with selected elements, such as elements which are unavailable in the input bus, click the **Remove blocks of selected signals** button .

Select Element

To change the bus element associated with the block, edit the second text field in the label by clicking in it.



If a bus is connected to the port, you can select an element of the bus from the list that appears. To see all elements of the bus along with the previously specified element name, clear the text. The list of elements is filtered to include only the elements that contain the existing text.

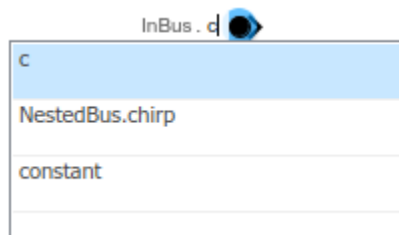

Each dot in the part of the label that describes the bus element indicates a new level of bus hierarchy. To reduce the size of the label, you can display only the element name by selecting the block, pausing over the ellipsis, and selecting **Compact Notation** from the action bar. To show the bus hierarchy again, select **Expanded Notation** from the action bar.



You can pass through the entire input connected to the port, including nonbus signals, by deleting the text from the second text field.



Referenced models support passing through an entire bus with an In Bus Element block in either of these scenarios:

- The bus is defined by a `Simulink.Bus` object.
- Additional In Bus Element blocks pass each leaf element of the bus into the referenced model.

You can select an In Bus Element block that has duplicates to highlight the duplicate blocks. To show a related block in an open diagram or new tab, pause on the ellipsis that appears after selection.

Then, select **Related Blocks**  from the action bar. When multiple blocks correspond to the selected block, a list of related blocks opens. You can filter the list of related blocks by entering a search term in the text box. After you select a related block from the list, window focus goes to the open diagram or new tab that shows the related block.

Load Input Data

You can use an In Bus Element block to load external input data for a bus. An In Bus Element block can load data for an element of a bus or for an entire bus. When you use an In Bus Element block to load data for an entire bus, you must specify the data type for the block using a `Simulink.Bus` object. For more information about loading input data for bus elements, see “Load Input Data for a Bus Using In Bus Element Blocks”.

You can load simulation input data for a group of root-level In Bus Element blocks by using a structure of `timeseries`, `timetable`, or `SimulationDatastore` objects. In Bus Element blocks interpolate loaded data for all data types except `string`, `enumerated`, and `fixed point`.

Ports

Output

Port_1 — Selected input from external port

signal | message

Selected input that is associated with an external subsystem or model port.

While you can select bus elements, you cannot select elements of arrays of buses.

Data Types: `single` | `double` | `half` | `int8` | `int16` | `int32` | `int64` | `uint8` | `uint16` | `uint32` | `uint64` | `string` | `Boolean` | `fixed point` | `enumerated` | `bus`

Parameters

Port name — Name of input port

InBus (default) | port name

Specify a port name that is not already in use by another block or port. The name appears on the parent Subsystem or Model block. The name also appears next to the block. Multiple blocks can access the same port.

Programmatic Use

Block Parameter: PortName

Type: character vector

Values: 'InBus' | '<port name>'

Default: 'InBus '

Port number — Position of port on parent block

1 (default) | real integer

Specify the order in which the port that corresponds to the block appears on the parent Subsystem or Model block.

- If you add a block that creates another port, the port number is the next available number.
- Deleting all blocks associated with a port deletes the port. Other ports are renumbered so that they are sequential and do not skip any numbers.
- Specifying a port number that exceeds the number of ports creates a port for that number and for any skipped sequential numbers.

Programmatic Use

Block Parameter: Port

Type: character vector

Values: real integer

Default: '1'

Set color — Specify block background color

Black (default) | White | Red | Green | Blue | Cyan | Magenta | Yellow | Gray | Light Blue | Orange | Dark Green | More Colors

Specify the block background color. This specification sets the color of blocks associated with selected bus elements, or of all blocks associated with the port if you do not select any bus elements.

Programmatic Use

Block Parameter: BackgroundColor

Type: character vector

Values: 'black' | 'white' | 'red' | 'green' | 'blue' | 'cyan' | 'magenta' | 'yellow' | 'gray' | 'lightBlue' | 'orange' | 'darkGreen' | '[r,g,b]' where r, g, and b, are the red, green, blue values of the color in the range 0.0 to 1.0

Default: 'black'

Filter — Filter set of displayed signals

text

Specify a search term to use for filtering a long list of bus elements. Do not enclose the search term in quotation marks. The filter does a partial string search and supports regular expressions. To use a regular expression character as a literal, include an escape character (\). For example, to use a question mark, type sig\?1.

Attributes

To specify attributes, click the pencil button or nondefault attribute summary next to the name of a bus or bus element.

Data type — Data type

Inherit: auto (default) | double | single | half | int8 | uint8 | int16 | uint16 | ...

The data type can be inherited, specified directly, or expressed as a data type object such as a Simulink.NumericType object.

You can specify any of these options:

- Inherited data type
- Built-in Simulink data type — For example, specify `single` or `uint8`. See “Data Types Supported by Simulink”.
- Fixed-point data type — Use the `fixdt` function. For example, specify `fixdt(1,16,0)`.
- Enumerated data type — Use the name of the type preceded by `Enum:`. For example, specify `Enum: myEnumType`.
- Bus data type — Use the name of the `Simulink.Bus` object preceded by `Bus:`. For example, specify `Bus: myBusObject`.
- Value type — Use the name of the `Simulink.ValueType` object preceded by `ValueType:`. For example, specify `ValueType: windVelocity`.
- Custom data type — Use a MATLAB expression that specifies the type. For example, you can specify a `Simulink.NumericType` object whose `DataTypeMode` property is set to a value other than `'Fixed-point: unspecified scaling'`.

When you specify a `Simulink.ValueType` or `Simulink.Bus` object, the object defines more than the data type. The object also defines properties such as **Min**, **Max**, and **Unit**. The property values specified by the `ValueType` object override the corresponding property values specified by a block. For example, suppose a block sets **Unit** to `ft/s`. When the **Data type** of the block specifies a `ValueType` object that has `m/s` as its unit, the block uses `m/s` instead of `ft/s`.

Programmatic Use

Block Parameter: `OutDataTypeStr`

Type: character vector

Values: `'Inherit: auto' | 'double' | 'single' | 'half' | 'int8' | 'uint8' | 'int16' | 'uint16' | 'int32' | 'uint32' | 'int64' | 'uint64' | 'boolean' | 'fixdt(1,16)' | 'fixdt(1,16,0)' | 'fixdt(1,16,2^0,0)' | 'string' | 'Enum: <class name>' | 'Bus: <object name>' | 'ValueType: <object name>' | '<data type expression>'`

Default: `'Inherit: auto'`

Data mode — Data mode of bus elements

`inherit (default) | signal | message`

Specify the data mode of the elements of the bus.

- `inherit` — Bus elements inherit their data modes.
- `signal` — Bus elements must be signals.
- `message` — Bus elements must be messages.

For the In Bus Element block, if you choose `message` as the data mode, an envelope button appears next to the bus or bus element. Use the envelope button to specify custom queue properties for each message element. The Out Bus Element block does not support queue specifications.

Dependencies

To enable this parameter, the block must be at the top level of a model.

Programmatic Use

Block Parameter: `DataMode`

Type: character vector

Values: `'inherit' | 'signal' | 'message'`

Default: 'inherit'

Bus virtuality — Virtual or nonvirtual bus

inherit (default) | virtual | nonvirtual

Specify whether to inherit the bus virtuality or define the bus as virtual or nonvirtual. For more information, see “Types of Composite Signals”.

This parameter determines whether the blocks inherit or define the bus virtuality. If the blocks define the bus virtuality and the virtuality of the input bus does not match, compiling the model produces an error.

Dependencies

To enable this parameter, set **Data type** to a Bus object.

Programmatic Use

Block Parameter: BusVirtuality

Type: character vector

Values: 'inherit' | 'virtual' | 'nonvirtual'

Default: 'inherit'

Dimensions — Signal dimensions

-1 (default) | integer | [integer, integer]

Specify the dimensions of a signal.

- -1 — The signal can have any dimensions.
- N — The signal must be a vector of size N.
- [R C] — The signal must be a matrix having R rows and C columns.

Programmatic Use

Block Parameter: PortDimensions

Type: character vector

Values: '-1' | integer | [integer, integer]

Default: '-1'

Dims mode — Option to allow only variable-size or fixed-size signals

Inherit (default) | Fixed | Variable

Specify the type of signals allowed.

- Inherit — Allow variable-size and fixed-size signals.
- Variable — Allow only variable-size signals.
- Fixed — Allow only fixed-size signals. Do not allow variable-size signals.

When the signal is variable-sized, the **Dimensions** parameter specifies the maximum dimensions of the signal.

Programmatic Use

Parameter: VarSizeSig

Type: character vector

Value: 'Inherit' | 'No' | 'Yes'

Default: 'Inherit'

Unit – Physical unit`inherit (default) | <Enter unit>`

Specify the physical unit of the signal. For a list of supported units, see Allowed Unit Systems.

Programmatic Use**Block Parameter:** Unit**Type:** character vector**Values:** 'inherit' | '<Enter unit>'**Default:** 'inherit'**Sample time – Sample time**`-1 (default) | scalar`

Specify the discrete interval between sample time hits or specify another appropriate sample time such as continuous or inherited.

By default, the signal inherits its sample time. To set a different sample time, enter a valid sample time based on the table in “Types of Sample Time”.

Programmatic Use**Block Parameter:** SampleTime**Type:** character vector**Values:** scalar**Default:** '-1'**Complexity – Numeric type**`auto (default) | real | complex`

Specify the numeric type of the signal. To choose the numeric type of the signal, select `auto`. Otherwise, choose a real or complex signal type.

Programmatic Use**Block Parameter:** SignalType**Type:** character vector**Values:** 'auto' | 'real' | 'complex'**Default:** 'auto'**Minimum – Minimum value**`[] (default) | scalar`

Lower value of the range that Simulink checks.

This number must be a finite real double scalar value.

Simulink software uses this value to perform:

- Simulation range checking (see “Specify Signal Ranges”).
- Automatic scaling of fixed-point data types.
- Optimization of the code that you generate from the model. This optimization can remove algorithmic code and affect the results of some simulation modes such as SIL or external mode. For more information, see “Optimize using the specified minimum and maximum values” (Embedded Coder).

Programmatic Use**Block Parameter:** OutMin**Type:** character vector**Values:** ' [] ' | scalar**Default:** ' [] '**Maximum — Maximum value**

[] (default) | scalar

Upper value of the range that Simulink checks.

This number must be a finite real double scalar value.

Simulink software uses this value to perform:

- Simulation range checking (see “Specify Signal Ranges”).
- Automatic scaling of fixed-point data types.
- Optimization of the code that you generate from the model. This optimization can remove algorithmic code and affect the results of some simulation modes such as SIL or external mode. For more information, see “Optimize using the specified minimum and maximum values” (Embedded Coder).

Programmatic Use**Block Parameter:** OutMax**Type:** character vector**Values:** ' [] ' | scalar**Default:** ' [] '**Description — Description of bus or bus elements**

no default

Use the description to document information about the bus or bus element, such as where it is used. This information does not affect Simulink processing.

Programmatic Use**Block Parameter:** Description**Type:** character vector**Values:** ' ' | '<Enter text>'**Default:** ' '**Queue Attributes**

Queue attributes are visible only when the block must be at the top level of a model and you set the **Data mode** parameter to message.

To specify attributes, click the envelope button next to the name of a bus or bus element.

Use default queue attributes — Default or custom queue specifications

on (default) | off

Use this parameter to select between default or custom queue specifications.

To use the default queue properties, leave the parameter selected. In this case, for each message bus element, a LIFO overwriting queue of capacity 1 is automatically inserted.

To use custom specifications, clear the parameter and configure the queue properties. Queue attributes are applicable if there is no storage block placed outside a component.

For more information, see “Specify Queue Properties for Message Interface”.

Dependencies

To enable this parameter, set the **Data mode** parameter to `message`.

Programmatic Use

Block Parameter: `MessageQueueUseDefaultAttributes`

Type: character vector

Values: 'on' | 'off'

Default: 'on'

Queue capacity — Message storage capacity

1 (default) | scalar

Specify the number of messages elements the queue can store.

Dependencies

This parameter is visible when you set the **Data mode** parameter to `message`.

Programmatic Use

Block Parameter: `MessageQueueCapacity`

Type: character vector

Values: '1' | scalar

Default: '1'

Queue type — Choose FIFO or LIFO queue

LIFO (default) | FIFO

Choose one of these queue types:

- FIFO — First-in-first-out
- LIFO — Last-in-first-out

Dependencies

This parameter is visible when you set the **Data mode** parameter to `message`.

Programmatic Use

Block Parameter: `MessageQueueType`

Type: character vector

Values: 'FIFO' | 'LIFO'

Default: 'LIFO'

Queue overwriting — Queue message overwriting policy

on (default) | off

Select this parameter to choose between two queue overwriting policies.

- If you select the parameter, an incoming message element overwrites the oldest message if the queue is full.
- If you clear the parameter, the block does not accept new messages if the queue is full.

Dependencies

To enable this parameter, set the **Data mode** parameter to message.

Programmatic Use

Block Parameter: MessageQueueOverwriting

Type: character vector

Values: 'on' | 'off'

Default: 'on'

Block Characteristics

| | |
|---------------------------------|--|
| Data Types | Boolean bus double enumerated fixed point half integer single string |
| Direct Feedthrough | no |
| Multidimensional Signals | yes |
| Variable-Size Signals | yes |
| Zero-Crossing Detection | no |

Extended Capabilities

C/C++ Code Generation

Generate C and C++ code using Simulink® Coder™.

HDL Code Generation

Generate Verilog and VHDL code for FPGA and ASIC designs using HDL Coder™.

This block can be used to simplify the Subsystem bus interfaces when you use the block in subsystems that generate HDL code, but is not included in the hardware implementation.

To learn more about using buses for HDL code generation, see “Buses” (HDL Coder) and “Use Bus Signals to Improve Readability of Model and Generate HDL Code” (HDL Coder).

Fixed-Point Conversion

Design and simulate fixed-point systems using Fixed-Point Designer™.

See Also

Blocks

Out Bus Element | Inport | Bus Selector

Topics

“Simplify Subsystem and Model Interfaces with Buses”

“Types of Composite Signals”

“Group Signal Lines into Virtual Buses”

Introduced in R2017a

Increment Real World

Increase real-world value of signal by one

Library: Simulink / Additional Math & Discrete / Additional Math:
Increment - Decrement
HDL Coder / Math Operations



Description

The Increment Real World block increases the real-world value of the signal by one.

Overflows always wrap.

Ports

Input

Port_1 – Input signal

scalar | vector | matrix

Input signal, specified as a scalar, vector, or matrix.

Data Types: single | double | int8 | int16 | int32 | int64 | uint8 | uint16 | uint32 | uint64 | fixed point

Output

Port_1 – Output signal

scalar | vector | matrix

Output is the real-world value of the input signal increased by one. Overflows always wrap. The output has the same data type and dimensions as the input.

Data Types: single | double | int8 | int16 | int32 | int64 | uint8 | uint16 | uint32 | uint64 | fixed point

Block Characteristics

| | |
|---------------------------------|---|
| Data Types | double fixed point integer single |
| Direct Feedthrough | no |
| Multidimensional Signals | no |
| Variable-Size Signals | yes |

| | |
|--------------------------------|----|
| Zero-Crossing Detection | no |
|--------------------------------|----|

Extended Capabilities

C/C++ Code Generation

Generate C and C++ code using Simulink® Coder™.

The code generator does not explicitly group primitive blocks that constitute a nonatomic masked subsystem block in the generated code. This flexibility allows for more efficient code generation. In certain cases, you can achieve grouping by configuring the masked subsystem block to execute as an atomic unit by selecting the **Treat as atomic unit** option.

HDL Code Generation

Generate Verilog and VHDL code for FPGA and ASIC designs using HDL Coder™.

HDL Coder provides additional configuration options that affect HDL implementation and synthesized logic.

HDL Architecture

This block has a single, default HDL architecture.

HDL Block Properties

| | |
|----------------------------------|--|
| ConstrainedOutputPipeline | Number of registers to place at the outputs by moving existing delays within your design. Distributed pipelining does not redistribute these registers. The default is 0. For more details, see “ConstrainedOutputPipeline” (HDL Coder). |
| InputPipeline | Number of input pipeline stages to insert in the generated code. Distributed pipelining and constrained output pipelining can move these registers. The default is 0. For more details, see “InputPipeline” (HDL Coder). |
| OutputPipeline | Number of output pipeline stages to insert in the generated code. Distributed pipelining and constrained output pipelining can move these registers. The default is 0. For more details, see “OutputPipeline” (HDL Coder). |

Fixed-Point Conversion

Design and simulate fixed-point systems using Fixed-Point Designer™.

See Also

Decrement Stored Integer | Decrement Time To Zero | Decrement To Zero | Increment Real World

Topics

“Fixed-Point Numbers”

Introduced before R2006a

Increment Stored Integer

Increase stored integer value of signal by one

Library: Simulink / Additional Math & Discrete / Additional Math:
Increment - Decrement
HDL Coder / Math Operations



Description

The Increment Stored Integer block increases the stored integer value of a signal by one.

Floating-point signals also increase by one, and overflows always wrap.

Ports

Input

Port_1 – Input signal

scalar | vector | matrix

Input signal, specified as a scalar, vector, or matrix.

Data Types: single | double | int8 | int16 | int32 | int64 | uint8 | uint16 | uint32 | uint64 | fixed point

Output

Port_1 – Output signal

scalar | vector | matrix

Output is the stored integer value of the input signal increased by one. Floating-point signals also increase by one, and overflows always wrap. The output has the same data type and dimensions as the input.

Data Types: single | double | int8 | int16 | int32 | int64 | uint8 | uint16 | uint32 | uint64 | fixed point

Block Characteristics

| | |
|---------------------------------|---|
| Data Types | double fixed point integer single |
| Direct Feedthrough | yes |
| Multidimensional Signals | yes |
| Variable-Size Signals | yes |

| | |
|--------------------------------|----|
| Zero-Crossing Detection | no |
|--------------------------------|----|

Extended Capabilities

C/C++ Code Generation

Generate C and C++ code using Simulink® Coder™.

The code generator does not explicitly group primitive blocks that constitute a nonatomic masked subsystem block in the generated code. This flexibility allows for more efficient code generation. In certain cases, you can achieve grouping by configuring the masked subsystem block to execute as an atomic unit by selecting the **Treat as atomic unit** option.

HDL Code Generation

Generate Verilog and VHDL code for FPGA and ASIC designs using HDL Coder™.

HDL Coder provides additional configuration options that affect HDL implementation and synthesized logic.

HDL Architecture

This block has a single, default HDL architecture.

HDL Block Properties

| | |
|----------------------------------|--|
| ConstrainedOutputPipeline | Number of registers to place at the outputs by moving existing delays within your design. Distributed pipelining does not redistribute these registers. The default is 0. For more details, see “ConstrainedOutputPipeline” (HDL Coder). |
| InputPipeline | Number of input pipeline stages to insert in the generated code. Distributed pipelining and constrained output pipelining can move these registers. The default is 0. For more details, see “InputPipeline” (HDL Coder). |
| OutputPipeline | Number of output pipeline stages to insert in the generated code. Distributed pipelining and constrained output pipelining can move these registers. The default is 0. For more details, see “OutputPipeline” (HDL Coder). |

Fixed-Point Conversion

Design and simulate fixed-point systems using Fixed-Point Designer™.

See Also

Decrement Stored Integer | Increment Real World

Topics

“Fixed-Point Numbers”

Introduced before R2006a

Index Vector

Switch output between different inputs based on value of first input

Library: Simulink / Signal Routing
HDL Coder / Signal Routing

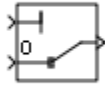

Description

The Index Vector block is a special configuration of the Multiport Switch block in which you specify one data input and the control input is zero-based. The block output is the element of the input vector whose index matches the control input. For example, if the input vector is [18 15 17 10] and the control input is 3, the element that matches the index of 3 (zero-based) is 10, and that becomes the output value.

To configure a Multiport Switch block to work as an Index Vector block set **Number of data ports** to 1 and **Data port order** to Zero-based contiguous.

For more information about the Multiport Switch block, see the Multiport Switch block reference page.

Ports

Input

Port_1 — Control signal

scalar

Control signal, specified as a scalar. When the control input is not an integer value, the block truncates the value to an integer by rounding to zero.

For information on control signals of enumerated type, see “Guidelines on Setting Parameters for Enumerated Control Port” on page 1-1139 on the Multiport Switch block ref page.

Limitations

- If the control signal is numeric, the control signal cannot be complex.
- If the control signal is an enumerated signal, the block uses the value of the underlying integer to select a data port.
- If the underlying integer does not correspond to a data input, an error occurs.

Data Types: single | double | half | int8 | int16 | int32 | int64 | uint8 | uint16 | uint32 | uint64 | Boolean | fixed point

0 or 1 — First data input

scalar | vector

First data input, specified as a scalar or vector. The port is labeled **0** when you set **Data port order** to **Zero-based contiguous**, and labeled **1** when you set **Data port order** to **One-based contiguous**.

Data Types: `single` | `double` | `half` | `int8` | `int16` | `int32` | `int64` | `uint8` | `uint16` | `uint32` | `uint64` | `Boolean` | `fixed point` | `bus` | `enumerated` | `string`

Output

Port_1 — Selected data input, based on control signal value

scalar

The block outputs the selected value from the input data vector, according to the control signal value. The output is a scalar.

Data Types: `single` | `double` | `half` | `int8` | `int16` | `int32` | `int64` | `uint8` | `uint16` | `uint32` | `uint64` | `Boolean` | `fixed point` | `enumerated` | `bus`

Parameters

Main

Data port order — Type of ordering for data input ports

`Zero-based contiguous` (default) | `One-based contiguous` | `Specify indices`

Specify the type of ordering for your data input ports.

- **Zero-based contiguous** — Block uses zero-based indexing for ordering contiguous data ports. This is the default value of the Index Vector block.
- **One-based contiguous** — Block uses one-based indexing for ordering contiguous data ports. This is the default value of the Multiport Switch block.
- **Specify indices** — Block uses noncontiguous indexing for ordering data ports. This value is supported only for configurations with two or more input data ports.

Tips

- When the control port is of enumerated type, select `Specify indices`.
- If you select `Zero-based contiguous` or `One-based contiguous`, verify that the control port is not of enumerated type. This configuration is deprecated and produces an error. You can run the Upgrade Advisor on your model to replace each Multiport Switch block of this configuration with a block that explicitly specifies data port indices. See “Model Upgrades”.
- Avoid situations where the block contains unused data ports for simulation or code generation. When the control port is of fixed-point or built-in data type, verify that all data port indices are representable with that type. Otherwise, the following block behavior occurs:

| If the block has unused data ports and data port order is: | The block produces: |
|---|---------------------|
| <code>Zero-based contiguous</code> or <code>One-based contiguous</code> | A warning |
| <code>Specify indices</code> | An error |

Dependencies

Selecting Zero-based contiguous or One-based contiguous enables the **Number of data ports** parameter.

Selecting Specify indices enables the **Data port indices** parameter.

Programmatic Use

Block Parameter: DataPortOrder

Type: character vector

Values: 'Zero-based contiguous' | 'One-based contiguous' | 'Specify indices'

Default: 'Zero-based contiguous'

Number of data ports — Number of data input ports

1 (default) | integer between 1 and 65536

Specify the number of data input ports to the block.

Dependencies

To enable this parameter, set **Data port order** to Zero-based contiguous or One-based contiguous.

Programmatic Use

Block Parameter: Inputs

Type: character vector

Values: integer between 1 and 65536

Default: '1'

Signal Attributes**Require all data port inputs to have the same data type — Require all inputs to have the same data type**

off (default) | on

Select this check box to require that all data input ports have the same data type. When you clear this check box, the block allows data port inputs to have different data types.

Programmatic Use

Block Parameter: InputSameDT

Type: character vector

Values: 'off' | 'on'

Default: 'off'

Output minimum — Minimum output value for range checking

[] (default) | scalar

Lower value of the output range that Simulink checks.

Simulink uses the minimum to perform:

- Parameter range checking (see “Specify Minimum and Maximum Values for Block Parameters”) for some blocks.
- Simulation range checking (see “Specify Signal Ranges” and “Enable Simulation Range Checking”).

- Automatic scaling of fixed-point data types.
- Optimization of the code that you generate from the model. This optimization can remove algorithmic code and affect the results of some simulation modes such as SIL or external mode. For more information, see “Optimize using the specified minimum and maximum values” (Embedded Coder).

Note Output minimum does not saturate or clip the actual output signal. Use the Saturation block instead.

Programmatic Use

Block Parameter: OutMin

Type: character vector

Values: '[]' | scalar

Default: '[]'

Output maximum — Maximum output value for range checking

[] (default) | scalar

Upper value of the output range that Simulink checks.

Simulink uses the maximum value to perform:

- Parameter range checking (see “Specify Minimum and Maximum Values for Block Parameters”) for some blocks.
- Simulation range checking (see “Specify Signal Ranges” and “Enable Simulation Range Checking”).
- Automatic scaling of fixed-point data types.
- Optimization of the code that you generate from the model. This optimization can remove algorithmic code and affect the results of some simulation modes such as SIL or external mode. For more information, see “Optimize using the specified minimum and maximum values” (Embedded Coder).

Note Output maximum does not saturate or clip the actual output signal. Use the Saturation block instead.

Programmatic Use

Block Parameter: OutMax

Type: character vector

Values: '[]' | scalar

Default: '[]'

Output data type — Specify the output data type

Inherit: Inherit via internal rule (default) | Inherit: Inherit via back propagation | Inherit: Same as first data input | double | single | half | int8 | uint8 | int16 | uint16 | int32 | uint32 | int64 | uint64 | fixdt(1,16) | fixdt(1,16,0) | fixdt(1,16,2^0,0) | string | <data type expression>

Choose the data type for the output. The type can be inherited, specified directly, or expressed as a data type object such as Simulink.NumericType.

When you select an inherited option, the block behaves as follows:

- **Inherit: Inherit via internal rule**—Simulink chooses a data type to balance numerical accuracy, performance, and generated code size, while taking into account the properties of the embedded target hardware. If you change the embedded target settings, the data type selected by the internal rule might change. It is not always possible for the software to optimize code efficiency and numerical accuracy at the same time. If the internal rule doesn't meet your specific needs for numerical accuracy or performance, use one of the following options:
 - Specify the output data type explicitly.
 - Explicitly specify a default data type such as `fixdt(1,32,16)` and then use the Fixed-Point Tool to propose data types for your model. For more information, see `fxptdlg`.
 - To specify your own inheritance rule, use **Inherit: Inherit via back propagation** and then use a Data Type Propagation block. Examples of how to use this block are available in the Signal Attributes library Data Type Propagation Examples block.
- **Inherit: Inherit via back propagation** — Uses the data type of the driving block.
- **Inherit: Same as first data input** — Uses the data type of the first data input port.

Programmatic Use

Block Parameter: `OutDataTypeStr`

Type: character vector

Values: `'Inherit: Inherit via internal rule'|'Inherit: Inherit via back propagation'|'Inherit: Same as first input'|'double'|'single'|'half'|'int8'|'uint8'|'int16'|'uint16'|'int32'|'uint32'|'int64'|'uint64'|'fixdt(1,16)'|'fixdt(1,16,0)'|'fixdt(1,16,2^0,0)'|'string'|'<data type expression>'`

Default: `'Inherit: Inherit via internal rule'`

Lock output data type setting against changes by the fixed-point tools — Prevent fixed-point tools from overriding data types

`off (default) | on`

Select to lock the output data type setting of this block against changes by the Fixed-Point Tool and the Fixed-Point Advisor. For more information, see “Use Lock Output Data Type Setting” (Fixed-Point Designer).

Programmatic Use

Block Parameter: `LockScale`

Type: character vector

Values: `'off' | 'on'`

Default: `'off'`

Integer rounding mode — Specify the rounding mode for fixed-point operations

`Floor (default) | Ceiling | Convergent | Nearest | Round | Simplest | Zero`

Choose one of these rounding modes.

Ceiling

Rounds both positive and negative numbers toward positive infinity. Equivalent to the MATLAB `ceil` function.

Convergent

Rounds number to the nearest representable value. If a tie occurs, rounds to the nearest even integer. Equivalent to the Fixed-Point Designer `convergent` function.

Floor

Rounds both positive and negative numbers toward negative infinity. Equivalent to the MATLAB `floor` function.

Nearest

Rounds number to the nearest representable value. If a tie occurs, rounds toward positive infinity. Equivalent to the Fixed-Point Designer `nearest` function.

Round

Rounds number to the nearest representable value. If a tie occurs, rounds positive numbers toward positive infinity and rounds negative numbers toward negative infinity. Equivalent to the Fixed-Point Designer `round` function.

Simplest

Automatically chooses between round toward floor and round toward zero to generate rounding code that is as efficient as possible.

Zero

Rounds number toward zero. Equivalent to the MATLAB `fix` function.

Programmatic Use

Block Parameter: `RndMeth`

Type: character vector

Values: 'Ceiling' | 'Convergent' | 'Floor' | 'Nearest' | 'Round' | 'Simplest' | 'Zero'

Default: 'Floor'

See Also

For more information, see “Rounding” (Fixed-Point Designer).

Saturate on integer overflow – Method of overflow action

`off` (default) | `on`

Specify whether overflows saturate or wrap.

- `off` — Overflows wrap to the appropriate value that the data type can represent.

For example, the number 130 does not fit in a signed 8-bit integer and wraps to -126.

- `on` — Overflows saturate to either the minimum or maximum value that the data type can represent.

For example, an overflow associated with a signed 8-bit integer can saturate to -128 or 127.

Tip

- Consider selecting this check box when your model has a possible overflow and you want explicit saturation protection in the generated code.
- Consider clearing this check box when you want to optimize efficiency of your generated code.

Clearing this check box also helps you to avoid overspecifying how a block handles out-of-range signals. For more information, see “Troubleshoot Signal Range Errors”.

- When you select this check box, saturation applies to every internal operation on the block, not just the output or result.

- In general, the code generation process can detect when overflow is not possible. In this case, the code generator does not produce saturation code.

Programmatic Use

Block Parameter: SaturateOnIntegerOverflow

Type: character vector

Values: 'off' | 'on'

Default: 'off'

Allow different data input sizes (Results in variable-size output signal) – Allow input signals with different sizes

off (default) | on

Select this check box to allow input signals with different sizes.

- On — Allows input signals with different sizes, and propagate the input signal size to the output signal. In this mode, the block produces a variable-size output signal.
- Off — Requires that all nonscalar data input signals be the same size.

Programmatic Use

Parameter: AllowDiffInputSizes

Type: character vector

Value: 'on' | 'off'

Default: 'off'

Block Characteristics

| | |
|---------------------------------|---|
| Data Types | Boolean bus double enumerated fixed point half integer single |
| Direct Feedthrough | yes |
| Multidimensional Signals | yes |
| Variable-Size Signals | yes |
| Zero-Crossing Detection | no |

Extended Capabilities

C/C++ Code Generation

Generate C and C++ code using Simulink® Coder™.

HDL Code Generation

Generate Verilog and VHDL code for FPGA and ASIC designs using HDL Coder™.

HDL Coder provides additional configuration options that affect HDL implementation and synthesized logic.

The Index Vector block is a Multiport Switch block with **Number of data ports** set to 1. For HDL code generation information, see Multiport Switch.

PLC Code Generation

Generate Structured Text code using Simulink® PLC Coder™.

Fixed-Point Conversion

Design and simulate fixed-point systems using Fixed-Point Designer™.

See Also

Multiport Switch | Switch

Topics

“Variable-Size Signal Basics”

Introduced before R2006a

Initialize Function

Execute subsystem on model initialize event

Library: Simulink / User-Defined Functions

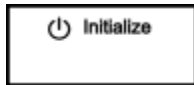

Description

The Initialize Function block is a pre-configured Subsystem block that executes on a model initialize event. By default, the Initialize Function block includes an Event Listener block with **Event** set to Initialize, a Constant block with **Constant value** set to 0, and a State Writer block.

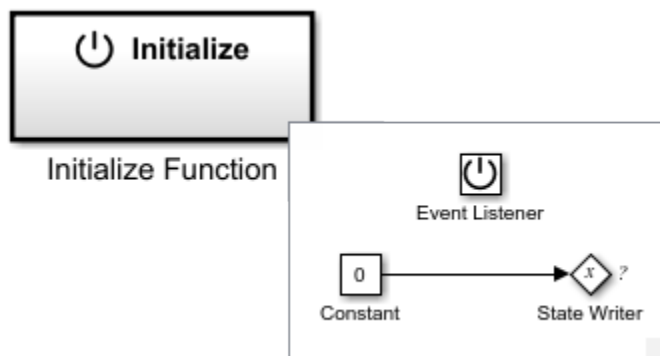

Replace the Constant block with blocks that generate the state value for the State Writer block.

Conditionally executed subsystem blocks with output ports are fully supported within Initialize Function blocks.

For a list of unsupported blocks and features, see “Initialize, Reset, and Terminate Function Limitations”.

The input and output ports of a component containing Initialize Function and Terminate Function blocks must connect to input and output port blocks.

The code generated from this block is part of the `model_initialize` function that is called once at the beginning of model execution.

You can select an Initialize Function, Reset Function, or Terminate Function block or a corresponding state owner block to highlight blocks related to it. To show a related block in an open diagram or new tab, pause on the ellipsis that appears after selection. Then, select **Related Blocks**  from the action bar. When multiple blocks correspond to the selected block, a list of related blocks opens. You can filter the list of related blocks by entering a search term in the text box. After you select a related block from the list, window focus goes to the open diagram or new tab that shows the related block.

Block Characteristics

| | |
|---------------------------------|---|
| Data Types | Boolean ^a bus ^a double ^a enumerated ^a fixed point ^a half ^a integer ^a single ^a string ^a |
| Direct Feedthrough | no |
| Multidimensional Signals | limited ^a |
| Variable-Size Signals | no |
| Zero-Crossing Detection | no |

a. Actual data type or capability support depends on block implementation.

Extended Capabilities

C/C++ Code Generation

Generate C and C++ code using Simulink® Coder™.

Actual code generation support depends on block implementation.

Fixed-Point Conversion

Design and simulate fixed-point systems using Fixed-Point Designer™.

Actual data type support depends on block implementation.

See Also

Reset Function | Terminate Function | Event Listener | State Reader | State Writer

Topics

“Using Initialize, Reset, and Terminate Functions”

“Create Test Harness to Generate Function Calls”

“Generate Code That Responds to Initialize, Reset, and Terminate Events” (Simulink Coder)

Inport

Create input port for subsystem or external input

Library: Simulink / Commonly Used Blocks
 Simulink / Ports & Subsystems
 Simulink / Sources
 HDL Coder / Commonly Used Blocks
 HDL Coder / Ports & Subsystems
 HDL Coder / Sources



Description

Inport blocks link signals from outside a system into the system.

Simulink software assigns Inport block port numbers according to these rules:

- It automatically numbers the Inport blocks within a top-level system or subsystem sequentially, starting with 1.
- If you add an Inport block, the label is the next available number.
- If you delete an Inport block, other port numbers are automatically renumbered to ensure that the Inport blocks are in sequence and that no numbers are omitted.
- If you copy an Inport block into a system, its port number is *not* renumbered unless its current number conflicts with an inport already in the system. If the copied Inport block port number is not in sequence, renumber the block. Otherwise, you get an error message when you run the simulation or update the block diagram.

Inport Blocks in a Top-Level System

You can use an Inport block in a top-level system to:

- Supply external inputs from the workspace using one of these approaches. If no external outputs are supplied, then the default output is the ground value.
 - Use the **Configuration Parameters > Data Import/Export > Input** parameter. See “Load Data to Root-Level Input Ports”.

Tip To import many signals to root-level input ports, consider using the Root Inport Mapper tool. For more information, see “Map Data Using Root Inport Mapper Tool”.

- Use the `ut` argument of the `sim` command to specify the inputs.
- Provide a means for perturbation of the model by the `linmod` and `trim` analysis functions.
 - Use Inport blocks to inject inputs into the system. See “Linearizing Models”.
- To load logged signal data using root Inport blocks, use the `createInputDataset` function to create a `Dataset` object that contains elements corresponding to root-level Inport blocks.

Inport Blocks in a Subsystem

Inport blocks in a subsystem represent inputs to the subsystem. A signal arriving at an input port on a Subsystem block flows out of the associated Inport block in that subsystem. The Inport block associated with an input port on a Subsystem block is the block whose **Port number** parameter matches the relative position of the input port on the Subsystem block. For example, the Inport block whose **Port number** parameter is 1 gets its signal from the block connected to the topmost port on the Subsystem block.

If you renumber the **Port number** of an Inport block, the block becomes connected to a different input port. The block continues to receive its signal from the same block outside the subsystem.

Inport blocks inside a subsystem support signal label propagation, but root-level Inport blocks do not.

You can directly edit port labels on a Subsystem block. For more information, see “Edit Port Labels on Subsystems”.

Tip For models that include buses composed of many bus elements, consider using In Bus Element and Out Bus Element blocks. These blocks:

- Reduce signal line complexity and clutter in a block diagram.
- Make it easier to change the interface incrementally.
- Allow access to a bus element closer to the point of usage, avoiding the use of a Bus Selector and Goto block configuration.

The In Bus Element block is of block type Inport and the Out Bus Element block is of block type Output.

Creating Duplicate Inport Blocks

You can create any number of duplicates of an Inport block. The duplicates are graphical representations of the original intended to simplify block diagrams by eliminating unnecessary lines. The duplicate has the same port number, properties, and output as the original.

To create a duplicate of an Inport block:

- 1** In the block diagram, select the unconnected Inport block that you want to duplicate.
- 2** Press and hold the **Ctrl** key and drag the block.
- 3** Release the mouse and then select **Duplicate** from the context menu.

You can select an Inport block that has duplicates to highlight the duplicate blocks. To show a related block in an open diagram or new tab, pause on the ellipsis that appears after selection. Then, select

Related Blocks  from the action bar. When multiple blocks correspond to the selected block, a list of related blocks opens. You can filter the list of related blocks by entering a search term in the text box. After you select a related block from the list, window focus goes to the open diagram or new tab that shows the related block.

Connecting Buses to Root-Level Inport Blocks

If you want a root-level Inport block of a model to produce a bus, set the **Data type** parameter to the name of a bus object that defines the bus that the Inport block produces. For more information, see “Specify Bus Properties with Simulink.Bus Object Data Types”.

Ports

Output

Port_1 — Inport signal

scalar | vector

Input signal that flows through the inport into the system.

You can use a subsystem inport to supply fixed-point data in a structure or any other format.

Data Types: single | double | half | int8 | int16 | int32 | int64 | uint8 | uint16 | uint32 | uint64 | string | Boolean | fixed point | enumerated | bus

Parameters

Main

Port number — Position of port on parent block

1 (default) | real integer

Specify the order in which the port that corresponds to the block appears on the parent Subsystem or Model block.

- If you add a block that creates another port, the port number is the next available number.
- Deleting all blocks associated with a port deletes the port. Other ports are renumbered so that they are sequential and do not skip any numbers.
- Specifying a port number that exceeds the number of ports creates a port for that number and for any skipped sequential numbers.

Programmatic Use

Block Parameter: Port

Type: character vector

Values: real integer

Default: '1'

Icon display — Icon display

Port number (default) | Signal name | Port number and signal name

Specify the information displayed on the block icon.

Programmatic Use

Block Parameter: IconDisplay

Type: character vector

Values: 'Signal name' | 'Port number' | 'Port number and signal name'

Default: 'Port number'

Latch input by delaying outside signal – Latch signal by delay

off (default) | on

Select to specify the block outputs the value of the input signal at the previous time step.

Selecting this check box enables Simulink to resolve data dependencies among triggered subsystems that are part of a loop.

The Inport block indicates that this option is selected by displaying <Lo>.

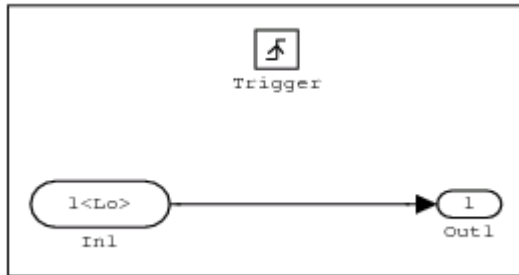

Dependency

Enabled in a triggered subsystem.

Programmatic Use

Block Parameter: LatchByDelaying OutsideSignal

Type: character vector

Values: 'on' | 'off'

Default: 'off'

Latch input for feedback signals of function-call subsystem outputs – Latch signal from changing

off (default) | on

Select to specify the block latches the value of the input to this subsystem and prevents this value from changing during the execution of the subsystem. For a single function call that is branched to invoke multiple function-call subsystems, this option breaks a loop formed by a signal fed back from one of these function-call subsystems into the other. This option prevents any change to the values of a feedback signal from a function-call subsystem that is invoked during the execution of this subsystem.

The Inport block indicates that this option is selected by displaying .

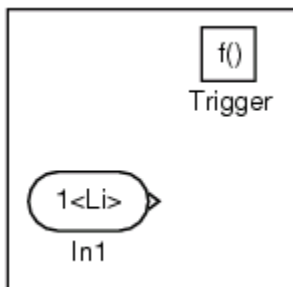

Dependency

Enabled when Inport block is in a function-call subsystem.

Programmatic Use

Block Parameter: LatchInputFor FeedbackSignals

Type: character vector

Values: 'on' | 'off'

Default: 'off'

Interpolate data — Interpolate output data

on (default) | off

When loading data from the workspace to a root-level Inport block, specify whether the block linearly interpolates and extrapolates output at time steps for which no corresponding data exists.

To load discrete signal data from the workspace, in the Inport block dialog box:

- 1 Set the **Sample time** parameter to a discrete value, such as 2.
- 2 Clear the **Interpolate data** parameter.

Specifying the discrete sample time causes the simulation to have hit times exactly at those instances when the discrete data is sampled. You specify the data values, not time values.

Turning interpolation off avoids unexpected data values at other simulation time points as a result of double precision arithmetic processing. For more information, see “Load Data to Test a Discrete Algorithm”.

Simulink uses the following interpolation and extrapolation:

- For time steps between the first specified data point and the last specified data point — zero-order hold
- For time steps before the first specified data point and after the last specified data point — ground value
- For variable-size signals for time steps before the first specified data point — a NaN is logged for single or double data types and ground for other data types. For time steps after the last specified data point, uses ground values.

Programmatic Use

Block Parameter: Interpolate

Type: character vector

Values: 'on' | 'off'

Default: 'on'

Connect Input — Tool to help map signals to inports

button

To import, visualize, and map signal and bus data to root-level inports, click this button. The Root Inport Mapper tool displays.

Dependency

This button appears only if this block is a root inport block.

Signal Attributes

Output function call — Output function-call trigger signal

off (default) | on

Specify that the input signal outputs a function-call trigger signal.

Select this option if it is necessary for a current model to accept a function-call trigger signal when referenced in the top model.

Dependency

Enabled in an asynchronous function call.

Minimum — Minimum output value

[] (default) | scalar

Lower value of the output range that Simulink checks.

This number must be a finite real double scalar value.

Note If you specify a bus object as the data type for this block, do not set the minimum value for bus data on the block. Simulink ignores this setting. Instead, set the minimum values for bus elements of the bus object specified as the data type. For information on the Minimum property of a bus element, see `Simulink.BusElement`.

Simulink software uses this value to perform:

- Simulation range checking (see “Specify Signal Ranges”).
- Automatic scaling of fixed-point data types.
- Optimization of the code that you generate from the model. This optimization can remove algorithmic code and affect the results of some simulation modes such as SIL or external mode. For more information, see “Optimize using the specified minimum and maximum values” (Embedded Coder).

Programmatic Use

Block Parameter: OutMin

Type: character vector

Values: '[]' | scalar

Default: '[]'

Maximum — Maximum output value

[] (default) | scalar

Upper value of the output range that Simulink checks.

This number must be a finite real double scalar value.

Note If you specify a bus object as the data type for this block, do not set the maximum value for bus data on the block. Simulink ignores this setting. Instead, set the maximum values for bus elements of the bus object specified as the data type. For information on the Maximum property of a bus element, see `Simulink.BusElement`.

Simulink software uses this value to perform:

- Simulation range checking (see “Specify Signal Ranges”).
- Automatic scaling of fixed-point data types.
- Optimization of the code that you generate from the model. This optimization can remove algorithmic code and affect the results of some simulation modes such as SIL or external mode. For more information, see “Optimize using the specified minimum and maximum values” (Embedded Coder).

Programmatic Use

Block Parameter: OutMax

Type: character vector

Values: ' [] ' | scalar

Default: ' [] '

Data type — Output data type

Inherit: auto (default) | double | single | half | int8 | uint8 | int16 | uint16 | ...

Specify the output data type of the external input. The type can be inherited, specified directly, or expressed as a data type object such as `Simulink.NumericType`.

Click the **Show data type assistant** button  to display the **Data Type Assistant**, which helps you set the data type attributes. For more information, see “Specify Data Types Using Data Type Assistant”.

You can specify any of these options:

- Inherited data type
- Built-in Simulink data type — For example, specify `single` or `uint8`. See “Data Types Supported by Simulink”.
- Fixed-point data type — Use the `fixdt` function. For example, specify `fixdt(1,16,0)`.
- Enumerated data type — Use the name of the type preceded by `Enum:`. For example, specify `Enum: myEnumType`.
- Bus data type — Use the name of the `Simulink.Bus` object preceded by `Bus:`. For example, specify `Bus: myBusObject`.
- Value type — Use the name of the `Simulink.ValueType` object preceded by `ValueType:`. For example, specify `ValueType: windVelocity`.
- Custom data type — Use a MATLAB expression that specifies the type. For example, you can specify a `Simulink.NumericType` object whose `DataTypeMode` property is set to a value other than 'Fixed-point: unspecified scaling'.

When you specify a `Simulink.ValueType` or `Simulink.Bus` object, the object defines more than the data type. The object also defines properties such as **Min**, **Max**, and **Unit**. The property values specified by the `ValueType` object override the corresponding property values specified by a block. For example, suppose a block sets **Unit** to ft/s. When the **Data type** of the block specifies a `ValueType` object that has m/s as its unit, the block uses m/s instead of ft/s.

Lock output data type setting against changes by the fixed-point tools — Prevent fixed-point tools from overriding data types

off (default) | on

Select to lock the output data type setting of this block against changes by the Fixed-Point Tool and the Fixed-Point Advisor. For more information, see “Use Lock Output Data Type Setting” (Fixed-Point Designer).

Programmatic Use

Block Parameter: LockScale

Type: character vector

Values: 'off' | 'on'

Default: 'off'

Output as nonvirtual bus — Specify virtual or nonvirtual bus output

off (default) | on

Specify whether the output for a top-level Inport block used to load bus data is virtual or nonvirtual.

- Select this parameter to specify a nonvirtual bus output.
- Clear this parameter to specify a virtual bus output.

Tips

- All signals in a nonvirtual bus must have the same sample time, even if the associated bus object specifies inherited sample time for some elements. Any operation that would result in a nonvirtual bus containing signals with different sample rates generates an error. You cannot load multirate data for a nonvirtual bus. See “Modify Sample Times for Nonvirtual Buses” for details on how to pass signals with different sample rates into a referenced model as a nonvirtual bus.

To load multirate data for a bus, clear the **Output as nonvirtual bus** parameter, and set the **Sample time** parameter to inherited (-1).

- For the top model in a model reference hierarchy, code generation creates a C structure to represent the nonvirtual bus output.
- For referenced models, select this option to create a C structure in generated code. Otherwise, code generation creates an argument for each leaf element of the bus.

Dependency

This parameter is only available for top-level Inport blocks with Bus: <object name> selected for the **Data type** parameter.

Programmatic Use

Block Parameter: BusOutputAsStruct

Type: character vector

Values: 'off' | 'on'

Default: 'off'

Unit (e.g., m, m/s², N*m) — Physical unit of the input signal to the block

inherit (default) | <Enter unit>

Specify the physical unit of the input signal to the block. To specify a unit, begin typing in the text box. As you type, the parameter displays potential matching units. For a list of supported units, see Allowed Unit Systems.

To constrain the unit system, click the link to the right of the parameter:

- If a Unit System Configuration block exists in the component, its dialog box opens. Use that dialog box to specify allowed and disallowed unit systems for the component.

- If a Unit System Configuration block does not exist in the component, the model Configuration Parameters dialog box displays. Use that dialog box to specify allowed and disallowed unit systems for the model.

Programmatic Use

Block Parameter: Unit

Type: character vector

Values: 'inherit' | '<Enter unit>'

Default: 'inherit'

Port dimensions (-1 for inherited) – Port dimensions

-1 (default) | integer | [integer integer]

Specify the dimensions of the output signal for this Inport block.

| | |
|-------|--|
| -1 | The port can load data for a signal with any dimensions. The port inherits dimensions from the connected signal. |
| N | The port can load data for a signal that is a vector of size N. |
| [R C] | The port can load data for a matrix signal having R rows and C columns. |

Programmatic Use

Block Parameter: PortDimensions

Type: character vector

Values: '-1' | integer | [integer integer]

Default: '-1'

Variable-size signal – Allow variable-size signals

Inherit (default) | No | Yes

Specify the type of signals allowed out of this port. To allow variable-size and fixed-size signals, select Inherit. To allow only variable-size signals, select Yes. To allow only fixed-size signals, select No.

Dependencies

When the signal at this port is a variable-size signal, the **Port dimensions** parameter specifies the maximum dimensions of the signal.

Command-Line Information

Parameter: VarSizeSig

Type: character vector

Value: 'Inherit' | 'No' | 'Yes'

Default: 'Inherit'

Sample time (-1 for inherited) – Specify sample time

-1 (default) | scalar

Specify the discrete interval between sample time hits or specify another appropriate sample time such as continuous or inherited.

By default, the block inherits its sample time based upon the context of the block within the model. To set a different sample time, enter a valid sample time based upon the table in “Types of Sample Time”.

Programmatic Use**Block Parameter:** SampleTime**Type:** character vector**Values:** scalar**Default:** '-1'**Signal type — Output signal type**

auto (default) | real | complex

Specify the numeric type of the signal output. To choose the numeric type of the signal that is connected to its input, select `auto`. Otherwise, choose a real or complex signal type.

Programmatic Use**Block Parameter:** SignalType**Type:** character vector**Values:** 'auto' | 'real' | 'complex'**Default:** 'auto'**Block Characteristics**

| | |
|---------------------------------|--|
| Data Types | Boolean bus double enumerated fixed point half integer single string |
| Direct Feedthrough | no |
| Multidimensional Signals | yes |
| Variable-Size Signals | yes |
| Zero-Crossing Detection | no |

Extended Capabilities**C/C++ Code Generation**

Generate C and C++ code using Simulink® Coder™.

HDL Code Generation

Generate Verilog and VHDL code for FPGA and ASIC designs using HDL Coder™.

HDL Coder provides additional configuration options that affect HDL implementation and synthesized logic.

HDL Architecture

This block has a single, default HDL architecture.

HDL Block Properties

| General | | |
|--------------------------|--|---|
| BidirectionalPort | BidirectionalPort Setting | Description |
| | on | <p>Specify the port as bidirectional.</p> <p>The following requirements apply:</p> <ul style="list-style-type: none"> • The port must be in a Subsystem block with black box implementation. • There must also be no logic between the bidirectional port and the corresponding top-level DUT subsystem port. <p>For more information, see “Specify Bidirectional Ports” (HDL Coder).</p> |
| | off (default) | Do not specify the port as bidirectional. |
| Target Specification | | |
| IOInterface | <p>Target platform interface type for DUT ports, specified as a character vector. The IOInterface block property is ignored for Inport and Outport blocks that are not DUT ports.</p> <p>To specify valid IOInterface settings, use the HDL Workflow Advisor:</p> <ol style="list-style-type: none"> 1 In the HDL Workflow Advisor, in the Set Target > Set Target Interface step, in the Target platform interface table, in the Target Platform Interfaces column, use the drop-down list to set the target platform interface type. 2 Save the model. <p>The IOInterface value is saved as an HDL block property of the port.</p> <p>For example, to view the IOInterface value, if the full path to your DUT port is hdlcoder_led_blinking/led_counter/LED, enter:</p> <pre>hdlget_param('hdlcoder_led_blinking/led_counter/LED', 'IOInterface')</pre> | |

| Target Specification | |
|---------------------------|---|
| IOInterfaceMapping | <p>Target platform interface port mapping for DUT ports, specified as a character vector. The <code>IOInterfaceMapping</code> block property is ignored for Inport and Outport blocks that are not DUT ports.</p> <p>To specify valid <code>IOInterfaceMapping</code> settings, use the HDL Workflow Advisor:</p> <ol style="list-style-type: none"> 1 In the HDL Workflow Advisor, in the Set Target > Set Target Interface step, in the Target platform interface table, in the Target Platform Interfaces column, use the drop-down list to set the target platform interface type. 2 In the Bit Range / Address / FPGA Pin column, if you want to change the default value, enter a target platform interface mapping. 3 Save the model. <p>The <code>IOInterfaceMapping</code> value is saved as an HDL block property of the port.</p> <p>For example, to view the <code>IOInterfaceMapping</code> value, if the full path to your DUT port is <code>hdlcoder_led_blinking/led_counter/LED</code>, enter:</p> <pre>hdlget_param('hdlcoder_led_blinking/led_counter/LED',... 'IOInterfaceMapping')</pre> |
| IOInterfaceOptions | <p>Target platform interface port mapping options for DUT ports, specified as a character vector. The <code>IOInterfaceOptions</code> block property is ignored for Inport and Outport blocks that are not DUT ports.</p> <p>To specify valid <code>IOInterfaceOptions</code> settings, use the HDL Workflow Advisor:</p> <ol style="list-style-type: none"> 1 In the HDL Workflow Advisor, on the Set Target > Set Target Interface step, in the Target platform interface table, in the Target Platform Interfaces column, map the input or output ports to an AXI4 subordinate interface. 2 In the Interface Options column, if you want to change the default initial value, click the Options button and enter a value for RegisterInitialValue. 3 Save the model. <p>The <code>IOInterfaceOptions</code> value is saved as an HDL block property of the port.</p> <p>For example, to view the <code>IOInterfaceOptions</code> value, if the full path to your DUT port is <code>hdlcoder_led_blinking/led_counter/LED</code>, enter:</p> <pre>hdlget_param('hdlcoder_led_blinking/led_counter/LED',... 'IOInterfaceOptions')</pre> |

PLC Code Generation

Generate Structured Text code using Simulink® PLC Coder™.

Fixed-Point Conversion

Design and simulate fixed-point systems using Fixed-Point Designer™.

See Also

Outport | Asynchronous Task Specification | In Bus Element

Topics

“Load Data to Root-Level Input Ports”

“Using Function-Call Subsystems”

“Map Data Using Root Inport Mapper Tool”

“Load Big Data for Simulations”

“Comparison of Signal Loading Techniques”

“Map Root Inport Signal Data”

Introduced before R2006a

Integrator

Integrate signal

Library: Simulink / Commonly Used Blocks
Simulink / Continuous



Description

The Integrator block outputs the value of the integral of its input signal with respect to time.

Simulink treats the Integrator block as a dynamic system with one state. The block dynamics are given by:

$$\begin{cases} \dot{x}(t) = u(t) \\ y(t) = x(t) \end{cases} \quad x(t_0) = x_0$$

where:

- u is the block input.
- y is the block output.
- x is the block state.
- x_0 is the initial condition of x .

While these equations define an exact relationship in continuous time, Simulink uses numerical approximation methods to evaluate them with finite precision. Simulink can use several different numerical integration methods to compute the output of the block, each with advantages in particular applications. Use the **Solver** pane of the Configuration Parameters dialog box (see “Solver Pane”) to select the technique best suited to your application.

The selected solver computes the output of the Integrator block at the current time step, using the current input value and the value of the state at the previous time step. To support this computational model, the Integrator block saves its output at the current time step for use by the solver to compute its output at the next time step. The block also provides the solver with an initial condition for use in computing the block's initial state at the beginning of a simulation. The default value of the initial condition is 0. Use the block parameter dialog box to specify another value for the initial condition or create an initial value input port on the block.

Use the parameter dialog box to:

- Define upper and lower limits on the integral
- Create an input that resets the block's output (state) to its initial value, depending on how the input changes
- Create an optional state output so that the value of the block's output can trigger a block reset

Use the Discrete-Time Integrator block to create a purely discrete system.

Defining Initial Conditions

You can define the initial conditions as a parameter on the block dialog box or input them from an external signal:

- To define the initial conditions as a block parameter, specify the **Initial condition source** parameter as `internal` and enter the value in the **Initial condition** field.
- To provide the initial conditions from an external source, specify the **Initial condition source** parameter as `external`. An additional input port appears under the block input.

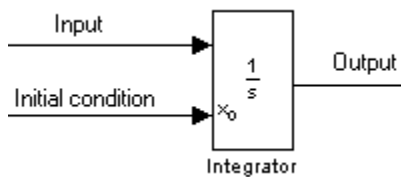

Note If the integrator limits its output (see “Limiting the Integral” on page 1-788), the initial condition must fall inside the integrator's saturation limits. If the initial condition is outside the block saturation limits, the block displays an error message.

Limiting the Integral

To prevent the output from exceeding specifiable levels, select the **Limit output** check box and enter the limits in the appropriate parameter fields. This action causes the block to function as a limited integrator. When the output reaches the limits, the integral action is turned off to prevent integral wind up. During a simulation, you can change the limits but you cannot change whether the output is limited. The block determines output as follows:

- When the integral is less than or equal to the **Lower saturation limit**, the output is held at the **Lower saturation limit**.
- When the integral is between the **Lower saturation limit** and the **Upper saturation limit**, the output is the integral.
- When the integral is greater than or equal to the **Upper saturation limit**, the output is held at the **Upper saturation limit**.

To generate a signal that indicates when the state is being limited, select the **Show saturation port** check box. A saturation port appears below the block output port.

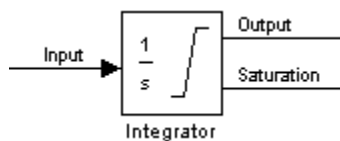

The signal has one of three values:

- 1 indicates that the upper limit is being applied.
- 0 indicates that the integral is not limited.
- -1 indicates that the lower limit is being applied.

When you select this check box, the block has three zero crossings: one to detect when it enters the upper saturation limit, one to detect when it enters the lower saturation limit, and one to detect when it leaves saturation.

Note For the Integrator Limited block, by default, **Limit output** is selected, **Upper saturation limit** is set to 1, and **Lower saturation limit** is set to 0.

Wrapping Cyclic States

Several physical phenomena are cyclic, periodic, or rotary in nature. Objects or machinery that exhibit rotational movement and oscillators are examples of such phenomena.

Modeling these phenomena in Simulink involves integrating the rate of change of the periodic or cyclic signals to obtain the state of the movement.

The drawback with this approach, however, is that over long simulation time spans, the states representing periodic or cyclic signals integrate to large values. Further, computing the sine or cosine of these signals takes an increasingly large amount of time because of angle reduction. The large signals values also negatively impact solver performance and accuracy.

One approach for overcoming this drawback is to reset the angular state to 0 when it reaches 2π (or to $-\pi$ when it reaches π , for numerical symmetry). This approach improves the accuracy of sine and cosine computations and reduces angle reduction time. But it also requires zero-crossing detection and introduces solver resets, which slow down the simulation for variable step solvers, particularly in large models.

To eliminate solver resets at wrap points, the Integrator block supports wrapped states that you can enable by checking **Wrap state** on the block parameter dialog box. When you enable **Wrap state**, the block icon changes to indicate that the block has wrapping states.

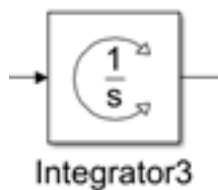

Simulink allows wrapping states that are bounded by upper and lower values parameters of the wrapped state. The algorithm for determining wrapping states is given by:

$$y = \begin{cases} x & x \in [x_l, x_u) \\ x - (x_u - x_l) \left\lfloor \frac{x - x_l}{x_u - x_l} \right\rfloor & \text{otherwise} \end{cases}$$

where:

- x_l is the lower value of the wrapped state.
- x_u is the upper value of the wrapped state.
- y is the output.

The support for wrapping states provides these advantages.

- It eliminates simulation instability when your model approaches large angles and large state values.
- It reduces the number of solver resets during simulation and eliminates the need for zero-crossing detection, improving simulation time.
- It eliminates large angle values, speeding up computation of trigonometric functions on angular states.
- It improves solver accuracy and performance and enables unlimited simulation time.

Resetting the State

The block can reset its state to the specified initial condition based on an external signal. To cause the block to reset its state, select one of the **External reset** choices. A trigger port appears below the block's input port and indicates the trigger type.

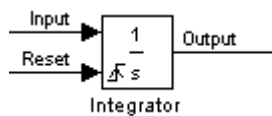

- Select **rising** to reset the state when the reset signal rises from a negative or zero value to a positive value.
- Select **falling** to reset the state when the reset signal falls from a positive value to a zero or negative value.
- Select **either** to reset the state when the reset signal changes from zero to a nonzero value, from a nonzero value to zero, or changes sign.
- Select **level** to reset the state when the reset signal is nonzero at the current time step or changes from nonzero at the previous time step to zero at the current time step.
- Select **level hold** to reset the state when the reset signal is nonzero at the current time step.

The reset port has direct feedthrough. If the block output feeds back into this port, either directly or through a series of blocks with direct feedthrough, an algebraic loop results (see "Algebraic Loop Concepts"). Use the Integrator block's state port to feed back the block's output without creating an algebraic loop.

Note To be compliant with the Motor Industry Software Reliability Association (MISRA) software standard, your model must use Boolean signals to drive the external reset ports of Integrator blocks.

About the State Port

Selecting the **Show state port** check box on the Integrator block's parameter dialog box causes an additional output port, the state port, to appear at the top of the Integrator block.

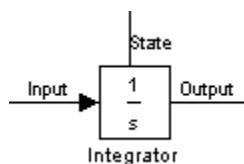

The output of the state port is the same as the output of the block's standard output port except for the following case. If the block is reset in the current time step, the output of the state port is the

value that would have appeared at the block's standard output if the block had not been reset. The state port's output appears earlier in the time step than the output of the Integrator block's output port. Use the state port to avoid creating algebraic loops in these modeling scenarios:

- Self-resetting integrators (see “Creating Self-Resetting Integrators” on page 1-791)
- Handing off a state from one enabled subsystem to another (see “Handing Off States Between Enabled Subsystems” on page 1-792)

Note When updating a model, Simulink checks that the state port applies to one of these two scenarios. If not, an error message appears. Also, you cannot log the output of this port in a referenced model that executes in Accelerator mode. If logging is enabled for the port, Simulink generates a "signal not found" warning during execution of the referenced model.

Creating Self-Resetting Integrators

The Integrator block's state port helps you avoid an algebraic loop when creating an integrator that resets itself based on the value of its output. Consider, for example, the following model.

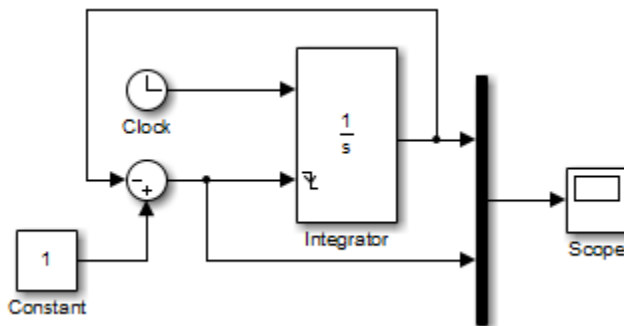

This model tries to create a self-resetting integrator by feeding the integrator's output, subtracted from 1, back into the integrator's reset port. However, the model creates an algebraic loop. To compute the integrator block's output, Simulink software needs to know the value of the block's reset signal, and vice versa. Because the two values are mutually dependent, Simulink software cannot determine either. Therefore, an error message appears if you try to simulate or update this model.

The following model uses the integrator's state port to avoid the algebraic loop.

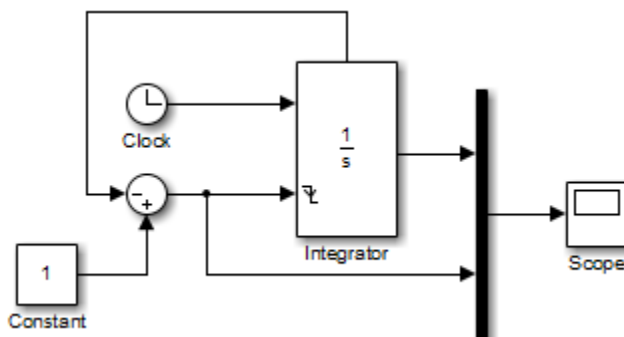

In this version, the value of the reset signal depends on the value of the state port. The value of the state port is available earlier in the current time step than the value of the integrator block's output

port. Therefore, Simulink can determine whether the block needs to be reset before computing the block's output, thereby avoiding the algebraic loop.

Handing Off States Between Enabled Subsystems

The state port helps you avoid an algebraic loop when passing a state between two enabled subsystems. Consider, for example, the following model.

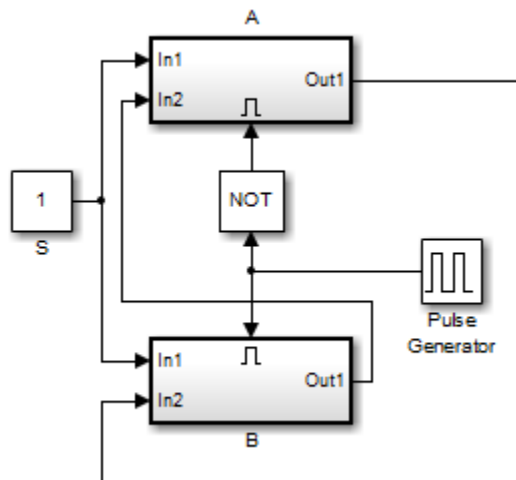

The enabled subsystems, A and B, contain the following blocks:

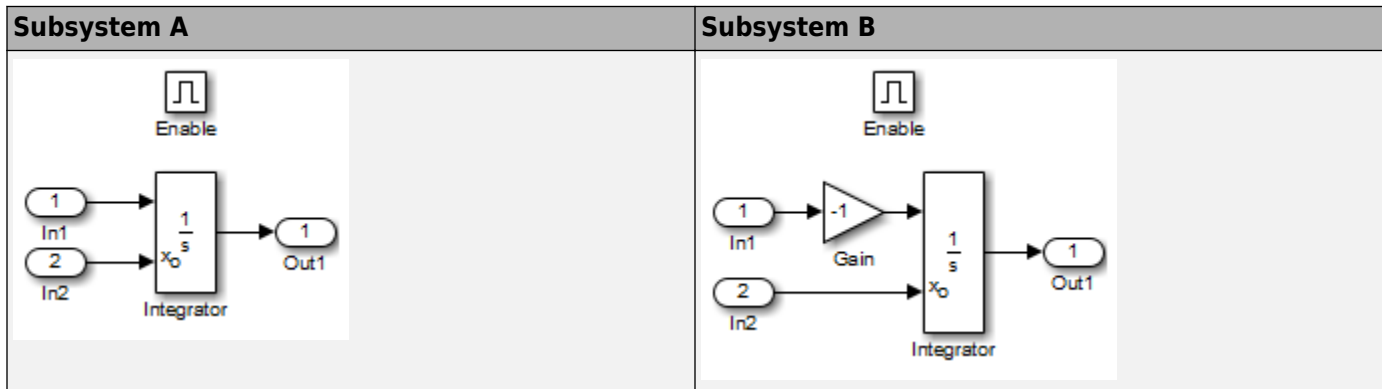

In this model, a constant input signal drives two enabled subsystems that integrate the signal. A pulse generator generates an enabling signal that causes execution to alternate between the two subsystems. The enable port of each subsystem is set to reset, which causes the subsystem to reset its integrator when it becomes active. Resetting the integrator causes the integrator to read the value of its initial condition port. The initial condition port of the integrator in each subsystem is connected to the output port of the integrator in the other subsystem.

This connection is intended to enable continuous integration of the input signal as execution alternates between two subsystems. However, the connection creates an algebraic loop. To compute the output of A, Simulink needs to know the output of B, and vice versa. Because the outputs are mutually dependent, Simulink cannot compute the output values. Therefore, an error message appears if you try to simulate or update this model.

The following version of the same model uses the integrator state port to avoid creating an algebraic loop when handing off the state.

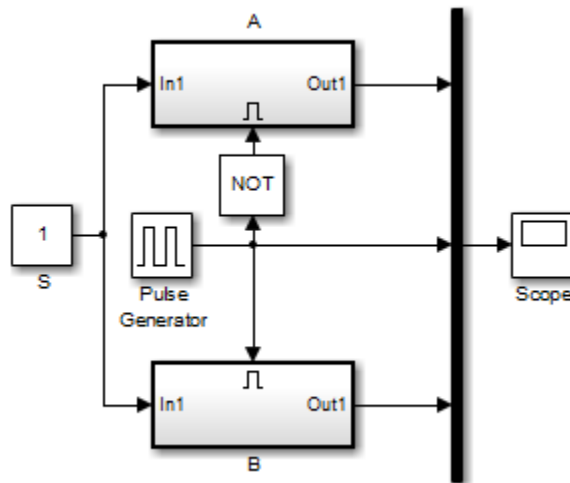

The enabled subsystems, A and B, contain the following blocks:

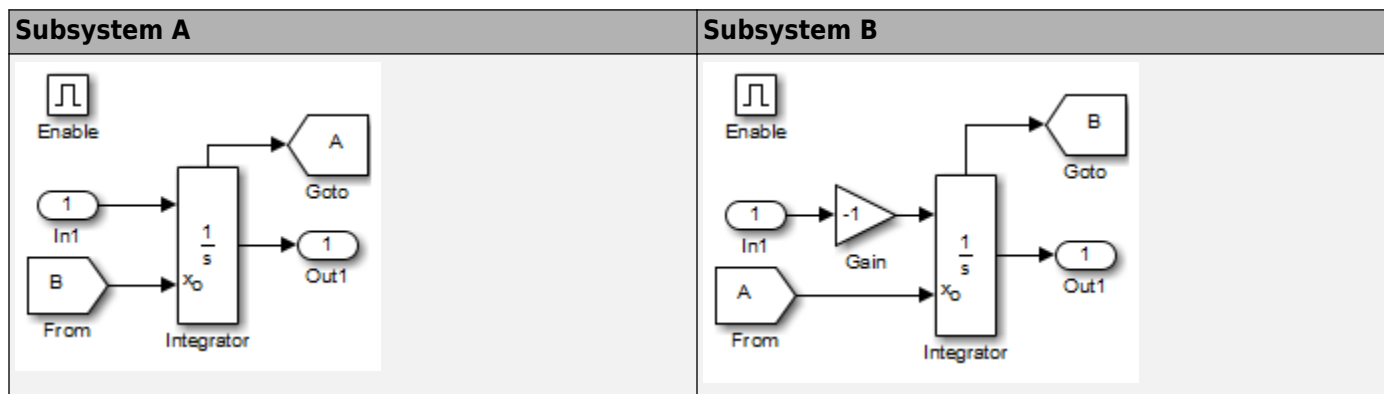

In this model, the initial condition of the integrator in A depends on the value of the state port of the integrator in B, and vice versa. The values of the state ports are updated earlier in the simulation time step than the values of the integrator output ports. Therefore, Simulink can compute the initial condition of either integrator without knowing the final output value of the other integrator. For another example of using the state port to hand off states between conditionally executed subsystems, see “Building a Clutch Lock-Up Model” on page 13-144.

Specifying the Absolute Tolerance for the Block Outputs

By default Simulink software uses the absolute tolerance value specified in the Configuration Parameters dialog box (see “Error Tolerances for Variable-Step Solvers”) to compute the output of the Integrator block. If this value does not provide sufficient error control, specify a more appropriate value in the **Absolute tolerance** field of the Integrator block dialog box. The value that you specify is used to compute all the block outputs.

Selecting All Options

When you select all options, the block icon looks like this.

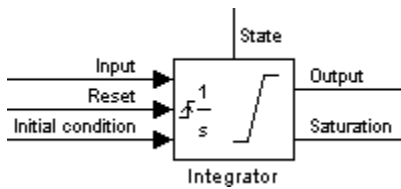

Ports

The Integrator block accepts and outputs signals of type `double` on its data ports. The external reset port accepts signals of type `double` or `Boolean`.

Input

Port_1 — Integrand signal

real scalar or array

Signal that needs to be integrated.

Data Types: `double`

External Reset — Reset state to initial conditions

real scalar or array

Reset the state to the specified initial conditions based on an external signal. See “Resetting the State” on page 1-790.

Dependencies

To enable this port, enable the **External Reset** parameter.

Data Types: `Boolean`

x_0 — Initial condition

real scalar or array

Set the initial condition of the block's state from an external signal.

Dependencies

To enable this port, set the **Initial Conditions** parameter to `external`.

Data Types: `double`

Output

Port_1 — Output signal

real scalar or array

Output the integrated state.

Data Types: `double`

Port_2 — Show output saturation

-1 | 0 | 1

Indicate when the state is being limited. The signal has a value of 1 when the integral is limited by the specified **Upper saturation limit**. When the signal is limited by the **Lower saturation limit**, the

signal value is -1. When the integral is between the saturation limits, the signal value is 0. See “Limiting the Integral” on page 1-788.

Data Types: double

Port_3 – State

real scalar or array

Output the state of the block. See “About the State Port” on page 1-790.

Dependencies

Enable this port by enabling the **Show state port** parameter.

Data Types: double

Parameters

External reset – Reset states to their initial conditions

none (default) | rising | falling | either | level | level hold

Specify the type of trigger to use for the external reset signal.

- Select **rising** to reset the state when the reset signal rises from a negative or zero value to a positive value, or a negative value to zero value.
- Select **falling** to reset the state when the reset signal falls from a positive value to a zero or negative value, or from a zero value to negative value.
- Select **either** to reset the state when the reset signal changes from zero to a nonzero value, from a nonzero value to zero, or changes sign.
- Select **level** to reset the state when the reset signal is nonzero at the current time step or changes from nonzero at the previous time step to zero at the current time step.
- Select **level hold** to reset the state when the reset signal is nonzero at the current time step.

Programmatic Use

Block Parameter: ExternalReset

Type: character vector , string

Values: 'none' | 'rising' | 'falling' | 'either' | 'level' | 'level hold'

Default: 'none'

Initial condition source – Select source of initial condition

internal (default) | external

Select source of initial condition:

- **internal** — Get the initial conditions of the states from the **Initial condition** block parameter.
- **external** — Get the initial conditions of the states from an external block, via the **IC** input port.

Dependencies

Selecting **internal** enables the **Initial condition** parameter.

Selecting **external** disables the **Initial condition** parameter and enables the **IC** input port.

Programmatic Use**Block Parameter:** InitialConditionSource**Type:** character vector, string**Values:** 'internal' | 'external'**Default:** 'internal'**Initial condition — Initial state**

0 (default) | real scalar or array

Set the initial state of the Integrator block.

TipsSimulink software does not allow the initial condition of this block to be `inf` or `NaN`.**Dependencies**Setting **Initial condition source** to `internal` enables this parameter.Setting **Initial condition source** to `external` disables this parameter.**Programmatic Use****Block Parameter:** InitialCondition**Type:** scalar or vector**Default:** '0'**Limit output — Limit block output values to specified range**`off` (default for Integrator) | `on` (default for Integrator Limited)Limit the block's output to a value between the **Lower saturation limit** and **Upper saturation limit** parameters.

- Selecting this check box limits the block output to a value between the **Lower saturation limit** and **Upper saturation limit** parameters.
- Clearing this check box does not limit the block output values.

DependenciesSelecting this parameter enables the **Lower saturation limit** and **Upper saturation limit** parameters.**Programmatic Use****Block Parameter:** LimitOutput**Type:** character vector , string**Values:** 'off' | 'on'**Default:** 'off'**Upper saturation limit — Upper limit for the integral**`inf` (default) | scalar | vector | matrixSpecify the upper limit for the integral as a scalar, vector, or matrix. You must specify a value between the **Output minimum** and **Output maximum** parameter values.**Dependencies**To enable this parameter, select the **Limit output** check box.

Programmatic Use**Block Parameter:** UpperSaturationLimit**Type:** character vector, string**Values:** scalar | vector | matrix**Default:** 'inf'**Lower saturation limit — Lower limit for the integral**

-inf (default) | scalar | vector | matrix

Specify the lower limit for the integral as a scalar, vector, or matrix. You must specify a value between the **Output minimum** and **Output maximum** parameter values.

Dependencies

To enable this parameter, select the **Limit output** check box.

Programmatic Use**Block Parameter:** LowerSaturationLimit**Type:** character vector, string**Values:** scalar | vector | matrix**Default:** '-inf'**Wrap state — Enable wrapping of states**

off (default) | on

Enable wrapping of states between the **Wrapped state upper value** and **Wrapped state lower value** parameters. Enabling wrap states eliminates the need for zero-crossing detection, reduces solver resets, improves solver performance and accuracy, and increases simulation time span when modeling rotary and cyclic state trajectories.

If you specify **Wrapped state upper value** as inf and **Wrapped state lower value** as -inf, wrapping does not occur.

Dependencies

Selecting this parameter enables **Wrapped state upper value** and **Wrapped state lower value** parameters.

Programmatic Use**Block Parameter:** WrapState**Type:** character vector, string**Values:** 'off' | 'on'**Default:** 'off'**Wrapped state upper value — Specify upper value for wrapped state**

pi (default) | scalar or vector

Upper limit of the block output.

Dependencies

Selecting **Wrap state** enables this parameter.

Programmatic Use**Block Parameter:** WrappedStateUpperValue**Type:** scalar or vector

Values: '2*pi'

Default: 'pi'

Wrapped state lower value — Specify lower value for wrap state

-pi (default) | scalar or vector

Lower limit of the block output.

Dependencies

Selecting **Wrap state** enables this parameter.

Programmatic Use

Block Parameter: WrappedStateLowerValue

Type: scalar or vector

Values: '0'

Default: '-pi'

Show saturation port — Enable saturation output port

off (default) | on

Select this check box to add a saturation output port to the block. When you clear this check box, the block does not have a saturation output port.

Dependencies

Selecting this parameter enables a saturation output port.

Programmatic Use

Block Parameter: ShowSaturationPort

Type: character vector , string

Values: 'off' | 'on'

Default: 'off'

Show state port — Enable state output port

off (default) | on

Select this check box to add a state output port to the block. When you clear this check box, the block does not have a state output port.

Dependencies

Selecting this parameter enables a state output port.

Programmatic Use

Block Parameter: ShowStatePort

Type: character vector , string

Values: 'off' | 'on'

Default: 'off'

Absolute tolerance — Absolute tolerance for block states

auto (default) | real scalar or vector

- If you enter `auto` or `-1`, then Simulink uses the absolute tolerance value in the Configuration Parameters dialog box (see “Solver Pane”) to compute block states.
- If you enter a real scalar, then that value overrides the absolute tolerance in the Configuration Parameters dialog box for computing all block states.

- If you enter a real vector, then the dimension of that vector must match the dimension of the continuous states in the block. These values override the absolute tolerance in the Configuration Parameters dialog box.

Programmatic Use**Block Parameter:** AbsoluteTolerance**Type:** character vector, string, scalar, or vector**Values:** 'auto' | '-1' | any positive real scalar or vector**Default:** 'auto'**Ignore limit and reset when linearizing — Treat block as unresettable and output unlimited**

off (default) | on

Cause Simulink linearization commands to treat this block as unresettable and as having no limits on its output, regardless of the settings of the reset and output limitation options of the block.

Tip

Use this check box to linearize a model around an operating point that causes the integrator to reset or saturate.

Programmatic Use**Block Parameter:** IgnoreLimit**Type:** character vector, string**Values:** 'off' | 'on'**Default:** 'off'**Enable zero-crossing detection — Enable zero-crossing detection**

on (default) | Boolean

Select to enable zero-crossing detection. For more information, see “Zero-Crossing Detection” in the Simulink documentation.

Programmatic Use**Block Parameter:** ZeroCross**Type:** character vector, string**Values:** 'off' | 'on'**Default:** 'on'**State Name (e.g., 'position') — Assign unique name to each state**

' ' (default) | character vector | string

- To assign a name to a single state, enter the name between quotes, for example, 'velocity'.
- To assign names to multiple states, enter a comma-delimited list surrounded by braces, for example, {'a', 'b', 'c'}. Each name must be unique.
- The state names apply only to the selected block.
- The number of states must divide evenly among the number of state names.
- You can specify fewer names than states, but you cannot specify more names than states.

For example, you can specify two names in a system with four states. The first name applies to the first two states and the second name to the last two states.

- To assign state names with a variable in the MATLAB workspace, enter the variable without quotes. A variable can be a character vector, string, cell array, or structure.

Programmatic Use**Block Parameter:** ContinuousStateAttributes**Type:** character vector, string**Values:** ' ' | user-defined**Default:** ' '**Block Characteristics**

| | |
|---------------------------------|--------|
| Data Types | double |
| Direct Feedthrough | yes |
| Multidimensional Signals | no |
| Variable-Size Signals | no |
| Zero-Crossing Detection | yes |

Extended Capabilities**C/C++ Code Generation**

Generate C and C++ code using Simulink® Coder™.

- Consider discretizing the model
- Not recommended for production code

See Also

Discrete-Time Integrator | Second-Order Integrator

Introduced before R2006a

Integrator Limited

Integrate signal

Library: Simulink / Continuous



Description

The Integrator Limited block is identical to the Integrator block with the exception that the output of the block is limited based on the upper and lower saturation limits. See “Limiting the Integral” on page 1-803 for details.

Simulink treats the Integrator block as a dynamic system with one state. The block dynamics are given by:

$$\begin{cases} \dot{x}(t) = u(t) \\ y(t) = x(t) \end{cases} \quad x(t_0) = x_0$$

where:

- u is the block input.
- y is the block output.
- x is the block state.
- x_0 is the initial condition of x .

While these equations define an exact relationship in continuous time, Simulink uses numerical approximation methods to evaluate them with finite precision. Simulink can use several different numerical integration methods to compute the output of the block, each with advantages in particular applications. Use the **Solver** pane of the Configuration Parameters dialog box (see “Solver Pane”) to select the technique best suited to your application.

The selected solver computes the output of the Integrator block at the current time step, using the current input value and the value of the state at the previous time step. To support this computational model, the Integrator block saves its output at the current time step for use by the solver to compute its output at the next time step. The block also provides the solver with an initial condition for use in computing the block's initial state at the beginning of a simulation. The default value of the initial condition is 0. Use the block parameter dialog box to specify another value for the initial condition or create an initial value input port on the block.

Use the parameter dialog box to:

- Define upper and lower limits on the integral
- Create an input that resets the block's output (state) to its initial value, depending on how the input changes
- Create an optional state output so that the value of the block's output can trigger a block reset

Use the Discrete-Time Integrator block to create a purely discrete system.

Defining Initial Conditions

You can define the initial conditions as a parameter on the block dialog box or input them from an external signal:

- To define the initial conditions as a block parameter, specify the **Initial condition source** parameter as `internal` and enter the value in the **Initial condition** field.
- To provide the initial conditions from an external source, specify the **Initial condition source** parameter as `external`. An additional input port appears under the block input.

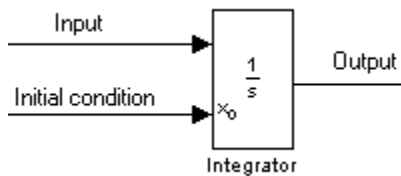

Note If the integrator limits its output (see “Limiting the Integral” on page 1-803), the initial condition must fall inside the integrator's saturation limits. If the initial condition is outside the block saturation limits, the block displays an error message.

Wrapping Cyclic States

Several physical phenomena are cyclic, periodic, or rotary in nature. Objects or machinery that exhibit rotational movement and oscillators are examples of such phenomena.

Modeling these phenomena in Simulink involves integrating the rate of change of the periodic or cyclic signals to obtain the state of the movement.

The drawback with this approach, however, is that over long simulation time spans, the states representing periodic or cyclic signals integrate to large values. Further, computing the sine or cosine of these signals takes an increasingly large amount of time because of angle reduction. The large signals values also negatively impact solver performance and accuracy.

One approach for overcoming this drawback is to reset the angular state to 0 when it reaches 2π (or to $-\pi$ when it reaches π , for numerical symmetry). This approach improves the accuracy of sine and cosine computations and reduces angle reduction time. But it also requires zero-crossing detection and introduces solver resets, which slow down the simulation for variable step solvers, particularly in large models.

To eliminate solver resets at wrap points, the Integrator block supports wrapped states that you can enable by checking **Wrap state** on the block parameter dialog box. When you enable **Wrap state**, the block icon changes to indicate that the block has wrapping states.

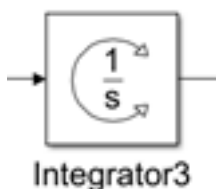

Simulink allows wrapping states that are bounded by upper and lower values parameters of the wrapped state. The algorithm for determining wrapping states is given by:

$$y = \begin{cases} x & x \in [x_l, x_u) \\ x - (x_u - x_l) \left\lfloor \frac{x - x_l}{x_u - x_l} \right\rfloor & \text{otherwise} \end{cases}$$

where:

- x_l is the lower value of the wrapped state.
- x_u is the upper value of the wrapped state.
- y is the output.

The support for wrapping states provides these advantages.

- It eliminates simulation instability when your model approaches large angles and large state values.
- It reduces the number of solver resets during simulation and eliminates the need for zero-crossing detection, improving simulation time.
- It eliminates large angle values, speeding up computation of trigonometric functions on angular states.
- It improves solver accuracy and performance and enables unlimited simulation time.

Limiting the Integral

To prevent the output from exceeding specifiable levels, select the **Limit output** check box and enter the limits in the appropriate parameter fields. This action causes the block to function as a limited integrator. When the output reaches the limits, the integral action is turned off to prevent integral wind up. During a simulation, you can change the limits but you cannot change whether the output is limited. The block determines output as follows:

- When the integral is less than or equal to the **Lower saturation limit**, the output is held at the **Lower saturation limit**.
- When the integral is between the **Lower saturation limit** and the **Upper saturation limit**, the output is the integral.
- When the integral is greater than or equal to the **Upper saturation limit**, the output is held at the **Upper saturation limit**.

To generate a signal that indicates when the state is being limited, select the **Show saturation port** check box. A saturation port appears below the block output port.

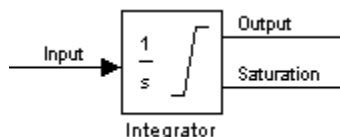

The signal has one of three values:

- 1 indicates that the upper limit is being applied.
- 0 indicates that the integral is not limited.

- -1 indicates that the lower limit is being applied.

When you select this check box, the block has three zero crossings: one to detect when it enters the upper saturation limit, one to detect when it enters the lower saturation limit, and one to detect when it leaves saturation.

Note For the Integrator Limited block, by default, **Limit output** is selected, **Upper saturation limit** is set to 1, and **Lower saturation limit** is set to 0.

Resetting the State

The block can reset its state to the specified initial condition based on an external signal. To cause the block to reset its state, select one of the **External reset** choices. A trigger port appears below the block's input port and indicates the trigger type.

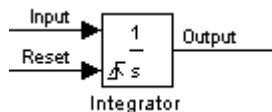

- Select **rising** to reset the state when the reset signal rises from a negative or zero value to a positive value.
- Select **falling** to reset the state when the reset signal falls from a positive value to a zero or negative value.
- Select **either** to reset the state when the reset signal changes from zero to a nonzero value, from a nonzero value to zero, or changes sign.
- Select **level** to reset the state when the reset signal is nonzero at the current time step or changes from nonzero at the previous time step to zero at the current time step.
- Select **level hold** to reset the state when the reset signal is nonzero at the current time step.

The reset port has direct feedthrough. If the block output feeds back into this port, either directly or through a series of blocks with direct feedthrough, an algebraic loop results (see "Algebraic Loop Concepts"). Use the Integrator block's state port to feed back the block's output without creating an algebraic loop.

Note To be compliant with the Motor Industry Software Reliability Association (MISRA) software standard, your model must use Boolean signals to drive the external reset ports of Integrator blocks.

About the State Port

Selecting the **Show state port** check box on the Integrator block's parameter dialog box causes an additional output port, the state port, to appear at the top of the Integrator block.

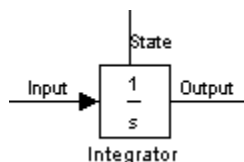

The output of the state port is the same as the output of the block's standard output port except for the following case. If the block is reset in the current time step, the output of the state port is the

value that would have appeared at the block's standard output if the block had not been reset. The state port's output appears earlier in the time step than the output of the Integrator block's output port. Use the state port to avoid creating algebraic loops in these modeling scenarios:

- Self-resetting integrators (see “Creating Self-Resetting Integrators” on page 1-805)
- Handing off a state from one enabled subsystem to another (see “Handing Off States Between Enabled Subsystems” on page 1-806)

Note When updating a model, Simulink checks that the state port applies to one of these two scenarios. If not, an error message appears. Also, you cannot log the output of this port in a referenced model that executes in Accelerator mode. If logging is enabled for the port, Simulink generates a "signal not found" warning during execution of the referenced model.

Creating Self-Resetting Integrators

The Integrator block's state port helps you avoid an algebraic loop when creating an integrator that resets itself based on the value of its output. Consider, for example, the following model.

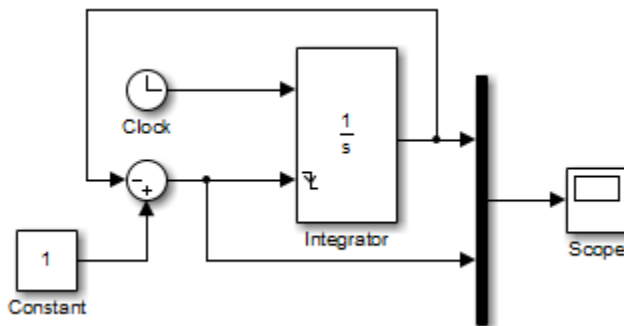

This model tries to create a self-resetting integrator by feeding the integrator's output, subtracted from 1, back into the integrator's reset port. However, the model creates an algebraic loop. To compute the integrator block's output, Simulink software needs to know the value of the block's reset signal, and vice versa. Because the two values are mutually dependent, Simulink software cannot determine either. Therefore, an error message appears if you try to simulate or update this model.

The following model uses the integrator's state port to avoid the algebraic loop.

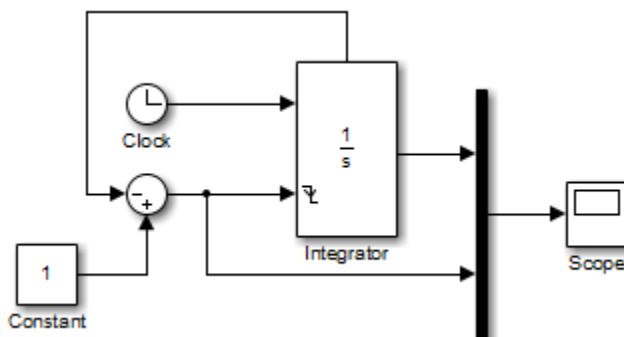

In this version, the value of the reset signal depends on the value of the state port. The value of the state port is available earlier in the current time step than the value of the integrator block's output

port. Therefore, Simulink can determine whether the block needs to be reset before computing the block's output, thereby avoiding the algebraic loop.

Handing Off States Between Enabled Subsystems

The state port helps you avoid an algebraic loop when passing a state between two enabled subsystems. Consider, for example, the following model.

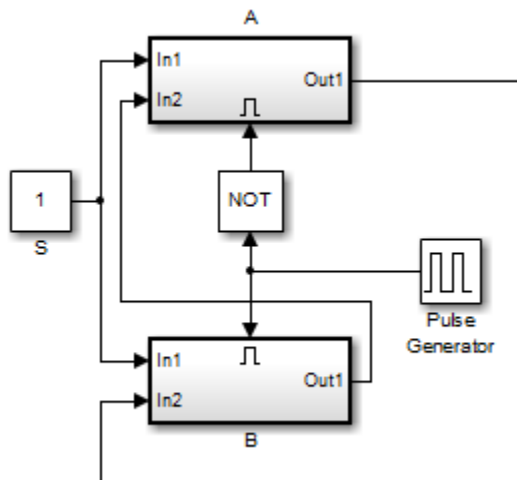

The enabled subsystems, A and B, contain the following blocks:

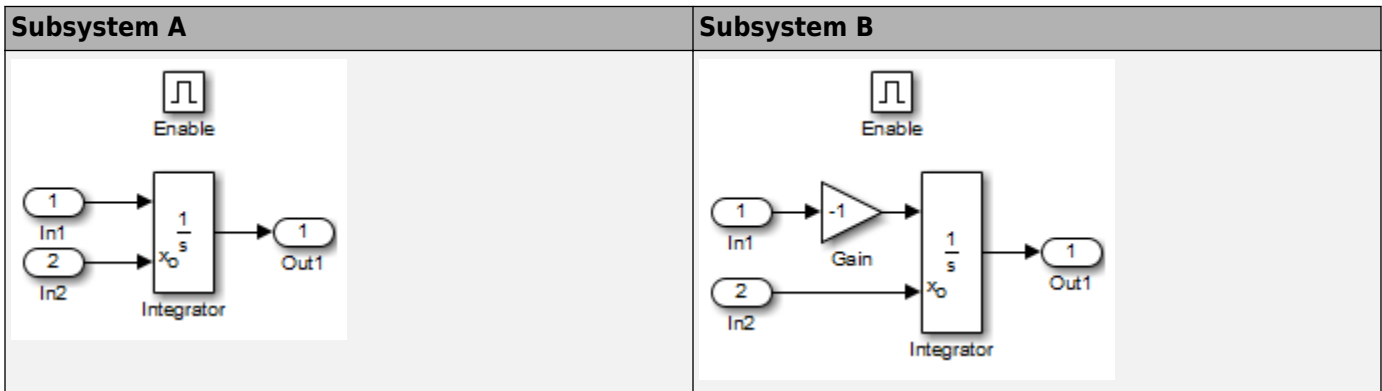

In this model, a constant input signal drives two enabled subsystems that integrate the signal. A pulse generator generates an enabling signal that causes execution to alternate between the two subsystems. The enable port of each subsystem is set to reset, which causes the subsystem to reset its integrator when it becomes active. Resetting the integrator causes the integrator to read the value of its initial condition port. The initial condition port of the integrator in each subsystem is connected to the output port of the integrator in the other subsystem.

This connection is intended to enable continuous integration of the input signal as execution alternates between two subsystems. However, the connection creates an algebraic loop. To compute the output of A, Simulink needs to know the output of B, and vice versa. Because the outputs are mutually dependent, Simulink cannot compute the output values. Therefore, an error message appears if you try to simulate or update this model.

The following version of the same model uses the integrator state port to avoid creating an algebraic loop when handing off the state.

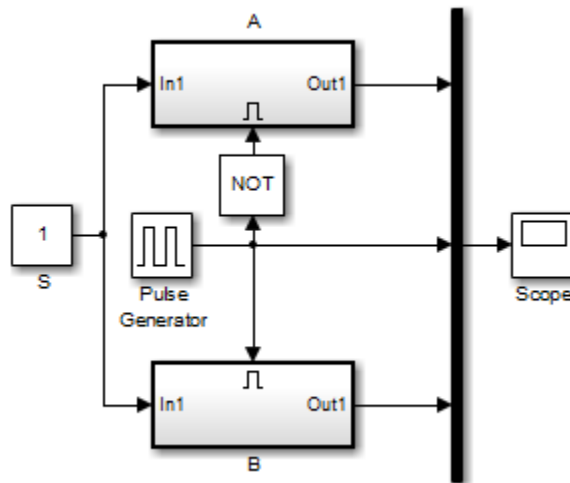

The enabled subsystems, A and B, contain the following blocks:

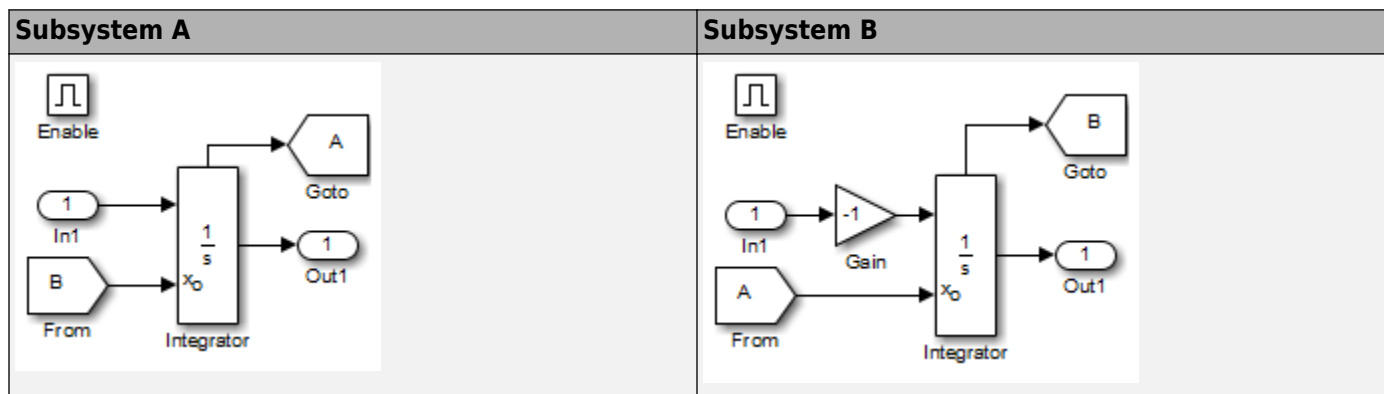

In this model, the initial condition of the integrator in A depends on the value of the state port of the integrator in B, and vice versa. The values of the state ports are updated earlier in the simulation time step than the values of the integrator output ports. Therefore, Simulink can compute the initial condition of either integrator without knowing the final output value of the other integrator. For another example of using the state port to hand off states between conditionally executed subsystems, see “Building a Clutch Lock-Up Model” on page 13-144.

Specifying the Absolute Tolerance for the Block Outputs

By default Simulink software uses the absolute tolerance value specified in the Configuration Parameters dialog box (see “Error Tolerances for Variable-Step Solvers”) to compute the output of the Integrator block. If this value does not provide sufficient error control, specify a more appropriate value in the **Absolute tolerance** field of the Integrator block dialog box. The value that you specify is used to compute all the block outputs.

Selecting All Options

When you select all options, the block icon looks like this.

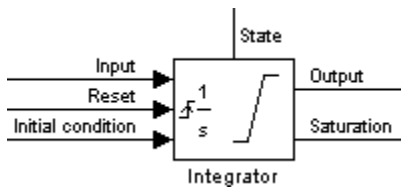

Ports

Input

Port_1 — Integrand signal

real scalar or array

Signal that needs to be integrated.

Data Types: double

External Reset — Reset state to initial conditions

real scalar or array

Reset the state to the specified initial conditions based on an external signal. See “Resetting the State” on page 1-804.

Dependencies

To enable this port, enable the **External Reset** parameter.

Data Types: Boolean

x_0 — Initial condition

real scalar or array

Set the initial condition of the block's state from an external signal.

Dependencies

To enable this port, set the **Initial Conditions** parameter to external.

Data Types: double

Output

Port_1 — Output signal

real scalar or array

Output the integrated state.

Data Types: double

Port_2 — Show output saturation

-1 | 0 | 1

Indicate when the state is being limited. The signal has a value of 1 when the integral is limited by the specified **Upper saturation limit**. When the signal is limited by the **Lower saturation limit**, the signal value is -1. When the integral is between the saturation limits, the signal value is 0. See “Limiting the Integral” on page 1-803.

Data Types: double

Port_3 – State

real scalar or array

Output the state of the block. See “About the State Port” on page 1-804.

Dependencies

Enable this port by enabling the **Show state port** parameter.

Data Types: double

Parameters

External reset – Reset states to their initial conditions

none (default) | rising | falling | either | level | level hold

Specify the type of trigger to use for the external reset signal.

- Select **rising** to reset the state when the reset signal rises from a negative or zero value to a positive value, or a negative value to zero value.
- Select **falling** to reset the state when the reset signal falls from a positive value to a zero or negative value, or from a zero value to negative value.
- Select **either** to reset the state when the reset signal changes from zero to a nonzero value, from a nonzero value to zero, or changes sign.
- Select **level** to reset the state when the reset signal is nonzero at the current time step or changes from nonzero at the previous time step to zero at the current time step.
- Select **level hold** to reset the state when the reset signal is nonzero at the current time step.

Programmatic Use

Block Parameter: ExternalReset

Type: character vector , string

Values: 'none' | 'rising' | 'falling' | 'either' | 'level' | 'level hold'

Default: 'none'

Initial condition source – Select source of initial condition

internal (default) | external

Select source of initial condition:

- **internal** — Get the initial conditions of the states from the **Initial condition** block parameter.
- **external** — Get the initial conditions of the states from an external block, via the **IC** input port.

Dependencies

Selecting **internal** enables the **Initial condition** parameter.

Selecting **external** disables the **Initial condition** parameter and enables the **IC** input port.

Programmatic Use

Block Parameter: InitialConditionSource

Type: character vector, string

Values: 'internal' | 'external'

Default: 'internal'

Initial condition — Initial state

0 (default) | real scalar or array

Set the initial state of the Integrator block.

Tips

Simulink software does not allow the initial condition of this block to be `inf` or `NaN`.

Dependencies

Setting **Initial condition source** to `internal` enables this parameter.

Setting **Initial condition source** to `external` disables this parameter.

Programmatic Use

Block Parameter: `InitialCondition`

Type: scalar or vector

Default: '0'

Limit output — Limit block output values to specified range

`off` (default for Integrator) | `on` (default for Integrator Limited)

Limit the block's output to a value between the **Lower saturation limit** and **Upper saturation limit** parameters.

- Selecting this check box limits the block output to a value between the **Lower saturation limit** and **Upper saturation limit** parameters.
- Clearing this check box does not limit the block output values.

Dependencies

Selecting this parameter enables the **Lower saturation limit** and **Upper saturation limit** parameters.

Programmatic Use

Block Parameter: `LimitOutput`

Type: character vector, string

Values: 'off' | 'on'

Default: 'off'

Upper saturation limit — Upper limit for the integral

`inf` (default) | scalar | vector | matrix

Specify the upper limit for the integral as a scalar, vector, or matrix. You must specify a value between the **Output minimum** and **Output maximum** parameter values.

Dependencies

To enable this parameter, select the **Limit output** check box.

Programmatic Use

Block Parameter: `UpperSaturationLimit`

Type: character vector, string

Values: scalar | vector | matrix

Default: 'inf'

Lower saturation limit — Lower limit for the integral

-inf (default) | scalar | vector | matrix

Specify the lower limit for the integral as a scalar, vector, or matrix. You must specify a value between the **Output minimum** and **Output maximum** parameter values.

Dependencies

To enable this parameter, select the **Limit output** check box.

Programmatic Use

Block Parameter: LowerSaturationLimit

Type: character vector, string

Values: scalar | vector | matrix

Default: '-inf'

Wrap state — Enable wrapping of states

off (default) | on

Enable wrapping of states between the **Wrapped state upper value** and **Wrapped state lower value** parameters. Enabling wrap states eliminates the need for zero-crossing detection, reduces solver resets, improves solver performance and accuracy, and increases simulation time span when modeling rotary and cyclic state trajectories.

If you specify **Wrapped state upper value** as inf and **Wrapped state lower value** as -inf, wrapping does not occur.

Dependencies

Selecting this parameter enables **Wrapped state upper value** and **Wrapped state lower value** parameters.

Programmatic Use

Block Parameter: WrapState

Type: character vector, string

Values: 'off' | 'on'

Default: 'off'

Wrapped state upper value — Specify upper value for wrapped state

pi (default) | scalar or vector

Upper limit of the block output.

Dependencies

Selecting **Wrap state** enables this parameter.

Programmatic Use

Block Parameter: WrappedStateUpperValue

Type: scalar or vector

Values: '2*pi'

Default: 'pi'

Wrapped state lower value — Specify lower value for wrap state

-pi (default) | scalar or vector

Lower limit of the block output.

Dependencies

Selecting **Wrap state** enables this parameter.

Programmatic Use

Block Parameter: WrappedStateLowerValue

Type: scalar or vector

Values: '0'

Default: '-pi'

Show saturation port — Enable saturation output port

off (default) | on

Select this check box to add a saturation output port to the block. When you clear this check box, the block does not have a saturation output port.

Dependencies

Selecting this parameter enables a saturation output port.

Programmatic Use

Block Parameter: ShowSaturationPort

Type: character vector , string

Values: 'off' | 'on'

Default: 'off'

Show state port — Enable state output port

off (default) | on

Select this check box to add a state output port to the block. When you clear this check box, the block does not have a state output port.

Dependencies

Selecting this parameter enables a state output port.

Programmatic Use

Block Parameter: ShowStatePort

Type: character vector , string

Values: 'off' | 'on'

Default: 'off'

Absolute tolerance — Absolute tolerance for block states

auto (default) | real scalar or vector

- If you enter `auto` or `-1`, then Simulink uses the absolute tolerance value in the Configuration Parameters dialog box (see “Solver Pane”) to compute block states.
- If you enter a real scalar, then that value overrides the absolute tolerance in the Configuration Parameters dialog box for computing all block states.
- If you enter a real vector, then the dimension of that vector must match the dimension of the continuous states in the block. These values override the absolute tolerance in the Configuration Parameters dialog box.

Programmatic Use**Block Parameter:** AbsoluteTolerance**Type:** character vector, string, scalar, or vector**Values:** 'auto' | '-1' | any positive real scalar or vector**Default:** 'auto'**Ignore limit and reset when linearizing — Treat block as unresettable and output unlimited**

off (default) | on

Cause Simulink linearization commands to treat this block as unresettable and as having no limits on its output, regardless of the settings of the reset and output limitation options of the block.

Tip

Use this check box to linearize a model around an operating point that causes the integrator to reset or saturate.

Programmatic Use**Block Parameter:** IgnoreLimit**Type:** character vector, string**Values:** 'off' | 'on'**Default:** 'off'**Enable zero-crossing detection — Enable zero-crossing detection**

on (default) | Boolean

Select to enable zero-crossing detection. For more information, see “Zero-Crossing Detection” in the Simulink documentation.

Programmatic Use**Block Parameter:** ZeroCross**Type:** character vector, string**Values:** 'off' | 'on'**Default:** 'on'**State Name (e.g., 'position') — Assign unique name to each state**

' ' (default) | character vector | string

- To assign a name to a single state, enter the name between quotes, for example, 'velocity'.
- To assign names to multiple states, enter a comma-delimited list surrounded by braces, for example, {'a', 'b', 'c'}. Each name must be unique.
- The state names apply only to the selected block.
- The number of states must divide evenly among the number of state names.
- You can specify fewer names than states, but you cannot specify more names than states.

For example, you can specify two names in a system with four states. The first name applies to the first two states and the second name to the last two states.

- To assign state names with a variable in the MATLAB workspace, enter the variable without quotes. A variable can be a character vector, string, cell array, or structure.

Programmatic Use**Block Parameter:** ContinuousStateAttributes

Type: character vector, string

Values: ' ' | user-defined

Default: ' '

Block Characteristics

| | |
|---------------------------------|--------|
| Data Types | double |
| Direct Feedthrough | yes |
| Multidimensional Signals | no |
| Variable-Size Signals | no |
| Zero-Crossing Detection | yes |

Extended Capabilities

C/C++ Code Generation

Generate C and C++ code using Simulink® Coder™.

- Consider discretizing the model
- Not recommended for production code

See Also

Discrete-Time Integrator | Second-Order Integrator

Introduced before R2006a

Interpolation Using Prelookup

Use precalculated index and fraction values to accelerate approximation of N-dimensional function

Library: Simulink / Lookup Tables

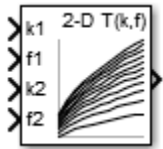

Description

The Interpolation Using Prelookup block is most efficient when used with the Prelookup block. The Prelookup block calculates the index and interval fraction that specify how its input value u relates to the breakpoint data set. Feed the resulting index and fraction values into an Interpolation Using Prelookup block to interpolate an n -dimensional table. These two blocks have distributed algorithms. When combined together, they perform the same operation as the integrated algorithm in the n -D Lookup Table block. However, the Prelookup and Interpolation Using Prelookup blocks offer greater flexibility that can provide more efficient simulation and code generation. For more information, see “Efficiency of Performance”.

Supported Block Operations

To use the Interpolation Using Prelookup block, you specify a set of table data values directly on the dialog box or feed values into the **T** input port. Typically, these table values correspond to the breakpoint data sets specified in Prelookup blocks. The Interpolation Using Prelookup block generates output by looking up or estimating table values based on index and interval fraction values fed from Prelookup blocks. Labels for the index and interval fraction appear as k and f on the Interpolation Using Prelookup block icon.

| When inputs for index and interval fraction... | The Interpolation Using Prelookup block... |
|--|--|
| Map to values in breakpoint data sets | Outputs the table value at the intersection of the row, column, and higher dimension breakpoints |
| Do not map to values in breakpoint data sets, but are within range | Interpolates appropriate table values using the Interpolation method you select |
| Do not map to values in breakpoint data sets, and are out of range | Extrapolates the output value using the Extrapolation method you select |

How The Block Interpolates a Subset of Table Data

You can use the **Number of sub-table selection dimensions** parameter to specify that interpolation occur only on a subset of the table data. To activate this interpolation mode, set this parameter to a positive integer. This value defines the number of dimensions to select, starting from the highest dimension of table data for the default column-major algorithm. Therefore, the value must be less than or equal to the **Number of table dimensions**.

For row-major algorithms, the interpolation starts from the first or lowest dimension of the table data.

For nonzero values, the subtable selection behavior is optimized for row-major layout when you select the **Math and Data Types > Use algorithms optimized for row-major array layout** configuration parameter.

Suppose that you have 3-D table data in your Interpolation Using Prelookup block. This behavior applies for the column-major algorithm.

| Number of Selection Dimensions | Action by the Block | Block Appearance |
|--------------------------------|--|--|
| 0 | Interpolates the entire table and does not activate subtable selection | Does not change |
| 1 | Interpolates the first two dimensions and selects the third dimension | Displays an input port with the label <code>s3</code> that you use to select and interpolate 2-D tables |
| 2 | Interpolates the first dimension and selects the second and third dimensions | Displays two input ports with the labels <code>s2</code> and <code>s3</code> that you use to select and interpolate 1-D tables |

Subtable selection uses zero-based indexing. For an example of interpolating a subset of table data, see “Using the Prelookup and Interpolation Blocks” on page 13-578.

For 2-D or n-D interpolation without subtable selection, the column-major and row-major algorithms may differ in the order of output calculations, causing slight different numerical results.

Ports

Input

k1 – Index, k, for the first dimension of the table

scalar | vector | matrix

Zero-based index, k , specifying the interval containing the input u for the first dimension of the table.

Data Types: single | double | int8 | int16 | int32 | int64 | uint8 | uint16 | uint32 | uint64 | fixed point

f1 – Fraction, f, for the first dimension of the table

scalar | vector | matrix

Fraction, f , representing the normalized position of the input within the interval, k , for the first dimension of the table.

Data Types: single | double | int8 | int16 | int32 | int64 | uint8 | uint16 | uint32 | uint64 | fixed point

kn – Index, k, for the n-th dimension of the table

scalar | vector | matrix

Zero-based index, k , specifying the interval containing the input u for the n -th dimension of the table.

Data Types: single | double | int8 | int16 | int32 | int64 | uint8 | uint16 | uint32 | uint64 | fixed point

fn — Fraction, f, for the n-th dimension of the table

scalar | vector | matrix

Fraction, *f*, representing the normalized position of the input within the interval, *k*, for the *n*-th dimension of the table.

Data Types: single | double | int8 | int16 | int32 | int64 | uint8 | uint16 | uint32 | uint64 | fixed point

kf1 — Input containing index k and fraction f

bus object

Inputs to the **kf1** port contain index *k* and fraction *f* specified as a bus object.

Dependencies

To enable this port, select the **Require index and fraction as a bus** check box.

The number of available **kf** input ports depends on the value of the **Number of dimensions** and **Number of sub-table selection dimensions** parameters.

Data Types: single | double | int8 | int16 | int32 | int64 | uint8 | uint16 | uint32 | uint64 | fixed point | bus

kfn — Input containing index k and fraction f

bus object

Inputs to the **kfn** port contain index *k* and fraction *f* for the *n*-th dimension of the input, specified as a bus object.

Dependencies

To enable this port, select the **Require index and fraction as a bus** check box.

The number of available **kf** input ports depends on the value of the **Number of dimensions** and **Number of sub-table selection dimensions** parameters.

Data Types: single | double | int8 | int16 | int32 | int64 | uint8 | uint16 | uint32 | uint64 | fixed point | bus

sm — Select and interpolate a subset of the table data

scalar | vector | matrix

For column-major algorithm, the block uses inputs to the *sm*, *sm*+1, ... *sn* port to perform selection and interpolation within the subtables. *m* maps to the *m*th dimension of the table. *n* equals the **Number of dimensions**.

For row-major algorithm, the block uses inputs to the *s1*, *s2*, ... ,*sm* port to perform selection and interpolation within the subtables. *m* maps to the *m*th dimension of the table. *m* equals the **Number of sub-table selection dimensions**.

Dependencies

To enable this port, the **Number of sub-table selection dimensions** must be a positive integer less than or equal to the **Number of dimensions**.

Data Types: single | double | int8 | int16 | int32 | int64 | uint8 | uint16 | uint32 | uint64 | Boolean | fixed point | enumerated | bus

T — Table data

scalar | vector | matrix | n-d array

Table data values provided as input to port **T**. Typically, these table values correspond to the breakpoint data sets specified in Prelookup blocks. The Interpolation Using Prelookup block generates output by looking up or estimating table values based on index (k) and interval fraction (f) values fed from Prelookup blocks.

Dependencies

To enable this port, set **Source** to Input port.

Data Types: single | double | int8 | int16 | int32 | int64 | uint8 | uint16 | uint32 | uint64 | fixed point

Output**Port_1 — Approximation of N-dimensional function**

scalar | vector | matrix

Approximation of N-dimensional function, computed by interpolating (or extrapolating) table data using values from the input index, k, and fraction, f.

Data Types: single | double | int8 | int16 | int32 | int64 | uint8 | uint16 | uint32 | uint64 | fixed point

Parameters**Main****Table data****Number of dimensions — Number of table data dimensions**

2 (default) | integer between 1 and 30

Specify the number of dimensions that the table data must have. The **Number of dimensions** defines the number of independent variables for the table.

| To specify... | Do this... |
|-------------------------------------|---|
| 1, 2, 3, or 4 | Select the value from the drop-down list. |
| A higher number of table dimensions | Enter a positive integer directly in the field. The maximum number of table dimensions that this block supports is 30. |

Programmatic Use**Block Parameter:** NumberOfTableDimensions**Type:** character vector**Values:** '1' | '2' | '3' | '4' | ... | '30'**Default:** '2'**Require index and fraction as bus — Index and fraction inputs can be combined in a bus**

off (default) | on

Select this check box to combine index and fraction inputs in a bus.

To enable the Prelookup block to supply input to the Interpolation Using Prelookup block, set:

- **Output selection** to Index and fraction as bus
- **Output** to Bus: <object name>, where <object name> must be a valid bus object name accessible to the model

Regardless of this check box setting, the selection port always operates in nonbus mode.

Programmatic Use

Block Parameter: RequireIndexFractionAsBus

Type: character vector

Values: 'off' | 'on'

Default: 'off'

Specification — Choose how to enter table data

Explicit values (default) | Lookup table object

Specify whether to enter table data directly or use a lookup table object. If you set this parameter to:

- Explicit values, the **Source** and **Value** parameters are visible on the dialog box.
- Lookup table object, the **Name** parameter is visible on the dialog box.

Programmatic Use

Block Parameter: TableSpecification

Type: character vector

Values: 'Explicit values' | 'Lookup table object'

Default: 'Explicit values'

Source — Source of table data

Dialog (default) | Input port

Specify whether to enter table data in the dialog box or to inherit the data from an input port. If you set **Source** to:

- Dialog, enter table data in the text box under **Value**
- Input port, verify that an upstream signal supplies table data to the table input port

Dependencies

To enable this parameter, set **Specification** to Explicit values.

Programmatic Use

Block Parameter: TableSource

Type: character vector

Values: 'Dialog' | 'Input port'

Default: 'Dialog'

Value — Specify table data values

$\text{sqrt}([1:11]' * [1:11])$ (default) | multidimensional array of table data

Specify table data as an N-D array, where N is the value of the **Number of dimensions** parameter. You can edit the block diagram without specifying a correctly dimensioned matrix by entering an empty matrix ([]) or an undefined workspace variable in the **Value** edit field. For information about how to construct multidimensional arrays in MATLAB, see “Multidimensional Arrays”.

If you set **Source** to Input port, verify that an upstream signal supplies table data to the **T** input port. The size of table data must match the **Number of table dimensions**. For this option, the block inherits table attributes from the **T** input port.

To edit lookup tables using the Lookup Table Editor, click **Edit** (see “Edit Lookup Tables”).

Dependencies

To enable this parameter and explicitly specify table values on the dialog box, you must set **Specification** to Explicit values and **Source** to Dialog.

Programmatic Use

Block Parameter: Table

Type: character vector

Values: scalar, vector, matrix, or N-D array

Default: 'sqrt([1:11]' * [1:11])'

Name — Name of a Simulink.LookupTable object

Simulink.LookupTable object

Specify the name of a Simulink.LookupTable object. A lookup table object references Simulink

breakpoint objects. If a Simulink.LookupTable object does not exist, click the action button  and select **Create**. The corresponding parameters of the new lookup table object are automatically populated with the block information.

Dependencies

To enable this parameter, set **Specification** to Lookup table object.

Programmatic Use

Block Parameter: LookupTableObject

Type: character vector

Value: Simulink.LookupTable object

Default: ''

Algorithm

Interpolation method — Select Linear point-slope, Flat, Nearest, or Linear Lagrange

Linear point-slope (default) | Nearest | Flat | Linear Lagrange

Specify the method the block uses to interpolate table data. You can select Linear point-slope, Flat, Nearest, or Linear Lagrange. See “Interpolation Methods” for more information.

Programmatic Use

Block Parameter: InterpMethod

Type: character vector

Values: 'Flat' | 'Linear point-slope' | 'Nearest' | 'Linear Lagrange'

Default: 'Linear point-slope'

Extrapolation method — Method of handling input that falls outside the range of the breakpoint data set

Linear (default) | Clip

Specify the method the block uses to extrapolate values for all inputs that fall outside the range of the breakpoint data set. You can select **Clip** or **Linear**. See “Extrapolation Methods” for more information.

If the extrapolation method is **Linear**, the extrapolation value is calculated based on the selected linear interpolation method. For example, if the interpolation method is **Linear Lagrange**, the extrapolation method inherits the **Linear Lagrange** equation to compute the extrapolated value.

Dependencies

To enable the **Extrapolation method** parameter, set the **Interpolation method** to **Linear**.

The Interpolation Using Prelookup block does not support **Linear** extrapolation when the input or output signals specify integer or fixed-point data types.

Programmatic Use

Block Parameter: ExtrapMethod

Type: character vector

Values: 'Clip' | 'Linear'

Default: 'Linear'

Valid index input may reach last index — Allow inputs to access the last elements of table data

off (default) | on

Specify how block inputs for index (**k**) and interval fraction (**f**) access the last elements of *n*-dimensional table data. Index values are zero based.

This check box is relevant if the input index is equal to or larger than the table's last index for that dimension. Due to rounding, selecting and clearing this check box may result in differing results for the last index between simulation and code generation.

| Check Box | Block Behavior |
|-----------|---|
| on | Returns the value of the last element in a dimension of its table when: <ul style="list-style-type: none"> • k indexes the last table element in the corresponding dimension • f is 0 |
| off | Returns the value of the last element in a dimension of its table when: <ul style="list-style-type: none"> • k indexes the next-to-last table element in the corresponding dimension • f is 1 |

Dependencies

This check box is visible only when:

- **Interpolation method** is **Linear point-slope** or **Linear Lagrange**
- **Extrapolation method** is **Clip**

Tip When you select **Valid index input may reach last index** for an Interpolation Using Prelookup block, you must also select **Use last breakpoint for input at or above upper limit** for all Prelookup blocks that feed it. This action allows the blocks to use the same indexing convention when accessing the last elements of their breakpoint and table data sets.

Programmatic Use**Block Parameter:** ValidIndexMayReachLast**Type:** character vector**Values:** 'off' | 'on'**Default:** 'off'**Diagnostic for out-of-range input — Block action when input is out of range**

None (default) | Warning | Error

Specify whether to produce a warning or error when the input is out of range. Options include:

- None — Produce no response.
- Warning — Display a warning and continue the simulation.
- Error — Terminate the simulation and display an error.

Programmatic Use**Block Parameter:** DiagnosticForOutOfRangeInput**Type:** character vector**Values:** 'None' | 'Warning' | 'Error'**Default:** 'None'**Number of sub-table selection dimensions — Number of dimensions of the output computation subtable**

0 (default) | positive integer, less than or equal to the number of table dimensions

Specify the number of dimensions of the subtable that the block uses to compute the output. Follow these rules:

- To enable subtable selection, enter a positive integer.

This integer must be less than or equal to the **Number of table dimensions**.

- To disable subtable selection, enter 0 to interpolate the entire table.

For nonzero values, the subtable selection behavior is optimized for row-major layout when you select the **Math and Data Types > Use algorithms optimized for row-major array layout** configuration parameter.

For more information, see “How The Block Interpolates a Subset of Table Data” on page 1-815.

Programmatic Use**Block Parameter:** NumSelectionDims**Type:** character vector**Values:** '0' | '1' | '2' | '3' | '4' | ... | Number of table dimensions**Default:** '0'**Code generation****Remove protection against out-of-range index in generated code — Remove code that checks for out-of-range index inputs**

off (default) | on

| Check Box | Result | When to Use |
|-----------|--|----------------------------------|
| on | Generated code does not include conditional statements to check for out-of-range index inputs. When the input k or f is out of range, it may cause undefined behavior for generated code. | For code efficiency |
| off | Generated code includes conditional statements to check for out-of-range index inputs. | For safety-critical applications |

If your input is not out of range, you can select the **Remove protection against out-of-range index in generated code** check box for code efficiency. By default, this check box is cleared. For safety-critical applications, do not select this check box. If you want to select the **Remove protection against out-of-range index in generated code** check box, first check that your model inputs are in range. For example:

- 1 Clear the **Remove protection against out-of-range index in generated code** check box.
- 2 Set the **Diagnostic for out-of-range input** parameter to Error.
- 3 Simulate the model in normal mode.
- 4 If there are out-of-range errors, fix them to be in range and run the simulation again.
- 5 When the simulation no longer generates out-of-range input errors, select the **Remove protection against out-of-range index in generated code** check box.

Note When you select the **Remove protection against out-of-range index in generated code** check box and the input k or f is out of range, the behavior is undefined for generated code.

Depending on your application, you can run the following Model Advisor checks to verify the usage of this check box:

- **By Product > Embedded Coder > Identify lookup table blocks that generate expensive out-of-range checking code**
- **By Product > Simulink Check > Modeling Standards > DO-178C/DO-331 Checks > Check usage of lookup table blocks**

For more information about the Model Advisor, see “Run Model Advisor Checks”.

Additionally, to determine if it is safe to select this check box, if you have a Simulink Design Verifier license, consider using the “Detect Block Input Range Violations” (Simulink Design Verifier) check.

This check box has no effect on the generated code when one of the following is true:

- The Prelookup block feeds index values to the Interpolation Using Prelookup block.

Because index values from the Prelookup block are always valid, no check code is necessary.

- The data type of the input k restricts the data to valid index values.

For example, unsigned integer data types guarantee nonnegative index values. Therefore, unsigned input values of k do not require check code for negative values.

Programmatic Use**Block Parameter:** RemoveProtectionIndex**Type:** character vector**Values:** 'off' | 'on'**Default:** 'off'**Sample time — Specify sample time as a value other than -1**`-1 (default) | scalar | vector`

Specify the sample time as a value other than -1. For more information, see “Specify Sample Time”.

Dependencies

This parameter is not visible unless it is explicitly set to a value other than -1. To learn more, see “Blocks for Which Sample Time Is Not Recommended”.

Programmatic Use**Block Parameter:** SampleTime**Type:** character vector**Values:** scalar or vector**Default:** '-1'**Data Types****Table data — Data type of table values**`Inherit: Same as output (default) | Inherit: Inherit from 'Table data' | double | single | int8 | uint8 | int16 | uint16 | int32 | uint32 | int64 | uint64 | fixdt(1,16) | fixdt(1,16,0) | fixdt(1,16,2^0,0) | <data type expression>`

Specify the table data type. You can set it to:

- A rule that inherits a data type, for example, `Inherit: Same as output`
- The name of a built-in data type, for example, `single`
- The name of a data type object, for example, a `Simulink.NumericType` object
- An expression that evaluates to a data type, for example, `fixdt(1,16,0)`

Click the **Show data type assistant** button  to display the **Data Type Assistant**, which helps you set the table data type.

Tip Specify a table data type different from the output data type for these cases:

- Lower memory requirement for storing table data that uses a smaller type than the output signal
 - Sharing of prescaled table data between two Interpolation Using Prelookup blocks with different output data types
 - Sharing of custom storage table data in Simulink Coder generated code for blocks with different output data types
-

Programmatic Use**Block Parameter:** TableDataTypeStr**Type:** character vector

Values: 'Inherit: Inherit from table data' | 'Inherit: Same as output' | 'double' | 'single' | 'int8' | 'uint8' | 'int16' | 'uint16' | 'int32' | 'uint32' | 'int64' | 'uint64' | 'fixdt(1,16)' | 'fixdt(1,16,0)' | 'fixdt(1,16,2^0,0)' | '<data type expression>'

Default: 'Inherit: Same as input'**Table minimum — Minimum value of table data**

[] (default) | scalar

Specify the minimum value for table data as a finite, real, double, scalar. The default value is [] (unspecified).

Programmatic Use**Block Parameter:** TableMin**Type:** character vector**Values:** scalar**Default:** '[]'**Table maximum — Maximum value of table data**

[] (default) | scalar

Specify the maximum value for table data as a finite, real, double, scalar. The default value is [] (unspecified).

Programmatic Use**Block Parameter:** TableMax**Type:** character vector**Values:** scalar**Default:** '[]'**Intermediate results — Data type of intermediate results**

Inherit: Inherit via internal rule (default) | Inherit: Same as output | double | single | int8 | uint8 | int16 | uint16 | int32 | uint32 | int64 | uint64 | fixdt(1,16) | fixdt(1,16,0) | fixdt(1,16,2^0,0) | <data type expression>

Specify the intermediate results data type. You can set it to:

- A rule that inherits a data type, for example, `Inherit: Same as output`
- The name of a built-in data type, for example, `single`
- The name of a data type object, for example, a `Simulink.NumericType` object
- An expression that evaluates to a data type, for example, `fixdt(1,16,0)`

Click the **Show data type assistant** button  to display the **Data Type Assistant**, which helps you set the data type attributes. For more information, see “Specify Data Types Using Data Type Assistant”.

Tip Use this parameter to specify higher precision for internal computations than for table data or output data.

Programmatic Use**Block Parameter:** IntermediateResultsDataTypeStr**Type:** character vector

Values: 'Inherit: Inherit via internal rule' | 'Inherit: Same as output' | 'double' | 'single' | 'int8' | 'uint8' | 'int16' | 'uint16' | 'int32' | 'uint32' | 'int64' | 'uint64' | 'fixdt(1,16)' | 'fixdt(1,16,0)' | 'fixdt(1,16,2^0,0)' | '<data type expression>'

Default: 'Inherit: Same as input'**Output — Output data type**

Inherit: Inherit from 'Table data' (default) | Inherit: Inherit via back propagation | double | single | int8 | uint8 | int16 | uint16 | int32 | uint32 | int64 | uint64 | fixdt(1,16) | fixdt(1,16,0) | fixdt(1,16,2^0,0) | <data type expression>

Specify the output data type. You can set it to:

- A rule that inherits a data type, for example, Inherit: Inherit via back propagation
- The name of a built-in data type, for example, single
- The name of a data type object, for example, a Simulink.NumericType object
- An expression that evaluates to a data type, for example, fixdt(1,16,0)

Click the **Show data type assistant** button  to display the **Data Type Assistant**, which helps you set the output data type.

See “Control Data Types of Signals” in the *Simulink User's Guide* for more information.

Programmatic Use**Block Parameter:** OutDataTypeStr**Type:** character vector

Values: 'Inherit: Inherit via back propagation' | 'Inherit: Inherit from table data' | 'double' | 'single' | 'int8' | 'uint8' | 'int16' | 'uint16' | 'int32' | 'uint32' | 'int64' | 'uint64' | 'fixdt(1,16,0)' | 'fixdt(1,16,2^0,0)' | 'fixdt(1,16,2^0,0)' | '<data type expression>'

Default: 'Inherit: Inherit from table data'**Output minimum — Minimum value the block can output**

[] (default) | scalar

Specify the minimum value that the block should output as a finite, real-valued scalar. The default value is [] (unspecified). Simulink software uses this value to perform:

- Parameter range checking (see “Specify Minimum and Maximum Values for Block Parameters”).
- Simulation range checking (see “Specify Signal Ranges”).
- Automatic scaling of fixed-point data types.
- Optimization of the code that you generate from the model. This optimization can remove algorithmic code and affect the results of some simulation modes such as SIL or external mode. For more information, see “Optimize using the specified minimum and maximum values” (Embedded Coder).

Programmatic Use**Block Parameter:** OutMin

Type: character vector

Values: scalar

Default: ' [] '

Output maximum — Maximum value the block can output

[] (default) | scalar

Specify the maximum value that the block should output as a finite, real-valued scalar. The default value is [] (unspecified). Simulink software uses this value to perform:

- Parameter range checking (see “Specify Minimum and Maximum Values for Block Parameters”).
- Simulation range checking (see “Specify Signal Ranges”).
- Automatic scaling of fixed-point data types.
- Optimization of the code that you generate from the model. This optimization can remove algorithmic code and affect the results of some simulation modes such as SIL or external mode. For more information, see “Optimize using the specified minimum and maximum values” (Embedded Coder).

Programmatic Use

Block Parameter: OutMax

Type: character vector

Values: scalar

Default: ' [] '

Internal rule priority — Internal rule for intermediate calculations

Speed (default) | Precision

Specify the internal rule for intermediate calculations. Select Speed for faster calculations. If you do, a loss of accuracy might occur, usually up to 2 bits.

Programmatic Use

Block Parameter: InternalRulePriority

Type: character vector

Values: 'Speed' | 'Precision'

Default: 'Speed'

Lock data type settings against changes by the fixed-point tools — Prevent fixed-point tools from overriding data types

off (default) | on

Select this parameter to prevent the fixed-point tools from overriding the data types you specify on this block. For more information, see “Lock the Output Data Type Setting” (Fixed-Point Designer).

Programmatic Use

Block Parameter: LockScale

Type: character vector

Values: 'off' | 'on'

Default: 'off'

Integer rounding mode — Rounding mode for fixed-point operations

Floor (default) | Convergent | Ceiling | Nearest | Round | Simplest | Zero

Specify the rounding mode for fixed-point operations. For more information, see “Rounding” (Fixed-Point Designer).

Block parameters always round to the nearest representable value. To control the rounding of a block parameter, enter an expression using a MATLAB rounding function in the mask field.

Programmatic Use

Block Parameter: RndMeth

Type: character vector

Values: 'Ceiling' | 'Convergent' | 'Floor' | 'Nearest' | 'Round' | 'Simplest' | 'Zero'

Default: 'Floor'

Saturate on integer overflow — Method of overflow action

off (default) | on

Specify whether overflows saturate or wrap.

| Action | Rationale | Impact on Overflows | Example |
|-------------------------------------|---|---|---|
| Select this check box (on). | Your model has possible overflow, and you want explicit saturation protection in the generated code. | Overflows saturate to either the minimum or maximum value that the data type can represent. | The maximum value that the <code>int8</code> (signed, 8-bit integer) data type can represent is 127. Any block operation result greater than this maximum value causes overflow of the 8-bit integer. With the check box selected, the block output saturates at 127. Similarly, the block output saturates at a minimum output value of -128. |
| Do not select this check box (off). | You want to optimize efficiency of your generated code. You want to avoid overspecifying how a block handles out-of-range signals. For more information, see “Troubleshoot Signal Range Errors”. | Overflows wrap to the appropriate value that is representable by the data type. | The maximum value that the <code>int8</code> (signed, 8-bit integer) data type can represent is 127. Any block operation result greater than this maximum value causes overflow of the 8-bit integer. With the check box cleared, the software interprets the overflow-causing value as <code>int8</code> , which can produce an unintended result. For example, a block result of 130 (binary 1000 0010) expressed as <code>int8</code> , is -126. |

When you select this check box, saturation applies to every internal operation on the block, not just the output, or result. Usually, the code generation process can detect when overflow is not possible. In this case, the code generator does not produce saturation code.

Programmatic Use

Block Parameter: SaturateOnIntegerOverflow

Type: character vector

Values: 'off' | 'on'
Default: 'off'

Block Characteristics

| | |
|---------------------------------|---|
| Data Types | double fixed point integer single |
| Direct Feedthrough | yes |
| Multidimensional Signals | yes |
| Variable-Size Signals | no |
| Zero-Crossing Detection | no |

Extended Capabilities

C/C++ Code Generation

Generate C and C++ code using Simulink® Coder™.

PLC Code Generation

Generate Structured Text code using Simulink® PLC Coder™.

Simulink PLC Coder™ has limited support for lookup table blocks. The coder does not support:

- Number of dimensions greater than 2
- Cubic spline interpolation method
- Begin index search using a previous index mode
- Cubic spline extrapolation method

Fixed-Point Conversion

Design and simulate fixed-point systems using Fixed-Point Designer™.

See Also

Prelookup

Topics

“About Lookup Table Blocks”

“Anatomy of a Lookup Table”

“Enter Breakpoints and Table Data”

“Guidelines for Choosing a Lookup Table”

“Column-Major Layout to Row-Major Layout Conversion of Models with Lookup Table Blocks” (Simulink Coder)

“Interpolation with Subtable Selection Algorithm for Row-Major Array Layout” (Simulink Coder)

Introduced in R2006b

Interpreted MATLAB Function

Apply MATLAB function or expression to input

Library: Simulink / User-Defined Functions

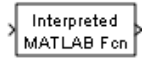

Description

The Interpreted MATLAB Function block applies the specified MATLAB function or expression to the input. The output of the function must match the output dimensions of the block.

Some valid expressions for this block are:

```
sin
atan2(u(1), u(2))
u(1)^u(2)
```

Note This block is slow because it calls the MATLAB parser during each integration step. Consider using built-in blocks (such as the Math Function block) instead. Alternatively, you can write the function as a MATLAB S-function or MEX-file S-function, then access it using the S-Function block.

Ports

Input

In — Input of a Interpreted MATLAB function

scalar | vector | matrix

The Interpreted MATLAB Function block accepts one real or complex input of type `double` and generates real or complex output of type `double`, depending on the setting of the **Output signal type** parameter.

Data Types: `double`

Output

Out — Output of a Interpreted MATLAB function

scalar | vector | matrix

The Interpreted MATLAB Function block accepts one real or complex input of type `double` and generates real or complex output of type `double`, depending on the setting of the **Output signal type** parameter.

Data Types: `double`

Parameters

MATLAB Function — Specify the function or expression

function (default)

Specify the function or expression. If you specify a function only, it is not necessary to include the input argument in parentheses.

Output dimensions — Specify the dimensions of the block output signal

scalar | matrix | vector | inherited

Specify the dimensions of the block output signal, for example, 2 for a two-element vector. The output dimensions must match the dimensions of the value returned by the function or expression in the **MATLAB function** field.

Specify -1 to inherit the dimensions from the output of the specified function or expression. To determine the output dimensions, Simulink runs the function or expression once before simulation starts.

Note If you specify -1 for this parameter and your function has persistent variables, then the variables might update before the simulation starts. If you need to use persistent variables, consider setting this parameter to a value other than -1.

Output signal type — Specify the block output signal type

auto (default) | real | complex

Specify the output signal type of the block as real, complex, or auto. A value of auto sets the output type to be the same as the type of the input signal.

Collapse 2-D results to 1-D — Output a 2-D array as a 1-D array

off (default) | on

Select this check box to output a 2-D array as a 1-D array containing the 2-D array's elements in column-major order.

Sample time — Specify sample time in the block

scalar

Note This parameter is not visible in the block dialog box unless it is explicitly set to a value other than -1. To learn more, see “Blocks for Which Sample Time Is Not Recommended”.

Block Characteristics

| | |
|---------------------------------|--------|
| Data Types | double |
| Direct Feedthrough | yes |
| Multidimensional Signals | no |
| Variable-Size Signals | no |

| | |
|------------------------------------|----|
| Zero-Crossing Detection | no |
|------------------------------------|----|

See Also

MATLAB Function | MATLAB System

Introduced in R2011a

Interval Test

Determine if signal is in specified interval

Library: Simulink / Logic and Bit Operations



Description

The Interval Test block outputs true (1) if the input is between the values specified by the **Lower limit** and **Upper limit** parameters. The block outputs false (0) if the input is outside those values. The output of the block when the input is equal to the **Lower limit** or the **Upper limit** is determined by whether you select the **Interval closed on left** and **Interval closed on right** check boxes.

Ports

Input

Port_1 – Input signal

scalar | vector | matrix | N-D array

Input signal, specified as a scalar, vector, matrix, or N-D array.

Limitations

When the input signal is an enumerated type, the **Upper limit** and **Lower limit** values must be of the same enumerated type.

Data Types: single | double | int8 | int16 | int32 | int64 | uint8 | uint16 | uint32 | uint64 | Boolean | fixed point | enumerated

Output

Port_1 – Output signal

scalar | vector | matrix | N-D array

Output signal indicating whether the input values fall within the specified interval. You can specify the **Output data type** as boolean or uint8.

Data Types: uint8 | Boolean

Parameters

Interval closed on right – Include upper limit value

on (default) | off

When you select this check box, the **Upper limit** is included in the interval for which the block outputs true (1).

Programmatic Use

Block Parameter: IntervalClosedRight

Type: character vector
Values: 'on' | 'off'
Default: 'on'

Upper limit – Upper limit of interval

0.5 (default) | scalar | vector | matrix | N-D array

The upper limit of the interval for which the block outputs true (1).

Programmatic Use

Block Parameter: uplimit

Type: character vector

Values: scalar | vector | matrix | N-D array

Default: '0.5'

Interval closed on left – Include lower limit value

on (default) | off

When you select this check box, the **Lower limit** is included in the interval for which the block outputs true (1).

Programmatic Use

Block Parameter: IntervalClosedLeft

Type: character vector

Values: 'on' | 'off'

Default: 'on'

Lower limit – Lower limit of interval

-0.5 (default) | scalar | vector | matrix | N-D array

The lower limit of the interval for which the block outputs true (1).

Programmatic Use

Block Parameter: lowlimit

Type: character vector

Values: scalar | vector | matrix | N-D array

Default: '-0.5'

Output data type – Output data type

boolean (default) | uint8

Specify the output data type as boolean or uint8.

Programmatic Use

Block Parameter: OutDataTypeStr

Type: character vector

Values: 'boolean' | 'uint8'

Default: 'boolean'

Block Characteristics

| | |
|---------------------------|--|
| Data Types | Boolean double enumerated fixed point integer single |
| Direct Feedthrough | yes |

| | |
|---------------------------------|-----|
| Multidimensional Signals | yes |
| Variable-Size Signals | no |
| Zero-Crossing Detection | no |

Extended Capabilities

C/C++ Code Generation

Generate C and C++ code using Simulink® Coder™.

HDL Code Generation

Generate Verilog and VHDL code for FPGA and ASIC designs using HDL Coder™.

HDL Coder provides additional configuration options that affect HDL implementation and synthesized logic.

HDL Architecture

| Architecture | Description |
|------------------|--|
| Module (default) | Generate code for the subsystem and the blocks within the subsystem. |
| BlackBox | Generate a black box interface. The generated HDL code includes only the input/output port definitions for the subsystem. Therefore, you can use a subsystem in your model to generate an interface to existing, manually written HDL code. The black-box interface generation for subsystems is similar to the Model block interface generation without the clock signals. |
| No HDL | Remove the subsystem from the generated code. You can use the subsystem in simulation, however, treat it as a “no-op” in the HDL code. |

Black Box Interface Customization

For the BlackBox architecture, you can customize port names and set attributes of the external component interface. See “Customize Black Box or HDL Cosimulation Interface” (HDL Coder).

HDL Block Properties

| General | |
|----------------------------|---|
| AdaptivePipelining | Automatic pipeline insertion based on the synthesis tool, target frequency, and multiplier word-lengths. The default is <code>inherit</code> . See also “AdaptivePipelining” (HDL Coder). |
| BalanceDelays | Detects introduction of new delays along one path and inserts matching delays on the other paths. The default is <code>inherit</code> . See also “BalanceDelays” (HDL Coder). |
| ClockRatePipelining | Insert pipeline registers at a faster clock rate instead of the slower data rate. The default is <code>inherit</code> . See also “ClockRatePipelining” (HDL Coder). |

| General | |
|----------------------------------|--|
| ConstrainedOutputPipeline | Number of registers to place at the outputs by moving existing delays within your design. Distributed pipelining does not redistribute these registers. The default is 0. For more details, see “ConstrainedOutputPipeline” (HDL Coder). |
| DistributedPipelining | Pipeline register distribution, or register retiming. The default is off. See also “DistributedPipelining” (HDL Coder). |
| DSPStyle | Synthesis attributes for multiplier mapping. The default is none. See also “DSPStyle” (HDL Coder). |
| FlattenHierarchy | Remove subsystem hierarchy from generated HDL code. The default is inherit. See also “FlattenHierarchy” (HDL Coder). |
| InputPipeline | Number of input pipeline stages to insert in the generated code. Distributed pipelining and constrained output pipelining can move these registers. The default is 0. For more details, see “InputPipeline” (HDL Coder). |
| OutputPipeline | Number of output pipeline stages to insert in the generated code. Distributed pipelining and constrained output pipelining can move these registers. The default is 0. For more details, see “OutputPipeline” (HDL Coder). |
| SharingFactor | Number of functionally equivalent resources to map to a single shared resource. The default is 0. See also “Resource Sharing” (HDL Coder). |
| StreamingFactor | Number of parallel data paths, or vectors, that are time multiplexed to transform into serial, scalar data paths. The default is 0, which implements fully parallel data paths. See also “Streaming” (HDL Coder). |

If this block is not the DUT, the block property settings in the **Target Specification** tab are ignored. In the HDL Workflow Advisor, if you use the **IP Core Generation** workflow, these target specification block property values are saved with the model. If you specify these target specification block property values using `hdlset_param`, when you open HDL Workflow Advisor, the fields are populated with the corresponding values.

| Target Specification | |
|-----------------------------------|---|
| AdditionalTargetInterfaces | <p>Additional target interfaces, specified as a character vector.</p> <p>To save this block property on the model, in the Set Target Interface task of the IP Core Generation workflow, corresponding to the DUT ports that you want to add more interfaces, select Add more.... You can then add more interfaces in the Add New Target Interfaces dialog box. Specify the type of interface, number of additional interfaces, and a unique name for each additional interface.</p> <p>Values: ' ' (default) cell array of character vectors</p> <p>Example: <code>'{'AXI4-Stream', 'InterfaceID', 'AXI4-Stream1'}'</code></p> |

| Target Specification | |
|---|---|
| ProcessorFPGASynchronization | <p>Processor/FPGA synchronization mode, specified as a character vector.</p> <p>To save this block property on the model, specify the Processor/FPGA Synchronization in the Set Target Interface task of the IP Core Generation workflow.</p> <p>Values: Free running (default) Coprocessing - blocking</p> <p>Example: 'Free running'</p> |
| TestPointMapping | <p>To save this block property on the model, specify the mapping of test point ports to target platform interfaces in the Set Target Interface task of the IP Core Generation workflow.</p> <p>Values: '' (default) cell array of character vectors</p> <p>Example: '{{ 'TestPoint', 'AXI4-Lite', 'x"108"' }}</p> |
| TunableParameterMapping | <p>To save this block property on the model, specify the mapping of tunable parameter ports to target platform interfaces in the Set Target Interface task of the IP Core Generation workflow.</p> <p>Values: '' (default) cell array of character vectors</p> <p>Example: '{{ 'myParam', 'AXI4-Lite', 'x"108"' }}</p> |
| AXI4RegisterReadback | <p>To save this block property on the model, specify whether you want to enable readback on AXI4 subordinate write registers in the Generate RTL Code and IP Core task of the IP Core Generation workflow. To learn more, see “Model Design for AXI4 Slave Interface Generation” (HDL Coder).</p> <p>Values: 'off' (default) 'on'</p> |
| AXI4SlaveIDWidth | <p>To save this block property on the model, specify the number of AXI manager interfaces that you want to connect the DUT IP core to by using the AXI4 Slave ID Width setting in the Generate RTL Code and IP Core task of the IP Core Generation workflow. To learn more, see “Define Multiple AXI Master Interfaces in Reference Designs to access DUT AXI4 Slave Interface” (HDL Coder).</p> <p>Values: 'off' (default) 'on'</p> |
| AXI4SlavePortToPipelineRegisterRatio | <p>To save this block property on the model, specify the number of AXI4 subordinate ports for which you want a pipeline register to be inserted by using the AXI4 Slave port to pipeline register ratio setting in the Generate RTL Code and IP Core task of the IP Core Generation workflow. To learn more, see “Model Design for AXI4 Slave Interface Generation” (HDL Coder).</p> <p>Values: 'off' (default) 'on'</p> |

| Target Specification | |
|----------------------------------|--|
| GenerateDefaultAXI4 Slave | <p>To save this block property on the model, specify whether you want to disable generation of default AXI4 subordinate interfaces in the Generate RTL Code and IP Core task of the IP Core Generation workflow.</p> <p>Values: 'on' (default) 'off'</p> |
| IPCoreAdditionalFiles | <p>Verilog or VHDL files for black boxes in your design. Specify the full path to each file, and separate file names with a semicolon (;).</p> <p>You can set this property in the HDL Workflow Advisor, in the Additional source files field.</p> <p>Values: '' (default) character vector</p> <p>Example: 'C:\myprojfiles \led_blinking_file1.vhd;C:\myprojfiles \led_blinking_file2.vhd;'</p> |
| IPCoreName | <p>IP core name, specified as a character vector.</p> <p>You can set this property in the HDL Workflow Advisor, in the IP core name field. If this property is set to the default value, the HDL Workflow Advisor constructs the IP core name based on the name of the DUT.</p> <p>Values: '' (default) character vector</p> <p>Example: 'my_model_name'</p> |
| IPCoreVersion | <p>IP core version number, specified as a character vector.</p> <p>You can set this property in the HDL Workflow Advisor, in the IP core version field. If this property is set to the default value, the HDL Workflow Advisor sets the IP core version.</p> <p>Values: '' (default) character vector</p> <p>Example: '1.3'</p> |
| IPDataCaptureBuffer Size | <p>FPGA Data Capture buffer size, specified as a character vector. Use FPGA Data Capture to observe signals in a design when running on an FPGA.</p> <p>The buffer size uses values that are $128 \cdot 2^n$, where n is an integer. By default, the buffer size is 128 (n=0). The maximum value of n is 13, which means that the maximum value for buffer size is 1048576 ($=128 \cdot 2^{13}$).</p> <p>Values: '' (default) character vector</p> <p>Example: '1.3'</p> |

PLC Code Generation

Generate Structured Text code using Simulink® PLC Coder™.

Fixed-Point Conversion

Design and simulate fixed-point systems using Fixed-Point Designer™.

See Also

Interval Test Dynamic

Introduced before R2006a

Interval Test Dynamic

Determine if signal is in specified interval

Library: Simulink / Logic and Bit Operations

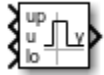

Description

The Interval Test Dynamic block outputs true (1) if the input is between the values of the external signals **up** and **lo**. The block outputs false (0) if the input is outside those values. To control how the block handles input values that are equal to the signal **lo** or the signal **up**, use the **Interval closed on left** and **Interval closed on right** check boxes.

Ports

Input

up — Upper limit of interval

scalar | vector | matrix | N-D array

Upper limit of interval, specified as a scalar, vector, matrix, or N-D array.

Limitations

When the input signal is an enumerated type, the **up** and **lo** signals must be of the same enumerated type.

Data Types: single | double | int8 | int16 | int32 | int64 | uint8 | uint16 | uint32 | uint64 | Boolean | fixed point | enumerated

u — Input signal

scalar | vector | matrix | N-D array

Input signal, specified as a scalar, vector, matrix, or N-D array.

Limitations

When the input signal is an enumerated type, the **up** and **lo** signals must be of the same enumerated type.

Data Types: single | double | int8 | int16 | int32 | int64 | uint8 | uint16 | uint32 | uint64 | Boolean | fixed point | enumerated

lo — Lower limit of interval

scalar | vector | matrix | N-D array

Lower limit of interval, specified as a scalar, vector, matrix, or N-D array.

Limitations

When the input signal is an enumerated type, the **up** and **lo** signals must be of the same enumerated type.

Data Types: `single` | `double` | `int8` | `int16` | `int32` | `int64` | `uint8` | `uint16` | `uint32` | `uint64` | `Boolean` | `fixed point` | `enumerated`

Output

y — Output signal

scalar | vector | matrix | N-D array

Output signal indicating whether the input values fall within the specified interval. You can specify the **Output data type** as `boolean` or `uint8`.

Data Types: `uint8` | `Boolean`

Parameters

Interval closed on right — Include upper limit value

`on` (default) | `off`

When you select this check box, the value of the signal connected to the **up** input port is included in the interval for which the block outputs true (1).

Programmatic Use

Block Parameter: `IntervalClosedRight`

Type: character vector

Values: `'on'` | `'off'`

Default: `'on'`

Interval closed on left — Include lower limit value

`on` (default) | `off`

When you select this check box, the value of the signal connected to the **lo** input port is included in the interval for which the block outputs true (1).

Programmatic Use

Block Parameter: `IntervalClosedLeft`

Type: character vector

Values: `'on'` | `'off'`

Default: `'on'`

Output data type — Output data type

`boolean` (default) | `uint8`

Specify the output data type as `boolean` or `uint8`.

Programmatic Use

Block Parameter: `OutDataTypeStr`

Type: character vector

Values: `'boolean'` | `'uint8'`

Default: `'boolean'`

Block Characteristics

| | |
|---------------------------|--|
| Data Types | <code>Boolean</code> <code>double</code> <code>enumerated</code> <code>fixed point</code> <code>integer</code> <code>single</code> |
| Direct Feedthrough | yes |

| | |
|---------------------------------|-----|
| Multidimensional Signals | yes |
| Variable-Size Signals | no |
| Zero-Crossing Detection | no |

Extended Capabilities

C/C++ Code Generation

Generate C and C++ code using Simulink® Coder™.

HDL Code Generation

Generate Verilog and VHDL code for FPGA and ASIC designs using HDL Coder™.

HDL Coder provides additional configuration options that affect HDL implementation and synthesized logic.

HDL Architecture

This block has a single, default HDL architecture.

HDL Block Properties

| | |
|----------------------------------|--|
| ConstrainedOutputPipeline | Number of registers to place at the outputs by moving existing delays within your design. Distributed pipelining does not redistribute these registers. The default is 0. For more details, see “ConstrainedOutputPipeline” (HDL Coder). |
| InputPipeline | Number of input pipeline stages to insert in the generated code. Distributed pipelining and constrained output pipelining can move these registers. The default is 0. For more details, see “InputPipeline” (HDL Coder). |
| OutputPipeline | Number of output pipeline stages to insert in the generated code. Distributed pipelining and constrained output pipelining can move these registers. The default is 0. For more details, see “OutputPipeline” (HDL Coder). |

PLC Code Generation

Generate Structured Text code using Simulink® PLC Coder™.

Fixed-Point Conversion

Design and simulate fixed-point systems using Fixed-Point Designer™.

See Also

Interval Test

Introduced before R2006a

IsSymmetric

Check if matrix is symmetric or skew-symmetric

Library: Simulink / Matrix Operations



Description

The IsSymmetric block determines if the input is a symmetric or skew-symmetric matrix.

Ports

Input

Port_1 — Input matrix

matrix

Input, specified as a matrix.

Data Types: single | double | half | int8 | int16 | int32 | int64 | uint8 | uint16 | uint32 | uint64 | fixed point

Output

Port_1 — Symmetric or skew-symmetric matrix

real scalar boolean

A symmetric or skew-symmetric matrix, returned as a real scalar boolean.

Data Types: Boolean

Parameters

Mode — Whether matrix is symmetric or skew-symmetric

Symmetric (default) | Skew-Symmetric

Identify the matrix as Symmetric or Skew-Symmetric.

Programmatic Use

Block Parameter: Mode

Type: character vector

Values: 'Symmetric' | 'Skew-Symmetric'

Default: 'Symmetric'

Block Characteristics

| | |
|-------------------|---|
| Data Types | Boolean double fixed point half integer ^a single |
|-------------------|---|

| | |
|---------------------------------|----|
| Direct Feedthrough | no |
| Multidimensional Signals | no |
| Variable-Size Signals | no |
| Zero-Crossing Detection | no |

a. This block only supports signed integer types for the skew-symmetric mode.

Extended Capabilities

C/C++ Code Generation

Generate C and C++ code using Simulink® Coder™.

See Also

Cross Product | Hermitian Transpose | Identity Matrix | IsTriangular | Matrix Square | Transpose

Topics

“Compatible Array Sizes for Basic Operations”
MATLAB Matrix Operations

Introduced in R2021b

IsTriangular

Check if matrix is upper or lower triangular

Library: Simulink / Matrix Operations



Description

The IsTriangular block determines if the input is an upper triangular or lower triangular matrix.

Ports

Input

Port_1 — Input matrix

matrix

Input matrix, specified as a matrix.

Data Types: single | double | half | int8 | int16 | int32 | int64 | uint8 | uint16 | uint32 | uint64 | Boolean | fixed point

Output

Port_2 — Upper triangular or lower triangular matrix

real scalar boolean

Upper triangular or lower triangular matrix, specified scalar, returned as a real scalar boolean.

Data Types: Boolean

Parameters

Mode — Whether matrix is upper triangular or lower triangular

Upper (default) | Lower

Identify the matrix as Upper or Lower.

Programmatic Use

Block Parameter: Mode

Type: character vector

Values: 'Upper' | 'Lower'

Default: 'Upper'

Block Characteristics

| | |
|-------------------|--|
| Data Types | Boolean double fixed point half integer single |
|-------------------|--|

| | |
|---------------------------------|----|
| Direct Feedthrough | no |
| Multidimensional Signals | no |
| Variable-Size Signals | no |
| Zero-Crossing Detection | no |

Extended Capabilities

C/C++ Code Generation

Generate C and C++ code using Simulink® Coder™.

See Also

Cross Product | Hermitian Transpose | Identity Matrix | Matrix Square | IsSymmetric | Transpose

Topics

“Compatible Array Sizes for Basic Operations”
MATLAB Matrix Operations

Introduced in R2021b

Knob

Change parameter or variable value using knob with customizable appearance

Library: Simulink / Dashboard / Customizable Blocks



Description

Use the Knob block to tune the value of a variable or block parameter to during simulation. When you use the Knob block in the Customizable Blocks library, you can customize the appearance of the block so that it looks like a control in a real system. You can modify the range and tick values on the Knob block to fit the desired range for the value you want to tune. Use the Knob block with other dashboard blocks to create an interactive dashboard to control your model.

Customize Knob Blocks

When you add a Knob block to your model, the block is preconfigured with a default design. You can use the block with the default design or customize the appearance of the block using design mode. You can enter design mode in one of three ways after selecting the block:

- On the **Knob** tab, under **Design**, click **Edit**.
- In the **Property Inspector**, on the **Design** tab, click **Edit Design**.
- Pause on the ellipsis that appears above the block and click the **Edit Custom Block** button.

In design mode, you have access to block parameters and settings that allow you to design the appearance of the block. You can use the toolbar above the block to change the background image or needle image and to set the opacity and color for the scale, tick labels, and value bar. To design the appearance of the scale, select the aspect of the scale you want to edit in the middle section of the toolbar. Use the controls on the right of the toolbar to set the color and opacity. You can also click and drag to reposition the needle or the scale.

For fine control of the block design, use the **Design** tab in the **Property Inspector**. You can use the **Property Inspector** to enter exact values for design settings. The **Design** tab also includes design parameters that are not available through the toolbar or interactive editing, such as the ability to add a foreground image to the block.

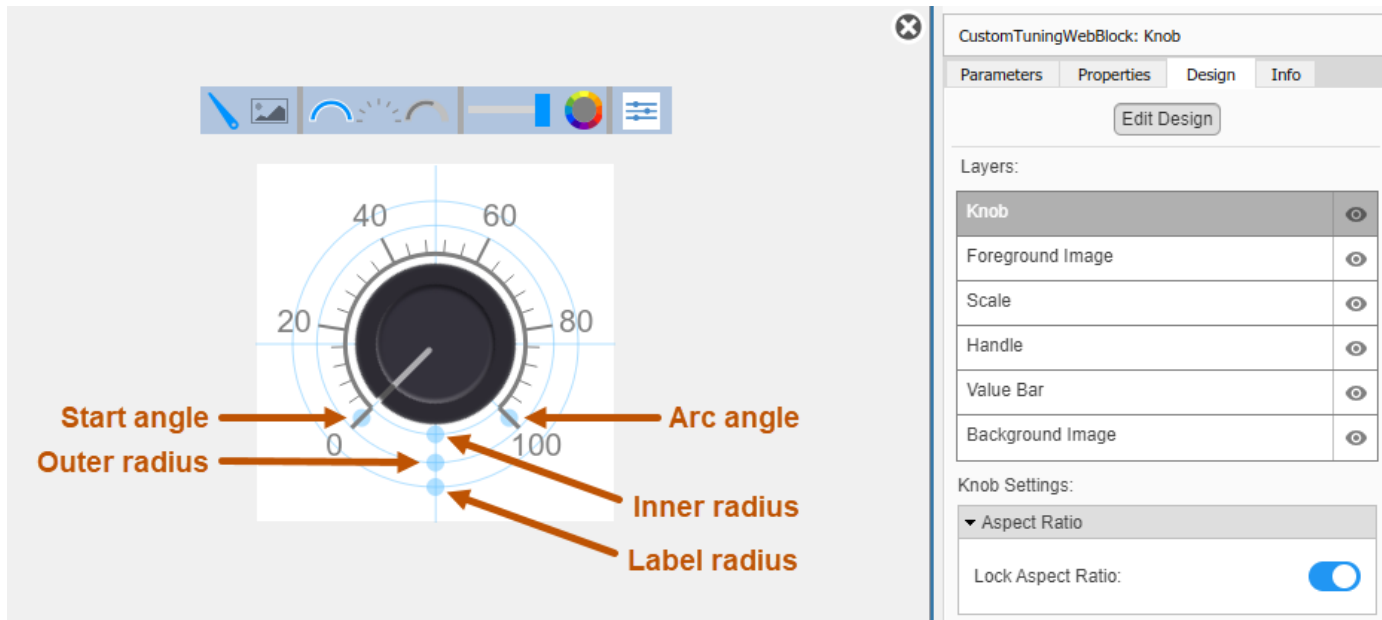

When you finish editing the design, click **Exit** in the upper-right of the canvas to exit design mode.

Connect Dashboard Blocks

Dashboard blocks do not use ports to connect to model elements. To connect dashboard blocks to variables and block parameters, use connect mode. Connect mode facilitates the process of connecting dashboard blocks in your model, especially when you want to connect multiple blocks at once. To connect a single dashboard block, you can also use the **Connection** table in the block dialog box.

Tip You can modify dashboard block connections in your model during normal and accelerator mode simulations.

Note Dashboard blocks cannot connect to variables until you update the model diagram. To connect dashboard blocks to variables or modify variable values between opening your model and running a simulation, update the model diagram using **Ctrl+D**.

To enter connect mode, select the block. Then, on the block tab, click **Connect**. In connect mode, when you select one or more blocks, a list of parameters and variables available for connection appears. Select a variable or parameter from the list to connect to the selected dashboard block.

When the value of the selected variable or block parameter is nonscalar, use the text box at the bottom of the **Connection** table to specify the element you want to connect to the dashboard block. To connect to an element of a vector, matrix, or array, specify the element index, for example, 3 or (1, 3). To connect to an element in a bus or structure, specify the element in the context of the bus or structure hierarchy by using dots to indicate different levels in the hierarchy, and omit the top level. For example, specify a.b to connect to scalar element b of the structure or bus a nested inside the selected composite variable or parameter.

To connect another dashboard block, pause on another dashboard block and click the **Connect** button above it. Then, make a selection of signals and blocks in your model and choose a model element to connect.

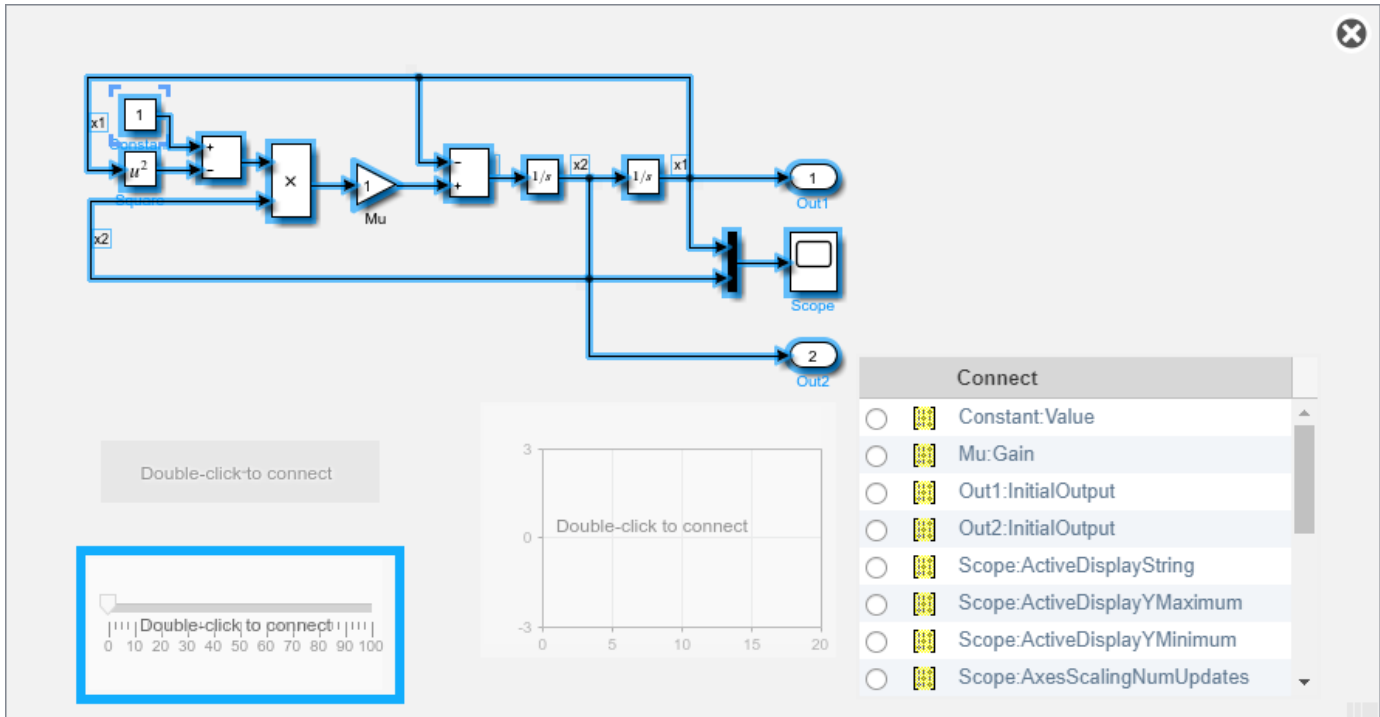

When you finish connecting the dashboard blocks in your model, on the block tab, click **Done Connecting**.

Tip You can hide the message shown on unconnected blocks using the `set_param` function with the `ShowInitialText` block parameter. The message also disappears when you connect the block.

Parameter Logging

Tunable parameters connected to dashboard blocks are logged to the Simulation Data Inspector, where you can view the parameter values along with logged signal data. You can access logged parameter data in the MATLAB workspace by exporting the parameter data from the Simulation Data Inspector by using the UI or the `Simulink.sdi.exportRun` function. For more information about exporting data using the Simulation Data Inspector UI, see “Export Data to the Workspace or a File”. The parameter data is stored in a `Simulink.SimulationData.Parameter` object, accessible as an element in the exported `Simulink.SimulationData.Dataset`.

Limitations

- Except for the Dashboard Scope block and the Display block, dashboard blocks can only connect to real scalar signals.
- The toolbar does not support blocks that are inside a panel.
- You cannot use the **Connection** table in the block dialog to connect a dashboard block to a block that is commented out. When you connect a dashboard block to a commented block using connect

mode, the dashboard block does not display the connected value until the you uncomment the block.

- Dashboard blocks cannot connect to model elements inside referenced models.
- When you simulate a model hierarchy, dashboard blocks inside referenced models do not update.
- Dashboard blocks do not support rapid accelerator simulation.
- When you connect a dashboard block to a variable or parameter during simulation, the data for that variable or parameter is not logged to the Simulation Data Inspector. To log variable and parameter data to the Simulation Data Inspector, connect the dashboard block to the variable or parameter prior to simulation.
- When you simulate a model in external mode with the **Default parameter behavior** set to **Inlined**, dashboard blocks can appear to change parameter and variable values. However, the change does not propagate to the simulation. For example, Gain blocks display changes made to the **Gain** parameter using the dashboard blocks, but the **Gain** value used in the simulation does not change.

Parameters

Connection — Select a variable or block parameter to connect

variable and parameter connection options

Select the variable or block parameter to control using the **Connection** table. To connect the block to a signal:

- 1 Make a selection in the model that includes one or more blocks.
- 2 Select the variable or parameter you want to connect.

When the value of the selected variable or block parameter is nonscalar, use the text box at the bottom of the **Connection** table to specify the element you want to connect to the dashboard block. To connect to an element of a vector, matrix, or array, specify the element index, for example, 3 or (1, 3). To connect to an element in a bus or structure, specify the element in the context of the bus or structure hierarchy by using dots to indicate different levels in the hierarchy, and omit the top level. For example, specify a.b to connect to scalar element b of the structure or bus a nested inside the selected composite variable or parameter.

- 3 Click **Apply**.

To facilitate understanding and debugging your model, you can connect Dashboard blocks to variables and parameters in your model during simulation.

Note To see workspace variables in the connection table, update the model diagram using **Ctrl+D**.

Programmatic Use

To programmatically connect a dashboard block to a tunable parameter or a variable, use a `Simulink.HMI.ParamSourceInfo` object. The `Simulink.HMI.ParamSourceInfo` object contains four properties. Some of the properties apply to connecting dashboard blocks to parameters, and some apply to connecting dashboard blocks to variables. Not all fields have a value for a connection because a given dashboard block connects to either a parameter or a variable.

Block Parameter: Binding

Type: Simulink.HMI.ParamSourceInfo

Default: []

Minimum — Minimum tick mark value

0 (default) | scalar

Finite, real, double, scalar value specifying the minimum tick mark value for the scale. The minimum must be less than the value of the **Maximum** parameter.

Programmatic Use

To programmatically set the Minimum parameter, use a 1-by-3 vector containing values for the Minimum, Tick Interval, and Maximum parameters, in that order. To use the `auto` value for the Tick Interval, leave the Tick Interval position in the vector empty or specify -1.

Block Parameter: Limits

Type: 1x3 vector

Default: [0 -1 100]

Maximum — Maximum tick mark value

100 (default) | scalar

Finite, real, double, scalar value specifying the maximum tick mark value for the scale. The maximum must be greater than the value of the **Minimum** parameter.

Programmatic Use

To programmatically set the Maximum parameter, use a 1-by-3 vector containing values for the Minimum, Tick Interval, and Maximum parameters, in that order. To use the `auto` value for the Tick Interval, leave the Tick Interval position in the vector empty or specify -1.

Block Parameter: Limits

Type: 1x3 vector

Default: [0 -1 100]

Tick Interval — Interval between major tick marks

auto (default) | scalar

Finite, real, positive, whole, scalar value specifying the interval of major tick marks on the scale. When set to `auto`, the block automatically adjusts the tick interval based on the values of the **Maximum** and **Minimum** parameters.

Programmatic Use

To programmatically set the Tick Interval parameter, use a 1-by-3 vector containing values for the Minimum, Tick Interval, and Maximum parameters, in that order. To use the `auto` value for the Tick Interval, leave the Tick Interval position in the vector empty or specify -1.

Block Parameter: Limits

Type: 1x3 vector

Default: [0 -1 100]

Label — Block label position

Top (default) | Bottom | Hide

Position of the block label. When the block is connected to an element in the model, the label is the name of the connected element.

Programmatic Use**Block Parameter:** LabelPosition**Type:** character vector**Values:** 'Top' | 'Bottom' | 'Hide'**Default:** 'Top'**Lock Aspect Ratio — Whether to maintain block aspect ratio**

on (default) | off

Whether to maintain the block aspect ratio when resizing the block and when you specify a new background image.

Foreground Color — Block foreground color

[r g b] vector

Block foreground color, excluding the text. The **Foreground Color** applies to the scale and the block name. To specify the color for the block text, use the **Font Color**.

Specify the **Foreground Color** for the block using the **Design** tab in the Property Inspector.

- 1 On the **Design** tab, click **Edit Design**.
- 2 Select the **Scale** component.
- 3 In the **Ticks** section, open the **Color** menu. You can choose from the palette of standard colors or specify a custom color.

Programmatic Use

Specify the `ForegroundColor` parameter for the block as a 1-by-3 [r g b] vector with values between 0 and 1.

Block Parameter: ForegroundColor**Type:** [r g b] vector**Background Color — Block background color**

[r g b] vector

Block background color. You can choose to select a solid background color instead of providing a background image. To design a block that uses a solid background, use the **Design** tab in the Property Inspector.

- 1 On the **Design** tab, click **Edit Design**.
- 2 Select the **Background** component.
- 3 Select **Use background color**.
- 4 Choose a background color from the palette of standard colors or specify a custom color.
- 5 Adjust the **Offset from scale** option until the solid background is the desired size.

Changing the background color using the toolbar removes the background image and enables the **Use background color** option.

Programmatic Use

Specify the `BackgroundColor` parameter for the block as a 1-by-3 [r g b] vector with values between 0 and 1.

Block Parameter: BackgroundColor

Type: [r g b] vector

Font Color — Block font color

[r g b] vector

Block font color. The **Font Color** applies to the scale labels. To specify the color of the scale, use the **Foreground Color**.

Specify the **Font Color** for the block using the **Design** tab in the Property Inspector.

- 1 On the **Design** tab, click **Edit Design**.
- 2 Select the **Scale** component.
- 3 In the **Labels** section, open the **Color** menu. You can choose from the palette of standard colors or specify a custom color.

Block Characteristics

| | |
|---------------------------------|----------------------------------|
| Data Types | double half integer single |
| Direct Feedthrough | no |
| Multidimensional Signals | no |
| Variable-Size Signals | no |
| Zero-Crossing Detection | no |

Extended Capabilities

C/C++ Code Generation

Generate C and C++ code using Simulink® Coder™.

Dashboard blocks are ignored for code generation.

See Also

Blocks

Horizontal Slider | Vertical Slider | Knob | Circular Gauge | Horizontal Gauge | Vertical Gauge

Topics

“Tune and Visualize Your Model with Dashboard Blocks”

“Simulation Pacing”

Introduced in R2021a

Knob

Tune parameter value with dial

Library: Simulink / Dashboard



Description

The Knob block tunes the value of the connected block parameter to during simulation. For example, you can connect the Knob block to a Gain block in your model and adjust its value during simulation. You can modify the range of the Knob block's scale to fit your data. Use the Knob block with other Dashboard blocks to create an interactive dashboard to control your model.

Connect Dashboard Blocks

Dashboard blocks do not use ports to connect to model elements. To connect dashboard blocks to variables and block parameters, use connect mode. Connect mode facilitates the process of connecting dashboard blocks in your model, especially when you want to connect multiple blocks at once. To connect a single dashboard block, you can also use the **Connection** table in the block dialog box.

Tip You can modify dashboard block connections in your model during normal and accelerator mode simulations.

Note Dashboard blocks cannot connect to variables until you update the model diagram. To connect dashboard blocks to variables or modify variable values between opening your model and running a simulation, update the model diagram using **Ctrl+D**.

To enter connect mode, select the block. Then, on the block tab, click **Connect**. In connect mode, when you select one or more blocks, a list of parameters and variables available for connection appears. Select a variable or parameter from the list to connect to the selected dashboard block.

When the value of the selected variable or block parameter is nonscalar, use the text box at the bottom of the **Connection** table to specify the element you want to connect to the dashboard block. To connect to an element of a vector, matrix, or array, specify the element index, for example, 3 or (1, 3). To connect to an element in a bus or structure, specify the element in the context of the bus or structure hierarchy by using dots to indicate different levels in the hierarchy, and omit the top level. For example, specify a.b to connect to scalar element b of the structure or bus a nested inside the selected composite variable or parameter.

To connect another dashboard block, pause on another dashboard block and click the **Connect** button above it. Then, make a selection of signals and blocks in your model and choose a model element to connect.

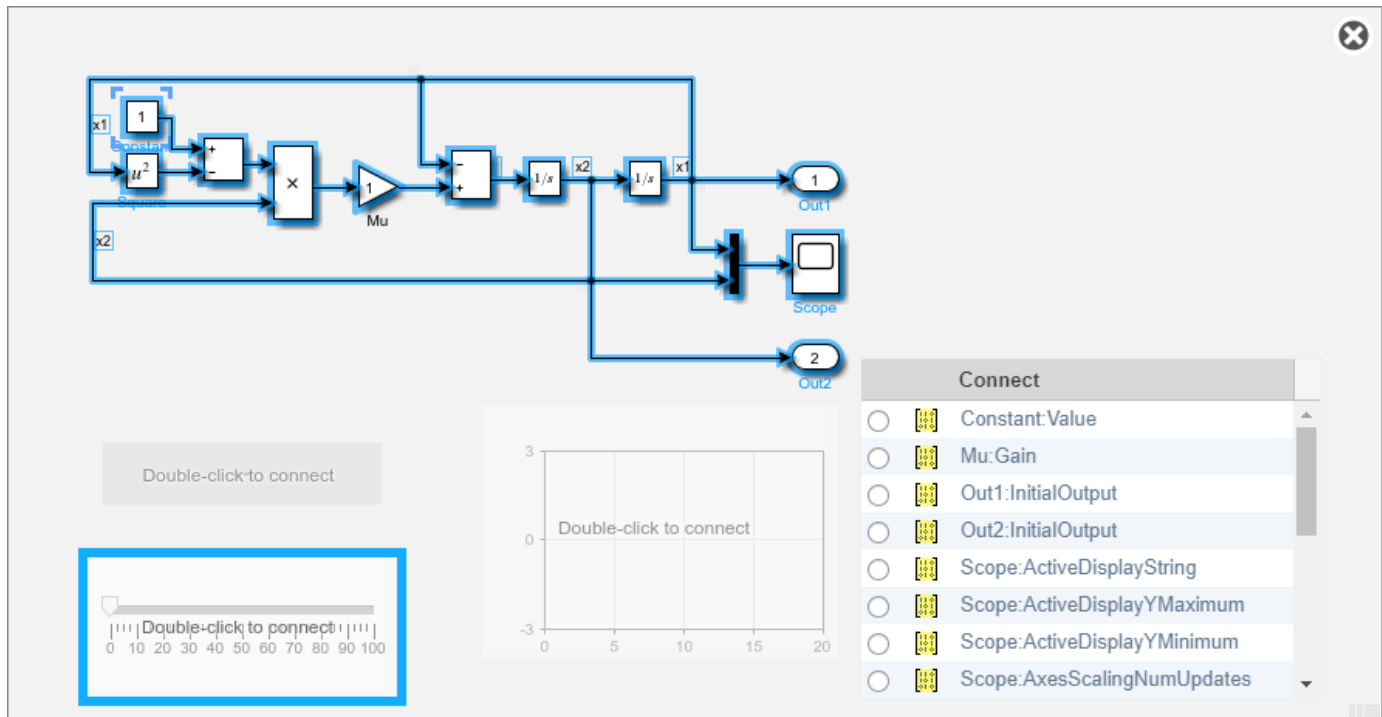

When you finish connecting the dashboard blocks in your model, on the block tab, click **Done Connecting**.

Tip You can hide the message shown on unconnected blocks using the `set_param` function with the `ShowInitialText` block parameter. The message also disappears when you connect the block.

Parameter Logging

Tunable parameters connected to dashboard blocks are logged to the Simulation Data Inspector, where you can view the parameter values along with logged signal data. You can access logged parameter data in the MATLAB workspace by exporting the parameter data from the Simulation Data Inspector by using the UI or the `Simulink.sdi.exportRun` function. For more information about exporting data using the Simulation Data Inspector UI, see “Export Data to the Workspace or a File”. The parameter data is stored in a `Simulink.SimulationData.Parameter` object, accessible as an element in the exported `Simulink.SimulationData.Dataset`.

Limitations

- Except for the Dashboard Scope block and the Display block, dashboard blocks can only connect to real scalar signals.
- The toolstrip does not support blocks that are inside a panel.
- You cannot use the **Connection** table in the block dialog to connect a dashboard block to a block that is commented out. When you connect a dashboard block to a commented block using connect mode, the dashboard block does not display the connected value until the you uncomment the block.
- Dashboard blocks cannot connect to model elements inside referenced models.

- When you simulate a model hierarchy, dashboard blocks inside referenced models do not update.
- Dashboard blocks do not support rapid accelerator simulation.
- When you connect a dashboard block to a variable or parameter during simulation, the data for that variable or parameter is not logged to the Simulation Data Inspector. To log variable and parameter data to the Simulation Data Inspector, connect the dashboard block to the variable or parameter prior to simulation.
- When you simulate a model in external mode with the **Default parameter behavior** set to **Inlined**, dashboard blocks can appear to change parameter and variable values. However, the change does not propagate to the simulation. For example, Gain blocks display changes made to the **Gain** parameter using the dashboard blocks, but the **Gain** value used in the simulation does not change.

Parameters

Connection — Select a variable or block parameter to connect

variable and parameter connection options

Select the variable or block parameter to control using the **Connection** table. To connect the block to a signal:

- 1 Make a selection in the model that includes one or more blocks.
- 2 Select the variable or parameter you want to connect.

When the value of the selected variable or block parameter is nonscalar, use the text box at the bottom of the **Connection** table to specify the element you want to connect to the dashboard block. To connect to an element of a vector, matrix, or array, specify the element index, for example, 3 or (1, 3). To connect to an element in a bus or structure, specify the element in the context of the bus or structure hierarchy by using dots to indicate different levels in the hierarchy, and omit the top level. For example, specify `a.b` to connect to scalar element `b` of the structure or bus `a` nested inside the selected composite variable or parameter.

- 3 Click **Apply**.

To facilitate understanding and debugging your model, you can connect Dashboard blocks to variables and parameters in your model during simulation.

Note To see workspace variables in the connection table, update the model diagram using **Ctrl+D**.

Programmatic Use

To programmatically connect a dashboard block to a tunable parameter or a variable, use a `Simulink.HMI.ParamSourceInfo` object. The `Simulink.HMI.ParamSourceInfo` object contains four properties. Some of the properties apply to connecting dashboard blocks to parameters, and some apply to connecting dashboard blocks to variables. Not all fields have a value for a connection because a given dashboard block connects to either a parameter or a variable.

Block Parameter: Binding

Type: `Simulink.HMI.ParamSourceInfo`

Default: []

Scale Type — Type of scale

Linear (default) | Log

Type of scale displayed on the block. **Linear** specifies a linear scale, and **Log** specifies a logarithmic scale.

Programmatic Use

Block Parameter: ScaleType

Type: string or character vector

Values: 'Linear' | 'Log'

Default: 'Linear'

Minimum — Minimum tick mark value

0 (default) | scalar

Finite, real, double, scalar value specifying the minimum tick mark value for the scale. The minimum must be less than the value of the **Maximum** parameter.

Programmatic Use

To programmatically set the Minimum parameter, use a 1-by-3 vector containing values for the Minimum, Tick Interval, and Maximum parameters, in that order. To use the `auto` value for the Tick Interval, leave the Tick Interval position in the vector empty or specify `-1`.

Block Parameter: Limits

Type: 1x3 vector

Default: [0 -1 100]

Maximum — Maximum tick mark value

100 (default) | scalar

Finite, real, double, scalar value specifying the maximum tick mark value for the scale. The maximum must be greater than the value of the **Minimum** parameter.

Programmatic Use

To programmatically set the Maximum parameter, use a 1-by-3 vector containing values for the Minimum, Tick Interval, and Maximum parameters, in that order. To use the `auto` value for the Tick Interval, leave the Tick Interval position in the vector empty or specify `-1`.

Block Parameter: Limits

Type: 1x3 vector

Default: [0 -1 100]

Tick Interval — Interval between major tick marks

auto (default) | scalar

Finite, real, positive, whole, scalar value specifying the interval of major tick marks on the scale. When set to `auto`, the block automatically adjusts the tick interval based on the values of the **Maximum** and **Minimum** parameters.

Programmatic Use

To programmatically set the Tick Interval parameter, use a 1-by-3 vector containing values for the Minimum, Tick Interval, and Maximum parameters, in that order. To use the `auto` value for the Tick Interval, leave the Tick Interval position in the vector empty or specify `-1`.

Block Parameter: Limits

Type: 1x3 vector

Default: [0 -1 100]

Label — Block label position

Top (default) | Bottom | Hide

Position of the block label. When the block is connected to an element in the model, the label is the name of the connected element.

Programmatic Use**Block Parameter:** LabelPosition**Type:** character vector**Values:** 'Top' | 'Bottom' | 'Hide'**Default:** 'Top'**Block Characteristics**

| | |
|---------------------------------|----------------------------------|
| Data Types | double half integer single |
| Direct Feedthrough | no |
| Multidimensional Signals | no |
| Variable-Size Signals | no |
| Zero-Crossing Detection | no |

Extended Capabilities**C/C++ Code Generation**

Generate C and C++ code using Simulink® Coder™.

Dashboard blocks are ignored for code generation.

See Also

Rotary Switch | Slider

Topics

“Tune and Visualize Your Model with Dashboard Blocks”

“Decide How to Visualize Simulation Data”

Introduced in R2015a

Lamp

Display color that reflects signal value on lamp with customizable appearance

Library: Simulink / Dashboard / Customizable Blocks



Description

The Lamp block displays a color that reflects the value of the connected signal. To configure the Lamp block to provide the information you need during simulation, specify one or more states, which pair a signal value with a color for the Lamp block to display. When you use the Lamp block in the Customizable Blocks library, you can modify the appearance of the block so it looks like a real indicator lamp in your system. Use the Lamp block with other dashboard blocks to build an interactive dashboard of controls and indicators for your model.

Customize Lamp Blocks

When you add a Lamp block to your model, the block is preconfigured with a default design. You can use the block with the default design or customize the appearance of the block. When you design a custom Lamp block, you can:

- Select a shape for the region that changes color to reflect the value of the connected signal.
- Select an icon from a built-in set of shapes, wireless icons, and automotive indicator lamps or upload your own custom icon.
- Specify how to combine the shape and the icon.
 - Simple — Overlay the icon on top of the shape.
 - Intersect — Retain the intersection of the shape and icon as the area that changes color to reflect the signal value.
 - Subtract — Subtract the icon from the shape, producing a cut out in the shape of the icon in the area that changes color to reflect the signal value.



Icon



Simple



Intersect



Subtract

Note The intersect and subtract combination styles use transparency in the icon asset to produce the area that changes color. When you design a Lamp block that uses a custom icon, consider

using an SVG or PNG file for the icon if you want your design to use the intersect or subtract options. Both formats support transparency, and SVG files also scale well in response to zoom operations.

- Upload a background image or specify a background color to provide a background for the shape and icon.
- Upload a foreground image that overlays the rest of the lamp design.

To customize the appearance of the block, use design mode. You can enter design mode in one of three ways after selecting the block:

- On the **Lamp** tab, under **Design**, click **Edit**.
- In the **Property Inspector**, on the **Design** tab, click **Edit Design**.
- Pause on the ellipsis that appears above the block and click the **Edit Custom Block** button.

Design mode gives you access to block parameters and settings that allow you to customize the appearance of the block. You can use the toolbar above the block to change the icon and how the icon combines with the shape. To select a shape, background image or color, and foreground image, use the **Design** tab in the Property Inspector.

When you finish designing the lamp, click **Exit** in the upper-right of the canvas to exit design mode.

Connect Dashboard Blocks

Dashboard blocks do not use ports to connect to model elements. To connect dashboard blocks to signals in your model, use connect mode. Connect mode facilitates the process of connecting dashboard blocks in your model, especially when you want to connect multiple blocks at once. To connect a single dashboard block, you can also use the **Connection** table in the block dialog box.

Tip You can modify dashboard block connections during normal and accelerator mode simulations.

To enter connect mode, select a dashboard block to connect. Then, on the block tab, click **Connect**. In connect mode, when you select one or more signals or blocks, a list of signals that are available for connection appears. Select a signal from the list to connect to the selected dashboard block. To connect another dashboard block, pause on the block you want to connect and click the **Connect** button above it. Then, select one or more signals and blocks in the model and choose a signal to connect.

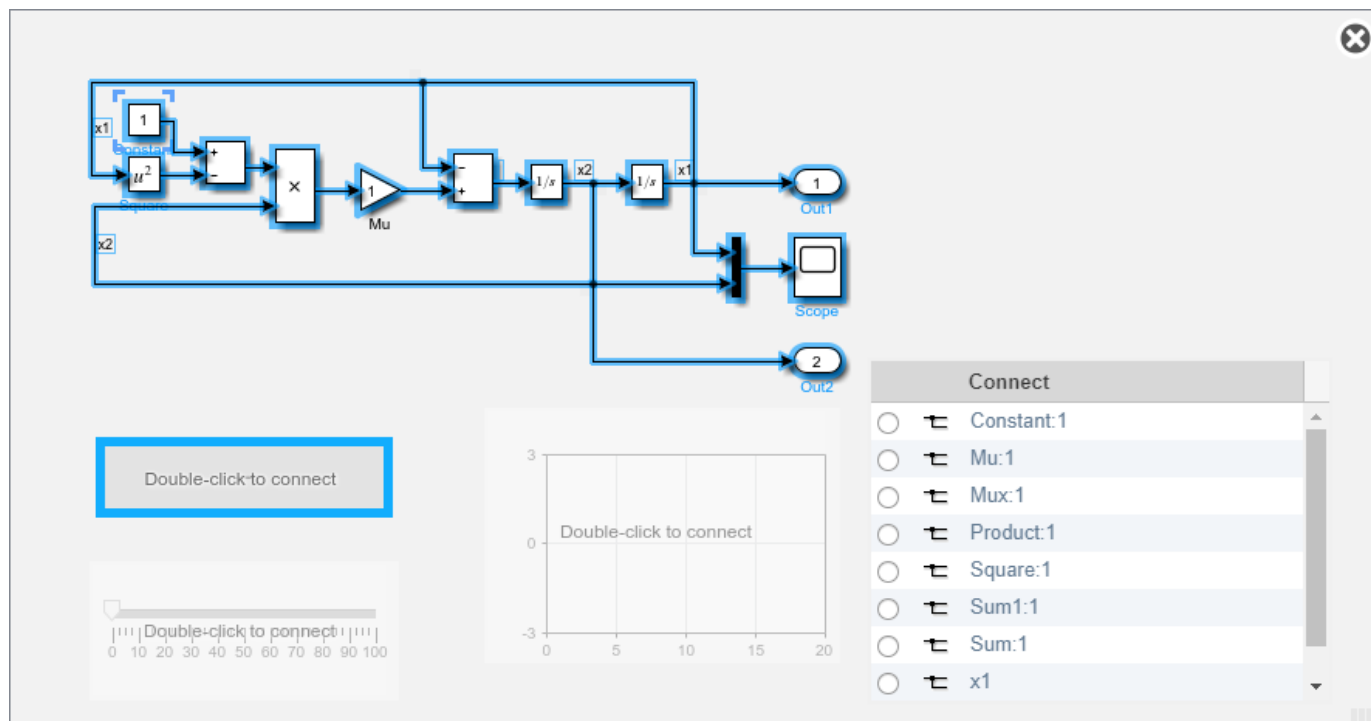

When you finish connecting the dashboard blocks in your model, on the block tab, click **Done Connecting**.

Tip You can hide the message shown on unconnected blocks using the `set_param` function with the `ShowInitialText` block parameter. The message also disappears when you connect the block.

Limitations

- Except for the Dashboard Scope block and the Display block, dashboard blocks can only connect to real scalar signals.
- The toolstrip does not support blocks that are inside a panel.
- You cannot use the **Connection** table in the block dialog to connect a dashboard block to a block that is commented out. When you connect a dashboard block to a commented block using connect mode, the dashboard block does not display the connected value until the you uncomment the block.
- Dashboard blocks cannot connect to model elements inside referenced models.

- When you simulate a model hierarchy, dashboard blocks inside referenced models do not update.
- Dashboard blocks do not support rapid accelerator simulation.
- You cannot connect a dashboard block to data or activity in Stateflow during simulation.
- Some signals do not have data available during simulation due to block reduction or optimization for accelerator mode simulations. To view such a signal using a dashboard block, mark the signal for logging.

Parameters

Connection — Signal to connect and display

signal connection options

Use the connection table to select the signal to connect to the block. To connect the block to a signal:

- 1 Make a selection in the model that includes one or more signals.
- 2 In the table, select the signal you want to connect.
- 3 Click **Apply**.

Tip You can connect dashboard blocks to signals in the model during simulation.

Programmatic Use

Block Parameter: Binding

Type: Simulink.HMI.SignalSpecification

Default: []

States — Signal value and color pairs

scalar and RGB vector

States match a display color to the value of the connected signal. Each state consists of a **State** and a **Color**.

- **State** — Connected signal value that causes the Lamp block to display the specified color.
- **Color** — Lamp color when the connected signal value matches the corresponding **State** value. You can select from a palette of standard colors or specify a custom color with RGB values.

The [undefined] state specifies the color of the Lamp block when the connected signal value does not match any of the values specified in the **States** table. Click the **+** button to add another state.

Programmatic Use

To programmatically specify the **State** and **Color** parameter values for a Lamp block, use an array of structures that contain these fields:

- **Value** — Scalar double signal value that causes the Lamp block to display the specified color indication.
- **Color** — 1-by-3 [r g b] vector with values between 0 and 1 that specifies the color for the Lamp block to display.

```
lampState1.Value = 1;  
lampState1.Color = [0 0 1];
```

```
lampState2.Value = 2;
lampState2.Color = [1 0 0];
lampStates = [lampState1 lampState2];
```

Block Parameter: StateColors

Type: structure array

Default: structure

The ColorDefault parameter specifies the color for the Lamp block when the value of the connected signal does not match any of the specified state values. Specify the ColorDefault parameter as a 1-by-3 [r g b] vector with values between 0 and 1.

Block Parameter: ColorDefault

Type: [r g b] vector

Default: [0.7529 0.7529 0.7529]

Label — Block label position

Top (default) | Bottom | Hide

Position of the block label. When the block is connected to an element in the model, the label is the name of the connected element.

Programmatic Use

Block Parameter: LabelPosition

Type: character vector

Values: 'Top' | 'Bottom' | 'Hide'

Default: 'Top'

Lock Aspect Ratio — Whether to maintain block aspect ratio

on (default) | off

Whether to maintain the block aspect ratio when resizing the block and when you specify a new background image.

Block Characteristics

| | |
|---------------------------------|---|
| Data Types | Boolean double enumerated fixed point half integer single |
| Direct Feedthrough | no |
| Multidimensional Signals | no |
| Variable-Size Signals | no |
| Zero-Crossing Detection | no |

Extended Capabilities

C/C++ Code Generation

Generate C and C++ code using Simulink® Coder™.

Dashboard blocks are ignored for code generation.

See Also

Lamp

Topics

“Tune and Visualize Your Model with Dashboard Blocks”

Introduced in R2021b

Lamp

Display color that reflects signal value on lamp

Library: Simulink / Dashboard



Description

The Lamp block displays a color that indicates the value of the connected signal. To configure the Lamp block to provide the information you need during simulation, specify one or more states, which pair a signal value with a color for the Lamp block to display. You can use the Lamp block with other Dashboard blocks to build an interactive dashboard of controls and indicators for your model.

Lamp Icons

You can change the appearance of the Lamp block by selecting one of the built-in icons or uploading your own custom icon. The built-in icons include basic shapes, automotive indicator lamps, and wireless icons. You can change the icon for a Lamp block by using the **Icon** parameter or by using the block tab in the toolstrip. The Dashboard library also includes libraries that have a preconfigured version of the Lamp block for each icon. For complete details, see “Icon” on page 1-0 .

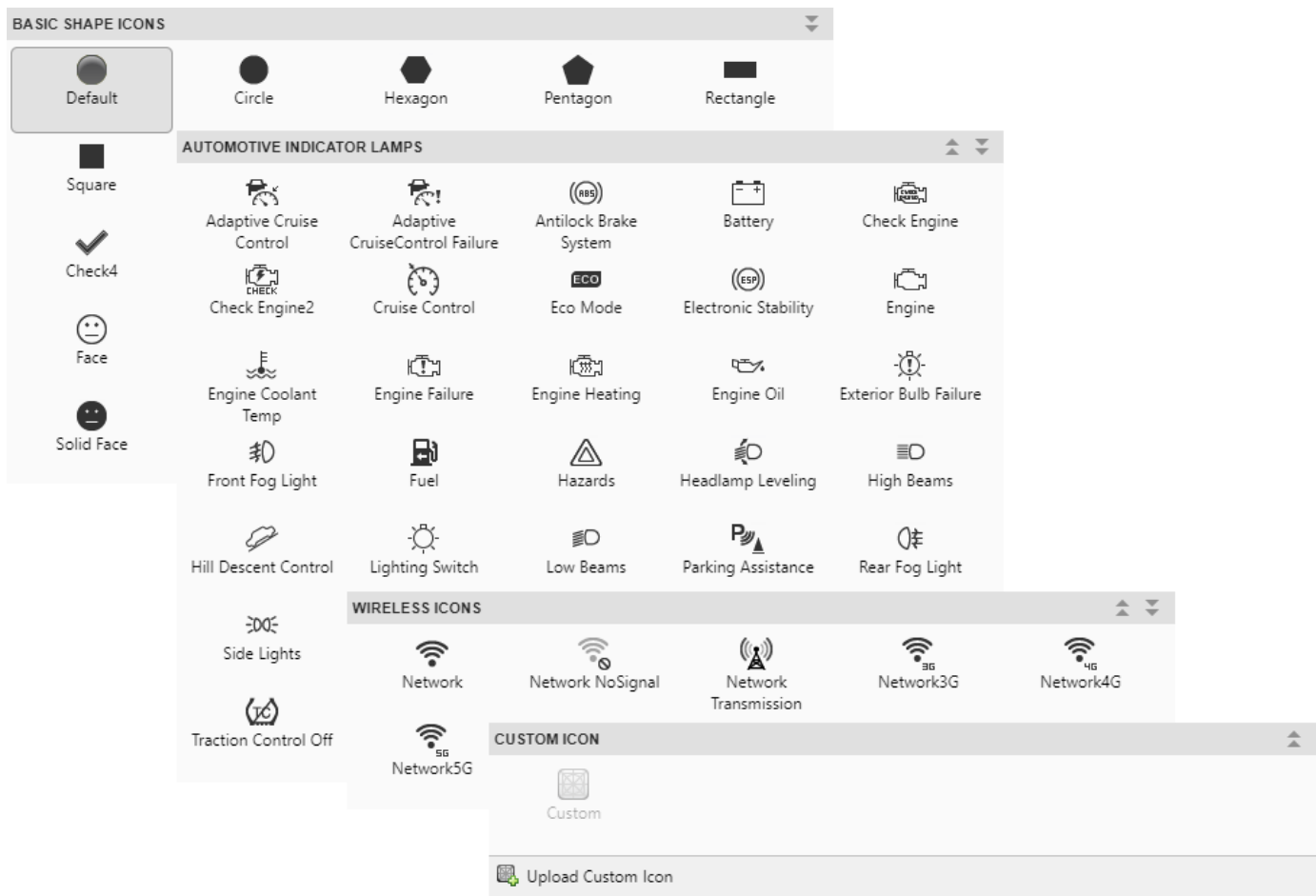

If you want to customize the appearance of the Lamp block beyond the ability to select an icon, consider designing your own indicator lamp using the Lamp block in the Customizable Blocks library.

Connect Dashboard Blocks

Dashboard blocks do not use ports to connect to model elements. To connect dashboard blocks to signals in your model, use connect mode. Connect mode facilitates the process of connecting dashboard blocks in your model, especially when you want to connect multiple blocks at once. To connect a single dashboard block, you can also use the **Connection** table in the block dialog box.

Tip You can modify dashboard block connections during normal and accelerator mode simulations.

To enter connect mode, select a dashboard block to connect. Then, on the block tab, click **Connect**. In connect mode, when you select one or more signals or blocks, a list of signals that are available for connection appears. Select a signal from the list to connect to the selected dashboard block. To connect another dashboard block, pause on the block you want to connect and click the **Connect** button above it. Then, select one or more signals and blocks in the model and choose a signal to connect.

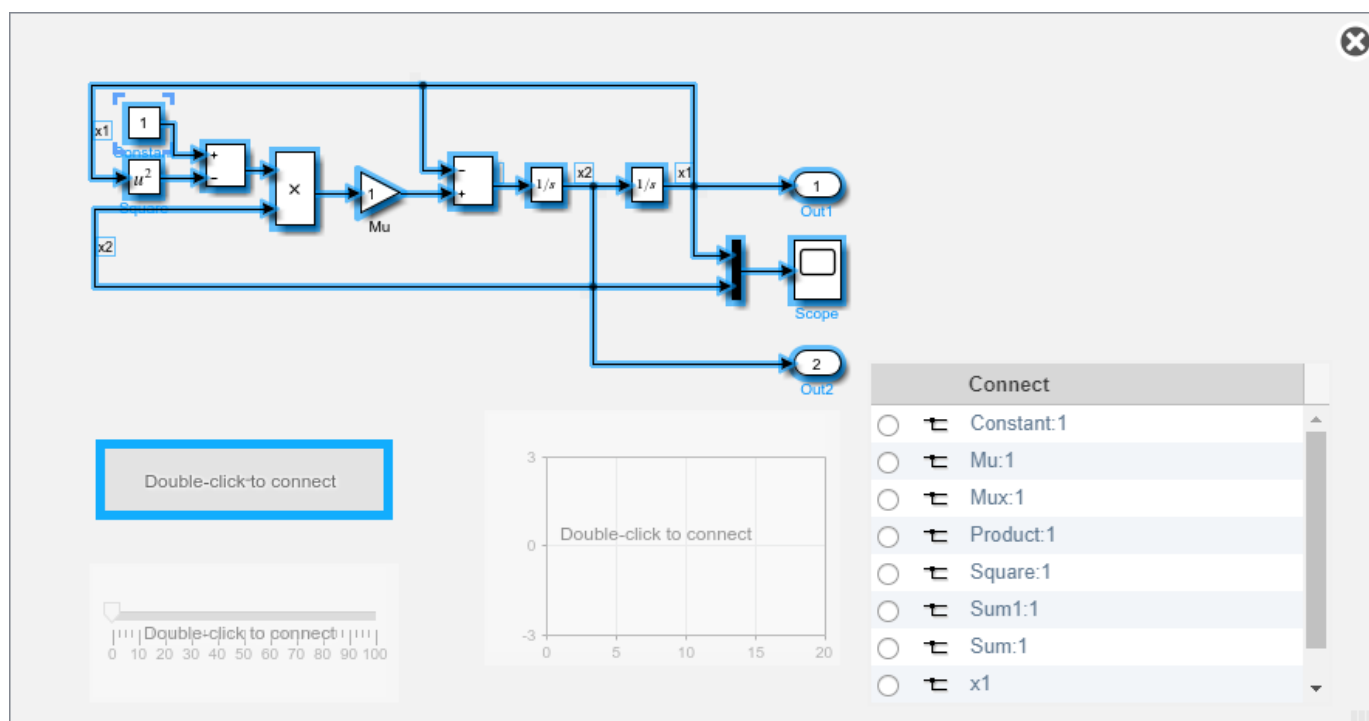

When you finish connecting the dashboard blocks in your model, on the block tab, click **Done Connecting**.

Tip You can hide the message shown on unconnected blocks using the `set_param` function with the `ShowInitialText` block parameter. The message also disappears when you connect the block.

Limitations

- Except for the Dashboard Scope block and the Display block, dashboard blocks can only connect to real scalar signals.
- The toolstrip does not support blocks that are inside a panel.
- You cannot use the **Connection** table in the block dialog to connect a dashboard block to a block that is commented out. When you connect a dashboard block to a commented block using connect mode, the dashboard block does not display the connected value until the you uncomment the block.
- Dashboard blocks cannot connect to model elements inside referenced models.
- When you simulate a model hierarchy, dashboard blocks inside referenced models do not update.
- Dashboard blocks do not support rapid accelerator simulation.
- You cannot connect a dashboard block to data or activity in Stateflow during simulation.
- Some signals do not have data available during simulation due to block reduction or optimization for accelerator mode simulations. To view such a signal using a dashboard block, mark the signal for logging.

Parameters

Connection — Signal to connect and display

signal connection options

Use the connection table to select the signal to connect to the block. To connect the block to a signal:

- 1 Make a selection in the model that includes one or more signals.
- 2 In the table, select the signal you want to connect.
- 3 Click **Apply**.

Tip You can connect dashboard blocks to signals in the model during simulation.

Programmatic Use

Block Parameter: Binding

Type: Simulink.HMI.SignalSpecification

Default: []

States — Signal value and color pairs

scalar and RGB vector

States match a display color to the value of the connected signal. Each state consists of a **State** and a **Color**.

- **State** — Connected signal value that causes the Lamp block to display the specified color.
- **Color** — Lamp color when the connected signal value matches the corresponding **State** value. You can select from a palette of standard colors or specify a custom color with RGB values.

The [undefined] state specifies the color of the Lamp block when the connected signal value does not match any of the values specified in the **States** table. Click the **+** button to add another state.

Programmatic Use

To programmatically specify the **State** and **Color** parameter values for a Lamp block, use an array of structures that contain these fields:

- **Value** — Scalar `double` signal value that causes the Lamp block to display the specified color indication.
- **Color** — 1-by-3 [r g b] vector with values between 0 and 1 that specifies the color for the Lamp block to display.

```
lampState1.Value = 1;  
lampState1.Color = [0 0 1];  
lampState2.Value = 2;  
lampState2.Color = [1 0 0];  
lampStates = [lampState1 lampState2];
```

Block Parameter: StateColors

Type: structure array

Default: structure

The `ColorDefault` parameter specifies the color for the Lamp block when the value of the connected signal does not match any of the specified state values. Specify the `ColorDefault` parameter as a 1-by-3 [r g b] vector with values between 0 and 1.

Block Parameter: `ColorDefault`

Type: [r g b] vector

Default: [0.7529 0.7529 0.7529]

Icon — Lamp block appearance

SVG image

Use an icon to configure the appearance of the Lamp block in the model. You can choose from built-in shape, automotive, and wireless icons, or you can upload your own custom SVG file as an icon.

To view icon options, on the **Icon** tab, select an **Icon Type**. To use your own SVG file as the block icon, select **Custom** as the **Icon Type** and upload the SVG file. The state colors for the Lamp block can apply to these SVG elements:

- `altGlyph`
- `circle`
- `ellipse`
- `path`
- `polygon`
- `rect`
- `text`
- `textPath`
- `tref`
- `tspan`

Shape Icons

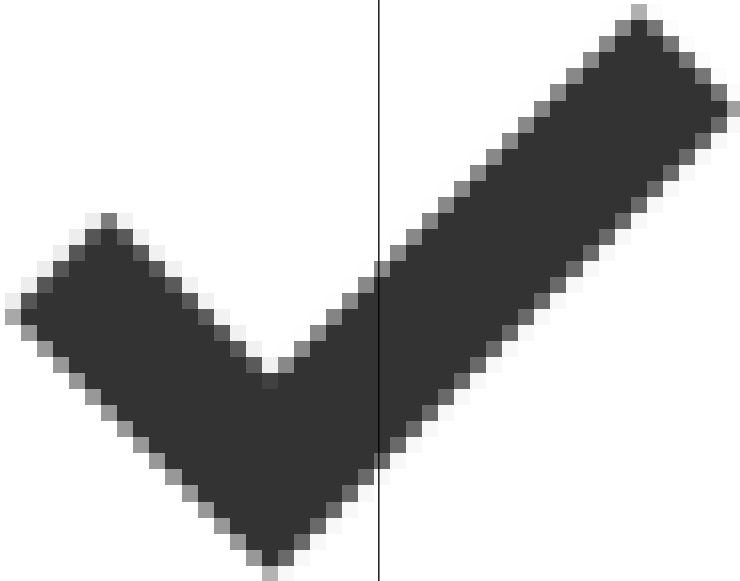
| Icon | Basic Shapes Library Block Name | Programmatic Use Value |
|---|---------------------------------|------------------------|
|  | Lamp | Default |
|  | Check1 | Check1 |

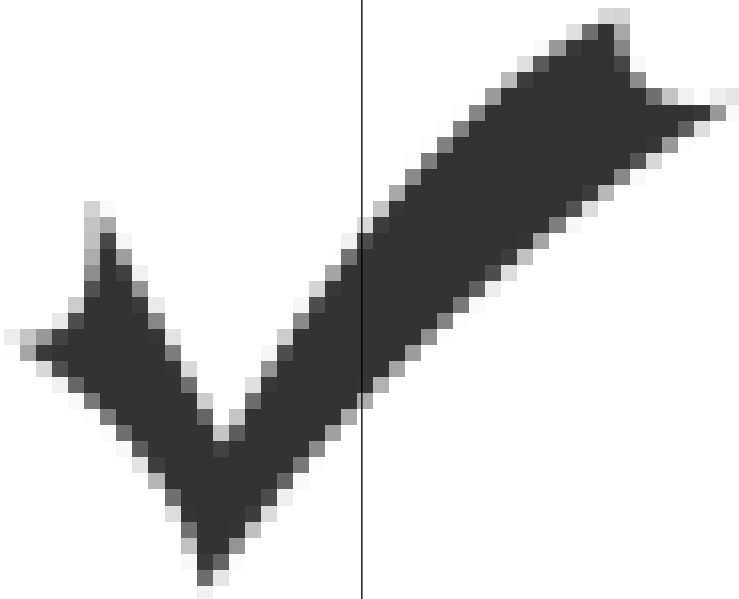
| Icon | Basic Shapes Library Block Name | Programmatic Use Value |
|---|---------------------------------|------------------------|
|  | Check2 | Check2 |

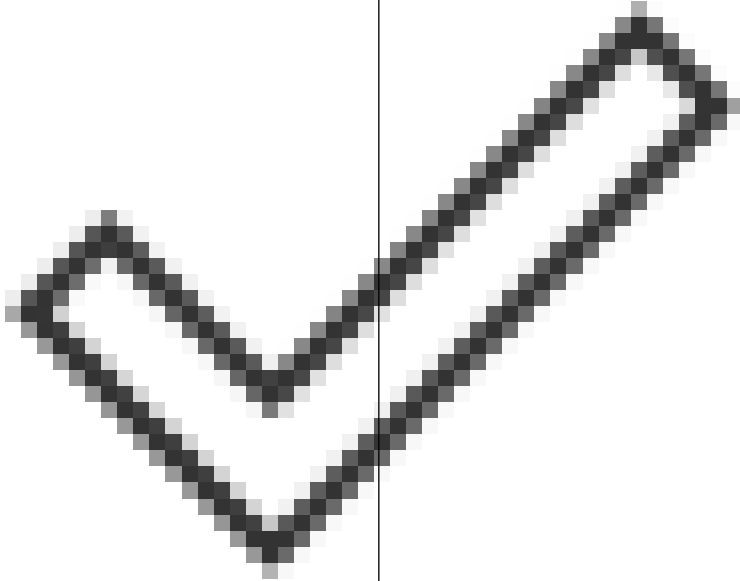
| Icon | Basic Shapes Library Block Name | Programmatic Use Value |
|---|--|-------------------------------|
|  | Check3 | Check3 |

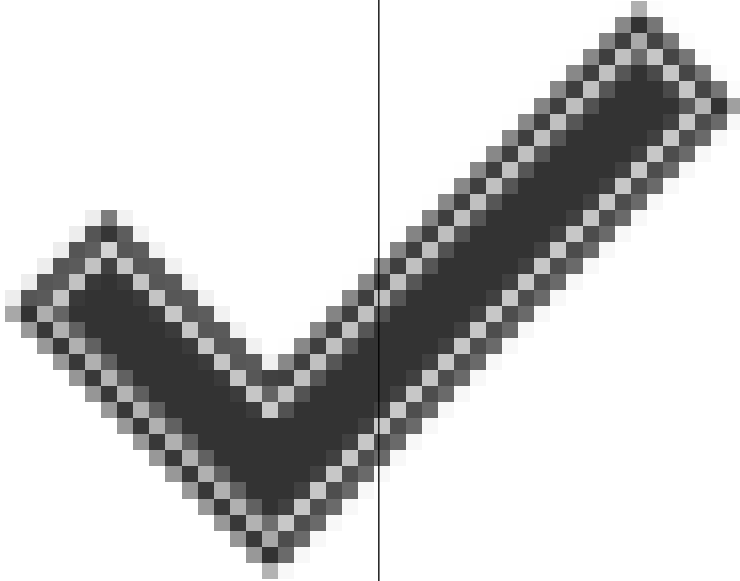
| Icon | Basic Shapes Library Block Name | Programmatic Use Value |
|---|---------------------------------|------------------------|
|  | Check4 | Check4 |

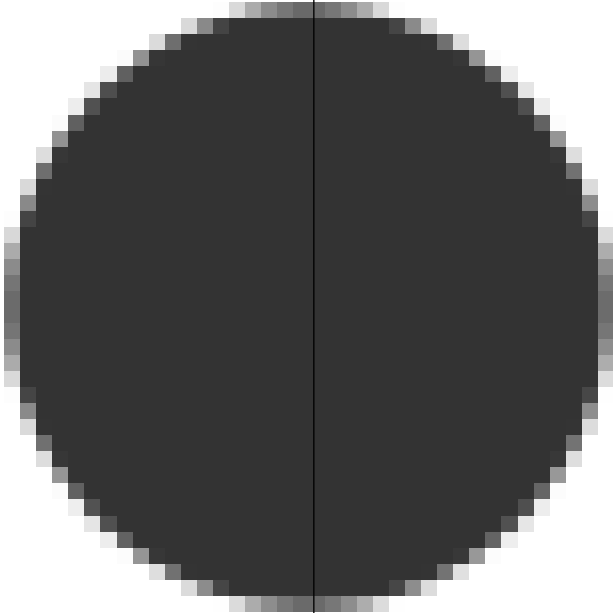
| Icon | Basic Shapes Library Block Name | Programmatic Use Value |
|--|--|-------------------------------|
|  | Circle | Circle |

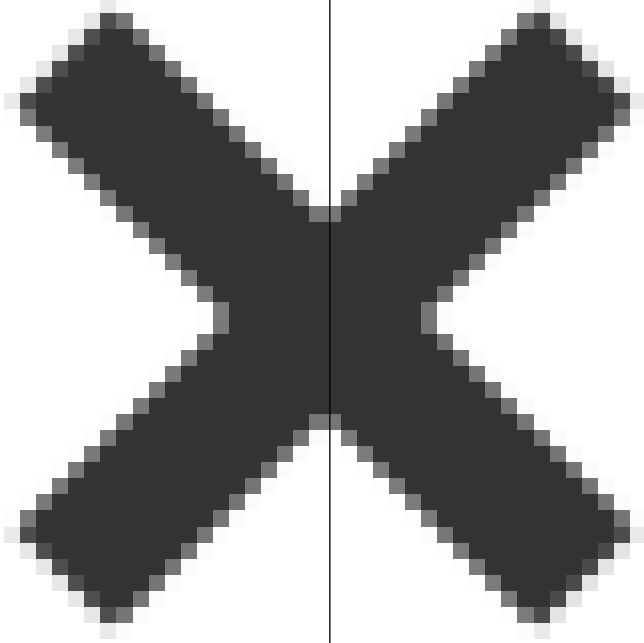
| Icon | Basic Shapes Library Block Name | Programmatic Use Value |
|--|---------------------------------|------------------------|
|  | Ex1 | Ex1 |

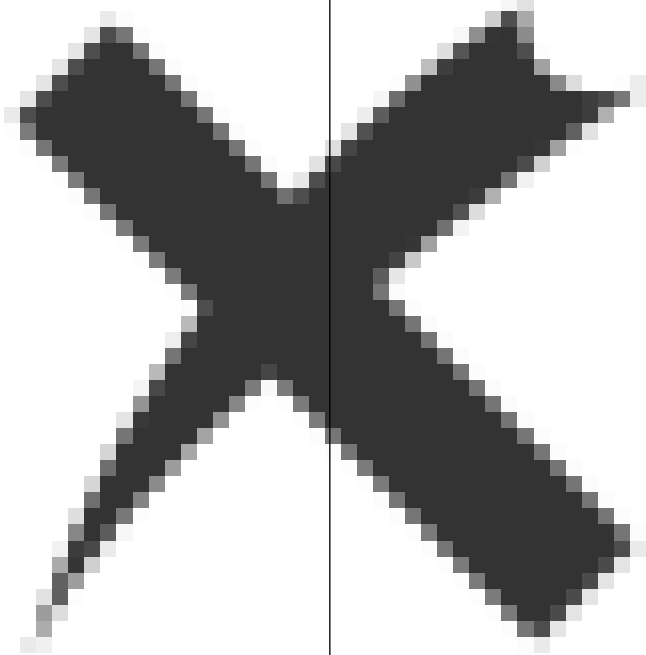
| Icon | Basic Shapes Library Block Name | Programmatic Use Value |
|--|--|-------------------------------|
|  | Ex2 | Ex2 |

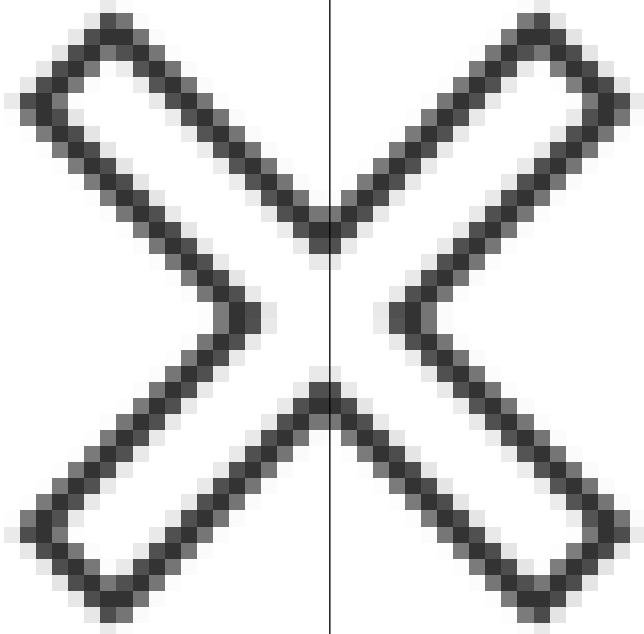
| Icon | Basic Shapes Library Block Name | Programmatic Use Value |
|--|---------------------------------|------------------------|
|  | Ex3 | Ex3 |

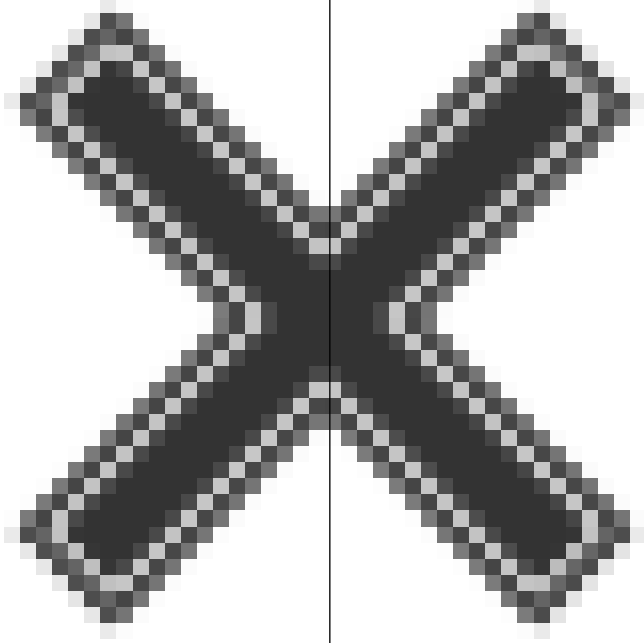
| Icon | Basic Shapes Library Block Name | Programmatic Use Value |
|--|--|-------------------------------|
|  | Ex4 | Ex4 |

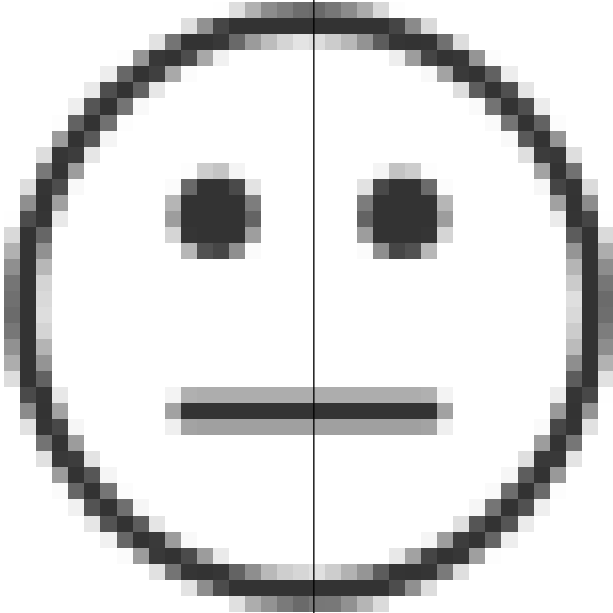
| Icon | Basic Shapes Library Block Name | Programmatic Use Value |
|--|---------------------------------|------------------------|
|  | Face | Face |

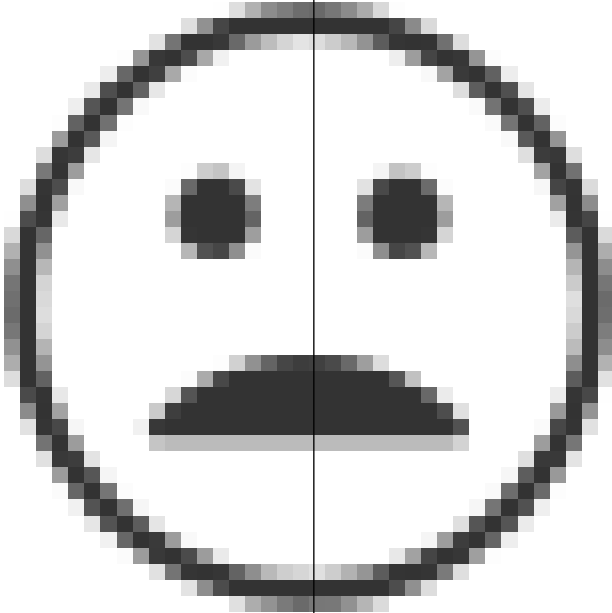
| Icon | Basic Shapes Library Block Name | Programmatic Use Value |
|--|--|-------------------------------|
|  | Frown1 | Frown1 |

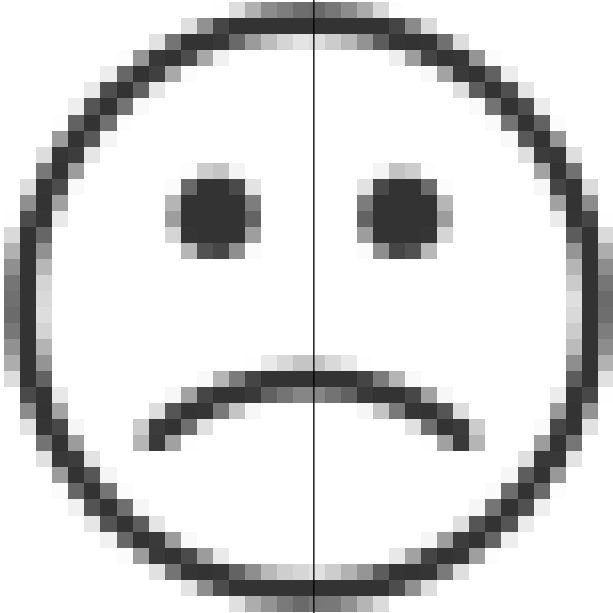
| Icon | Basic Shapes Library Block Name | Programmatic Use Value |
|--|---------------------------------|------------------------|
|  | Frown2 | Frown2 |

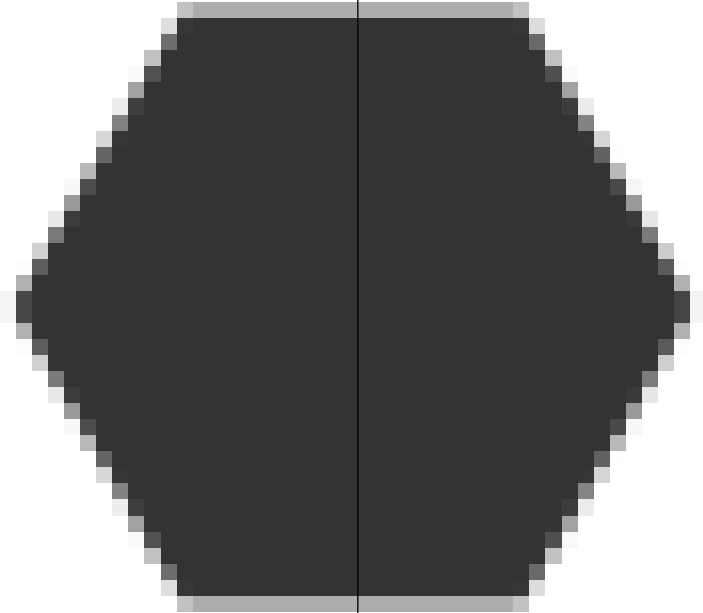
| Icon | Basic Shapes Library Block Name | Programmatic Use Value |
|--|--|-------------------------------|
|  | Hexagon | Hexagon |

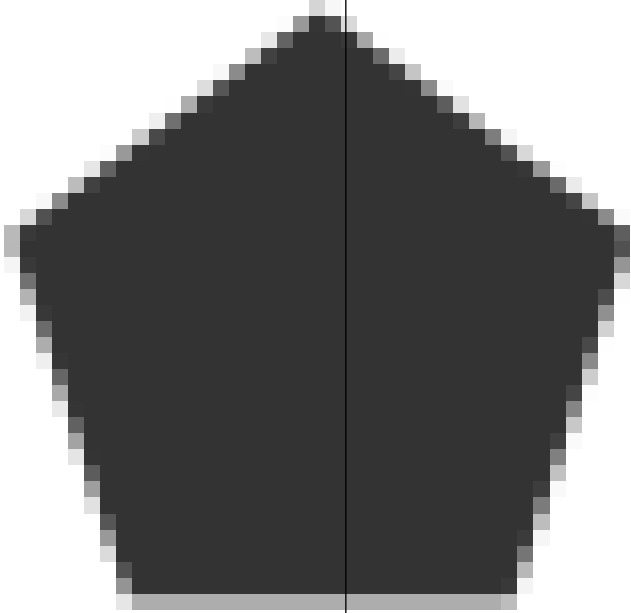
| Icon | Basic Shapes Library Block Name | Programmatic Use Value |
|--|--|-------------------------------|
|  | Pentagon | Pentagon |

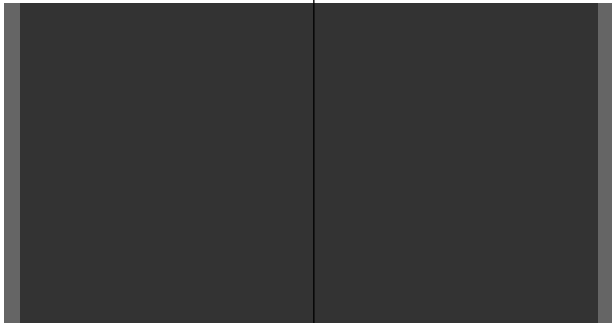
| Icon | Basic Shapes Library Block Name | Programmatic Use Value |
|---|--|-------------------------------|
|  | Rectangle | Rectangle |

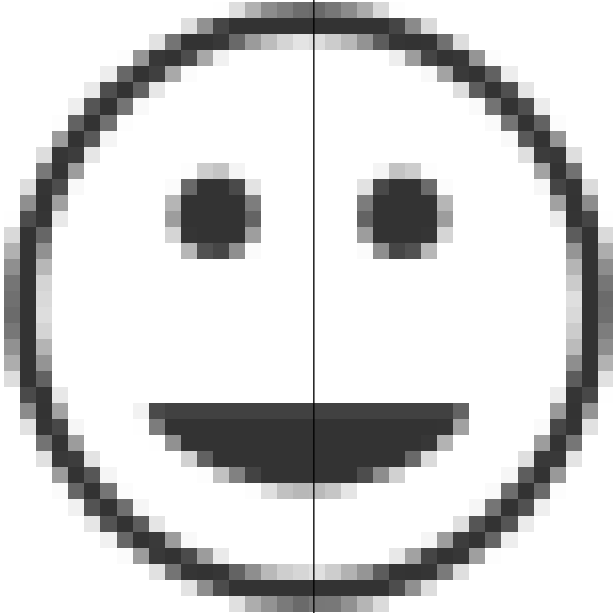
| Icon | Basic Shapes Library Block Name | Programmatic Use Value |
|--|---------------------------------|------------------------|
|  | Smile1 | Smile1 |

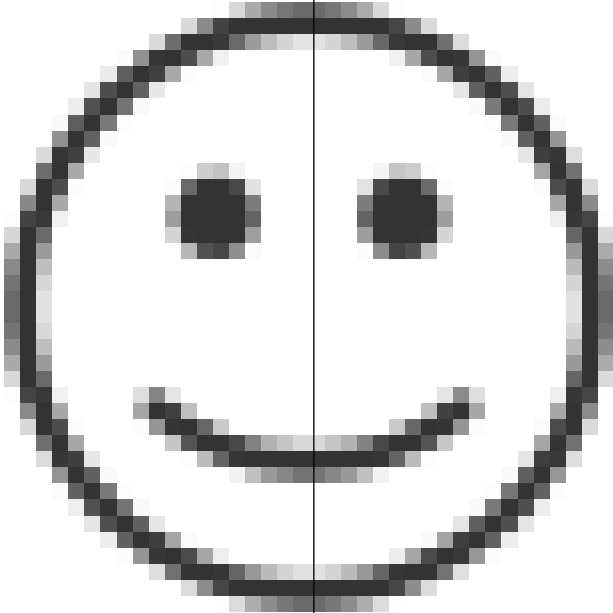
| Icon | Basic Shapes Library Block Name | Programmatic Use Value |
|--|--|-------------------------------|
|  | Smile2 | Smile2 |

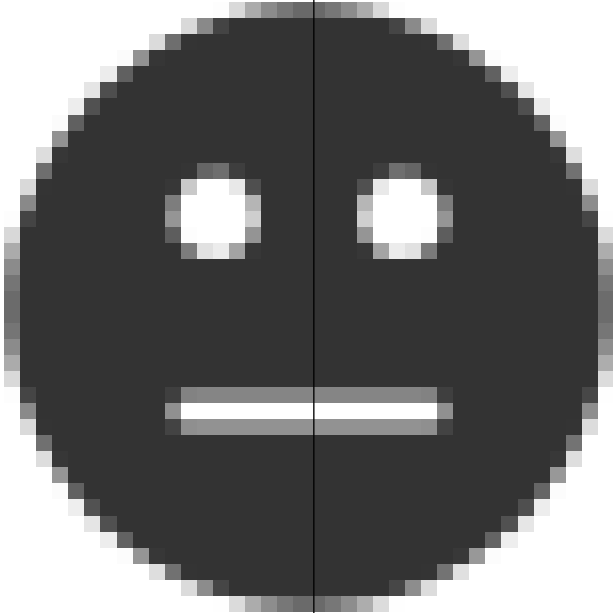
| Icon | Basic Shapes Library Block Name | Programmatic Use Value |
|--|---------------------------------|------------------------|
|  | Solid Face | SolidFace |

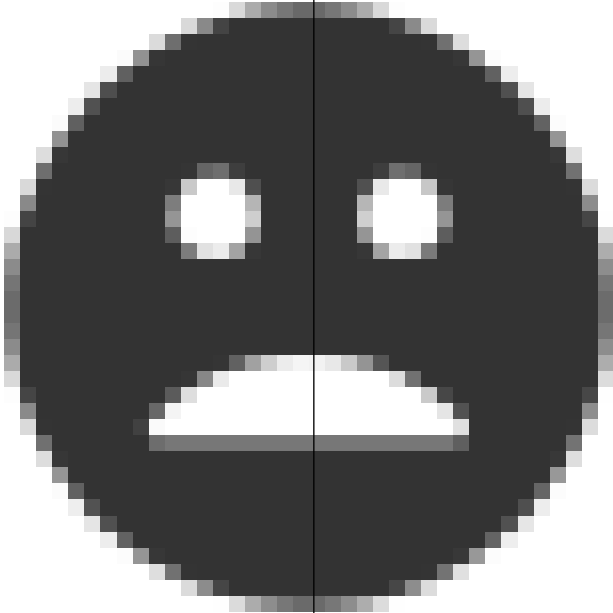
| Icon | Basic Shapes Library Block Name | Programmatic Use Value |
|--|--|-------------------------------|
|  | Solid Frown1 | SolidFrown1 |

| Icon | Basic Shapes Library Block Name | Programmatic Use Value |
|--|---------------------------------|------------------------|
|  | Solid Frown2 | SolidFrown2 |

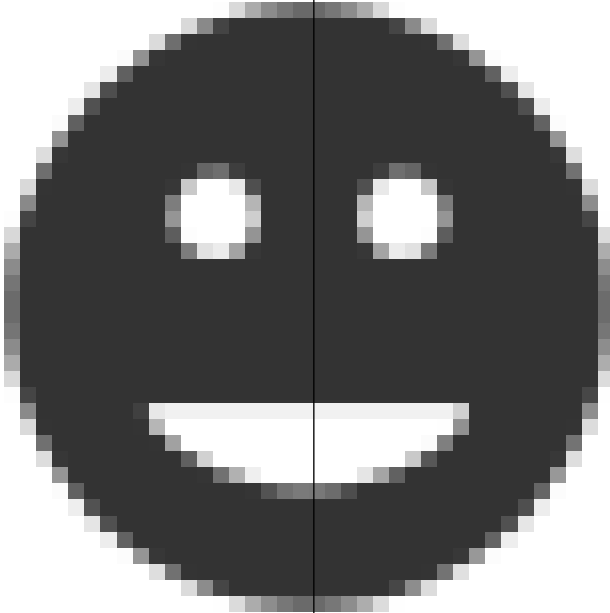
| Icon | Basic Shapes Library Block Name | Programmatic Use Value |
|--|--|-------------------------------|
|  | Solid Smile1 | SolidSmile1 |

| Icon | Basic Shapes Library Block Name | Programmatic Use Value |
|--|---------------------------------|------------------------|
|  | Solid Smile2 | SolidSmile2 |

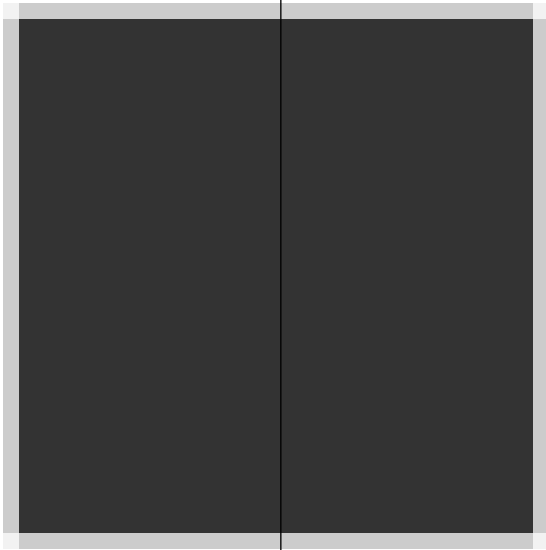
| Icon | Basic Shapes Library Block Name | Programmatic Use Value |
|--|--|-------------------------------|
|  | Square | Square |

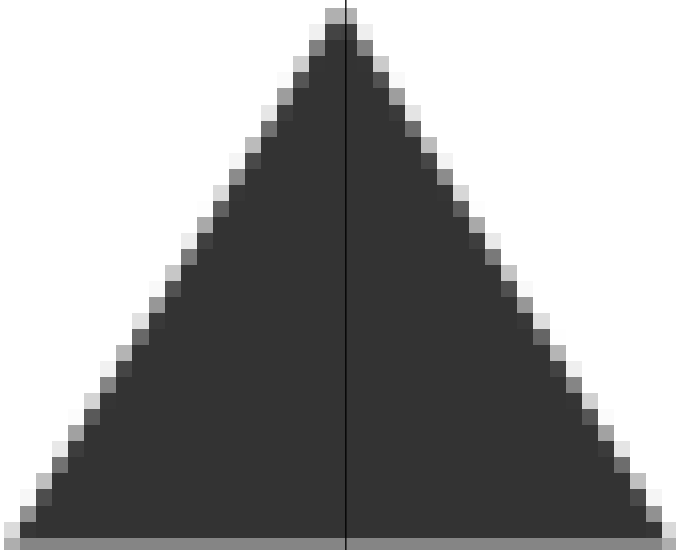
| Icon | Basic Shapes Library Block Name | Programmatic Use Value |
|---|---------------------------------|------------------------|
|  | Triangle | Triangle |

Automotive Icons

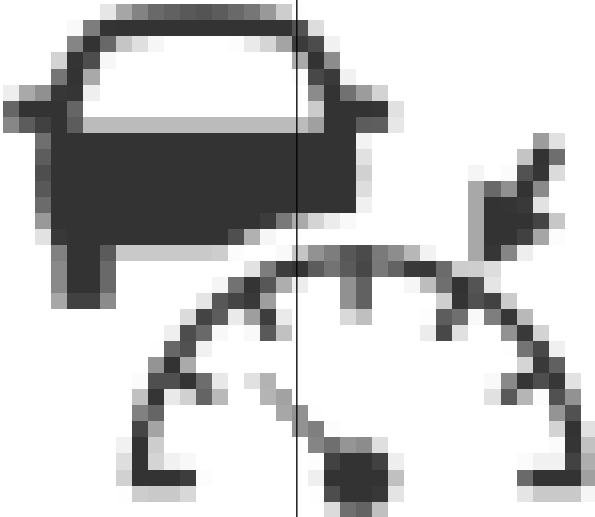
| Icon | Automotive Indicator Lamps Library Block Name | Programmatic Use Value |
|--|--|------------------------|
|  | Adaptive Cruise Control | AdaptiveCruiseControl |

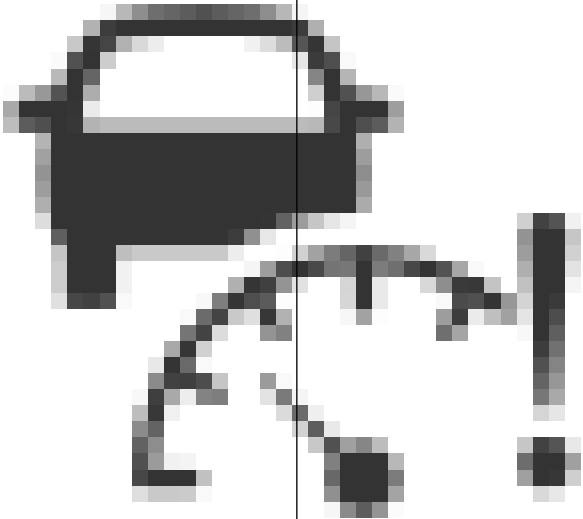
| Icon | Automotive Indicator Lamps Library Block Name | Programmatic Use Value |
|--|---|------------------------------|
|  A pixelated black and white icon showing a car from a side profile. A line extends from the front of the car to a large exclamation mark, indicating a warning or error. | Adaptive Cruise Control Failure | AdaptiveCruiseControlFailure |

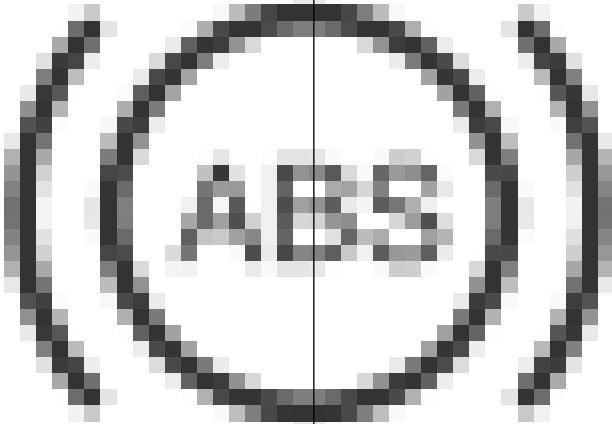
| Icon | Automotive Indicator Lamps Library Block Name | Programmatic Use Value |
|---|--|-------------------------------|
|  | Antilock Brake System | AntilockBrakeSystem |

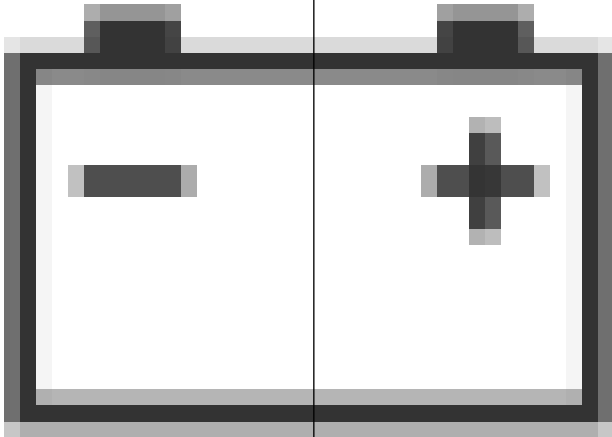
| Icon | Automotive Indicator Lamps Library Block Name | Programmatic Use Value |
|---|---|------------------------|
|  A stylized icon of a battery, consisting of a rectangular frame with two terminals on top. The left terminal is marked with a minus sign (-) and the right terminal with a plus sign (+). | Battery | Battery |

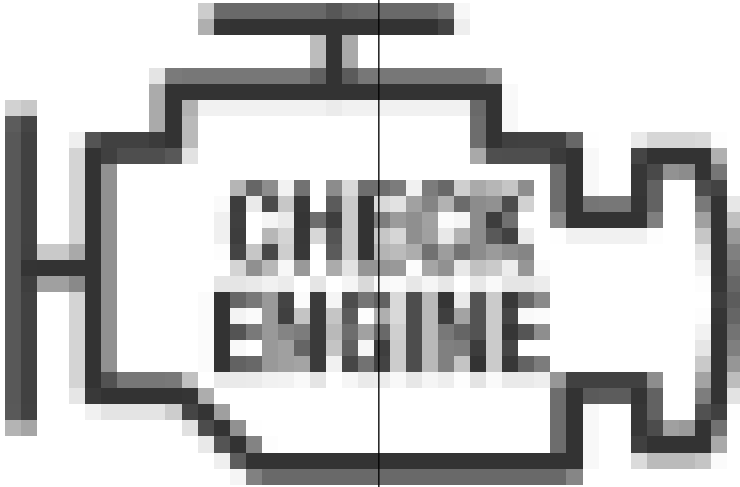
| Icon | Automotive Indicator Lamps Library Block Name | Programmatic Use Value |
|--|--|------------------------|
|  A pixelated, black and white icon of a check engine light. It features a stylized engine block with the words "CHECK ENGINE" written across the front in a bold, blocky font. The entire icon is enclosed within a thick, black, irregular border that resembles a light housing or a warning symbol. | Check Engine | CheckEngine |

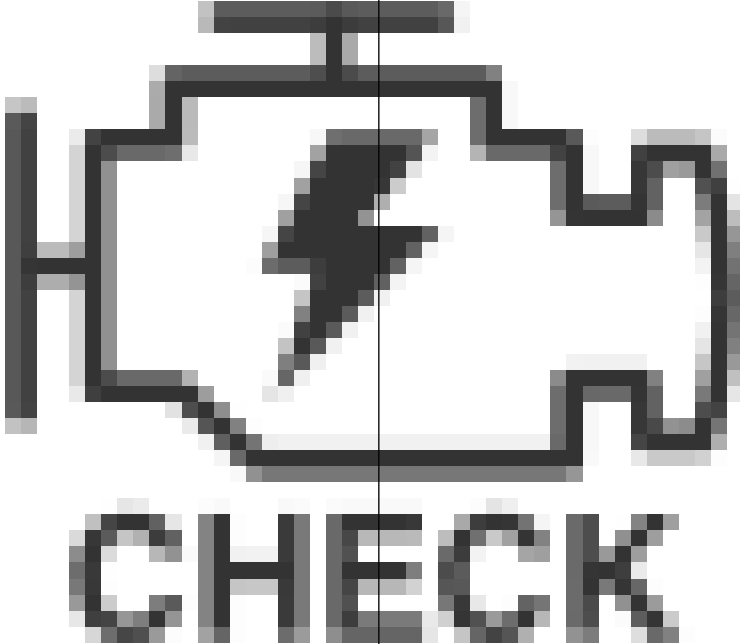
| Icon | Automotive Indicator Lamps Library Block Name | Programmatic Use Value |
|---|---|------------------------|
|  The icon depicts a check engine lamp, which is a stylized outline of an engine with a lightning bolt striking it. Below the engine graphic, the word "CHECK" is written in a bold, blocky, sans-serif font. | Check Engine2 | CheckEngine2 |

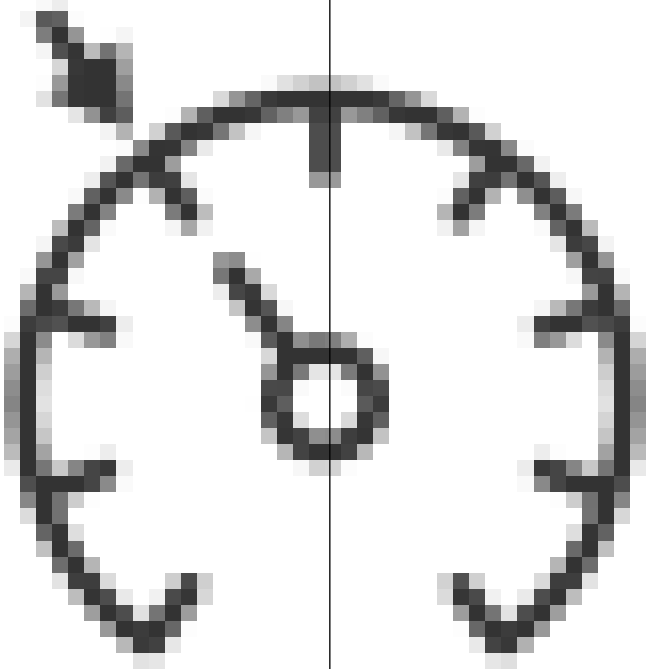
| Icon | Automotive Indicator Lamps Library Block Name | Programmatic Use Value |
|--|--|-------------------------------|
|  | Cruise Control | CruiseControl |

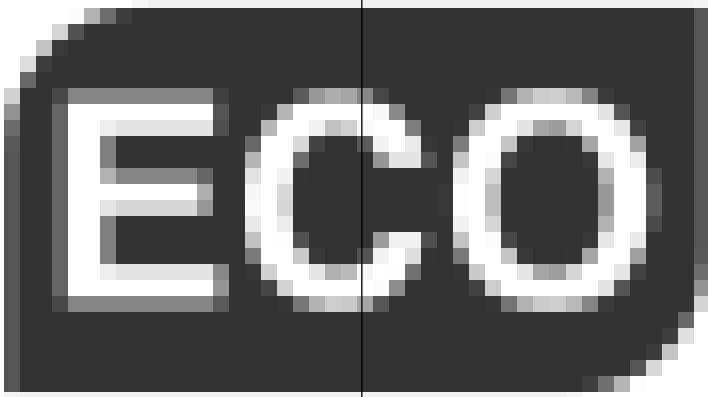
| Icon | Automotive Indicator Lamps Library Block Name | Programmatic Use Value |
|---|---|------------------------|
|  | Eco Mode | EcoMode |

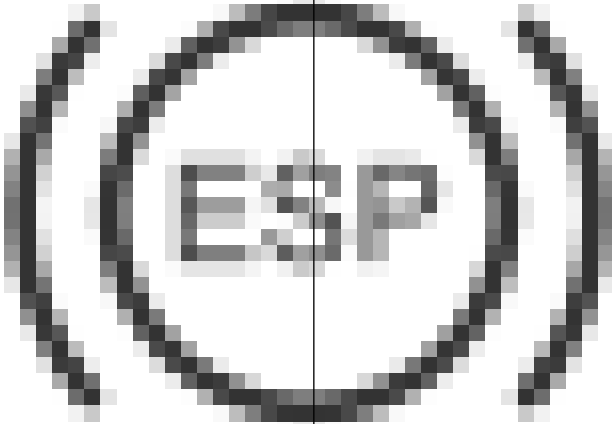
| Icon | Automotive Indicator Lamps Library Block Name | Programmatic Use Value |
|---|--|-------------------------------|
|  | Electronic Stability | ElectronicStability |

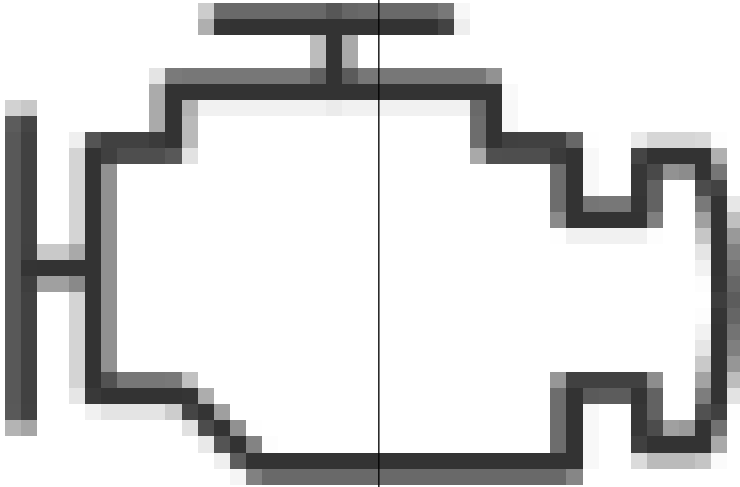
| Icon | Automotive Indicator Lamps Library Block Name | Programmatic Use Value |
|--|---|------------------------|
|  | Engine | Engine |

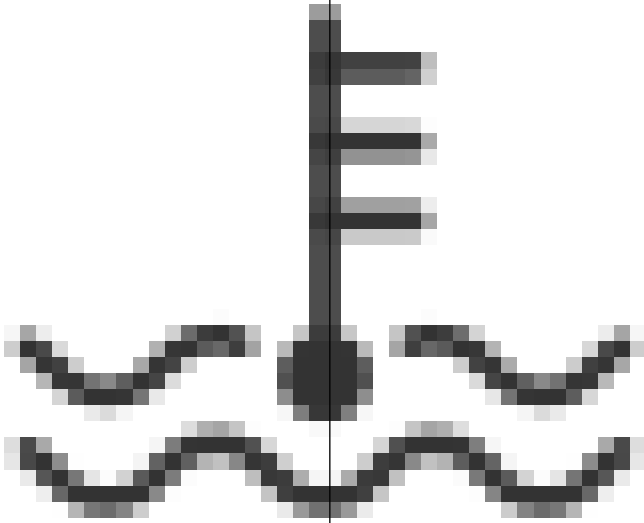
| Icon | Automotive Indicator Lamps Library Block Name | Programmatic Use Value |
|---|--|------------------------|
|  | Engine Coolant Temp | EngineCoolantTemp |

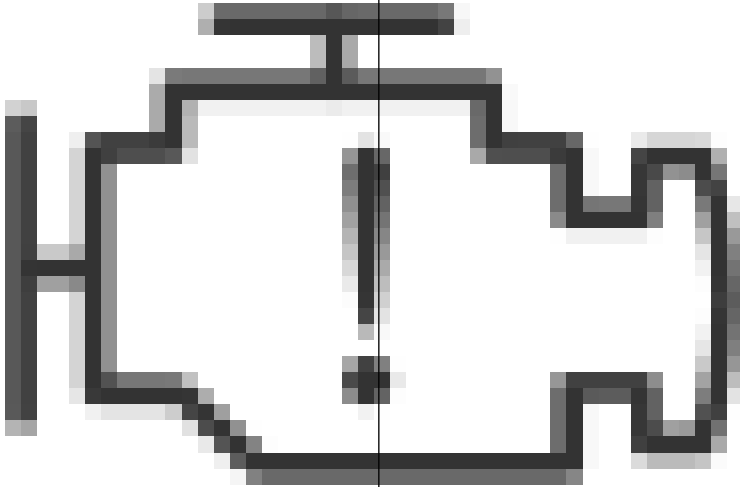
| Icon | Automotive Indicator Lamps Library Block Name | Programmatic Use Value |
|--|---|------------------------|
|  | Engine Failure | EngineFailure |

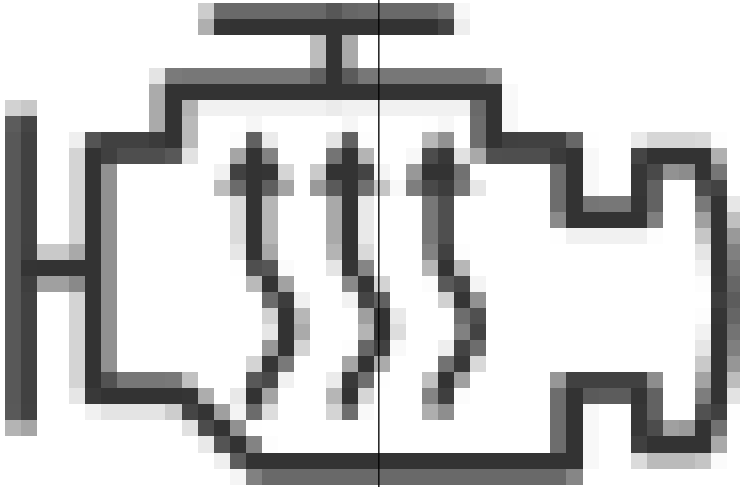
| Icon | Automotive Indicator Lamps Library Block Name | Programmatic Use Value |
|--|--|------------------------|
|  The icon depicts a stylized engine compartment. At the top center, there is a horizontal bar representing the radiator. Below it, the engine block is shown with various components, including what appears to be a water pump on the left and a fan on the right. The entire icon is rendered in a thick, black, pixelated line-art style. | Engine Heating | EngineHeating |

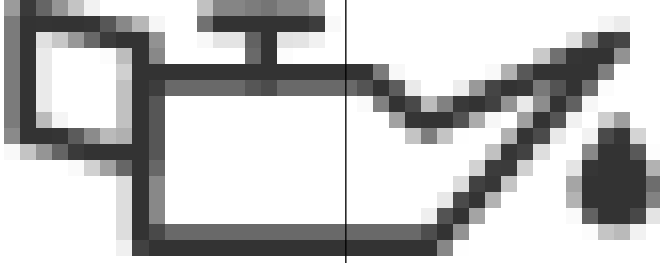
| Icon | Automotive Indicator Lamps Library Block Name | Programmatic Use Value |
|---|--|------------------------|
|  A black and white icon of an engine oil lamp. It features a rectangular base with a vertical line extending upwards from the center, topped with a horizontal bar. To the right, a diagonal line extends downwards and to the right, ending in a circular shape representing the lamp's lens. | Engine Oil | EngineOil |

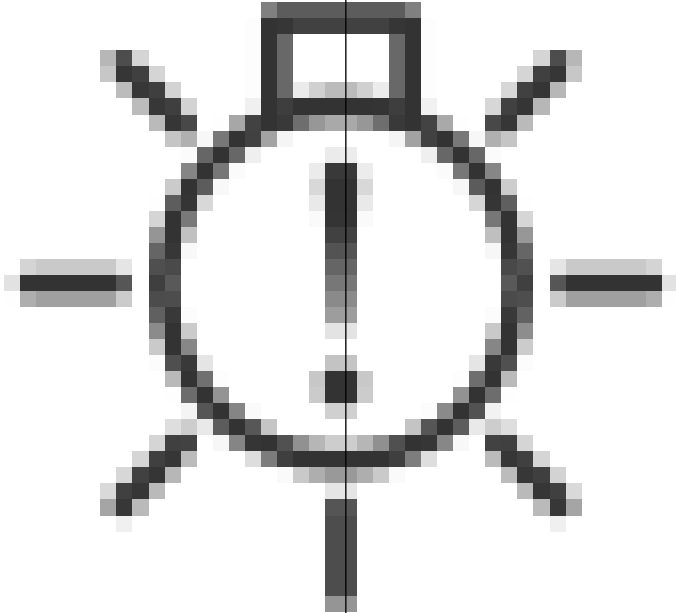
| Icon | Automotive Indicator Lamps Library Block Name | Programmatic Use Value |
|--|--|-------------------------------|
|  | Exterior Bulb Failure | ExteriorBulbFailure |

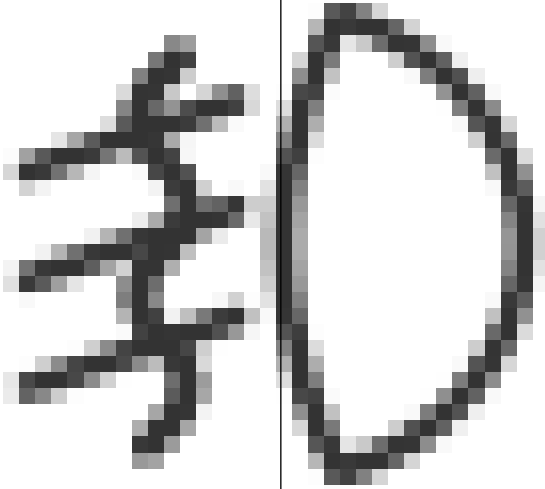
| Icon | Automotive Indicator Lamps Library Block Name | Programmatic Use Value |
|---|--|------------------------|
|  | Front Fog Light | FrontFogLight |

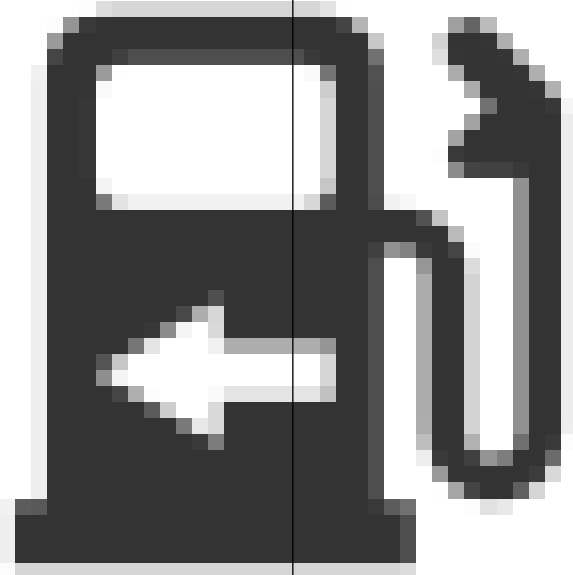
| Icon | Automotive Indicator Lamps Library Block Name | Programmatic Use Value |
|--|--|------------------------|
|  A black and white icon of a fuel pump nozzle. The nozzle is on the right, with a curved handle. A hose extends from the nozzle to a rectangular fuel tank on the left. The tank has a white cross symbol on its front face. | Fuel | Fuel |

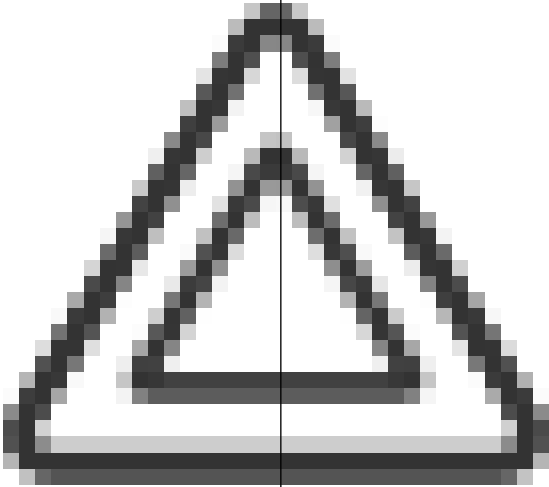
| Icon | Automotive Indicator Lamps Library Block Name | Programmatic Use Value |
|---|--|------------------------|
|  | Hazards | Hazards |

| Icon | Automotive Indicator Lamps Library Block Name | Programmatic Use Value |
|--|--|------------------------|
|  A black and white icon depicting a headlamp. The headlamp is shown in profile, facing right. It has a rectangular lens area with a curved top and bottom. To the left of the lens, there are several horizontal lines of varying lengths, representing light rays or a leveling mechanism. The entire icon is rendered in a pixelated, grayscale style. | Headlamp Leveling | HeadlampLeveling |

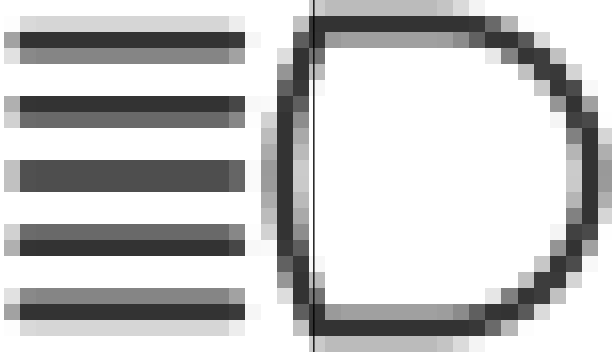
| Icon | Automotive Indicator Lamps Library Block Name | Programmatic Use Value |
|---|--|------------------------|
|  | High Beams | HighBeams |

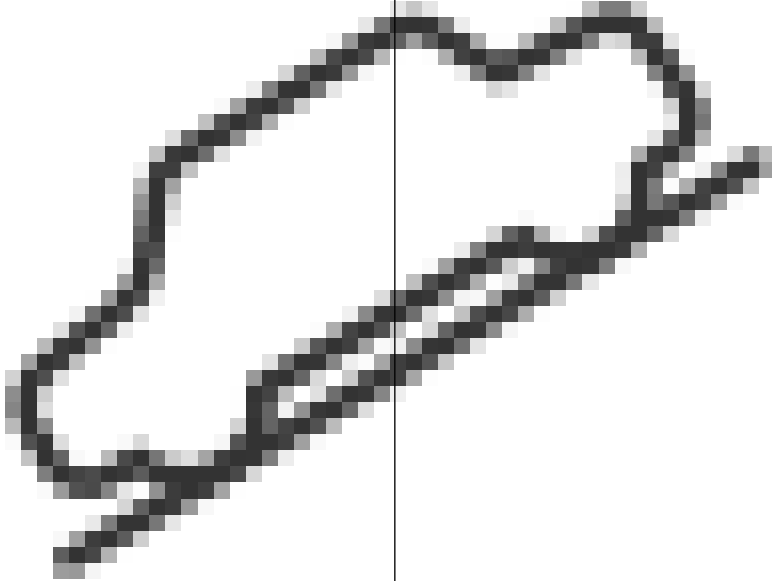
| Icon | Automotive Indicator Lamps Library Block Name | Programmatic Use Value |
|---|--|-------------------------------|
|  | Hill Descent Control | HillDescentControl |

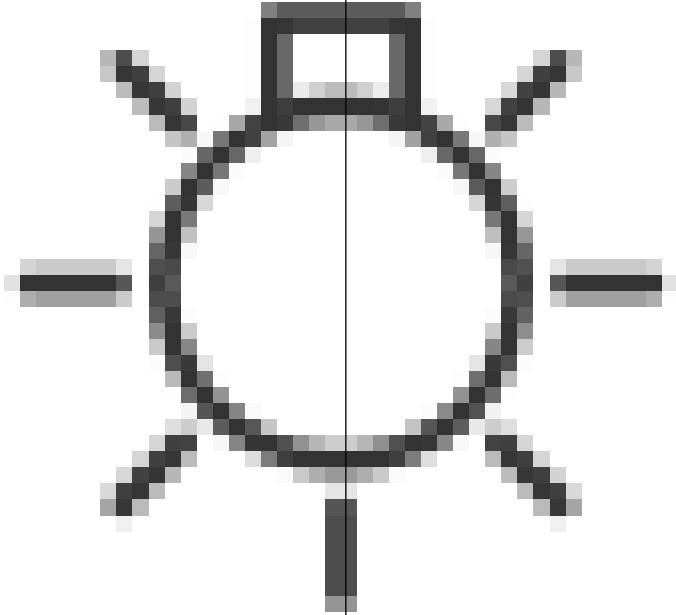
| Icon | Automotive Indicator Lamps Library Block Name | Programmatic Use Value |
|--|--|------------------------|
|  | Lighting Switch | LightingSwitch |

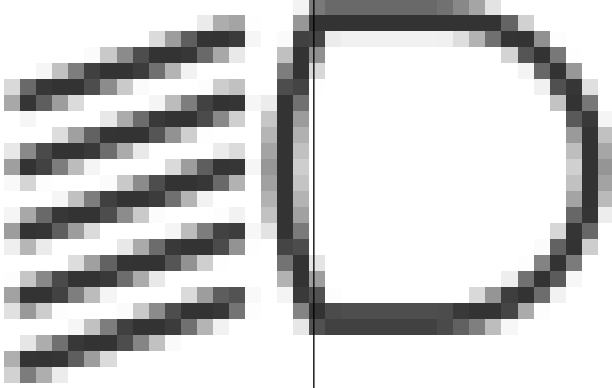
| Icon | Automotive Indicator Lamps Library Block Name | Programmatic Use Value |
|---|--|-------------------------------|
|  A pixelated icon of a low beam headlight. It features a series of horizontal lines on the left side, representing the light beam, and a large, rounded rectangular shape on the right side, representing the headlight housing. | Low Beams | LowBeams |

| Icon | Automotive Indicator Lamps Library Block Name | Programmatic Use Value |
|---|---|------------------------|
|  | Parking Assistance | ParkingAssistance |

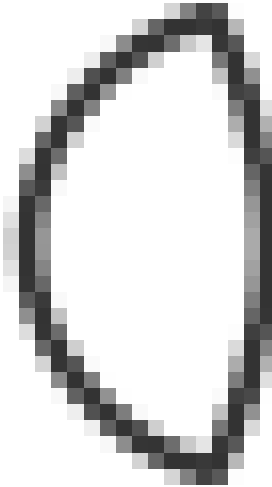
| Icon | Automotive Indicator Lamps Library Block Name | Programmatic Use Value |
|---|--|-------------------------------|
|  | Rear Fog Light | RearFogLight |

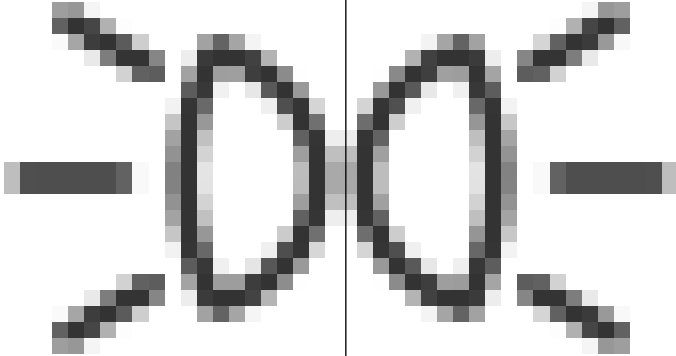
| Icon | Automotive Indicator Lamps Library Block Name | Programmatic Use Value |
|--|--|------------------------|
|  A pixelated icon showing two circular side lights. Each light has a horizontal bar extending from its center. The left light has three diagonal lines extending upwards and outwards, and the right light has three diagonal lines extending downwards and outwards. | Side Lights | SideLights |

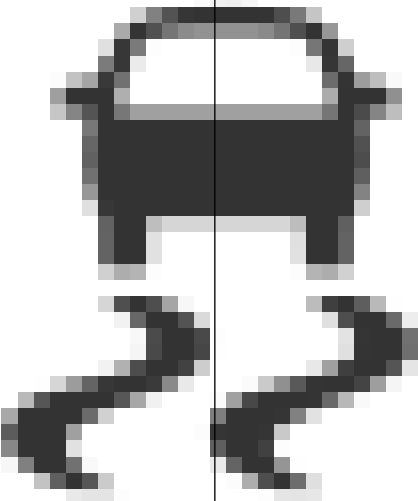
| Icon | Automotive Indicator Lamps Library Block Name | Programmatic Use Value |
|---|--|-------------------------------|
|  | Stability Control | StabilityControl |

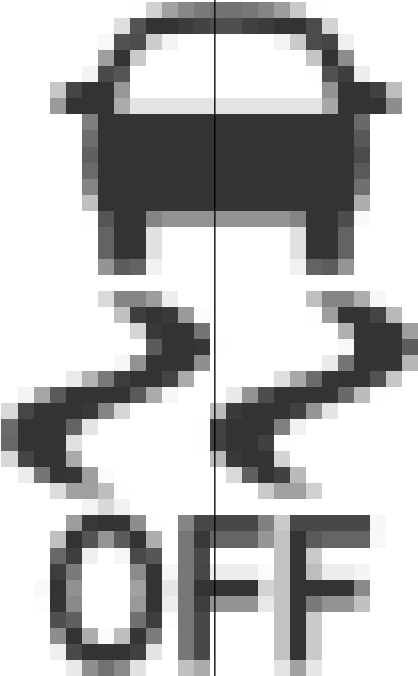
| Icon | Automotive Indicator Lamps Library Block Name | Programmatic Use Value |
|--|--|------------------------|
|  | Stability Control Off | StabilityControlOff |

| Icon | Automotive Indicator Lamps Library Block Name | Programmatic Use Value |
|---|--|-------------------------------|
|  | Tire Monitor | TireMonitor |

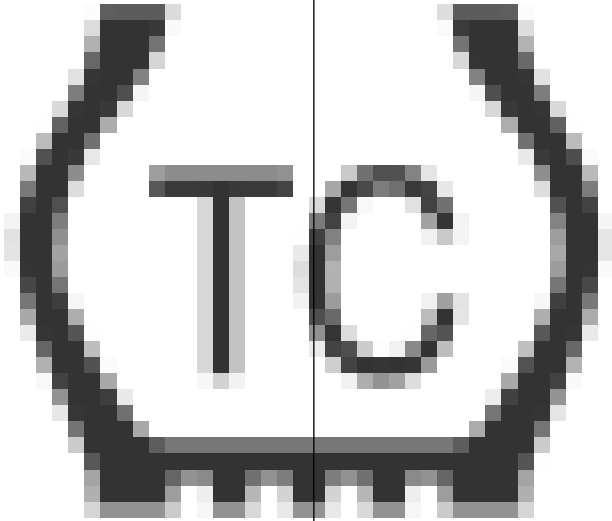
| Icon | Automotive Indicator Lamps Library Block Name | Programmatic Use Value |
|---|--|------------------------|
|  A black and white icon of a gear with the letters 'TC' in the center, representing a traction control system. | Traction Control | TractionControl |

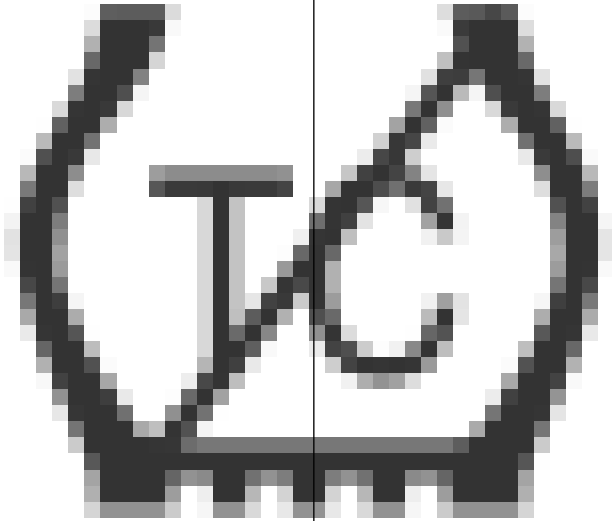
| Icon | Automotive Indicator Lamps Library Block Name | Programmatic Use Value |
|--|--|------------------------|
|  The icon depicts a stylized gear with a 'TC' symbol in the center. The gear is rendered with a thick, black, pixelated outline. The 'TC' is also in a bold, black, pixelated font, with the 'T' positioned to the left of the 'C'. The entire icon is centered within the first column of the table. | Traction Control Off | TractionControlOff |

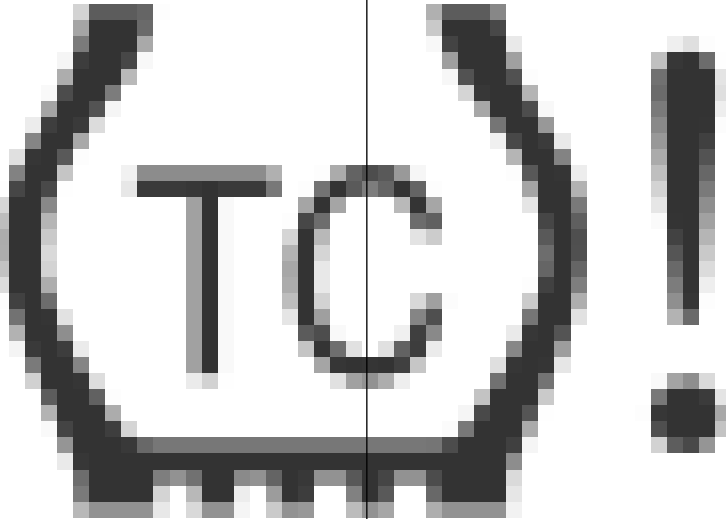
| Icon | Automotive Indicator Lamps Library Block Name | Programmatic Use Value |
|--|---|------------------------|
|  | Traction Control Failure | TractionControlFailure |

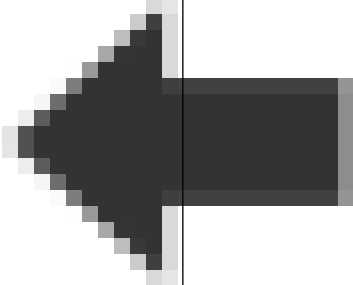
| Icon | Automotive Indicator Lamps Library Block Name | Programmatic Use Value |
|---|--|-------------------------------|
|  A black icon of a left-pointing arrow with a rectangular tail, representing a left turn signal. | Turn Signal Left | TurnSignalLeft |

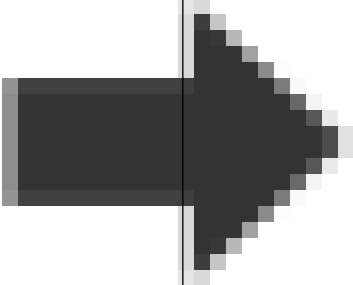
| Icon | Automotive Indicator Lamps Library Block Name | Programmatic Use Value |
|---|---|------------------------|
|  | Turn Signal Right | TurnSignalRight |

Wireless Icons

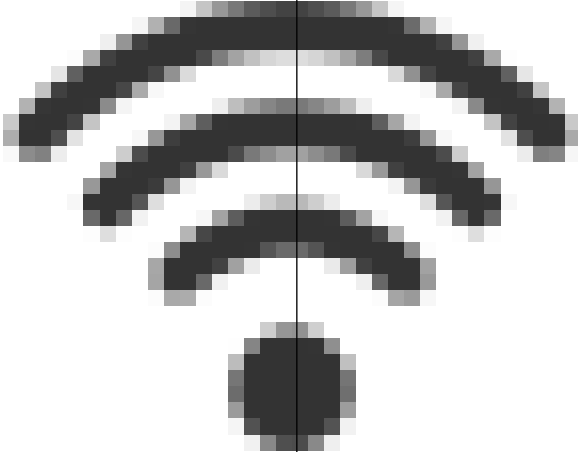
| Icon | Wireless Icons Library Block Name | Programmatic Use Value |
|---|--|-------------------------------|
|  A black and white icon representing a wireless network. It consists of three curved lines of increasing size from top to bottom, with a solid black circle at the bottom center, resembling a signal strength indicator. | Network | Network |

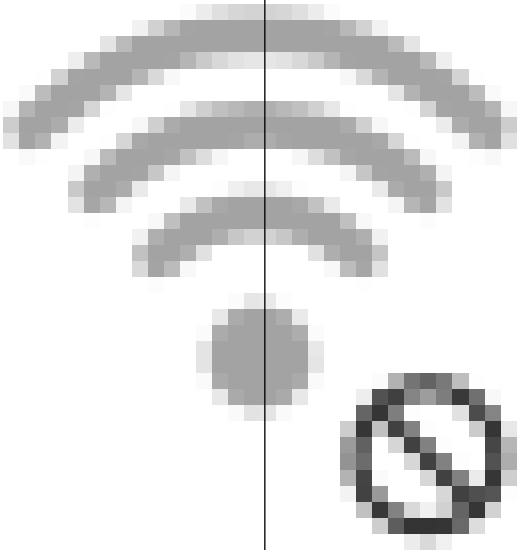
| Icon | Wireless Icons Library Block Name | Programmatic Use Value |
|--|-----------------------------------|------------------------|
|  | Network No Signal | NetworkNoSignal |

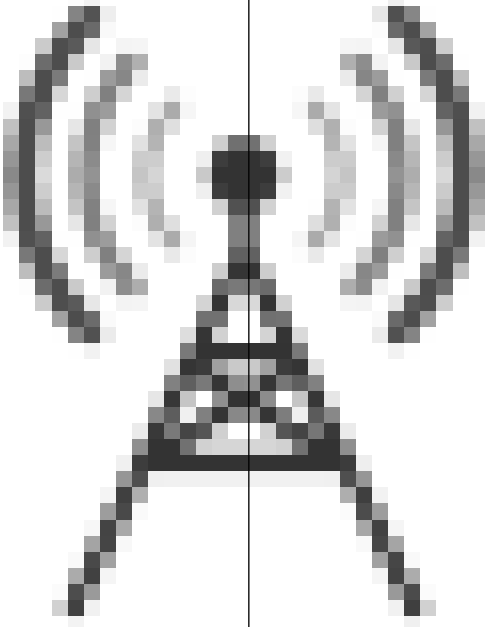
| Icon | Wireless Icons Library Block Name | Programmatic Use Value |
|--|--|-------------------------------|
|  | Network Transmission | NetworkTransmission |

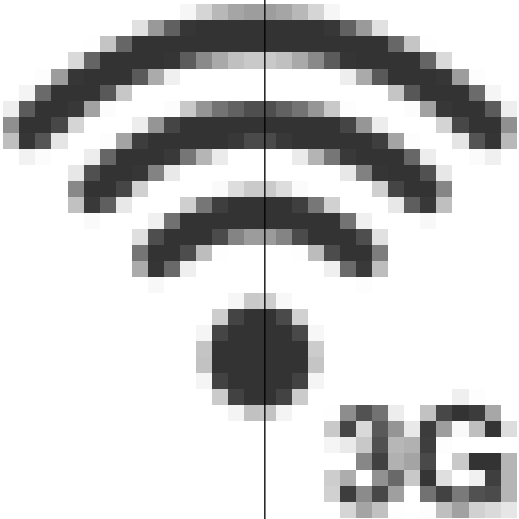
| Icon | Wireless Icons Library Block Name | Programmatic Use Value |
|---|-----------------------------------|------------------------|
|  | Network3G | Network3G |

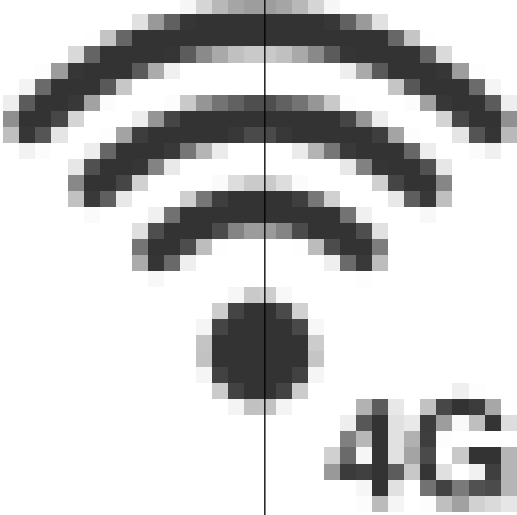
| Icon | Wireless Icons Library Block Name | Programmatic Use Value |
|--|-----------------------------------|------------------------|
|  A pixelated black and white icon of a wireless network signal. It features three curved lines of decreasing size from top to bottom, a solid black circle at the base, and the text "4G" to the right of the circle. | Network4G | Network4G |

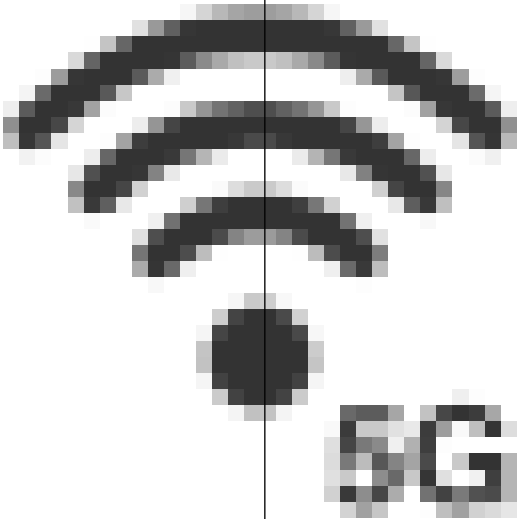
| Icon | Wireless Icons Library Block Name | Programmatic Use Value |
|---|-----------------------------------|------------------------|
|  | Network5G | Network5G |

Tips

- You can change the icon for a Lamp block using the block tab in the toolbar.
- The Dashboard library has libraries with a preconfigured Lamp block for each icon.
- If you want to customize the appearance of the Lamp block beyond the ability to select an icon, consider designing your own indicator lamp using the Lamp block in the Customizable Blocks library.

Programmatic Use

Block Parameter: Icon

Type: string | character vector

Default: 'Default'

Label — Block label position

Top (default) | Bottom | Hide

Position of the block label. When the block is connected to an element in the model, the label is the name of the connected element.

Programmatic Use

Block Parameter: LabelPosition

Type: character vector

Values: 'Top' | 'Bottom' | 'Hide'

Default: 'Top'

Opacity — Block opacity

1 (default) | scalar

Block opacity, specified as a scalar value between 0 and 1.

Example: 0.5

Programmatic Use**Block Parameter:** Opacity**Type:** scalar**Default:** 1**Block Characteristics**

| | |
|---------------------------------|---|
| Data Types | Boolean double enumerated fixed point half integer single |
| Direct Feedthrough | no |
| Multidimensional Signals | no |
| Variable-Size Signals | no |
| Zero-Crossing Detection | no |

Extended Capabilities**C/C++ Code Generation**

Generate C and C++ code using Simulink® Coder™.

Dashboard blocks are ignored for code generation.

See Also

MultiStateImage

Topics

“Tune and Visualize Your Model with Dashboard Blocks”

“Decide How to Visualize Simulation Data”

Introduced in R2015a

Level-2 MATLAB S-Function

Use Level-2 MATLAB S-function in model

Library: Simulink / User-Defined Functions

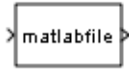

Description

This block allows you to use a Level-2 MATLAB S-function (see “Write Level-2 MATLAB S-Functions”) in a model. To do this, create an instance of this block in the model. Then enter the name of the Level-2 MATLAB S-function in the **S-function name** field of the block's parameter dialog box.

Note Use the S-Function block to include a Level-1 MATLAB S-function in a block.

If the Level-2 MATLAB S-function defines any additional parameters, you can enter them in the **Parameters** field of the block's parameter dialog box. Enter the parameters as MATLAB expressions that evaluate to their values in the order defined by the MATLAB S-function. Use commas to separate each expression.

If a model includes a Level-2 MATLAB S-Function block, and an error occurs in the S-function, the Level-2 MATLAB S-Function block displays MATLAB stack trace information for the error in a dialog box. Click **OK** to close the dialog box.

Parameters

S-Function Name — Specify S-Function name

matlabfile (default) | S-Function name

Specify the name of a MATLAB function that defines the behavior of this block. The MATLAB function must follow the Level-2 standard for writing MATLAB S-functions (see “Write Level-2 MATLAB S-Functions” for details).

Programmatic Use

Block Parameter: FunctionName

Type: character vector

Values: 'matlabfile' | S-Function name

Default: 'matlabfile'

Parameters — Specify values of parameters for this block

no default (default)

Specify values of parameters for this block.

Programmatic Use

Block Parameter: Parameters

Type: character vector
Values: values of block parameters
Default: ' '

Block Characteristics

| | |
|---------------------------------|--|
| Data Types | Boolean ^a double ^a fixed point ^a integer ^a single ^a |
| Direct Feedthrough | yes |
| Multidimensional Signals | yes |
| Variable-Size Signals | yes |
| Zero-Crossing Detection | no |

a. Level-1 MATLAB S-functions support only the double data type. Level-2 MATLAB S-functions support all data types that Simulink supports.

Extended Capabilities

C/C++ Code Generation

Generate C and C++ code using Simulink® Coder™.

- If a corresponding TLC file is available, the Level-2 MATLAB S-Function block uses the TLC file to generate code, otherwise code generation throws an error.
- Real-time code generation does not support S-functions that call MATLAB.
- Actual data type or capability support depends on block implementation.

Fixed-Point Conversion

Design and simulate fixed-point systems using Fixed-Point Designer™.

Level-1 MATLAB S-functions support only the double data type. Level-2 MATLAB S-functions support all data types that Simulink supports.

See Also

Blocks

MATLAB Function | MATLAB System | Simulink Function | Subsystem, Atomic Subsystem, Nonvirtual Subsystem, CodeReuse Subsystem | S-Function | S-Function Builder

Topics

“What Is an S-Function?”
 “Write Level-2 MATLAB S-Functions”
 “Design and Create a Custom Block”

Introduced in R2010b

Linear Gauge

Display input value on linear scale

Library: Simulink / Dashboard

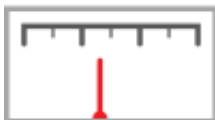

Description

The Linear Gauge block displays the connected signal on a straight linear scale during simulation. Use the Linear Gauge block with other Dashboard blocks to build an interactive dashboard of controls and indicators for your model. The Linear Gauge block provides an indication of the instantaneous value of the connected signal throughout simulation. You can modify the range of the Linear Gauge block to fit your data. You can also customize the appearance of the Linear Gauge block to provide more information about your signal. For example, you can color-code in-specification and out-of-specification ranges.

Connect Dashboard Blocks

Dashboard blocks do not use ports to connect to model elements. To connect dashboard blocks to signals in your model, use connect mode. Connect mode facilitates the process of connecting dashboard blocks in your model, especially when you want to connect multiple blocks at once. To connect a single dashboard block, you can also use the **Connection** table in the block dialog box.

Tip You can modify dashboard block connections during normal and accelerator mode simulations.

To enter connect mode, select a dashboard block to connect. Then, on the block tab, click **Connect**. In connect mode, when you select one or more signals or blocks, a list of signals that are available for connection appears. Select a signal from the list to connect to the selected dashboard block. To connect another dashboard block, pause on the block you want to connect and click the **Connect** button above it. Then, select one or more signals and blocks in the model and choose a signal to connect.

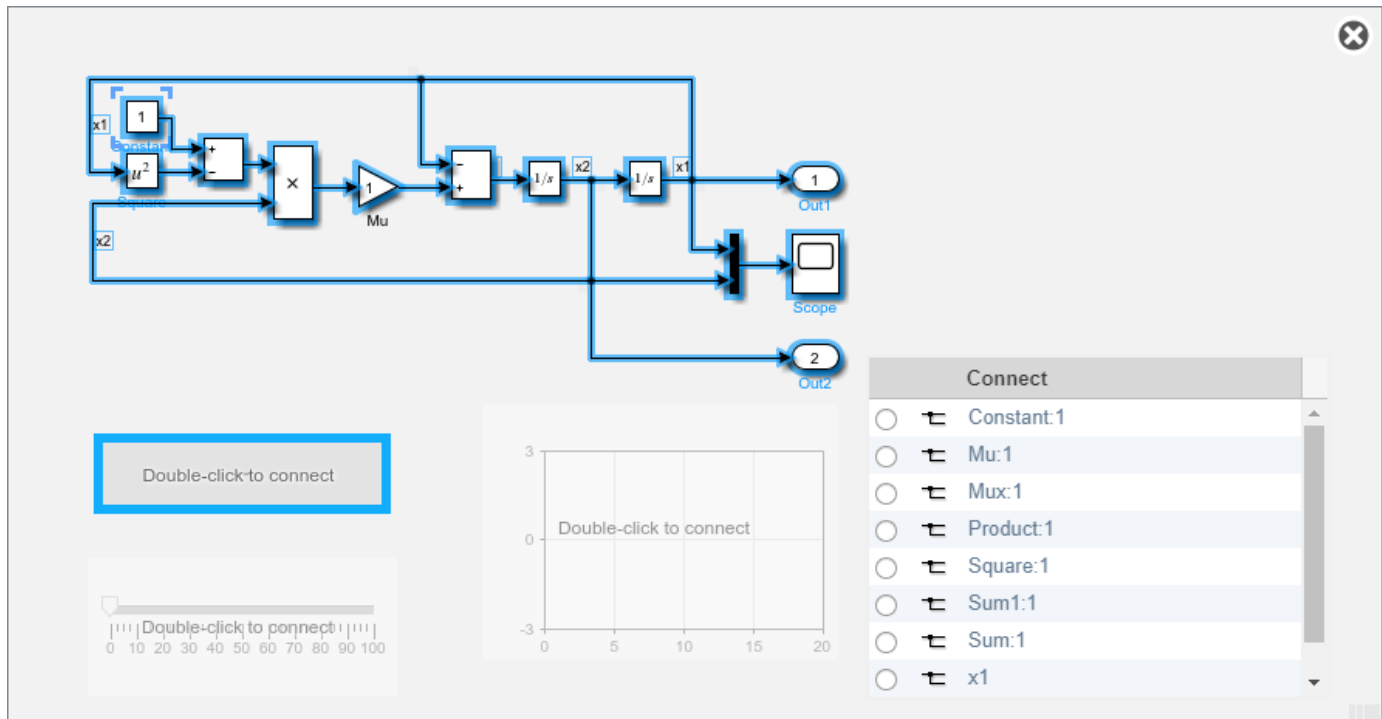

When you finish connecting the dashboard blocks in your model, on the block tab, click **Done Connecting**.

Tip You can hide the message shown on unconnected blocks using the `set_param` function with the `ShowInitialText` block parameter. The message also disappears when you connect the block.

Limitations

- Except for the Dashboard Scope block and the Display block, dashboard blocks can only connect to real scalar signals.
- The toolstrip does not support blocks that are inside a panel.
- You cannot use the **Connection** table in the block dialog to connect a dashboard block to a block that is commented out. When you connect a dashboard block to a commented block using connect mode, the dashboard block does not display the connected value until the you uncomment the block.
- Dashboard blocks cannot connect to model elements inside referenced models.
- When you simulate a model hierarchy, dashboard blocks inside referenced models do not update.
- Dashboard blocks do not support rapid accelerator simulation.
- You cannot connect a dashboard block to data or activity in Stateflow during simulation.
- Some signals do not have data available during simulation due to block reduction or optimization for accelerator mode simulations. To view such a signal using a dashboard block, mark the signal for logging.

Parameters

Signal

Connection — Signal to connect and display

signal connection options

Use the connection table to select the signal to connect to the block. To connect the block to a signal:

- 1 Make a selection in the model that includes one or more signals.
- 2 In the table, select the signal you want to connect.
- 3 Click **Apply**.

Tip You can connect dashboard blocks to signals in the model during simulation.

Programmatic Use

Block Parameter: Binding

Type: Simulink.HMI.SignalSpecification

Default: []

Main

Minimum — Minimum tick mark value

0 (default) | scalar

Finite, real, double, scalar value specifying the minimum tick mark value for the scale. The minimum must be less than the value of the **Maximum** parameter.

Programmatic Use

To programmatically set the Minimum parameter, use a 1-by-3 vector containing values for the Minimum, Tick Interval, and Maximum parameters, in that order. To use the `auto` value for the Tick Interval, leave the Tick Interval position in the vector empty or specify -1.

Block Parameter: Limits

Type: 1x3 vector

Default: [0 -1 100]

Maximum — Maximum tick mark value

100 (default) | scalar

Finite, real, double, scalar value specifying the maximum tick mark value for the scale. The maximum must be greater than the value of the **Minimum** parameter.

Programmatic Use

To programmatically set the Maximum parameter, use a 1-by-3 vector containing values for the Minimum, Tick Interval, and Maximum parameters, in that order. To use the `auto` value for the Tick Interval, leave the Tick Interval position in the vector empty or specify -1.

Block Parameter: Limits

Type: 1x3 vector

Default: [0 -1 100]

Tick Interval — Interval between major tick marks

auto (default) | scalar

Finite, real, positive, whole, scalar value specifying the interval of major tick marks on the scale. When set to `auto`, the block automatically adjusts the tick interval based on the values of the **Maximum** and **Minimum** parameters.

Programmatic Use

To programmatically set the `Tick Interval` parameter, use a 1-by-3 vector containing values for the `Minimum`, `Tick Interval`, and `Maximum` parameters, in that order. To use the `auto` value for the `Tick Interval`, leave the `Tick Interval` position in the vector empty or specify `-1`.

Block Parameter: Limits

Type: 1x3 vector

Default: [0 -1 100]

Scale Colors — Color indications on gauge scale

colors for scale ranges

Color specifications for value ranges on the scale. Press the **+** button to add a scale color. For each color added, specify the minimum and maximum values of the range in which you want to display that color.

Programmatic Use

To programmatically specify the `Scale Colors` parameter, use an array of structures with the fields:

- `Min` — Minimum value for the color range on the scale
- `Max` — Maximum value for the color range on the scale
- `Color` — 1-by-3 vector of double values between 0 and 1 that specify the color for the range in the form [r g b]

Include a structure in the array for each scale range for which you want to specify a color.

```
range1.Min = 0;  
range1.Max = 10;  
range1.Color = [0 0 1];  
range2.Min = 10;  
range2.Max = 15;  
range2.Color = [0 1 0];  
scaleRanges = [range1 range2];
```

Block Parameter: ScaleColors

Type: structure array

Default: 0x1 struct array

Label — Block label position

Top (default) | Bottom | Hide

Position of the block label. When the block is connected to an element in the model, the label is the name of the connected element.

Programmatic Use

Block Parameter: LabelPosition

Type: character vector

Values: 'Top' | 'Bottom' | 'Hide'

Default: 'Top'

Format

Opacity — Block background opacity

1 (default) | scalar

Block background opacity, specified as a scalar value between 0 and 1.

Example: 0.5

Programmatic Use

Block Parameter: Opacity

Type: scalar

Default: 1

Foreground Color — Block foreground color

[r g b] vector

Block foreground color, excluding the text. The **Foreground Color** applies to the scale and the block name. You can select a color from a palette of standard colors or specify a custom color. To specify the color for the block text, use the **Font Color**.

Programmatic Use

Specify the `ForegroundColor` parameter for the block as a 1-by-3 [r g b] vector with values between 0 and 1.

Block Parameter: `ForegroundColor`

Type: [r g b] vector

Background Color — Block background color

[r g b] vector

Block background color. You can select a color from a palette of standard colors or specify a custom color.

Programmatic Use

Specify the `BackgroundColor` parameter for the block as a 1-by-3 [r g b] vector with values between 0 and 1.

Block Parameter: `BackgroundColor`

Type: [r g b] vector

Font Color — Block font color

[r g b] vector

Block font color. The **Font Color** applies to the tick labels on the scale. You can select a color from a palette of standard colors or specify a custom color.

Programmatic Use

Specify the `FontColor` parameter for the block as a 1-by-3 [r g b] vector with values between 0 and 1.

Block Parameter: `FontColor`

Type: [r g b] vector

Block Characteristics

| | |
|---------------------------------|---|
| Data Types | Boolean double enumerated fixed point half integer single |
| Direct Feedthrough | no |
| Multidimensional Signals | no |
| Variable-Size Signals | no |
| Zero-Crossing Detection | no |

Extended Capabilities

C/C++ Code Generation

Generate C and C++ code using Simulink® Coder™.

Dashboard blocks are ignored for code generation.

See Also

Gauge | Half Gauge | Quarter Gauge | Circular Gauge

Topics

“Tune and Visualize Your Model with Dashboard Blocks”

“Decide How to Visualize Simulation Data”

Introduced in R2015a

Logical Operator

Perform specified logical operation on input

Library: Simulink / Commonly Used Blocks
 Simulink / Logic and Bit Operations
 HDL Coder / Commonly Used Blocks
 HDL Coder / Logic and Bit Operations



Description

The Logical Operator block performs the specified logical operation on its inputs. An input value is true (1) if it is nonzero and false (0) if it is zero.

You select the Boolean operation connecting the inputs with the **Operator** parameter list. If you select **rectangular** as the **Icon shape** property, the name of the selected operator displays on the block icon. If you select **distinctive** as the **Icon shape** property, the name of the selected operator does not display on the block icon. This table shows supported operations:

| Operation | Description |
|-----------|---|
| AND | TRUE if all inputs are TRUE |
| OR | TRUE if at least one input is TRUE |
| NAND | TRUE if at least one input is FALSE |
| NOR | TRUE when no inputs are TRUE |
| XOR | TRUE if an odd number of inputs are TRUE |
| NXOR | TRUE if an even number of inputs are TRUE |
| NOT | TRUE if the input is FALSE |

If you select **distinctive** as the **Icon shape**, the block appearance indicates its function. Simulink software displays a distinctive shape for the selected operator, conforming to the IEEE Standard Graphic Symbols for Logic Functions.



To specify the number of input ports, use the **Number of input ports** parameter. The output type is specified using the **Output data type** parameter. An output value is 1 if TRUE and 0 if FALSE.

Note The output data type should represent zero exactly. Data types that satisfy this condition include signed and unsigned integers, and any floating-point data type.

The size of the output depends on input vector size and the selected operator:

- If the block has more than one input, any nonscalar inputs must have the same dimensions. For example, if any input is a 2-by-2 array, all other nonscalar inputs must also be 2-by-2 arrays.

Scalar inputs are expanded to have the same dimensions as the nonscalar inputs.

If the block has more than one input, the output has the same dimensions as the inputs (after scalar expansion) and each output element is the result of applying the specified logical operation to the corresponding input elements. For example, if the specified operation is AND and the inputs are 2-by-2 arrays, the output is a 2-by-2 array whose top left element is the result of applying AND to the top left elements of the inputs, and so on.

- For a single vector input, the block applies the operation (except the NOT operator) to all elements of the vector. The output is always a scalar.
- The NOT operator accepts only one input, which can be a scalar or a vector. If the input is a vector, the output is a vector of the same size containing the logical complements of the input vector elements.

When configured as a multi-input XOR gate, this block performs an addition modulo two operation as mandated by the IEEE Standard for Logic Elements.

Ports

Input

Port_1 — First input signal

scalar | vector | matrix

First input signal, specified as a scalar, vector, or matrix.

Data Types: half | single | double | int8 | int16 | int32 | int64 | uint8 | uint16 | uint32 | uint64 | Boolean | fixed point

Port_2 — Second input signal

scalar | vector | matrix

Second input signal, specified as a scalar, vector, or matrix.

Data Types: half | single | double | int8 | int16 | int32 | int64 | uint8 | uint16 | uint32 | uint64 | Boolean | fixed point

Port_N — Nth input signal

scalar | vector | matrix

Nth input signal, specified as a scalar, vector, or matrix.

Dependencies

To enable additional input ports, use the **Number of input ports** parameter.

Data Types: half | single | double | int8 | int16 | int32 | int64 | uint8 | uint16 | uint32 | uint64 | Boolean | fixed point

Output

Port_1 — Output signal

scalar | vector | matrix

Output signal, consisting of zeros and ones, with the same dimensions as the input. You control the output data type with the **Require all inputs and output to have the same data type** and **Output data type** parameters.

Data Types: half | single | double | int8 | int16 | int32 | int64 | uint8 | uint16 | uint32 | uint64 | Boolean | fixed point

Parameters

Main

Operator — Logical operator

AND (default) | OR | NAND | NOR | XOR | NXOR | NOT

Select the logical operator to apply to block inputs.

- AND — T if all inputs are TRUE
- OR — TRUE if at least one input is TRUE
- NAND — TRUE if at least one input is FALSE
- NOR — TRUE when no inputs are TRUE
- XOR — TRUE if an odd number of inputs are TRUE
- NXOR — TRUE if an even number of inputs are TRUE
- NOT — TRUE if the input is FALSE

Programmatic Use

Block Parameter: Operator

Type: character vector

Values: 'AND' | 'OR' | 'NAND' | 'NOR' | 'XOR' | 'NXOR' | 'NOT'

Default: 'AND'

Number of input ports — Number of inputs

2 (default) | positive integer

Specify the number of block inputs as a positive integer.

Programmatic Use

Block Parameter: Inputs

Type: character vector

Values: positive integer

Default: '2'

Dependencies

This parameter is not available when you set the **Operator** to NOT.

Icon shape — Icon shape

rectangular (default) | distinctive

Specify the shape of the block icon.

- `rectangular` — Results in a rectangular block that displays the name of the selected operator.
- `distinctive` — Use the graphic symbol for the selected operator as specified by the IEEE standard.

Programmatic Use**Block Parameter:** `IconShape`**Type:** character vector**Values:** `'rectangular'` | `'distinctive'`**Default:** `'rectangular'`**Sample time — Specify sample time as a value other than -1**`-1` (default) | scalar | vector

Specify the sample time as a value other than -1. For more information, see “Specify Sample Time”.

Dependencies

This parameter is not visible unless it is explicitly set to a value other than -1. To learn more, see “Blocks for Which Sample Time Is Not Recommended”.

Programmatic Use**Block Parameter:** `SampleTime`**Type:** character vector**Values:** scalar or vector**Default:** `'-1'`**Data Type****Require all inputs and output to have the same data type — Require all ports to have same data type**`off` (default) | `on`

To require that all block inputs and the output have the same data type, select this check box. When you clear this check box, the inputs and output can have different data types.

Programmatic Use**Block Parameter:** `AllPortsSameDT`**Type:** character vector**Values:** `'off'` | `'on'`**Default:** `'off'`**Output data type — Output data type**`boolean` (default) | `Inherit: Logical` (see Configuration Parameters: Optimization) | `fixdt(1,16)` | `<data type expression>`

Specify the output data type. When you select:

- `boolean` — The block output has data type `boolean`.
- `Inherit: Logical` (see Configuration Parameters: Optimization) — The block uses the **Implement logic signals as Boolean data** configuration parameter to specify the output data type (see “Implement logic signals as Boolean data (vs. double)”).

Note This option supports models created before the `boolean` option was available. Use one of the other options, preferably `boolean`, for new models.

- `fixdt(1,16)` — The block output has the specified fixed-point data type `fixdt(1,16)`.

Tip Click the **Show data type assistant** button  to display the **Data Type Assistant**, which helps you set the data type attributes. For more information, see “Specify Data Types Using Data Type Assistant”.

- `<data type expression>` — The block output has the data type you specify as a data type expression, for example, `Simulink.NumericType`.

Tip To enter a built-in data type (`double`, `single`, `int8`, `uint8`, `int16`, `uint16`, `int32`, or `uint32`), enclose the expression in single quotes. For example, enter `'double'` instead of `double`.

Programmatic Use

Block Parameter: `OutDataTypeStr`

Type: character vector

Values: `'Inherit: Logical (see Configuration Parameters: Optimization)'` | `'boolean'` | `'fixdt(1,16)'` | `'<data type expression>'`

Default: `'boolean'`

Block Characteristics

| | |
|---------------------------------|--|
| Data Types | Boolean double fixed point half integer single |
| Direct Feedthrough | yes |
| Multidimensional Signals | yes |
| Variable-Size Signals | yes |
| Zero-Crossing Detection | no |

Extended Capabilities

C/C++ Code Generation

Generate C and C++ code using Simulink® Coder™.

HDL Code Generation

Generate Verilog and VHDL code for FPGA and ASIC designs using HDL Coder™.

HDL Coder provides additional configuration options that affect HDL implementation and synthesized logic.

HDL Architecture

This block has a single, default HDL architecture.

HDL Block Properties

| | |
|----------------------------------|--|
| ConstrainedOutputPipeline | Number of registers to place at the outputs by moving existing delays within your design. Distributed pipelining does not redistribute these registers. The default is 0. For more details, see “ConstrainedOutputPipeline” (HDL Coder). |
| InputPipeline | Number of input pipeline stages to insert in the generated code. Distributed pipelining and constrained output pipelining can move these registers. The default is 0. For more details, see “InputPipeline” (HDL Coder). |
| OutputPipeline | Number of output pipeline stages to insert in the generated code. Distributed pipelining and constrained output pipelining can move these registers. The default is 0. For more details, see “OutputPipeline” (HDL Coder). |

PLC Code Generation

Generate Structured Text code using Simulink® PLC Coder™.

Fixed-Point Conversion

Design and simulate fixed-point systems using Fixed-Point Designer™.

See Also

Relational Operator | Combinatorial Logic | “Implement logic signals as Boolean data (vs. double)”

Introduced before R2006a

1-D Lookup Table

Approximate one-dimensional function

Library: Simulink / Lookup Tables
HDL Coder / Lookup Tables

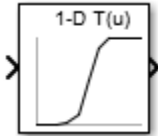

Description

Supported Block Operations

The 1-D, 2-D, and n-D Lookup Table blocks evaluate a sampled representation of a function in N variables

$$y = F(x_1, x_2, x_3, \dots, x_N)$$

where the function F can be empirical. The block maps inputs to an output value by looking up or interpolating a table of values you define with block parameters. The block supports flat (constant), linear (linear point-slope), Lagrange (linear Lagrange), nearest, cubic-spline, and Akima spline interpolation methods. You can apply these methods to a table of any dimension from 1 through 30.

In the following block, the first input identifies the first dimension (row) breakpoints, the second input identifies the second dimension (column) breakpoints, and so on.

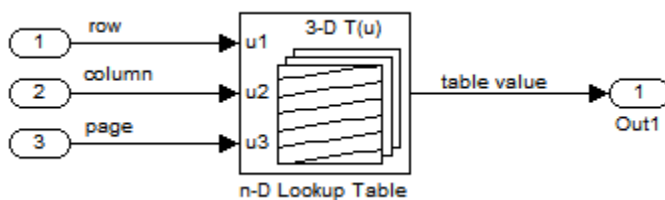

See “Port Location After Rotating or Flipping” for a description of the port order for various block orientations.

When the **Math and Data Types > Use algorithms optimized for row-major array layout** configuration parameter is set, the 2-D and n-D Lookup Table block behavior changes from column-major to row-major. For these blocks, the column-major and row-major algorithms may differ in the order of the output calculations, possibly resulting in slightly different numerical values. This capability requires a Simulink Coder or Embedded Coder license. For more information on row-major support, see “Code Generation of Matrices and Arrays” (Simulink Coder).

Specification of Breakpoint and Table Data

These block parameters define the breakpoint and table data.

| Block Parameter | Purpose |
|-----------------------------------|--|
| Number of table dimensions | Specifies the number of dimensions of your lookup table. |
| Breakpoints | Specifies a breakpoint vector that corresponds to each dimension of your lookup table. |
| Table data | Defines the associated set of output values. |

Tip Evenly spaced breakpoints can make the generated code division-free. For more information, see `fixpt_evenspace_cleanup` and “Identify questionable fixed-point operations” (Embedded Coder).

How the Block Generates Output

The n-D, 1-D and 2-D Lookup Table blocks generate output by looking up or estimating table values based on the input values.

| Block Inputs | n-D Lookup Table Block Behavior |
|--|--|
| Match the values of indices in breakpoint data sets | Outputs the table value at the intersection of the row, column, and higher dimension breakpoints |
| Do not match the values of indices in breakpoint data sets, but are within range | Interpolates appropriate table values, using the Interpolation method you select |
| Do not match the values of indices in breakpoint data sets, and are out of range | Extrapolates the output value, using the Extrapolation method you select |

Other Blocks that Perform Equivalent Operations

You can use the Interpolation Using Prelookup block with the Prelookup block to perform the equivalent operation of one n-D Lookup Table block. This combination of blocks offers greater flexibility that can result in more efficient simulation performance for linear interpolations.

When the lookup operation is an array access that does not require interpolation, use the Direct Lookup Table (n-D) block. For example, if you have an integer value k and you want the k th element of a table, $y = \text{table}(k)$, interpolation is unnecessary.

Ports

Input

u1 — First-dimension (row) inputs

scalar | vector | matrix

Real-valued inputs to the **u1** port, mapped to an output value by looking up or interpolating the table of values that you define.

Example: `0:10`

Data Types: `half` | `single` | `double` | `int8` | `int16` | `int32` | `int64` | `uint8` | `uint16` | `uint32` | `uint64` | `enumerated` | `fixed point`

T — Define the table of output values

matrix of values with dimensions that match the **Number of table dimensions** and the breakpoint lengths for each dimension of the table

Specify the table of output values with a signal that is tunable at runtime.

During simulation, the matrix size must match the dimensions defined by the **Number of table dimensions** parameter. However, during block diagram editing, you can enter an empty matrix (specified as []) or an undefined workspace variable. This technique lets you postpone specifying a correctly dimensioned matrix for the table data and continue editing the block diagram.

Dependencies

To enable this port, set:

- **Data specification** to Table and breakpoints.
- **Table data** to Input port.

Data Types: half | single | double | int8 | int16 | int32 | int64 | uint8 | uint16 | uint32 | uint64 | fixed point

bp1 — Explicit breakpoint values

1-by-n or n-by-1 vector of monotonically increasing values

Specify the breakpoint data explicitly, based on the value of the **Breakpoints specification** parameter, with a signal that is tunable at runtime.

- If you set **Breakpoints specification** to Explicit values, enter the breakpoint set that corresponds to each dimension of table data in each **Breakpoints** row. For each dimension, specify breakpoints as a 1-by-n or n-by-1 vector whose values are strictly monotonically increasing.

Note To specify breakpoints in the even spacing specification format, set **Breakpoints specification** to Even spacing and use the **Breakpoints First** point and **Spacing** parameters.

Dependencies

To enable this port, set:

- **Data specification** to Table and breakpoints.
- **Breakpoints specification** to Explicit values.
- **Breakpoints 1** to Input port.

Data Types: half | single | double | int8 | int16 | int32 | int64 | uint8 | uint16 | uint32 | uint64 | enumerated | fixed point

Output**Port_1 — Output computed by looking up or estimating table values**

scalar | vector | matrix

Output generated by looking up or estimating table values based on the input values.

| When block inputs... | The n-D Lookup Table block... |
|--|--|
| Match the values of indices in breakpoint data sets | Outputs the table value at the intersection of the row, column, and higher dimension breakpoints |
| Do not match the values of indices in breakpoint data sets, but are within range | Interpolates appropriate table values, using the Interpolation method you select |
| Do not match the values of indices in breakpoint data sets, and are out of range | Extrapolates the output value, using the Extrapolation method you select |

Data Types: half | single | double | int8 | int16 | int32 | int64 | uint8 | uint16 | uint32 | uint64 | fixed point

Parameters

Table and Breakpoints

Number of table dimensions — Number of lookup table dimensions

1 (default) | 2 | 3 | 4 | ... | 30

Enter the number of dimensions of the lookup table. This parameter determines:

- The number of independent variables for the table and the number of block inputs
- The number of breakpoint sets to specify

| To specify... | Do this... |
|-------------------------------------|---|
| 1, 2, 3, or 4 | Select the value from the drop-down list. |
| A higher number of table dimensions | Enter a positive integer directly in the field. The maximum number of table dimensions that this block supports is 30. |

For example, a table with a size of $M \times N \times \dots$ means that the size of dimension 1 is M , the size of dimension 2 is N , and so forth. M must match the first breakpoint length, N must match the second breakpoint length, and so forth.

Programmatic Use

Block Parameter: NumberOfTableDimensions

Type: character vector

Values: '1' | '2' | '3' | '4' | ... | 30

Default: '1'

Data specification — Method of table and breakpoint specification

Table and breakpoints (default) | Lookup table object

From the list, select:

- **Table and breakpoints** — Specify the table data and breakpoints. Selecting this option enables these parameters:
 - **Table data**
 - **Breakpoints specification**

- **Breakpoints 1**
- **Edit table and breakpoints**

To specify the table and breakpoints using input ports, see the **Source** parameter.

- **Lookup table object** — Use an existing lookup table (`Simulink.LookupTable`) object. Selecting this option enables the **Name** field and **Edit table and breakpoints** button.

Programmatic Use

Block Parameter: `DataSpecification`

Type: character vector

Values: 'Table and breakpoints' | 'Lookup table object'

Default: 'Table and breakpoints'

Name — Name of the lookup table object

`[]` (default) | `Simulink.LookupTable` object

Enter the name of the lookup table (`Simulink.LookupTable`) object. If a `Simulink.LookupTable`

object does not exist, click the action button  and select **Create**. The corresponding parameters of the new lookup table object are automatically populated with the block information.

Dependencies

To enable this parameter, set **Data specification** to `Lookup table object`.

Programmatic Use

Block Parameter: `LookupTableObject`

Type: character vector

Values: name of a `Simulink.LookupTable` object

Default: ''

Breakpoints specification — Method of breakpoint specification

`Explicit values` (default) | `Even spacing`

Specify whether to enter data as explicit breakpoints or as parameters that generate evenly spaced breakpoints.

- To explicitly specify breakpoint data, set this parameter to `Explicit values` and enter breakpoint data in the text box next to the **Breakpoints** parameters.
- To specify parameters that generate evenly spaced breakpoints, set this parameter to `Even spacing` and enter values for the **First point** and **Spacing** parameters for each dimension of breakpoint data. The block calculates the number of points to generate from the table data.

Dependencies

To enable this parameter, set **Data specification** to `Table and breakpoints`.

Programmatic Use

Block Parameter: `BreakpointsSpecification`

Type: character vector

Values: 'Explicit values' | 'Even spacing'

Default: 'Explicit values'

Source — Source of table and breakpoint data

`Dialog` (default) | `Input port`

Source of table and breakpoint data, specified as:

- **Dialog** — Specify the table or breakpoint data in **Value** parameter.
- **Input port** — Specify the table or breakpoint data through the associated input port.

You can create up to three breakpoint data input ports. For breakpoints 4 to 30, you can specify breakpoints data only through the corresponding **Breakpoints** parameter.

Note Using the input port to specify table or breakpoint data might negatively affect block performance for simulation due to runtime checks.

Dependencies

- To enable this parameter, set **Data specification** to **Table and breakpoints**.
- To enable the associated **Value**, set this parameter to **Dialog**.
- To enable the associated input port, set this parameter to **Input port**.
- Setting this parameter to **Input port** disables the **Value** field and hides the corresponding parameter on the **Data Types** tab.
- Setting this parameter to **Input port** for any one of the parameters disables the **Edit Table and Breakpoints** button.

Programmatic Use

Block Parameter: TableSource | BreakpointsForDimension1Source | BreakpointsForDimension2Source | BreakpointsForDimension3Source

Type: character vector

Values: Dialog | Input port

Default: 'Dialog'

Table data — Define the table of output values

`tanh([-5:5])` (default) | vector of values

Enter the table of output values in the associated **Value** field.

During simulation, the matrix size must match the dimensions defined by the **Number of table dimensions** parameter. However, during block diagram editing, you can enter an empty matrix (specified as `[]`) or an undefined workspace variable. This technique lets you postpone specifying a correctly dimensioned matrix for the table data and continue editing the block diagram.

Dependencies

To enable this parameter, set:

- **Data specification** to **Table and breakpoints**.
- **Table data: Source** to **Dialog**.

Programmatic Use

Block Parameter: Table

Type: character vector

Values: vector of table values

Default: 'tanh([-5:5])'

Breakpoints — Explicit breakpoint values, or first point and spacing of breakpoints

[-5:5] (default) | 1-by-n or n-by-1 vector of monotonically increasing values

Specify the breakpoint data explicitly or as evenly-spaced breakpoints, based on the value of the **Breakpoints specification** parameter.

- If you set **Breakpoints specification** to `Explicit` values, enter the breakpoint set that corresponds to each dimension of table data in each **Breakpoints** row. For each dimension, specify breakpoints as a 1-by-n or n-by-1 vector whose values are strictly monotonically increasing.
- If you set **Breakpoints specification** to `Even spacing`, enter the parameters **First point** and **Spacing** in each **Breakpoints** row to generate evenly spaced breakpoints in the respective dimension. Your table data determines the number of evenly spaced points.

Dependencies

- To enable this parameter, set:
 - **Data specification** to `Table` and breakpoints.
 - **Table data: Source** to `Dialog`.
- When the **Breakpoints specification** parameter is set to `Even spacing`, you can only specify breakpoints data through the dialog.

Programmatic Use**Block Parameter:** BreakpointsForDimension1**Type:** character vector**Values:** 1-by-n or n-by-1 vector of monotonically increasing values**Default:** '[10, 22, 31]'**First point — First point in evenly spaced breakpoint data**

1 (default) | scalar

Specify the first point in your evenly spaced breakpoint data as a real-valued, finite, scalar. This parameter is available when **Breakpoints specification** is set to `Even spacing`.

Dependencies

To enable this parameter, set **Data specification** to `Table` and breakpoints, and **Breakpoints specification** to `Even spacing`.

Programmatic Use**Block Parameter:** BreakpointsForDimension1FirstPoint**Type:** character vector**Values:** real-valued, finite, scalar**Default:** '1'**Spacing — Spacing between evenly spaced breakpoints**

1 (default) | scalar

Specify the spacing between points in your evenly spaced breakpoint data.

Dependencies

To enable this parameter, set **Data specification** to `Table` and breakpoints, and **Breakpoints specification** to `Even spacing`.

Programmatic Use**Block Parameter:** BreakpointsForDimension1Spacing**Type:** character vector**Values:** positive, real-valued, finite, scalar**Default:** '1'**Edit table and breakpoints — Launch Lookup Table Editor dialog box**

button

Click this button to open the Lookup Table Editor. For more information, see “Edit Lookup Tables” in the Simulink documentation.

Clicking this button for a lookup table object lets you edit the object and save the new values for the object.

Algorithm**Lookup method****Interpolation method — Method of interpolation between breakpoint values**

Linear point-slope (default) | Flat | Nearest | Linear Lagrange | Cubic spline | Akima spline

When an input falls between breakpoint values, the block interpolates the output value using neighboring breakpoints. For more information on interpolation methods, see “Interpolation Methods”.

Dependencies

- If you select Cubic spline, the block supports only scalar signals. The other interpolation methods support nonscalar signals.
- If you select Akima spline, the extrapolation method can only be Akima spline.

When set to the modified Akima interpolation method, this block does not support:

- Row-major array layout and algorithms optimized for row-major array layout
- Scaled double and fixed-point data types
- Simulink.LookupTable objects
- Code generation when the configuration parameter **Code Generation > Interface > Support non-finite numbers** check box is selected

When set to the modified Akima interpolation method, this block is known to run more slowly when these conditions are true:

- Code generation-based simulation targets, such as those for accelerator mode, rapid accelerator mode, protected models, and so forth.
- Code generated for large breakpoint and data table sizes. For example with a table size of 629x1601.

Programmatic Use**Block Parameter:** InterpMethod**Type:** character vector

Values: 'Linear point-slope' | 'Flat' | 'Nearest' | 'Linear Lagrange' | 'Cubic spline' | 'Akima spline'
Default: 'Linear point-slope'

Extrapolation method — Method of handling input values that fall outside the range of a breakpoint data set

Linear (default) | Clip | Cubic spline | Akima spline

Select Clip, Linear, or Cubic spline. See “Extrapolation Methods” for more information.

If the extrapolation method is Linear, the extrapolation value is calculated based on the selected linear interpolation method. For example, if the interpolation method is linear Lagrange, the extrapolation method inherits the linear Lagrange equation to compute the extrapolated value.

Dependencies

- To select Cubic spline for **Extrapolation method**, you must also select Cubic spline for **Interpolation method**.
- To select Akima spline for **Extrapolation method**, you must also select Akima spline for **Interpolation method**.

Programmatic Use

Block Parameter: ExtrapMethod

Type: character vector

Values: 'Linear' | 'Clip' | 'Cubic spline' | 'Akima spline'

Default: 'Linear'

Index search method — Method of calculating table indices

Evenly spaced points (default) | Linear search | Binary search

Select Evenly spaced points, Linear search, or Binary search. Each search method has speed advantages in different circumstances:

- For evenly spaced breakpoint sets (for example, 10, 20, 30, and so on), you achieve optimal speed by selecting Evenly spaced points to calculate table indices.

This algorithm uses only the first two breakpoints of a set to determine the offset and spacing of the remaining points.

Note Set **Index search method** to Evenly spaced points when using the Simulink.LookupTable object to specify table data and the **Breakpoints Specification** parameter of the referenced Simulink.LookupTable object is set to Even spacing.

- For unevenly spaced breakpoint sets, follow these guidelines:
 - If input signals do not vary much between time steps, selecting Linear search with **Begin index search using previous index result** produces the best performance.
 - If input signals jump more than one or two table intervals per time step, selecting Binary search produces the best performance.

A suboptimal choice of index search method can lead to slow performance of models that rely heavily on lookup tables.

Note The generated code stores only the first breakpoint, the spacing, and the number of breakpoints when:

- The breakpoint data is not tunable.
 - The index search method is Evenly spaced points.
-

Programmatic Use

Block Parameter: IndexSearchMethod

Type: character vector

Values: 'Binary search' | 'Evenly spaced points' | 'Linear search'

Default: 'Binary search'

Begin index search using previous index result — Start using the index from the previous time step

off (default) | on

Select this check box when you want the block to start its search using the index found at the previous time step. For inputs that change slowly with respect to the interval size, enabling this option can improve performance. Otherwise, the linear search and binary search methods can take longer, especially for large breakpoint sets.

Dependencies

To enable this parameter, set **Index search method** to Linear search or Binary search.

Programmatic Use

Block Parameter: BeginIndexSearchUsing PreviousIndexResult

Type: character vector

Values: 'off' | 'on'

Default: 'off'

Diagnostic for out-of-range input — Block action when input is out of range

None (default) | Warning | Error

Specify whether to produce a warning or error when the input is out of range. Options include:

- None — Produce no response.
- Warning — Display a warning and continue the simulation.
- Error — Terminate the simulation and display an error.

Programmatic Use

Block Parameter: DiagnosticForOutOfRangeInput

Type: character vector

Values: 'None' | 'Warning' | 'Error'

Default: 'None'

Apply full precision fixed-point algorithm when possible — More accurate fixed-point table lookup

off (default) | on

Use this check box to enable full-precision fixed-point algorithm lookup for linear interpolation lookup when possible. This algorithm generally achieves better precision for hardware-efficient fixed-point rounding modes.

Dependencies

To enable this parameter, set:

- **Number of table dimensions** to 1.
- **Interpolation method** to Linear point-slope.
- **Extrapolation method** to Clip.

Programmatic Use

Block Parameter: ApplyFullPrecisionForLinearInterpolation

Type: character vector

Values: 'off' | 'on'

Default: 'off'

Use last table value for inputs at or above last breakpoint – Method for computing output for inputs at or above last breakpoint

off (default) | on

Using this check box, specify the indexing convention that the block uses to address the last element of a breakpoint set and its corresponding table value. This check box is relevant if the input is equal to or larger than the last element of the breakpoint data. Due to rounding, selecting and clearing this check box may result in differing results for the last breakpoint between simulation and code generation.

| Check Box | Index Used by Block | Interval Fraction |
|-----------|---|-------------------|
| Selected | Last element of breakpoint data on the Table and Breakpoints tab | 0 |
| Cleared | Next-to-last element of breakpoint data on the Table and Breakpoints tab | 1 |

Given an input u within range of a breakpoint set bp , the interval fraction f , in the range $0 \leq f < 1$, is computed as shown below.

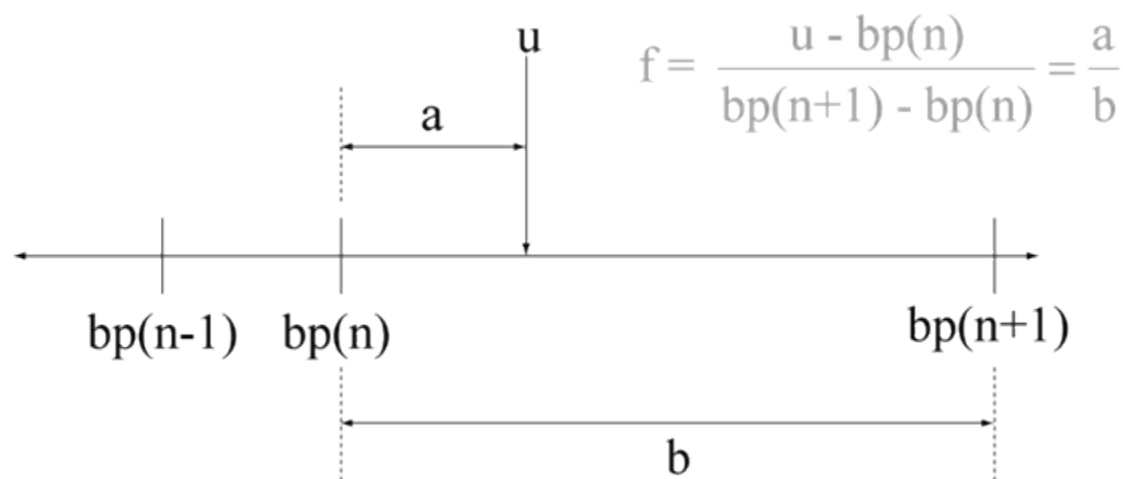

Suppose the breakpoint set is [1 4 5] and input u is 5.5. If you select this check box, the index is that of the last element (5) and the interval fraction is 0. If you clear this check box, the index is that of the next-to-last element (4) and the interval fraction is 1.

Dependencies

To enable this parameter, set:

- **Interpolation method** to Linear.
- **Extrapolation method** to Clip.

Programmatic Use

Block Parameter: UseLastTableValue

Type: character vector

Values: 'off' | 'on'

Default: 'off'

Input settings**Use one input port for all input data — Use only one input port**

off (default) | on

Select this check box to use only one input port that expects a signal that is n elements wide for an n -dimensional table. This option is useful for removing line clutter on a block diagram with many lookup tables.

Note When you select this check box, one input port with the label u appears on the block.

Programmatic Use

Block Parameter: UseOneInputPortForAllInputData

Type: character vector

Values: 'off' | 'on'

Default: 'off'

Code generation**Remove protection against out-of-range input in generated code — Remove code that checks for out-of-range input values**

off (default) | on

Specify whether or not to include code that checks for out-of-range input values.

| Check Box | Result | When to Use |
|-----------|--|----------------------------------|
| on | Generated code does not include conditional statements to check for out-of-range breakpoint inputs. When the input is out-of-range, it may cause undefined behavior for generated code. | For code efficiency |
| off | Generated code includes conditional statements to check for out-of-range inputs. | For safety-critical applications |

If your input is not out of range, you can select the **Remove protection against out-of-range index in generated code** check box for code efficiency. By default, this check box is cleared. For safety-

critical applications, do not select this check box. If you want to select the **Remove protection against out-of-range index in generated code** check box, first check that your model inputs are in range. For example:

- 1 Clear the **Remove protection against out-of-range index in generated code** check box.
- 2 Set the **Diagnostic for out-of-range input** parameter to Error.
- 3 Simulate the model in normal mode.
- 4 If there are out-of-range errors, fix them to be in range and run the simulation again.
- 5 When the simulation no longer generates out-of-range input errors, select the **Remove protection against out-of-range index in generated code** check box.

Note When you select the **Remove protection against out-of-range index in generated code** check box and the input is out of range, the behavior is undefined for generated code.

Depending on your application, you can run the following Model Advisor checks to verify the usage of this check box:

- **By Product > Embedded Coder > Identify lookup table blocks that generate expensive out-of-range checking code**
- **By Product > Simulink Check > Modeling Standards > DO-178C/DO-331 Checks > Check usage of lookup table blocks**

For more information about the Model Advisor, see “Run Model Advisor Checks”.

Additionally, to determine if it is safe to select this check box, if you have a Simulink Design Verifier license, consider using the “Detect Block Input Range Violations” (Simulink Design Verifier) check.

Programmatic Use

Block Parameter: RemoveProtectionInput

Type: character vector

Values: 'off' | 'on'

Default: 'off'

Support tunable table size in code generation – Enable tunable table size in the generated code

off (default) | on

Select this check box to enable tunable table size in the generated code. This option enables you to change the size and values of the lookup table and breakpoint data in the generated code without regenerating or recompiling the code. You can only decrease the size of the lookup table and breakpoint data.

Dependencies

If you set **Interpolation method** to Cubic spline, this check box is not available.

Programmatic Use

Block Parameter: SupportTunableTableSize

Type: character vector

Values: 'off' | 'on'

Default: 'off'

Sample time — Specify sample time as a value other than -1

-1 (default) | scalar | vector

Specify the sample time as a value other than -1. For more information, see “Specify Sample Time”.

Dependencies

This parameter is not visible unless it is explicitly set to a value other than -1. To learn more, see “Blocks for Which Sample Time Is Not Recommended”.

Programmatic Use**Block Parameter:** SampleTime**Type:** character vector**Values:** scalar or vector**Default:** '-1'**Maximum indices for each dimension — Maximum index value for each table dimension**

[] (default) | scalar or vector of positive integer values

Example: [4 6] for a 5-by-7 table

Specify the maximum index values for each table dimension using zero-based indexing. You can specify a scalar or vector of positive integer values using the following data types:

- Built-in floating-point types: `double` and `single`
- Built-in integer types: `int8`, `int16`, `int32`, `uint8`, `uint16`, and `uint32`

Examples of valid specifications include:

- [4 6] for a 5-by-7 table
- [`int8`(2) `int16`(5) `int32`(9)] for a 3-by-6-by-10 table
- A `Simulink.Parameter` whose value on generating code is one less than the dimensions of the table data. For more information, see “Tunable Table Size in the Generated Code” on page 1-969.

Dependencies

To enable this parameter, select **Support tunable table size in code generation**. On tuning this parameter in the generated code, provide the new table data and breakpoints along with the tuned parameter value.

Programmatic Use**Block Parameter:** MaximumIndicesForEachDimension**Type:** character vector**Values:** scalar or vector of positive integer values**Default:** '[]'**Data Types****Table data — Data type of table data**

Inherit: Same as output (default) | `double` | `single` | `half` | `int8` | `uint8` | `int16` | `uint16` | `int32` | `uint32` | `int64` | `uint64` | `fixdt`(1,16) | `fixdt`(1,16,0) | `fixdt`(1,16,2⁰,0) | <data type expression>

Specify the table data type. You can set it to:

- A rule that inherits a data type, for example, `Inherit: Same as output`
- The name of a built-in data type, for example, `single`
- The name of a data type object, for example, a `Simulink.NumericType` object
- An expression that evaluates to a data type, for example, `fixdt(1,16,0)`

Click the **Show data type assistant** button  to display the **Data Type Assistant**, which helps you set the data type attributes. For more information, see “Specify Data Types Using Data Type Assistant”.

Tip Specify a table data type different from the output data type for these cases:

- Lower memory requirement for storing table data that uses a smaller type than the output signal
 - Sharing of prescaled table data between two n-D Lookup Table blocks with different output data types
 - Sharing of custom storage table data in the generated code for blocks with different output data types
-

Dependencies

To enable this parameter, set **Table data** from the **Table and Breakpoints** tab to Dialog.

Programmatic Use

Block Parameter: `TableDataTypeStr`

Type: character vector

Values: `'Inherit: Inherit from 'Table data''` | `'Inherit: Same as output'` | `'double'` | `'single'` | `'half'` | `'int8'` | `'uint8'` | `'int16'` | `'uint16'` | `'int32'` | `'uint32'` | `'int64'` | `'uint64'` | `'fixdt(1,16)'` | `'fixdt(1,16,0)'` | `'fixdt(1,16,2^0,0)'` | `'<data type expression>'`

Default: `'Inherit: Same as output'`

Table data Minimum — Minimum value of the table data

`[]` | scalar

Specify the minimum value for table data. The default value is `[]` (unspecified).

Programmatic Use

Block Parameter: `TableMin`

Type: character vector

Values: scalar

Default: `'[]'`

Table data Maximum — Maximum value of the table data

`[]` | scalar

Specify the maximum value for table data. The default value is `[]` (unspecified).

Programmatic Use

Block Parameter: `TableMax`

Type: character vector

Values: scalar

Default: ' [] '

Breakpoints — Breakpoint data type

Inherit: Same as corresponding input (default) | double | single | half | int8 | uint8 | int16 | uint16 | int32 | uint32 | int64 | uint64 | fixdt(1,16) | fixdt(1,16,0) | fixdt(1,16,2^0,0) | Enum: <class name> | <data type expression>

Specify the data type for a set of breakpoint data. You can set it to:

- A rule that inherits a data type, for example, `Inherit: Same as corresponding input`
- The name of a built-in data type, for example, `single`
- The name of a data type class, for example, an enumerated data type class
- The name of a data type object, for example, a `Simulink.NumericType` object
- An expression that evaluates to a data type, for example, `fixdt(1,16,0)`

Tip

- Breakpoints support unordered enumerated data. As a result, linear searches are also unordered, which offers flexibility but can impact performance. The search begins from the first element in the breakpoint.
 - If the **Begin index search using previous index result** check box is selected, you must use ordered monotonically increasing data. This ordering improves performance.
 - For enumerated data, **Extrapolation method** must be `Clip`.
 - The block does not support out-of-range input for enumerated data. When specifying enumerated data, include the entire enumeration set in the breakpoint data set. For example, use the `enumeration` function.
-

This is a limitation for using enumerated data with this block:

- The block does not support out-of-range input for enumerated data. When specifying enumerated data, include the entire enumeration set in the breakpoint data set. For example, use the `enumeration` function.

Click the **Show data type assistant** button  to display the **Data Type Assistant**, which helps you set the data type attributes. For more information, see “Specify Data Types Using Data Type Assistant”.

Tip Specify a breakpoint data type different from the corresponding input data type for these cases:

- Lower memory requirement for storing breakpoint data that uses a smaller type than the input signal
- Sharing of prescaled breakpoint data between two n-D Lookup Table blocks with different input data types
- Sharing of custom storage breakpoint data in the generated code for blocks with different input data types

Specify the same slope and bias for a breakpoint data type and its corresponding input data type if either of them has a fixed-point data type.

Dependencies

To enable this parameter, set the corresponding **Breakpoints** parameter from the **Table and Breakpoints** tab to Dialog.

Programmatic Use

Block Parameter: BreakpointsForDimension1DataTypeStr | BreakpointsForDimension2DataTypeStr | ... | BreakpointsForDimension30DataTypeStr

Type: character vector

Values: 'Inherit: Same as corresponding input' | 'Inherit: Inherit from 'Breakpoint data'' | 'double' | 'single' | 'half' | 'int8' | 'uint8' | 'int16' | 'uint16' | 'int32' | 'uint32' | 'int64' | 'uint64' | 'fixdt(1,16)' | 'fixdt(1,16,0)' | 'fixdt(1,16,2^0,0)' | '<data type expression>'

Default: 'Inherit: Same as corresponding input'

Breakpoints Minimum — Minimum value breakpoint data can have

[] | scalar

Specify the minimum value that a set of breakpoint data can have. The default value is [] (unspecified).

Programmatic Use

Block Parameter: BreakpointsForDimension1Min | BreakpointsForDimension2Min | ... | BreakpointsForDimension30Min

Type: character vector

Values: scalar

Default: '[]'

Breakpoints Maximum — Maximum value breakpoint data can have

[] | scalar

Specify the maximum value that a set of breakpoint data can have. The default value is [] (unspecified).

Programmatic Use

Block Parameter: BreakpointsForDimension1Max | BreakpointsForDimension2Max | ... | BreakpointsForDimension30Max

Type: character vector

Values: scalar

Default: '[]'

Fraction — Fraction data type

Inherit: Inherit via internal rule (default) | double | single | fixdt(1,16,0) | <data type expression>

Specify the fraction data type. You can set it to:

- A rule that inherits a data type, for example, Inherit: Inherit via internal rule
- The name of a built-in data type, for example, single
- The name of a data type object, for example, a Simulink.NumericType object
- An expression that evaluates to a data type, for example, fixdt(1,16,0)

Click the **Show data type assistant** button  to display the **Data Type Assistant**, which helps you set the data type attributes. For more information, see “Specify Data Types Using Data Type Assistant”.

Programmatic Use

Block Parameter: FractionDataTypeStr

Type: character vector

Values: 'Inherit: Inherit via internal rule' | 'double' | 'single' | 'fixdt(1,16,0)' | '<data type expression>'

Default: 'Inherit: Inherit via internal rule'

Intermediate results – Intermediate results data type

Inherit: Same as output (default) | Inherit: Inherit via internal rule | double | single | int8 | uint8 | int16 | uint16 | int32 | uint32 | int64 | uint64 | fixdt(1,16,0) | fixdt(1,16,2^0,0) | <data type expression>

Specify the intermediate results data type. You can set it to:

- A rule that inherits a data type, for example, Inherit: Same as output
- The name of a built-in data type, for example, single
- The name of a data type object, for example, a Simulink.NumericType object
- An expression that evaluates to a data type, for example, fixdt(1,16,0)

Click the **Show data type assistant** button  to display the **Data Type Assistant**, which helps you set the data type attributes. For more information, see “Specify Data Types Using Data Type Assistant”.

Tip Use this parameter to specify higher (or lower) precision for internal computations than for table data or output data.

Programmatic Use

Block Parameter: IntermediateResultsDataTypeStr

Type: character vector

Values: 'Inherit: Inherit via internal rule' | 'Inherit: Same as output' | 'double' | 'single' | 'int8' | 'uint8' | 'int16' | 'uint16' | 'int32' | 'uint32' | 'int64' | 'uint64' | 'fixdt(1,16,0)' | 'fixdt(1,16,2^0,0)' | '<data type expression>'

Default: 'Inherit: Same as output'

Output – Output data type

Inherit: Same as input (default) | double | single | half | int8 | uint8 | int16 | uint16 | int32 | uint32 | int64 | uint64 | fixdt(1,16) | fixdt(1,16,0) | fixdt(1,16,2^0,0) | <data type expression>

Specify the output data type. You can set it to:

- A rule that inherits a data type, for example, Inherit: Inherit via back propagation
- The name of a built-in data type, for example, single
- The name of a data type object, for example, a Simulink.NumericType object

- An expression that evaluates to a data type, for example, `fixdt(1,16,0)`

Click the **Show data type assistant** button  to display the **Data Type Assistant**, which helps you set the data type attributes. For more information, see “Specify Data Types Using Data Type Assistant”.

Programmatic Use

Block Parameter: `OutDataTypeStr`

Type: character vector

Values: 'Inherit: Inherit via back propagation' | 'Inherit: Inherit from table data' | 'Inherit: Same as first input' | 'double' | 'single' | 'half' | 'int8' | 'uint8' | 'int16' | 'uint16' | 'int32' | 'uint32' | 'int64' | 'uint64' | 'fixdt(1,16,0)' | 'fixdt(1,16,2^0,0)' | '<data type expression'

Default: 'Inherit: Same as first input'

Output Minimum — Minimum value the block can output

`[]` | scalar

Specify the minimum value that the block outputs. The default value is `[]` (unspecified). Simulink software uses this value to perform:

- Parameter range checking (see “Specify Minimum and Maximum Values for Block Parameters”).
- Simulation range checking (see “Specify Signal Ranges”).
- Automatic scaling of fixed-point data types.
- Optimization of the code that you generate from the model. This optimization can remove algorithmic code and affect the results of some simulation modes such as SIL or external mode.

Programmatic Use

Block Parameter: `OutMin`

Type: character vector

Values: scalar

Default: '`[]`'

Output Maximum — Maximum value the block can output

`[]` | scalar

Specify the maximum value that the block can output. The default value is `[]` (unspecified). Simulink software uses this value to perform:

- Parameter range checking (see “Specify Minimum and Maximum Values for Block Parameters”).
- Simulation range checking (see “Specify Signal Ranges”).
- Automatic scaling of fixed-point data types.
- Optimization of the code that you generate from the model. This optimization can remove algorithmic code and affect the results of some simulation modes such as SIL or external mode.

Programmatic Use

Block Parameter: `OutMax`

Type: character vector

Values: scalar

Default: '`[]`'

Internal rule priority — Internal rule for intermediate calculations

Speed (default) | Precision

Specify the internal rule for intermediate calculations. Select Speed for faster calculations. If you do, a loss of accuracy might occur, usually up to 2 bits.

Programmatic Use**Block Parameter:** InternalRulePriority**Type:** character vector**Values:** 'Speed' | 'Precision'**Default:** 'Speed'**Require all inputs to have the same data type — Require all inputs to have the same data type**

on (default) | off

Select to require all inputs to have the same data type.

Programmatic Use**Block Parameter:** InputSameDT**Type:** character vector**Values:** 'off' | 'on'**Default:** 'on'**Lock data type settings against changes by the fixed-point tools — Prevent fixed-point tools from overriding data types**

off (default) | on

Select this parameter to prevent the fixed-point tools from overriding the data types you specify on this block. For more information, see “Lock the Output Data Type Setting” (Fixed-Point Designer).

Programmatic Use**Block Parameter:** LockScale**Type:** character vector**Values:** 'off' | 'on'**Default:** 'off'**Integer rounding mode — Rounding mode for fixed-point operations**

Simplest (default) | Ceiling | Convergent | Floor | Nearest | Round | Zero

Specify the rounding mode for fixed-point lookup table calculations that occur during simulation or execution of code generated from the model. For more information, see “Rounding” (Fixed-Point Designer).

This option does not affect rounding of values of block parameters. Simulink rounds such values to the nearest representable integer value. To control the rounding of a block parameter, enter an expression using a MATLAB rounding function into the edit field on the block dialog box.

Programmatic Use**Block Parameter:** RndMeth**Type:** character vector**Values:** 'Ceiling' | 'Convergent' | 'Floor' | 'Nearest' | 'Round' | 'Simplest' | 'Zero'**Default:** 'Simplest'

Saturate on integer overflow – Method of overflow action

off (default) | on

| Action | Reasons for Taking This Action | What Happens for Overflows | Example |
|-------------------------------------|---|---|---|
| Select this check box (on). | Your model has possible overflow and you want explicit saturation protection in the generated code. | Overflows saturate to either the minimum or maximum value that the data type can represent. | An overflow associated with a signed 8-bit integer can saturate to -128 or 127. |
| Do not select this check box (off). | You want to optimize efficiency of your generated code. You want to avoid overspecifying how a block handles out-of-range signals. For more information, see "Troubleshoot Signal Range Errors". | Overflows wrap to the appropriate value that is representable by the data type. | The number 130 does not fit in a signed 8-bit integer and wraps to -126. |

Tip If you save your model as version R2009a or earlier, this check box setting has no effect and no saturation code appears. This behavior preserves backward compatibility.

When you select this check box, saturation applies to every internal operation on the block, not just the output or result. In general, the code generation process can detect when overflow is not possible. In this case, the code generator does not produce saturation code.

Programmatic Use**Block Parameter:** SaturateOnIntegerOverflow**Type:** character vector**Values:** 'off' | 'on'**Default:** 'off'**Block Characteristics**

| | |
|---------------------------------|---|
| Data Types | double enumerated fixed point half integer single |
| Direct Feedthrough | yes |
| Multidimensional Signals | yes |
| Variable-Size Signals | no |
| Zero-Crossing Detection | no |

More About**Tunable Table Size in the Generated Code**

Suppose that you have a lookup table and want to make the size tunable in the generated code. When you use `Simulink.LookupTable` and `Simulink.Breakpoint` objects to configure lookup table

data for calibration in the generated code, use the `SupportTunableSize` property of the objects to enable a tunable table size. When you do not use these classes, use the **Support tunable table size in code generation** parameter in an n-D Lookup Table block to enable a tunable table size.

Assume that:

- You define a `Simulink.Parameter` structure in the preload function of your model:

```
p = Simulink.Parameter;
p.Value.MaxIdx = [2 2];
p.Value.BP1 = [1 2 3];
p.Value.BP2 = [1 4 16];
p.Value.Table = [4 5 6; 16 19 20; 10 18 23];
p.DataType = 'Bus: slLookupTable';
p.CoderInfo.StorageClass = 'ExportedGlobal';

% Create bus object slBus1 from MATLAB structure
Simulink.Bus.createObject(p.Value);
slLookupTable = slBus1;
slLookupTable.Elements(1).DataType = 'uint32';
```

- These block parameters apply in the n-D Lookup Table block.

| Parameter | Value |
|--|----------|
| Number of table dimensions | 2 |
| Table data | p.Table |
| Breakpoints 1 | p.BP1 |
| Breakpoints 2 | p.BP2 |
| Support tunable table size in code generation | on |
| Maximum indices for each dimension | p.MaxIdx |

The generated `model_types.h` header file contains a type definition that looks something like this.

```
typedef struct {
    uint32_T MaxIdx[2];
    real_T BP1[3];
    real_T BP2[3];
    real_T Table[9];
} slLookupTable;
```

The generated `model.c` file contains code that looks something like this.

```
/* Exported block parameters */
slLookupTable p = {
    { 2U, 2U },

    { 1.0, 2.0, 3.0 },

    { 1.0, 4.0, 16.0 },

    { 4.0, 16.0, 10.0, 5.0, 19.0, 18.0, 6.0, 20.0, 23.0 }
};

/* More code */
```

```

/* Model output function */
static void ex_lut_nd_tunable_table_output(int_T tid)
{
  /* Lookup_n-D: '<Root>/n-D Lookup Table' incorporates:
   * Inport: '<Root>/In1'
   * Inport: '<Root>/In2'
   */
  Y = look2_binlcpw(U1, U2, p.BP1, p.BP2, p.Table, ...
p.MaxIdx, p.MaxIdx[0] + 1U);

  /* Outport: '<Root>/Out1' */
  ex_lut_nd_tunable_table_Y.Out1 = Y;

  /* tid is required for a uniform function interface.
   * Argument tid is not used in the function. */
  UNUSED_PARAMETER(tid);
}

```

The highlighted line of code specifies a tunable table size for the lookup table. You can change the size and values of the lookup table and breakpoint data without regenerating or recompiling the code.

Enumerated Values in Lookup Tables

Suppose that you have a lookup table with an enumerated class like this defined:

```

classdef(Enumeration) Gears < Simulink.IntEnumType
  enumeration
    GEAR1(1),
    GEAR2(2),
    GEAR3(4),
    GEAR4(8),
    SPORTS(16),
    REVERSE(-1),
    NEUTRAL(0)
  end
end

```

n-D Lookup block has these settings:

- **Number of dimensions** to 1.
- **Table data** value is [5 10 20 40 80 -5 0].
- **Breakpoints 1** value is enumeration('Gears').
- Interpolation method is Flat.
- For an unordered search, set **Index search method** to Linear search and clear the **Begin index search using previous index result** check box.

Simulation produces a vector [10 -5 80], which correspond to GEAR2, REVERSE, and SPORTS.



Extended Capabilities

C/C++ Code Generation

Generate C and C++ code using Simulink® Coder™.

HDL Code Generation

Generate Verilog and VHDL code for FPGA and ASIC designs using HDL Coder™.

HDL Coder provides additional configuration options that affect HDL implementation and synthesized logic. For information about HDL code generation support for 1-D Lookup Table blocks, see “HDL Code Generation” on page 1-1022 .

Fixed-Point Conversion

Design and simulate fixed-point systems using Fixed-Point Designer™.

See Also

[Direct Lookup Table \(n-D\) | Prelookup | Interpolation Using Prelookup | Lookup Table Dynamic | Simulink.LookupTable | Simulink.Breakpoint](#)

Topics

[“Import Lookup Table Data from MATLAB”](#)

[“About Lookup Table Blocks”](#)

[“Anatomy of a Lookup Table”](#)

[“Enter Breakpoints and Table Data”](#)

[“Guidelines for Choosing a Lookup Table”](#)

Introduced in R2011a

2-D Lookup Table

Approximate two-dimensional function

Library: Simulink / Lookup Tables
HDL Coder / Lookup Tables

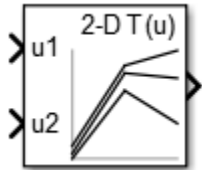

Description

Supported Block Operations

The 1-D, 2-D, and n-D Lookup Table blocks evaluate a sampled representation of a function in N variables

$$y = F(x_1, x_2, x_3, \dots, x_N)$$

where the function F can be empirical. The block maps inputs to an output value by looking up or interpolating a table of values you define with block parameters. The block supports flat (constant), linear (linear point-slope), Lagrange (linear Lagrange), nearest, cubic-spline, and Akima spline interpolation methods. You can apply these methods to a table of any dimension from 1 through 30.

In the following block, the first input identifies the first dimension (row) breakpoints, the second input identifies the second dimension (column) breakpoints, and so on.

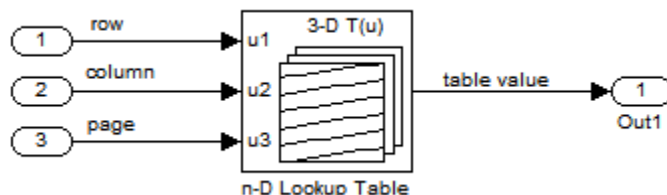

See “Port Location After Rotating or Flipping” for a description of the port order for various block orientations.

When the **Math and Data Types > Use algorithms optimized for row-major array layout** configuration parameter is set, the 2-D and n-D Lookup Table block behavior changes from column-major to row-major. For these blocks, the column-major and row-major algorithms may differ in the order of the output calculations, possibly resulting in slightly different numerical values. This capability requires a Simulink Coder or Embedded Coder license. For more information on row-major support, see “Code Generation of Matrices and Arrays” (Simulink Coder).

Specification of Breakpoint and Table Data

These block parameters define the breakpoint and table data.

| Block Parameter | Purpose |
|-----------------------------------|--|
| Number of table dimensions | Specifies the number of dimensions of your lookup table. |
| Breakpoints | Specifies a breakpoint vector that corresponds to each dimension of your lookup table. |
| Table data | Defines the associated set of output values. |

Tip Evenly spaced breakpoints can make the generated code division-free. For more information, see `fixpt_evenspace_cleanup` and “Identify questionable fixed-point operations” (Embedded Coder).

How the Block Generates Output

The n-D, 1-D and 2-D Lookup Table blocks generate output by looking up or estimating table values based on the input values.

| Block Inputs | n-D Lookup Table Block Behavior |
|--|--|
| Match the values of indices in breakpoint data sets | Outputs the table value at the intersection of the row, column, and higher dimension breakpoints |
| Do not match the values of indices in breakpoint data sets, but are within range | Interpolates appropriate table values, using the Interpolation method you select |
| Do not match the values of indices in breakpoint data sets, and are out of range | Extrapolates the output value, using the Extrapolation method you select |

Other Blocks that Perform Equivalent Operations

You can use the Interpolation Using Prelookup block with the Prelookup block to perform the equivalent operation of one n-D Lookup Table block. This combination of blocks offers greater flexibility that can result in more efficient simulation performance for linear interpolations.

When the lookup operation is an array access that does not require interpolation, use the Direct Lookup Table (n-D) block. For example, if you have an integer value k and you want the k th element of a table, $y = \text{table}(k)$, interpolation is unnecessary.

Ports

Input

u1 — First-dimension (row) inputs

scalar | vector | matrix

Real-valued inputs to the **u1** port, mapped to an output value by looking up or interpolating the table of values that you define.

Example: `0:10`

Data Types: `half` | `single` | `double` | `int8` | `int16` | `int32` | `int64` | `uint8` | `uint16` | `uint32` | `uint64` | `enumerated` | `fixed point`

u2 — Second-dimension (column) inputs

scalar | vector | matrix

Real-valued inputs to the **u2** port, mapped to an output value by looking up or interpolating the table of values that you define.

Example: 0:10

Data Types: half | single | double | int8 | int16 | int32 | int64 | uint8 | uint16 | uint32 | uint64 | enumerated | fixed point

T — Define the table of output values

matrix of values with dimensions that match the **Number of table dimensions** and the breakpoint lengths for each dimension of the table

Specify the table of output values with a signal that is tunable at runtime.

During simulation, the matrix size must match the dimensions defined by the **Number of table dimensions** parameter and the breakpoint lengths for each dimension of the table. However, during block diagram editing, you can enter an empty matrix (specified as []) or an undefined workspace variable. This technique lets you postpone specifying a correctly dimensioned matrix for the table data and continue editing the block diagram.

Dependencies

To enable this port, set:

- **Data specification** to Table and breakpoints.
- **Table data** to Input port.

Data Types: half | single | double | int8 | int16 | int32 | int64 | uint8 | uint16 | uint32 | uint64 | fixed point

bp1 — Explicit breakpoint values

1-by-n or n-by-1 vector of monotonically increasing values

Specify the breakpoint data explicitly, based on the value of the **Breakpoints specification** parameter, with a signal that is tunable at runtime.

- If you set **Breakpoints specification** to Explicit values, enter the breakpoint set that corresponds to each dimension of table data in each **Breakpoints** row. For each dimension, specify breakpoints as a 1-by-n or n-by-1 vector whose values are strictly monotonically increasing.

Note To specify breakpoints in the even spacing specification format, set **Breakpoints specification** to Even spacing and use the **Breakpoints First** point and **Spacing** parameters.

Dependencies

To enable this port, set:

- **Data specification** to Table and breakpoints.
- **Breakpoints specification** to Explicit values.
- **Breakpoints 1** to Input port.

Data Types: half | single | double | int8 | int16 | int32 | int64 | uint8 | uint16 | uint32 | uint64 | enumerated | fixed point

bp2 — Explicit breakpoint values

1-by-n or n-by-1 vector of monotonically increasing values

Specify the breakpoint data explicitly, based on the value of the **Breakpoints specification** parameter, with a signal that is tunable at runtime.

- If you set **Breakpoints specification** to `Explicit` values, enter the breakpoint set that corresponds to each dimension of table data in each **Breakpoints** row. For each dimension, specify breakpoints as a 1-by-n or n-by-1 vector whose values are strictly monotonically increasing.

Note To specify evenly spaced breakpoint data, use the **Breakpoints** parameter. You cannot specify evenly spaced breakpoint data through the input port.

Dependencies

To enable this port, set:

- **Data specification** to `Table` and breakpoints.
- **Breakpoints specification** to `Explicit` values.
- **Breakpoints 2** to `Input` port.

Data Types: `half` | `single` | `double` | `int8` | `int16` | `int32` | `int64` | `uint8` | `uint16` | `uint32` | `uint64` | `enumerated` | `fixed point`

Output**Port_1 — Output computed by looking up or estimating table values**

`scalar` | `vector` | `matrix`

Output generated by looking up or estimating table values based on the input values.

| When block inputs... | The n-D Lookup Table block... |
|--|--|
| Match the values of indices in breakpoint data sets | Outputs the table value at the intersection of the row, column, and higher dimension breakpoints |
| Do not match the values of indices in breakpoint data sets, but are within range | Interpolates appropriate table values, using the Interpolation method you select |
| Do not match the values of indices in breakpoint data sets, and are out of range | Extrapolates the output value, using the Extrapolation method you select |

Data Types: `half` | `single` | `double` | `int8` | `int16` | `int32` | `int64` | `uint8` | `uint16` | `uint32` | `uint64` | `fixed point`

Parameters**Table and Breakpoints****Number of table dimensions — Number of lookup table dimensions**

2 (default) | 1 | 3 | 4 | ... | 30

Enter the number of dimensions of the lookup table. This parameter determines:

- The number of independent variables for the table and the number of block inputs
- The number of breakpoint sets to specify

| To specify... | Do this... |
|-------------------------------------|---|
| 1, 2, 3, or 4 | Select the value from the drop-down list. |
| A higher number of table dimensions | Enter a positive integer directly in the field. The maximum number of table dimensions that this block supports is 30. |

For example, a table with a size of $M \times N \times \dots$ means that the size of dimension 1 is M , the size of dimension 2 is N , and so forth. M must match the first breakpoint length, N must match the second breakpoint length, and so forth.

Programmatic Use

Block Parameter: NumberOfTableDimensions

Type: character vector

Values: '1' | '2' | '3' | '4' | ... | 30

Default: '2'

Data specification — Method of table and breakpoint specification

Table and breakpoints (default) | Lookup table object

From the list, select:

- Table and breakpoints — Specify the table data and breakpoints. Selecting this option enables these parameters:
 - Table data
 - Breakpoints specification
 - Breakpoints 1
 - Breakpoints 2
 - Edit table and breakpoints

To specify the table and breakpoints using input ports, see the **Source** parameter.

- Lookup table object — Use an existing lookup table (`Simulink.LookupTable`) object. Selecting this option enables the **Name** field and **Edit table and breakpoints** button.

Programmatic Use

Block Parameter: DataSpecification

Type: character vector

Values: 'Table and breakpoints' | 'Lookup table object'

Default: 'Table and breakpoints'

Name — Name of the lookup table object

[] (default) | `Simulink.LookupTable` object

Enter the name of the lookup table (`Simulink.LookupTable`) object. If a `Simulink.LookupTable`

object does not exist, click the action button  and select **Create**. The corresponding parameters of the new lookup table object are automatically populated with the block information.

Dependencies

To enable this parameter, set **Data specification** to `Lookup table object`.

Programmatic Use

Block Parameter: `LookupTableObject`

Type: character vector

Values: name of a `Simulink.LookupTable` object

Default: `''`

Breakpoints specification — Method of breakpoint specification

`Explicit values (default)` | `Even spacing`

Specify whether to enter data as explicit breakpoints or as parameters that generate evenly spaced breakpoints.

- To explicitly specify breakpoint data, set this parameter to `Explicit values` and enter breakpoint data in the text box next to the **Breakpoints** parameters.
- To specify parameters that generate evenly spaced breakpoints, set this parameter to `Even spacing` and enter values for the **First point** and **Spacing** parameters for each dimension of breakpoint data. The block calculates the number of points to generate from the table data.

Dependencies

To enable this parameter, set **Data specification** to `Table` and `breakpoints`.

Programmatic Use

Block Parameter: `BreakpointsSpecification`

Type: character vector

Values: `'Explicit values'` | `'Even spacing'`

Default: `'Explicit values'`

Source — Source of table and breakpoint data

`Dialog (default)` | `Input port`

Source of table and breakpoint data, specified as:

- `Dialog` — Specify the table or breakpoint data in **Value** parameter.
- `Input port` — Specify the table or breakpoint data through the associated input port. Through the input port, you can specify only up to three sets of breakpoint data. To specify breakpoint data above three, use the **Value** parameter.

Note Using the input port to specify table or breakpoint data might negatively affect block performance for simulation due to runtime checks.

Dependencies

- To enable this parameter, set **Data specification** to `Table` and `breakpoints`.
- To enable the associated **Value**, set this parameter to `Dialog`.
- To enable the associated input port, set this parameter to `Input port`.
- Setting this parameter to `Input port` disables the **Value** field and hides the corresponding parameter on the **Data Types** tab.

- Setting this parameter to `Input port` for any one of the parameters disables the **Edit Table and Breakpoints** button.

Programmatic Use

Block Parameter: `TableSource` | `BreakpointsForDimension1Source` | `BreakpointsForDimension2Source` | `BreakpointsForDimension3Source`

Type: character vector

Values: `Dialog` | `Input port`

Default: `'Dialog'`

Table data — Define the table of output values

`[4 5 6; 16 19 20; 10 18 23]` (default) | matrix of values

Enter the table of output values in the associated **Value** field.

During simulation, the matrix size must match the dimensions defined by the **Number of table dimensions** parameter. However, during block diagram editing, you can enter an empty matrix (specified as `[]`) or an undefined workspace variable. This technique lets you postpone specifying a correctly dimensioned matrix for the table data and continue editing the block diagram.

Dependencies

To enable this parameter, set:

- **Data specification** to `Table` and `breakpoints`.
- **Table data: Source** to `Dialog`.

Programmatic Use

Block Parameter: `Table`

Type: character vector

Values: matrix of table values

Default: `'[4 5 6; 16 19 20; 10 18 23]'`

Breakpoints — Explicit breakpoint values, or first point and spacing of breakpoints

`[1:3]` (default) | 1-by-n or n-by-1 vector of monotonically increasing values

Specify the breakpoint data explicitly or as evenly-spaced breakpoints, based on the value of the **Breakpoints specification** parameter.

- If you set **Breakpoints specification** to `Explicit values`, enter the breakpoint set that corresponds to each dimension of table data in each **Breakpoints** row in the associated **Value** field. For each dimension, specify breakpoints as a 1-by-n or n-by-1 vector whose values are strictly monotonically increasing.
- If you set **Breakpoints specification** to `Even spacing`, enter the parameters **First point** and **Spacing** in each **Breakpoints** row to generate evenly-spaced breakpoints in the respective dimension. Your table data determines the number of evenly spaced points.

Dependencies

- To enable this parameter, set
 - **Data specification** to `Table` and `breakpoints`.
 - **Breakpoints: Source** to `Dialog`.
- When the **Breakpoints specification** parameter is set to `Even spacing`, you can only specify breakpoints data through the dialog.

Programmatic Use**Block Parameter:** BreakpointsForDimension1**Type:** character vector**Values:** 1-by-n or n-by-1 vector of monotonically increasing values**Default:** '[1:3]'**First point — First point in evenly spaced breakpoint data**

1 (default) | scalar

Specify the first point in your evenly spaced breakpoint data as a real-valued, finite, scalar. This parameter is available when **Breakpoints specification** is set to Even spacing.

Dependencies

To enable this parameter, set **Data specification** to Table and breakpoints, and **Breakpoints specification** to Even spacing.

Programmatic Use**Block Parameter:** BreakpointsForDimension1FirstPoint | BreakpointsForDimension2FirstPoint**Type:** character vector**Values:** real-valued, finite, scalar**Default:** '1'**Spacing — Spacing between evenly spaced breakpoints**

1 (default) | scalar

Specify the spacing between points in your evenly-spaced breakpoint data.

Dependencies

To enable this parameter, set **Data specification** to Table and breakpoints, and **Breakpoints specification** to Even spacing.

Programmatic Use**Block Parameter:** BreakpointsForDimension1Spacing | BreakpointsForDimension2Spacing**Type:** character vector**Values:** positive, real-valued, finite, scalar**Default:** '1'**Edit table and breakpoints — Launch Lookup Table Editor dialog box**

button

Click this button to open the Lookup Table Editor. For more information, see “Edit Lookup Tables” in the Simulink documentation.

Clicking this button for a lookup table object lets you edit the object and save the new values for the object.

Algorithm**Lookup method****Interpolation method — Method of interpolation between breakpoint values**

Linear point-slope (default) | Flat | Nearest | Linear Lagrange | Cubic spline | Akima spline

When an input falls between breakpoint values, the block interpolates the output value using neighboring breakpoints. For more information on interpolation methods, see “Interpolation Methods”.

Dependencies

- If you select `Cubic spline`, the block supports only scalar signals. The other interpolation methods support nonscalar signals.
- If you select `Akima spline`, the extrapolation method can only be `Akima spline`.

When set to the modified Akima interpolation method, this block does not support:

- Row-major array layout and algorithms optimized for row-major array layout
- Scaled double and fixed-point data types
- `Simulink.LookupTable` objects
- Code generation when the configuration parameter **Code Generation > Interface > Support non-finite numbers** check box is selected

When set to the modified Akima interpolation method, this block is known to run more slowly when these conditions are true:

- Code generation-based simulation targets, such as those for accelerator mode, rapid accelerator mode, protected models, and so forth.
- Code generated for large breakpoint and data table sizes. For example with a table size of 629x1601.

Programmatic Use

Block Parameter: `InterpMethod`

Type: character vector

Values: `'Linear point-slope'` | `'Flat'` | `'Nearest'` | `'Linear Lagrange'` | `'Cubic spline'` | `'Akima spline'`

Default: `'Linear point-slope'`

Extrapolation method — Method of handling input values that fall outside the range of a breakpoint data set

`Linear (default)` | `Clip` | `Cubic spline` | `Akima spline`

Select `Clip`, `Linear`, or `Cubic spline`. See “Extrapolation Methods” for more information.

If the extrapolation method is `Linear`, the extrapolation value is calculated based on the selected linear interpolation method. For example, if the interpolation method is linear Lagrange, the extrapolation method inherits the linear Lagrange equation to compute the extrapolated value.

Dependencies

- To select `Cubic spline` for **Extrapolation method**, you must also select `Cubic spline` for **Interpolation method**.
- To select `Akima spline` for **Extrapolation method**, you must also select `Akima spline` for **Interpolation method**.

Programmatic Use

Block Parameter: `ExtrapMethod`

Type: character vector

Values: 'Linear' | 'Clip' | 'Cubic spline' | 'Akima spline'
Default: 'Linear'

Index search method — Method of calculating table indices

Evenly spaced points (default) | Linear search | Binary search

Select Evenly spaced points, Linear search, or Binary search. Each search method has speed advantages in different circumstances:

- For evenly spaced breakpoint sets (for example, 10, 20, 30, and so on), you achieve optimal speed by selecting Evenly spaced points to calculate table indices.

This algorithm uses only the first two breakpoints of a set to determine the offset and spacing of the remaining points.

Note Set **Index search method** to Evenly spaced points when using the Simulink.LookupTable object to specify table data and the **Breakpoints Specification** parameter of the referenced Simulink.LookupTable object is set to Even spacing.

- For unevenly spaced breakpoint sets, follow these guidelines:
 - If input signals do not vary much between time steps, selecting Linear search with **Begin index search using previous index result** produces the best performance.
 - If input signals jump more than one or two table intervals per time step, selecting Binary search produces the best performance.

A suboptimal choice of index search method can lead to slow performance of models that rely heavily on lookup tables.

Note The generated code stores only the first breakpoint, the spacing, and the number of breakpoints when:

- The breakpoint data is not tunable.
 - The index search method is Evenly spaced points.
-

Programmatic Use

Block Parameter: IndexSearchMethod

Type: character vector

Values: 'Binary search' | 'Evenly spaced points' | 'Linear search'

Default: 'Binary search'

Begin index search using previous index result — Start using the index from the previous time step

off (default) | on

Select this check box when you want the block to start its search using the index found at the previous time step. For inputs that change slowly with respect to the interval size, enabling this option can improve performance. Otherwise, the linear search and binary search methods can take longer, especially for large breakpoint sets.

Dependencies

To enable this parameter, set **Index search method** to Linear search or Binary search.

Programmatic Use

Block Parameter: BeginIndexSearchUsing PreviousIndexResult

Type: character vector

Values: 'off' | 'on'

Default: 'off'

Diagnostic for out-of-range input — Block action when input is out of range

None (default) | Warning | Error

Specify whether to produce a warning or error when the input is out of range. Options include:

- None — Produce no response.
- Warning — Display a warning and continue the simulation.
- Error — Terminate the simulation and display an error.

Programmatic Use

Block Parameter: DiagnosticForOutOfRangeInput

Type: character vector

Values: 'None' | 'Warning' | 'Error'

Default: 'None'

Apply full precision fixed-point algorithm when possible — More accurate fixed-point table lookup

off (default) | on

Use this check box to enable full-precision fixed-point algorithm lookup for linear interpolation lookup when possible. This algorithm generally achieves better precision for hardware-efficient fixed-point rounding modes.

Dependencies

To enable this parameter, set:

- **Number of table dimensions** to 1.
- **Interpolation method** to Linear point-slope.
- **Extrapolation method** to Clip.

Programmatic Use

Block Parameter: ApplyFullPrecisionForLinearInterpolation

Type: character vector

Values: 'off' | 'on'

Default: 'off'

Use last table value for inputs at or above last breakpoint — Method for computing output for inputs at or above last breakpoint

off (default) | on

Using this check box, specify the indexing convention that the block uses to address the last element of a breakpoint set and its corresponding table value. This check box is relevant if the input is equal to or larger than the last element of the breakpoint data. Due to rounding, selecting and clearing this

check box may result in differing results for the last breakpoint between simulation and code generation.

| Check Box | Index Used by Block | Interval Fraction |
|-----------|---|-------------------|
| Selected | Last element of breakpoint data on the Table and Breakpoints tab | 0 |
| Cleared | Next-to-last element of breakpoint data on the Table and Breakpoints tab | 1 |

Given an input u within range of a breakpoint set bp , the interval fraction f , in the range $0 \leq f < 1$, is computed as shown below.

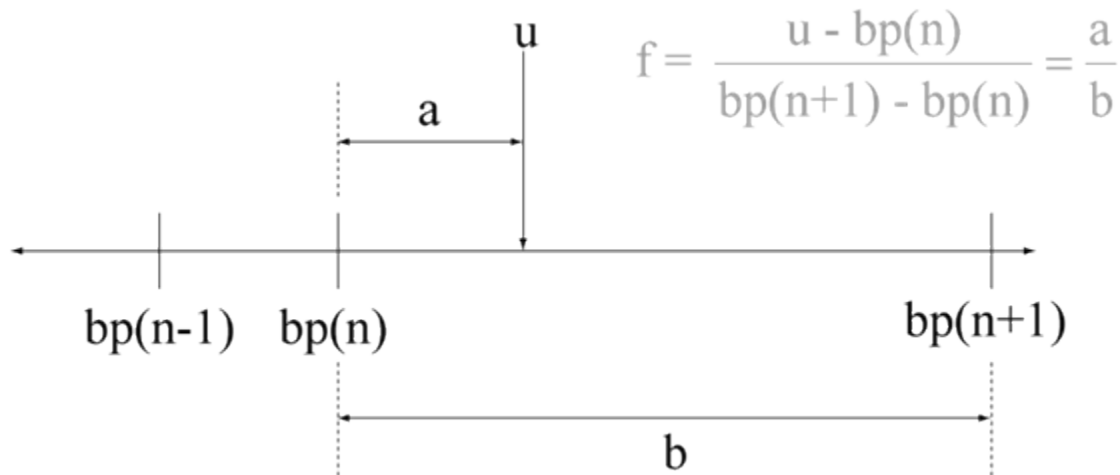

Suppose the breakpoint set is [1 4 5] and input u is 5.5. If you select this check box, the index is that of the last element (5) and the interval fraction is 0. If you clear this check box, the index is that of the next-to-last element (4) and the interval fraction is 1.

Dependencies

To enable this parameter, set:

- **Interpolation method** to Linear.
- **Extrapolation method** to Clip.

Programmatic Use

Block Parameter: UseLastTableValue

Type: character vector

Values: 'off' | 'on'

Default: 'off'

Input settings

Use one input port for all input data — Use only one input port

off (default) | on

Select this check box to use only one input port that expects a signal that is n elements wide for an n -dimensional table. This option is useful for removing line clutter on a block diagram with many lookup tables.

Note When you select this check box, one input port with the label *u* appears on the block.

Programmatic Use

Block Parameter: UseOneInputPortForAllInputData

Type: character vector

Values: 'off' | 'on'

Default: 'off'

Code generation

Remove protection against out-of-range input in generated code — Remove code that checks for out-of-range input values

off (default) | on

Specify whether or not to include code that checks for out-of-range input values.

| Check Box | Result | When to Use |
|-----------|--|----------------------------------|
| on | Generated code does not include conditional statements to check for out-of-range breakpoint inputs. When the input is out-of-range, it may cause undefined behavior for generated code. | For code efficiency |
| off | Generated code includes conditional statements to check for out-of-range inputs. | For safety-critical applications |

If your input is not out of range, you can select the **Remove protection against out-of-range index in generated code** check box for code efficiency. By default, this check box is cleared. For safety-critical applications, do not select this check box. If you want to select the **Remove protection against out-of-range index in generated code** check box, first check that your model inputs are in range. For example:

- 1 Clear the **Remove protection against out-of-range index in generated code** check box.
- 2 Set the **Diagnostic for out-of-range input** parameter to Error.
- 3 Simulate the model in normal mode.
- 4 If there are out-of-range errors, fix them to be in range and run the simulation again.
- 5 When the simulation no longer generates out-of-range input errors, select the **Remove protection against out-of-range index in generated code** check box.

Note When you select the **Remove protection against out-of-range index in generated code** check box and the input is out of range, the behavior is undefined for generated code.

Depending on your application, you can run the following Model Advisor checks to verify the usage of this check box:

- **By Product > Embedded Coder > Identify lookup table blocks that generate expensive out-of-range checking code**

- **By Product > Simulink Check > Modeling Standards > DO-178C/DO-331 Checks > Check usage of lookup table blocks**

For more information about the Model Advisor, see “Run Model Advisor Checks”.

Additionally, to determine if it is safe to select this check box, if you have a Simulink Design Verifier license, consider using the “Detect Block Input Range Violations” (Simulink Design Verifier) check.

Programmatic Use

Block Parameter: RemoveProtectionInput

Type: character vector

Values: 'off' | 'on'

Default: 'off'

Support tunable table size in code generation — Enable tunable table size in the generated code

off (default) | on

Select this check box to enable tunable table size in the generated code. This option enables you to change the size and values of the lookup table and breakpoint data in the generated code without regenerating or recompiling the code. You can only decrease the size of the lookup table and breakpoint data.

Dependencies

If you set **Interpolation method** to Cubic spline, this check box is not available.

Programmatic Use

Block Parameter: SupportTunableTableSize

Type: character vector

Values: 'off' | 'on'

Default: 'off'

Sample time — Specify sample time as a value other than -1

-1 (default) | scalar | vector

Specify the sample time as a value other than -1. For more information, see “Specify Sample Time”.

Dependencies

This parameter is not visible unless it is explicitly set to a value other than -1. To learn more, see “Blocks for Which Sample Time Is Not Recommended”.

Programmatic Use

Block Parameter: SampleTime

Type: character vector

Values: scalar or vector

Default: '-1'

Maximum indices for each dimension — Maximum index value for each table dimension

[] (default) | scalar or vector of positive integer values

Example: [4 6] for a 5-by-7 table

Specify the maximum index values for each table dimension using zero-based indexing. You can specify a scalar or vector of positive integer values using the following data types:

- Built-in floating-point types: `double` and `single`
- Built-in integer types: `int8`, `int16`, `int32`, `uint8`, `uint16`, and `uint32`

Examples of valid specifications include:

- `[4 6]` for a 5-by-7 table
- `[int8(2) int16(5) int32(9)]` for a 3-by-6-by-10 table
- A `Simulink.Parameter` whose value on generating code is one less than the dimensions of the table data. For more information, see “Tunable Table Size in the Generated Code” on page 1-994.

Dependencies

To enable this parameter, select **Support tunable table size in code generation**. On tuning this parameter in the generated code, provide the new table data and breakpoints along with the tuned parameter value.

Programmatic Use

Block Parameter: `MaximumIndicesForEachDimension`

Type: character vector

Values: scalar or vector of positive integer values

Default: `'[]'`

Data Types

Table data — Data type of table data

Inherit: `Same as output (default) | double | single | half | int8 | uint8 | int16 | uint16 | int32 | uint32 | int64 | uint64 | fixdt(1,16) | fixdt(1,16,0) | fixdt(1,16,2^0,0) | <data type expression>`

Specify the table data type. You can set it to:

- A rule that inherits a data type, for example, `Inherit: Same as output`
- The name of a built-in data type, for example, `single`
- The name of a data type object, for example, a `Simulink.NumericType` object
- An expression that evaluates to a data type, for example, `fixdt(1,16,0)`

Click the **Show data type assistant** button  to display the **Data Type Assistant**, which helps you set the data type attributes. For more information, see “Specify Data Types Using Data Type Assistant”.

Tip Specify a table data type different from the output data type for these cases:

- Lower memory requirement for storing table data that uses a smaller type than the output signal
 - Sharing of prescaled table data between two n-D Lookup Table blocks with different output data types
 - Sharing of custom storage table data in the generated code for blocks with different output data types
-

Dependencies

To enable this parameter, set **Table data** from the **Table and Breakpoints** tab to Dialog.

Programmatic Use

Block Parameter: TableDataTypeStr

Type: character vector

Values: 'Inherit: Inherit from 'Table data'' | 'Inherit: Same as output' | 'double' | 'single' | 'half' | 'int8' | 'uint8' | 'int16' | 'uint16' | 'int32' | 'uint32' | 'int64' | 'uint64' | 'fixdt(1,16)' | 'fixdt(1,16,0)' | 'fixdt(1,16,2^0,0)' | '<data type expression>'

Default: 'Inherit: Same as output'

Table data Minimum — Minimum value of the table data

[] | scalar

Specify the minimum value for table data. The default value is [] (unspecified).

Programmatic Use

Block Parameter: TableMin

Type: character vector

Values: scalar

Default: '[]'

Table data Maximum — Maximum value of the table data

[] | scalar

Specify the maximum value for table data. The default value is [] (unspecified).

Programmatic Use

Block Parameter: TableMax

Type: character vector

Values: scalar

Default: '[]'

Breakpoints — Breakpoint data type

Inherit: Same as corresponding input (default) | double | single | half | int8 | uint8 | int16 | uint16 | int32 | uint32 | int64 | uint64 | fixdt(1,16) | fixdt(1,16,0) | fixdt(1,16,2^0,0) | Enum: <class name> | <data type expression>

Specify the data type for a set of breakpoint data. You can set it to:

- A rule that inherits a data type, for example, `Inherit: Same as corresponding input`
- The name of a built-in data type, for example, `single`
- The name of a data type class, for example, an enumerated data type class
- The name of a data type object, for example, a `Simulink.NumericType` object
- An expression that evaluates to a data type, for example, `fixdt(1,16,0)`

Tip

- Breakpoints support unordered enumerated data. As a result, linear searches are also unordered, which offers flexibility but can impact performance. The search begins from the first element in the breakpoint.

- If the **Begin index search using previous index result** check box is selected, you must use ordered monotonically increasing data. This ordering improves performance.
- For enumerated data, **Extrapolation method** must be Clip.
- The block does not support out-of-range input for enumerated data. When specifying enumerated data, include the entire enumeration set in the breakpoint data set. For example, use the enumeration function.

This is a limitation for using enumerated data with this block:

- The block does not support out-of-range input for enumerated data. When specifying enumerated data, include the entire enumeration set in the breakpoint data set. For example, use the enumeration function.

Click the **Show data type assistant** button  to display the **Data Type Assistant**, which helps you set the data type attributes. For more information, see “Specify Data Types Using Data Type Assistant”.

Tip Specify a breakpoint data type different from the corresponding input data type for these cases:

- Lower memory requirement for storing breakpoint data that uses a smaller type than the input signal
- Sharing of prescaled breakpoint data between two n-D Lookup Table blocks with different input data types
- Sharing of custom storage breakpoint data in the generated code for blocks with different input data types

Specify the same slope and bias for a breakpoint data type and its corresponding input data type if either of them has a fixed-point data type.

Dependencies

To enable this parameter, set the corresponding **Breakpoints** parameter from the **Table and Breakpoints** tab to Dialog.

Programmatic Use

Block Parameter: BreakpointsForDimension1DataTypeStr | BreakpointsForDimension2DataTypeStr | ... | BreakpointsForDimension30DataTypeStr

Type: character vector

Values: 'Inherit: Same as corresponding input' | 'Inherit: Inherit from 'Breakpoint data'' | 'double' | 'single' | 'half' | 'int8' | 'uint8' | 'int16' | 'uint16' | 'int32' | 'uint32' | 'int64' | 'uint64' | 'fixdt(1,16)' | 'fixdt(1,16,0)' | 'fixdt(1,16,2^0,0)' | '<data type expression>'

Default: 'Inherit: Same as corresponding input'

Breakpoints Minimum — Minimum value breakpoint data can have

[] | scalar

Specify the minimum value that a set of breakpoint data can have. The default value is [] (unspecified).

Programmatic Use

Block Parameter: BreakpointsForDimension1Min | BreakpointsForDimension2Min
| ... | BreakpointsForDimension30Min

Type: character vector

Values: scalar

Default: '[]'

Breakpoints Maximum — Maximum value breakpoint data can have

[] | scalar

Specify the maximum value that a set of breakpoint data can have. The default value is [] (unspecified).

Programmatic Use

Block Parameter: BreakpointsForDimension1Max | BreakpointsForDimension2Max
| ... | BreakpointsForDimension30Max

Type: character vector

Values: scalar

Default: '[]'

Fraction — Fraction data type

Inherit: Inherit via internal rule (default) | double | single | fixdt(1,16,0) | <data type expression>

Specify the fraction data type. You can set it to:

- A rule that inherits a data type, for example, Inherit: Inherit via internal rule
- The name of a built-in data type, for example, single
- The name of a data type object, for example, a Simulink.NumericType object
- An expression that evaluates to a data type, for example, fixdt(1,16,0)

Click the **Show data type assistant** button  to display the **Data Type Assistant**, which helps you set the data type attributes. For more information, see “Specify Data Types Using Data Type Assistant”.

Programmatic Use

Block Parameter: FractionDataTypeStr

Type: character vector

Values: 'Inherit: Inherit via internal rule' | 'double' | 'single' |
'fixdt(1,16,0)' | <data type expression>

Default: 'Inherit: Inherit via internal rule'

Intermediate results — Intermediate results data type

Inherit: Same as output (default) | Inherit: Inherit via internal rule | double |
single | int8 | uint8 | int16 | uint16 | int32 | uint32 | int64 | uint64 | fixdt(1,16,0) |
fixdt(1,16,2^0,0) | <data type expression>

Specify the intermediate results data type. You can set it to:

- A rule that inherits a data type, for example, Inherit: Same as output

- The name of a built-in data type, for example, `single`
- The name of a data type object, for example, a `Simulink.NumericType` object
- An expression that evaluates to a data type, for example, `fixdt(1,16,0)`

Click the **Show data type assistant** button  to display the **Data Type Assistant**, which helps you set the data type attributes. For more information, see “Specify Data Types Using Data Type Assistant”.

Tip Use this parameter to specify higher (or lower) precision for internal computations than for table data or output data.

Programmatic Use

Block Parameter: `IntermediateResultsDataTypeStr`

Type: character vector

Values: `'Inherit: Inherit via internal rule'` | `'Inherit: Same as output'` | `'double'` | `'single'` | `'int8'` | `'uint8'` | `'int16'` | `'uint16'` | `'int32'` | `'uint32'` | `'int64'` | `'uint64'` | `'fixdt(1,16,0)'` | `'fixdt(1,16,2^0,0)'` | `'<data type expression>'`

Default: `'Inherit: Same as output'`

Output — Output data type

`Inherit: Same as input (default)` | `double` | `single` | `half` | `int8` | `uint8` | `int16` | `uint16` | `int32` | `uint32` | `int64` | `uint64` | `fixdt(1,16)` | `fixdt(1,16,0)` | `fixdt(1,16,2^0,0)` | `<data type expression>`

Specify the output data type. You can set it to:

- A rule that inherits a data type, for example, `Inherit: Inherit via back propagation`
- The name of a built-in data type, for example, `single`
- The name of a data type object, for example, a `Simulink.NumericType` object
- An expression that evaluates to a data type, for example, `fixdt(1,16,0)`

Click the **Show data type assistant** button  to display the **Data Type Assistant**, which helps you set the data type attributes. For more information, see “Specify Data Types Using Data Type Assistant”.

Programmatic Use

Block Parameter: `OutDataTypeStr`

Type: character vector

Values: `'Inherit: Inherit via back propagation'` | `'Inherit: Inherit from table data'` | `'Inherit: Same as first input'` | `'double'` | `'single'` | `'half'` | `'int8'` | `'uint8'` | `'int16'` | `'uint16'` | `'int32'` | `'uint32'` | `'int64'` | `'uint64'` | `'fixdt(1,16,0)'` | `'fixdt(1,16,2^0,0)'` | `'<data type expression>'`

Default: `'Inherit: Same as first input'`

Output Minimum — Minimum value the block can output

`[]` | scalar

Specify the minimum value that the block outputs. The default value is `[]` (unspecified). Simulink software uses this value to perform:

- Parameter range checking (see “Specify Minimum and Maximum Values for Block Parameters”).
- Simulation range checking (see “Specify Signal Ranges”).
- Automatic scaling of fixed-point data types.
- Optimization of the code that you generate from the model. This optimization can remove algorithmic code and affect the results of some simulation modes such as SIL or external mode.

Programmatic Use**Block Parameter:** OutMin**Type:** character vector**Values:** scalar**Default:** ' [] '**Output Maximum — Maximum value the block can output**

[] | scalar

Specify the maximum value that the block can output. The default value is [] (unspecified). Simulink software uses this value to perform:

- Parameter range checking (see “Specify Minimum and Maximum Values for Block Parameters”).
- Simulation range checking (see “Specify Signal Ranges”).
- Automatic scaling of fixed-point data types.
- Optimization of the code that you generate from the model. This optimization can remove algorithmic code and affect the results of some simulation modes such as SIL or external mode.

Programmatic Use**Block Parameter:** OutMax**Type:** character vector**Values:** scalar**Default:** ' [] '**Internal rule priority — Internal rule for intermediate calculations**

Speed (default) | Precision

Specify the internal rule for intermediate calculations. Select Speed for faster calculations. If you do, a loss of accuracy might occur, usually up to 2 bits.

Programmatic Use**Block Parameter:** InternalRulePriority**Type:** character vector**Values:** 'Speed' | 'Precision'**Default:** 'Speed'**Require all inputs to have the same data type — Require all inputs to have the same data type**

on (default) | off

Select to require all inputs to have the same data type.

Programmatic Use**Block Parameter:** InputSameDT**Type:** character vector**Values:** 'off' | 'on'**Default:** 'on'

Lock data type settings against changes by the fixed-point tools – Prevent fixed-point tools from overriding data types

off (default) | on

Select this parameter to prevent the fixed-point tools from overriding the data types you specify on this block. For more information, see “Lock the Output Data Type Setting” (Fixed-Point Designer).

Programmatic Use**Block Parameter:** LockScale**Type:** character vector**Values:** 'off' | 'on'**Default:** 'off'**Integer rounding mode – Rounding mode for fixed-point operations**

Simplest (default) | Ceiling | Convergent | Floor | Nearest | Round | Zero

Specify the rounding mode for fixed-point lookup table calculations that occur during simulation or execution of code generated from the model. For more information, see “Rounding” (Fixed-Point Designer).

This option does not affect rounding of values of block parameters. Simulink rounds such values to the nearest representable integer value. To control the rounding of a block parameter, enter an expression using a MATLAB rounding function into the edit field on the block dialog box.

Programmatic Use**Block Parameter:** RndMeth**Type:** character vector**Values:** 'Ceiling' | 'Convergent' | 'Floor' | 'Nearest' | 'Round' | 'Simplest' | 'Zero'**Default:** 'Simplest'**Saturate on integer overflow – Method of overflow action**

off (default) | on

| Action | Reasons for Taking This Action | What Happens for Overflows | Example |
|-------------------------------------|---|---|---|
| Select this check box (on). | Your model has possible overflow and you want explicit saturation protection in the generated code. | Overflows saturate to either the minimum or maximum value that the data type can represent. | An overflow associated with a signed 8-bit integer can saturate to -128 or 127. |
| Do not select this check box (off). | You want to optimize efficiency of your generated code. You want to avoid overspecifying how a block handles out-of-range signals. For more information, see “Troubleshoot Signal Range Errors”. | Overflows wrap to the appropriate value that is representable by the data type. | The number 130 does not fit in a signed 8-bit integer and wraps to -126. |

Tip If you save your model as version R2009a or earlier, this check box setting has no effect and no saturation code appears. This behavior preserves backward compatibility.

When you select this check box, saturation applies to every internal operation on the block, not just the output or result. In general, the code generation process can detect when overflow is not possible. In this case, the code generator does not produce saturation code.

Programmatic Use

Block Parameter: SaturateOnIntegerOverflow

Type: character vector

Values: 'off' | 'on'

Default: 'off'

Block Characteristics

| | |
|---------------------------------|---|
| Data Types | double enumerated fixed point half integer single |
| Direct Feedthrough | yes |
| Multidimensional Signals | yes |
| Variable-Size Signals | no |
| Zero-Crossing Detection | no |

More About

Tunable Table Size in the Generated Code

Suppose that you have a lookup table and want to make the size tunable in the generated code. When you use `Simulink.LookupTable` and `Simulink.Breakpoint` objects to configure lookup table data for calibration in the generated code, use the `SupportTunableSize` property of the objects to enable a tunable table size. When you do not use these classes, use the **Support tunable table size in code generation** parameter in an n-D Lookup Table block to enable a tunable table size.

Assume that:

- You define a `Simulink.Parameter` structure in the preload function of your model:

```
p = Simulink.Parameter;
p.Value.MaxIdx = [2 2];
p.Value.BP1 = [1 2 3];
p.Value.BP2 = [1 4 16];
p.Value.Table = [4 5 6; 16 19 20; 10 18 23];
p.DataType = 'Bus: slLookupTable';
p.CoderInfo.StorageClass = 'ExportedGlobal';

% Create bus object slBus1 from MATLAB structure
Simulink.Bus.createObject(p.Value);
slLookupTable = slBus1;
slLookupTable.Elements(1).DataType = 'uint32';
```

- These block parameters apply in the n-D Lookup Table block.

| Parameter | Value |
|----------------------------|-------|
| Number of table dimensions | 2 |

| Parameter | Value |
|--|----------|
| Table data | p.Table |
| Breakpoints 1 | p.BP1 |
| Breakpoints 2 | p.BP2 |
| Support tunable table size in code generation | on |
| Maximum indices for each dimension | p.MaxIdx |

The generated `model_types.h` header file contains a type definition that looks something like this.

```
typedef struct {
    uint32_T MaxIdx[2];
    real_T BP1[3];
    real_T BP2[3];
    real_T Table[9];
} sLookupTable;
```

The generated `model.c` file contains code that looks something like this.

```
/* Exported block parameters */
sLookupTable p = {
    { 2U, 2U },

    { 1.0, 2.0, 3.0 },

    { 1.0, 4.0, 16.0 },

    { 4.0, 16.0, 10.0, 5.0, 19.0, 18.0, 6.0, 20.0, 23.0 }
};

/* More code */

/* Model output function */
static void ex_lut_nd_tunable_table_output(int_T tid)
{
    /* Lookup_n-D: '<Root>/n-D Lookup Table' incorporates:
     * Inport: '<Root>/In1'
     * Inport: '<Root>/In2'
     */
    Y = look2_binlcpw(U1, U2, p.BP1, p.BP2, p.Table, ...
p.MaxIdx, p.MaxIdx[0] + 1U);

    /* Outport: '<Root>/Out1' */
    ex_lut_nd_tunable_table_Y.Out1 = Y;

    /* tid is required for a uniform function interface.
     * Argument tid is not used in the function. */
    UNUSED_PARAMETER(tid);
}
```

The highlighted line of code specifies a tunable table size for the lookup table. You can change the size and values of the lookup table and breakpoint data without regenerating or recompiling the code.

Enumerated Values in Lookup Tables

Suppose that you have a lookup table with an enumerated class like this defined:

```
classdef(Enumeration) Gears < Simulink.IntEnumType
    enumeration
        GEAR1(1),
        GEAR2(2),
        GEAR3(4),
        GEAR4(8),
        SPORTS(16),
        REVERSE(-1),
        NEUTRAL(0)
    end
end
```

n-D Lookup block has these settings:

- **Number of dimensions** to 1.
- **Table data** value is [5 10 20 40 80 -5 0].
- **Breakpoints 1** value is enumeration('Gears').
- Interpolation method is Flat.
- For an unordered search, set **Index search method** to Linear search and clear the **Begin index search using previous index result** check box.

Simulation produces a vector [10 -5 80], which correspond to GEAR2, REVERSE, and SPORTS.



Extended Capabilities

C/C++ Code Generation

Generate C and C++ code using Simulink® Coder™.

HDL Code Generation

Generate Verilog and VHDL code for FPGA and ASIC designs using HDL Coder™.

HDL Coder provides additional configuration options that affect HDL implementation and synthesized logic. For information about HDL code generation support for 2-D Lookup Table blocks, see “HDL Code Generation” on page 1-1022 .

Fixed-Point Conversion

Design and simulate fixed-point systems using Fixed-Point Designer™.

See Also

Direct Lookup Table (n-D) | Prelookup | Interpolation Using Prelookup | Lookup Table Dynamic | `Simulink.LookupTable` | `Simulink.Breakpoint`

Topics

"Import Lookup Table Data from MATLAB"

"About Lookup Table Blocks"

"Anatomy of a Lookup Table"

"Enter Breakpoints and Table Data"

"Guidelines for Choosing a Lookup Table"

Introduced in R2011a

n-D Lookup Table

Approximate n-dimensional function

Library: Simulink / Lookup Tables
HDL Coder / Lookup Tables

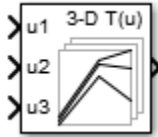

Description

Supported Block Operations

The 1-D, 2-D, and n-D Lookup Table blocks evaluate a sampled representation of a function in N variables

$$y = F(x_1, x_2, x_3, \dots, x_N)$$

where the function F can be empirical. The block maps inputs to an output value by looking up or interpolating a table of values you define with block parameters. The block supports flat (constant), linear (linear point-slope), Lagrange (linear Lagrange), nearest, cubic-spline, and Akima spline interpolation methods. You can apply these methods to a table of any dimension from 1 through 30.

In the following block, the first input identifies the first dimension (row) breakpoints, the second input identifies the second dimension (column) breakpoints, and so on.

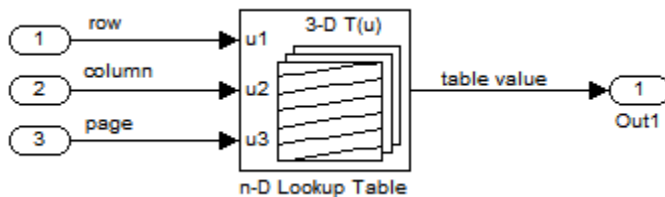

See “Port Location After Rotating or Flipping” for a description of the port order for various block orientations.

When the **Math and Data Types > Use algorithms optimized for row-major array layout** configuration parameter is set, the 2-D and n-D Lookup Table block behavior changes from column-major to row-major. For these blocks, the column-major and row-major algorithms may differ in the order of the output calculations, possibly resulting in slightly different numerical values. This capability requires a Simulink Coder or Embedded Coder license. For more information on row-major support, see “Code Generation of Matrices and Arrays” (Simulink Coder).

Specification of Breakpoint and Table Data

These block parameters define the breakpoint and table data.

| Block Parameter | Purpose |
|-----------------------------------|--|
| Number of table dimensions | Specifies the number of dimensions of your lookup table. |
| Breakpoints | Specifies a breakpoint vector that corresponds to each dimension of your lookup table. |
| Table data | Defines the associated set of output values. |

Tip Evenly spaced breakpoints can make the generated code division-free. For more information, see `fixpt_evenspace_cleanup` and “Identify questionable fixed-point operations” (Embedded Coder).

How the Block Generates Output

The n-D, 1-D and 2-D Lookup Table blocks generate output by looking up or estimating table values based on the input values.

| Block Inputs | n-D Lookup Table Block Behavior |
|--|--|
| Match the values of indices in breakpoint data sets | Outputs the table value at the intersection of the row, column, and higher dimension breakpoints |
| Do not match the values of indices in breakpoint data sets, but are within range | Interpolates appropriate table values, using the Interpolation method you select |
| Do not match the values of indices in breakpoint data sets, and are out of range | Extrapolates the output value, using the Extrapolation method you select |

Other Blocks that Perform Equivalent Operations

You can use the Interpolation Using Prelookup block with the Prelookup block to perform the equivalent operation of one n-D Lookup Table block. This combination of blocks offers greater flexibility that can result in more efficient simulation performance for linear interpolations.

When the lookup operation is an array access that does not require interpolation, use the Direct Lookup Table (n-D) block. For example, if you have an integer value k and you want the k th element of a table, $y = \text{table}(k)$, interpolation is unnecessary.

Ports

Input

u1 — First-dimension (row) inputs

scalar | vector | matrix

Real-valued inputs to the **u1** port, mapped to an output value by looking up or interpolating the table of values that you define.

Example: `0:10`

Data Types: `half` | `single` | `double` | `int8` | `int16` | `int32` | `int64` | `uint8` | `uint16` | `uint32` | `uint64` | `enumerated` | `fixed point`

uN — n-th dimension input values

scalar | vector | matrix

Real-valued inputs to the **uN** port, mapped to an output value by looking up or interpolating the table of values that you define.

Example: 0:10

Data Types: half | single | double | int8 | int16 | int32 | int64 | uint8 | uint16 | uint32 | uint64 | enumerated | fixed point

T – Define the table of output values

matrix of values with dimensions that match the **Number of table dimensions** and the breakpoint lengths for each dimension of the table

Specify the table of output values with a signal that is tunable at runtime.

During simulation, the matrix size must match the dimensions defined by the **Number of table dimensions** parameter. However, during block diagram editing, you can enter an empty matrix (specified as []) or an undefined workspace variable. This technique lets you postpone specifying a correctly dimensioned matrix for the table data and continue editing the block diagram.

Dependencies

To enable this port, set:

- **Data specification** to Table and breakpoints.
- **Table data** to Input port.

Data Types: half | single | double | int8 | int16 | int32 | int64 | uint8 | uint16 | uint32 | uint64 | fixed point

bp1 – Explicit breakpoint values

1-by-n or n-by-1 vector of monotonically increasing values

Specify the breakpoint data explicitly, based on the value of the **Breakpoints specification** parameter, with a signal that is tunable at runtime

- If you set **Breakpoints specification** to Explicit values, enter the breakpoint set that corresponds to each dimension of table data in each **Breakpoints** row. For each dimension, specify breakpoints as a 1-by-n or n-by-1 vector whose values are strictly monotonically increasing.

You can create up to three breakpoint data input ports. For breakpoints 4 to 30, you can specify breakpoint data only through the corresponding **Breakpoints** parameter.

Note To specify breakpoints in the even spacing specification format, set **Breakpoints specification** to Even spacing and use the **Breakpoints First** point and **Spacing** parameters.

Dependencies

To enable this port, set:

- **Data specification** to Table and breakpoints.
- **Breakpoints specification** to Explicit values.
- **Breakpoints 1** to Input port.

Data Types: half | single | double | int8 | int16 | int32 | int64 | uint8 | uint16 | uint32 | uint64 | enumerated | fixed point

bp2 — Explicit breakpoint values

1-by-n or n-by-1 vector of monotonically increasing values

Specify the breakpoint data explicitly, based on the value of the **Breakpoints specification** parameter, with a signal that is tunable at runtime.

- If you set **Breakpoints specification** to `Explicit values`, enter the breakpoint set that corresponds to each dimension of table data in each **Breakpoints** row. For each dimension, specify breakpoints as a 1-by-n or n-by-1 vector whose values are strictly monotonically increasing.

You can create up to three breakpoint data input ports. For breakpoints 4 to 30, you can specify breakpoint data only through the corresponding **Breakpoints** parameter.

Note To specify evenly spaced breakpoint data, use the **Breakpoints** parameter. You cannot specify evenly spaced breakpoint data through the input port.

Dependencies

To enable this port, set:

- **Data specification** to `Table` and `breakpoints`.
- **Breakpoints specification** to `Explicit values`.
- **Breakpoints 2** to `Input port`.

Data Types: half | single | double | int8 | int16 | int32 | int64 | uint8 | uint16 | uint32 | uint64 | enumerated | fixed point

bp3 — Explicit breakpoint values

1-by-n or n-by-1 vector of monotonically increasing values

Specify the breakpoint data explicitly, based on the value of the **Breakpoints specification** parameter, with a signal that is tunable at runtime.

- If you set **Breakpoints specification** to `Explicit values`, enter the breakpoint set that corresponds to each dimension of table data in each **Breakpoints** row. For each dimension, specify breakpoints as a 1-by-n or n-by-1 vector whose values are strictly monotonically increasing.

You can create up to three breakpoint data input ports. For breakpoints 4 to 30, you can specify breakpoint data only through the corresponding **Breakpoints** parameter.

Note To specify evenly spaced breakpoint data, use the **Breakpoints** parameter. You cannot specify evenly spaced breakpoint data through the input port.

Dependencies

To enable this port, set:

- **Data specification** to Table and breakpoints.
- **Breakpoints specification** to Explicit values.
- **Breakpoints 3** to Input port.

Data Types: half | single | double | int8 | int16 | int32 | int64 | uint8 | uint16 | uint32 | uint64 | enumerated | fixed point

Output

Port_1 – Output computed by looking up or estimating table values

scalar | vector | matrix

Output generated by looking up or estimating table values based on the input values:

| When block inputs... | The n-D Lookup Table block... |
|--|--|
| Match the values of indices in breakpoint data sets | Outputs the table value at the intersection of the row, column, and higher dimension breakpoints |
| Do not match the values of indices in breakpoint data sets, but are within range | Interpolates appropriate table values, using the Interpolation method you select |
| Do not match the values of indices in breakpoint data sets, and are out of range | Extrapolates the output value, using the Extrapolation method you select |

Data Types: half | single | double | int8 | int16 | int32 | int64 | uint8 | uint16 | uint32 | uint64 | fixed point

Parameters

Table and Breakpoints

Number of table dimensions – Number of lookup table dimensions

3 (default) | 1 | 2 | 4 | ... | 30

Enter the number of dimensions of the lookup table. This parameter determines:

- The number of independent variables for the table and the number of block inputs
- The number of breakpoint sets to specify

| Value | Setting |
|-------------------------------------|---|
| 1, 2, 3, or 4 | Select the value from the drop-down list. |
| A higher number of table dimensions | Enter a positive integer directly in the field. The maximum number of table dimensions that this block supports is 30. |

For example, a table with a size of $M \times N \times \dots$ means that the size of dimension 1 is M , the size of dimension 2 is N , and so forth. M must match the first breakpoint length, N must match the second breakpoint length, and so forth.

Programmatic Use

Block Parameter: NumberOfTableDimensions

Type: character vector

Values: '1' | '2' | '3' | '4' | ... | 30
Default: '3'

Data specification — Method of table and breakpoint specification

Table and breakpoints (default) | Lookup table object

From the list, select:

- Table and breakpoints — Specify the table data and breakpoints. Selecting this option enables the following parameters:
 - Table data
 - Breakpoints specification
 - Breakpoints 1
 - Breakpoints 2
 - Breakpoints 3
 - Edit table and breakpoints

To specify the table and breakpoints using input ports, see the **Source** parameter.

- Lookup table object — Use an existing lookup table (`Simulink.LookupTable`) object. Selecting this option enables the **Name** field and **Edit table and breakpoints** button.

Programmatic Use

Block Parameter: DataSpecification

Type: character vector

Values: 'Table and breakpoints' | 'Lookup table object'

Default: 'Table and breakpoints'

Name — Name of the lookup table object

[] (default) | `Simulink.LookupTable` object

Enter the name of the lookup table (`Simulink.LookupTable`) object. If a `Simulink.LookupTable`

object does not exist, click the action button  and select **Create**. The corresponding parameters of the new lookup table object are automatically populated with the block information.

Dependencies

To enable this parameter, set **Data specification** to `Lookup table object`.

Programmatic Use

Block Parameter: LookupTableObject

Type: character vector

Values: name of a `Simulink.LookupTable` object

Default: ''

Breakpoints specification — Method of breakpoint specification

Explicit values (default) | Even spacing

Specify whether to enter data as explicit breakpoints or as parameters that generate evenly spaced breakpoints.

- To explicitly specify breakpoint data, set this parameter to `Explicit values` and enter breakpoint data in the text box next to the **Breakpoints** parameters.

- To specify parameters that generate evenly spaced breakpoints, set this parameter to **Even spacing** and enter values for the **First point** and **Spacing** parameters for each dimension of breakpoint data. The block calculates the number of points to generate from the table data.

Dependencies

- To enable this parameter, set **Data specification** to **Table** and **breakpoints**.
- When this parameter is set to **Even spacing**, you can only specify breakpoint data through the dialog.

Programmatic Use**Block Parameter:** BreakpointsSpecification**Type:** character vector**Values:** 'Explicit values' | 'Even spacing'**Default:** 'Explicit values'**Source — Source of table and breakpoint data**

Dialog (default) | Input port

Specify the source of the table and breakpoint data as:

- **Dialog** — Specify the table or breakpoint data in **Value** parameter.
- **Input port** — Specify the table or breakpoint data through the associated input port.

You can create up to three breakpoint data input ports. For breakpoints 4 to 30, you can specify breakpoint data only through the corresponding **Breakpoints** parameter.

Note Using the input port to specify table or breakpoint data might negatively affect block performance for simulation due to runtime checks.

Dependencies

- To enable this parameter, set **Data specification** to **Table** and **breakpoints**.
- To enable the associated **Value**, set this parameter to **Dialog**.
- To enable the associated input port, set this parameter to **Input port**.
- Setting this parameter to **Input port** disables the **Value** field and hides the corresponding parameter on the **Data Types** tab.
- Setting this parameter to **Input port** for any one of the parameters disables the **Edit Table and Breakpoints** button.

Programmatic Use**Block Parameter:** TableSource | BreakpointsForDimension1Source | BreakpointsForDimension2Source | BreakpointsForDimension3Source**Type:** character vector**Values:** Dialog | Input port**Default:** 'Dialog'**Table data — Define the table of output values**reshape(repmat([4 5 6;16 19 20;10 18 23],1,2),[3,3,2]) (default) | matrix of values with dimensions that match the **Number of table dimensions**Enter the table of output values in the associated **Value** field.

During simulation, the matrix size must match the dimensions defined by the **Number of table dimensions** parameter. However, during block diagram editing, you can enter an empty matrix (specified as []) or an undefined workspace variable. This technique lets you postpone specifying a correctly dimensioned matrix for the table data and continue editing the block diagram.

Dependencies

To enable this parameter, set:

- **Data specification** to Table and breakpoints.
- **Table data: Source** to Dialog.

Programmatic Use

Block Parameter: Table

Type: character vector

Values: matrix of table values

Default: 'reshape(repmat([4 5 6;16 19 20;10 18 23],1,2),[3,3,2])'

Breakpoints — Explicit breakpoint values or first point and spacing of breakpoints

[10,22,31] (default) | 1-by-n or n-by-1 vector of monotonically increasing values

Specify the breakpoint data explicitly or as evenly-spaced breakpoints, based on the value of the **Breakpoints specification** parameter.

- If you set **Breakpoints specification** to `Explicit` values, enter the breakpoint set that corresponds to each dimension of table data in each **Breakpoints** row in the associated **Value** field. For each dimension, specify breakpoints as a 1-by-n or n-by-1 vector whose values are strictly monotonically increasing.
- If you set **Breakpoints specification** to `Even spacing`, enter the parameters **First point** and **Spacing** in each **Breakpoints** row to generate evenly-spaced breakpoints in the respective dimension. Your table data determines the number of evenly spaced points.

Dependencies

- To enable this parameter, set:
 - **Data specification** to Table and breakpoints.
 - **Table data: Source** to Dialog.
- When the **Breakpoints specification** parameter is set to `Even spacing`, you can only specify breakpoint data through the dialog.

Programmatic Use

Block Parameter: BreakpointsForDimension1 | BreakpointsForDimension2 | ... | BreakpointsForDimension30 |

Type: character vector

Values: 1-by-n or n-by-1 vector of monotonically increasing values

Default: '[10, 22, 31]'

First point — First point in evenly spaced breakpoint data

1 (default) | scalar

Specify the first point in your evenly spaced breakpoint data as a real-valued, finite scalar. This parameter is available when **Breakpoints specification** is set to `Even spacing`.

Dependencies

To enable this parameter, set **Data specification** to `Table` and `breakpoints`, and **Breakpoints specification** to `Even spacing`.

Programmatic Use

Block Parameter: `BreakpointsForDimension1FirstPoint` | `BreakpointsForDimension2FirstPoint` | ... | `BreakpointsForDimension30FirstPoint` |

Type: character vector

Values: real-valued, finite, scalar

Default: '1'

Spacing — Spacing between evenly spaced breakpoints

1 (default) | scalar

Specify the spacing between points in your evenly-spaced breakpoint data.

Dependencies

To enable this parameter, set **Data specification** to `Table` and `breakpoints`, and **Breakpoints specification** to `Even spacing`.

Programmatic Use

Block Parameter: `BreakpointsForDimension1Spacing` | `BreakpointsForDimension2Spacing` | ... | `BreakpointsForDimension30Spacing` |

Type: character vector

Values: positive, real-valued, finite, scalar

Default: '1'

Edit table and breakpoints — Open Lookup Table Editor dialog box

button

Click this button to open the Lookup Table Editor. For more information, see “Edit Lookup Tables” in the Simulink documentation.

Clicking this button for a lookup table object lets you edit the object and save the new values for the object.

Algorithm

Lookup method

Interpolation method — Method of interpolation between breakpoint values

`Linear point-slope` (default) | `Flat` | `Nearest` | `Linear Lagrange` | `Cubic spline` | `Akima spline`

When an input falls between breakpoint values, the block interpolates the output value using neighboring breakpoints. For more information on interpolation methods, see “Interpolation Methods”.

Dependencies

- If you select `Cubic spline`, the block supports only scalar signals. The other interpolation methods support nonscalar signals.
- If you select `Akima spline`, the extrapolation method can only be `Akima spline`.

When set to the modified Akima interpolation method, this block does not support:

- Row-major array layout and algorithms optimized for row-major array layout
- Scaled double and fixed-point data types
- Simulink.LookupTable objects
- Code generation when the configuration parameter **Code Generation > Interface > Support non-finite numbers** check box is selected

When set to the modified Akima interpolation method, this block is known to run more slowly when these conditions are true:

- Code generation-based simulation targets, such as those for accelerator mode, rapid accelerator mode, protected models, and so forth.
- Code generated for large breakpoint and data table sizes. For example with a table size of 629x1601.

Programmatic Use

Block Parameter: InterpMethod

Type: character vector

Values: 'Linear point-slope' | 'Flat' | 'Nearest' | 'Linear Lagrange' | 'Cubic spline' | 'Akima spline'

Default: 'Linear point-slope'

Extrapolation method — Method of handling input values that fall outside the range of a breakpoint data set

Linear (default) | Clip | Cubic spline | Akima spline

Select Clip, Linear, or Cubic spline. See “Extrapolation Methods” for more information.

If the extrapolation method is Linear, the extrapolation value is calculated based on the selected linear interpolation method. For example, if the interpolation method is linear Lagrange, the extrapolation method inherits the linear Lagrange equation to compute the extrapolated value.

Dependencies

- To select Cubic spline for **Extrapolation method**, you must also select Cubic spline for **Interpolation method**.
- To select Akima spline for **Extrapolation method**, you must also select Akima spline for **Interpolation method**.

Programmatic Use

Block Parameter: ExtrapMethod

Type: character vector

Values: 'Linear' | 'Clip' | 'Cubic spline' | 'Akima spline'

Default: 'Linear'

Index search method — Method of calculating table indices

Evenly spaced points (default) | Linear search | Binary search

Select Evenly spaced points, Linear search, or Binary search. Each search method has speed advantages in different circumstances:

- For evenly spaced breakpoint sets (for example, 10, 20, 30, and so on), you achieve optimal speed by selecting Evenly spaced points to calculate table indices.

This algorithm uses only the first two breakpoints of a set to determine the offset and spacing of the remaining points.

Note Set **Index search method** to `Evenly spaced points` when using the `Simulink.LookupTable` object to specify table data and the **Breakpoints Specification** parameter of the referenced `Simulink.LookupTable` object is set to `Even spacing`.

- For unevenly spaced breakpoint sets, follow these guidelines:
 - If input signals do not vary much between time steps, selecting `Linear search` with **Begin index search using previous index result** produces the best performance.
 - If input signals jump more than one or two table intervals per time step, selecting `Binary search` produces the best performance.

A suboptimal choice of index search method can lead to slow performance of models that rely heavily on lookup tables.

Note The generated code stores only the first breakpoint, the spacing, and the number of breakpoints when:

- The breakpoint data is not tunable.
 - The index search method is `Evenly spaced points`.
-

Programmatic Use

Block Parameter: `IndexSearchMethod`

Type: character vector

Values: `'Binary search'` | `'Evenly spaced points'` | `'Linear search'`

Default: `'Binary search'`

Begin index search using previous index result — Start using the index from the previous time step

`off` (default) | `on`

Select this check box when you want the block to start its search using the index found at the previous time step. For inputs that change slowly with respect to the interval size, enabling this option can improve performance. Otherwise, the linear search and binary search methods can take longer, especially for large breakpoint sets.

Dependencies

To enable this parameter, set **Index search method** to `Linear search` or `Binary search`.

Programmatic Use

Block Parameter: `BeginIndexSearchUsing PreviousIndexResult`

Type: character vector

Values: `'off'` | `'on'`

Default: `'off'`

Diagnostic for out-of-range input — Block action when input is out of range

`None` (default) | `Warning` | `Error`

Specify whether to produce a warning or error when the input is out of range. Options include:

- None — Produce no response.
- Warning — Display a warning and continue the simulation.
- Error — Terminate the simulation and display an error.

Programmatic Use**Block Parameter:** DiagnosticForOutOfRangeInput**Type:** character vector**Values:** 'None' | 'Warning' | 'Error'**Default:** 'None'**Apply full precision fixed-point algorithm when possible — More accurate fixed-point table lookup**

off (default) | on

Use this check box to enable full-precision fixed-point algorithm lookup for linear interpolation lookup when possible. This algorithm generally achieves better precision for hardware-efficient fixed-point rounding modes.

Dependencies

To enable this parameter, set:

- **Number of table dimensions** to 1.
- **Interpolation method** to Linear point-slope.
- **Extrapolation method** to Clip.

Programmatic Use**Block Parameter:** ApplyFullPrecisionForLinearInterpolation**Type:** character vector**Values:** 'off' | 'on'**Default:** 'off'**Use last table value for inputs at or above last breakpoint — Method for computing output for inputs at or above last breakpoint**

off (default) | on

Using this check box, specify the indexing convention that the block uses to address the last element of a breakpoint set and its corresponding table value. This check box is relevant if the input is equal to or larger than the last element of the breakpoint data. Due to rounding, selecting and clearing this check box may result in differing results for the last breakpoint between simulation and code generation.

| Check Box | Index Used by Block | Interval Fraction |
|-----------|---|-------------------|
| Selected | Last element of breakpoint data on the Table and Breakpoints tab | 0 |
| Cleared | Next-to-last element of breakpoint data on the Table and Breakpoints tab | 1 |

Given an input u within range of a breakpoint set bp , the interval fraction f , in the range $0 \leq f < 1$, is computed as shown below.

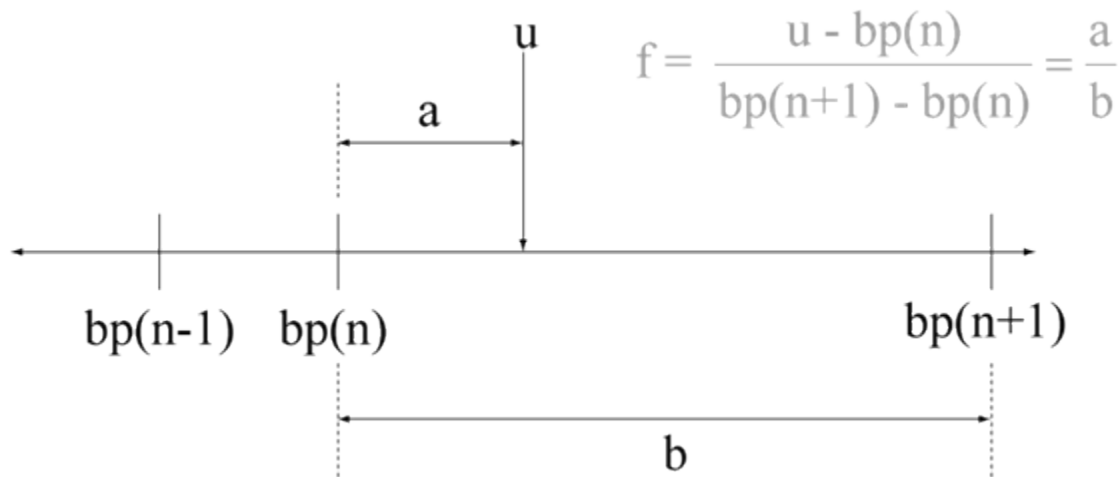

Suppose the breakpoint set is [1 4 5] and input u is 5.5. If you select this check box, the index is that of the last element (5) and the interval fraction is 0. If you clear this check box, the index is that of the next-to-last element (4) and the interval fraction is 1.

Dependencies

To enable this parameter, set:

- **Interpolation method** to Linear.
- **Extrapolation method** to Clip.

Programmatic Use

Block Parameter: UseLastTableValue

Type: character vector

Values: 'off' | 'on'

Default: 'off'

Input settings

Use one input port for all input data – Use only one input port

off (default) | on

Select this check box to use only one input port that expects a signal that is n elements wide for an n -dimensional table. This option is useful for removing line clutter on a block diagram with many lookup tables.

Note When you select this check box, one input port with the label u appears on the block.

Programmatic Use

Block Parameter: UseOneInputPortForAllInputData

Type: character vector

Values: 'off' | 'on'

Default: 'off'

Code generation**Remove protection against out-of-range input in generated code — Remove code that checks for out-of-range input values**

off (default) | on

Specify whether or not to include code that checks for out-of-range input values.

| Check Box | Result | When to Use |
|-----------|--|----------------------------------|
| on | Generated code does not include conditional statements to check for out-of-range breakpoint inputs. When the input is out-of-range, it may cause undefined behavior for generated code. | For code efficiency |
| off | Generated code includes conditional statements to check for out-of-range inputs. | For safety-critical applications |

If your input is not out of range, you can select the **Remove protection against out-of-range index in generated code** check box for code efficiency. By default, this check box is cleared. For safety-critical applications, do not select this check box. If you want to select the **Remove protection against out-of-range index in generated code** check box, first check that your model inputs are in range. For example:

- 1 Clear the **Remove protection against out-of-range index in generated code** check box.
- 2 Set the **Diagnostic for out-of-range input** parameter to Error.
- 3 Simulate the model in normal mode.
- 4 If there are out-of-range errors, fix them to be in range and run the simulation again.
- 5 When the simulation no longer generates out-of-range input errors, select the **Remove protection against out-of-range index in generated code** check box.

Note When you select the **Remove protection against out-of-range index in generated code** check box and the input is out of range, the behavior is undefined for generated code.

Depending on your application, you can run the following Model Advisor checks to verify the usage of this check box:

- **By Product > Embedded Coder > Identify lookup table blocks that generate expensive out-of-range checking code**
- **By Product > Simulink Check > Modeling Standards > DO-178C/DO-331 Checks > Check usage of lookup table blocks**

For more information about the Model Advisor, see “Run Model Advisor Checks”.

Additionally, to determine if it is safe to select this check box, if you have a Simulink Design Verifier license, consider using the “Detect Block Input Range Violations” (Simulink Design Verifier) check.

Programmatic Use**Block Parameter:** RemoveProtectionInput**Type:** character vector**Values:** 'off' | 'on'**Default:** 'off'**Support tunable table size in code generation — Enable tunable table size in the generated code**

off (default) | on

Select this check box to enable tunable table size in the generated code. This option enables you to change the size and values of the lookup table and breakpoint data in the generated code without regenerating or recompiling the code. You can only decrease the size of the lookup table and breakpoint data.

Dependencies

If you set **Interpolation method** to Cubic spline, this check box is not available.

Programmatic Use**Block Parameter:** SupportTunableTableSize**Type:** character vector**Values:** 'off' | 'on'**Default:** 'off'**Sample time — Specify sample time as a value other than -1**

-1 (default) | scalar | vector

Specify the sample time as a value other than -1. For more information, see “Specify Sample Time”.

Dependencies

This parameter is not visible unless it is explicitly set to a value other than -1. To learn more, see “Blocks for Which Sample Time Is Not Recommended”.

Programmatic Use**Block Parameter:** SampleTime**Type:** character vector**Values:** scalar or vector**Default:** '-1'**Maximum indices for each dimension — Maximum index value for each table dimension**

[] (default) | scalar or vector of positive integer values

Example: [4 6] for a 5-by-7 table

Specify the maximum index values for each table dimension using zero-based indexing. You can specify a scalar or vector of positive integer values using the following data types:

- Built-in floating-point types: double and single
- Built-in integer types: int8, int16, int32, uint8, uint16, and uint32

Examples of valid specifications include:

- [4 6] for a 5-by-7 table
- [int8(2) int16(5) int32(9)] for a 3-by-6-by-10 table

- A `Simulink.Parameter` whose value on generating code is one less than the dimensions of the table data. For more information, see “Tunable Table Size in the Generated Code” on page 1-1020.

Dependencies

To enable this parameter, select **Support tunable table size in code generation**. On tuning this parameter in the generated code, provide the new table data and breakpoints along with the tuned parameter value.

Programmatic Use

Block Parameter: `MaximumIndicesForEachDimension`

Type: character vector

Values: scalar or vector of positive integer values

Default: `[]`

Data Types

Table data — Data type of table data

Inherit: `Same as output (default) | double | single | half | int8 | uint8 | int16 | uint16 | int32 | uint32 | int64 | uint64 | fixdt(1,16) | fixdt(1,16,0) | fixdt(1,16,2^0,0) | <data type expression>`

Specify the table data type. You can set it to:

- A rule that inherits a data type, for example, `Inherit: Same as output`
- The name of a built-in data type, for example, `single`
- The name of a data type object, for example, a `Simulink.NumericType` object
- An expression that evaluates to a data type, for example, `fixdt(1,16,0)`

Click the **Show data type assistant** button  to display the **Data Type Assistant**, which helps you set the data type attributes. For more information, see “Specify Data Types Using Data Type Assistant”.

Tip Specify a table data type different from the output data type for these cases:

- Lower memory requirement for storing table data that uses a smaller type than the output signal
 - Sharing of prescaled table data between two n-D Lookup Table blocks with different output data types
 - Sharing of custom storage table data in the generated code for blocks with different output data types
-

Dependencies

To enable this parameter, set **Table data** from the **Table and Breakpoints** tab to `Dialog`.

Programmatic Use

Block Parameter: `TableDataTypeStr`

Type: character vector

Values: `'Inherit: Inherit from 'Table data'' | 'Inherit: Same as output' | 'double' | 'single' | 'half' | 'int8' | 'uint8' | 'int16' | 'uint16' |`

'int32' | 'uint32' | 'int64' | 'uint64' | 'fixdt(1,16)' | 'fixdt(1,16,0)' | 'fixdt(1,16,2^0,0)' | '<data type expression>'

Default: 'Inherit: Same as output'

Table data Minimum — Minimum value of the table data

[] | scalar

Specify the minimum value for table data. The default value is [] (unspecified).

Programmatic Use

Block Parameter: TableMin

Type: character vector

Values: scalar

Default: '[]'

Table data Maximum — Maximum value of the table data

[] | scalar

Specify the maximum value for table data. The default value is [] (unspecified).

Programmatic Use

Block Parameter: TableMax

Type: character vector

Values: scalar

Default: '[]'

Breakpoints — Breakpoint data type

Inherit: Same as corresponding input (default) | double | single | half | int8 | uint8 | int16 | uint16 | int32 | uint32 | int64 | uint64 | fixdt(1,16) | fixdt(1,16,0) | fixdt(1,16,2^0,0) | Enum: <class name> | <data type expression>

Specify the data type for a set of breakpoint data. You can set it to:

- A rule that inherits a data type, for example, `Inherit: Same as corresponding input`
- The name of a built-in data type, for example, `single`
- The name of a data type class, for example, an enumerated data type class
- The name of a data type object, for example, a `Simulink.NumericType` object
- An expression that evaluates to a data type, for example, `fixdt(1,16,0)`

Tip

- Breakpoints support unordered enumerated data. As a result, linear searches are also unordered, which offers flexibility but can impact performance. The search begins from the first element in the breakpoint.
 - If the **Begin index search using previous index result** check box is selected, you must use ordered monotonically increasing data. This ordering improves performance.
 - For enumerated data, **Extrapolation method** must be `Clip`.
 - The block does not support out-of-range input for enumerated data. When specifying enumerated data, include the entire enumeration set in the breakpoint data set. For example, use the `enumeration` function.
-

This is a limitation for using enumerated data with this block:

- The block does not support out-of-range input for enumerated data. When specifying enumerated data, include the entire enumeration set in the breakpoint data set. For example, use the enumeration function.

Click the **Show data type assistant** button  to display the **Data Type Assistant**, which helps you set the data type attributes. For more information, see “Specify Data Types Using Data Type Assistant”.

Tip Specify a breakpoint data type different from the corresponding input data type for these cases:

- Lower memory requirement for storing breakpoint data that uses a smaller type than the input signal
- Sharing of prescaled breakpoint data between two n-D Lookup Table blocks with different input data types
- Sharing of custom storage breakpoint data in the generated code for blocks with different input data types

Specify the same slope and bias for a breakpoint data type and its corresponding input data type if either of them has a fixed-point data type.

Dependencies

To enable this parameter, set the corresponding **Breakpoints** parameter from the **Table and Breakpoints** tab to Dialog.

Programmatic Use

Block Parameter: BreakpointsForDimension1DataTypeStr | BreakpointsForDimension2DataTypeStr | ... | BreakpointsForDimension30DataTypeStr

Type: character vector

Values: 'Inherit: Same as corresponding input' | 'Inherit: Inherit from 'Breakpoint data'' | 'double' | 'single' | 'half' | 'int8' | 'uint8' | 'int16' | 'uint16' | 'int32' | 'uint32' | 'int64' | 'uint64' | 'fixdt(1,16)' | 'fixdt(1,16,0)' | 'fixdt(1,16,2^0,0)' | '<data type expression>'

Default: 'Inherit: Same as corresponding input'

Breakpoints Minimum — Minimum value breakpoint data can have

[] | scalar

Specify the minimum value that a set of breakpoint data can have. The default value is [] (unspecified).

Programmatic Use

Block Parameter: BreakpointsForDimension1Min | BreakpointsForDimension2Min | ... | BreakpointsForDimension30Min

Type: character vector

Values: scalar

Default: '[]'

Breakpoints Maximum — Maximum value breakpoint data can have

[] | scalar

Specify the maximum value that a set of breakpoint data can have. The default value is [] (unspecified).

Programmatic Use

Block Parameter: BreakpointsForDimension1Max | BreakpointsForDimension2Max
| ... | BreakpointsForDimension30Max

Type: character vector

Values: scalar

Default: '[]'

Fraction — Fraction data type

Inherit: Inherit via internal rule (default) | double | single | fixdt(1,16,0) | <data type expression>

Specify the fraction data type. You can set it to:

- A rule that inherits a data type, for example, Inherit: Inherit via internal rule
- The name of a built-in data type, for example, single
- The name of a data type object, for example, a Simulink.NumericType object
- An expression that evaluates to a data type, for example, fixdt(1,16,0)

Click the **Show data type assistant** button  to display the **Data Type Assistant**, which helps you set the data type attributes. For more information, see “Specify Data Types Using Data Type Assistant”.

Programmatic Use

Block Parameter: FractionDataTypeStr

Type: character vector

Values: 'Inherit: Inherit via internal rule' | 'double' | 'single' | 'fixdt(1,16,0)' | <data type expression>

Default: 'Inherit: Inherit via internal rule'

Intermediate results — Intermediate results data type

Inherit: Same as output (default) | Inherit: Inherit via internal rule | double | single | int8 | uint8 | int16 | uint16 | int32 | uint32 | int64 | uint64 | fixdt(1,16,0) | fixdt(1,16,2^0,0) | <data type expression>

Specify the intermediate results data type. You can set it to:

- A rule that inherits a data type, for example, Inherit: Same as output
- The name of a built-in data type, for example, single
- The name of a data type object, for example, a Simulink.NumericType object
- An expression that evaluates to a data type, for example, fixdt(1,16,0)

Click the **Show data type assistant** button  to display the **Data Type Assistant**, which helps you set the data type attributes. For more information, see “Specify Data Types Using Data Type Assistant”.

Tip Use this parameter to specify higher (or lower) precision for internal computations than for table data or output data.

Programmatic Use

Block Parameter: IntermediateResultsDataTypeStr

Type: character vector

Values: 'Inherit: Inherit via internal rule' | 'Inherit: Same as output' | 'double' | 'single' | 'int8' | 'uint8' | 'int16' | 'uint16' | 'int32' | 'uint32' | 'int64' | 'uint64' | 'fixdt(1,16,0)' | 'fixdt(1,16,2^0,0)' | '<data type expression>'

Default: 'Inherit: Same as output'

Output — Output data type

Inherit: Same as input (default) | double | single | half | int8 | uint8 | int16 | uint16 | int32 | uint32 | int64 | uint64 | fixdt(1,16) | fixdt(1,16,0) | fixdt(1,16,2^0,0) | <data type expression>

Specify the output data type. You can set it to:

- A rule that inherits a data type, for example, `Inherit: Inherit via back propagation`
- The name of a built-in data type, for example, `single`
- The name of a data type object, for example, a `Simulink.NumericType` object
- An expression that evaluates to a data type, for example, `fixdt(1,16,0)`

Click the **Show data type assistant** button  to display the **Data Type Assistant**, which helps you set the data type attributes. For more information, see “Specify Data Types Using Data Type Assistant”.

Programmatic Use

Block Parameter: OutDataTypeStr

Type: character vector

Values: 'Inherit: Inherit via back propagation' | 'Inherit: Inherit from table data' | 'Inherit: Same as first input' | 'double' | 'single' | 'half' | 'int8' | 'uint8' | 'int16' | 'uint16' | 'int32' | 'uint32' | 'int64' | 'uint64' | 'fixdt(1,16,0)' | 'fixdt(1,16,2^0,0)' | '<data type expression>'

Default: 'Inherit: Same as first input'

Output Minimum — Minimum value the block can output

[] | scalar

Specify the minimum value that the block outputs. The default value is [] (unspecified). Simulink software uses this value to perform:

- Parameter range checking (see “Specify Minimum and Maximum Values for Block Parameters”).
- Simulation range checking (see “Specify Signal Ranges”).
- Automatic scaling of fixed-point data types.
- Optimization of the code that you generate from the model. This optimization can remove algorithmic code and affect the results of some simulation modes such as SIL or external mode.

Programmatic Use**Block Parameter:** OutMin**Type:** character vector**Values:** scalar**Default:** ' [] '**Output Maximum — Maximum value the block can output**

[] | scalar

Specify the maximum value that the block can output. The default value is [] (unspecified). Simulink software uses this value to perform:

- Parameter range checking (see “Specify Minimum and Maximum Values for Block Parameters”).
- Simulation range checking (see “Specify Signal Ranges”).
- Automatic scaling of fixed-point data types.
- Optimization of the code that you generate from the model. This optimization can remove algorithmic code and affect the results of some simulation modes such as SIL or external mode.

Programmatic Use**Block Parameter:** OutMax**Type:** character vector**Values:** scalar**Default:** ' [] '**Internal rule priority — Internal rule for intermediate calculations**

Speed (default) | Precision

Specify the internal rule for intermediate calculations. Select Speed for faster calculations. If you do, a loss of accuracy might occur, usually up to 2 bits.

Programmatic Use**Block Parameter:** InternalRulePriority**Type:** character vector**Values:** 'Speed' | 'Precision'**Default:** 'Speed'**Require all inputs to have the same data type — Require all inputs to have the same data type**

on (default) | off

Select to require all inputs to have the same data type.

Programmatic Use**Block Parameter:** InputSameDT**Type:** character vector**Values:** 'off' | 'on'**Default:** 'on'**Lock data type settings against changes by the fixed-point tools — Prevent fixed-point tools from overriding data types**

off (default) | on

Select this parameter to prevent the fixed-point tools from overriding the data types you specify on this block. For more information, see “Lock the Output Data Type Setting” (Fixed-Point Designer).

Programmatic Use**Block Parameter:** LockScale**Type:** character vector**Values:** 'off' | 'on'**Default:** 'off'**Integer rounding mode — Rounding mode for fixed-point operations**

Simplest (default) | Ceiling | Convergent | Floor | Nearest | Round | Zero

Specify the rounding mode for fixed-point lookup table calculations that occur during simulation or execution of code generated from the model. For more information, see “Rounding” (Fixed-Point Designer).

This option does not affect rounding of values of block parameters. Simulink rounds such values to the nearest representable integer value. To control the rounding of a block parameter, enter an expression using a MATLAB rounding function into the edit field on the block dialog box.

Programmatic Use**Block Parameter:** RndMeth**Type:** character vector**Values:** 'Ceiling' | 'Convergent' | 'Floor' | 'Nearest' | 'Round' | 'Simplest' | 'Zero'**Default:** 'Simplest'**Saturate on integer overflow — Method of overflow action**

off (default) | on

| Action | Reasons for Taking This Action | What Happens for Overflows | Example |
|-------------------------------------|---|---|---|
| Select this check box (on). | Your model has possible overflow and you want explicit saturation protection in the generated code. | Overflows saturate to either the minimum or maximum value that the data type can represent. | An overflow associated with a signed 8-bit integer can saturate to -128 or 127. |
| Do not select this check box (off). | You want to optimize efficiency of your generated code. You want to avoid overspecifying how a block handles out-of-range signals. For more information, see “Troubleshoot Signal Range Errors”. | Overflows wrap to the appropriate value that is representable by the data type. | The number 130 does not fit in a signed 8-bit integer and wraps to -126. |

Tip If you save your model as version R2009a or earlier, this check box setting has no effect and no saturation code appears. This behavior preserves backward compatibility.

When you select this check box, saturation applies to every internal operation on the block, not just the output or result. In general, the code generation process can detect when overflow is not possible. In this case, the code generator does not produce saturation code.

Programmatic Use**Block Parameter:** SaturateOnIntegerOverflow**Type:** character vector**Values:** 'off' | 'on'**Default:** 'off'**Block Characteristics**

| | |
|---------------------------------|---|
| Data Types | double enumerated fixed point half integer single |
| Direct Feedthrough | yes |
| Multidimensional Signals | yes |
| Variable-Size Signals | no |
| Zero-Crossing Detection | no |

More About**Tunable Table Size in the Generated Code**

Suppose that you have a lookup table and want to make the size tunable in the generated code. When you use `Simulink.LookupTable` and `Simulink.Breakpoint` objects to configure lookup table data for calibration in the generated code, use the `SupportTunableSize` property of the objects to enable a tunable table size. When you do not use these classes, use the **Support tunable table size in code generation** parameter in an n-D Lookup Table block to enable a tunable table size.

Assume that:

- You define a `Simulink.Parameter` structure in the preload function of your model:

```
p = Simulink.Parameter;
p.Value.MaxIdx = [2 2];
p.Value.BP1 = [1 2 3];
p.Value.BP2 = [1 4 16];
p.Value.Table = [4 5 6; 16 19 20; 10 18 23];
p.DataType = 'Bus: slLookupTable';
p.CoderInfo.StorageClass = 'ExportedGlobal';

% Create bus object slBus1 from MATLAB structure
Simulink.Bus.createObject(p.Value);
slLookupTable = slBus1;
slLookupTable.Elements(1).DataType = 'uint32';
```

- These block parameters apply in the n-D Lookup Table block.

| Parameter | Value |
|-----------------------------------|---------|
| Number of table dimensions | 2 |
| Table data | p.Table |
| Breakpoints 1 | p.BP1 |
| Breakpoints 2 | p.BP2 |

| Parameter | Value |
|--|----------|
| Support tunable table size in code generation | on |
| Maximum indices for each dimension | p.MaxIdx |

The generated `model_types.h` header file contains a type definition that looks something like this.

```
typedef struct {
    uint32_T MaxIdx[2];
    real_T BP1[3];
    real_T BP2[3];
    real_T Table[9];
} sLookupTable;
```

The generated `model.c` file contains code that looks something like this.

```
/* Exported block parameters */
sLookupTable p = {
    { 2U, 2U },

    { 1.0, 2.0, 3.0 },

    { 1.0, 4.0, 16.0 },

    { 4.0, 16.0, 10.0, 5.0, 19.0, 18.0, 6.0, 20.0, 23.0 }
};

/* More code */

/* Model output function */
static void ex_lut_nd_tunable_table_output(int_T tid)
{
    /* Lookup_n-D: '<Root>/n-D Lookup Table' incorporates:
     * Inport: '<Root>/In1'
     * Inport: '<Root>/In2'
     */
    Y = look2_binlcpw(U1, U2, p.BP1, p.BP2, p.Table, ...
p.MaxIdx, p.MaxIdx[0] + 1U);

    /* Output: '<Root>/Out1' */
    ex_lut_nd_tunable_table_Y.Out1 = Y;

    /* tid is required for a uniform function interface.
     * Argument tid is not used in the function. */
    UNUSED_PARAMETER(tid);
}
```

The highlighted line of code specifies a tunable table size for the lookup table. You can change the size and values of the lookup table and breakpoint data without regenerating or recompiling the code.

Enumerated Values in Lookup Tables

Suppose that you have a lookup table with an enumerated class like this defined:

```
classdef(Enumeration) Gears < Simulink.IntEnumType
    enumeration
        GEAR1(1),
```

```

        GEAR2(2),
        GEAR3(4),
        GEAR4(8),
        SPORTS(16),
        REVERSE(-1),
        NEUTRAL(0)
    end
end

```

n-D Lookup block has these settings:

- **Number of dimensions** to 1.
- **Table data** value is [5 10 20 40 80 -5 0].
- **Breakpoints 1** value is enumeration('Gears').
- Interpolation method is Flat.
- For an unordered search, set **Index search method** to Linear search and clear the **Begin index search using previous index result** check box.

Simulation produces a vector [10 -5 80], which correspond to GEAR2, REVERSE, and SPORTS.



Extended Capabilities

C/C++ Code Generation

Generate C and C++ code using Simulink® Coder™.

HDL Code Generation

Generate Verilog and VHDL code for FPGA and ASIC designs using HDL Coder™.

HDL Coder provides additional configuration options that affect HDL implementation and synthesized logic.

HDL Architecture

This block has a single, default HDL architecture.

HDL Block Properties

| General | |
|----------------------------------|--|
| ConstrainedOutputPipeline | Number of registers to place at the outputs by moving existing delays within your design. Distributed pipelining does not redistribute these registers. The default is 0. For more details, see “ConstrainedOutputPipeline” (HDL Coder). |

| General | |
|-----------------------|--|
| InputPipeline | Number of input pipeline stages to insert in the generated code. Distributed pipelining and constrained output pipelining can move these registers. The default is 0. For more details, see “InputPipeline” (HDL Coder). |
| MapToRAM | Map lookup tables (LUTs) to RAM. The default is on. See also “MapToRAM” (HDL Coder). |
| OutputPipeline | Number of output pipeline stages to insert in the generated code. Distributed pipelining and constrained output pipelining can move these registers. The default is 0. For more details, see “OutputPipeline” (HDL Coder). |

Note The block supports single, double, and half data types for HDL code generation.

| Native Floating Point | |
|---------------------------------|--|
| HandleDenormals | Specify whether you want HDL Coder to insert additional logic to handle denormal numbers in your design. Denormal numbers are numbers that have magnitudes less than the smallest floating-point number that can be represented without leading zeros in the mantissa. The default is inherit. See also “HandleDenormals” (HDL Coder). |
| LatencyStrategy | Specify whether to map the blocks in your design to inherit, Max, Min, or Zero for the floating-point operator. The default is inherit. See also “LatencyStrategy” (HDL Coder). |
| MantissaMultiplyStrategy | Specify how to implement the mantissa multiplication operation during code generation. By using different settings, you can control the DSP usage on the target FPGA device. The default is inherit. See also “MantissaMultiplyStrategy” (HDL Coder). |
| PrecomputeCoefficients | <p>To enable this property, set Interpolation method to Linear point-slope.</p> <p>When you enable this property, the slope and bias coefficients are statically precomputed depending on the table data and breakpoints. This setting reduces the number of division operations that are performed during runtime to compute the coefficients. It also reduces the overall number of floating-point addition and multiplication operations that are performed.</p> <p>Enabling this property reduces the latency and saves area number of lookup table resources that are required. However, this property reorders the floating-point operations, which might result in small numeric differences. You can observe these numerical differences in the generated validation model.</p> |

| Native Floating Point | |
|-------------------------|---|
| AreaOptimization | For 4-D and 5-D LUT, HDL code generation supports fully parallel and serial implementations. To enable this property, use linear interpolation method for 4-D and 5-D LUT. When you set this property to either <code>Parallel</code> or <code>Serial</code> , HDL Coder manipulates the resources for your design. To reduce the area of your design, use serial implementation for minimizing the resources. To observe the results of fully parallel and serial implementation, compare the resource utilization report of native floating-point operators for your design. You can also compare the synthesis results of the design for fully parallel and serial implementation. |

Complex Data Support

This block supports code generation for complex signals.

Required Block Settings

| Block Setting | HDL Coder Support |
|--|---|
| Number of table dimensions | Specify up to a maximum dimension of 5. |
| Breakpoints specification | Select either <code>Explicit values</code> or <code>Even spacing</code> . |
| Extrapolation method | Select <code>Clip</code> or <code>Linear</code> . The code generator does not support extrapolation beyond even bounds. |
| Interpolation method | Select <code>Flat</code> or <code>Linear point-slope</code> . |
| Diagnostic for out-of-range input | Select <code>Error</code> . If you specify other options, HDL Coder generates a warning. |
| Use last table value for inputs at or above last breakpoint | Select this check box. |
| Require all inputs to have the same data type | Select this check box. |
| Fraction | Select <code>Inherit: Inherit via internal rule</code> . |
| Integer rounding mode | Select <code>Zero</code> , <code>Floor</code> , or <code>Simplest</code> . |
| Use one input port for all input data | Clear this check box. |

MAX 10 Device Settings

If you use Intel MAX 10 device, to map the lookup table to RAM, add this Tcl command when creating the project in the Quartus tool:

```
set_global_assignment -name INTERNAL_FLASH_UPDATE_MODE "SINGLE IMAGE WITH ERAM"
```

Avoid Generation of Divide Operator

If HDL Coder encounters conditions under which a division operation is required to match the model simulation behavior, a warning is displayed. The conditions described cause this block to emit a divide operator. When you use this block for HDL code generation, avoid these conditions:

- If the block is configured to use interpolation, a division operator is required. To avoid this requirement, set **Interpolation method** to `Flat`.

- Uneven table spacing. HDL code generation requires the block to use the evenly spaced points algorithm. The block mapping from the input data type to the zero-based table index in general requires a division. When the breakpoint spacing is an exact power of 2, this divide is implemented as a shift instead of as a divide. To adjust the breakpoint spacing, adjust the number of breakpoints in the table, or the difference between the left and right bounds of the breakpoint range.

Table Data Typing and Sizing

- It is good practice to structure your table such that the spacing between breakpoints is a power of two. If the breakpoint spacing does not meet this condition, HDL Coder issues a warning. When the breakpoint spacing is a power of two, you can replace division operations in the prelookup step with right-shift operations.
- All ports on the block require scalar values.

Restrictions

- HDL code generation supports only floating-point data inputs, breakpoints, and outputs for the 3-D, 4-D, and 5-D Lookup Table. For 1-D and 2-D Lookup Table blocks, both floating-point and fixed-point data inputs, breakpoints, and outputs are supported.
- When you set the **Interpolation method** to **Flat**, the block supports half data types for data inputs, breakpoints, and outputs. Linear interpolation is not supported for half data types.
- HDL code generation for n-D Lookup Table blocks with fixed-point data type supports only Evenly spaced points as the index search method.

PLC Code Generation

Generate Structured Text code using Simulink® PLC Coder™.

Simulink PLC Coder has limited support for lookup table blocks. The coder does not support:

- Number of dimensions greater than 2
- Cubic spline interpolation method
- Begin index search using a previous index mode
- Cubic spline extrapolation method

Fixed-Point Conversion

Design and simulate fixed-point systems using Fixed-Point Designer™.

See Also

[Direct Lookup Table \(n-D\)](#) | [Prelookup](#) | [Interpolation Using Prelookup](#) | [Lookup Table Dynamic](#) | [Simulink.LookupTable](#) | [Simulink.Breakpoint](#)

Topics

“Import Lookup Table Data from MATLAB”

“About Lookup Table Blocks”

“Anatomy of a Lookup Table”

“Enter Breakpoints and Table Data”

“Guidelines for Choosing a Lookup Table”

“Interpolation Algorithm for Row-Major Array Layout” (Simulink Coder)

Introduced in R2011a

Lookup Table Dynamic

Approximate a one-dimensional function using dynamic table

Library: Simulink / Lookup Tables

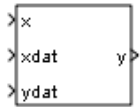

Description

How This Block Differs from Other Lookup Table Blocks

The Lookup Table Dynamic block computes an approximation of a function $y = f(x)$ using `xdat` and `ydat` vectors. The lookup method can use interpolation, extrapolation, or the original values of the input.

Using the Lookup Table Dynamic block, you can change the table data without stopping the simulation. For example, you can incorporate new table data if the physical system you are simulating changes.

Inputs for Breakpoint and Table Data

The `xdat` vector is the breakpoint data, which must be *strictly monotonically increasing*. The value of the next element in the vector must be greater than the value of the preceding element after conversion to a fixed-point data type. Due to quantization, `xdat` can be strictly monotonic for a floating-point data type, but not after conversion to a fixed-point data type.

The `ydat` vector is the table data, which is an evaluation of the function at the breakpoint values.

Note The inputs to `xdat` and `ydat` cannot be scalar (one-element array) values. If you provide a scalar value to either of these inputs, you see an error upon simulation. Provide a 1-by-n vector to both the `xdat` and `ydat` inputs.

Lookup Table Definition

You define the lookup table by feeding `xdat` and `ydat` as 1-by-n vectors to the block. To reduce ROM usage in the generated code for this block, you can use different data types for `xdat` and `ydat`. However, these restrictions apply:

- The `xdat` breakpoint data and the `x` input vector must have the same sign, bias, and fractional slope. Also, the precision and range for `x` must be greater than or equal to the precision and range for `xdat`.
- The `ydat` table data and the `y` output vector must have the same sign, bias, and fractional slope.

Tip Breakpoints with even spacing can make Simulink Coder generated code division-free. For more information, see `fixpt_evenspace_cleanup` in the Simulink documentation and “Identify questionable fixed-point operations” (Embedded Coder) in the Simulink Coder documentation.

How the Block Generates Output

The block uses the input values to generate output using the method you select for **Lookup Method**:

| Lookup Method | Block Action |
|--|---|
| Interpolation-Extrapolation | <p>Performs linear interpolation and extrapolation of the inputs.</p> <ul style="list-style-type: none"> • If the input matches a breakpoint, the output is the corresponding element in the table data. • If the input does not match a breakpoint, the block performs linear interpolation between two elements of the table to determine the output. If the input falls outside the range of breakpoint values, the block extrapolates using the first two or last two points. <p>Note If you select this lookup method, Simulink Coder software cannot generate code for this block.</p> |
| Interpolation-Use End Values (default) | Performs linear interpolation but does not extrapolate outside the end points of the breakpoint data. Instead, the block uses the end values. |
| Use Input Nearest | Finds the element in <code>xdat</code> nearest the current input. The corresponding element in <code>ydat</code> is the output. |
| Use Input Below | Finds the element in <code>xdat</code> nearest and below the current input. The corresponding element in <code>ydat</code> is the output. If there is no element in <code>xdat</code> below the current input, the block finds the nearest element. |
| Use Input Above | Finds the element in <code>xdat</code> nearest and above the current input. The corresponding element in <code>ydat</code> is the output. If there is no element in <code>xdat</code> above the current input, the block finds the nearest element. |

Note The Use Input Nearest, Use Input Below, and Use Input Above methods perform the same action when the input `x` matches a breakpoint value.

Some continuous solvers subdivide the simulation time span into major and minor time steps. A minor time step is a subdivision of the major time step. The solver produces a result at each major time step and uses results at minor time steps to improve the accuracy of the result at the major time step. For continuous solvers, the output of the Lookup Table Dynamic block can appear like a stair step because the signal is fixed in minor time step to avoid incorrect results. For more information about the effect of solvers on block output, see “Compare Solvers” in the Simulink documentation.

Ports

Input

x — input vector

scalar | vector | 2-D array

The block accepts real-valued or complex-valued inputs.

Example: 2:12

Dependencies

The **x** input vector and the **xdat** breakpoint data must have the same sign, bias, and fractional slope. Also, the precision and range for **x** must be greater than or equal to the precision and range for **xdat**.

Data Types: single | double | int8 | int16 | int32 | int64 | uint8 | uint16 | uint32 | uint64 | Boolean | fixed point | bus

xdat — breakpoint data

1-by-n vector of strictly monotonically increasing values

The **xdat** vector is the breakpoint data, which must be strictly monotonically increasing. The value of the next element in the vector must be greater than the value of the preceding element after conversion to a fixed-point data type. Due to quantization, **xdat** can be strictly monotonic for a floating-point data type, but not after conversion to a fixed-point data type.

Tip Breakpoints with even spacing can make Simulink Coder generated code division-free. For more information, see `fixpt_evenspace_cleanup` in the Simulink documentation and “Identify questionable fixed-point operations” (Embedded Coder) in the Simulink Coder documentation.

Example: 1:10

Dependencies

The **xdat** breakpoint data and the **x** input vector must have the same sign, bias, and fractional slope. Also, the precision and range for **x** must be greater than or equal to the precision and range for **xdat**.

Data Types: single | double | int8 | int16 | int32 | int64 | uint8 | uint16 | uint32 | uint64 | Boolean | fixed point | bus

ydat — table data

1-by-n vector

The **ydat** input is a 1-by-n vector of real-valued or complex-valued table data, which is an evaluation of the function at the breakpoint values.

Example: [0 3 12 27 48 75 108 147 192 243 300]

Dependencies

The **ydat** table data and the **y** output vector must have the same sign, bias, and fractional slope.

Data Types: single | double | int8 | int16 | int32 | int64 | uint8 | uint16 | uint32 | uint64 | Boolean | fixed point | bus

Output

y — Approximation of $y = f(x)$ using dynamic table data

1-by-n vector

The block computes an approximation of a function $y = f(x)$ using the `xdat` and `ydat` input vectors. The lookup method can use interpolation, extrapolation, or the original values of the input.

Dependencies

The `ydat` table data and the `y` output vector must have the same sign, bias, and fractional slope.

Data Types: `single` | `double` | `int8` | `int16` | `int32` | `int64` | `uint8` | `uint16` | `uint32` | `uint64` | `Boolean` | `fixed point`

Parameters

Main Tab

Lookup Method — Specify the lookup method

`Interpolation-Use End Values (default)` | `Interpolation-Extrapolation` | `Use Input Nearest` | `Use Input Below` | `Use Input Above`

The block computes output by applying the **Lookup Method** you select to the input vectors of breakpoint data (`xdat`) and table data (`ydat`). For details, see “How the Block Generates Output” on page 1-1027.

Programmatic Use

Block Parameter: `LookUpMeth`

Type: character vector

Values: `'Interpolation-Extrapolation'` | `'Interpolation-Use End Values'` | `'Use Input Nearest'` | `'Use Input Below'` | `'Use Input Above'`

Default: `'Interpolation-Use End Values'`

Signal Attributes Tab

Output data type — Output data type

`double (default)` | `'Inherit: Inherit via back propagation'` | `single` | `int8` | `uint8` | `int16` | `uint16` | `int32` | `uint32` | `int64` | `uint64` | `boolean` | `fixdt(1,16,0)` | `fixdt(1,16,2^0,0)` | `<data type expression>`

Specify the data type of the output signal `y`.

Click the **Show data type assistant** button  to display the **Data Type Assistant**, which helps you set the data type attributes. For more information, see “Specify Data Types Using Data Type Assistant”.

Dependencies

The `ydat` table data and the `y` output vector must have the same sign, bias, and fractional slope.

Programmatic Use

Block Parameter: `OutDataTypeStr`

Type: character vector

Values: 'Inherit: Inherit via back propagation' | 'double' | 'single' | 'int8' | 'uint8' | 'int16' | 'uint16' | 'int32' | 'uint32' | 'int64' | 'uint64' | 'boolean' | 'fixdt(1,16,0)' | 'fixdt(1,16,2^0,0)' | <data type expression>
Default: 'double'

Lock output data type setting against changes by the fixed-point tools — Prevent fixed-point tools from overriding Output data type

off (default) | on

Select this parameter to prevent the fixed-point tools from overriding the **Output** data type you specify on the block. For more information, see “Use Lock Output Data Type Setting” (Fixed-Point Designer).

Programmatic Use

Block Parameter: LockScale

Type: character vector

Values: 'off' | 'on'

Default: 'off'

Integer rounding mode — Rounding mode for fixed-point operations

Floor (default) | Ceiling | Convergent | Nearest | Round | Simplest | Zero

Specify the rounding mode for fixed-point operations. For more information, see “Rounding” (Fixed-Point Designer).

Block parameters always round to the nearest representable value. To control the rounding of a block parameter, enter an expression using a MATLAB rounding function into the mask field.

Programmatic Use

Block Parameter: RndMeth

Type: character vector

Values: 'Ceiling' | 'Convergent' | 'Floor' | 'Nearest' | 'Round' | 'Simplest' | 'Zero'

Default: 'Floor'

Saturate to max or min when overflows occur — Method of overflow action

off (default) | on

When you select this check box, overflows saturate to the maximum or minimum value that the data type can represent. Otherwise, overflows wrap.

When you select this check box, saturation applies to every internal operation on the block, not just the output or result. In general, the code generation process can detect when overflow is not possible. In this case, the code generator does not produce saturation code.

Programmatic Use

Block Parameter: DoSatur

Type: character vector

Values: 'off' | 'on'

Default: 'off'

Block Characteristics

| | |
|-------------------|---|
| Data Types | Boolean double fixed point integer single |
|-------------------|---|

| | |
|---------------------------------|-----|
| Direct Feedthrough | no |
| Multidimensional Signals | yes |
| Variable-Size Signals | no |
| Zero-Crossing Detection | no |

Extended Capabilities

C/C++ Code Generation

Generate C and C++ code using Simulink® Coder™.

PLC Code Generation

Generate Structured Text code using Simulink® PLC Coder™.

The Simulink PLC Coder software does not support the Simulink Lookup Table Dynamic block. For your convenience, the pplib/Simulink/Lookup Tables library contains an implementation of a dynamic table lookup block using the Prelookup and Interpolation Using Prelookup blocks.

Fixed-Point Conversion

Design and simulate fixed-point systems using Fixed-Point Designer™.

See Also

n-D Lookup Table

Topics

“Entering Data Using Inports of the Lookup Table Dynamic Block”

“Nonlinearity”

“About Lookup Table Blocks”

“Anatomy of a Lookup Table”

“Guidelines for Choosing a Lookup Table”

Introduced before R2006a

Magnitude-Angle to Complex

Convert magnitude and/or a phase angle signal to complex signal

Library: Simulink / Math Operations
HDL Coder / HDL Floating Point Operations



Description

Supported Operations

The Magnitude-Angle to Complex block converts magnitude and phase angle inputs to a complex output. The angle input must be in rad.

When there are two block inputs, the block supports these combinations of input dimensions:

- Two inputs of equal dimensions
- One scalar input and the other an n-dimensional array

If the block input is an array, the output is an array of complex signals. The elements of a magnitude input vector map to the magnitudes of the corresponding complex output elements. Similarly, the elements of an angle input vector map to the angles of the corresponding complex output elements. If one input is a scalar, it maps to the corresponding component (magnitude or angle) of all the complex output signals.

Effect of Out-of-Range Input on CORDIC Approximations

If you use the CORDIC approximation method [1], the block input for phase angle has these restrictions:

- For signed fixed-point types, the input angle must fall within the range $[-2\pi, 2\pi]$ rad.
- For unsigned fixed-point types, the input angle must fall within the range $[0, 2\pi]$ rad.

This table summarizes the effects of an out-of-range input:

| Block Usage | Effect of Out-of-Range Input |
|------------------|------------------------------|
| Simulation modes | An error appears. |
| Generated code | Undefined behavior occurs. |

When you use the CORDIC approximation, ensure that you use an in-range input for the Magnitude-Angle to Complex block. Avoid relying on undefined behavior for generated code or accelerator modes.

Ports

Input

$|u|$ — Magnitude

scalar | vector | matrix

Magnitude, specified as a real-valued scalar, vector, or matrix.

Dependencies

- To enable this port, set **Input** to Magnitude and angle.

Limitations

- If one input has a floating-point data type, the other input must use the same data type. For example, both signals must be `double` or `single`.
- Fixed-point data types are supported only when you set the **Approximation method** to CORDIC. When one input has a fixed-point data type, the other input must also have a fixed-point data type.

Data Types: `single` | `double` | `int8` | `int16` | `int32` | `int64` | `uint8` | `uint16` | `uint32` | `uint64` | `fixed point`

$\angle u$ — Radian phase angle

scalar | vector | matrix

Radian phase angle, specified as a real-valued scalar, vector, or matrix. To compute the CORDIC approximation, the input angle must be between:

- $[-2\pi, 2\pi)$ rad, for signed fixed-point types
- $[0, 2\pi)$ rad, for unsigned fixed-point types

For more information, see “Effect of Out-of-Range Input on CORDIC Approximations” on page 1-1032.

Dependencies

- To enable this port, set **Input** to Magnitude and angle.

Limitations

- If one input has a floating-point data type, the other input must use the same data type. For example, both signals must be `double` or `single`.
- Fixed-point data types are supported only when you set the **Approximation method** to CORDIC. If one input has a fixed-point data type, the other input must also have a fixed-point data type.

Data Types: `single` | `double` | `int8` | `int16` | `int32` | `int64` | `uint8` | `uint16` | `uint32` | `uint64` | `fixed point`

Port_1 — Magnitude or radian phase angle

scalar | vector | matrix

Magnitude, or radian phase angle, specified as a real-valued scalar, vector, or matrix.

- When you set **Input** to Magnitude, you specify the magnitude at the input port, and the angle on the dialog box.

- When you set **Input** to **Angle**, you specify the angle at the input port, and the magnitude on the dialog box.

Dependencies

To enable this port, set **Input** to **Magnitude** or **Angle**.

Data Types: `single` | `double` | `int8` | `int16` | `int32` | `int64` | `uint8` | `uint16` | `uint32` | `uint64` | `fixed point`

Output**Port_1 — Complex signal**

`scalar` | `vector` | `matrix`

Complex signal, formed from the magnitude and phase angle you specify.

If the block input is an array, the output is an array of complex signals. The elements of a magnitude input vector map to the magnitudes of the corresponding complex output elements. Similarly, the elements of an angle input vector map to the angles of the corresponding complex output elements. If one input is a scalar, it maps to the corresponding component (magnitude or angle) of all the complex output signals.

Data Types: `single` | `double` | `fixed point`

Parameters**Input — Type of input**

`Magnitude (default)` | `Angle` | `Magnitude and angle`

Specify the kind of input: a magnitude input, an angle input, or both.

Programmatic Use

Block Parameter: `Input`

Type: `character vector`

Values: `'Magnitude'` | `'Angle'` | `'Magnitude and angle'`

Default: `'Magnitude and angle'`

Angle — Phase angle of output

`0 (default)` | `real-valued scalar, vector, or matrix`

Constant phase angle of the output signal, in rad. To compute the CORDIC approximation, the input angle must be between:

- $[-2\pi, 2\pi)$ rad, for signed fixed-point types
- $[0, 2\pi)$ rad, for unsigned fixed-point types

For more information, see “Effect of Out-of-Range Input on CORDIC Approximations” on page 1-1032.

Dependencies

To enable this parameter, set **Input** to **Magnitude**.

Programmatic Use

Block Parameter: `ConstantPart`

Type: `character vector`

Values: constant scalar

Default: '0'

Magnitude — Magnitude of output

0 (default) | real-valued scalar, vector, or matrix

Constant magnitude of the output signal, specified as a real-valued scalar, vector, or matrix.

Dependencies

To enable this parameter, set **Input** to Angle.

Programmatic Use

Block Parameter: ConstantPart

Type: character vector

Values: real-valued scalar, vector, or matrix

Default: '0'

Approximation method — CORDIC or none

None (default) | CORDIC

Specify the type of approximation for computing output.

| Approximation Method | Data Types Supported | When to Use This Method |
|----------------------|--------------------------------|--|
| None (default) | Floating point | You want to use the default Taylor series algorithm. |
| CORDIC | Floating point and fixed point | You want a fast, approximate calculation. |

When you use the CORDIC approximation, follow these guidelines for the input angle:

- For signed fixed-point types, the input angle must fall within the range $[-2\pi, 2\pi]$ rad.
- For unsigned fixed-point types, the input angle must fall within the range $[0, 2\pi]$ rad.

The block uses the following data type propagation rules:

| Data Type of Magnitude Input | Approximation Method | Data Type of Complex Output |
|------------------------------|----------------------|---|
| Floating point | None or CORDIC | Same as input |
| Signed, fixed point | CORDIC | $\text{fixdt}(1, WL + 2, FL)$ where WL and FL are the word length and fraction length of the magnitude |
| Unsigned, fixed point | CORDIC | $\text{fixdt}(1, WL + 3, FL)$ where WL and FL are the word length and fraction length of the magnitude |

Programmatic Use

Block Parameter: ApproximationMethod

Type: character vector

Values: 'None' | 'CORDIC'

Default: 'None'

Number of iterations — Number of iterations for CORDIC algorithm

11 (default) | positive integer, less than or equal to word length of fixed-point input

Number of iterations to perform the CORDIC algorithm. The range of possible values depends on the data type of the input:

| Data Type of Block Inputs | Value You Can Specify |
|---------------------------|--|
| Floating point | A positive integer |
| Fixed point | A positive integer that does not exceed the word length of the magnitude input or the word length of the phase angle input, whichever value is smaller |

Dependencies

To enable this parameter, set **Approximation method** to CORDIC.

Programmatic Use

Block Parameter: NumberOfIterations

Type: character vector

Values: positive integer, less than or equal to word length of fixed-point input

Default: '11'

Scale output by reciprocal of gain factor — Scale real and imaginary parts of complex output

on (default) | off

Select this check box to scale the real and imaginary parts of the complex output by a factor of (1/CORDIC gain). This value depends on the number of iterations you specify. As the number of iterations goes up, the value approaches 1.647.

This check box is selected by default, which leads to a more numerically accurate result for the complex output, $X + iY$. However, scaling the output adds two extra multiplication operations, one for X and one for Y .

Dependencies

To enable this parameter, set **Approximation method** to CORDIC.

Programmatic Use

Block Parameter: ScaleReciprocalGainFactor

Type: character vector

Values: 'on' | 'off'

Default: 'on'

Sample time — Specify sample time as a value other than -1

-1 (default) | scalar | vector

Specify the sample time as a value other than -1. For more information, see “Specify Sample Time”.

Dependencies

This parameter is not visible unless it is explicitly set to a value other than -1. To learn more, see “Blocks for Which Sample Time Is Not Recommended”.

Programmatic Use**Block Parameter:** SampleTime**Type:** character vector**Values:** scalar or vector**Default:** '-1'**Block Characteristics**

| | |
|---------------------------------|-----------------|
| Data Types | double single |
| Direct Feedthrough | yes |
| Multidimensional Signals | yes |
| Variable-Size Signals | yes |
| Zero-Crossing Detection | no |

More About**CORDIC**

CORDIC is an acronym for COordinate Rotation DIgital Computer. The Givens rotation-based CORDIC algorithm is one of the most hardware-efficient algorithms available because it requires only iterative shift-add operations (see References). The CORDIC algorithm eliminates the need for explicit multipliers. Using CORDIC, you can calculate various functions such as sine, cosine, arc sine, arc cosine, arc tangent, and vector magnitude. You can also use this algorithm for divide, square root, hyperbolic, and logarithmic functions.

Increasing the number of CORDIC iterations can produce more accurate results, but doing so increases the expense of the computation and adds latency.

References

- [1] Volder, Jack E., "The CORDIC Trigonometric Computing Technique." *IRE Transactions on Electronic Computers* EC-8 (1959); 330-334.
- [2] Andraka, Ray "A Survey of CORDIC Algorithm for FPGA Based Computers." *Proceedings of the 1998 ACM/SIGDA Sixth International Symposium on Field Programmable Gate Arrays*. Feb. 22-24 (1998): 191-200.
- [3] Walther, J.S., "A Unified Algorithm for Elementary Functions," *Proceedings of the Spring Joint Computer Conference*, May 18-20, 1971: 379-386.
- [4] Schelin, Charles W., "Calculator Function Approximation," *The American Mathematical Monthly* 90, no. 5 (1983): 317-325.

Extended Capabilities**C/C++ Code Generation**

Generate C and C++ code using Simulink® Coder™.

HDL Code Generation

Generate Verilog and VHDL code for FPGA and ASIC designs using HDL Coder™.

HDL Coder provides additional configuration options that affect HDL implementation and synthesized logic.

HDL Architecture

This block has multi-cycle implementations that introduce additional latency in the generated code. To see the added latency, view the generated model or validation model. See “Generated Model and Validation Model” (HDL Coder).

For a block that has additional latency, the **Approximation method** is CORDIC. The number of additional cycles iterations is +1.

HDL Block Properties

| | |
|----------------------------------|--|
| ConstrainedOutputPipeline | Number of registers to place at the outputs by moving existing delays within your design. Distributed pipelining does not redistribute these registers. The default is 0. For more details, see “ConstrainedOutputPipeline” (HDL Coder). |
| InputPipeline | Number of input pipeline stages to insert in the generated code. Distributed pipelining and constrained output pipelining can move these registers. The default is 0. For more details, see “InputPipeline” (HDL Coder). |
| OutputPipeline | Number of output pipeline stages to insert in the generated code. Distributed pipelining and constrained output pipelining can move these registers. The default is 0. For more details, see “OutputPipeline” (HDL Coder). |

Restrictions

The Magnitude-Angle to Complex block supports only the HDL code generation for a floating-point data type. Fixed-point data types are supported only when you set **Approximation method** to CORDIC.

Fixed-Point Conversion

Design and simulate fixed-point systems using Fixed-Point Designer™.

The Magnitude-Angle to Complex block supports fixed-point and base integer data types when you set **Approximation method** to CORDIC.

See Also

Complex to Magnitude-Angle | Complex to Real-Imag | Real-Imag to Complex

Topics

“Complex Signals”

Introduced before R2006a

Manual Switch

Switch between two inputs

Library: Simulink / Signal Routing



Description

The Manual Switch block is a toggle switch that selects one of its two inputs to pass through to the output. To toggle between inputs, double-click the block. You control the signal flow by setting the switch before you start the simulation or by changing the switch while the simulation is executing. The Manual Switch block retains its current state when you save the model.

To programmatically toggle the switch, set the `set_param sw` property to '0' or '1'. For example, to connect the second input to the output:

```
set_param(gcb, 'sw', '0')
```

To connect the first input to the output:

```
set_param(gcb, 'sw', '1')
```

Note Double-clicking the Manual Switch block does not open the block dialog box. Instead, it toggles the input choice.

Ports

Input

Port_1 — First input signal

scalar | vector

First of two inputs to the Manual Switch block. The block propagates the selected input to the output. To select the input signal, toggle the switch by double-clicking the block.

Data Types: single | double | half | int8 | int16 | int32 | int64 | uint8 | uint16 | uint32 | uint64 | Boolean | fixed point | enumerated | bus

Port_2 — Second input signal

scalar | vector

Second of two inputs to the Manual Switch block. The block propagates the selected input to the output. To select the input signal, toggle the switch by double-clicking the block.

Data Types: single | double | half | int8 | int16 | int32 | int64 | uint8 | uint16 | uint32 | uint64 | Boolean | fixed point | enumerated | bus

Output

Port_1 — Output signal

scalar | vector

Output signal propagated from either the first or second input signal.

Data Types: single | double | half | int8 | int16 | int32 | int64 | uint8 | uint16 | uint32 | uint64 | Boolean | fixed point | enumerated | bus

Parameters

To view the block parameters, right-click the block and select **Block Parameters (ManualSwitch)**.

Allow the two inputs to differ in size (Results in variable-size output signal) — Allow inputs of different sizes

off (default) | on

Select this check box to allow inputs with different sizes and propagate the selected input signal size to the output signal. If you clear the box, the block expands scalar inputs to have the same dimensions as nonscalar inputs. See “Scalar Expansion of Inputs and Parameters”.

Programmatic Use

Parameter: varsize

Type: character vector

Value: 'on' | 'off'

Default: 'off'

Sample time — Specify sample time as a value other than -1

-1 (default) | scalar | vector

Specify the sample time as a value other than -1. For more information, see “Specify Sample Time”.

Dependencies

This parameter is not visible unless it is explicitly set to a value other than -1. To learn more, see “Blocks for Which Sample Time Is Not Recommended”.

Programmatic Use

Block Parameter: SampleTime

Type: character vector

Values: scalar or vector

Default: '-1'

Block Characteristics

| | |
|---------------------------------|--|
| Data Types | Boolean bus double enumerated fixed point half integer single string |
| Direct Feedthrough | yes |
| Multidimensional Signals | yes |
| Variable-Size Signals | yes |

| | |
|--------------------------------|----|
| Zero-Crossing Detection | no |
|--------------------------------|----|

Extended Capabilities

C/C++ Code Generation

Generate C and C++ code using Simulink® Coder™.

Not recommended for production code.

Fixed-Point Conversion

Design and simulate fixed-point systems using Fixed-Point Designer™.

See Also

Switch | Multiport Switch | Manual Variant Source | Manual Variant Sink

Introduced before R2006a

Manual Variant Sink

Switch between multiple variant choices at output

Library: Simulink / Signal Routing

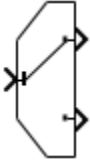

Description

The Manual Variant Sink block is a toggle switch that activates one of its variant choices at the output to pass the input.

The block can have two or more output ports and has one input port. Each output port is associated with a variant control. To change the number of output ports, right-click the block and select **Mask Parameters**, then type a value in the **Number of choices** box.

To toggle between the variant choices at output, double-click the block. The block displays the active choice with a line connecting the input to the output. The block propagates the active variant choice at output and discards the blocks connected to inactive output ports during simulation.

Note Double-clicking the Manual Variant Sink block does not open the block dialog box instead it toggles the output choice.

Ports

Input

Port_1 — Input signal

scalar | vector

Input signal passed to the active output port.

Data Types: single | double | half | int8 | int16 | int32 | int64 | uint8 | uint16 | uint32 | uint64 | Boolean | fixed point | enumerated | bus

Output

Port_1 — First variant output

scalar | vector

First variant output signal. The block passes the input signal to this output port when you connect the toggle switch to this port.

Data Types: single | double | half | int8 | int16 | int32 | int64 | uint8 | uint16 | uint32 | uint64 | Boolean | fixed point | enumerated | bus

Port_n — nth variant output

scalar | vector

nth variant output signal. The block passes the input signal to this output port when you connect the toggle switch to this port.

Data Types: `single` | `double` | `half` | `int8` | `int16` | `int32` | `int64` | `uint8` | `uint16` | `uint32` | `uint64` | `Boolean` | `fixed point` | `enumerated` | `bus`

Parameters

To access the block parameter, right-click the block and select **Mask > Mask Parameters**.

Number of choices — Number of output choices

2 (default) | scalar

Specify the number of variant output ports.

Programmatic Use

Block Parameter: NumChoices

Type: character vector

Value: integer

Default: '2'

Block Characteristics

| | |
|---------------------------------|--|
| Data Types | Boolean bus double enumerated fixed point half integer single string |
| Direct Feedthrough | no |
| Multidimensional Signals | no |
| Variable-Size Signals | no |
| Zero-Crossing Detection | no |

Extended Capabilities

C/C++ Code Generation

Generate C and C++ code using Simulink® Coder™.

Fixed-Point Conversion

Design and simulate fixed-point systems using Fixed-Point Designer™.

See Also

Variant Sink | Variant Source | Manual Variant Source

Topics

“Introduction to Variant Controls”

“Define, Configure, and Activate Variant Choices in a Variant Subsystem Block”

“Working with Variant Choices”

“Variant Systems” (Embedded Coder)

“Represent Variant Source and Sink Blocks in Generated Code” (Embedded Coder)

“Variants Example Models”

Introduced in R2016b

Manual Variant Source

Switch between multiple variant choices at input

Library: Simulink / Signal Routing

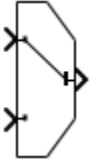

Description

The Manual Variant Source block is a toggle switch that activates one of its variant choices at the input to pass through to the output.

A Manual Variant Source block can have two or more input ports and has one output port. Each input port is associated with a variant control. To change the number of input ports, right-click the block and select **Mask Parameters**, then type a value in the **Number of choices** box.

To toggle between the variant choices at input, double-click the block. The block displays the active choice with a line connecting the input to the output. The block propagates the active variant choice at input directly to the output and discards the blocks connected to inactive input ports during simulation.

Note Double-clicking the Manual Variant Source block does not open the block dialog box instead it toggles the output choice.

Ports

Input

Port_1 — First variant input signal

scalar | vector

First variant input signal. The block passes this input signal to the output port when you connect the toggle switch to this port.

Data Types: single | double | half | int8 | int16 | int32 | int64 | uint8 | uint16 | uint32 | uint64 | Boolean | fixed point | enumerated | bus

Port_n — nth variant input signal

scalar | vector

nth variant input signal. The block passes this input signal to the output port when you connect the toggle switch to this port.

Data Types: single | double | half | int8 | int16 | int32 | int64 | uint8 | uint16 | uint32 | uint64 | Boolean | fixed point | enumerated | bus

Output

Port_1 — Output signal

scalar | vector

Output signal passed from the active variant input signal.

Data Types: single | double | half | int8 | int16 | int32 | int64 | uint8 | uint16 | uint32 | uint64 | Boolean | fixed point | enumerated | bus

Parameters

To access the block parameter, right-click the block and select **Mask > Mask Parameters**.

Number of choices — Number of input choices

2 (default) | scalar

Specify the number of variant input ports.

Programmatic Use

Block Parameter: NumChoices

Type: character vector

Value: integer

Default: '2'

Block Characteristics

| | |
|---------------------------------|--|
| Data Types | Boolean bus double enumerated fixed point half integer single string |
| Direct Feedthrough | no |
| Multidimensional Signals | no |
| Variable-Size Signals | no |
| Zero-Crossing Detection | no |

Extended Capabilities

C/C++ Code Generation

Generate C and C++ code using Simulink® Coder™.

Fixed-Point Conversion

Design and simulate fixed-point systems using Fixed-Point Designer™.

See Also

Variant Source | Variant Sink | Manual Variant Source and Sink Blocks

Topics

“Introduction to Variant Controls”

“Define, Configure, and Activate Variant Choices in a Variant Subsystem Block”

“Working with Variant Choices”

“Variant Systems” (Embedded Coder)

“Represent Variant Source and Sink Blocks in Generated Code” (Embedded Coder)

“Variants Example Models”

Introduced in R2016b

Math Function

Perform mathematical function

Library: Simulink / Math Operations
HDL Coder / Math Operations



Description

The Math Function block performs many common mathematical functions.

Tip To perform square root calculations, use the Sqrt block.

You can select one of these functions from the **Function** parameter list.

| Function | Description | Mathematical Expression | MATLAB Equivalent |
|---------------------------------------|----------------------------|--|--|
| exp | Exponential | e^u | exp |
| log | Natural logarithm | $\ln u$ | log |
| 10^u | Power of base 10 | 10^u | 10.^u (see power) |
| log10 | Common (base 10) logarithm | $\log u$ | log10 |
| magnitude^2 | Complex modulus | $ u ^2$ | real(u).^2 + imag(u).^2 (see real, imag, and power) |
| square | Power 2 | u^2 | u.^2 (see power) |
| pow | Power | $\text{sign}(u) * u ^v$ (default, applied only for even-order roots) or u^v | power |
| conj | Complex conjugate | \bar{u} | conj |
| reciprocal with Exact method | Reciprocal | $1/u$ | 1./u (see rdivide) |
| reciprocal with Newton-Raphson method | Reciprocal | See "Newton-Raphson Reciprocal Algorithm Method" on page 1-1050 | None |

| Function | Description | Mathematical Expression | MATLAB Equivalent |
|-----------|-----------------------------|-------------------------|--|
| hypot | Square root of sum squares | $(u^2+v^2)^{0.5}$ | hypot |
| rem | Remainder after division | — | rem |
| mod | Modulus after division | — | mod |
| transpose | Transpose | u^T | u.' (see "Array vs. Matrix Operations") |
| hermitian | Complex conjugate transpose | u^H | u' (see "Array vs. Matrix Operations") |

The block output is the result of the operation of the function on the input or inputs. The functions support these types of operations.

| Function | Scalar Operations | Element-Wise Vector and Matrix Operations | Vector and Matrix Operations |
|---------------------------------------|--------------------|--|------------------------------|
| exp | Yes | Yes | — |
| log | Yes | Yes | — |
| 10 ^u | Yes | Yes | — |
| log10 | Yes | Yes | — |
| magnitude ² | Yes | Yes | — |
| square | Yes | Yes | — |
| pow | Yes | Yes | — |
| conj | Yes | Yes | — |
| reciprocal with Exact method | Yes | Yes | — |
| reciprocal with Newton-Raphson method | Yes | Yes | — |
| hypot | Yes, on two inputs | Yes, on two inputs (two vectors or two matrices of the same size, a scalar and a vector, or a scalar and a matrix) | — |
| rem | Yes, on two inputs | Yes, on two inputs (two vectors or two matrices of the same size, a scalar and a vector, or a scalar and a matrix) | — |
| mod | Yes, on two inputs | Yes, on two inputs (two vectors or two matrices of the same size, a scalar and a vector, or a scalar and a matrix) | — |

| Function | Scalar Operations | Element-Wise Vector and Matrix Operations | Vector and Matrix Operations |
|-----------|-------------------|---|------------------------------|
| transpose | Yes | — | Yes |
| hermitian | Yes | — | Yes |

The name of the function appears on the block. The appropriate number of input ports appears automatically.

Tip Use the Math Function block when you want vector or matrix output.

Newton-Raphson Reciprocal Algorithm Method

The `reciprocal` function with the Newton-Raphson algorithm method calculates the reciprocal with Newton-Raphson approximation method. The function uses recursive approximation to find better approximations to the roots of a real-valued function.

The reciprocal of a real number a is defined as a zero of the function:

$$f(x) = \frac{1}{x} - a$$

Simulink chooses an initial estimate in the range $0 < x_0 < \frac{2}{a}$, as this is the domain of convergence for the function.

To successively compute the roots of the function, specify the **Number of iterations** parameter. The process is repeated as follows:

$$x_{i+1} = x_i - \frac{f(x_i)}{f'(x_i)} = x_i + (x_i - ax_i^2) = x_i \cdot (2 - ax_i)$$

$f'(x)$ is the derivative of the function $f(x)$.

Data Type Support

This table shows the input data types that each function of the block can support.

| Function | Single | Double | Half* | Boolean | Built-in integer | Fixed point |
|------------------------|--------|--------|-------|---------|------------------|-------------|
| exp | Yes | Yes | Yes | — | — | — |
| log | Yes | Yes | Yes | — | — | — |
| 10 ^u | Yes | Yes | Yes | — | — | — |
| log10 | Yes | Yes | Yes | — | — | — |
| magnitude ² | Yes | Yes | Yes | — | Yes | Yes |
| square | Yes | Yes | Yes | — | Yes | Yes |
| pow | Yes | Yes | Yes | — | — | — |
| conj | Yes | Yes | Yes | — | Yes | Yes |

| Function | Single | Double | Half* | Boolean | Built-in integer | Fixed point |
|---|--------|--------|-------|---------|------------------|-------------|
| reciprocal with Exact method | Yes | Yes | Yes | — | Yes | Yes |
| reciprocal with Newton-Raphson method (for more information, see “Output” on page 1-1052) | Yes | Yes | — | — | Yes | Yes |
| hypot | Yes | Yes | Yes | — | — | — |
| rem | Yes | Yes | Yes | — | Yes | — |
| mod | Yes | Yes | Yes | — | Yes | — |
| transpose | Yes | Yes | Yes | Yes | Yes | Yes |
| hermitian | Yes | Yes | Yes | — | Yes | Yes |

For more information on half-precision arithmetic operations, see “The Half-Precision Data Type in Simulink” (Fixed-Point Designer).

Ports

Input

Port_1 — Input signal

scalar | vector | matrix

Input signal specified as a scalar, vector, or matrix. All supported modes accept both real and complex inputs, except for `reciprocal`, which does not accept complex fixed-point inputs. See Description on page 1-1048 for more information.

Dependencies

Data type support for this block depends on the **Function** you select and the size of the input(s). For more information, see “Data Type Support” on page 1-1050.

Data Types: `half` | `single` | `double` | `int8` | `int16` | `int32` | `int64` | `uint8` | `uint16` | `uint32` | `uint64` | `Boolean` | `fixed point`

Port_2 — Input signal

scalar | vector | matrix

Input signal specified as a scalar, vector, or matrix. All supported modes accept both real and complex inputs, except for `reciprocal`, which does not accept complex fixed-point inputs.

Dependencies

To enable this port, set **Function** to `hypot`, `rem`, or `mod`.

Data type support for this block depends on the **Function** you select, and the size of the input(s). For more information, see “Data Type Support” on page 1-1050.

Data Types: half | single | double | int8 | int16 | int32 | int64 | uint8 | uint16 | uint32 | uint64 | Boolean | fixed point

Output

Port_1 — Result of the operation of the function on the input or inputs

scalar | vector | matrix

Output signal specified as a scalar, vector, or matrix. The dimensions of the block output depend on the **Function** you select and the size of the inputs. The block output is real or complex, depending on what you select for **Output signal type**. See Description on page 1-1048 for more information.

reciprocal with Newton-Raphson Method

The reciprocal with Newton-Raphson method output data type depends on the input data type:

| Input data type | Output data type |
|--|--|
| single | single |
| double | double |
| built-in integer | built-in integer |
| built-in fixed-point | built-in fixed-point |
| <code>fi (value, 0, word_length, fraction_length)</code> | <code>fi (value, 0, word_length, word_length-fraction_length-1)</code> |
| <code>fi (value, 1, word_length, fraction_length)</code> | <code>fi (value, 1, word_length, word_length-fraction_length-2)</code> |

Data Types: half | single | double | int8 | int16 | int32 | int64 | uint8 | uint16 | uint32 | uint64 | Boolean | fixed point

Parameters

Main

Function — Math function

exp (default) | log | 10^u | log10 | magnitude² | square | pow | conj | reciprocal | hypot | rem | mod | transpose | hermitian

Specify the mathematical function. See Description on page 1-1048 for more information about the options for this parameter.

Dependency

Setting **Function** to pow enables the **Signed power** parameter.

Programmatic Use

Block Parameter: Operator

Type: character vector

Values: 'exp' | 'log' | '10^u' | 'log10' | 'magnitude²' | 'square' | 'pow' | 'conj' | 'reciprocal' | 'hypot' | 'rem' | 'mod' | 'transpose' | 'hermitian'

Default: 'exp'

Algorithm method — Algorithm method for reciprocal function

Exact (default) | Newton-Raphson

Algorithm method for reciprocal function, specified as Exact or Newton-Raphson. To calculate reciprocal with the Newton-Raphson approximation method, select Newton-Raphson. Otherwise, select Exact.

Dependency

Setting **Function** to reciprocal enables this parameter.

Programmatic Use

Block Parameter: AlgorithmType

Type: character vector

Values: 'Exact' | 'Newton-Raphson'

Default: 'Exact'

Signed power — Power signedness

on (default) | off

Take into account sign of the input signal when calculating power, specified as on or off. This parameter applies only for even-order roots, such as $u^{1/2}$, $u^{1/4}$, and so forth.

- on — Calculate power of the absolute value of the input, multiplied by the sign of the input.
- off — Calculate power of the actual input value. If the first input is negative and the second input is an even-order root, return nan.

Dependency

Setting **Function** to pow enables this parameter.

Programmatic Use

Block Parameter: SignedPower

Type: character vector

Values: 'on' | 'off' |

Default: 'on'

Output signal type — Complexity of output signal

auto (default) | real | complex

Specify the output signal type of the Math Function block as auto, real, or complex.

| Function | Input Signal Type | Output Signal Type | | |
|--|-------------------|--------------------|-------|---------|
| | | Auto | Real | Complex |
| exp, log, 10u, log10, square, pow, reciprocal, conjugate, transpose, hermitian | real | real | real | complex |
| | complex | complex | error | complex |

| Function | Input Signal Type | Output Signal Type | | |
|-------------------|-------------------|--------------------|-------|---------|
| | | Auto | Real | Complex |
| magnitude squared | real | real | real | complex |
| | complex | real | real | complex |
| hypot, rem, mod | real | real | real | complex |
| | complex | error | error | error |

Programmatic Use**Block Parameter:** OutputSignalType**Type:** character vector**Values:** 'auto' | 'real' | 'complex'**Default:** 'auto'**Number of iterations — Number of Newton-Raphson iterations**

3 (default) | scalar

Number of Newton-Raphson iterations, specified as a scalar.

Dependencies

To enable this parameter, set:

- **Function** to reciprocal.
- **Algorithm method** to Newton-Raphson.

Programmatic Use**Block Parameter:** Iterations**Type:** character vector**Values:** '3' | scalar**Default:** '3'**Sample time — Specify sample time as a value other than -1**

-1 (default) | scalar | vector

Specify the sample time as a value other than -1. For more information, see “Specify Sample Time”.

Dependencies

This parameter is not visible unless it is explicitly set to a value other than -1. To learn more, see “Blocks for Which Sample Time Is Not Recommended”.

Programmatic Use**Block Parameter:** SampleTime**Type:** character vector**Values:** scalar or vector**Default:** '-1'**Signal Attributes****Output minimum — Minimum output value for range checking**

[] (default) | scalar

Lower value of the output range that Simulink checks.

Simulink uses the minimum to perform:

- Parameter range checking (see “Specify Minimum and Maximum Values for Block Parameters”) for some blocks.
- Simulation range checking (see “Specify Signal Ranges” and “Enable Simulation Range Checking”).
- Automatic scaling of fixed-point data types.
- Optimization of the code that you generate from the model. This optimization can remove algorithmic code and affect the results of some simulation modes such as SIL or external mode. For more information, see “Optimize using the specified minimum and maximum values” (Embedded Coder).

Note Output minimum does not saturate or clip the actual output signal. Use the Saturation block instead.

Programmatic Use

Block Parameter: OutMin

Type: character vector

Values: ' [] ' | scalar

Default: ' [] '

Output maximum — Maximum output value for range checking

[] (default) | scalar

Upper value of the output range that Simulink checks.

Simulink uses the maximum value to perform:

- Parameter range checking (see “Specify Minimum and Maximum Values for Block Parameters”) for some blocks.
- Simulation range checking (see “Specify Signal Ranges” and “Enable Simulation Range Checking”).
- Automatic scaling of fixed-point data types.
- Optimization of the code that you generate from the model. This optimization can remove algorithmic code and affect the results of some simulation modes such as SIL or external mode. For more information, see “Optimize using the specified minimum and maximum values” (Embedded Coder).

Note Output maximum does not saturate or clip the actual output signal. Use the Saturation block instead.

Programmatic Use

Block Parameter: OutMax

Type: character vector

Values: ' [] ' | scalar

Default: ' [] '

Output data type — Specify the output data type

Inherit: Same as first input (default) | Inherit: Inherit via internal rule |

Inherit: Inherit via back propagation | double | single | half | int8 | uint8 | int16 |

```
uint16 | int32 | uint32 | int64 | uint64 | fixdt(1,16) | fixdt(1,16,0) |
fixdt(1,16,2^0,0) | <data type expression>
```

Specify the output data type. You can set it to:

- A rule that inherits a data type, for example, `Inherit: Inherit via back propagation`
- The name of a built-in data type, for example, `single`
- The name of a data type object, for example, a `Simulink.NumericType` object
- An expression that evaluates to a data type, for example, `fixdt(1,16,0)`

Click the **Show data type assistant** button  to display the **Data Type Assistant**, which helps you set the data type attributes. For more information, see “Specify Data Types Using Data Type Assistant”.

Dependencies

- To enable this parameter, set the **Function** to `magnitude^2`, `square`, or `reciprocal`.
- For the `magnitude^2` and `square`, when input is a floating-point data type smaller than single precision, the `Inherit: Inherit via internal rule` output data type depends on the setting of the “Inherit floating-point output type smaller than single precision” configuration parameter. Data types are smaller than single-precision when the number of bits needed to encode the data type is less than the 32 bits needed to encode the single precision data type. For example, `half` and `int16` are smaller than single precision.

Programmatic Use

Block Parameter: `OutDataTypeStr`

Type: character vector

Values: `'Inherit: Inherit via internal rule'` | `'Inherit: Same as first input'` | `'Inherit: Inherit via back propagation'` | `'double'` | `'single'` | `'half'` | `'int8'` | `'uint8'` | `'int16'` | `'uint16'` | `'int32'` | `'uint32'` | `'int64'` | `'uint64'` | `'fixdt(1,16)'` | `'fixdt(1,16,0)'` | `'fixdt(1,16,2^0,0)'` | `'<data type expression>'`

Default: `'Inherit: Same as first input'`

Lock output data type setting against changes by the fixed-point tools — Prevent fixed-point tools from overriding data types

`off` (default) | `on`

Select this parameter to prevent the fixed-point tools from overriding the **Output** data type you specify on the block. For more information, see “Use Lock Output Data Type Setting” (Fixed-Point Designer).

Dependencies

To enable this parameter, set the **Function** to `magnitude^2`, `square`, or `reciprocal`.

Programmatic Use

Block Parameter: `LockScale`

Type: character vector

Values: `'off'` | `'on'`

Default: `'off'`

Integer rounding mode — Rounding mode for fixed-point operations

`Floor` (default) | `Ceiling` | `Convergent` | `Nearest` | `Round` | `Simplest` | `Zero`

Rounding mode for fixed-point operations. For more information, see “Rounding” (Fixed-Point Designer).

Block parameters always round to the nearest representable value. To control the rounding of a block parameter, enter an expression using a MATLAB rounding function into the mask field.

Dependencies

To enable this parameter, set the **Function** to `magnitude^2`, `square`, or `reciprocal`.

Programmatic Use

Block Parameter: `RndMeth`

Type: character vector

Values: `'Ceiling'` | `'Convergent'` | `'Floor'` | `'Nearest'` | `'Round'` | `'Simplest'` | `'Zero'`

Default: `'Floor'`

Saturate on integer overflow — Choose the behavior when integer overflow occurs

`on (default)` | `boolean`

| Action | Reasons for Taking This Action | What Happens for Overflows | Example |
|-------------------------------|---|---|---|
| Select this check box. | Your model has possible overflow, and you want explicit saturation protection in the generated code. | Overflows saturate to either the minimum or maximum value that the data type can represent. | The maximum value that the <code>int8</code> (signed, 8-bit integer) data type can represent is 127. Any block operation result greater than this maximum value causes overflow of the 8-bit integer. With the check box selected, the block output saturates at 127. Similarly, the block output saturates at a minimum output value of -128. |
| Do not select this check box. | You want to optimize efficiency of your generated code. You want to avoid overspecifying how a block handles out-of-range signals. For more information, see “Troubleshoot Signal Range Errors”. | Overflows wrap to the appropriate value that is representable by the data type. | The maximum value that the <code>int8</code> (signed, 8-bit integer) data type can represent is 127. Any block operation result greater than this maximum value causes overflow of the 8-bit integer. With the check box cleared, the software interprets the overflow-causing value as <code>int8</code> , which can produce an unintended result. For example, a block result of 130 (binary 1000 0010) expressed as <code>int8</code> , is -126. |

When you select this check box, saturation applies to every internal operation on the block, not just the output or result. Usually, the code generation process can detect when overflow is not possible. In this case, the code generator does not produce saturation code.

Dependencies

To enable this parameter, set the **Function** to `magnitude^2`, `square`, `conj`, `reciprocal`, or `hermitian`.

Programmatic Use

Block Parameter: `SaturateOnIntegerOverflow`

Type: character vector

Value: `'off'` | `'on'`

Default: `'on'`

Block Characteristics

| | |
|---------------------------------|--|
| Data Types | Boolean double fixed point half integer single |
| Direct Feedthrough | yes |
| Multidimensional Signals | yes |
| Variable-Size Signals | yes |
| Zero-Crossing Detection | no |

Extended Capabilities

C/C++ Code Generation

Generate C and C++ code using Simulink® Coder™.

HDL Code Generation

Generate Verilog and VHDL code for FPGA and ASIC designs using HDL Coder™.

HDL Coder provides additional configuration options that affect HDL implementation and synthesized logic.

HDL Architecture

You can generate HDL code for the `Math` architecture of the block for single-precision data types in native floating-point mode.

| Architecture | Description |
|------------------|--|
| ComplexConjugate | Compute complex conjugate. |
| Hermitian | Compute hermitian. |
| Transpose | Compute array transpose. See <code>Math Function</code> in the Simulink documentation. |

Reciprocal Architecture

You can generate HDL code for single-precision floating-point data types in native floating-point mode using Math architecture. HDL code generation also supports these architectures for reciprocal function in Math Function block:

| Architecture | Parameters | Additional Cycles of Latency | Description |
|-------------------------------------|------------|--|--|
| Reciprocal | None | 0 | Compute reciprocal as $1/N$, using the HDL divide (/) operator to implement the division. |
| ReciprocalRsqrBasedNewton | Iterations | Signed input: Iterations + 5 Unsigned input: Iterations + 3 | Use the iterative Newton method. Select this option to optimize area. The default value for Iterations is 3. The recommended value for Iterations is from 2 through 10. If Iterations is outside the recommended range, HDL Coder generates a message. |
| ReciprocalRsqrBasedNewtonSingleRate | Iterations | Signed input: (Iterations * 4) + 8 Unsigned input: (Iterations * 4) + 6 | Use the single rate pipelined Newton method. Select this option to optimize speed, or if you want a single rate implementation. The default value for Iterations is 3. The recommended value for Iterations is from 2 through 10. If Iterations is outside the recommended range, the coder generates a message. |

You can select these options in HDL Block properties of this block when the algorithm method is set to Exact.

This block has multi-cycle implementations that introduce additional latency in the generated code. To see the added latency, view the generated model or validation model. See “Generated Model and Validation Model” (HDL Coder).

HDL code generation also supports the Newton-Raphson algorithm method for reciprocal function. Select the **Algorithm method** as Newton-Raphson to use these architectures for reciprocal function in the Math Function block.

| Architecture | Additional Cycles of Latency | Description |
|----------------------------|------------------------------|--|
| ReciprocalNewton (default) | Iterations + 1 | <p>Use the multirate implementation of the iterative Newton method. Select this option to optimize area for your design.</p> <p>The default value for <code>Iterations</code> is 3.</p> <p>The recommended value for <code>Iterations</code> is from 2 through 10. If <code>Iterations</code> value is outside the recommended range, HDL Coder displays a message.</p> |
| ReciprocalNewtonSingleRate | (Iterations * 2) + 1 | <p>Use the single rate pipelined Newton method. Select this option to optimize speed for your design, or if you want a single rate implementation.</p> <p>The default value for <code>Iterations</code> is 3.</p> <p>The recommended value for <code>Iterations</code> is between 2 and 10. If <code>Iterations</code> value is outside the recommended range, HDL Coder displays a message.</p> |

HDL Block Properties

| General | |
|----------------------------------|--|
| ConstrainedOutputPipeline | Number of registers to place at the outputs by moving existing delays within your design. Distributed pipelining does not redistribute these registers. The default is 0. For more details, see “ConstrainedOutputPipeline” (HDL Coder). |
| InputPipeline | Number of input pipeline stages to insert in the generated code. Distributed pipelining and constrained output pipelining can move these registers. The default is 0. For more details, see “InputPipeline” (HDL Coder). |
| OutputPipeline | Number of output pipeline stages to insert in the generated code. Distributed pipelining and constrained output pipelining can move these registers. The default is 0. For more details, see “OutputPipeline” (HDL Coder). |

| Native Floating Point | |
|-------------------------|--|
| CheckResetToZero | Use this property for the <code>mod</code> and <code>rem</code> functions of the Math Function block. If you have numbers <code>a</code> and <code>b</code> such that the quotient <code>a/b</code> is close to an integer, this setting treats <code>a</code> as an integral multiple of <code>b</code> , and <code>rem(a, b) = 0</code> . This result is numerically accurate and matches the simulation results. However, computing this result uses additional resources and increases the area footprint on the target FPGA device. For more information, see “CheckResetToZero” (HDL Coder). |
| HandleDenormals | Specify whether you want HDL Coder to insert additional logic to handle denormal numbers in your design. Denormal numbers are numbers that have magnitudes less than the smallest floating-point number that can be represented without leading zeros in the mantissa. The default is <code>inherit</code> . See also “HandleDenormals” (HDL Coder). |
| LatencyStrategy | Specify whether to map the blocks in your design to <code>inherit</code> , <code>Max</code> , <code>Min</code> , <code>Zero</code> , or <code>Custom</code> for the floating-point operator. The default is <code>inherit</code> . See also “LatencyStrategy” (HDL Coder). |
| NFPCustomLatency | To specify a value, set LatencyStrategy to <code>Custom</code> . HDL Coder adds latency equal to the value that you specify for the NFPCustomLatency setting. See also “NFPCustomLatency” (HDL Coder). |
| MaxIterations | Use this property for the <code>mod</code> and <code>rem</code> functions of the Math Function block. If you have numbers <code>a</code> and <code>b</code> that are significantly large integers, you can increase MaxIterations to match the simulation results. However, computing this result uses additional resources and increases the area footprint on the target FPGA device. For more information, see “MaxIterations” (HDL Coder). |

Data types Support

- HDL code generation supports fixed-point and floating-point data types for the `Magnitude^2` function. It supports single-precision and double-precision floating-point data types. You can use complex data types for the `Magnitude Square` block.
- HDL code generation supports double-precision floating-point data type for `Log` function.

Complex Data Support

The `conj`, `hermitian`, and `transpose` functions support complex data.

Restrictions

Function set to `Square` is not supported.

When you use a `reciprocal` implementation:

- Input must be scalar and must have integer or fixed-point (signed or unsigned) data type.
- The output must be scalar and have integer or fixed-point (signed or unsigned) data type.
- Only the `Zero` rounding mode is supported.
- The **Saturate on integer overflow** option on the block must be selected.

PLC Code Generation

Generate Structured Text code using Simulink® PLC Coder™.

Fixed-Point Conversion

Design and simulate fixed-point systems using Fixed-Point Designer™.

The Math Function block only supports fixed-point conversion in certain configurations. For more information, see the Block Support Table.

See Also

Sqrt, Signed Sqrt, Reciprocal Sqrt | Trigonometric Function

Topics

“hisl_0004: Usage of natural logarithm and base 10 logarithm operations”

Introduced before R2006a

MATLAB Function

Include MATLAB code in models that generate embeddable C code

Library: Simulink / User-Defined Functions
HDL Coder / User-Defined Functions



Description

With a MATLAB Function block, you can write a MATLAB function for use in a Simulink model. The MATLAB function executes for simulation and generates code for a Simulink Coder target. If you are new to Simulink and MATLAB products, see “Implementing MATLAB Functions Using Blocks” for an overview.

Double-clicking the MATLAB Function block opens the **MATLAB Function Block Editor**, where you write the MATLAB function. The example model `call_stats_block2` discussed in “Create Custom Functionality Using MATLAB Function Blocks” uses the following function in the **MATLAB Function Block Editor**:

```
function [mean,stdev] = stats(vals)

% Calculates a statistical mean and a standard
% deviation for the values in vals.

len = length(vals);
mean = avg(vals,len);
stdev = sqrt(sum(((vals-avg(vals,len)).^2))/len);
plot(vals,'-+');

function mean = avg(array,size)
mean = sum(array)/size;
```

The function specifies the input and output data in the function declaration statement as arguments and return values. The argument and return values of the preceding example function correspond to the inputs and outputs of the block in the `call_stats_block2` model.

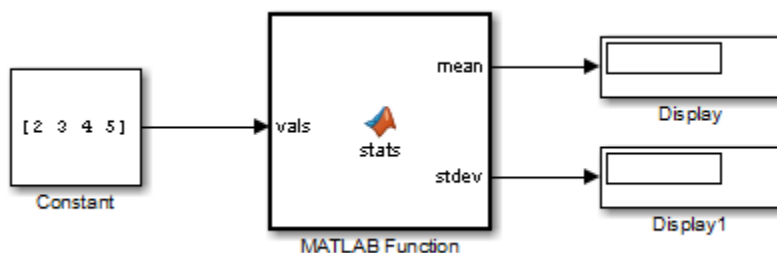

You can also define data, add an input trigger, and create function call outputs using the Model Explorer or the Ports and Data Manager. You can access the Ports and Data Manager in the **MATLAB**

Function Block Editor by clicking **Edit Data**. For more information, see “Define MATLAB Function Block Data”, “Manage the Input Trigger of a MATLAB Function Block”, and “Manage Function Call Outputs of a MATLAB Function Block”.

The MATLAB Function block generates efficient embeddable code based on an analysis that determines the size, class, and complexity of each variable. This analysis imposes the following restrictions:

- The first assignment to a variable defines its, size, class, and complexity.
See “Best Practices for Defining Variables for C/C++ Code Generation”.
- You cannot reassign variable properties after the initial assignment except when using variable-size data or reusing variables in the code for different purposes.

See “Reassignment of Variable Properties”.

In addition to language restrictions, the MATLAB Function block supports a subset of the functions available in MATLAB. These functions include functions in common categories, such as:

- Arithmetic operators like `plus`, `minus`, and `power`. For more information, see “Array vs. Matrix Operations”.
- Matrix operations like `size`, and `length`
- Advanced matrix operations like `lu`, `inv`, `svd`, and `chol`
- Trigonometric functions like `sin`, `cos`, `sinh`, and `cosh`

For more information, see “Functions and Objects Supported for C/C++ Code Generation”.

Note Although the code for this block attempts to produce exactly the same results as MATLAB, differences might occur due to rounding errors. These numerical differences, which might be a few `eps` initially, can magnify after repeated operations. Reliance on the behavior of `nan` is not recommended. Different C compilers can yield different results for the same computation.

Note New MATLAB Function blocks do not include the `%#codegen` directive, but check for errors as if it is included. Adding the `%#codegen` directive to a MATLAB Function block does not affect error checking. For more information see “Compilation Directive `%#codegen`”.

To support visualization of data, the MATLAB Function block supports calls to MATLAB functions for simulation only. See “Use MATLAB Engine to Execute a Function Call in Generated Code” to understand some of the limitations of this capability, and how it integrates with code analysis for this block. If these function calls do not directly affect any of the Simulink inputs or outputs, the calls do not appear in Simulink Coder generated code.

From MATLAB Function blocks, you can also call functions defined in a Simulink Function block. You can call Stateflow functions with **Export Chart Level Functions (Make Global)** and **Allow exported functions to be called by Simulink** checked in the chart Properties dialog box.

In the Ports and Data Manager, you can declare a block input to be a Simulink parameter instead of a port. The MATLAB Function block also supports inheritance of types and size for inputs, outputs, and parameters. You can also specify these properties explicitly. See “Define and Modify Function Argument Types”, “Specify Size of MATLAB Function Block Data”, and “Configure MATLAB Function

Block Parameter Data Arguments” for descriptions of variables that you use in MATLAB Function blocks.

Recursive calls are not allowed in MATLAB Function blocks.

By default, MATLAB Function blocks have direct feedthrough enabled. To disable it, clear the **Allow direct feedthrough** property. Nondirect feedthrough semantics ensure that outputs rely only on the current state. Using nondirect feedthrough enables you to use MATLAB Function blocks in a feedback loop and prevent algebraic loops. For more information, see “Use Nondirect Feedthrough in a MATLAB Function Block”.

Ports

Input

u — Input argument u

scalar | vector | matrix

Input corresponding to the first input argument of the function inside the MATLAB Function block. If you rename the function argument in the editor, the block renames the port correspondingly.

Data types supported by MATLAB but not supported by Simulink may not be passed between the Simulink model and the function within the MATLAB Function block. These types may be used within the MATLAB Function block.

For more information on fixed-point support for this block, refer to “Fixed-Point Data Types with MATLAB Function Block” (Fixed-Point Designer) and “MATLAB Function Block with Data Type Override” (Fixed-Point Designer).

Data Types: single | double | int8 | int16 | int32 | int64 | uint8 | uint16 | uint32 | uint64 | Boolean | string | fixed point | enumerated | bus

n — Input argument n

scalar | vector | matrix

nth input argument to the function in the MATLAB Function block. When you add the argument in the editor, the block adds the port correspondingly.

Data types supported by MATLAB but not supported by Simulink may not be passed between the Simulink model and the function within the MATLAB Function block. These types may be used within the MATLAB Function block.

For more information on fixed-point support for this block, refer to “Fixed-Point Data Types with MATLAB Function Block” (Fixed-Point Designer) and “MATLAB Function Block with Data Type Override” (Fixed-Point Designer).

Data Types: single | double | int8 | int16 | int32 | int64 | uint8 | uint16 | uint32 | uint64 | Boolean | string | fixed point | enumerated | bus

Output

y — Output argument

scalar | vector | matrix

First output argument of the function inside the MATLAB Function block. If you rename the function argument in the editor, the block renames the port correspondingly.

Data Types: `single` | `double` | `int8` | `int16` | `int32` | `int64` | `uint8` | `uint16` | `uint32` | `uint64` | `Boolean` | `string` | `fixed point` | `enumerated` | `bus`

n – Output argument n

`scalar` | `vector` | `matrix`

Nth output argument from the function inside the MATLAB Function block. When you add the argument in the editor, the block adds the port correspondingly.

Data Types: `single` | `double` | `int8` | `int16` | `int32` | `int64` | `uint8` | `uint16` | `uint32` | `uint64` | `Boolean` | `string` | `fixed point` | `enumerated` | `bus`

Parameters

Parameters in the **Code Generation** tab require Simulink Coder or Embedded Coder.

Main

Show port labels – Display options for port labels

`FromPortIcon` (default) | `FromPortBlockName` | `SignalName`

Select how to display port labels on the MATLAB Function block icon.

`none`

Do not display port labels.

`FromPortIcon`

Display the name of the function input and output arguments.

`FromPortBlockName`

Display the name of the function input and output arguments.

`SignalName`

If the signal connected to the port is named, display the signal name. Otherwise, display the name of the function argument.

Programmatic Use

Parameter: `ShowPortLabels`

Type: character vector

Value: `'FromPortIcon'` | `'FromPortBlockName'` | `'SignalName'`

Default: `'FromPortIcon'`

Read/Write permissions – Levels of access to contents of block

`ReadWrite` (default) | `ReadOnly` | `NoReadOrWrite`

Control user access to the contents of the MATLAB Function block.

`ReadWrite`

Enable opening and modification of MATLAB Function block contents.

`ReadOnly`

Enable opening but not modification of the MATLAB Function block.

NoReadOrWrite

Disable opening or modification of the MATLAB Function block.

Note You do not receive a response if you attempt to view the contents of a MATLAB Function block whose **Read/Write permissions** parameter is set to **NoReadOrWrite**. For example, when double-clicking such a MATLAB Function block, Simulink does not open the function code and does not display any messages.

Programmatic Use

Parameter: Permissions

Type: character vector

Value: 'ReadWrite' | 'ReadOnly' | 'NoReadOrWrite'

Default: 'ReadWrite'

Treat as atomic unit — Option to execute block as one unit

on (default) | off

Causes Simulink to treat the MATLAB Function block as a unit when determining the execution order of block methods.

on

Treat the MATLAB Function block as a unit when determining the execution order of block methods. For example, when Simulink needs to compute the output of the block, Simulink invokes the output methods of all the code in the MATLAB Function block before invoking the output methods of other blocks at the same level as the MATLAB Function block.

off

Treat all code in the MATLAB Function block as being at the same level in the model hierarchy as the MATLAB function when determining block method execution order. This hierarchy treatment can cause the execution of methods of code in the block to be interleaved with the execution of methods of blocks outside the chart.

Programmatic Use

Parameter: TreatAsAtomicUnit

Type: character vector

Value: 'on' | 'off'

Default: 'on'

Minimize algebraic loop occurrences — Option to eliminate artificial algebraic loops

off (default) | on

Try to eliminate any artificial algebraic loops that include the atomic unit.

off

Do not try to eliminate any artificial algebraic loops that include the atomic unit.

on

Try to eliminate any artificial algebraic loops that include the atomic unit.

Dependencies

To enable this parameter, select the **Treat as atomic unit** parameter.

Programmatic Use

Parameter: MinAlgLoopOccurrences

Type: character vector

Value: 'off' | 'on'

Default: 'off'

Schedule as — Type of scheduling

Sample Time (default) | Periodic Partition | Aperiodic Partition

Specify how to schedule the MATLAB Function block.

Sample time

Specify whether all code in the MATLAB Function block must run at the same rate or can run at different rates.

Periodic Partition

Schedule the MATLAB Function block code with a periodic partition. Specify a partition name and a sample time corresponding to the rate at which the partition runs.

Aperiodic Partition

Schedule the MATLAB Function block code with an aperiodic partition. Specify a partition name.

Dependencies

To enable this parameter, select the **Treat as atomic unit** parameter.

Programmatic Use

Parameter: ScheduleAs

Type: character vector

Value: 'SampleTime' | 'DiscretePartition' | 'UnconstrainedPartition'

Default: 'SampleTime'

Sample time — Specify time interval

-1 (default) | [Ts 0]

Specify whether all code in this block must run at the same rate or can run at different rates.

- If code in the MATLAB Function block can run at different rates, specify the sample time as inherited (-1).
- If all code must run at the same rate, specify the sample time corresponding to this rate as the value of the **Sample time** parameter.

-1

Specify inherited sample time. Use this sample time if the code in the MATLAB Function can run at different rates.

[Ts 0]

Specify periodic sample time.

Dependencies

To enable this parameter, select the **Treat as atomic unit** parameter.

Programmatic Use**Parameter:** SystemSampleTime**Type:** character vector**Value:** '-1' | '[Ts 0]'**Default:** '-1'**Code Generation****Function packaging — Code format**

Auto (default) | Inline | Nonreusable function | Reusable function

Select the code format to be generated for an atomic (nonvirtual) unit.

Auto

Simulink Coder and Embedded Coder choose the optimal format for you based on the type and number of instances of the MATLAB Function block that exist in the model.

Inline

Simulink Coder and Embedded Coder inline the MATLAB Function block unconditionally.

Nonreusable function

If **Filename options** is set to Auto, Simulink Coder and Embedded Coder package separate functions in the model file. If **File name options** is set to Use subsystem name, Use function name, or User specified using different file names, Simulink Coder and Embedded Coder package separate functions in separate files.

MATLAB Function blocks with this setting generate functions that might have arguments depending on the “Function interface” on page 1-0 parameter setting. You can name the generated function and file using parameters “Function name” on page 1-0 and “File name (no extension)” on page 1-0. These functions are not reentrant.

Reusable function

Simulink Coder and Embedded Coder generate a function with arguments that allows reuse of block code when a model includes multiple instances of the block.

This option also generates a function with arguments that allows MATLAB Function block code to be reused in the generated code of a model reference hierarchy that includes multiple instances of a MATLAB Function block across referenced models. In this case, the block must be in a library.

For more information, see:

- “Control Generation of Functions for Subsystems” (Simulink Coder)
- “Generate Code and Executables for Individual Subsystems” (Simulink Coder)
- “Generate Subsystem Code as Separate Function and Files” (Simulink Coder)
- “Generate Reusable Code from Library Subsystems Shared Across Models” (Simulink Coder)

Tips

- When you want multiple instances of a MATLAB Function block to be represented as one reusable function, you can designate each one of them as Auto or as Reusable function. It is best to use one or the other, as using both creates two reusable functions, one for each designation. The outcomes of these choices differ only when reuse is not possible. Selecting Auto does not allow control of the function or file name for the MATLAB Function block code.

- The `Reusable` function and `Auto` options both try to determine if multiple instances of a MATLAB Function block exist and if the code can be reused. The difference between the options' behavior is that when reuse is not possible:
 - `Auto` yields inlined code, or if circumstances prohibit inlining, separate functions for each MATLAB Function block instance.
 - `Reusable` function yields a separate function with arguments for each MATLAB Function block instance in the model.
- If you select `Reusable` function while your generated code is under source control, set **File name options** to `Use subsystem name`, `Use function name`, or `User specified`. Otherwise, the names of your code files change whenever you modify your model, which prevents source control on your files.

Dependencies

- This parameter requires Simulink Coder for code generation.
- To enable this parameter, select **Treat as atomic unit**.

Programmatic Use

Parameter: `RTWSystemCode`

Type: character vector

Value: `'Auto'` | `'Inline'` | `'Nonreusable function'` | `'Reusable function'`

Default: `'Auto'`

Block Characteristics

| | |
|---------------------------------|---|
| Data Types | <code>Boolean^a</code> <code>bus^a</code> <code>double^a</code> <code>enumerated^a</code> <code>fixed point^a</code> <code>integer^a</code> <code>single^a</code> <code>string^a</code> |
| Direct Feedthrough | yes |
| Multidimensional Signals | limited ^a |
| Variable-Size Signals | limited ^a |
| Zero-Crossing Detection | no |

a. Actual data type or capability support depends on block implementation.

Extended Capabilities

C/C++ Code Generation

Generate C and C++ code using Simulink® Coder™.

Actual data type or capability support depends on block implementation.

HDL Code Generation

Generate Verilog and VHDL code for FPGA and ASIC designs using HDL Coder™.

HDL Coder provides additional configuration options that affect HDL implementation and synthesized logic. Actual data type or capability support depends on block implementation. For best practices of using the MATLAB Function block, see:

- “Design Guidelines for the MATLAB Function Block” (HDL Coder)
- “Generate Instantiable Code for Functions” (HDL Coder)
- “Optimize MATLAB Loops” (HDL Coder)
- “Pipeline MATLAB Expressions” (HDL Coder)

HDL Architecture

| | |
|---------------------------|--|
| MATLAB Function (Default) | This is the default architecture for MATLAB Function blocks with fixed-point data types. When you use this architecture, you can use speed and area optimizations for blocks that surround the MATLAB Function block. The code inside the MATLAB Function block is not optimized. |
| MATLAB Datapath | <p>This is the default architecture for MATLAB Function blocks with floating-point data types. When you use this architecture, the code generator treats the MATLAB Function block like a regular Subsystem block. By enabling this architecture for fixed-point types, you can use speed and area optimizations for blocks inside the MATLAB Function block and across the MATLAB Function block with other Simulink blocks.</p> <p>This capability enables you to specify additional properties for the MATLAB Function block that you would specify for a Subsystem such as ClockRatePipelining and FlattenHierarchy.</p> |

HDL Block Properties

| | |
|------------------------------------|---|
| AdaptivePipelining | Automatic pipeline insertion based on the synthesis tool, target frequency, and multiplier word-lengths. The default is <code>inherit</code> . To specify this property, set Architecture to MATLAB Datapath. See also “AdaptivePipelining” (HDL Coder). |
| BalanceDelays | Detects introduction of new delays along one path and inserts matching delays on the other paths. The default is <code>inherit</code> . To specify this property, set Architecture to MATLAB Datapath. See also “BalanceDelays” (HDL Coder). |
| ClockRatePipelining | Insert pipeline registers at a faster clock rate instead of the slower data rate. The default is <code>inherit</code> . To specify this property, set Architecture to MATLAB Datapath. See also “ClockRatePipelining” (HDL Coder). |
| ConstMultiplierOptimization | Canonical signed digit (CSD) or factored CSD optimization. The default is <code>none</code> . See also “ConstMultiplierOptimization” (HDL Coder). |
| ConstrainedOutputPipeline | Number of registers to place at the outputs by moving existing delays within your design. Distributed pipelining does not redistribute these registers. The default is <code>0</code> . For more details, see “ConstrainedOutputPipeline” (HDL Coder). |
| DistributedPipelining | Pipeline register distribution, or register retiming. The default is <code>off</code> . See also “DistributedPipelining” (HDL Coder). |
| DSPStyle | Synthesis attributes for multiplier mapping. The default is <code>none</code> . To specify this property, set Architecture to MATLAB Datapath. See also “DSPStyle” (HDL Coder). |

| | |
|-------------------------------|---|
| FlattenHierarchy | Remove MATLAB Function block hierarchy from generated HDL code. The default is <code>inherit</code> . To specify this property, set Architecture to <code>MATLAB Datapath</code> . See also “FlattenHierarchy” (HDL Coder). |
| InputPipeline | Number of input pipeline stages to insert in the generated code. Distributed pipelining and constrained output pipelining can move these registers. The default is 0. For more details, see “InputPipeline” (HDL Coder). |
| InstantiateFunctions | Generate a VHDL entity or Verilog module for each function. The default is <code>off</code> . See also “InstantiateFunctions” (HDL Coder). |
| LoopOptimization | Unroll, stream, or do not optimize loops. The default is <code>none</code> . If you set Architecture to <code>MATLAB Datapath</code> , you can only unroll loops. If you want to use loop streaming with the <code>MATLAB Datapath</code> architecture, you can use the streaming optimization by specifying a StreamingFactor . See also “LoopOptimization” (HDL Coder). |
| MapPersistentVarsToRAM | Map persistent arrays to RAM. The default is <code>off</code> . See also “MapPersistentVarsToRAM” (HDL Coder). |
| OutputPipeline | Number of output pipeline stages to insert in the generated code. Distributed pipelining and constrained output pipelining can move these registers. The default is 0. For more details, see “OutputPipeline” (HDL Coder). |
| ResetType | Suppress reset logic generation. The default is <code>default</code> , which generates reset logic. See also “ResetType” (HDL Coder). |
| SharingFactor | Number of functionally equivalent resources to map to a single shared resource. The default is 0. See also “Resource Sharing” (HDL Coder). |
| StreamingFactor | Number of parallel data paths, or vectors, that are time multiplexed to transform into serial, scalar data paths. The default is 0, which implements fully parallel data paths. To specify this property, set Architecture to <code>MATLAB Datapath</code> . See also “Streaming” (HDL Coder). |
| VariablesToPipeline | <p>Warning <code>VariablesToPipeline</code> is not recommended. Use <code>coder.hdl.pipeline</code> instead.</p> <p>Insert a pipeline register at the output of the specified variable or variables. Specify the list of variables as a character vector, with spaces separating the variables. To specify this property, set Architecture to <code>MATLAB Function</code>.</p> |

Data Type Support

HDL code generation supports half-precision data types for these functions in MATLAB Function block:

| | | | | | |
|--------------------|-------------------------|------------------------|----------------------|------------------------|-------------------------|
| <code>all</code> | <code>and, &</code> | <code>any</code> | <code>cast</code> | <code>conj</code> | <code>ctranspose</code> |
| <code>end</code> | <code>=</code> | <code>eq</code> | <code>==</code> | <code>ge, >=</code> | <code>gt, ></code> |
| <code>half</code> | <code>inf</code> | <code>int8</code> | <code>int16</code> | <code>int32</code> | <code>int64</code> |
| <code>isa</code> | <code>iscolumn</code> | <code>isempty</code> | <code>isequal</code> | <code>isfinite</code> | <code>isfloat</code> |
| <code>isinf</code> | <code>isinteger</code> | <code>islogical</code> | <code>isnan</code> | <code>isnumeric</code> | <code>isreal</code> |

| | | | | | |
|-----------|------------|----------|----------|---------|-----------|
| isrow | isscalar | isvector | le, <= | length | logical |
| lt, < | max | min | minus, - | NaN | ndims |
| ne, ~= | not | numel | or, | plus, + | prod |
| reshape | single | size | sqrt | sum | times, .* |
| transpose | uint8 | uint16 | uint32 | uint64 | uminus |
| uplus | vertconcat | - | - | - | - |

Complex Data Support

This block supports code generation for complex signals.

See also “Complex Data Type Support” (HDL Coder).

Tunable Parameter Support

HDL Coder supports both tunable and non-tunable parameters with the following data types:

- Scalar
- Vector
- Complex
- Structure
- Enumeration

For details, see “Generate DUT Ports for Tunable Parameters” (HDL Coder) and “Design Guidelines for the MATLAB Function Block” (HDL Coder)

Restrictions

- If the block contains a System object™, block inputs cannot have non-discrete (constant or Inf) sample time.
- HDL Coder does not support a MATLAB Function that contains the same variable as the input and output of the function. For example, this MATLAB code is not supported.

```
function y = myFun(y)
%#codegen

y = 3 * y;
```

For the MATLAB language subset supported for HDL code generation from a MATLAB Function block, see “Supported MATLAB Data Types, Operators, and Control Flow Statements” (HDL Coder).

PLC Code Generation

Generate Structured Text code using Simulink® PLC Coder™.

Fixed-Point Conversion

Design and simulate fixed-point systems using Fixed-Point Designer™.

Actual data type or capability support depends on block implementation.

See Also

Subsystem, Atomic Subsystem, Nonvirtual Subsystem, CodeReuse Subsystem

Topics

“Create Custom Functionality Using MATLAB Function Blocks”

“Implementing MATLAB Functions Using Blocks”

“MATLAB Function Block Capabilities”

“Specify MATLAB Function Block Properties”

“Declare Variable-Size Inputs and Outputs”

“Use Nondirect Feedthrough in a MATLAB Function Block”

Introduced in R2011a

MATLAB System

Include System object in model

Library: Simulink / User-Defined Functions
HDL Coder / User-Defined Functions



Description

The MATLAB System block brings existing System objects (based on `matlab.System`) into Simulink. It also enables you to use System object APIs to develop new blocks for Simulink. For more information on this block, see “MATLAB System Block”.

For interpreted execution, the model simulates the block using the MATLAB execution engine.

For code generation, the model simulates the block using code generation (using the subset of MATLAB code supported for code generation). The MATLAB System block supports only a subset of the functions available in MATLAB. See “Functions and Objects Supported for C/C++ Code Generation” for a complete list of functions. These functions include those in common categories, such as:

- “Array vs. Matrix Operations”, like `plus`, `minus`, and `power`
- Matrix operations, like `size` and `length`
- Advanced matrix operations, like `lu`, `inv`, `svd`, and `chol`
- Trigonometric functions, like `sin`, `cos`, `sinh`, and `cosh`

System Objects

To use the MATLAB System block, you must first have a new System object or use an existing one. For more information, see “Integrate System Objects Using MATLAB System Block”.

Ports

Input

In — Signal input to a MATLAB System block

scalar | vector | matrix

The MATLAB System block accepts inputs of the types listed in the Block Characteristics table. It does not support virtual buses as input or output. It does not support nonvirtual buses that contain variable-size signals. For more information, see “Data Types Supported by Simulink”.

For information on fixed-point support for this block, see “Code Acceleration and Code Generation from MATLAB” (Fixed-Point Designer).

The MATLAB System block supports Simulink frames. For more information, see “Sample- and Frame-Based Concepts” (DSP System Toolbox).

Data Types: `single` | `double` | `int8` | `int16` | `int32` | `int64` | `uint8` | `uint16` | `uint32` | `uint64` | `fixed point`

Output

Out — Signal output of a MATLAB System block

`scalar` | `vector` | `matrix`

Signal output of a MATLAB System block that the System object returns.

Data Types: `single` | `double` | `int8` | `int16` | `int32` | `int64` | `uint8` | `uint16` | `uint32` | `uint64` | `Boolean` | `fixed point` | `enumerated` | `bus`

Parameters

System Object Name — Name of the System object

`cell array` (default)

Specify the full name of the user-defined System object class without the file extension. This entry is case sensitive. The class name must exist on the MATLAB path.

You can specify a System object name in one of these ways:

- Enter the name in the text box.
- Click the list arrow attached to the text box. If valid System objects exist in the current folder, the names appear in the list. Select a System object from this list.
- Browse to a folder that contains a valid System object. If the folder is not on your MATLAB path, the software prompts you to add it.

If you need to create a System object, you can create one from a template by clicking **New**.

After you save the System object, the name appears in the **System object name** text box.

Use the full name of the user-defined System object class name. The block does not accept a MATLAB variable that you have assigned to a System object class name.

Programmatic Use

Block Parameter: `System`

Type: `character vector`

Value: `name of the System object`

Default: `' '`

New — Create a System object from a template

`Basic` (default) | `Advanced` | `Simulink Extension`

Select one of the options for a System object template.

Basic

Starts MATLAB Editor and displays a template for a simple System object using the fewest System object methods.

Advanced

Starts MATLAB Editor and displays a template for a more advanced System object using most of the System object methods.

Simulink Extension

Starts MATLAB Editor and displays a file that contains utilities for customizing the block for Simulink. This is the same file available in MATLAB when you select **New > System Object > Simulink Extension**.

After you save the System object, you can enter the name in the **System object name** text box.

Simulate using — Select the simulation mode

Code generation (default) | Interpreted Execution

Select the simulation mode.

Code generation

On the first model run, simulate and generate code for MATLAB System block using only MATLAB functions supported for code generation. If the structure of the block does not change, subsequent model runs do not regenerate the code.

If the simulation mode is Code generation, System Objects accept a maximum of 32 inputs.

Interpreted execution

Simulate model using all supported MATLAB functions. Choosing this option can slow simulation performance.

Dependency — Dependency parameter for MATLAB System block

auto (default)

After you assign a valid System object class name to the block, the next time you open the block dialog box, the parameter is visible. This parameter appears for every MATLAB System block. You cannot remove it.

- If the block has no tabs, this parameter appears at the bottom of the dialog box.
- If the block has multiple tabs, this parameter appears at the bottom of the first tab of the dialog box.

Saturate on integer overflow — Specify whether overflows saturate

Off (default) | On

On

Overflows saturate to either the minimum or maximum value that the data type can represent. For example, an overflow associated with a signed 8-bit integer can saturate to -128 or 127.

Off

Overflows wrap to the appropriate value that the data type can represent. For example, the number 130 does not fit in a signed 8-bit integer and wraps to -126.

Tips

- Consider selecting this check box when your model has a possible overflow and you want explicit saturation protection in the generated code.
- Consider clearing this check box when you want to optimize efficiency of your generated code. Clearing this check box also helps you to avoid overspecifying how a block handles out-of-range signals. For more information, see “Troubleshoot Signal Range Errors”.

- When you select this check box, saturation applies to every internal operation on the block, not just the output or result.
- In general, the code generation process can detect when overflow is not possible. In this case, the code generator does not produce saturation code.

Dependency

This check box appears when you use the `showFiSettingsImpl` method in the System object.

Programmatic Use

Block Parameter: SaturateOnIntegerOverflow

Type: character vector

Values: 'off' | 'on'

Default: 'off'

Treat these inherited Simulink signal types as fi objects — Specify fi data types

Fixed-point (default) | Fixed-point & Integer

Select which inherited data types to treat fi data types,

Fixed-point

Treat fixed-point data types as fi data types.

Fixed-point & Integer

Treat fixed-point and integer data types as fi data types.

Dependency

This check box appears when you use the `showFiSettingsImpl` method in the System object.

MATLAB System fimath — Specify fixed-point settings to use

Same as MATLAB (default) | Specify Other

Select which fixed-point math settings to use.

Same as MATLAB

Use the current MATLAB fixed-point math settings.

Specify Other

Enable the edit box for specifying the desired fixed-point math settings. For information on setting fixed-point math, see `fimath`.

Dependency

This check box appears when you use the `showFiSettingsImpl` method in the System object.

Block Characteristics

| | |
|---------------------------------|--|
| Data Types | Boolean ^a bus ^{ba} double ^a enumerated ^a fixed point ^a integer ^a single ^a |
| Direct Feedthrough | no |
| Multidimensional Signals | limited ^a |

| | |
|--------------------------------|-----------------------|
| Variable-Size Signals | limited ^{ca} |
| Zero-Crossing Detection | no |

- Actual data type or capability support depends on block implementation.
- See Nonvirtual Buses and MATLAB System Block for more information.
- See Variable-Size Signals for more information.

Extended Capabilities

C/C++ Code Generation

Generate C and C++ code using Simulink® Coder™.

Actual code generation support depends on block implementation.

HDL Code Generation

Generate Verilog and VHDL code for FPGA and ASIC designs using HDL Coder™.

HDL Coder provides additional configuration options that affect HDL implementation and synthesized logic.

You can define a System object and use it in a MATLAB System block for HDL code generation.

Tunable Parameter Support

HDL Coder supports tunable parameters with the following data types:

- Numeric
- Fixed point
- Character
- Logical

When using tunable parameters with the MATLAB System block, the tunable parameter should be a Simulink.Parameter object with the StorageClass set to ExportedGlobal.

```
x = Simulink.Parameter
x.Value = 1
x.CoderInfo.StorageClass = 'ExportedGlobal'
```

For details, see “Generate DUT Ports for Tunable Parameters” (HDL Coder).

HDL Architecture

This block has a single, default HDL architecture.

HDL Block Properties

If you use a predefined System object, the HDL block properties available are the same as the properties available for the corresponding block.

By default, the following HDL block properties are available.

| | |
|------------------------------------|---|
| ConstMultiplierOptimization | Canonical signed digit (CSD) or factored CSD optimization. The default is none. See also “ConstMultiplierOptimization” (HDL Coder). |
|------------------------------------|---|

| | |
|----------------------------------|--|
| ConstrainedOutputPipeline | Number of registers to place at the outputs by moving existing delays within your design. Distributed pipelining does not redistribute these registers. The default is 0. For more details, see “ConstrainedOutputPipeline” (HDL Coder). |
| DistributedPipelining | Pipeline register distribution, or register retiming. The default is off. See also “DistributedPipelining” (HDL Coder). |
| InputPipeline | Number of input pipeline stages to insert in the generated code. Distributed pipelining and constrained output pipelining can move these registers. The default is 0. For more details, see “InputPipeline” (HDL Coder). |
| LoopOptimization | Unroll, stream, or do not optimize loops. The default is none. See also “LoopOptimization” (HDL Coder). |
| MapPersistentVarsToRAM | Map persistent arrays to RAM. The default is off. See also “MapPersistentVarsToRAM” (HDL Coder). |
| OutputPipeline | Number of output pipeline stages to insert in the generated code. Distributed pipelining and constrained output pipelining can move these registers. The default is 0. For more details, see “OutputPipeline” (HDL Coder). |
| ResetType | Suppress reset logic generation. The default is default, which generates reset logic. See also “ResetType” (HDL Coder). |
| SharingFactor | Number of functionally equivalent resources to map to a single shared resource. The default is 0. See also “Resource Sharing” (HDL Coder). |
| VariablesToPipeline | <p>Warning VariablesToPipeline is not recommended. Use <code>coder.hdl.pipeline</code> instead.</p> <hr/> <p>Insert a pipeline register at the output of the specified MATLAB variable or variables. Specify the list of variables as a character vector, with spaces separating the variables.</p> |

Restrictions

- The DUT subsystem must be single-rate.
- Inputs cannot have non-discrete (constant or Inf) sample time.
- The following predefined System objects are supported for code generation when you use them in the MATLAB System block:
 - `hdl.RAM`
 - `comm.HDLCRCDetector`
 - `comm.HDLCRCGenerator`
 - `comm.HDLRSDecoder`
 - `comm.HDLRSEncoder`
 - `dsp.DCBlocker`
 - `dsp.HDLComplexToMagnitudeAngle`
 - `dsp.HDLFFT`
 - `dsp.HDLIFFT`

- `dsp.HDLNCO`
- If you use a user-defined System object, it must support HDL code generation. For information about user-defined System objects and requirements for HDL code generation, see “HDL Code Generation for System Objects” (HDL Coder).

See also “Generate Code for User-Defined System Objects” (HDL Coder) and “HDL Code Generation for System Objects” (HDL Coder).

Fixed-Point Conversion

Design and simulate fixed-point systems using Fixed-Point Designer™.

Actual data type support depends on block implementation.

See Also

MATLAB Function

Topics

“Using Buses with MATLAB System Blocks” on page 13-574

“Pulse Width Modulation Using MATLAB System Block” on page 13-624

“MATLAB System Block”

“What Are System Objects?”

Introduced in R2013b

Matrix Square

Compute square of input matrix

Library: Simulink / Matrix Operations
 DSP System Toolbox / Math Functions / Matrices and Linear
 Algebra / Matrix Operations



Description

The Matrix Square block computes the square of an M -by- N input matrix, u , by premultiplying with the Hermitian transpose. The equivalent MATLAB code is:

$$y = u' * u$$

The block treats length- M unoriented vector inputs as an M -by-1 matrix. When the input is an M -by- N matrix, the output of the block is an N -by- N matrix.

Applications

The Matrix Square block can be used in a variety of applications:

- General matrix squares — The Matrix Square block computes the output matrix, y , without explicitly forming u' . It is therefore more efficient than other methods for computing the matrix square.
- Sum of squares — When the input is a column vector ($N=1$), the operation of the block is equivalent to a multiply-accumulate (MAC) process, or inner product. The output is the sum of the squares of the input, and is always a real scalar.
- Correlation matrix — When the input is a row vector ($M=1$), the output, y , is the symmetric autocorrelation matrix, or outer product.

Ports

Input

Port_1 — Input matrix

M -by-1 matrix | 1-by- N matrix | M -by- N matrix

Input matrix, specified as an M -by-1, 1-by- N , or M -by- N matrix.

Data Types: single | double | half | int8 | int16 | int32 | int64 | uint8 | uint16 | uint32 | uint64 | fixed point

Output

Port_1 — Output matrix

M -by- M matrix | N -by- N matrix

Output matrix, returned as an N -by- N or M -by- M matrix.

Data Types: `single` | `double` | `half` | `int8` | `int16` | `int32` | `int64` | `uint8` | `uint16` | `uint32` | `uint64` | `fixed point`

Parameters

Output minimum — Minimum output value for range checking

`[]` (default) | scalar

Minimum output value for range checking that Simulink checks. Simulink software uses this value to perform:

- Simulation range checking (see “Specify Signal Ranges”)
- Automatic scaling of fixed-point data types

Programmatic Use

Block Parameter: `OutMin`

Type: character vector

Values: `'[]'` | scalar

Default: `'[]'`

Output maximum — Maximum output value for range checking

`[]` (default) | scalar

Maximum output value for range checking that Simulink checks. Simulink software uses this value to perform:

- Simulation range checking (see “Specify Signal Ranges”)
- Automatic scaling of fixed-point data types

Programmatic Use

Block Parameter: `OutMax`

Type: character vector

Values: `'[]'` | scalar

Default: `'[]'`

Output data type — Output data type

`Inherit: Inherit via internal rule`(default) | `Inherit: Inherit via back propagation` | `Inherit: Same as input` | `double` | `single` | `int8` | `uint8` | `int16` | `uint16` | `int32` | `uint32` | `fixdt(1,16,0)` | `<data type expression>`

Specify the output data type for this block.

You can select one of these options:

- A rule that specifies how to inherit a data type, such as `Inherit: Inherit via internal rule`. For more information on this rule, see “Inherit via Internal Rule” (DSP System Toolbox).
- An expression that evaluates to a valid data type, for example, `fixdt([],16,0)`

Click the **Show data type assistant** button  to display the **Data Type Assistant**, which helps you set the **Output data type** parameter. For more information, see “Specify Data Types Using Data Type Assistant”.

Programmatic Use**Block Parameter:** OutDataTypeStr**Type:** character vector**Values:** 'Inherit: Same as input' | 'Inherit: Inherit via internal rule' | 'Inherit: Inherit via back propagation' | 'double' | 'single' | 'int8' | 'uint8' | 'int16' | 'uint16' | 'int32' | 'uint32' | 'int64' | 'uint64' | fixdt(1,16,0) | '<data type expression>'**Default:** 'Inherit: Inherit via internal rule'**Lock output data type setting against changes by the fixed-point tools — Output data type locking**

off (default) | on

Select this parameter to prevent the fixed-point tools from overriding the **Output data type** you specify on the block mask. For more information, see “Use Lock Output Data Type Setting” (Fixed-Point Designer).

Programmatic Use**Block Parameter:** LockScale**Type:** character vector**Values:** 'off' | 'on'**Default:** 'off'**Integer rounding mode — Rounding mode for fixed-point operations**

Floor (default) | Ceiling | Convergent | Nearest | Round | Simplest | Zero

Select the rounding mode (DSP System Toolbox) for fixed-point operations.

Programmatic Use**Block Parameter:** RndMeth**Type:** character vector**Values:** 'Ceiling' | 'Convergent' | 'Floor' | 'Nearest' | 'Round' | 'Simplest' | 'Zero'**Default:** 'Floor'**Saturate on integer overflow — Behavior when integer overflow occurs**

off (default) | on

Select this check box to have overflows saturate to the maximum or minimum value that the data type can represent. If you clear this check box, the block wraps all overflows. See Precision and Range (DSP System Toolbox) for more information.

When you select this check box, saturation applies to every internal operation on the block, not just the output or result. The code generation process can generally detect when overflow is not possible. In this case, the code generator does not produce saturation code.

Programmatic Use**Block Parameter:** SaturateOnIntegerOverflow**Type:** character vector**Value:** 'off' | 'on'**Default:** 'off'

Block Characteristics

| | |
|---------------------------------|---|
| Data Types | double fixed point integer single |
| Direct Feedthrough | no |
| Multidimensional Signals | no |
| Variable-Size Signals | no |
| Zero-Crossing Detection | no |

Compatibility Considerations

Matrix Square Block Moved to Simulink Matrix Operations Library

Behavior changed in R2021b

The Matrix Square block has been moved from the **DSP System Toolbox > Math Functions > Matrices and Linear Algebra > Matrix Operations** to the **Simulink > Matrix Operations**. All existing models continue to work.

Extended Capabilities

C/C++ Code Generation

Generate C and C++ code using Simulink® Coder™.

Fixed-Point Conversion

Design and simulate fixed-point systems using Fixed-Point Designer™.

See Also

Add | Cross Product | Hermitian Transpose | Identity Matrix | IsSymmetric | IsTriangular | Product | Transpose | Matrix Product

Topics

“Compatible Array Sizes for Basic Operations”
MATLAB Matrix Operations

Introduced before R2006a

Memory

Output input from previous time step

Library: Simulink / Discrete
HDL Coder / Discrete



Description

The Memory block holds and delays its input by one major integration time step. When placed in an iterator subsystem, it holds and delays its input by one iteration. This block accepts continuous and discrete signals. The block accepts one input and generates one output. Each signal can be a scalar, vector, matrix, or N-D array. If the input is non-scalar, the block holds and delays all elements of the input by the same time step.

You specify the block output for the first time step using the **Initial condition** parameter. Careful selection of this parameter can minimize unwanted output behavior. However, you cannot specify the sample time. This block's sample time depends on the type of solver used, or you can specify to inherit it. The **Inherit sample time** parameter determines whether sample time is inherited or based on the solver.

Tip Avoid using the Memory block when both these conditions are true:

- Your model uses the variable-step solver ode15s or ode113.
 - The input to the block changes during simulation.
-

When the Memory block inherits a discrete sample time, the block is analogous to the Unit Delay block. However, the Memory block does not support state logging. If logging the final state is necessary, use a Unit Delay block instead.

Comparison with Similar Blocks

The Memory, Unit Delay, and Zero-Order Hold blocks provide similar functionality but have different capabilities. Also, the purpose of each block is different.

This table shows recommended usage for each block.

| Block | Purpose of the Block | Reference Examples |
|------------|---|---|
| Unit Delay | Implement a delay using a discrete sample time that you specify. The block accepts and outputs signals with a discrete sample time. | <ul style="list-style-type: none"> • “Engine Timing Model with Closed Loop Control” on page 13-140 (Compression subsystem) |

| Block | Purpose of the Block | Reference Examples |
|-----------------------|--|--|
| Memory on page 1-1086 | Implement a delay by one major integration time step. Ideally, the block accepts continuous (or fixed in minor time step) signals and outputs a signal that is fixed in minor time step. | <ul style="list-style-type: none"> • “Building a Clutch Lock-Up Model” on page 13-144 (Friction Mode Logic/Lockup FSM subsystem) • “Capture the Velocity of a Bouncing Ball with the Memory Block” on page 12-85 |
| Zero-Order Hold | Convert an input signal with a continuous sample time to an output signal with a discrete sample time. | <ul style="list-style-type: none"> • “Developing the Apollo Lunar Module Digital Autopilot” on page 13-203 • “Radar Tracking Using MATLAB Function Block” on page 13-227 |

Each block has the following capabilities.

| Capability | Memory | Unit Delay | Zero-Order Hold |
|------------------------------------|--|------------|--|
| Specification of initial condition | Yes | Yes | No, because the block output at time $t = 0$ must match the input value. |
| Specification of sample time | No, because the block can only inherit sample time from the driving block or the solver used for the entire model. | Yes | Yes |
| Support for frame-based signals | No | Yes | Yes |
| Support for state logging | No | Yes | No |

Bus Support

The Memory block is a bus-capable block. The input can be a virtual or nonvirtual bus signal subject to the following restrictions:

- **Initial condition** must be zero, a nonzero scalar, or a finite numeric structure.
- If **Initial condition** is zero or a structure, and you specify a **State name**, the input cannot be a virtual bus.
- If **Initial condition** is a nonzero scalar, you cannot specify a **State name**.

For information about specifying an initial condition structure, see “Specify Initial Conditions for Bus Elements”.

All signals in a nonvirtual bus input to a Memory block must have the same sample time, even if the elements of the associated bus object specify inherited sample times. You can use a Rate Transition block to change the sample time of an individual signal, or of all signals in a bus. See “Modify Sample Times for Nonvirtual Buses” and Bus-Capable Blocks for more information.

You can use an array of buses as an input signal to a Memory block. You can specify the **Initial condition** parameter with:

- The value 0. In this case, all the individual signals in the array of buses use the initial value 0.
- An array of structures that specifies an initial condition for each of the individual signals in the array of buses.
- A single scalar structure that specifies an initial condition for each of the elements that the bus type defines. Use this technique to specify the same initial conditions for each of the buses in the array.

For details about defining and using an array of buses, see “Group Nonvirtual Buses in Arrays of Buses”.

Ports

Input

Port_1 – Input signal

scalar | vector | matrix | N-D array

Input signal, specified as a scalar, vector, matrix, or N-D array. The input can be continuous or discrete, containing real, or complex values of any data type Simulink supports.

Data Types: single | double | int8 | int16 | int32 | int64 | uint8 | uint16 | uint32 | uint64 | Boolean | fixed point | enumerated | bus

Output

Port_1 – Input delayed by one major integration time step

scalar | vector | matrix | N-D array

Output is the input from the previous time step.

Data Types: single | double | int8 | int16 | int32 | int64 | uint8 | uint16 | uint32 | uint64 | Boolean | fixed point | enumerated | bus

Parameters

Main

Initial condition – Initial condition

0 (default) | scalar | vector | matrix | N-D array

Specify the output at the initial integration step. This value must be 0 when you do not use a built-in input data type.

Programmatic Use

Block Parameter: InitialCondition

Type: character vector

Values: scalar | vector

Default: '0'

Inherit sample time – Inherit sample time

off (default) | on

Select to inherit the sample time from the driving block:

- If the driving block has a discrete sample time, the block inherits the sample time.
- If the driving block has a continuous sample time, selecting this check box has no effect. The sample time depends on the type of solver used for simulating the model.

When this check box is cleared, the block sample time depends on the type of solver used for simulating the model:

- If the solver is a variable-step solver, the block sample time is continuous but fixed in minor time step: `[0, 1]`.
- If the solver is a fixed-step solver, the `[0, 1]` sample time converts to the solver step size after sample-time propagation.

Programmatic Use

Block Parameter: `InheritSampleTime`

Type: character vector

Values: 'off' | 'on'

Default: 'off'

Direct feedthrough of input during linearization — Output the input during linearization and trim

off (default) | on

Select to output the input during linearization and trim. This selection sets the block mode to direct feedthrough.

Selecting this check box can cause a change in the ordering of states in the model when using the functions `linmod`, `dlinmod`, or `trim`. To extract this new state ordering, use the following commands.

First compile the model using the following command, where `model` is the name of the Simulink model.

```
[sizes, x0, x_str] = model([],[],[],'lincompile');
```

Next, terminate the compilation with this command.

```
model([],[],[],'term');
```

The output argument, `x_str`, which is a cell array of the states in the Simulink model, contains the new state ordering. When passing a vector of states as input to the `linmod`, `dlinmod`, or `trim` functions, the state vector must use this new state ordering.

Programmatic Use

Block Parameter: `LinearizeMemory`

Type: character vector

Values: 'off' | 'on'

Default: 'off'

Treat as a unit delay when linearizing with discrete sample time — Linearize to unit delay for discrete inputs

off (default) | on

Select to linearize the Memory block to a unit delay when the Memory block is driven by a signal with a discrete sample time.

Programmatic Use**Block Parameter:** LinearizeAsDelay**Type:** character vector**Values:** 'off' | 'on'**Default:** 'off'**State Attributes****State name — Unique name for block state**

' ' (default) | alphanumeric string

Use this parameter to assign a unique name to the block state. The default is ' '. When this field is blank, no name is assigned. When using this parameter, remember these considerations:

- A valid identifier starts with an alphabetic or underscore character, followed by alphanumeric or underscore characters.
- The state name applies only to the selected block.

This parameter enables **State name must resolve to Simulink signal object** when you click **Apply**.

For more information, see “C Code Generation Configuration for Model Interface Elements” (Simulink Coder).

Programmatic Use**Block Parameter:** StateName**Type:** character vector**Values:** unique name**Default:** ''**State name must resolve to Simulink signal object — Require state name resolve to a signal object**

off (default) | on

Select this check box to require that the state name resolves to a Simulink signal object.

Dependencies

To enable this parameter, specify a value for **State name**. This parameter appears only if you set the model configuration parameter **Signal resolution** to a value other than None.

Programmatic Use**Block Parameter:** StateMustResolveToSignalObject**Type:** character vector**Values:** 'off' | 'on'**Default:** 'off'**Block Characteristics**

| | |
|---------------------------|--|
| Data Types | Boolean bus double enumerated fixed point integer single |
| Direct Feedthrough | yes |

| | |
|---------------------------------|-----|
| Multidimensional Signals | yes |
| Variable-Size Signals | no |
| Zero-Crossing Detection | no |

Extended Capabilities

C/C++ Code Generation

Generate C and C++ code using Simulink® Coder™.

HDL Code Generation

Generate Verilog and VHDL code for FPGA and ASIC designs using HDL Coder™.

HDL Coder provides additional configuration options that affect HDL implementation and synthesized logic.

HDL Architecture

This block has a single, default HDL architecture.

HDL Block Properties

| | |
|----------------------------------|--|
| ConstrainedOutputPipeline | Number of registers to place at the outputs by moving existing delays within your design. Distributed pipelining does not redistribute these registers. The default is 0. For more details, see “ConstrainedOutputPipeline” (HDL Coder). |
| InputPipeline | Number of input pipeline stages to insert in the generated code. Distributed pipelining and constrained output pipelining can move these registers. The default is 0. For more details, see “InputPipeline” (HDL Coder). |
| OutputPipeline | Number of output pipeline stages to insert in the generated code. Distributed pipelining and constrained output pipelining can move these registers. The default is 0. For more details, see “OutputPipeline” (HDL Coder). |
| ResetType | Suppress reset logic generation. The default is <code>default</code> , which generates reset logic. See also “ResetType” (HDL Coder). |

Complex Data Support

This block supports code generation for complex signals.

PLC Code Generation

Generate Structured Text code using Simulink® PLC Coder™.

Fixed-Point Conversion

Design and simulate fixed-point systems using Fixed-Point Designer™.

See Also

Unit Delay | Zero-Order Hold

Topics

“C Code Generation Configuration for Model Interface Elements” (Simulink Coder)

“Organize Parameter Data into a Structure by Using Struct Storage Class” (Embedded Coder)

“Data Objects”

Introduced before R2006a

Merge

Combine multiple signals into single signal

Library: Simulink / Signal Routing

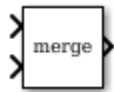

Description

The Merge block combines inputs into a single output. The output value at any time is equal to the most recently computed output of its driving blocks. Specify the number of inputs by setting the **Number of inputs** parameter.

Use a Merge block to interleave input signals that update at different times into a combined signal in which the interleaved values retain their separate identities and times. To combine signals that update at the same time into an array or matrix signal, use a Concatenate block.

Guidelines for Using the Merge Block

When you use the Merge block, follow these guidelines:

- Always use conditionally executed subsystems to drive Merge blocks, without any intervening blocks.
- Ensure that at most one of the driving conditionally executed subsystems executes at any time step.
- Ensure that all input signals have the same sample time.
- Do not branch a signal that inputs to a Merge block.
- For all conditionally executed subsystem Output blocks that drive Merge blocks, set **Output when disabled** to held.
- If the output of a Model block is coming from a MATLAB Function block or a Stateflow chart, do not connect that output port to the input port of the Merge block.
- The Merge block supports merging signals in different tasks to a root Output block.

For each input of a Merge block, the topmost nonvirtual source must be a conditionally executed subsystem (not including a For Iterator or While Iterator subsystem).

The next diagram shows valid Merge block usage, merging signals from two conditionally executed subsystems.

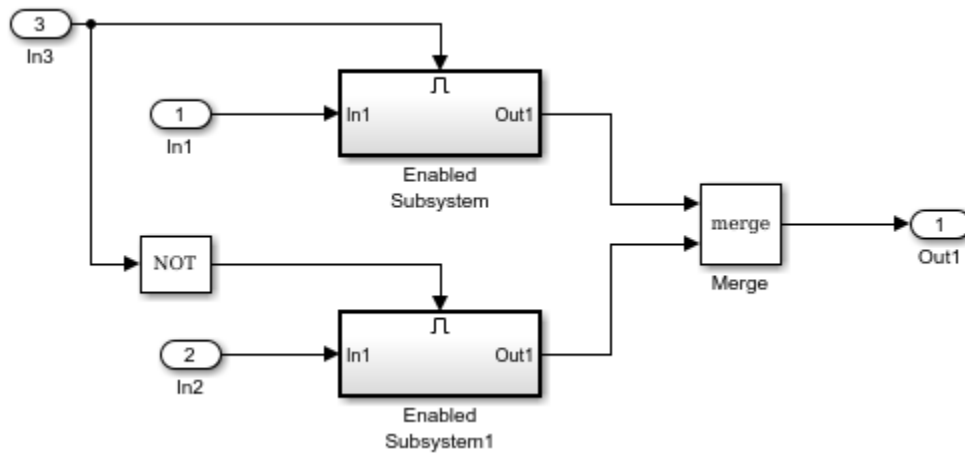

Bus Support

The Merge block is a bus-capable block. The inputs can be virtual or nonvirtual bus signals subject to these restrictions:

- The number of inputs must be greater than one.
- **Initial output** must be zero, a nonzero scalar, or a finite numeric structure.
- The **Allow unequal port widths** check box must be cleared.
- All inputs must be buses and must be equivalent (same hierarchy with identical names and attributes for all elements).

All signals in a nonvirtual bus input to a Merge block must have the same sample time. You can use a Rate Transition block to change the sample time of an individual signal, or of all signals in a bus.

Merging S-Function Outputs

The Merge block can merge a signal from an S-Function block only if the memory used to store the output from the S-Function block is reusable. Simulink displays an error message if you attempt to update or simulate a model that connects a nonreusable port of an S-Function block to a Merge block. See `ssSetOutputPortOptimOpts`.

Multi-tasked Root Outputs

A Merge block connected to a root Output block allows merging signals in different tasks by allowing those signals to write to the root Output block simultaneously. A Union sample time of the sources is assigned to the Merge block.

All the sources of the Merge block that are in the same task should be inside conditionally executed subsystems that should not output simultaneously in the same time step.

Limitations

- All signals that connect to a Merge block are functionally the same signal. Therefore, they are subject to the restriction that a given signal can have at most one associated signal object. See `Simulink.Signal` for more information.

- Run-time diagnostics do not run if the inputs to a Merge block are from a single initiator. For example, a single initiator could be a Stateflow chart executing function-call subsystems that are connected to a Merge block.
- Do not set the outputs of conditionally executed subsystems being merged to reset when disabled. This action can cause multiple subsystems to update the block at the same time. Specifically, the disabled subsystem updates the Merge block by resetting its output, while the enabled subsystem updates the block by computing its output.

To prevent this behavior, set the Output block parameter **Output when disabled** to held for each conditionally executed subsystem being merged.

- A Merge block does not accept input signals whose elements have been reordered or partially selected, as shown in the next diagram.

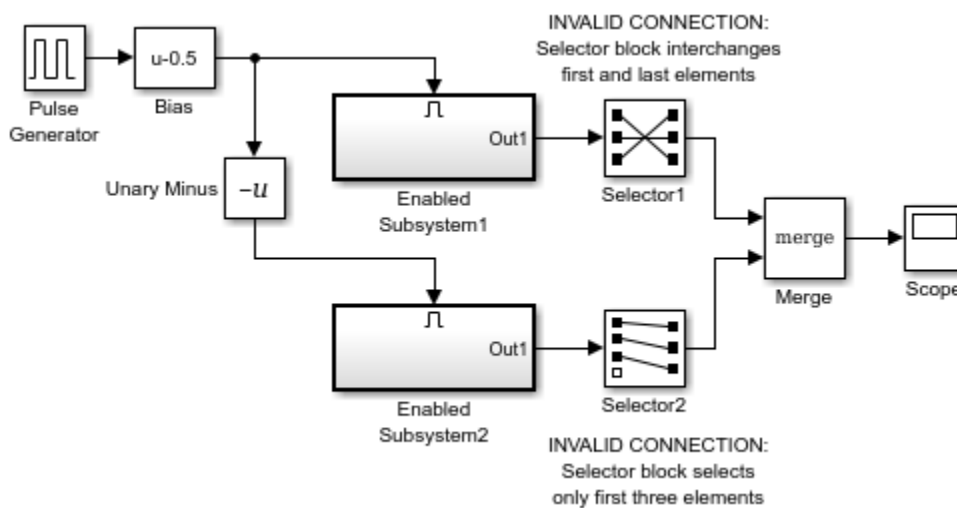

- Do not connect input signals to the block that have been combined outside of a conditionally executed subsystem.

You can use an array of buses as an input signal to a Merge block with these limitations:

- **Allow unequal port widths** — Clear this parameter.
- **Initial condition** — You can specify this parameter using:
 - The value θ . In this case, each of the individual signals in the array of buses use the initial value θ .
 - An array of structures that specifies an initial condition for each of the individual signals in the array of buses.
 - A single scalar structure that specifies an initial condition for each of the elements that the bus type defines. Use this technique to specify the same initial conditions for each of the buses in the array.

Ports

Input

Port_1 — First input signal

scalar | vector

First input signal merged with the other input signals.

Data Types: `single` | `double` | `half` | `int8` | `int16` | `int32` | `int64` | `uint8` | `uint16` | `uint32` | `uint64` | `Boolean` | `fixed point` | `enumerated` | `bus`

Port_n – nth input signal

`scalar` | `vector`

nth input signal merged with the other input signals.

Data Types: `single` | `double` | `half` | `int8` | `int16` | `int32` | `int64` | `uint8` | `uint16` | `uint32` | `uint64` | `Boolean` | `fixed point` | `enumerated` | `bus`

Output

Port_1 – Output signal

`scalar` | `vector`

Output signal merged from the input signals.

Data Types: `single` | `double` | `half` | `int8` | `int16` | `int32` | `int64` | `uint8` | `uint16` | `uint32` | `uint64` | `Boolean` | `fixed point` | `enumerated` | `bus`

Parameters

Number of inputs – Number of input signals to merge

2 (default) | `integer`

Specify the number of input signals to merge. The block creates a port for each input signal.

Programmatic Use

Block Parameter: Inputs

Type: character vector

Values: integer

Default: '2'

Initial output – Initial output value

[] (default) | `scalar` | `vector`

Specify the initial value of the output signal. If you do not specify an initial output value, then initial output depends on the initialization mode and the driving blocks.

In “Simplified Initialization Mode”, for an unspecified (empty matrix []) value of **Initial output**, the block uses the default initial value of the output data type. For information on the default initial value, see “Initialize Signal Values”. In “Classic Initialization Mode”, for an unspecified (empty matrix []) value of **Initial output**, the initial output of the block equals the most recently evaluated initial output of the driving blocks. Since the initialization ordering for these sources can vary, initialization can be inconsistent for the simulation and the code generation of a model.

Programmatic Use

Block Parameter: InitialOutput

Type: character vector

Values: `scalar` | `vector`

Default: '[]'

Allow unequal port widths — Allow inputs of unequal dimensions

off (default) | on

Select this parameter to allow the block to accept inputs having different numbers of elements from each other or from the output. The block allows you to specify an offset for each input signal relative to the beginning of the output signal. The width of the output signal is

$$\max(w_1+o_1, w_2+o_2, \dots, w_n+o_n)$$

where w_1, \dots, w_n are the widths of the input signals and o_1, \dots, o_n are the offsets for the input signals.

If you clear this parameter, the Merge block accepts only inputs of equal dimensions and outputs a signal of the same dimensions as the inputs.

Note Do not select this parameter unless your model is using Classic Initialization Mode.

Programmatic Use**Block Parameter:** AllowUnequalInputPortWidths**Type:** character vector**Values:** 'off' | 'on'**Default:** 'off'**Input port offsets — Offset for input signals**

[] (default) | vector

Enter a vector to specify the offset of each input signal relative to the beginning of the output signal.

Dependencies

To enable this parameter, select **Allow unequal port widths**.

Programmatic Use**Block Parameter:** InputPortOffsets**Type:** character vector**Values:** scalar | vector**Default:** '[]'**Block Characteristics**

| | |
|---------------------------------|--|
| Data Types | Boolean bus double enumerated fixed point half integer single string |
| Direct Feedthrough | yes |
| Multidimensional Signals | yes |
| Variable-Size Signals | no |
| Zero-Crossing Detection | no |

Extended Capabilities

C/C++ Code Generation

Generate C and C++ code using Simulink® Coder™.

In the code generation workflow, when the Merge block receives a constant value and non-constant sample times, one of these conditions must hold. Otherwise Simulink displays an error.

- The source of the constant value is a grounded signal.
- The source of the constant value is a constant block with a non-tunable parameter.
 - There is only one constant block that feeds the Merge block.
 - All other input signals to the Merge block are from conditionally executed subsystems.
 - The Merge block and output blocks of all conditionally executed subsystems does not specify any initial outputs.

Fixed-Point Conversion

Design and simulate fixed-point systems using Fixed-Point Designer™.

See Also

Switch | Manual Switch

Topics

“Conditionally Executed Subsystems Overview”

“Conditional Subsystem Initial Output Values”

“Conditional Subsystem Output Values When Disabled”

Introduced before R2006a

Entity Transport Delay

Introduce a delay in propagation of a SimEvents message

Library: Simulink / Continuous
SimEvents

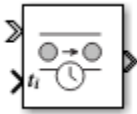

Description

The Entity Transport Delay block delays an entity for a period of time, named *transport delay*. The first input is the entity that is transported from point A to point B on a constant-length moving surface whose speed changes over time. The value from the second input is the *instantaneous delay*. The speed of the surface is the reciprocal of instantaneous delay. The product of instantaneous delay and the speed is 1.

The block calculates the implemented transport delay by the distance-speed-time relationship, where the surface length (distance) is equal to the integral of the variable surface speed over the duration of the transport delay (time). For more information about this calculation, see *Variable Transport Delay*.

The Entity Transport Delay block connects SimEvents to Simulink using the input from a Simulink signal and computing the transport delay as a continuous process, and applying this delay to an entity in a discrete-event process. For an example that uses the Entity Transport Delay block, see “Modeling Cyber-Physical Systems” on page 13-625.

Ports

Input

Port_1 — Input entity

SimEvents entity

SimEvents entity or message. For more information on entities in SimEvents, see “Entities in a SimEvents Model” (SimEvents).

t_i — Instantaneous delay

scalar | vector | matrix

Instantaneous delay in the transport of the SimEvents entity. t_i is the reciprocal of the speed of the entity. For more information on the calculation of instantaneous delay, see “Variable Transport Delay” on page 1-1943.

Data Types: single | double | int8 | int16 | int32 | uint8 | uint16 | uint32 | bus

Output

Port_1 — Delayed entity

SimEvents entity

SimEvents entity with the instantaneous delay t_i applied to it.

n — Number of delayed entities

real scalar

Secondary output signal of the block, which displays the number of entities processed in a time step.

Dependencies

To enable this port, enable the **Output number of entities in block, n** parameter

Data Types: double

Parameters

Capacity — Specify the capacity of the block

inf (default) | scalar

Specify capacity to accept entities to be delayed.

Programmatic Use

Block Parameter: Capacity

Type: character vector

Values: 'inf' | real scalar

Default: 'inf'

Output number of entities in block, n — Outputs the number of delayed entities present in the block

off (default) | on

Number of entities present in the block that are being delayed.

Programmatic Use

Block Parameter: ShowNumberEntitiesInBlock

Type: character vector

Values: 'on' | 'off'

Default: 'off'

Block Characteristics

| | |
|---------------------------------|--|
| Data Types | Boolean bus double enumerated fixed point integer single |
| Direct Feedthrough | no |
| Multidimensional Signals | yes |
| Variable-Size Signals | no |
| Zero-Crossing Detection | yes |

Extended Capabilities

C/C++ Code Generation

Generate C and C++ code using Simulink® Coder™.

See Also

Receive | Send | Transport Delay | Variable Transport Delay

Topics

“Establish Message Send and Receive Interfaces Between Software Components”

Introduced in R2019b

Message Merge

Combine message paths

Library: Simulink / Messages & Events



Description

The Message Merge block graphically combines multiple message lines into a single message line. Merging message lines does not change the messages themselves. You can specify the number of message lines to merge.

Use this block when you want to merge multiple incoming messages and output to a single destination such as a queue or a message storage block.

Ports

Input

Port_1 — Input message line to merge

scalar | vector | matrix

Input message port for messages entering the block.

Data Types: single | double | int8 | int16 | int32 | int64 | uint8 | uint16 | uint32 | uint64 | Boolean | enumerated | bus | fixed point

Port_2 — Input message line to merge

scalar | vector | matrix

Input message port for messages entering the block.

Data Types: single | double | int8 | int16 | int32 | int64 | uint8 | uint16 | uint32 | uint64 | Boolean | enumerated | bus | fixed point

Output

Port — Output message line

scalar | vector | matrix

Output message port for messages exiting the block.

Data Types: single | double | int8 | int16 | int32 | int64 | uint8 | uint16 | uint32 | uint64 | Boolean | enumerated | bus | fixed point

Parameters

Number of input ports — Specify the number message lines to combine

2 (default) | scalar

Determines the number of message input ports to be combined.

Programmatic Use

Block Parameter: NumberInputPorts

Type: character vector

Values: '2' | scalar

Default: '2'

Block Characteristics

| | |
|---------------------------------|---|
| Data Types | Boolean bus double enumerated fixed point integer single string |
| Direct Feedthrough | no |
| Multidimensional Signals | yes |
| Variable-Size Signals | no |
| Zero-Crossing Detection | no |

Extended Capabilities

C/C++ Code Generation

Generate C and C++ code using Simulink® Coder™.

See Also

Send | Queue | Entity Input Switch (SimEvents) | Entity Output Switch (SimEvents)

Topics

“Establish Message Send and Receive Interfaces Between Software Components”

Introduced in R2021a

Receive, Message Receive

Receive messages

Library: Simulink / Messages & Events
SimEvents



Description

The Receive block extracts data from received messages and writes them to the output signal port. If there are no new messages when the block executes, the block uses the **Value source when queue is empty** value. Receive and Message Receive blocks are identical blocks.

- Select `Hold last value` to hold data read from the last message.
- Select `Use initial value` to write default data.

Ports

Input

Port_1 — Input message

scalar | vector | matrix

The input port for the message.

Data Types: `single` | `double` | `int8` | `int16` | `int32` | `int64` | `uint8` | `uint16` | `uint32` | `uint64` | `Boolean` | `enumerated` | `bus` | `fixed point`

Output

Port_S — Show whether a message was received

scalar

Outputs 1 if the block receives a message successfully, and 0 otherwise.

Dependencies

To enable this port, select the check box labeled **Show receive status**.

Data Types: `double`

Port_1 — Output signal

scalar | vector | matrix

Output port for the signal.

Data Types: `single` | `double` | `int8` | `int16` | `int32` | `int64` | `uint8` | `uint16` | `uint32` | `uint64` | `Boolean` | `enumerated` | `bus` | `fixed point`

Parameters

Use internal queue — Select to use an internal queue

on (default for SimEvents) | off (default for Simulink)

Select this check box if you use an internal queue to receive messages.

Programmatic Use

Block Parameter: UseInternalQueue

Type: character vector

Values: 'on' | 'off'

Default: 'on'

Overwrite the oldest element if queue is full — Specify queue overwriting policy

on (default for Simulink) | off (default for SimEvents)

Select this check box to choose between two queue overwriting policies.

- If you select the check box, an incoming message overwrites the oldest if the queue is full.
- If you clear the check box, the block does not accept new messages if the queue is full.

Dependencies

This parameter is visible when you select the box labeled **Use internal queue**.

Programmatic Use

Block Parameter: QueueOverwriting

Type: character vector

Values: 'on' | 'off'

Default: 'on' (for Simulink) and 'off' (for SimEvents)

Queue length — Specify the length of the message queue

16 (default) | scalar

Specify message queue capacity. The queue length can be specified as a positive integer between 1 and $2^{26}-1$ (both included).

Dependencies

This parameter is visible when you select the box labeled **Use internal queue**.

Programmatic Use

Block Parameter: QueueLength

Type: character vector

Values: '16' | scalar

Default: '16'

Queue type — Specify message queue sorting policy

FIFO (default) | LIFO | Priority

The block supports three message sorting policies:

- First-in-first-out (FIFO) — The oldest message in the storage departs first.
- Last-in-first-out (LIFO) — The newest message in the storage departs first.
- Priority — Messages or entities are sorted based on their priority.

The priority queue can be used only when the **Overwrite the oldest element if queue is full** check box is cleared.

Note Priority queue accepts only non-bus scalar and it does not support fixed point data type.

Dependencies

This parameter is visible when you select the box labeled **Use internal queue**.

Programmatic Use

Block Parameter: QueueType

Type: character vector

Values: 'FIFO' | 'LIFO' | 'Priority'

Default: 'FIFO'

Priority order — Specify message queue priority

Ascending (default) | Descending

Choose the direction of sorting messages based on priority.

- Ascending — Messages with smaller priority values appear in front of the queue.
- Descending — Messages with greater priority values appear in front of the queue.

Dependencies

This parameter is visible when you select the box labeled **Use internal queue** and **Queue type > Priority**.

Programmatic Use

Block Parameter: PriorityOrder

Type: character vector

Values: 'Ascending' | 'Descending'

Default: 'Ascending'

Show receive status — Show whether a message was received

off (default) | on

Select this check box to show whether a message was received. If this check box is selected the block outputs 1 if it receives a message successfully, and 0 otherwise.

Programmatic Use

Block Parameter: ShowQueueStatus

Type: character vector

Values: 'on' | 'off'

Default: 'off'

Initial value — Set initial data value

[] (unspecified) (default) | scalar | vector | matrix

Enter an initial data value for the queue before the arrival of the first message. The default value [] (unspecified) is treated as 0 with data type double.

To use this block to initialize a nonvirtual bus signal, specify the initial value as a MATLAB structure. For more information about initializing nonvirtual bus signals using structures, see “Specify Initial Conditions for Bus Elements”.

Programmatic Use**Block Parameter:** InitialValue**Type:** character vector**Values:** '[]' | scalar**Default:** '[]'**Value source when queue is empty — Value source for empty queue**

Hold last value (default) | Use initial value

Specify the value to receive when received message queue is empty.

- **Hold last value (default)** — Holds data read from the last message.
Initially, if the block tries to receive a message and fails, it outputs the initial value.
- **Use initial value** — Writes default data.

DependenciesThis parameter is visible when you select the box labeled **Use internal queue**.**Programmatic Use****Block Parameter:** ValueSourceWhenQueueIsEmpty**Type:** character vector**Values:** 'Hold last value' | 'Use initial value'**Default:** 'Hold last value'**Sample time (-1 for inherited) — Specify the time interval between samples**

-1 (default) | scalar

To inherit the sample time, set this parameter to -1. See “Specify Sample Time” for more information.

Programmatic Use**Block Parameter:** SampleTime**Type:** character vector**Values:** '-1' | scalar**Default:** '-1'**Block Characteristics**

| | |
|---------------------------------|---|
| Data Types | Boolean bus double enumerated fixed point integer single string |
| Direct Feedthrough | no |
| Multidimensional Signals | yes |
| Variable-Size Signals | no |
| Zero-Crossing Detection | no |

Extended Capabilities

C/C++ Code Generation

Generate C and C++ code using Simulink® Coder™.

See Also

Send

Topics

“Simulink Messages Overview”

Introduced in R2016a

Send, Message Send

Create and send message

Library: Simulink / Messages & Events
SimEvents



Description

The Send block reads the value of an input signal, and sends a message that carries this value. In message-based communication, a message is a discrete-item of interest that carry data of any type that Simulink supports. Send and Message Send blocks are identical blocks.

Ports

Input

Port_Enable — External enable signal

scalar

Input port to enable the block to send a message. For any input value that is greater than 0 send is enabled. For any value less than or equal to 0, the send is disabled.

Dependencies

To enable this port, select the box labeled **Show enable port**.

Data Types: double

Port_1 — Input signal

scalar | vector | matrix

This block accepts inputs of any type that Simulink supports, including enumerated types and converts the input signal to a message. For more information, see “Data Types Supported by Simulink”.

Data Types: single | double | int8 | int16 | int32 | int64 | uint8 | uint16 | uint32 | uint64 | Boolean | enumerated | bus | fixed point

Output

Port_1 — Output message

scalar | vector | matrix

The block outputs a message with constant priority 20.

Data Types: single | double | int8 | int16 | int32 | int64 | uint8 | uint16 | uint32 | uint64 | Boolean | enumerated | bus | fixed point

Parameters

Show enable port — Display the enable port

off (default) | on

Select this check box to display enable port. For any input value that is greater than 0 send is enabled. For any value less than or equal to 0, the send is disabled.

Programmatic Use

Block Parameter: ShowEnablePort

Type: character vector

Values: 'on' | 'off'

Default: 'off'

Block Characteristics

| | |
|---------------------------------|---|
| Data Types | Boolean bus double enumerated fixed point integer single string |
| Direct Feedthrough | no |
| Multidimensional Signals | yes |
| Variable-Size Signals | no |
| Zero-Crossing Detection | no |

Extended Capabilities

C/C++ Code Generation

Generate C and C++ code using Simulink® Coder™.

See Also

Receive

Topics

“Simulink Messages Overview”

Introduced in R2016a

MinMax

Output minimum or maximum input value

Library: Simulink / Math Operations
HDL Coder / Math Operations



Description

The MinMax block outputs either the minimum or the maximum element or elements of the inputs. You choose whether the block outputs the minimum or maximum values by setting the **Function** parameter.

The MinMax block ignores any input value that is NaN, except when every input value is NaN. When all input values are NaN, the output is NaN, either as a scalar or the value of each output vector element.

Ports

Input

Port_1 — Input signal

scalar | vector | matrix

Provide an input signal from which the block outputs the maximum or minimum values.

- When the block has one input port, the input must be a scalar or a vector. The block outputs a scalar equal to the minimum or maximum element of the input vector.
- When the block has multiple input ports, all nonscalar inputs must have the same dimensions. The block expands any scalar inputs to have the same dimensions as the nonscalar inputs. The block outputs a signal having the same dimensions as the input. Each output element equals the minimum or maximum of the corresponding input elements.

Dependencies

To support matrix input, you must set the **Number of input ports** parameter to an integer greater than one. All nonscalar inputs must have the same dimensions.

Data Types: half | single | double | int8 | int16 | int32 | int64 | uint8 | uint16 | uint32 | uint64 | Boolean | fixed point

Port_N — N-th input signal

scalar | vector | matrix

Provide an input signal from which the block outputs the maximum or minimum values.

When the block has multiple input ports, all nonscalar inputs must have the same dimensions. The block expands any scalar inputs to have the same dimensions as the nonscalar inputs. The block

outputs a signal having the same dimensions as the input. Each output element equals the minimum or maximum of the corresponding input elements.

Dependencies

To provide more than one input signal, set the **Number of input ports** to an integer greater than 1.

Data Types: half | single | double | int8 | int16 | int32 | int64 | uint8 | uint16 | uint32 | uint64 | Boolean | fixed point

Output

Port_1 – Minimum or maximum values of inputs

scalar | vector | matrix

When the block has one input, the output is a scalar value, equal to the minimum or maximum of the input elements. When the block has multiple inputs, the output is a signal having the same dimensions as the input. Each output element equals the minimum or maximum of the corresponding input elements.

Data Types: half | single | double | int8 | int16 | int32 | int64 | uint8 | uint16 | uint32 | uint64 | Boolean | fixed point

Parameters

Main

Function – Specify minimum or maximum

min (default) | max

Specify whether to apply the function min or max to the input.

Programmatic Use

Block Parameter: Function

Type: character vector

Values: 'min' | 'max'

Default: 'min'

Number of input ports – Specify number of input ports

1 (default) | positive integer

Specify the number of inputs to the block.

Programmatic Use

Block Parameter: Inputs

Type: character vector

Values: positive integer

Default: '1'

Enable zero-crossing detection – Enable zero-crossing detection

on (default) | Boolean

Select to enable zero-crossing detection. For more information, see “Zero-Crossing Detection” in the Simulink documentation.

Programmatic Use**Block Parameter:** ZeroCross**Type:** character vector, string**Values:** 'off' | 'on'**Default:** 'on'**Sample time — Specify sample time as a value other than -1**

-1 (default) | scalar | vector

Specify the sample time as a value other than -1. For more information, see “Specify Sample Time”.

Dependencies

This parameter is not visible unless it is explicitly set to a value other than -1. To learn more, see “Blocks for Which Sample Time Is Not Recommended”.

Programmatic Use**Block Parameter:** SampleTime**Type:** character vector**Values:** scalar or vector**Default:** '-1'**Signal Attributes****Require all inputs to have the same data type — Inputs must have the same data type**

off (default) | on

Select this check box to require that all inputs have the same data type.

Programmatic Use**Block Parameter:** InputSameDT**Type:** character vector**Values:** 'off' | 'on'**Default:** 'off'**Output minimum — Minimum output value for range checking**

[] (default) | scalar

Lower value of the output range that Simulink checks.

Simulink uses the minimum to perform:

- Parameter range checking (see “Specify Minimum and Maximum Values for Block Parameters”) for some blocks.
- Simulation range checking (see “Specify Signal Ranges” and “Enable Simulation Range Checking”).
- Automatic scaling of fixed-point data types.
- Optimization of the code that you generate from the model. This optimization can remove algorithmic code and affect the results of some simulation modes such as SIL or external mode. For more information, see “Optimize using the specified minimum and maximum values” (Embedded Coder).

Note Output minimum does not saturate or clip the actual output signal. Use the Saturation block instead.

Programmatic Use

Block Parameter: OutMin

Type: character vector

Values: '[]' | scalar

Default: '[]'

Output maximum — Maximum output value for range checking

[] (default) | scalar

Upper value of the output range that Simulink checks.

Simulink uses the maximum value to perform:

- Parameter range checking (see “Specify Minimum and Maximum Values for Block Parameters”) for some blocks.
- Simulation range checking (see “Specify Signal Ranges” and “Enable Simulation Range Checking”).
- Automatic scaling of fixed-point data types.
- Optimization of the code that you generate from the model. This optimization can remove algorithmic code and affect the results of some simulation modes such as SIL or external mode. For more information, see “Optimize using the specified minimum and maximum values” (Embedded Coder).

Note Output maximum does not saturate or clip the actual output signal. Use the Saturation block instead.

Programmatic Use

Block Parameter: OutMax

Type: character vector

Values: '[]' | scalar

Default: '[]'

Output data type — Specify the output data type

Inherit: Inherit via internal rule (default) | Inherit: Inherit via back propagation | Inherit: Same as first input | double | single | half | int8 | uint8 | int16 | uint16 | int32 | uint32 | int64 | uint64 | fixdt(1,16,0) | fixdt(1,16,2^0,0) | <data type expression>

Choose the data type for the output. The type can be inherited, specified directly, or expressed as a data type object such as Simulink.NumericType.

Click the **Show data type assistant** button  to display the **Data Type Assistant**, which helps you set the data type attributes. For more information, see “Specify Data Types Using Data Type Assistant”.

Dependencies

When input is a floating-point data type smaller than single precision, the **Inherit: Inherit via internal rule** output data type depends on the setting of the “Inherit floating-point output type smaller than single precision” configuration parameter. Data types are smaller than single precision when the number of bits needed to encode the data type is less than the 32 bits needed to encode the single-precision data type. For example, `half` and `int16` are smaller than single precision.

Programmatic Use

Block Parameter: `OutDataTypeStr`

Type: character vector

Values: `'Inherit: Inherit via internal rule'` | `'Inherit: Inherit via back propagation'` | `'Inherit: Same as first input'` | `'single'` | `'half'` | `'int8'` | `'uint8'` | `'int16'` | `'uint16'` | `'int32'` | `'uint32'` | `'int64'` | `'uint64'` | `'fixdt(1,16,0)'` | `'fixdt(1,16,2^0,0)'` | `'<data type expression>'`

Default: `'Inherit: Inherit via internal rule'`

Lock output data type setting against changes by the fixed-point tools — Prevent fixed-point tools from overriding Output data type

`off` (default) | `on`

Select this parameter to prevent the fixed-point tools from overriding the **Output** data type you specify on the block. For more information, see “Use Lock Output Data Type Setting” (Fixed-Point Designer).

Programmatic Use

Block Parameter: `LockScale`

Type: character vector

Values: `'off'` | `'on'`

Default: `'off'`

Integer rounding mode — Rounding mode for fixed-point operations

`Floor` (default) | `Ceiling` | `Convergent` | `Nearest` | `Round` | `Simplest` | `Zero`

Specify the rounding mode for fixed-point operations. For more information, see “Rounding” (Fixed-Point Designer).

Block parameters always round to the nearest representable value. To control the rounding of a block parameter, enter an expression using a MATLAB rounding function into the mask field.

Programmatic Use

Block Parameter: `RndMeth`

Type: character vector

Values: `'Ceiling'` | `'Convergent'` | `'Floor'` | `'Nearest'` | `'Round'` | `'Simplest'` | `'Zero'`

Default: `'Floor'`

Saturate on integer overflow — Method of overflow action

`off` (default) | `on`

Specify whether overflows saturate or wrap.

| Action | Rationale | Impact on Overflows | Example |
|-------------------------------------|---|---|---|
| Select this check box (on). | Your model has possible overflow, and you want explicit saturation protection in the generated code. | Overflows saturate to either the minimum or maximum value that the data type can represent. | The maximum value that the <code>int8</code> (signed, 8-bit integer) data type can represent is 127. Any block operation result greater than this maximum value causes overflow of the 8-bit integer. With the check box selected, the block output saturates at 127. Similarly, the block output saturates at a minimum output value of -128. |
| Do not select this check box (off). | You want to optimize efficiency of your generated code. You want to avoid overspecifying how a block handles out-of-range signals. For more information, see "Troubleshoot Signal Range Errors". | Overflows wrap to the appropriate value that is representable by the data type. | The maximum value that the <code>int8</code> (signed, 8-bit integer) data type can represent is 127. Any block operation result greater than this maximum value causes overflow of the 8-bit integer. With the check box cleared, the software interprets the overflow-causing value as <code>int8</code> , which can produce an unintended result. For example, a block result of 130 (binary 1000 0010) expressed as <code>int8</code> , is -126. |

When you select this check box, saturation applies to every internal operation on the block, not just the output, or result. Usually, the code generation process can detect when overflow is not possible. In this case, the code generator does not produce saturation code.

Programmatic Use

Block Parameter: `SaturateOnIntegerOverflow`

Type: character vector

Values: 'off' | 'on'

Default: 'off'

Block Characteristics

| | |
|---------------------------------|--|
| Data Types | Boolean double fixed point half integer single |
| Direct Feedthrough | yes |
| Multidimensional Signals | yes |
| Variable-Size Signals | yes |
| Zero-Crossing Detection | yes |

Extended Capabilities

C/C++ Code Generation

Generate C and C++ code using Simulink® Coder™.

HDL Code Generation

Generate Verilog and VHDL code for FPGA and ASIC designs using HDL Coder™.

HDL Coder provides additional configuration options that affect HDL implementation and synthesized logic.

HDL Architecture

This block has multi-cycle implementations that introduce additional latency in the generated code. To see the added latency, view the generated model or validation model. See “Generated Model and Validation Model” (HDL Coder).

| Architecture | Additional cycles of latency | Description |
|-----------------|---|--|
| default Tree | 0 | Generates a tree structure of comparators. |
| Cascade | 1, when block has a single vector input port. | This implementation is optimized for latency * area, with medium speed. See “Cascade Architecture Best Practices” (HDL Coder). |

HDL Block Properties

| General | |
|----------------------------------|--|
| ConstrainedOutputPipeline | Number of registers to place at the outputs by moving existing delays within your design. Distributed pipelining does not redistribute these registers. The default is 0. For more details, see “ConstrainedOutputPipeline” (HDL Coder). |
| InputPipeline | Number of input pipeline stages to insert in the generated code. Distributed pipelining and constrained output pipelining can move these registers. The default is 0. For more details, see “InputPipeline” (HDL Coder). |
| OutputPipeline | Number of output pipeline stages to insert in the generated code. Distributed pipelining and constrained output pipelining can move these registers. The default is 0. For more details, see “OutputPipeline” (HDL Coder). |
| InstantiateStages | Generate a VHDL entity or Verilog module for each cascade stage. The default is off. See also “InstantiateStages” (HDL Coder). |
| SerialPartition | Specify partitions for Cascade-serial implementations as a vector of the lengths of each partition. The default setting uses the minimum number of stages. See also “SerialPartition” (HDL Coder). |

Note To enable the **LatencyStrategy** setting for the MinMax block, you must specify **Tree** as the **HDL Architecture**.

| Native Floating Point | |
|------------------------------|--|
| LatencyStrategy | Specify whether to map the blocks in your design to <code>inherit</code> , <code>Max</code> , <code>Min</code> , or <code>Zero</code> for the floating-point operator. The default is <code>inherit</code> . See also "LatencyStrategy" (HDL Coder). |

PLC Code Generation

Generate Structured Text code using Simulink® PLC Coder™.

Fixed-Point Conversion

Design and simulate fixed-point systems using Fixed-Point Designer™.

See Also

MinMax Running Resettable

Introduced before R2006a

MinMax Running Resettable

Determine minimum or maximum of signal over time

Library: Simulink / Math Operations



Description

The MinMax Running Resettable block outputs the minimum or maximum of all past inputs u . You specify whether the block outputs the running minimum or maximum with the **Function** parameter.

The block can reset its state based on an external reset signal R . When the reset signal R is nonzero (`true`), the block resets the output to the value of the **Initial condition** parameter.

The input can be a scalar, vector, or matrix signal. The block outputs a signal having the same dimensions as the input. Each output element equals the running minimum or maximum of the corresponding input elements.

Ports

Input

u — Input signal

scalar | vector | matrix

Input signal as a scalar, vector, or matrix. Based on what you specify for the **Function** parameter, the block outputs the minimum or maximum value of all past inputs u .

If you specify a scalar value for the **Initial condition** parameter, the block expands the parameter to have the same dimensions as nonscalar input u .

Data Types: single | double | int8 | int16 | int32 | int64 | uint8 | uint16 | uint32 | uint64 | Boolean | fixed point | bus

R — Reset signal

scalar | vector | matrix

The input port accepting the reset signal as a scalar, vector, or matrix. When the reset signal is nonscalar, it must have the same dimensions as input signal u . As long as the reset signal has a value of zero, the block outputs the running minimum or maximum value of input u . Whenever the reset signal has a nonzero value (`true`), the block resets the output to the value of the **Initial condition** parameter.

Data Types: single | double | int8 | int16 | int32 | int64 | uint8 | uint16 | uint32 | uint64 | Boolean | fixed point | bus

Output

y — Running minimum or maximum value

scalar | vector | matrix

Output signal, specified as a scalar, vector, or matrix, where each output element equals the running minimum or maximum value of the corresponding input elements. Output signal **y** has the same data type and dimensions as input signal **u**.

When the block receives a nonzero (**true**) reset signal, the block resets the output to the value of the **Initial condition** parameter.

Data Types: `single` | `double` | `int8` | `int16` | `int32` | `int64` | `uint8` | `uint16` | `uint32` | `uint64` | `Boolean` | `fixed point`

Parameters

Function — Specify minimum or maximum

`min` (default) | `max`

Specify whether the block outputs the running minimum or maximum value of the corresponding input elements.

Programmatic Use

Block Parameter: `Function`

Type: character vector

Values: `'min'` | `'max'`

Default: `'min'`

Initial condition — Value to reset output to

`0.0` (default) | scalar or vector

Specify the initial condition value. When the reset input signal **R** is **true**, the block resets the output to the value you specify.

Programmatic Use

Block Parameter: `vinit`

Type: character vector

Values: scalar or vector

Default: `'0.0'`

Block Characteristics

| | |
|---------------------------------|---|
| Data Types | Boolean double fixed point integer single |
| Direct Feedthrough | no |
| Multidimensional Signals | no |
| Variable-Size Signals | no |
| Zero-Crossing Detection | no |

Extended Capabilities

C/C++ Code Generation

Generate C and C++ code using Simulink® Coder™.

PLC Code Generation

Generate Structured Text code using Simulink® PLC Coder™.

Fixed-Point Conversion

Design and simulate fixed-point systems using Fixed-Point Designer™.

See Also

MinMax

Introduced before R2006a

Model

Reference another model to create model hierarchy

Library: Simulink / Ports & Subsystems
HDL Coder / Ports & Subsystems



Description

The Model block references the specified model. It displays input and output ports that correspond to the top-level input and output ports of the referenced model. These ports allow you to connect the referenced model to other blocks in the parent model.

To determine whether the Model block is better suited for your goal than another block with similar functionality, see “Choose Among Types of Model Components” and “Compare Capabilities of Model Components”.

For instructions on how to reference a model with a Model block, see “Reference Existing Models”.

By default, the Model block displays a representation of the contents of the referenced model. For more information, see “Preview Content of Model Components”. To see the contents of a referenced model, double-click the Model block.

If you have a Simulink Coder license, you can conceal the implementation details of a referenced model by protecting the model. To protect a model, see “Protect Models to Conceal Contents” (Simulink Coder). To reference a protected model, see “Reference Protected Models from Third Parties”.

Ports

Input

Port_1 — Input that corresponds to root-level blocks of referenced model

signal | message | function call

The Model block has an input port for each input port of the model it references. The input ports of referenced models are defined by Inport and In Bus Element blocks. The name of the Model block port matches the name of the corresponding port in the referenced model. The input signal for each Model block port must be valid for the corresponding port in the referenced model. For more information, see “Model Reference Interface and Boundary”.

Function calls connected to an input port pass into the referenced model. To conditionally execute the referenced model based on a function call, see **Function Call** on page 1-0 .

Data Types: single | double | int8 | int16 | int32 | int64 | uint8 | uint16 | uint32 | uint64 | Boolean | fixed point | enumerated | bus

Output

Port_1 — Output that corresponds to root-level blocks of referenced model

signal | message

The Model block has an output port for each output port of the model it references. The output ports of referenced models are defined by Output and Out Bus Element blocks. The name of the port on the Model block matches the name of the corresponding port in the referenced model. The output signals of the Model block are the signals connected to the Output and Out Bus Element blocks in the referenced model. See “Model Reference Interface and Boundary”.

Data Types: single | double | int8 | int16 | int32 | int64 | uint8 | uint16 | uint32 | uint64 | Boolean | fixed point | enumerated | bus

Control

Conditional Execution

Enable — Control signal that enables referenced model

scalar | vector | matrix

The enable port appears at the top of the Model block. The port label is an icon that represents an enable signal.

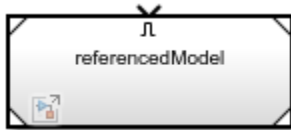

The control signal that connects to the port determines when to execute the referenced model. For more information, see “Conditionally Execute Referenced Models”.

Dependencies

To enable this port, add an Enable block to the top level of the referenced model.

Data Types: single | double | int8 | int16 | int32 | int64 | uint8 | uint16 | uint32 | uint64 | Boolean | fixed point

Trigger — Control signal that triggers referenced model

scalar | vector | matrix

The trigger port appears at the top of the Model block. The port label is an icon that represents a trigger signal.

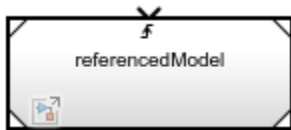

The control signal that connects to the port determines when to execute the referenced model. For more information, see “Conditionally Execute Referenced Models”.

Dependencies

To enable this port, add a Trigger block to the top level of the referenced model and set its **Trigger type** to rising, falling, or either.

Data Types: single | double | int8 | int16 | int32 | int64 | uint8 | uint16 | uint32 | uint64 | Boolean | fixed point

Function Call – Control signal for function-call event

function call

The function-call port appears at the top of the Model block. The port label displays the name of the referenced model as a function.

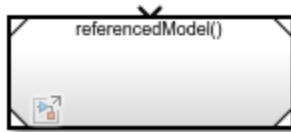

The control signal that connects to the port determines when to execute the referenced model. For more information, see “Conditionally Execute Referenced Models”.

Dependencies

To enable this port, add a Trigger block to the top level of the referenced model and set its **Trigger type** to function-call.

Model Events Simulation

initialize – Control signal for model initialize event

function call

The initialize event port provides a control signal that triggers a model initialize event, which initializes the states of the referenced model.

The referenced model can contain an Initialize Function block that corresponds to the model initialize event. For more information, see “Using Initialize, Reset, and Terminate Functions”.

Dependencies

To enable this port, select **Show model initialize port** on page 1-0 .

reset – Control signal for model reset event

function call

A reset event port provides a control signal that triggers a model reset event, which resets the states of the referenced model.

The referenced model must contain a Reset Function block that corresponds to each model reset event. For more information, see “Using Initialize, Reset, and Terminate Functions”.

To specify the port name, use the **Event name** parameter of the Event Listener block in the Reset Function block.

Dependencies

To enable this type of port, select **Show model reset ports** on page 1-0 .

terminate — Control signal for model terminate event

function call

The terminate event port provides a control signal that triggers a model terminate event, which reads and saves the states of the referenced model.

The referenced model can contain a Terminate Function block that corresponds to the model terminate event. For more information, see “Using Initialize, Reset, and Terminate Functions”.

Dependencies

To enable this port, select **Show model terminate port** on page 1-0 .

D[??] — Control signal for scheduling periodic events

function call

Periodic event ports provide control signals that specify when to execute the model. For an example, see “Test Rate-Based Model Simulation Using Function-Call Generators”.

Each port label displays information about the periodic event, such as the sample time of the corresponding Inport block. For example, the Model block in this image displays periodic event ports and references a model with two discrete rates: 0.01 and 0.1.

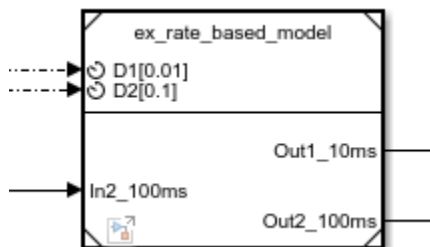
**Dependencies**

To enable this type of port, set **Schedule rates with** on page 1-0 to Ports.

Parameters

To interactively modify Model block parameters, select the Model block. Then, in the Simulink Toolstrip, on the **Model Block** tab, click **Block Parameters**.

Main

Specify fundamental information for the Model block.

Model name — File name of referenced model

' ' (default) | character vector

Specify the file name of the referenced model. The file name must be a valid MATLAB identifier for a model, as defined in “Model Names”. The file extension is optional.

To select the model that you want to reference, click **Browse**. To view the specified model, click **Open Model**.

Programmatic Use

You can query the name of the referenced model in different formats:

- `ModelFile` — Model name with file extension. When you do not specify a file extension, the first match that Simulink finds on the MATLAB path determines the file extension.
- `ModelNameDialog` — Model name with or without file extension, depending on whether you specify a file extension.
- `ModelName` — Model name without file extension. If you specify a model name with a file extension for `ModelName`, Simulink retains the file extension by setting `ModelNameDialog` and `ModelFile`.

Parameter: `ModelNameDialog`

Type: character vector

Value: '' | '<filename>'

Default: ''

Simulation mode — Simulation mode for model reference

Normal (default) | Accelerator | Software-in-the-loop (SIL) | Processor-in-the-loop (PIL)

Specify the simulation mode for the Model block. The simulation mode for the Model block can be different than the simulation mode of its referenced model and of other models in the model hierarchy.

- `Accelerator` — Create a MEX file for the referenced model and then execute the referenced model by running the S-function.
- `Normal` — Execute the referenced model interpretively, as if the referenced model is an atomic subsystem implemented directly within the parent model.
- `Software-in-the-loop (SIL)` — This option requires an Embedded Coder license. Generate production code based on the **Code interface** on page 1-0 parameter setting. The code is compiled for and executed on the host platform.
- `Processor-in-the-loop (PIL)` — This option requires an Embedded Coder license. Generate production code based on the **Code Interface** parameter setting. This code is compiled for and executed on the target platform. A target connectivity API implementation supports the exchange of data between the host and target at each time step during the PIL simulation.

The corners of the Model block indicate the simulation mode of the Model block. For normal mode, the corners have empty triangles. For accelerator mode, the corner triangles are filled in. For SIL and PIL modes, the corners are filled in and the word (SIL) or (PIL) appears on the block icon.

Although you can specify any simulation mode for a model, when you reference that model, the Model block specifies the simulation mode of the referenced model instance. The simulation mode of a parent model can override the simulation mode of a Model block.

For more information, see “Choose Simulation Modes for Model Hierarchies”.

Programmatic Use

Parameter: `SimulationMode`

Type: character vector

Value: 'Normal' | 'Accelerator' | 'Software-in-the-loop' | 'Processor-in-the-loop'

Default: 'Normal'

Code interface — Option to generate code from top model or referenced model

Model reference (default) | Top model

Specify whether to generate the code from the top model or the referenced model for SIL and PIL simulation modes. To deploy the generated code as part of a larger application that uses the referenced model, specify `Model reference`. To deploy the generated code as a standalone application, specify `Top model`.

- `Model reference` — The code is generated from the referenced model as part of a model hierarchy. Code generation uses the `slbuild('model', 'ModelReferenceCoderTarget')` command.
- `Top model` — The code is generated from the top model with the standalone code interface. Code generation uses the `slbuild('model')` command.

Dependencies

To enable this parameter, set **Simulation mode** on page 1-0 to either Software-in-the-loop (SIL) or Processor-in-the-loop (PIL).

Programmatic Use**Parameter:** CodeInterface**Type:** character vector**Value:** 'Model reference' | 'Top model'**Default:** 'Model reference'**Model Events Simulation**

Control when the referenced model executes and changes states.

Show model initialize port — Option to display initialize event port

off (default) | on

Select this parameter to display the initialize event port. Clear this parameter to remove the port.

Dependencies

To enable this parameter, reference a model that is not configured for conditional execution.

Programmatic Use**Block parameter:** ShowModelInitializePort**Type:** character vector**Value:** 'off' | 'on'**Default:** 'off'**Show model reset ports — Option to display reset event ports**

off (default) | on

Select this parameter to display the reset event ports. Clear this parameter to remove the ports.

Dependencies

To enable this parameter, reference a model that is not configured for conditional execution and contains a Reset Function block.

Programmatic Use**Block parameter:** ShowModelResetPorts

Type: character vector

Value: 'off' | 'on'

Default: 'off'

Show model terminate port — Option to display terminate event port

off (default) | on

Select this parameter to display the terminate event port. Clear this parameter to remove the port.

Dependencies

To enable this parameter, reference a model that is not configured for conditional execution. Then, select **Show model initialize port** on page 1-0 .

Programmatic Use

Block parameter: ShowModelTerminatePort

Type: character vector

Value: 'off' | 'on'

Default: 'off'

Schedule rates — Option to schedule periodic events

off (default) | on

Control the execution of the referenced model with periodic events.

Depending on the value of the **Schedule rates with** parameter, selecting this parameter will either display the periodic event ports on the Model block or create partitions to use with the **Schedule Editor**. When the **Schedule rates with** parameter is not visible, its default value (Ports) applies.

Clearing this parameter hides the periodic event ports and does not create partitions.

Dependencies

To enable this parameter, reference a model with discrete sample times that is not configured for conditional execution and is not an export-function model. When the parent model is rate based and the referenced model is an export-function model, **Schedule rates** is automatically selected.

Programmatic Use

Block parameter: ScheduleRates

Type: character vector

Value: 'off' | 'on'

Default: 'off'

Schedule rates with — Option to create partitions or periodic event ports

Ports (default) | Schedule Editor

Create ports or partitions.

- Ports — Display periodic event ports for discrete rates in the referenced model.

To manually specify port rates, use the `set_param` function to set the `AutoFillPortDiscreteRates` parameter of the Model block to 'off'. Then, specify the port rates with the `PortDiscreteRates` parameter.

- Schedule Editor — Create partitions for the referenced model to use with the **Schedule Editor**.

Dependencies

To enable this parameter:

- The parent model must not be an export-function model.
- The parent model must not use a fixed-step solver and single-tasking mode.
- Select **Schedule rates**. When the parent model is rate based and the referenced model is an export-function model, **Schedule rates** is automatically selected.
- Clear **Show model initialize port** and **Show model reset ports**.

Programmatic Use

Block parameter: ScheduleRatesWith

Type: character vector

Value: 'Ports' | 'ScheduleEditor'

Default: 'Ports'

Instance Parameters

Specify instance-specific values for model arguments.

Instance parameters — Display instance parameters and specify values for referenced model

number | workspace variable | mathematical expression | structure or structure field

Display instance parameters and specify instance-specific values. Instance parameters are block parameters that have been configured in the referenced model to use a different value for each instance of the model.

To specify instance-specific values, use the **Value** column in the table. To specify that a parameter value can be overridden by the parent model, select the **Argument** check box. For more information about configuring instance parameters in a referenced model and specifying instance-specific values at the Model block, see “Parameterize Instances of a Reusable Referenced Model”.

When changing instance-specific values, you can use a partial structure that has fields that correspond to only the instance parameters whose values you want to change. Instance parameters not included in the partial structure retain their values. In the structure, include the instance parameter names and values, specified as character vectors.

Programmatic Use

Block parameter: ParameterArgumentValues

Type: structure

Value: structure

Default: structure with no fields

Block parameter: InstanceParameters

Type: structure array

Value: structure with fields: Name, Value, Path, and Argument.

Block Characteristics

| | |
|---------------------------|---|
| Data Types | Boolean ^a bus ^a double ^a enumerated ^a fixed point ^a half ^a integer ^a single ^a string ^a |
| Direct Feedthrough | no |

| | |
|---------------------------------|----------------------|
| Multidimensional Signals | limited ^a |
| Variable-Size Signals | limited ^a |
| Zero-Crossing Detection | no |

a. Actual data type or capability support depends on block implementation.

Tips

To programmatically determine whether a Model block references a protected model, use the `get_param` function to query the read-only `ProtectedModel` parameter of the Model block. If the referenced model is protected, the function returns 'on'. If the referenced model is unprotected, the function returns 'off'.

Compatibility Considerations

Specifying variant models in Model blocks is no longer supported

Warns starting in R2019a

Starting in R2019a, specifying variant models in Model blocks is no longer supported. The Model Variants block, which was a Model block preconfigured to specify variant models, is also no longer supported. Loading a model that contains these blocks converts them to Variant Subsystem blocks that contain Model blocks that represent the variant choices.

Variant Subsystem blocks provide these advantages:

- You can mix Model blocks and Subsystem blocks as variant choices.
- You can specify variants that have different numbers of input and output ports.

The Variant Subsystem block parameter **Analyze all choices during update diagram and generate preprocessor conditionals** behaves differently from the Model block parameter **Generate preprocessor conditionals**. Instead of causing simulation and update diagram to compile the active variant only, the Variant Subsystem block parameter compiles all variants.

If you have scripts that use Model block parameters for variants, you must update them to use Variant Subsystem block parameters.

Extended Capabilities

C/C++ Code Generation

Generate C and C++ code using Simulink® Coder™.

Actual code generation support depends on block implementation.

HDL Code Generation

Generate Verilog and VHDL code for FPGA and ASIC designs using HDL Coder™.

HDL Coder provides additional configuration options that affect HDL implementation and synthesized logic. For more information about using the Model block for HDL code generation and best practices and limitations, see “Model Referencing for HDL Code Generation” (HDL Coder).

See also “Generate Black Box Interface for Referenced Model” (HDL Coder) and “Generate Parameterized Code for Referenced Models” (HDL Coder).

HDL Architecture

| Architecture | Description |
|--------------------------|--|
| ModelReference (default) | When you want to generate code from a referenced model and any nested models, use the ModelReference implementation. For more information, see “How To Generate Code for a Referenced Model” (HDL Coder). |
| BlackBox | Use the BlackBox implementation to instantiate an HDL wrapper, or black box interface, for legacy or external HDL code. If you specify a black box interface, HDL Coder does not attempt to generate HDL code for the referenced model. For more information, see “Generate Black Box Interface for Referenced Model” (HDL Coder). |

Black Box Interface Customization

For the **BlackBox** architecture, you can customize port names and set attributes of the external component interface. See “Customize Black Box or HDL Cosimulation Interface” (HDL Coder).

HDL Block Properties

| | |
|----------------------------------|--|
| BalanceDelays | Detects introduction of new delays along one path and inserts matching delays on the other paths. The default is <code>inherit</code> . See also “BalanceDelays” (HDL Coder). |
| ConstrainedOutputPipeline | Number of registers to place at the outputs by moving existing delays within your design. Distributed pipelining does not redistribute these registers. The default is <code>0</code> . For more details, see “ConstrainedOutputPipeline” (HDL Coder). |
| DistributedPipelining | Pipeline register distribution, or register retiming. The default is <code>off</code> . See also “DistributedPipelining” (HDL Coder). |
| DSPStyle | Synthesis attributes for multiplier mapping. The default is <code>none</code> . See also “DSPStyle” (HDL Coder). |
| InputPipeline | Number of input pipeline stages to insert in the generated code. Distributed pipelining and constrained output pipelining can move these registers. The default is <code>0</code> . For more details, see “InputPipeline” (HDL Coder). |
| OutputPipeline | Number of output pipeline stages to insert in the generated code. Distributed pipelining and constrained output pipelining can move these registers. The default is <code>0</code> . For more details, see “OutputPipeline” (HDL Coder). |

| | |
|-----------------------------|---|
| ReferenceModelPrefix | <p>Prefix of the referenced model to insert in the generated code. The code generator applies this prefix to submodel file names and HDL identifiers. The default prefix is <code>modelName_</code> where <code>modelName</code> is the name of the referenced model.</p> <hr/> <p>Note</p> <ul style="list-style-type: none"> • If you specify an empty prefix, the code generator does not add a prefix to submodel file names. This can cause HDL compilation errors due to naming collisions between the models. • If you use the referenced model as the DUT, the code generator ignores the prefix that you specify. |
| SharingFactor | Number of functionally equivalent resources to map to a single shared resource. The default is 0. See also “Resource Sharing” (HDL Coder). |
| StreamingFactor | Number of parallel data paths, or vectors, that are time multiplexed to transform into serial, scalar data paths. The default is 0, which implements fully parallel data paths. See also “Streaming” (HDL Coder). |

Fixed-Point Conversion

Design and simulate fixed-point systems using Fixed-Point Designer™.

Actual data type support depends on block implementation.

See Also

`find_mdhrefs` | `Simulink.SubSystem.convertToModelReference` | `convertToVariant` | `depview`

Topics

“Compare Capabilities of Model Components”

“Model Reference Basics”

“Reference Existing Models”

“Parameterize Instances of a Reusable Referenced Model”

“Choose Simulation Modes for Model Hierarchies”

“Protect Models to Conceal Contents” (Simulink Coder)

Introduced before R2006a

Model Info

Display model properties and text in model

Library: Simulink / Model-Wide Utilities
HDL Coder / Model-Wide Utilities

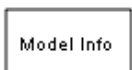

Description

The Model Info block displays model properties and text about a model on the mask of the block. Use the Model Info block dialog box to specify the content and format of the text that the block displays. You can select model properties to display on the block. In the text displayed on the block mask, Simulink replaces the property name with the current value of the property in the model.

Parameters

Specify Text and Properties to Display — Content and format of the text to display

no default

Use the **Enter text and tokens to display on Model Info block** edit box to specify the text and properties to display.

- In the edit box, enter any text you want to display on the block mask. Edit the default text Model Info.
- To display a model property on the block mask, select a property in the **Model properties** list and click the right arrow button.

The block adds a token of the form %<modelpropertyname> to the edit box. In the text the block mask displays, Simulink replaces the token with the value of the property.

- 1 For example, if you select **Description** in the **Model properties** list and click the right arrow button, then the token

```
%<Description>
```

 appears in the right edit box.
- 2 You could add some explanatory text before the model property, e.g. "Model description:".
- 3 When you click **Apply** or **OK**, Simulink displays your new text and the current value of the model property on the block mask in the Model Editor.

See "Access Model Information Programmatically" for descriptions of the model properties.

If you are interested in source control information, for a flexible interface to source control tools, use a project. See "Source Control in Projects".

Block Characteristics

| | |
|---------------------------------|----|
| Data Types | |
| Direct Feedthrough | no |
| Multidimensional Signals | no |
| Variable-Size Signals | no |
| Zero-Crossing Detection | no |

Extended Capabilities

C/C++ Code Generation

Generate C and C++ code using Simulink® Coder™.

The Model Info block is ignored during code generation.

HDL Code Generation

Generate Verilog and VHDL code for FPGA and ASIC designs using HDL Coder™.

HDL Coder provides additional configuration options that affect HDL implementation and synthesized logic.

Best Practices

When using Model Info blocks in models targeted for HDL code generation, consider using only ASCII characters in the text that you enter to display on the Model Info block. If you have non-ASCII characters in the generated HDL code, RTL simulation and synthesis tools can fail to compile the code.

HDL Architecture

This block has a single, default HDL architecture.

HDL Block Properties

| | |
|----------------------------------|--|
| ConstrainedOutputPipeline | Number of registers to place at the outputs by moving existing delays within your design. Distributed pipelining does not redistribute these registers. The default is 0. For more details, see “ConstrainedOutputPipeline” (HDL Coder). |
| InputPipeline | Number of input pipeline stages to insert in the generated code. Distributed pipelining and constrained output pipelining can move these registers. The default is 0. For more details, see “InputPipeline” (HDL Coder). |
| OutputPipeline | Number of output pipeline stages to insert in the generated code. Distributed pipelining and constrained output pipelining can move these registers. The default is 0. For more details, see “OutputPipeline” (HDL Coder). |

PLC Code Generation

Generate Structured Text code using Simulink® PLC Coder™.

See Also

DocBlock

Topics

“Access Model Information Programmatically”

“Source Control in Projects”

Introduced before R2006a

Multiport Switch

Select output signal based on control signal

Library: Simulink / Signal Routing
HDL Coder / Signal Routing

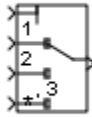

Description

The Multiport Switch block determines which of several inputs to the block passes to the output. The block bases this decision on the value of the first input. The first input is the control input and the remaining inputs are the data inputs. The value of the control input determines which data input passes to the output.

The table summarizes how the block interprets the control input and determines the data input that is passed to the output.

| Control Input | Truncation | Setting for Data Port Order | Block Behavior During Simulation | |
|----------------------|--|-----------------------------|----------------------------------|---|
| | | | Indexing to Select Data Input | Out-of-Range Condition |
| Integer value | None | Zero-based contiguous | Zero-based indexing | The control input is less than 0 or greater than the number of data inputs minus one. |
| | | One-based contiguous | One-based indexing | The control input is less than 1 or greater than the number of data inputs. |
| | | Specify indices | Indices you specify | The control input does not correspond to any specified data port index. |
| Not an integer value | The block truncates the value to an integer by rounding to zero. | Zero-based contiguous | Zero-based indexing | The truncated control input is less than 0 or greater than the number of data inputs minus one. |
| | | One-based contiguous | One-based indexing | The truncated control input is less than 1 or greater than the number of data inputs. |
| | | Specify indices | Indices you specify | The truncated control input does not correspond to any specified data port index. |

For information on how the block handles the out-of-range condition, see “How the Block Handles an Out-of-Range Control Input” on page 1-1137.

Multiport Switch Configured as an Index Vector Block

An Index Vector is a special configuration of a Multiport Switch block in which you specify one data input and the control input is zero-based. The block output is the element of the input vector whose index matches the control input. For example, if the input vector is [18 15 17 10] and the control input is 3, the element that matches the index of 3 (zero-based) is 10, and that becomes the output value.

To configure a Multiport Switch block to work as an Index Vector block, set **Number of data ports** to 1 and **Data port order** to Zero-based contiguous.

How the Block Handles an Out-of-Range Control Input

For an input with an integer value less than `intmax('int32')`, the input is out of range when the value does not match any data port indices. For a control input that is not an integer value, the input is out of range when the *truncated* value does not match any data port indices. In both cases, the block behavior depends on your settings for **Data port for default case** and **Diagnostic for default case**.

Note If the control input is larger than `intmax('int32')`, the block wraps the input value to an integer.

Behavior for Simulation

The following behavior applies only to simulation for your model.

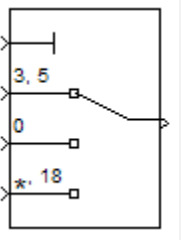
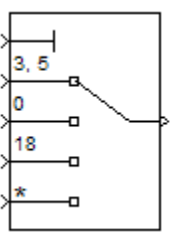
| Data Port for Default Case | Diagnostic for Default Case | | |
|---|---|---|--------------------------------------|
| | None | Warning | Error |
| Last data port  | Use the last data port and do not report any warning or error. | Use the last data port and report a warning. | Report an error and stop simulation. |
| Additional data port  | Use the additional data port with a * label and do not report any warning or error. | Use the additional data port with a * label and report a warning. | Report an error and stop simulation. |

Behavior for Code Generation

The following behavior applies to code generation for your model.

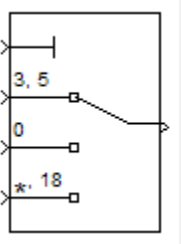
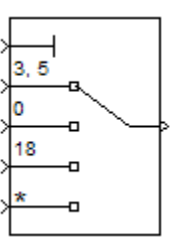
| Data Port for Default Case | Diagnostic for Default Case | | |
|--|--|--|--|
| | None | Warning | Error |
| Last data port  | Use the last data port. | Use the last data port. | Use the last data port. |
| Additional data port  | Use the additional data port with a * label. | Use the additional data port with a * label. | Use the additional data port with a * label. |

Use Data Inputs That Have Different Dimensions

If two signals have a different number of dimensions or different dimension lengths, you can use the signals as data inputs to a Multiport Switch block. In the block dialog box, select the parameter **Allow different data input sizes**. In this case, the output of the block is a variable-size signal. If you do not select this parameter, the block generates an error.

For more information about the parameter, see “Allow different data input sizes (Results in variable-size output signal)” on page 1-0 . For more information about variable-size signals, see “Variable-Size Signal Basics”.

Rules That Determine the Block Behavior

You specify the number of data inputs with **Number of data ports**.

- If you set **Number of data ports** to 1, the block behaves as an *index selector* or *index vector* and not as a multiport switch. For more details, see “Multiport Switch Configured as an Index Vector Block” on page 1-1137.
- If you set **Number of data ports** to an integer greater than 1, the block behaves as a multiport switch. The block output is the data input that corresponds to the value of the control input. If at least one of the data inputs is a vector, the block output is a vector. In this case, the block expands any scalar inputs to vectors.
- If all the data inputs are scalar, the output is a scalar.

Guidelines on Setting Parameters for Enumerated Control Port

When the control port on the Multiport Switch block is of enumerated type, follow these guidelines:

| Scenario | What to Do | Rationale |
|--|--|---|
| The enumerated type contains a value that represents invalid, out-of-range, or uninitialized values. | <ul style="list-style-type: none"> Set Data port order to Specify indices. Set Data port indices to use this value for the last data port. Set Data port for default case to Last data port. | This block configuration handles invalid values that the enumerated type explicitly represents. |
| The enumerated type contains only valid enumerated values. However, a data input port can get invalid values of enumerated type. | <ul style="list-style-type: none"> Set Data port for default case to Additional data port. | This block configuration handles invalid values that the enumerated type does not explicitly represent. |
| The enumerated type contains only valid enumerated values. Data input ports can never get invalid values of enumerated type. | <ul style="list-style-type: none"> Set Data port for default case to Last data port. Set Diagnostic for default case to None. | This block configuration avoids unnecessary diagnostic action. |
| The block does not have a data input port for every value of the enumerated type. | <ul style="list-style-type: none"> Set Data port for default case to Additional data port. | This block configuration handles enumerated values that do not have a data input port, along with invalid values. |

Limitations

- If the data inputs to the Multiport Switch block are buses, the element names of both buses must be the same. Using the same element names ensures that the output bus has the same element names no matter which input bus the block selects. To ensure that your model meets this requirement, use a bus object to define the buses and set the **Element name mismatch** diagnostic to error. See “Model Configuration Parameters: Connectivity Diagnostics” for more information.
- For arrays of buses, **Number of data ports** must be set to a value of 2 or greater.

Ports

Input

Port_1 – Control signal

scalar

The control signal can be of any data type that Simulink supports, including fixed-point and enumerated types. When the control input is not an integer value, the block truncates the value to an integer by rounding to zero.

For information on control signals of enumerated type, see “Guidelines on Setting Parameters for Enumerated Control Port” on page 1-1139.

For information on how the block handles the out-of-range condition, see “How the Block Handles an Out-of-Range Control Input” on page 1-1137.

Limitations

- If the control signal is numeric, the control signal cannot be complex.
- If the control signal is an enumerated signal, the block uses the value of the underlying integer to select a data port.
- If the underlying integer does not correspond to a data port, an error occurs.

Data Types: `single` | `double` | `half` | `int8` | `int16` | `int32` | `int64` | `uint8` | `uint16` | `uint32` | `uint64` | `Boolean` | `fixed point` | `enumerated`

1 – First data input

`scalar` | `vector` | `matrix` | N-D array

First data input, specified as a scalar, vector, matrix, or N-D array. All input data signals can be of any data type that Simulink supports.

- If all the data inputs are scalar, the output is scalar
- If at least one of the data inputs is a vector, the block output is a vector. In this case, the block expands any scalar inputs to vectors.
- If any two nonscalar signals have a different number of dimensions or different dimension lengths, select the **Allow different data input sizes** check box. For more information, see “Use Data Inputs That Have Different Dimensions” on page 1-1138
- If any data signal is of an enumerated type, all others must be of the same enumerated type.

Data Types: `single` | `double` | `half` | `int8` | `int16` | `int32` | `int64` | `uint8` | `uint16` | `uint32` | `uint64` | `Boolean` | `fixed point` | `enumerated` | `string`

2 – Second data input

`scalar` | `vector` | `matrix` | N-D array

Second data input, specified as a scalar, vector, matrix, or N-D array. All input data signals can be of any data type that Simulink supports.

- If all the data inputs are scalar, the output is scalar
- If at least one of the data inputs is a vector, the block output is a vector. In this case, the block expands any scalar inputs to vectors.
- If any two nonscalar signals have a different number of dimensions or different dimension lengths, select the **Allow different data input sizes** check box. For more information, see “Use Data Inputs That Have Different Dimensions” on page 1-1138
- If any data signal is of an enumerated type, all others must be of the same enumerated type.

Dependencies

To enable this port, set **Number of data ports** to an integer greater than 1.

Data Types: `single` | `double` | `half` | `int8` | `int16` | `int32` | `int64` | `uint8` | `uint16` | `uint32` | `uint64` | `Boolean` | `fixed point` | `enumerated` | `string`

N – Nth data input

scalar | vector | matrix | N-D array

Nth data input, specified as a scalar, vector, matrix, or N-D array. All input data signals can be of any data type that Simulink supports.

- If all the data inputs are scalar, the output is scalar
- If at least one of the data inputs is a vector, the block output is a vector. In this case, the block expands any scalar inputs to vectors.
- If any two nonscalar signals have a different number of dimensions or different dimension lengths, select the **Allow different data input sizes** check box. For more information, see “Use Data Inputs That Have Different Dimensions” on page 1-1138
- If any data signal is of an enumerated type, all others must be of the same enumerated type.

Dependencies

To enable the Nth input port, set **Number of data ports** to an integer value greater than or equal to N.

Data Types: single | double | half | int8 | int16 | int32 | int64 | uint8 | uint16 | uint32 | uint64 | Boolean | fixed point | enumerated | string

*** – Data port for out-of-range inputs**

scalar | vector | matrix | N-D array

Input data port for out-of-range control signal inputs, specified as a scalar, vector, matrix, or N-D array. All input data signals can be of any data type that Simulink supports. If any data signal is of an enumerated type, all others must be of the same enumerated type. If any two signals have a different number of dimensions or different dimension lengths, select the **Allow different data input sizes** check box. For more information, see “Use Data Inputs That Have Different Dimensions” on page 1-1138.

Dependencies

To create an additional data port for out-of-range control signal inputs, set **Data port for default case** to **Additional data port**. When you set **Data port for default case** to **Last data port**, the block uses the last data port for output when the control signal value does not match any data port indices.

Data Types: single | double | half | int8 | int16 | int32 | int64 | uint8 | uint16 | uint32 | uint64 | Boolean | fixed point | enumerated | bus

Output**Port_1 – Selected data input, based on control signal value**

scalar | vector | matrix | N-D array

The block outputs one of the data inputs, selected according to the control signal value. The output has the same dimensions as the corresponding data input. When you select the **Allow different data input sizes** check box, the output of the block is a variable size signal.

Data Types: single | double | half | int8 | int16 | int32 | int64 | uint8 | uint16 | uint32 | uint64 | fixed point | enumerated | string

Parameters

Main

Data port order — Type of ordering for data input ports

One-based contiguous | Zero-based contiguous | Specify indices

Specify the type of ordering for your data input ports.

- **Zero-based contiguous** — Block uses zero-based indexing for ordering contiguous data ports. This is the default value of the Index Vector block.
- **One-based contiguous** — Block uses one-based indexing for ordering contiguous data ports. This is the default value of the Multiport Switch block.
- **Specify indices** — Block uses noncontiguous indexing for ordering data ports.

Tips

- When the control port is of enumerated type, select **Specify indices**.
- If you select **Zero-based contiguous** or **One-based contiguous**, verify that the control port is not of enumerated type. This configuration is deprecated and produces an error. You can run the Upgrade Advisor on your model to replace each Multiport Switch block of this configuration with a block that explicitly specifies data port indices. See “Model Upgrades”.
- Avoid situations where the block contains unused data ports for simulation or code generation. When the control port is of fixed-point or built-in data type, verify that all data port indices are representable with that type. Otherwise, the following block behavior occurs.

| If the Block Has Unused Data Ports and Data Port Order Is: | The Block Produces: |
|--|---------------------|
| Zero-based contiguous or One-based contiguous | A warning |
| Specify indices | An error |

Dependencies

Selecting **Zero-based contiguous** or **One-based contiguous** enables the **Number of data ports** parameter.

Selecting **Specify indices** enables the **Data port indices** parameter.

Programmatic Use

Block Parameter: DataPortOrder

Type: character vector

Values: 'Zero-based contiguous' | 'One-based contiguous' | 'Specify indices'

Default: 'One-based contiguous' (Multiport Switch) 'Zero-based contiguous' (Index Vector)

Number of data ports — Number of data input ports

1 | 3 | integer between 1 and 65535

Specify the number of data input ports to the block. The total number of input ports is the number you specify, plus one for the control signal input port, and plus one more if you set **Data port for default case** to Additional data port.

Dependencies

To enable this parameter, set **Data port order** to Zero-based contiguous or One-based contiguous.

Programmatic Use

Block Parameter: Inputs

Type: character vector

Values: integer between 1 and 65536

Default: '3' (Multiport Switch) '1' (Index Vector)

Data port indices — Array of indices for data ports

{1,2,3} (default) | array of indices

Specify an array of indices for your data ports. The block icon changes to match the data port indices you specify.

Tips

- To specify an array of indices that correspond to all values of an enumerated type, enter the name of the type.

For example, `MyColors` is a valid entry if `MyColors` is the name of an enumerated type.

- To enter specific values of an enumerated type, use the `type_name.enumerated_name` format. Do not enter the underlying integer value.

For example, `{MyColors.Red, MyColors.Green, MyColors.Blue}` is a valid entry.

- To indicate that more than one value maps to a data port, use brackets.

For example, the following entries are both valid:

- `{MyColors.Red, MyColors.Green, [MyColors.Blue, MyColors.Yellow]}`
- `{[3,5],0,18}`
- If the control port is of fixed-point or built-in data type, the values for **Data port indices** must be representable with that type. Otherwise, an error appears at compile time to alert you to unused data ports.
- If the control port is of enumerated data type, the values for **Data port indices** must be enumerated values of that type.
- If **Data port indices** contains values of enumerated type, the control port must be of that data type.

Dependencies

To enable this parameter, set **Data port order** to Specify indices.

Programmatic Use

Block Parameter: DataPortIndices

Type: character vector

Values: array of indices

Default: '{1,2,3}'

Data port for default case — Port to use for out-of-range inputs

Last data port (default) | Additional data port

Specify whether to use the last data port for out-of-range inputs, or to use an additional port. An asterisk (*) next to the port name indicates the port the block uses when the control port value does not match any data port indices.

- **Last data port** — Block uses the last data port for output when the control port value does not match any data port indices.
- **Additional data port** — Block uses an additional data port for output when the control port value does not match any data port indices.

Tip

If you set this parameter to **Additional data port** and **Number of data ports** is 3, the number of input ports on the block is 5. The first input is the control port, the next three inputs are data ports, and the fifth input is the default port for out-of-range inputs.

Programmatic Use

Block Parameter: DataPortForDefault

Type: character vector

Values: 'Last data port' | 'Additional data port'

Default: 'Last data port'

Diagnostic for default case — Diagnostic action when control port value does not match data port indices

Error (default) | Warning | None

Specify the diagnostic action to take when the control port value does not match any data port indices.

- **None** — Produce no response.
- **Warning** — Display a warning and continue the simulation.
- **Error** — Terminate the simulation and display an error. In this case, the **Data port for default case** is used only for code generation and not simulation.

For more information, see “How the Block Handles an Out-of-Range Control Input” on page 1-1137.

Programmatic Use

Block Parameter: DiagnosticForDefault

Type: character vector

Values: 'None' | 'Warning' | 'Error'

Default: 'Error'

Sample time — Specify sample time as a value other than -1

-1 (default) | scalar | vector

Specify the sample time as a value other than -1. For more information, see “Specify Sample Time”.

Dependencies

This parameter is not visible unless it is explicitly set to a value other than -1. To learn more, see “Blocks for Which Sample Time Is Not Recommended”.

Programmatic Use

Block Parameter: SampleTime

Type: character vector

Values: scalar or vector

Default: '-1'

Signal Attributes

Require all data port inputs to have the same data type — Require all inputs to have the same data type

off (default) | on

Select this check box to require that all data input ports have the same data type. When you clear this check box, the block allows data port inputs to have different data types.

Programmatic Use

Block Parameter: InputSameDT

Type: character vector

Values: 'off' | 'on'

Default: 'off'

Output minimum — Minimum output value for range checking

[] (default) | scalar

Lower value of the output range that Simulink checks.

Simulink uses the minimum to perform:

- Parameter range checking (see “Specify Minimum and Maximum Values for Block Parameters”) for some blocks.
- Simulation range checking (see “Specify Signal Ranges” and “Enable Simulation Range Checking”).
- Automatic scaling of fixed-point data types.
- Optimization of the code that you generate from the model. This optimization can remove algorithmic code and affect the results of some simulation modes such as SIL or external mode. For more information, see “Optimize using the specified minimum and maximum values” (Embedded Coder).

Note Output minimum does not saturate or clip the actual output signal. Use the Saturation block instead.

Programmatic Use

Block Parameter: OutMin

Type: character vector

Values: '[]' | scalar

Default: '[]'

Output maximum — Maximum output value for range checking

[] (default) | scalar

Upper value of the output range that Simulink checks.

Simulink uses the maximum value to perform:

- Parameter range checking (see “Specify Minimum and Maximum Values for Block Parameters”) for some blocks.

- Simulation range checking (see “Specify Signal Ranges” and “Enable Simulation Range Checking”).
- Automatic scaling of fixed-point data types.
- Optimization of the code that you generate from the model. This optimization can remove algorithmic code and affect the results of some simulation modes such as SIL or external mode. For more information, see “Optimize using the specified minimum and maximum values” (Embedded Coder).

Note **Output maximum** does not saturate or clip the actual output signal. Use the Saturation block instead.

Programmatic Use

Block Parameter: OutMax

Type: character vector

Values: ' [] ' | scalar

Default: ' [] '

Output data type — Specify the output data type

Inherit: Inherit via internal rule (default) | Inherit: Inherit via back propagation | Inherit: Same as first data input | double | single | half | int8 | uint8 | int16 | uint16 | int32 | uint32 | int64 | uint64 | fixdt(1,16) | fixdt(1,16,0) | fixdt(1,16,2^0,0) | string | <data type expression>

Choose the data type for the output. The type can be inherited, specified directly, or expressed as a data type object such as `Simulink.NumericType`.

When you select an inherited option, the block behaves as follows:

- **Inherit: Inherit via internal rule**—Simulink chooses a data type to balance numerical accuracy, performance, and generated code size, while taking into account the properties of the embedded target hardware. If you change the embedded target settings, the data type selected by the internal rule might change. It is not always possible for the software to optimize code efficiency and numerical accuracy at the same time. If the internal rule doesn't meet your specific needs for numerical accuracy or performance, use one of the following options:
 - Specify the output data type explicitly.
 - Explicitly specify a default data type such as `fixdt(1,32,16)` and then use the Fixed-Point Tool to propose data types for your model. For more information, see `fxptdlg`.
 - To specify your own inheritance rule, use **Inherit: Inherit via back propagation** and then use a Data Type Propagation block. Examples of how to use this block are available in the Signal Attributes library Data Type Propagation Examples block.
- **Inherit: Inherit via back propagation** — Uses the data type of the driving block.
- **Inherit: Same as first data input** — Uses the data type of the first data input port.

Programmatic Use

Block Parameter: OutDataTypeStr

Type: character vector

Values: 'Inherit: Inherit via internal rule' | 'Inherit: Inherit via back propagation' | 'Inherit: Same as first input' | 'double' | 'single' | 'half' | 'int8'

| 'uint8' | 'int16' | 'uint16' | 'int32' | 'uint32' | 'int64' | 'uint64' | 'fixdt(1,16)' | 'fixdt(1,16,0)' | 'fixdt(1,16,2^0,0)' | 'string' | '<data type expression>'
Default: 'Inherit: Inherit via internal rule'

Lock output data type setting against changes by the fixed-point tools — Prevent fixed-point tools from overriding data types

off (default) | on

Select to lock the output data type setting of this block against changes by the Fixed-Point Tool and the Fixed-Point Advisor. For more information, see “Use Lock Output Data Type Setting” (Fixed-Point Designer).

Programmatic Use

Block Parameter: LockScale

Type: character vector

Values: 'off' | 'on'

Default: 'off'

Integer rounding mode — Specify the rounding mode for fixed-point operations

Floor (default) | Ceiling | Convergent | Nearest | Round | Simplest | Zero

Choose one of these rounding modes.

Ceiling

Rounds both positive and negative numbers toward positive infinity. Equivalent to the MATLAB `ceil` function.

Convergent

Rounds number to the nearest representable value. If a tie occurs, rounds to the nearest even integer. Equivalent to the Fixed-Point Designer `convergent` function.

Floor

Rounds both positive and negative numbers toward negative infinity. Equivalent to the MATLAB `floor` function.

Nearest

Rounds number to the nearest representable value. If a tie occurs, rounds toward positive infinity. Equivalent to the Fixed-Point Designer `nearest` function.

Round

Rounds number to the nearest representable value. If a tie occurs, rounds positive numbers toward positive infinity and rounds negative numbers toward negative infinity. Equivalent to the Fixed-Point Designer `round` function.

Simplest

Automatically chooses between round toward floor and round toward zero to generate rounding code that is as efficient as possible.

Zero

Rounds number toward zero. Equivalent to the MATLAB `fix` function.

Programmatic Use

Block Parameter: RndMeth

Type: character vector

Values: 'Ceiling' | 'Convergent' | 'Floor' | 'Nearest' | 'Round' | 'Simplest' | 'Zero'

Default: 'Floor'

See Also

For more information, see “Rounding” (Fixed-Point Designer).

Saturate on integer overflow — Method of overflow action

off (default) | on

Specify whether overflows saturate or wrap.

- off — Overflows wrap to the appropriate value that the data type can represent.

For example, the number 130 does not fit in a signed 8-bit integer and wraps to -126.

- on — Overflows saturate to either the minimum or maximum value that the data type can represent.

For example, an overflow associated with a signed 8-bit integer can saturate to -128 or 127.

Tip

- Consider selecting this check box when your model has a possible overflow and you want explicit saturation protection in the generated code.
 - Consider clearing this check box when you want to optimize efficiency of your generated code.

Clearing this check box also helps you to avoid overspecifying how a block handles out-of-range signals. For more information, see “Troubleshoot Signal Range Errors”.
 - When you select this check box, saturation applies to every internal operation on the block, not just the output or result.
 - In general, the code generation process can detect when overflow is not possible. In this case, the code generator does not produce saturation code.
-

Programmatic Use

Block Parameter: SaturateOnIntegerOverflow

Type: character vector

Values: 'off' | 'on'

Default: 'off'

Allow different data input sizes (Results in variable-size output signal) — Allow input signals with different sizes

off (default) | on

Select this check box to allow input signals with different sizes.

- On — Allows input signals with different sizes, and propagate the input signal size to the output signal. In this mode, the block produces a variable-size output signal.
- Off — Requires that all nonscalar data input signals be the same size.

Programmatic Use

Parameter: AllowDiffInputSizes

Type: character vector

Value: 'on' | 'off'

Default: 'off'

Block Characteristics

| | |
|---------------------------------|--|
| Data Types | Boolean bus double enumerated fixed point half integer single string |
| Direct Feedthrough | yes |
| Multidimensional Signals | yes |
| Variable-Size Signals | yes |
| Zero-Crossing Detection | no |

Extended Capabilities

C/C++ Code Generation

Generate C and C++ code using Simulink® Coder™.

HDL Code Generation

Generate Verilog and VHDL code for FPGA and ASIC designs using HDL Coder™.

HDL Coder provides additional configuration options that affect HDL implementation and synthesized logic.

HDL Architecture

This block has a single, default HDL architecture.

HDL Block Properties

| General | |
|----------------------------------|--|
| CodingStyle | Specify whether to generate HDL code with case statements or if-else statements. By default, HDL Coder generates if-else statements. See also "CodingStyle" (HDL Coder). |
| ConstrainedOutputPipeline | Number of registers to place at the outputs by moving existing delays within your design. Distributed pipelining does not redistribute these registers. The default is 0. For more details, see "ConstrainedOutputPipeline" (HDL Coder). |
| InputPipeline | Number of input pipeline stages to insert in the generated code. Distributed pipelining and constrained output pipelining can move these registers. The default is 0. For more details, see "InputPipeline" (HDL Coder). |
| OutputPipeline | Number of output pipeline stages to insert in the generated code. Distributed pipelining and constrained output pipelining can move these registers. The default is 0. For more details, see "OutputPipeline" (HDL Coder). |

| Native Floating Point | |
|------------------------|--|
| LatencyStrategy | Specify whether to map the blocks in your design to <code>inherit</code> , <code>Max</code> , <code>Min</code> , or <code>Zero</code> for the floating-point operator. The default is <code>inherit</code> . See also “LatencyStrategy” (HDL Coder). |

Complex Data Support

This block supports code generation for complex signals.

Using an Enumerated Type as Port Index

You can set **Data port order** to **Specify indices**, and enter enumeration values for the **Data port indices**. For example, you can connect the Enumerated Constant block to the Multiport Switch control port and use the enumerated types as data port indices.

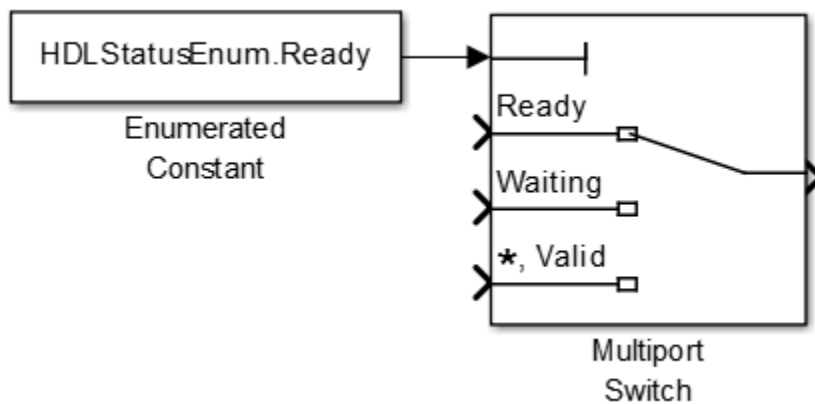

PLC Code Generation

Generate Structured Text code using Simulink® PLC Coder™.

Fixed-Point Conversion

Design and simulate fixed-point systems using Fixed-Point Designer™.

See Also

Index Vector | Switch

Topics

“Variable-Size Signal Basics”

Introduced before R2006a

MultiStateImage

Display image reflecting input value

Library: Simulink / Dashboard



Description

The MultiStateImage block displays an image to indicate the value of the input signal. You can use the MultiStateImage block with other Dashboard blocks to build an interactive dashboard of controls and indicators for your model. You can specify pairs of input values and images to provide the information you want during simulation.

Connect Dashboard Blocks

Dashboard blocks do not use ports to connect to model elements. To connect dashboard blocks to signals in your model, use connect mode. Connect mode facilitates the process of connecting dashboard blocks in your model, especially when you want to connect multiple blocks at once. To connect a single dashboard block, you can also use the **Connection** table in the block dialog box.

Tip You can modify dashboard block connections during normal and accelerator mode simulations.

To enter connect mode, select a dashboard block to connect. Then, on the block tab, click **Connect**. In connect mode, when you select one or more signals or blocks, a list of signals that are available for connection appears. Select a signal from the list to connect to the selected dashboard block. To connect another dashboard block, pause on the block you want to connect and click the **Connect** button above it. Then, select one or more signals and blocks in the model and choose a signal to connect.

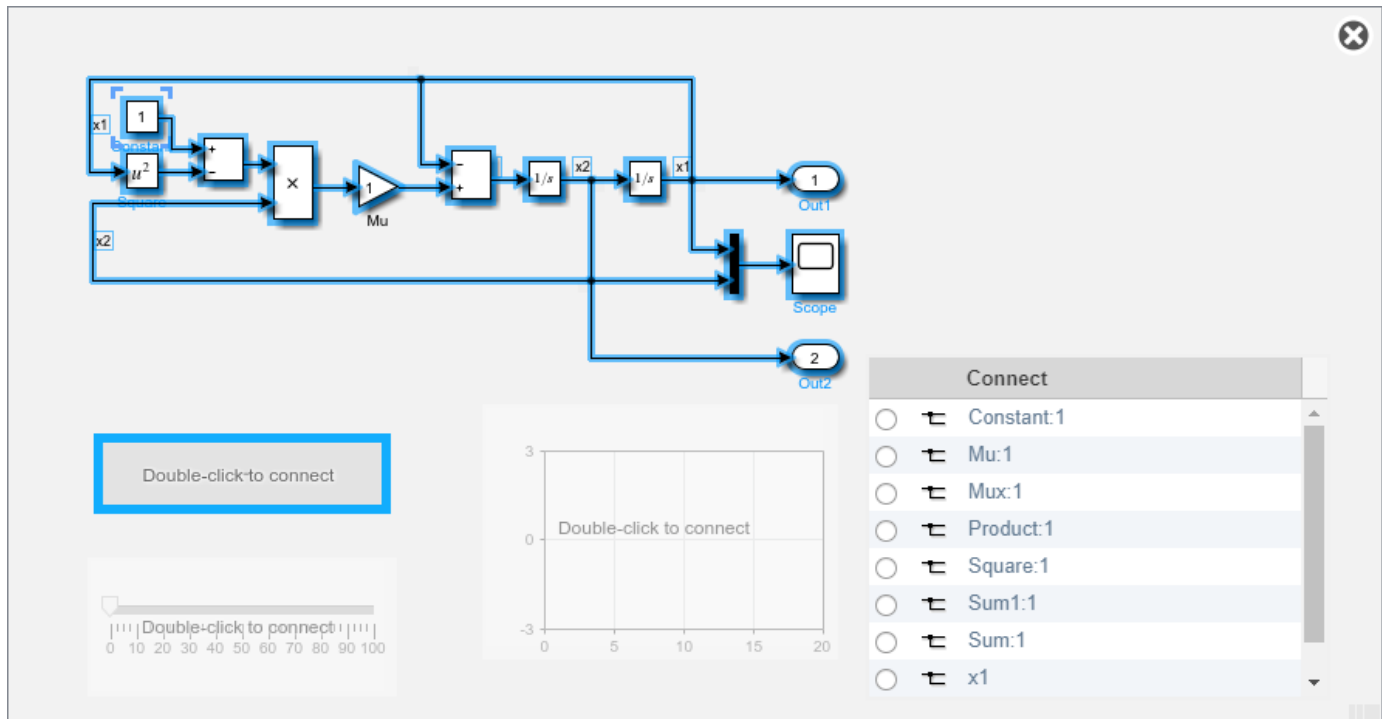

When you finish connecting the dashboard blocks in your model, on the block tab, click **Done Connecting**.

Tip You can hide the message shown on unconnected blocks using the `set_param` function with the `ShowInitialText` block parameter. The message also disappears when you connect the block.

Limitations

- Except for the Dashboard Scope block and the Display block, dashboard blocks can only connect to real scalar signals.
- The toolstrip does not support blocks that are inside a panel.
- You cannot use the **Connection** table in the block dialog to connect a dashboard block to a block that is commented out. When you connect a dashboard block to a commented block using connect mode, the dashboard block does not display the connected value until the you uncomment the block.
- Dashboard blocks cannot connect to model elements inside referenced models.
- When you simulate a model hierarchy, dashboard blocks inside referenced models do not update.
- Dashboard blocks do not support rapid accelerator simulation.
- You cannot connect a dashboard block to data or activity in Stateflow during simulation.
- Some signals do not have data available during simulation due to block reduction or optimization for accelerator mode simulations. To view such a signal using a dashboard block, mark the signal for logging.

Parameters

Connection — Signal to connect and display

signal connection options

Use the connection table to select the signal to connect to the block. To connect the block to a signal:

- 1 Make a selection in the model that includes one or more signals.
- 2 In the table, select the signal you want to connect.
- 3 Click **Apply**.

Tip You can connect dashboard blocks to signals in the model during simulation.

Programmatic Use

Block Parameter: Binding

Type: Simulink.HMI.SignalSpecification

Default: []

Scale Mode — Specify how to scale image

Fill with fixed aspect ratio (default) | Fixed | Fill

Specify how to scale the image.

Fill with fixed Aspect Ratio scales the image to the size of the block while retaining its original aspect ratio.

Fixed displays the image with its fixed true size.

Fill adjusts the image to fill the block.

Programmatic Use

Block Parameter: ScaleMode

Type: string or character vector

Values: 'Fill with fixed aspect ratio' | 'Fixed' | 'Fill'

Default: 'Fill with fixed aspect ratio'

States — Match values with images to display

scalar and image

States match an image to display with a value of the connected variable or parameter. Each state consists of a **State** and an image, displayed as a **Thumbnail** in the **States** table for the MultiStateImage block.

- **State** — Connected variable or parameter value that causes the MultiStateImage block to display the corresponding image.
- **Thumbnail** — Image to display when the connected variable or parameter value matches the corresponding **State**.

Click the + button to add another state.

Programmatic Use

To programmatically configure `State` and `Thumbnail` parameter values for the `MultiStateImage` block, use the `States` parameter. Specify the value for the `States` parameter as an array of structures with the fields:

- `State` — State value.
- `Size` — 1-by-2 vector containing the width and height for the image in that order, in pixels, specified as a `uint64`.
- `Image` — Character array of Base64 encoded image data.
- `Thumbnail` — Character array of Base64 encoded image data for the thumbnail image to display in the **States** table in the block dialog.

Include a structure in the array for each state you want to specify for the block. In the example, the `myBase64Image` and `myBase64Thumbnail` variables contain character vectors of the Base64 image data for the block image and thumbnail..

```
state1.State = 1;
state1.Size = [uint64(400) uint64(400)];
state1.Image = myBase64Image;
state1.Thumbnail = myBase64Thumbnail;
state2.State = 2;
state2.Size = [uint64(400) uint64(400)];
state1.Image = myBase64Image2;
state1.Thumbnail = myBase64Thumbnail2;
msiStates = [state1 state2];
```

Block Parameter: States

Type: structure array

The block displays the default image when the connected signal value does not correspond to any of the specified states. Specify the `DefaultImage` parameter as a structure containing the fields:

- `Size` — 1-by-2 vector containing the width and height for the image in that order, in pixels, specified as `uint64`.
- `Image` — Character array of Base64 encoded image data.
- `Thumbnail` — Character array of Base64 encoded image data for the thumbnail image to display in the **States** table in the block dialog.

Block Parameter: DefaultImage

Type: structure

Label — Block label position

Top (default) | Bottom | Hide

Position of the block label. When the block is connected to an element in the model, the label is the name of the connected element.

Programmatic Use

Block Parameter: `LabelPosition`

Type: character vector

Values: 'Top' | 'Bottom' | 'Hide'

Default: 'Top'

Block Characteristics

| | |
|---------------------------------|---|
| Data Types | Boolean double enumerated fixed point half integer single |
| Direct Feedthrough | no |
| Multidimensional Signals | no |
| Variable-Size Signals | no |
| Zero-Crossing Detection | no |

Extended Capabilities

C/C++ Code Generation

Generate C and C++ code using Simulink® Coder™.

Dashboard blocks are ignored for code generation.

See Also

Lamp

Topics

“Tune and Visualize Your Model with Dashboard Blocks”

“Decide How to Visualize Simulation Data”

Introduced in R2016b

Mux

Combine input signals of same data type and complexity into virtual vector

Library: Simulink / Commonly Used Blocks
 Simulink / Signal Routing
 HDL Coder / Commonly Used Blocks
 HDL Coder / Signal Routing



Description

The Mux block combines inputs with the same data type and complexity into a vector output. The output mux signal is flat, even if you create the mux signal from other mux signals. However, you can use multiple Mux blocks to create a mux signal in stages.

A mux signal simplifies the visual appearance of a model by combining two or more signal lines into one line. Mux signals do not affect simulation or code generation.

Tip If inputs have different data types or complexity, use a Bus Creator block to visually group the signals in a virtual bus. For more information, see “Types of Composite Signals”.

Ports

Input

Port_1 — Input signal to include in mux signal

scalar | vector

Input signal to include in the mux signal, specified as a scalar or vector.

The input signals for a Mux block can be any combination of scalars and vectors, but they must have the same data type and complexity.

Data Types: single | double | half | int8 | int16 | int32 | int64 | uint8 | uint16 | uint32 | uint64 | Boolean | fixed point | enumerated

Output

Port_1 — Output mux signal

vector

Output mux signal composed of the combined input signals, returned as a vector.

The elements of the output mux signal take their order from the port order of the input signals. For a description of the port order for various block orientations, see “Port Location After Rotating or Flipping”.

Data Types: single | double | half | int8 | int16 | int32 | int64 | uint8 | uint16 | uint32 | uint64 | Boolean | fixed point | enumerated

Parameters

Number of inputs — Number of input signals

2 (default) | scalar | vector | cell array | comma-separated list of signal names

The number of input signals, specified as a scalar, vector, cell array, or comma-separated list of signal names. Some of these formats allow you to specify the signal names and sizes, as described by the following table.

| Format | Block Behavior |
|--------------------------------------|---|
| Scalar | The number of inputs to the Mux block. When you use this format, the block accepts scalar or vector signals of any size. Simulink assigns each input the name <code>signalN</code> , where N is the input port number. |
| Vector | The length of the vector specifies the number of inputs. Each element specifies the size of the corresponding input. A positive value specifies that the corresponding port can accept only vectors of that size. For example, <code>[2 3]</code> specifies two input ports of sizes 2 and 3, respectively. If an input signal width does not match the expected width, an error message appears. A value of -1 specifies that the corresponding port can accept scalars or vectors of any size. |
| Cell array | The length of the cell array specifies the number of inputs. The value of each cell specifies the size of the corresponding input. A scalar value N specifies a vector of size N. A value of -1 means that the corresponding port can accept scalar or vector signals of any size. |
| Comma-separated list of signal names | A list of signal names separated by commas. Simulink assigns each name to the corresponding port and signal. For example, if you enter <code>position, velocity</code> , the Mux block has two inputs, named <code>position</code> and <code>velocity</code> . |

Tip If you specify a scalar for the **Number of inputs** parameter and all of the input ports are connected, as you draw a new signal line close to input side of a Mux block, Simulink adds a port and updates the parameter.

Programmatic Use

Block Parameter: Inputs

Type: scalar, vector, cell array, comma-separated list of signal names

Values: integer, vector of port sizes, cell array, comma-separated list of signal names

Default: '2'

Display option — Block icon appearance

bar (default) | signal | none

Block icon appearance, specified as `bar`, `signal`, or `none`.

- `bar` — Displays no text
- `signal` — Displays the input signal names
- `none` — Displays the type of block (Mux)

Resize the block as necessary to fit the text on the block icon.

Programmatic Use

Block Parameter: `DisplayOption`

Type: character vector

Values: `'bar'` `'signals'` `'none'` `'bar'`

Default: `'bar'`

Block Characteristics

| | |
|---------------------------------|---|
| Data Types | Boolean double enumerated fixed point half integer single |
| Direct Feedthrough | yes |
| Multidimensional Signals | no |
| Variable-Size Signals | no |
| Zero-Crossing Detection | no |

Extended Capabilities

C/C++ Code Generation

Generate C and C++ code using Simulink® Coder™.

Actual data type or capability support depends on block implementation.

HDL Code Generation

Generate Verilog and VHDL code for FPGA and ASIC designs using HDL Coder™.

HDL Coder provides additional configuration options that affect HDL implementation and synthesized logic.

HDL Architecture

This block has a single, default HDL architecture.

HDL Block Properties

| | |
|----------------------------------|--|
| ConstrainedOutputPipeline | Number of registers to place at the outputs by moving existing delays within your design. Distributed pipelining does not redistribute these registers. The default is 0. For more details, see “ConstrainedOutputPipeline” (HDL Coder). |
| InputPipeline | Number of input pipeline stages to insert in the generated code. Distributed pipelining and constrained output pipelining can move these registers. The default is 0. For more details, see “InputPipeline” (HDL Coder). |

| | |
|-----------------------|--|
| OutputPipeline | Number of output pipeline stages to insert in the generated code. Distributed pipelining and constrained output pipelining can move these registers. The default is 0. For more details, see “OutputPipeline” (HDL Coder). |
|-----------------------|--|

Complex Data Support

This block supports code generation for complex signals.

Restrictions

Buses are not supported for HDL code generation.

PLC Code Generation

Generate Structured Text code using Simulink® PLC Coder™.

Fixed-Point Conversion

Design and simulate fixed-point systems using Fixed-Point Designer™.

Actual data type or capability support depends on block implementation.

See Also

Demux | Vector Concatenate | Bus Creator | Bus to Vector

Topics

“Types of Composite Signals”

Introduced before R2006a

Out Bus Element, Bus Element Out

Specify output that connects to external port

Library: Simulink / Ports & Subsystems
 Simulink / Sinks
 HDL Coder / Ports & Subsystems
 HDL Coder / Sinks

 OutBus.signal1

Description

The Out Bus Element block, also known as the Bus Element Out block, combines the functionality of an Outport block and a Bus Creator block. This block is of the Outport block type and all Out Bus Element blocks that use the same port share a dialog box.

The output of an Out Bus Element is a bus, regardless of the number and type of signals connected to it. You must connect an Out Bus Element block to each signal that you want the bus to contain.

Create Port and Related Blocks

When you insert an Out Bus Element block, the block label populates with default values. The label consists of two interactive text fields: the port name and the bus element. To change the name of the port associated with the block, edit the first text field in the label by clicking the text.

 OutBus.signal1

To output multiple signals in a bus, create one Out Bus Element block for each signal that you want to include in the bus. In the Block Parameters dialog box, you can select the **Add a new signal**  or

Add a new sub-bus  buttons. Alternatively, hold **Ctrl** while you drag an existing Out Bus Element block to a new location. Upon releasing the mouse, click **Use Existing Port**.

If multiple blocks are associated with the same port and you change the name of the port, all blocks that share the port update to reflect the new port name.

To create a port, hold **Ctrl** while you drag an existing Out Bus Element block to a new location. Upon releasing the mouse, click **Create New Port**.

Modify Port Output

In the Block Parameters dialog box, you can:

- Change port and element names.
- Reorder bus elements by dragging and dropping an element in the list of elements.
- Remove blocks associated with selected elements by clicking the **Remove blocks of selected signals** button .

Specify Element Name

To change the name of the bus element associated with the block, edit the second text field in the label by clicking the text.

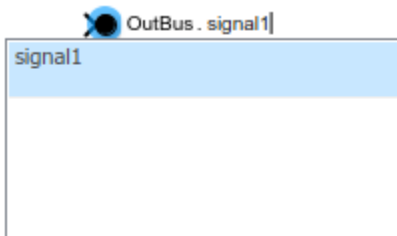

Tip To pass the block input to the external output port without nesting it in a bus, delete the text from the second text field in the label.

All element names associated with the port must be unique. You cannot specify the same element name more than once for a port. Simulink does not support overlapping writes to the same port.

To create hierarchy in the output bus, use dots in the part of the label that describes the bus element. Each dot indicates a new level of bus hierarchy.

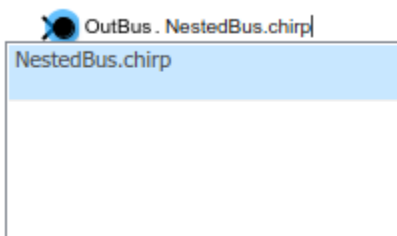

To reduce the size of the label, you can display only the element name by selecting the block, pausing on the ellipsis, and selecting **Compact Notation** from the action bar. To show the bus hierarchy again, select **Expanded Notation** from the action bar.



Log Output Data

When you save output data to the workspace or a file, bus data defined by groups of root-level Out Bus Element blocks are logged along with root-level Outport block data.

Ports

Input

Port_1 – Full or partial output for external port

signal | message

Full or partial output that is associated with an external subsystem or model port.

- When multiple Out Bus Element blocks are associated with the same external port, the input to this block is an element of the bus at the output port. The second text field in the label specifies the element name.
- When one Out Bus Element block is associated with the external port, the input to this block is passed directly to the output port or nested in a bus at the output port. To pass the input of the block to the output port without nesting it in a bus, delete the text from the second text field in the label.

Data Types: `single` | `double` | `half` | `int8` | `int16` | `int32` | `int64` | `uint8` | `uint16` | `uint32` | `uint64` | `string` | `Boolean` | `fixed point` | `enumerated` | `bus`

Parameters

Port name — Name of output port

`OutBus` (default) | port name

Specify a port name that is not already in use by another block or port. The name appears on the parent Subsystem or Model block. The name also appears next to the block. Multiple blocks can access the same port.

Programmatic Use

Block Parameter: `PortName`

Type: character vector

Values: `'OutBus'` | `'<port name>'`

Default: `'OutBus'`

Port number — Position of port on parent block

1 (default) | real integer

Specify the order in which the port that corresponds to the block appears on the parent Subsystem or Model block.

- If you add a block that creates another port, the port number is the next available number.
- Deleting all blocks associated with a port deletes the port. Other ports are renumbered so that they are sequential and do not skip any numbers.
- Specifying a port number that exceeds the number of ports creates a port for that number and for any skipped sequential numbers.

Programmatic Use

Block Parameter: `Port`

Type: character vector

Values: real integer

Default: `'1'`

Set color — Specify block background color

`Black` (default) | `White` | `Red` | `Green` | `Blue` | `Cyan` | `Magenta` | `Yellow` | `Gray` | `Light Blue` | `Orange` | `Dark Green` | `More Colors`

Specify the block background color. This specification sets the color of blocks associated with selected bus elements, or of all blocks associated with the port if you do not select any bus elements.

Programmatic Use

Block Parameter: `BackgroundColor`

Type: character vector

Values: 'black' | 'white' | 'red' | 'green' | 'blue' | 'cyan' | 'magenta' | 'yellow' | 'gray' | 'lightBlue' | 'orange' | 'darkGreen' | '[r,g,b]' where r, g, and b, are the red, green, blue values of the color in the range 0.0 to 1.0

Default: 'black'

Filter — Filter set of displayed signals

text

Specify a search term to use for filtering a long list of bus elements. Do not enclose the search term in quotation marks. The filter does a partial string search and supports regular expressions. To use a regular expression character as a literal, include an escape character (\). For example, to use a question mark, type sig\?1.

Attributes

To specify attributes, click the pencil button or nondefault attribute summary next to the name of a bus or bus element.

Data type — Data type

Inherit: auto (default) | double | single | half | int8 | uint8 | int16 | uint16 | ...

The data type can be inherited, specified directly, or expressed as a data type object such as a Simulink.NumericType object.

You can specify any of these options:

- Inherited data type
- Built-in Simulink data type — For example, specify single or uint8. See “Data Types Supported by Simulink”.
- Fixed-point data type — Use the fixdt function. For example, specify fixdt(1,16,0).
- Enumerated data type — Use the name of the type preceded by Enum:. For example, specify Enum: myEnumType.
- Bus data type — Use the name of the Simulink.Bus object preceded by Bus:. For example, specify Bus: myBusObject.
- Value type — Use the name of the Simulink.ValueType object preceded by ValueType:. For example, specify ValueType: windVelocity.
- Custom data type — Use a MATLAB expression that specifies the type. For example, you can specify a Simulink.NumericType object whose DataTypeMode property is set to a value other than 'Fixed-point: unspecified scaling'.

When you specify a Simulink.ValueType or Simulink.Bus object, the object defines more than the data type. The object also defines properties such as **Min**, **Max**, and **Unit**. The property values specified by the ValueType object override the corresponding property values specified by a block. For example, suppose a block sets **Unit** to ft/s. When the **Data type** of the block specifies a ValueType object that has m/s as its unit, the block uses m/s instead of ft/s.

Programmatic Use

Block Parameter: OutDataTypeStr

Type: character vector

Values: 'Inherit: auto' | 'double' | 'single' | 'half' | 'int8' | 'uint8' | 'int16' | 'uint16' | 'int32' | 'uint32' | 'int64' | 'uint64' | 'boolean' | 'fixdt(1,16)' |

'fixdt(1,16,0)' | 'fixdt(1,16,2^0,0)' | 'string' | 'Enum: <class name>' | 'Bus: <object name>' | 'ValueType: <object name>' | '<data type expression>'
Default: 'Inherit: auto'

Data mode — Data mode of bus elements

inherit (default) | signal | message

Specify the data mode of the elements of the bus.

- inherit — Bus elements inherit their data modes.
- signal — Bus elements must be signals.
- message — Bus elements must be messages.

For the In Bus Element block, if you choose `message` as the data mode, an envelope button appears next to the bus or bus element. Use the envelope button to specify custom queue properties for each message element. The Out Bus Element block does not support queue specifications.

Dependencies

To enable this parameter, the block must be at the top level of a model.

Programmatic Use

Block Parameter: DataMode

Type: character vector

Values: 'inherit' | 'signal' | 'message'

Default: 'inherit'

Bus virtuality — Virtual or nonvirtual bus

inherit (default) | virtual | nonvirtual

Specify whether to inherit the bus virtuality or define the bus as virtual or nonvirtual. For more information, see “Types of Composite Signals”.

This parameter determines whether the blocks inherit or define the bus virtuality. If the blocks define the bus virtuality and the virtuality of the input bus does not match, compiling the model produces an error.

Dependencies

To enable this parameter, set **Data type** to a Bus object.

Programmatic Use

Block Parameter: BusVirtuality

Type: character vector

Values: 'inherit' | 'virtual' | 'nonvirtual'

Default: 'inherit'

Dimensions — Signal dimensions

-1 (default) | integer | [integer, integer]

Specify the dimensions of a signal.

- -1 — The signal can have any dimensions.
- N — The signal must be a vector of size N.

- [R C] — The signal must be a matrix having R rows and C columns.

Programmatic Use**Block Parameter:** PortDimensions**Type:** character vector**Values:** '-1' | integer | [integer, integer]**Default:** '-1'**Dims mode — Option to allow only variable-size or fixed-size signals**

Inherit (default) | Fixed | Variable

Specify the type of signals allowed.

- Inherit — Allow variable-size and fixed-size signals.
- Variable — Allow only variable-size signals.
- Fixed — Allow only fixed-size signals. Do not allow variable-size signals.

When the signal is variable-sized, the **Dimensions** parameter specifies the maximum dimensions of the signal.

Programmatic Use**Parameter:** VarSizeSig**Type:** character vector**Value:** 'Inherit' | 'No' | 'Yes'**Default:** 'Inherit'**Unit — Physical unit**

inherit (default) | <Enter unit>

Specify the physical unit of the signal. For a list of supported units, see Allowed Unit Systems.

Programmatic Use**Block Parameter:** Unit**Type:** character vector**Values:** 'inherit' | '<Enter unit>'**Default:** 'inherit'**Sample time — Sample time**

-1 (default) | scalar

Specify the discrete interval between sample time hits or specify another appropriate sample time such as continuous or inherited.

By default, the signal inherits its sample time. To set a different sample time, enter a valid sample time based on the table in “Types of Sample Time”.

Programmatic Use**Block Parameter:** SampleTime**Type:** character vector**Values:** scalar**Default:** '-1'**Complexity — Numeric type**

auto (default) | real | complex

Specify the numeric type of the signal. To choose the numeric type of the signal, select `auto`. Otherwise, choose a real or complex signal type.

Programmatic Use**Block Parameter:** `SignalType`**Type:** character vector**Values:** `'auto' | 'real' | 'complex'`**Default:** `'auto'`**Minimum — Minimum value**`[]` (default) | scalar

Lower value of the range that Simulink checks.

This number must be a finite real double scalar value.

Simulink software uses this value to perform:

- Simulation range checking (see “Specify Signal Ranges”).
- Automatic scaling of fixed-point data types.
- Optimization of the code that you generate from the model. This optimization can remove algorithmic code and affect the results of some simulation modes such as SIL or external mode. For more information, see “Optimize using the specified minimum and maximum values” (Embedded Coder).

Programmatic Use**Block Parameter:** `OutMin`**Type:** character vector**Values:** `'[]' | scalar`**Default:** `'[]'`**Maximum — Maximum value**`[]` (default) | scalar

Upper value of the range that Simulink checks.

This number must be a finite real double scalar value.

Simulink software uses this value to perform:

- Simulation range checking (see “Specify Signal Ranges”).
- Automatic scaling of fixed-point data types.
- Optimization of the code that you generate from the model. This optimization can remove algorithmic code and affect the results of some simulation modes such as SIL or external mode. For more information, see “Optimize using the specified minimum and maximum values” (Embedded Coder).

Programmatic Use**Block Parameter:** `OutMax`**Type:** character vector**Values:** `'[]' | scalar`**Default:** `'[]'`**Description — Description of bus or bus elements**

no default

Use the description to document information about the bus or bus element, such as where it is used. This information does not affect Simulink processing.

Programmatic Use

Block Parameter: Description

Type: character vector

Values: '' | '<Enter text>'

Default: ''

Block Characteristics

| | |
|---------------------------------|--|
| Data Types | Boolean bus double enumerated fixed point half integer single string |
| Direct Feedthrough | no |
| Multidimensional Signals | yes |
| Variable-Size Signals | yes |
| Zero-Crossing Detection | no |

Extended Capabilities

C/C++ Code Generation

Generate C and C++ code using Simulink® Coder™.

HDL Code Generation

Generate Verilog and VHDL code for FPGA and ASIC designs using HDL Coder™.

This block can be used to simplify the Subsystem bus interfaces when you use the block in subsystems that generate HDL code, but is not included in the hardware implementation.

To learn more about using buses for HDL code generation, see “Buses” (HDL Coder) and “Use Bus Signals to Improve Readability of Model and Generate HDL Code” (HDL Coder).

Fixed-Point Conversion

Design and simulate fixed-point systems using Fixed-Point Designer™.

See Also

In Bus Element | Bus Creator | Outport

Topics

“Simplify Subsystem and Model Interfaces with Buses”

“Types of Composite Signals”

“Group Signal Lines into Virtual Buses”

Introduced in R2017a

Outputport

Create output port for subsystem or external output

Library: Simulink / Commonly Used Blocks
Simulink / Ports & Subsystems
Simulink / Sinks
HDL Coder / Commonly Used Blocks
HDL Coder / Ports & Subsystems
HDL Coder / Sinks



Description

Outputport blocks link signals from a system to a destination outside of the system. They can connect signals flowing from a subsystem to other parts of the model. They can also supply external outputs at the top level of a model hierarchy.

Outputport block port numbers are assigned according to these rules:

- Outputport blocks within a root-level system or subsystem are numbered sequentially, starting with 1.
- If you add an Outputport block, it is assigned the next available number.
- If you delete an Outputport block, other port numbers are automatically renumbered to ensure that the Outputport blocks are in sequence and that no numbers are omitted.

Outputport Blocks in a Subsystem

Outputport blocks in a subsystem represent outputs from the subsystem. A signal arriving at an Outputport block in a subsystem flows out of the associated output port on that Subsystem block. The Outputport block associated with an output port is the block whose **Port number** parameter matches the relative position of the output port on the Subsystem block. For example, the Outputport block whose **Port number** parameter is 1 sends its signal to the block connected to the topmost output port on the Subsystem block.

If you renumber the **Port number** of an Outputport block, the block becomes connected to a different output port. The block continues to send the signal to the same block outside the subsystem.

You can directly edit port labels on a Subsystem block. For more information, see “Edit Port Labels on Subsystems”.

Tip For models that include buses composed of many bus elements, consider using In Bus Element and Out Bus Element blocks. These blocks:

- Reduce signal line complexity and clutter in a block diagram.
- Make it easier to change the interface incrementally.
- Allow access to a bus element closer to the point of usage, avoiding the use of a Bus Selector and Goto block configuration.

The In Bus Element block is of block type Inport and the Out Bus Element block is of block type Output.

Top-Level Output Block in a Model Hierarchy

Output blocks at the top level of a model hierarchy have two uses. They can supply external outputs to the base MATLAB workspace, and they provide a means for the `linmod` and `trim` analysis functions to obtain output from the system.

To supply external outputs to the workspace, use the **Configuration Parameters > Data Import/Export** pane (see Exporting Output Data to the MATLAB Workspace) or the `sim` command. For example, if a system has more than one Output block and the save format is array, the following command

```
[t,x,y] = sim(...);
```

writes `y` as a matrix, with each column containing data for a different Output block. The column order matches the order of the port numbers for the Output blocks.

If you specify more than one variable name after the second (state) argument, data from each Output block is written to a different variable. For example, if the system has two Output blocks, to save data from Output block 1 to `speed` and the data from Output block 2 to `dist`, specify this command:

```
[t,x,speed,dist] = sim(...);
```

Connecting Buses to Root-Level Outputs

A root-level Output block in a model can accept a virtual bus only if all elements of the bus have the same data type. The Output block automatically unifies the bus to a vector having the same number of elements as the bus, and provides that vector as output.

If you want a root-level Output block of a model to accept a bus that contains mixed types, set the Output block **Data type** to `Bus: <object name>`. If the bus is virtual, it is converted to nonvirtual, as described in “Virtual and Nonvirtual Bus Conversions”.

Associate Root-Level Output Block with Simulink.Signal Object

To associate a root-level Output block with a `Simulink.Signal` object, use the Model Data Editor. See “For Signals”.

Ports

Input

Port_1 — Output signal

scalar | vector

Input signal that flows through the output to an external subsystem or model.

An Output block can accept fixed-point and enumerated data types when the block is not a root-level output port. The complexity and data type of the block output are the same as its input.

Data Types: `half` | `single` | `double` | `int8` | `int16` | `int32` | `int64` | `uint8` | `uint16` | `uint32` | `uint64` | `string` | `Boolean` | `fixed point` | `enumerated` | `bus`

Parameters

Main

Port number — Position of port on parent block

1 (default) | real integer

Specify the order in which the port that corresponds to the block appears on the parent Subsystem or Model block.

- If you add a block that creates another port, the port number is the next available number.
- Deleting all blocks associated with a port deletes the port. Other ports are renumbered so that they are sequential and do not skip any numbers.
- Specifying a port number that exceeds the number of ports creates a port for that number and for any skipped sequential numbers.

Programmatic Use

Block Parameter: Port

Type: character vector

Values: real integer

Default: '1'

Signal name — Signal name

' ' (default) | character vector

Specify the name of the corresponding signal data in the generated code. Use this parameter to specify a name for the signal data when you apply a storage class to a root-level Outport block.

Programmatic Use

Block Parameter: SignalName

Type: character vector

Values: character vector

Default: ' '

Icon display — Icon display

Port number (default) | Signal name | Port number and signal name

Specify the information displayed on the block icon.

Programmatic Use

Block Parameter: IconDisplay

Type: character vector

Values: 'Signal name' | 'Port number' | 'Port number and signal name'

Default: 'Port number'

Specify output when source is disconnected — Specify unconnected output value

off (default) | on

Specify a constant output value for when source is not connected.

Dependency

Available for unconnected Outport blocks inside a Variant Subsystem block.

Programmatic Use**Block Parameter:** OutputWhenUnconnected**Type:** character vector**Values:** 'on' | 'off'**Default:** 'off'**Constant value — Output value when the block is not connected**

0 (default) | scalar | vector

Specify a constant output value for when source is not connected.

Dependency

Available in a Variant Subsystem block for an unconnected Outport block with **Specify output when source is unconnected** selected.

Programmatic Use**Block Parameter:** OutputWhenUnconnectedValue**Type:** character vector**Values:** scalar | vector**Default:** '0'**Interpret vector parameters as 1-D — Treat vectors as 1-D**

on (default) | off

Select this check box to create a vector of length N at the output if the **Constant value** parameter evaluates to an N-element row or column vector.

Dependency

Available in a Variant Subsystem block on an unconnected Outport block when you select the **Specify output when source is unconnected** parameter.

Programmatic Use**Block Parameter:** VectorParamsAs1DForOutWhenUnconnected**Type:** character vector**Values:** 'on' | 'off'**Default:** 'on'**Ensure output is virtual — Ensure that output is virtual**

off (default) | on

Clear this parameter to allow Simulink to use a signal buffer on output port. This buffer, which is the equivalent of a Signal Copy block but is not displayed on the canvas, ensures consistent initialization of the Outport block signal.

If you select this parameter, Simulink tries to remove the signal buffer.

- If the signal buffer is not needed, Simulink removes the buffer.
- If the signal buffer is needed for data consistency and proper execution, Simulink displays an error indicating the buffer could not be removed.

Allow partial writes through Assignment blocks.

For more information regarding this parameter, including examples with conditional writes and partial writes, see “Ensure Output is Virtual”.

Dependency

This parameter applies to these blocks:

- Conditional subsystem
- Assignment
- Merge
- Model with root Output block

Programmatic Use

Block Parameter: EnsureOutputIsVirtual

Type: character vector

Values: 'on' | 'off'

Default: 'off'

Source of initial output value — Source of initial output value

Dialog (default) | Input signal

Select the source of the initial output value of the block. Select `Dialog` to specify that the initial output value is the value of the **Initial output** parameter. Select `Input signal` to specify that the initial output value is inherited from the input signal. See “Conditional Subsystem Initial Output Values”.

Tips

- If you are using classic initialization mode, selecting `Input signal` causes an error. To inherit the initial output value from the input signal, set this parameter to `Dialog` and specify `[]` (empty matrix) for the **Initial output** value. For more information, see “Conditional Subsystem Initial Output Values”.

Dependencies

Available for Output blocks inside a conditional subsystem.

Selecting `Dialog` exposes the following parameters:

- **Output when disabled**
- **Initial output**

Programmatic Use

Block Parameter: SourceOfInitialOutputValue

Type: character vector

Values: 'Dialog' | 'Input signal'

Default: 'Dialog'

Output when disabled — Output when disabled

held (default) | reset

Specify what happens to the block output when the subsystem is disabled. Select `held` to indicate that the output is held when the subsystem is disabled. Select `reset` to indicate that the output is reset to the value given by **Initial output** when the subsystem is disabled.

Dependencies

Available when you select `Dialog` as the value for the **Source of initial output** parameter for an Output block inside a conditional subsystem with valid enabling and disabling semantics. For

example, the parameter is available for an Output block inside an Enabled Subsystem block and not for an Output block inside a Triggered Subsystem block.

If an Output block is inside a Function-Call Subsystem block, this parameter is only meaningful if the Function-Call Subsystem block is connected to a state in a Stateflow chart. For more information, see “Bind a Function-Call Subsystem to a State” (Stateflow).

When connecting the output of a conditional subsystem to a Merge block, set this parameter to `held`. Setting it to `reset` returns an error.

Programmatic Use

Block Parameter: `OutputWhenDisabled`

Type: character vector

Values: `'held'` | `'reset'`

Default: `'held'`

Initial output — Initial output for conditionally executed subsystems

`[]` (default) | scalar | structure

For conditionally executed subsystems, specify the block output before the subsystem executes and while it is disabled. Specify `[]` to inherit the initial output value from the input signal. For more information, see “Conditional Subsystem Initial Output Values”.

For information about specifying an initial condition structure, see “Specify Initial Conditions for Bus Elements”.

Tips

If the conditional subsystem is driving a Merge block, you do not need to specify an Initial Condition (IC) for the Output block. For more information, see “Underspecified initialization detection”.

Dependencies

Available when **Source of initial output value** is set to `Dialog` for an Output block in a conditional subsystem.

Limitations

- This block does not allow an initial output of `inf` or `NaN`.
- When the input is a virtual bus, an **Initial output** value `[]` is treated as `double(0)`.
- When the input contains a nonvirtual bus, **Initial output** does not support nonzero scalar values.

Programmatic Use

Block Parameter: `InitialOutput`

Type: character vector

Values: `'[]'` | scalar | structure

Default: `'[]'`

Signal Attributes

Minimum — Minimum output value

`[]` (default) | scalar

Lower value of the output range that Simulink checks.

This number must be a finite real double scalar value.

Note If you specify a bus object as the data type for this block, do not set the minimum value for bus data on the block. Simulink ignores this setting. Instead, set the minimum values for bus elements of the bus object specified as the data type. For information on the Minimum property of a bus element, see `Simulink.BusElement`.

Simulink software uses this value to perform:

- Simulation range checking (see “Specify Signal Ranges”).
- Automatic scaling of fixed-point data types.
- Optimization of the code that you generate from the model. This optimization can remove algorithmic code and affect the results of some simulation modes such as SIL or external mode. For more information, see “Optimize using the specified minimum and maximum values” (Embedded Coder).

Programmatic Use

Block Parameter: OutMin

Type: character vector

Values: ' [] ' | scalar

Default: ' [] '

Maximum — Maximum output value

[] (default) | scalar

Upper value of the output range that Simulink checks.

This number must be a finite real double scalar value.

Note If you specify a bus object as the data type for this block, do not set the maximum value for bus data on the block. Simulink ignores this setting. Instead, set the maximum values for bus elements of the bus object specified as the data type. For information on the Maximum property of a bus element, see `Simulink.BusElement`.

Simulink software uses this value to perform:

- Simulation range checking (see “Specify Signal Ranges”).
- Automatic scaling of fixed-point data types.
- Optimization of the code that you generate from the model. This optimization can remove algorithmic code and affect the results of some simulation modes such as SIL or external mode. For more information, see “Optimize using the specified minimum and maximum values” (Embedded Coder).

Programmatic Use

Block Parameter: OutMax

Type: character vector

Values: ' [] ' | scalar

Default: ' [] '

Data type — Output data type

Inherit: auto (default) | double | single | half | int8 | uint8 | int16 | uint16 | ...

Specify the output data type of the external input. The type can be inherited, specified directly, or expressed as a data type object such as a `Simulink.NumericType` object.

Click the **Show data type assistant** button  to display the **Data Type Assistant**, which helps you set the data type attributes. For more information, see “Specify Data Types Using Data Type Assistant”.

You can specify any of these options:

- Inherited data type
- Built-in Simulink data type — For example, specify `single` or `uint8`. See “Data Types Supported by Simulink”.
- Fixed-point data type — Use the `fixdt` function. For example, specify `fixdt(1,16,0)`.
- Enumerated data type — Use the name of the type preceded by `Enum:`. For example, specify `Enum: myEnumType`.
- Bus data type — Use the name of the `Simulink.Bus` object preceded by `Bus:`. For example, specify `Bus: myBusObject`.
- Value type — Use the name of the `Simulink.ValueType` object preceded by `ValueType:`. For example, specify `ValueType: windVelocity`.
- Custom data type — Use a MATLAB expression that specifies the type. For example, you can specify a `Simulink.NumericType` object whose `DataTypeMode` property is set to a value other than `'Fixed-point: unspecified scaling'`.

When you specify a `Simulink.ValueType` or `Simulink.Bus` object, the object defines more than the data type. The object also defines properties such as **Min**, **Max**, and **Unit**. The property values specified by the `ValueType` object override the corresponding property values specified by a block. For example, suppose a block sets **Unit** to `ft/s`. When the **Data type** of the block specifies a `ValueType` object that has `m/s` as its unit, the block uses `m/s` instead of `ft/s`.

Programmatic Use

Block Parameter: `OutDataTypeStr`

Type: character vector

Values: `'Inherit: auto' | 'double' | 'single' | 'half' | 'int8' | 'uint8' | 'int16' | 'uint16' | 'int32' | 'uint32' | 'int64' | 'uint64' | 'boolean' | 'fixdt(1,16)' | 'fixdt(1,16,0)' | 'fixdt(1,16,2^0,0)' | 'string' | 'Enum: <class name>' | 'Bus: <object name>' | 'ValueType: <object name>' | '<data type expression>'`

Default: `'Inherit: auto'`

Lock output data type setting against changes by the fixed-point tools — Prevent fixed-point tools from overriding data types

`off (default) | on`

Select to lock the output data type setting of this block against changes by the Fixed-Point Tool and the Fixed-Point Advisor. For more information, see “Use Lock Output Data Type Setting” (Fixed-Point Designer).

Programmatic Use

Block Parameter: `LockScale`

Type: character vector

Values: `'off' | 'on'`

Default: `'off'`

Output as nonvirtual bus in parent model — Output as nonvirtual bus in parent model

off (default) | on

Specify the output bus to be nonvirtual in the parent model. Select this parameter if you want the bus emerging in the parent model to be nonvirtual. The bus that is input to the port can be virtual or nonvirtual, regardless of the setting of **Output as nonvirtual bus in parent model**.

Clear this parameter if you want the bus emerging in the parent model to be virtual.

Tips

- In a nonvirtual bus, all signals must have the same sample time, even if the elements of the associated bus object specify inherited sample times. Any operation that would result in a nonvirtual bus that violates this requirement generates an error. For details, see “Modify Sample Times for Nonvirtual Buses”.

To use a multirate signal for a virtual bus, in the root-level Outport block, set the **Sample time** parameter to inherited (-1).

- For the top model in a model reference hierarchy, code generation creates a C structure to represent the bus output of this block.
- For referenced models, select this option to create a C structure. Otherwise, code generation creates an argument for each leaf element of the bus.

Dependency

Available when the **Data type** is set to Bus: <object name>.

Programmatic Use

Block Parameter: BusOutputAsStruct

Type: character vector

Values: 'off' | 'on'

Default: 'off'

Unit (e.g., m, m/s², N*m) — Physical unit of the input signal to the block

inherit (default) | <Enter unit>

Specify the physical unit of the input signal to the block. To specify a unit, begin typing in the text box. As you type, the parameter displays potential matching units. For a list of supported units, see Allowed Unit Systems.

To constrain the unit system, click the link to the right of the parameter:

- If a Unit System Configuration block exists in the component, its dialog box opens. Use that dialog box to specify allowed and disallowed unit systems for the component.
- If a Unit System Configuration block does not exist in the component, the model Configuration Parameters dialog box displays. Use that dialog box to specify allowed and disallowed unit systems for the model.

Programmatic Use

Block Parameter: Unit

Type: character vector

Values: 'inherit' | '<Enter unit>'

Default: 'inherit'

Port dimensions (-1 for inherited) – Port dimensions

-1 (default) | integer | [integer, integer]

Specify the dimensions that a signal must have to be connected to this Output block.

| | |
|-------|---|
| -1 | A signal of any dimensions can be connected to this port. |
| N | The signal connected to this port must be a vector of size N. |
| [R C] | The signal connected to this port must be a matrix having R rows and C columns. |

Programmatic Use**Block Parameter:** PortDimensions**Type:** character vector**Values:** '-1' | integer | [integer, integer]**Default:** '-1'**Variable-size signal – Allow variable-size signals**

Inherit (default) | No | Yes

Specify the type of signals allowed at the output of this port. To allow variable-size and fixed-size signals, select *Inherit*. To allow only variable-size signals, select *Yes*. To allow only fixed-size signals, select *No*.

Dependencies

When the signal at this port is a variable-size signal, the **Port dimensions** parameter specifies the maximum dimensions of the signal.

Programmatic Use**Parameter:** VarSizeSig**Type:** character vector**Value:** 'Inherit' | 'No' | 'Yes'**Default:** 'Inherit'**Sample time (-1 for inherited) – Specify sample time**

-1 (default) | scalar

Specify the discrete interval between sample time hits or specify another appropriate sample time such as continuous or inherited.

By default, the block inherits its sample time based upon the context of the block within the model. To set a different sample time, enter a valid sample time based upon the table in “Types of Sample Time”.

Programmatic Use**Block Parameter:** SampleTime**Type:** character vector**Values:** scalar**Default:** '-1'**Signal type – Output signal type**

auto (default) | real | complex

Specify the numeric type of the signal output. To choose the numeric type of the signal that is connected to its input, select *auto*. Otherwise, choose a real or complex signal type.

Programmatic Use**Block Parameter:** SignalType**Type:** character vector**Values:** 'auto' | 'real' | 'complex'**Default:** 'auto'**Block Characteristics**

| | |
|---------------------------------|--|
| Data Types | Boolean bus double enumerated fixed point half integer single string |
| Direct Feedthrough | no |
| Multidimensional Signals | yes |
| Variable-Size Signals | yes |
| Zero-Crossing Detection | no |

Extended Capabilities**C/C++ Code Generation**

Generate C and C++ code using Simulink® Coder™.

HDL Code Generation

Generate Verilog and VHDL code for FPGA and ASIC designs using HDL Coder™.

HDL Coder provides additional configuration options that affect HDL implementation and synthesized logic.

HDL Architecture

This block has a single, default HDL architecture.

HDL Block Properties

| General | | |
|-------------------|---------------------------|---|
| BidirectionalPort | BidirectionalPort Setting | Description |
| | on | <p>Specify the port as bidirectional.</p> <p>The following requirements apply:</p> <ul style="list-style-type: none"> • The port must be in a Subsystem block with black box implementation. • There must also be no logic between the bidirectional port and the corresponding top-level DUT subsystem port. <p>For more information, see “Specify Bidirectional Ports” (HDL Coder).</p> |
| | off (default) | Do not specify the port as bidirectional. |

| Target Specification | |
|----------------------|--|
| IOInterface | <p>Target platform interface type for DUT ports, specified as a character vector. The IOInterface block property is ignored for Inport and Outport blocks that are not DUT ports.</p> <p>To specify valid IOInterface settings, use the HDL Workflow Advisor:</p> <ol style="list-style-type: none"> 1 In the HDL Workflow Advisor, in the Set Target > Set Target Interface step, in the Target platform interface table, in the Target Platform Interfaces column, use the drop-down list to set the target platform interface type. 2 Save the model. <p>The IOInterface value is saved as an HDL block property of the port.</p> <p>For example, to view the IOInterface value, if the full path to your DUT port is hdlcoder_led_blinking/led_counter/LED, enter:</p> <pre>hdlget_param('hdlcoder_led_blinking/led_counter/LED', 'IOInterface')</pre> |

| Target Specification | |
|---------------------------|---|
| IOInterfaceMapping | <p>Target platform interface port mapping for DUT ports, specified as a character vector. The <code>IOInterfaceMapping</code> block property is ignored for Inport and Outport blocks that are not DUT ports.</p> <p>To specify valid <code>IOInterfaceMapping</code> settings, use the HDL Workflow Advisor:</p> <ol style="list-style-type: none"> 1 In the HDL Workflow Advisor, in the Set Target > Set Target Interface step, in the Target platform interface table, in the Target Platform Interfaces column, use the drop-down list to set the target platform interface type. 2 In the Bit Range / Address / FPGA Pin column, if you want to change the default value, enter a target platform interface mapping. 3 Save the model. <p>The <code>IOInterfaceMapping</code> value is saved as an HDL block property of the port.</p> <p>For example, to view the <code>IOInterfaceMapping</code> value, if the full path to your DUT port is <code>hdlcoder_led_blinking/led_counter/LED</code>, enter:</p> <pre>hdlget_param('hdlcoder_led_blinking/led_counter/LED', ... 'IOInterfaceMapping')</pre> |
| IOInterfaceOptions | <p>Target platform interface port mapping options for DUT ports, specified as a character vector. The <code>IOInterfaceOptions</code> block property is ignored for Inport and Outport blocks that are not DUT ports.</p> <p>To specify valid <code>IOInterfaceOptions</code> settings, use the HDL Workflow Advisor:</p> <ol style="list-style-type: none"> 1 In the HDL Workflow Advisor, on the Set Target > Set Target Interface step, in the Target platform interface table, in the Target Platform Interfaces column, map the input or output ports to an AXI4 subordinate interface. 2 In the Interface Options column, if you want to change the default initial value, click the Options button and enter a value for RegisterInitialValue. 3 Save the model. <p>The <code>IOInterfaceOptions</code> value is saved as an HDL block property of the port.</p> <p>For example, to view the <code>IOInterfaceOptions</code> value, if the full path to your DUT port is <code>hdlcoder_led_blinking/led_counter/LED</code>, enter:</p> <pre>hdlget_param('hdlcoder_led_blinking/led_counter/LED', ... 'IOInterfaceOptions')</pre> |

PLC Code Generation

Generate Structured Text code using Simulink® PLC Coder™.

Fixed-Point Conversion

Design and simulate fixed-point systems using Fixed-Point Designer™.

See Also

Inport | Out Bus Element

Topics

“Simplify Subsystem and Model Interfaces with Buses”

“Ensure Outport is Virtual”

“Specify Data Types Using Data Type Assistant”

Introduced before R2006a

Parameter Writer

Write to a model instance parameter

Library: Simulink / Signal Routing



Description

The Parameter Writer block changes block parameter values in a referenced model by writing to instance parameters belonging to a Model block referencing a model.

Use the Parameter Writer block with the Initialize Function and Reset Function blocks to respond to events. For example, an event could be reading the value from a hardware sensor, and then updating a model parameter based on the sensor value.

Ports

Input

In — Parameter value

scalar | vector

Parameter value written to a block.

Data Types: half | single | double | int8 | int16 | int32 | int64 | uint8 | uint16 | uint32 | uint64 | Boolean | fixed point | enumerated | bus

Parameters

Parameter owner block — Show the parameter owner block

none (default)

Show the parameter owner block whose parameter value this block is writing. To change the parameter owner block, select a block from the **Parameter Owner Selector Tree**.

Programmatic Use

Block Parameter: ParameterOwnerBlock

Type: character vector

Value: '' | '<model path/block name>'

Default: ''

Block Characteristics

| | |
|---------------------------------|---|
| Data Types | Boolean bus double enumerated fixed point half integer single |
| Direct Feedthrough | no |
| Multidimensional Signals | yes |

| | |
|--------------------------------|----|
| Variable-Size Signals | no |
| Zero-Crossing Detection | no |

Extended Capabilities

C/C++ Code Generation

Generate C and C++ code using Simulink® Coder™.

Fixed-Point Conversion

Design and simulate fixed-point systems using Fixed-Point Designer™.

See Also

[Initialize Function](#) | [Reset Function](#) | [Terminate Function](#) | [Event Listener](#) | [State Reader](#) | [State Writer](#) | [Model](#)

Topics

[“Using Initialize, Reset, and Terminate Functions”](#)

[“Parameterize Instances of a Reusable Referenced Model”](#)

[“Create Test Harness to Generate Function Calls”](#)

[Initialize and Reset Parameter Values](#)

[“Initialize, Reset, and Terminate Function Limitations”](#)

Permute Dimensions

Rearrange dimensions of multidimensional array dimensions

Library: Simulink / Math Operations



Description

The Permute Dimensions block reorders the elements of the input signal by permuting its dimensions. You specify the permutation to be applied to the input signal using the **Order** parameter.

For example, to transpose a 3-by-5 input signal, specify the permutation vector [2 1] for the **Order** parameter. When you do, the block reorders the elements of the input signal and outputs a 5-by-3 matrix.

You can use an array of buses as an input signal to a Permute Dimensions block. For details about defining and using an array of buses, see “Group Nonvirtual Buses in Arrays of Buses”.

Ports

Input

Port_1 – Input signal

scalar | vector | matrix | N-D array

This port accepts scalar, vector, matrix, and N-dimensional signals of any data type that Simulink supports, including fixed-point, enumerated, and nonvirtual bus data types.

Data Types: half | single | double | int8 | int16 | int32 | int64 | uint8 | uint16 | uint32 | uint64 | Boolean | fixed point | enumerated | bus

Output

Port_2 – Permutation of input signal

scalar | vector | matrix | N-D array

The block outputs the permutation of the input signal, according to the value of the **Order** parameter. The output has the same data type as the input.

Data Types: half | single | double | int8 | int16 | int32 | int64 | uint8 | uint16 | uint32 | uint64 | Boolean | fixed point | enumerated | bus

Parameters

Order – Permutation vector

[2, 1] (default) | N-element vector, where N is the number of dimensions of the input signal

Specify the permutation order to apply to the dimensions of the input signal. The value of this parameter must be an N-element vector where N is the number of dimensions of the input signal. The elements of the permutation vector must be a rearrangement of the values from 1 to N.

For example, the permutation vector [2 1] applied to a 5-by-3 input signal results in a 3-by-5 output signal, in other words, the transpose of the input signal.

Programmatic Use

Block Parameter: Order

Type: character vector

Value: N-element vector

Default: '[2 1]'

Block Characteristics

| | |
|---------------------------------|---|
| Data Types | Boolean bus double enumerated fixed point half integer single |
| Direct Feedthrough | yes |
| Multidimensional Signals | no |
| Variable-Size Signals | yes |
| Zero-Crossing Detection | no |

Extended Capabilities

C/C++ Code Generation

Generate C and C++ code using Simulink® Coder™.

PLC Code Generation

Generate Structured Text code using Simulink® PLC Coder™.

Fixed-Point Conversion

Design and simulate fixed-point systems using Fixed-Point Designer™.

See Also

Math Function | permute

Topics

“Multidimensional Arrays”

Introduced in R2007a

PID Controller

Continuous-time or discrete-time PID controller

Library: Simulink / Continuous

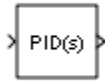

Description

The PID Controller block implements a PID controller (PID, PI, PD, P only, or I only). The block is identical to the Discrete PID Controller block with the **Time domain** parameter set to **Continuous-time**.

The block output is a weighted sum of the input signal, the integral of the input signal, and the derivative of the input signal. The weights are the proportional, integral, and derivative gain parameters. A first-order pole filters the derivative action.

The block supports several controller types and structures. Configurable options in the block include:

- Controller type (PID, PI, PD, P only, or I only) — See the **Controller** parameter.
- Controller form (Parallel or Ideal) — See the **Form** parameter.
- Time domain (continuous or discrete) — See the **Time domain** parameter.
- Initial conditions and reset trigger — See the **Source** and **External reset** parameters.
- Output saturation limits and built-in anti-windup mechanism — See the **Limit output** parameter.
- Signal tracking for bumpless control transfer and multiloop control — See the **Enable tracking mode** parameter.

As you change these options, the internal structure of the block changes by activating different variant subsystems. (See "Variant Subsystems".) To examine the internal structure of the block and its variant subsystems, right-click the block and select **Mask > Look Under Mask**.

Control Configuration

In one common implementation, the PID Controller block operates in the feedforward path of a feedback loop.

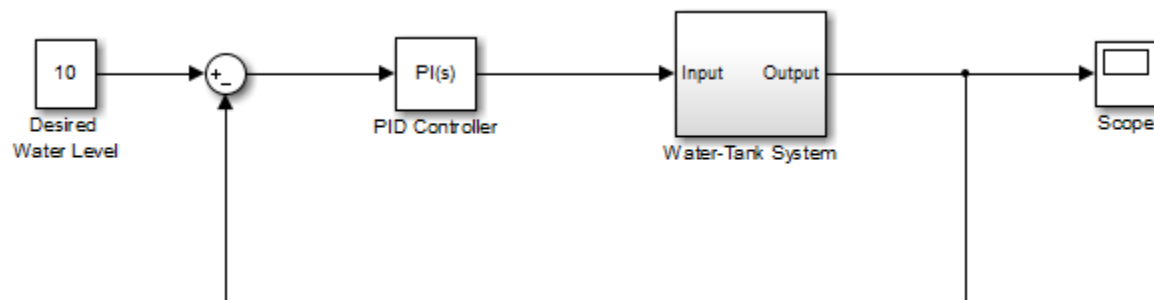

The input of the block is typically an error signal, which is the difference between a reference signal and the system output. For a two-input block that permits setpoint weighting, see PID Controller (2DOF).

PID Gain Tuning

The PID controller coefficients are tunable either manually or automatically. Automatic tuning requires Simulink Control Design software. For more information about automatic tuning, see the **Select tuning method** parameter.

Ports

Input

Port_1(u) — Error signal input

scalar | vector

Difference between a reference signal and the output of the system under control, as shown.

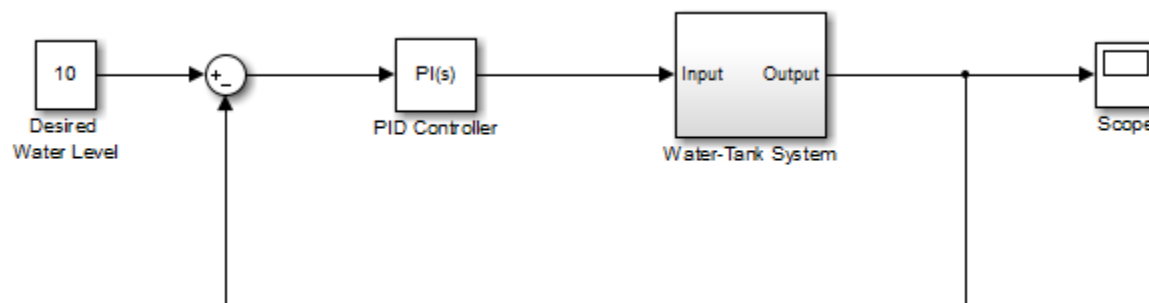

When the error signal is a vector, the block acts separately on each signal, vectorizing the PID coefficients and producing a vector output signal of the same dimensions. You can specify the PID coefficients and some other parameters as vectors of the same dimensions as the input signal. Doing so is equivalent to specifying a separate PID controller for each entry in the input signal.

Data Types: single | double | int8 | int16 | int32 | int64 | uint8 | uint16 | uint32 | uint64 | fixed point

P — Proportional gain

scalar | vector

Proportional gain, provided from a source external to the block. External gain input is useful, for example, when you want to map a different PID parameterization to the PID gains of the block. You can also use external gain input to implement gain-scheduled PID control. In gain-scheduled control, you determine the PID coefficients by logic or other calculation in your model and feed them to the block.

Dependencies

To enable this port, set **Controller parameters Source** to external.

Data Types: single | double | int8 | int16 | int32 | int64 | uint8 | uint16 | uint32 | uint64 | fixed point

I — Integral gain

scalar | vector

Integral gain, provided from a source external to the block. External gain input is useful, for example, when you want to map a different PID parameterization to the PID gains of the block. You can also use external gain input to implement gain-scheduled PID control. In gain-scheduled control, you determine the PID coefficients by logic or other calculation in your model and feed them to the block.

When you supply gains externally, time variations in the integral gain are also integrated. This result occurs because of the way the PID gains are implemented within the block. For details, see the **Controller parameters Source** parameter.

Dependencies

To enable this port, set **Controller parameters Source** to `external`, and set **Controller** to a controller type that has integral action.

Data Types: `single` | `double` | `int8` | `int16` | `int32` | `int64` | `uint8` | `uint16` | `uint32` | `uint64` | `fixed point`

D — Derivative gain

scalar | vector

Derivative gain, provided from a source external to the block. External gain input is useful, for example, when you want to map a different PID parameterization to the PID gains of the block. You can also use external gain input to implement gain-scheduled PID control. In gain-scheduled control, you determine the PID coefficients by logic or other calculation in your model and feed them to the block.

When you supply gains externally, time variations in the derivative gain are also differentiated. This result occurs because of the way the PID gains are implemented within the block. For details, see the **Controller parameters Source** parameter.

Dependencies

To enable this port, set **Controller parameters Source** to `external`, and set **Controller** to a controller type that has derivative action.

Data Types: `single` | `double` | `int8` | `int16` | `int32` | `int64` | `uint8` | `uint16` | `uint32` | `uint64` | `fixed point`

N — Filter coefficient

scalar | vector

Derivative filter coefficient, provided from a source external to the block. External coefficient input is useful, for example, when you want to map a different PID parameterization to the PID gains of the block. You can also use the external input to implement gain-scheduled PID control. In gain-scheduled control, you determine the PID coefficients by logic or other calculation in your model and feed them to the block.

Dependencies

To enable this port, set **Controller parameters Source** to `external`, and set **Controller** to a controller type that has a filtered derivative.

Data Types: `single` | `double` | `int8` | `int16` | `int32` | `int64` | `uint8` | `uint16` | `uint32` | `uint64` | `fixed point`

Reset — External reset trigger

scalar

Trigger to reset the integrator and filter to their initial conditions. The value of the **External reset** parameter determines whether reset occurs on a rising signal, a falling signal, or a level signal. The port icon indicates the selected trigger type. For example, the following illustration shows a continuous-time PID block with **External reset** set to **rising**.

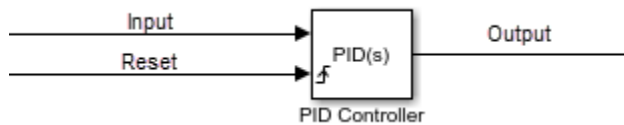

When the trigger occurs, the block resets the integrator and filter to the initial conditions specified by the **Integrator Initial condition** and **Filter Initial condition** parameters or the **I₀** and **D₀** ports.

Note To be compliant with the Motor Industry Software Reliability Association (MISRA) software standard, your model must use Boolean signals to drive the external reset ports of the PID controller block.

Dependencies

To enable this port, set **External reset** to any value other than **none**.

Data Types: `single` | `double` | `int8` | `int16` | `int32` | `int64` | `uint8` | `uint16` | `uint32` | `uint64` | `fixed point` | `Boolean`

I₀ — Integrator initial condition

scalar | vector

Integrator initial condition, provided from a source external to the block.

Dependencies

To enable this port, set **Initial conditions Source** to **external**, and set **Controller** to a controller type that has integral action.

Data Types: `single` | `double` | `int8` | `int16` | `int32` | `int64` | `uint8` | `uint16` | `uint32` | `uint64` | `fixed point`

D₀ — Filter initial condition

scalar | vector

Initial condition of the derivative filter, provided from a source external to the block.

Dependencies

To enable this port, set **Initial conditions Source** to **external**, and set **Controller** to a controller type that has derivative action.

Data Types: `single` | `double` | `int8` | `int16` | `int32` | `int64` | `uint8` | `uint16` | `uint32` | `uint64` | `fixed point`

up — Output saturation upper limit

scalar | vector

Upper limit of the block output, provided from a source external to the block. If the weighted sum of the proportional, integral, and derivative actions exceeds the value provided at this port, the block output is held at that value.

Dependencies

To enable this port, select **Limit output** and set the output saturation **Source** to **external**.

Data Types: `single` | `double` | `int8` | `int16` | `int32` | `int64` | `uint8` | `uint16` | `uint32` | `uint64` | `fixed point`

Lo — Output saturation lower limit

scalar | vector

Lower limit of the block output, provided from a source external to the block. If the weighted sum of the proportional, integral, and derivative actions goes below the value provided at this port, the block output is held at that value.

Dependencies

To enable this port, select **Limit output** and set the output saturation **Source** to **external**.

Data Types: `single` | `double` | `int8` | `int16` | `int32` | `int64` | `uint8` | `uint16` | `uint32` | `uint64` | `fixed point`

TR — Tracking signal

scalar | vector

Signal for controller output to track. When signal tracking is active, the difference between the tracking signal and the block output is fed back to the integrator input. Signal tracking is useful for implementing bumpless control transfer in systems that switch between two controllers. It can also be useful to prevent block windup in multiloop control systems. For more information, see the **Enable tracking mode** parameter.

Dependencies

To enable this port, select the **Enable tracking mode** parameter.

Data Types: `single` | `double` | `int8` | `int16` | `int32` | `int64` | `uint8` | `uint16` | `uint32` | `uint64` | `fixed point`

T_{DTI} — Discrete-integrator time

scalar

Discrete-integrator time, provided as a scalar to the block. You can use your own value of discrete-time integrator sample time that defines the rate at which the block is going to be run either in Simulink or on external hardware. The value of the discrete-time integrator time should match the average sampling rate of the external interrupts, when the block is used inside a conditionally-executed subsystem.

In other words, you can specify T_s for any of the integrator methods below such that the value matches the average sampling rate of the external interrupts. In discrete time, the derivative term of the controller transfer function is:

$$D \left[\frac{N}{1 + N\alpha(z)} \right],$$

where $\alpha(z)$ depends on the integrator method you specify with this parameter.

Forward Euler

$$\alpha(z) = \frac{T_s}{z - 1}.$$

Backward Euler

$$\alpha(z) = \frac{T_s z}{z - 1}.$$

Trapezoidal

$$\alpha(z) = \frac{T_s z + 1}{2 z - 1} \cdot$$

For more information about discrete-time integration, see the Discrete-Time Integrator block reference page. For more information on conditionally executed subsystems, see “Conditionally Executed Subsystems Overview”.

Dependencies

To enable this port, set **Time Domain** to Discrete-time and select the **PID Controller is inside a conditionally executed subsystem** option.

Data Types: single | double | int8 | int16 | int32 | int64 | uint8 | uint16 | uint32 | uint64

Output

Port_1(y) – Controller output

scalar | vector

Controller output, generally based on a sum of the input signal, the integral of the input signal, and the derivative of the input signal, weighted by the proportional, integral, and derivative gain parameters. A first-order pole filters the derivative action. Which terms are present in the controller signal depends on what you select for the **Controller** parameter. The base controller transfer function for the current settings is displayed in the **Compensator formula** section of the block parameters and under the mask. Other parameters modify the block output, such as saturation limits specified by the **Upper Limit** and **Lower Limit** saturation parameters.

The controller output is a vector signal when any of the inputs is a vector signal. In that case, the block acts as N independent PID controllers, where N is the number of signals in the input vector.

Data Types: single | double | int8 | int16 | int32 | int64 | uint8 | uint16 | uint32 | uint64 | fixed point

Parameters

Controller – Controller type

PID (default) | PI | PD | P | I

Specify which of the proportional, integral, and derivative terms are in the controller.

PID

Proportional, integral, and derivative action.

PI

Proportional and integral action only.

PD

Proportional and derivative action only.

P

Proportional action only.

I

Integral action only.

Tip The controller transfer function for the current setting is displayed in the **Compensator formula** section of the block parameters and under the mask.

Programmatic Use**Block Parameter:** Controller**Type:** string, character vector**Values:** "PID", "PI", "PD", "P", "I"**Default:** "PID"**Form — Controller structure**

Parallel (default) | Ideal

Specify whether the controller structure is parallel or ideal.

Parallel

The controller output is the sum of the proportional, integral, and derivative actions, weighted independently by **P**, **I**, and **D**, respectively. For example, for a continuous-time parallel-form PID controller, the transfer function is:

$$C_{par}(s) = P + I\left(\frac{1}{s}\right) + D\left(\frac{Ns}{s + N}\right).$$

For a discrete-time parallel-form controller, the transfer function is:

$$C_{par}(z) = P + I\alpha(z) + D\left[\frac{N}{1 + N\beta(z)}\right],$$

where the **Integrator method** and **Filter method** parameters determine $\alpha(z)$ and $\beta(z)$, respectively.

Ideal

The proportional gain **P** acts on the sum of all actions. For example, for a continuous-time ideal-form PID controller, the transfer function is:

$$C_{id}(s) = P\left[1 + I\left(\frac{1}{s}\right) + D\left(\frac{Ns}{s + N}\right)\right].$$

For a discrete-time ideal-form controller, the transfer function is:

$$C_{id}(z) = P \left[1 + I\alpha(z) + D \frac{N}{1 + N\beta(z)} \right],$$

where the **Integrator method** and **Filter method** parameters determine $a(z)$ and $b(z)$, respectively.

Tip The controller transfer function for the current settings is displayed in the **Compensator formula** section of the block parameters and under the mask.

Programmatic Use

Block Parameter: Controller

Type: string, character vector

Values: "Parallel", "Ideal"

Default: "Parallel"

Time domain — Specify continuous-time or discrete-time controller

Continuous-time (default) | Discrete-time

When you select **Discrete-time**, it is recommended that you specify an explicit sample time for the block. See the **Sample time (-1 for inherited)** parameter. Selecting **Discrete-time** also enables the **Integrator method**, and **Filter method** parameters.

When the PID Controller block is in a model with synchronous state control (see the State Control block), you cannot select **Continuous-time**.

Note The PID Controller and Discrete PID Controller blocks are identical except for the default value of this parameter.

Programmatic Use

Block Parameter: TimeDomain

Type: string, character vector

Values: "Continuous-time", "Discrete-time"

Default: "Continuous-time"

PID Controller is inside a conditionally executed subsystem — Enable the discrete-integrator time port

off (default) | on

For discrete-time PID controllers, enable the discrete-time integrator port to use your own value of discrete-time integrator sample time. To ensure proper integration, Use the T_{DTI} port to provide a scalar value of Δt for accurate discrete-time integration.

Dependencies

To enable this parameter, set **Time Domain** to **Discrete-time**.

Programmatic Use

Block Parameter: UseExternalTs

Type: string, character vector

Values: "on", "off"

Default: "off"

Sample time (-1 for inherited) – Discrete interval between samples

-1 (default) | positive scalar

Specify a sample time by entering a positive scalar value, such as 0.1. The default discrete sample time of -1 means that the block inherits its sample time from upstream blocks. However, it is recommended that you set the controller sample time explicitly, especially if you expect the sample time of upstream blocks to change. The effect of the controller coefficients P, I, D, and N depend on the sample time. Thus, for a given set of coefficient values, changing the sample time changes the performance of the controller.

See “Specify Sample Time” for more information.

To implement a continuous-time controller, set **Time domain** to Continuous-time.

Tip If you want to run the block with an externally specified or variable sample time, set this parameter to -1 and put the block in a Triggered Subsystem. Then, trigger the subsystem at the desired sample time.

Dependencies

To enable this parameter, set **Time domain** to Discrete-time.

Programmatic Use**Block Parameter:** SampleTime**Type:** scalar**Values:** -1, positive scalar**Default:** -1**Integrator method – Method for computing integral in discrete-time controller**

Forward Euler (default) | Backward Euler | Trapezoidal

In discrete time, the integral term of the controller transfer function is $I\alpha(z)$, where $\alpha(z)$ depends on the integrator method you specify with this parameter.

Forward Euler

Forward rectangular (left-hand) approximation,

$$\alpha(z) = \frac{T_s}{z - 1} \cdot$$

This method is best for small sampling times, where the Nyquist limit is large compared to the bandwidth of the controller. For larger sampling times, the Forward Euler method can result in instability, even when discretizing a system that is stable in continuous time.

Backward Euler

Backward rectangular (right-hand) approximation,

$$\alpha(z) = \frac{T_s z}{z - 1} .$$

An advantage of the Backward Euler method is that discretizing a stable continuous-time system using this method always yields a stable discrete-time result.

Trapezoidal

Bilinear approximation,

$$\alpha(z) = \frac{T_s z + 1}{2 z - 1} .$$

An advantage of the Trapezoidal method is that discretizing a stable continuous-time system using this method always yields a stable discrete-time result. Of all available integration methods, the Trapezoidal method yields the closest match between frequency-domain properties of the discretized system and the corresponding continuous-time system.

Tip The controller formula for the current setting is displayed in the **Compensator formula** section of the block parameters and under the mask.

Note For the BackwardEuler or Trapezoidal methods, you cannot generate HDL code for the block if either:

- **Limit output** is selected and **Anti-Windup Method** is anything other than none.
- **Enable tracking mode** is selected.

For more information about discrete-time integration, see the Discrete-Time Integrator block reference page.

Dependencies

To enable this parameter, set **Time Domain** to Discrete-time and set **Controller** to a controller type with integral action.

Programmatic Use

Block Parameter: IntegratorMethod

Type: string, character vector

Values: "Forward Euler", "Backward Euler", "Trapezoidal"

Default: "Forward Euler"

Filter method — Method for computing derivative in discrete-time controller

Forward Euler (default) | Backward Euler | Trapezoidal

In discrete time, the derivative term of the controller transfer function is:

$$D \left[\frac{N}{1 + N\alpha(z)} \right],$$

where $\alpha(z)$ depends on the filter method you specify with this parameter.

Forward Euler

Forward rectangular (left-hand) approximation,

$$\alpha(z) = \frac{T_s}{z - 1} \cdot$$

This method is best for small sampling times, where the Nyquist limit is large compared to the bandwidth of the controller. For larger sampling times, the Forward Euler method can result in instability, even when discretizing a system that is stable in continuous time.

Backward Euler

Backward rectangular (right-hand) approximation,

$$\alpha(z) = \frac{T_s z}{z - 1} \cdot$$

An advantage of the Backward Euler method is that discretizing a stable continuous-time system using this method always yields a stable discrete-time result.

Trapezoidal

Bilinear approximation,

$$\alpha(z) = \frac{T_s z + 1}{2 z - 1} \cdot$$

An advantage of the Trapezoidal method is that discretizing a stable continuous-time system using this method always yields a stable discrete-time result. Of all available integration methods, the Trapezoidal method yields the closest match between frequency-domain properties of the discretized system and the corresponding continuous-time system.

Tip The controller formula for the current setting is displayed in the **Compensator formula** section of the block parameters and under the mask.

For more information about discrete-time integration, see the Discrete-Time Integrator block reference page.

Dependencies

To enable this parameter, set **Time Domain** to Discrete-time and enable **Use filtered derivative**.

Programmatic Use

Block Parameter: FilterMethod

Type: string, character vector

Values: "Forward Euler", "Backward Euler", "Trapezoidal"

Default: "Forward Euler"

Main

Source — Source for controller gains and filter coefficient

internal (default) | external

Enabling external inputs for the parameters allows you to compute PID gains and filter coefficients externally to the block and provide them to the block as signal inputs.

internal

Specify the controller gains and filter coefficient using the block parameters **P**, **I**, **D**, and **N**.

external

Specify the PID gains and filter coefficient externally using block inputs. An additional input port appears on the block for each parameter that is required for the current controller type.

External gain input is useful, for example, when you want to map a different PID parameterization to the PID gains of the block. You can also use external gain input to implement gain-scheduled PID control. In gain-scheduled control, you determine the PID gains by logic or other calculation in your model and feed them to the block.

When you supply gains externally, time variations in the integral and derivative gain values are integrated and differentiated, respectively. This result occurs because in both continuous time and discrete time, the gains are applied to the signal before integration or differentiation. For example, for a continuous-time PID controller with external inputs, the integrator term is implemented as shown in the following illustration.

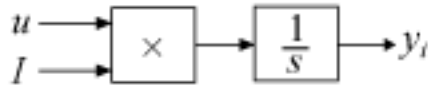

Within the block, the input signal u is multiplied by the externally supplied integrator gain, I , before integration. This implementation yields:

$$y_i = \int uI dt.$$

Thus, the integrator gain is included in the integral. Similarly, in the derivative term of the block, multiplication by the derivative gain precedes the differentiation, which causes the derivative gain D to be differentiated.

Programmatic Use

Block Parameter: ControllerParametersSource

Type: string, character vector

Values: "internal", "external"

Default: "internal"

Proportional (P) — Proportional gain

1 (default) | scalar | vector

Specify a finite, real gain value for the proportional gain. When **Controller form** is:

- **Parallel** — Proportional action is independent of the integral and derivative actions. For instance, for a continuous-time parallel PID controller, the transfer function is:

$$C_{par}(s) = P + I\left(\frac{1}{s}\right) + D\left(\frac{Ns}{s + N}\right).$$

For a discrete-time parallel-form controller, the transfer function is:

$$C_{par}(z) = P + I\alpha(z) + D\left[\frac{N}{1 + N\beta(z)}\right],$$

where the **Integrator method** and **Filter method** parameters determine $\alpha(z)$ and $\beta(z)$, respectively.

- **Ideal** — The proportional gain multiplies the integral and derivative terms. For instance, for a continuous-time ideal PID controller, the transfer function is:

$$C_{id}(s) = P\left[1 + I\left(\frac{1}{s}\right) + D\left(\frac{Ns}{s + N}\right)\right].$$

For a discrete-time ideal-form controller, the transfer function is:

$$C_{id}(z) = P \left[1 + I\alpha(z) + D \frac{N}{1 + N\beta(z)} \right],$$

where the **Integrator method** and **Filter method** parameters determine $\alpha(z)$ and $\beta(z)$, respectively.

Tunable: Yes

Dependencies

To enable this parameter, in the **Main** tab, set the controller-parameters **Source** to **internal** and set **Controller** to PID, PD, PI, or P.

Programmatic Use

Block Parameter: P

Type: scalar, vector

Default: 1

Integral (I) – Integral gain

1 (default) | scalar | vector

Specify a finite, real gain value for the integral gain.

Tunable: Yes

Dependencies

To enable this parameter, in the **Main** tab, set the controller-parameters **Source** to **internal**, and set **Controller** to a type that has integral action.

Programmatic Use

Block Parameter: I

Type: scalar, vector

Default: 1

Derivative (D) – Derivative gain

0 (default) | scalar | vector

Specify a finite, real gain value for the derivative gain.

Tunable: Yes

Dependencies

To enable this parameter, in the **Main** tab, set the controller-parameters **Source** to **internal**, and set **Controller** to PID or PD.

Programmatic Use

Block Parameter: D

Type: scalar, vector

Default: 0

Use filtered derivative – Apply filter to derivative term

on (default) | off

For discrete-time PID controllers only, clear this option to replace the filtered derivative with an unfiltered discrete-time differentiator. When you do so, the derivative term of the controller transfer function becomes:

$$D \frac{z - 1}{z T_s} \cdot$$

For continuous-time PID controllers, the derivative term is always filtered.

Dependencies

To enable this parameter, set **Time domain** to Discrete-time, and set **Controller** to a type that has derivative action.

Programmatic Use

Block Parameter: UseFilter

Type: string, character vector

Values: "on", "off"

Default: "on"

Filter coefficient (N) – Derivative filter coefficient

100 (default) | scalar | vector

Specify a finite, real gain value for the filter coefficient. The filter coefficient determines the pole location of the filter in the derivative action of the block. The location of the filter pole depends on the **Time domain** parameter.

- When **Time domain** is Continuous-time, the pole location is $s = -N$.
- When **Time domain** is Discrete-time, the pole location depends on the **Filter method** parameter.

| Filter Method | Location of Filter Pole |
|----------------|--|
| Forward Euler | $z_{pole} = 1 - NT_s$ |
| Backward Euler | $z_{pole} = \frac{1}{1 + NT_s}$ |
| Trapezoidal | $z_{pole} = \frac{1 - NT_s/2}{1 + NT_s/2}$ |

The block does not support $N = \text{Inf}$ (ideal unfiltered derivative). When the **Time domain** is Discrete-time, you can clear **Use filtered derivative** to remove the derivative filter.

Tunable: Yes

Dependencies

To enable this parameter, in the **Main** tab, set the controller-parameters **Source** to internal and set **Controller** to PID or PD.

Programmatic Use

Block Parameter: N

Type: scalar, vector

Default: 100

Select tuning method — Tool for automatic tuning of controller coefficients

Transfer Function Based (PID Tuner App) (default) | Frequency Response Based

If you have Simulink Control Design software, you can automatically tune the PID coefficients. To do so, use this parameter to select a tuning tool, and click **Tune**.

Transfer Function Based (PID Tuner App)

Use **PID Tuner**, which lets you interactively tune PID coefficients while examining relevant system responses to validate performance. By default, **PID Tuner** works with a linearization of your plant model. For models that cannot be linearized, you can tune PID coefficients against a plant model estimated from simulated or measured response data. For more information, see “Introduction to Model-Based PID Tuning in Simulink” (Simulink Control Design).

Frequency Response Based

Use **Frequency Response Based PID Tuner**, which tunes PID controller coefficients based on frequency-response estimation data obtained by simulation. This tuning approach is especially useful for plants that are not linearizable or that linearize to zero. For more information, see “Design PID Controller from Plant Frequency-Response Data” (Simulink Control Design).

Both of these tuning methods assume a single-loop control configuration. Simulink Control Design software includes other tuning approaches that suit more complex configurations. For information about other ways to tune a PID Controller block, see “Choose a Control Design Approach” (Simulink Control Design).

Enable zero-crossing detection — Detect zero crossings on reset and on entering or leaving a saturation state

on (default) | off

Zero-crossing detection can accurately locate signal discontinuities without resorting to excessively small time steps that can lead to lengthy simulation times. If you select **Limit output** or activate

External reset in your PID Controller block, activating zero-crossing detection can reduce computation time in your simulation. Selecting this parameter activates zero-crossing detection:

- At initial-state reset
- When entering an upper or lower saturation state
- When leaving an upper or lower saturation state

For more information about zero-crossing detection, see “Zero-Crossing Detection”.

Programmatic Use

Block Parameter: ZeroCross

Type: string, character vector

Values: "on", "off"

Default: "on"

Initialization

Source — Source for integrator and derivative initial conditions

`internal` (default) | `external`

Simulink uses initial conditions to initialize the integrator and derivative-filter (or the unfiltered derivative) output at the start of a simulation or at a specified trigger event. (See the **External reset** parameter.) These initial conditions determine the initial block output. Use this parameter to select how to supply the initial condition values to the block.

`internal`

Specify the initial conditions using the **Integrator Initial condition** and **Filter Initial condition** parameters. If **Use filtered derivative** is not selected, use the **Differentiator** parameter to specify the initial condition for the unfiltered differentiator instead of a filter initial condition.

`external`

Specify the initial conditions externally using block inputs. Additional input ports **I₀** and **D₀** appear on the block. If **Use filtered derivative** is not selected, supply the initial condition for the unfiltered differentiator at **D₀** instead of a filter initial condition.

Programmatic Use

Block Parameter: InitialConditionSource

Type: string, character vector

Values: "internal", "external"

Default: "internal"

Integrator — Integrator initial condition

`0` (default) | `scalar` | `vector`

Simulink uses the integrator initial condition to initialize the integrator at the start of a simulation or at a specified trigger event (see **External reset**). The integrator initial condition and the filter initial condition determine the initial output of the PID controller block.

The integrator initial condition cannot be NaN or Inf.

Dependencies

To use this parameter, in the **Initialization** tab, set **Source** to `internal`, and set **Controller** to a type that has integral action.

Programmatic Use**Block Parameter:** InitialConditionForIntegrator**Type:** scalar, vector**Default:** 0**Filter — Filter initial condition**

0 (default) | scalar | vector

Simulink uses the filter initial condition to initialize the derivative filter at the start of a simulation or at a specified trigger event (see **External reset**). The integrator initial condition and the filter initial condition determine the initial output of the PID controller block.

The filter initial condition cannot be NaN or Inf.

Dependencies

To use this parameter, in the **Initialization** tab, set **Source** to `internal`, and use a controller that has a derivative filter.

Programmatic Use**Block Parameter:** InitialConditionForFilter**Type:** scalar, vector**Default:** 0**Differentiator — Initial condition for unfiltered derivative**

0 (default) | scalar | vector

When you use an unfiltered derivative, Simulink uses this parameter to initialize the differentiator at the start of a simulation or at a specified trigger event (see **External reset**). The integrator initial condition and the derivative initial condition determine the initial output of the PID controller block.

The derivative initial condition cannot be NaN or Inf.

Dependencies

To use this parameter, set **Time domain** to `Discrete-time`, clear the **Use filtered derivative** check box, and in the **Initialization** tab, set **Source** to `internal`.

Programmatic Use**Block Parameter:** DifferentiatorICPrevScaledInput**Type:** scalar, vector**Default:** 0**Initial condition setting — Location at which initial condition is applied**

State (most efficient) (default) | Output

Use this parameter to specify whether to apply the **Integrator Initial condition** and **Filter Initial condition** parameter to the corresponding block state or output. You can change this parameter at the command line only, using `set_param` to set the `InitialConditionSetting` parameter of the block.

State (most efficient)

Use this option in all situations except when the block is in a triggered subsystem or a function-call subsystem and simplified initialization mode is enabled.

Output

Use this option when the block is in a triggered subsystem or a function-call subsystem and simplified initialization mode is enabled.

For more information about the **Initial condition setting** parameter, see the Discrete-Time Integrator block.

This parameter is only accessible through programmatic use.

Programmatic Use

Block Parameter: InitialConditionSetting

Type: string, character vector

Values: "state", "output"

Default: "state"

External reset — Trigger for resetting integrator and filter values

none (default) | rising | falling | either | level

Specify the trigger condition that causes the block to reset the integrator and filter to initial conditions. (If **Use filtered derivative** is not selected, the trigger resets the integrator and differentiator to initial conditions.) Selecting any option other than none enables the **Reset** port on the block for the external reset signal.

none

The integrator and filter (or differentiator) outputs are set to initial conditions at the beginning of simulation, and are not reset during simulation.

rising

Reset the outputs when the reset signal has a rising edge.

falling

Reset the outputs when the reset signal has a falling edge.

either

Reset the outputs when the reset signal either rises or falls.

level

Reset the outputs when the reset signal either:

- Is nonzero at the current time step
- Changes from nonzero at the previous time step to zero at the current time step

This option holds the outputs to the initial conditions while the reset signal is nonzero.

Dependencies

To enable this parameter, set **Controller** to a type that has derivative or integral action.

Programmatic Use

Block Parameter: ExternalReset

Type: string, character vector

Values: "none", "rising", "falling", "either", "level"

Default: "none"

Ignore reset when linearizing — Force linearization to ignore reset

off (default) | on

Select to force Simulink and Simulink Control Design linearization commands to ignore any reset mechanism specified in the **External reset** parameter. Ignoring reset states allows you to linearize a model around an operating point even if that operating point causes the block to reset.

Programmatic Use

Block Parameter: IgnoreLimit

Type: string, character vector

Values: "off", "on"

Default: "off"

Enable tracking mode — Activate signal tracking

off (default) | on

Signal tracking lets the block output follow a tracking signal that you provide at the **TR** port. When signal tracking is active, the difference between the tracking signal and the block output is fed back to the integrator input with a gain K_t , specified by the **Tracking gain (Kt)** parameter. Signal tracking has several applications, including bumpless control transfer and avoiding windup in multiloop control structures.

Bumpless control transfer

Use signal tracking to achieve bumpless control transfer in systems that switch between two controllers. Suppose you want to transfer control between a PID controller and another controller. To do so, connecting the controller output to the **TR** input as shown in the following illustration.

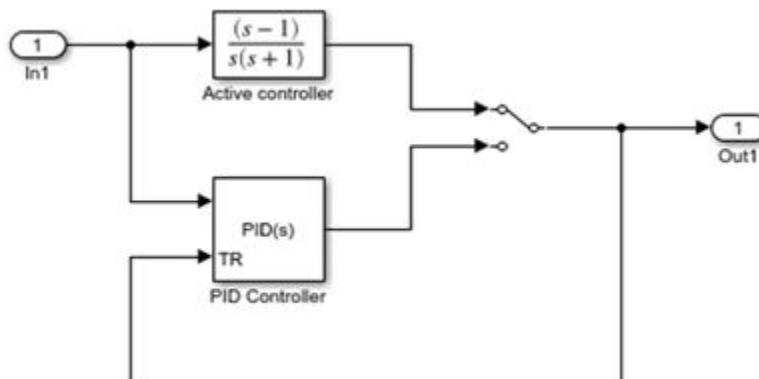

For more information, see “Bumpless Control Transfer” on page 12-100.

Multiloop control

Use signal tracking to prevent block windup in multiloop control approaches, as in the following model.

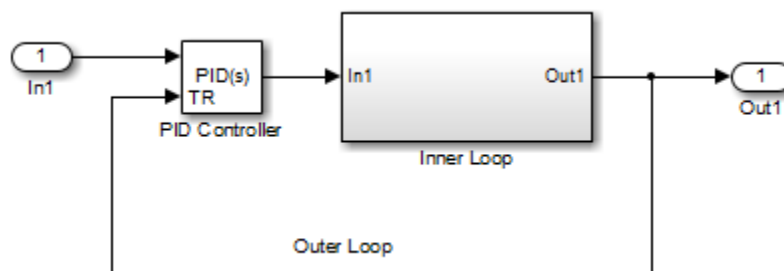

The Inner Loop subsystem contains the blocks shown in the following diagram.

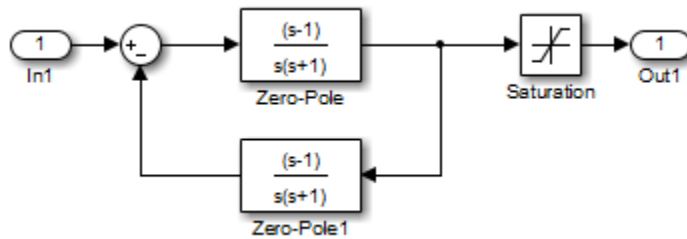

Because the PID controller tracks the output of the inner loop, its output never exceeds the saturated inner-loop output. For more details, see “Prevent Block Windup in Multiloop Control” on page 12-99.

Dependencies

To enable this parameter, set **Controller** to a type that has integral action.

Programmatic Use

Block Parameter: TrackingMode

Type: string, character vector

Values: "off", "on"

Default: "off"

Tracking coefficient (Kt) — Gain of signal-tracking feedback loop

1 (default) | scalar

When you select **Enable tracking mode**, the difference between the signal **TR** and the block output is fed back to the integrator input with a gain K_t . Use this parameter to specify the gain in that feedback loop.

Dependencies

To enable this parameter, select **Enable tracking mode**.

Programmatic Use

Block Parameter: Kt

Type: scalar

Default: 1

Output saturation

Limit Output — Limit block output to specified saturation values

off (default) | on

Activating this option limits the block output, so that you do not need a separate Saturation on page 1-1512 block after the controller. It also allows you to activate the anti-windup mechanism built into the block (see the **Anti-windup method** parameter). Specify the output saturation limits using the **Lower limit** and **Upper limit** parameters. You can also specify the saturation limits externally as block input ports.

Programmatic Use

Block Parameter: LimitOutput

Type: string, character vector

Values: "off", "on"

Default: "off"

Source — Source for output saturation limits

internal (default) | external

Use this parameter to specify how to supply the upper and lower saturation limits of the block output.

internal

Specify the output saturation limits using the **Upper limit** and **Lower limit** parameters.

external

Specify the output saturation limits externally using block input ports. The additional input ports **up** and **lo** appear on the block. You can use the input ports to implement the upper and lower output saturation limits determined by logic or other calculations in the Simulink model and passed to the block.

Programmatic Use

Block Parameter: SatLimitsSource

Type: string, character vector

Values: "internal", "external"

Default: "internal"

Upper limit — Upper saturation limit for block output

Inf (default) | scalar

Specify the upper limit for the block output. The block output is held at the **Upper saturation limit** whenever the weighted sum of the proportional, integral, and derivative actions exceeds that value.

Dependencies

To enable this parameter, select **Limit output**.

Programmatic Use

Block Parameter: UpperSaturationLimit

Type: scalar

Default: Inf

Lower limit — Lower saturation limit for block output

-Inf (default) | scalar

Specify the lower limit for the block output. The block output is held at the **Lower saturation limit** whenever the weighted sum of the proportional, integral, and derivative actions goes below that value.

Dependencies

To enable this parameter, select **Limit output**.

Programmatic Use

Block Parameter: LowerSaturationLimit

Type: scalar

Default: -Inf

Ignore saturation when linearizing — Force linearization to ignore output limits

off (default) | on

Force Simulink and Simulink Control Design linearization commands to ignore block output limits specified in the **Upper limit** and **Lower limit** parameters. Ignoring output limits allows you to linearize a model around an operating point even if that operating point causes the block to exceed the output limits.

Dependencies

To enable this parameter, select the **Limit output** parameter.

Programmatic Use

Block Parameter: LinearizeAsGain

Type: string, character vector

Values: "off", "on"

Default: "off"

Anti-windup method — Integrator anti-windup method

none (default) | back-calculation | clamping

When you select **Limit output** and the weighted sum of the controller components exceeds the specified output limits, the block output holds at the specified limit. However, the integrator output can continue to grow (integrator windup), increasing the difference between the block output and the sum of the block components. In other words, the internal signals in the block can be unbounded even if the output appears bounded by saturation limits. Without a mechanism to prevent integrator windup, two results are possible:

- If the sign of the input signal never changes, the integrator continues to integrate until it overflows. The overflow value is the maximum or minimum value for the data type of the integrator output.
- If the sign of the input signal changes once the weighted sum has grown beyond the output limits, it can take a long time to unwind the integrator and return the weighted sum within the block saturation limit.

In either case, controller performance can suffer. To combat the effects of windup without an anti-windup mechanism, it may be necessary to detune the controller (for example, by reducing the controller gains), resulting in a sluggish controller. To avoid this problem, activate an anti-windup mechanism using this parameter.

none

Do not use an anti-windup mechanism.

back-calculation

Unwind the integrator when the block output saturates by feeding back to the integrator the difference between the saturated and unsaturated control signal. The following diagram represents the back-calculation feedback circuit for a continuous-time controller. To see the actual feedback circuit for your controller configuration, right-click on the block and select **Mask > Look Under Mask**.

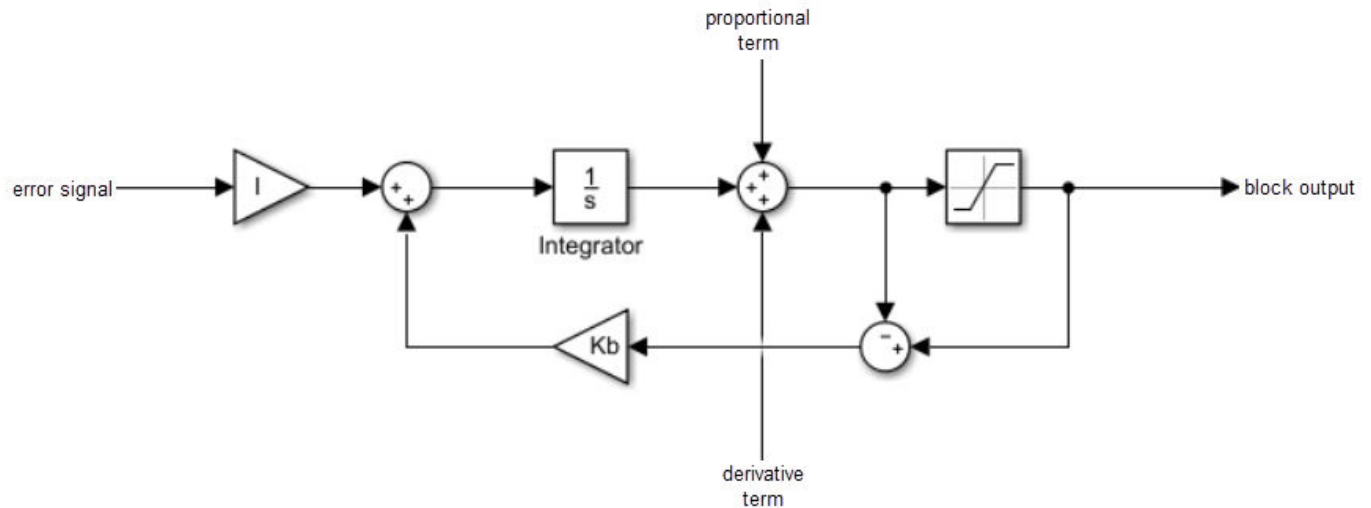

Use the **Back-calculation coefficient (Kb)** parameter to specify the gain of the anti-windup feedback circuit. It is usually satisfactory to set $K_b = I$, or for controllers with derivative action, $K_b = \sqrt{I \cdot D}$. Back-calculation can be effective for plants with relatively large dead time [1].

clamping

Integration stops when the sum of the block components exceeds the output limits and the integrator output and block input have the same sign. Integration resumes when the sum of the block components exceeds the output limits and the integrator output and block input have opposite sign. Clamping is sometimes referred to as conditional integration.

Clamping can be useful for plants with relatively small dead times, but can yield a poor transient response for large dead times [1].

Dependencies

To enable this parameter, select the **Limit output** parameter.

Programmatic Use

Block Parameter: AntiWindupMode

Type: string, character vector

Values: "none", "back-calculation", "clamping"

Default: "none"

Back-calculation coefficient (Kb) — Gain coefficient of anti-windup feedback loop

1 (default) | scalar

The back-calculation anti-windup method unwinds the integrator when the block output saturates. It does so by feeding back to the integrator the difference between the saturated and unsaturated control signal. Use the **Back-calculation coefficient (Kb)** parameter to specify the gain of the anti-windup feedback circuit. For more information, see the **Anti-windup method** parameter.

Dependencies

To enable this parameter, select the **Limit output** parameter, and set the **Anti-windup method** parameter to back-calculation.

Programmatic Use**Block Parameter:** Kb**Type:** scalar**Default:** 1**Data Types**

The parameters in this tab are primarily of use in fixed-point code generation using Fixed-Point Designer. They define how numeric quantities associated with the block are stored and processed when you generate code.

If you need to configure data types for fixed-point code generation, click **Open Fixed-Point Tool** and use that tool to configure the rest of the parameters in the tab. For information about using Fixed-Point Tool, see “Autoscaling Data Objects Using the Fixed-Point Tool” (Fixed-Point Designer).

After you use Fixed-Point Tool, you can use the parameters in this tab to make adjustments to fixed-point data-type settings if necessary. For each quantity associated with the block, you can specify:

- Floating-point or fixed-point data type, including whether the data type is inherited from upstream values in the block.
- The minimum and maximum values for the quantity, which determine how the quantity is scaled for fixed-point representation.

For assistance in selecting appropriate values, click  to open the Data Type Assistant for the corresponding quantity. For more information, see “Specify Data Types Using Data Type Assistant”.

| Main | | Initialization | | Output saturation | | Data Types | | State Attributes | |
|------------------------------------|------------------------------------|--|---------|-------------------|---------|------------|--|--------------------------|--|
| Fixed-point operational parameters | | | | | | | | | |
| Integer rounding mode: | | Floor | | | | | | | |
| <input type="checkbox"/> | | Saturate on integer overflow | | | | | | | |
| <input type="checkbox"/> | | Lock data type settings against changes by the fixed-point tools | | | | | | | |
| | | | | | | | | Open Fixed-Point Tool... | |
| Data Type | | | Minimum | | Maximum | | | | |
| P product output: | Inherit: Inherit via internal rule | >> | | : | | : | | : | |
| I product output: | Inherit: Inherit via internal rule | >> | | : | | : | | : | |
| D product output: | Inherit: Inherit via internal rule | >> | | : | | : | | : | |
| N product output: | Inherit: Inherit via internal rule | >> | | : | | : | | : | |
| b product output: | Inherit: Inherit via internal rule | >> | | : | | : | | : | |
| c product output: | Inherit: Inherit via internal rule | >> | | : | | : | | : | |
| Sum output: | Inherit: Inherit via internal rule | >> | | : | | : | | : | |
| ▶ Additional data types | | | | | | | | | |

The specific quantities listed in the Data Types tab vary depending on how you configure the PID controller block. In general, you can configure data types for the following types of quantities:

- **Product output** — Stores the result of a multiplication carried out under the block mask. For example, **P product output** stores the output of the gain block that multiplies the block input with the proportional gain **P**.
- **Parameter** — Stores the value of a numeric block parameter, such as **P**, **I**, or **D**.
- **Block output** — Stores the output of a block that resides under the PID controller block mask. For example, use **Integrator output** to specify the data type of the output of the block called Integrator. This block resides under the mask in the Integrator subsystem, and computes integrator term of the controller action.
- **Accumulator** — Stores values associated with a sum block. For example, **SumI2 Accumulator** sets the data type of the accumulator associated with the sum block SumI2. This block resides under the mask in the Back Calculation subsystem of the Anti-Windup subsystem.

In general, you can find the block associated with any listed parameter by looking under the PID Controller block mask and examining its subsystems. You can also use the Model Explorer to search under the mask for the listed parameter name, such as SumI2. (See **Model Explorer**.)

Matching Input and Internal Data Types

By default, all data types in the block are set to `Inherit: Inherit via internal rule`. With this setting, Simulink chooses data types to balance numerical accuracy, performance, and generated code size, while accounting for the properties of the embedded target hardware.

Under some conditions, incompatibility can occur between data types within the block. For instance, in continuous time, the Integrator block under the mask can accept only signals of type `double`. If the block input signal is a type that cannot be converted to `double`, such as `uint16`, the internal rules for type inheritance generate an error when you generate code.

To avoid such errors, you can use the Data Types settings to force a data type conversion. For instance, you can explicitly set **P product output**, **I product output**, and **D product output** to `double`, ensuring that the signals reaching the continuous-time integrators are of type `double`.

In general, it is not recommended to use the block in continuous time for code generation applications. However, similar data type errors can occur in discrete time, if you explicitly set some values to data types that are incompatible with downstream signal constraints within the block. In such cases, use the Data Types settings to ensure that all data types are internally compatible.

Fixed-Point Operational Parameters

Integer rounding mode — Rounding mode for fixed-point operations

Floor (default) | Ceiling | Convergent | Nearest | Round | Simplest | Zero

Specify the rounding mode for fixed-point operations. For more information, see “Rounding” (Fixed-Point Designer).

Block parameters always round to the nearest representable value. To control the rounding of a block parameter, enter an expression using a MATLAB rounding function into the mask field.

Programmatic Use

Block Parameter: RndMeth

Type: character vector

Values: 'Ceiling' | 'Convergent' | 'Floor' | 'Nearest' | 'Round' | 'Simplest' | 'Zero'

Default: 'Floor'

Saturate on integer overflow – Method of overflow action

off (default) | on

Specify whether overflows saturate or wrap.

- off — Overflows wrap to the appropriate value that the data type can represent.
For example, the number 130 does not fit in a signed 8-bit integer and wraps to -126.
- on — Overflows saturate to either the minimum or maximum value that the data type can represent.

For example, an overflow associated with a signed 8-bit integer can saturate to -128 or 127.

Tip

- Consider selecting this check box when your model has a possible overflow and you want explicit saturation protection in the generated code.
 - Consider clearing this check box when you want to optimize efficiency of your generated code.
Clearing this check box also helps you to avoid overspecifying how a block handles out-of-range signals. For more information, see “Troubleshoot Signal Range Errors”.
 - When you select this check box, saturation applies to every internal operation on the block, not just the output or result.
 - In general, the code generation process can detect when overflow is not possible. In this case, the code generator does not produce saturation code.
-

Programmatic Use

Block Parameter: SaturateOnIntegerOverflow

Type: character vector

Values: 'off' | 'on'

Default: 'off'

Lock data type settings against changes by the fixed-point tools – Prevent fixed-point tools from overriding data types

off (default) | on

Select this parameter to prevent the fixed-point tools from overriding the data types you specify on this block. For more information, see “Lock the Output Data Type Setting” (Fixed-Point Designer).

Programmatic Use

Block Parameter: LockScale

Type: character vector

Values: 'off' | 'on'

Default: 'off'

State Attributes

The parameters in this tab are primarily of use in code generation.

State name (e.g., 'position') – Name for continuous-time filter and integrator states
 '' (default) | character vector

Assign a unique name to the state associated with the integrator or the filter, for continuous-time PID controllers. (For information about state names in a discrete-time PID controller, see the **State name** parameter.) The state name is used, for example:

- For the corresponding variable in generated code
- As part of the storage name when logging states during simulation
- For the corresponding state in a linear model obtain by linearizing the block

A valid state name begins with an alphabetic or underscore character, followed by alphanumeric or underscore characters.

Dependencies

To enable this parameter, set **Time domain** to Continuous-time.

Programmatic Use

Parameter: IntegratorContinuousStateAttributes, FilterContinuousStateAttributes

Type: character vector

Default: ''

State name – Names for discrete-time filter and integrator states

empty string (default) | string | character vector

Assign a unique name to the state associated with the integrator or the filter, for discrete-time PID controllers. (For information about state names in a continuous-time PID controller, see the **State name (e.g., 'position')** parameter.)

A valid state name begins with an alphabetic or underscore character, followed by alphanumeric or underscore characters. The state name is used, for example:

- For the corresponding variable in generated code
- As part of the storage name when logging states during simulation
- For the corresponding state in a linear model obtain by linearizing the block

For more information about the use of state names in code generation, see “C Code Generation Configuration for Model Interface Elements” (Simulink Coder).

Dependencies

To enable this parameter, set **Time domain** to Discrete-time.

Programmatic Use

Parameter: IntegratorStateIdentifier, FilterStateIdentifier

Type: string, character vector

Default: ""

State name must resolve to Simulink signal object – Require that state name resolve to a signal object

off (default) | on

Select this parameter to require that the discrete-time integrator or filter state name resolves to a Simulink signal object.

Dependencies

To enable this parameter for the discrete-time integrator or filter state:

- 1 Set **Time domain** to Discrete-time.
- 2 Specify a value for the integrator or filter **State name**.
- 3 Set the model configuration parameter **Signal resolution** to a value other than None.

Programmatic Use

Block Parameter: IntegratorStateMustResolveToSignalObject,
FilterStateMustResolveToSignalObject

Type: string, character vector

Values: "off", "on"

Default: "off"

Block Characteristics

| | |
|---------------------------------|---|
| Data Types | double fixed point integer single |
| Direct Feedthrough | no |
| Multidimensional Signals | no |
| Variable-Size Signals | no |
| Zero-Crossing Detection | no |

Compatibility Considerations

ReferenceBlock parameter returns different path

Behavior changed in R2021b

Starting in R2021b, the `get_param` function returns a different value for the `ReferenceBlock` parameter. The `ReferenceBlock` parameter is a property common to all Simulink blocks and gives the path of the library block to which a block links. The PID Controller and Discrete PID Controller blocks now link to 'slpidlib/PID Controller'. Previously, the blocks linked to 'pid_lib/PID Controller'.

This change does not affect any other functionality or workflows. You can still use the previous path with the `set_param` function.

ReferenceBlock parameter returns different path

Behavior changed in R2020b

Starting in R2020b, the `get_param` function returns a different value for the `ReferenceBlock` parameter. The `ReferenceBlock` parameter is a property common to all Simulink blocks and gives the path of the library block to which a block links. The PID Controller and Discrete PID Controller blocks now link to 'pid_lib/PID Controller'. Previously, the blocks linked to 'simulink/Continuous/PID Controller'.

This change does not affect any other functionality or workflows. You can still use the previous path with the `set_param` function.

References

- [1] Visioli, A., "Modified Anti-Windup Scheme for PID Controllers," *IEE Proceedings - Control Theory and Applications*, Vol. 150, Number 1, January 2003

Extended Capabilities

C/C++ Code Generation

Generate C and C++ code using Simulink® Coder™.

For continuous-time PID controllers (**Time domain** set to Continuous-time):

- Consider using "Model Discretizer" to map continuous-time blocks to discrete equivalents that support code generation. To access Model Discretizer, from your model, in the **Apps** tab, under **Control Systems**, click **Model Discretizer**.
- Not recommended for production code.

For discrete-time PID controllers (**Time domain** set to Discrete-time):

- Depends on absolute time when placed inside a triggered subsystem hierarchy.
- Generated code relies on memcpy or memset functions (`string.h`) under certain conditions.

HDL Code Generation

Generate Verilog and VHDL code for FPGA and ASIC designs using HDL Coder™.

HDL Coder provides additional configuration options that affect HDL implementation and synthesized logic.

HDL Architecture

This block has a single, default HDL architecture.

HDL Block Properties

| | |
|----------------------------------|--|
| ConstrainedOutputPipeline | Number of registers to place at the outputs by moving existing delays within your design. Distributed pipelining does not redistribute these registers. The default is 0. For more details, see "ConstrainedOutputPipeline" (HDL Coder). |
| InputPipeline | Number of input pipeline stages to insert in the generated code. Distributed pipelining and constrained output pipelining can move these registers. The default is 0. For more details, see "InputPipeline" (HDL Coder). |
| OutputPipeline | Number of output pipeline stages to insert in the generated code. Distributed pipelining and constrained output pipelining can move these registers. The default is 0. For more details, see "OutputPipeline" (HDL Coder). |

Restrictions

- HDL code generation is supported for discrete-time PID controllers only (**Time domain** set to Discrete-time).
- If the **Integrator method** is set to BackwardEuler or Trapezoidal, you cannot generate HDL code for the block under either of the following conditions:

- **Limit output** is selected and the **Anti-Windup Method** is anything other than none.
- **Enable tracking mode** is selected.
- To generate HDL code:
 - Use a discrete-time PID controller. On the **Time domain** section, specify **Discrete-time**.
 - Leave the **Use filtered derivative** check box selected.
 - Specify the initial conditions of the filter and integrator internally. On the **Initialization** tab, specify **Source** as `internal`.

You can specify the filter coefficients internally and externally for HDL code generation. On the **Main** tab, for **Source**, you can use `internal` or `external`.

- Set **External reset** to none.
- When you use double inputs, do not set **Anti-windup Method** to clamping.

PLC Code Generation

Generate Structured Text code using Simulink® PLC Coder™.

Fixed-Point Conversion

Design and simulate fixed-point systems using Fixed-Point Designer™.

Fixed-point code generation is supported for discrete-time PID controllers only (**Time domain** set to `Discrete-time`).

See Also

PID Controller (2DOF) | Gain | Integrator | Derivative | Discrete PID Controller

Introduced in R2009b

PID Controller (2DOF)

Continuous-time or discrete-time two-degree-of-freedom PID controller

Library: Simulink / Continuous

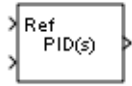

Description

The PID Controller (2DOF) block implements a two-degree-of-freedom PID controller (PID, PI, or PD). The block is identical to the Discrete PID Controller (2DOF) block with the **Time domain** parameter set to Continuous-time.

The block generates an output signal based on the difference between a reference signal and a measured system output. The block computes a weighted difference signal for the proportional and derivative actions according to the setpoint weights (**b** and **c**) that you specify. The block output is the sum of the proportional, integral, and derivative actions on the respective difference signals, where each action is weighted according to the gain parameters **P**, **I**, and **D**. A first-order pole filters the derivative action.

The block supports several controller types and structures. Configurable options in the block include:

- Controller type (PID, PI, or PD) — See the **Controller** parameter.
- Controller form (Parallel or Ideal) — See the **Form** parameter.
- Time domain (continuous or discrete) — See the **Time domain** parameter.
- Initial conditions and reset trigger — See the **Source** and **External reset** parameters.
- Output saturation limits and built-in anti-windup mechanism — See the **Limit output** parameter.
- Signal tracking for bumpless control transfer and multiloop control — See the **Enable tracking mode** parameter.

As you change these options, the internal structure of the block changes by activating different variant subsystems. (See “Variant Subsystems”.) To examine the internal structure of the block and its variant subsystems, right-click the block and select **Mask > Look Under Mask**.

Control Configuration

In one common implementation, the PID Controller block operates in the feedforward path of a feedback loop.

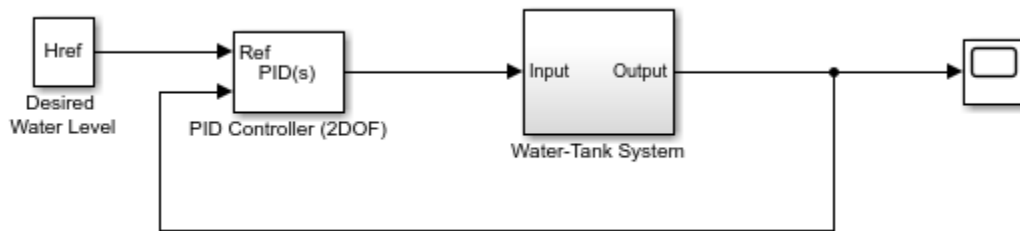

For a single-input block that accepts an error signal (a difference between a setpoint and a system output), see PID Controller.

PID Gain Tuning

The PID controller coefficients and the setpoint weights are tunable either manually or automatically. Automatic tuning requires Simulink Control Design software. For more information about automatic tuning, see the **Select tuning method** parameter.

Ports

Input

Ref — Reference signal

scalar | vector

Reference signal for plant to follow, as shown.

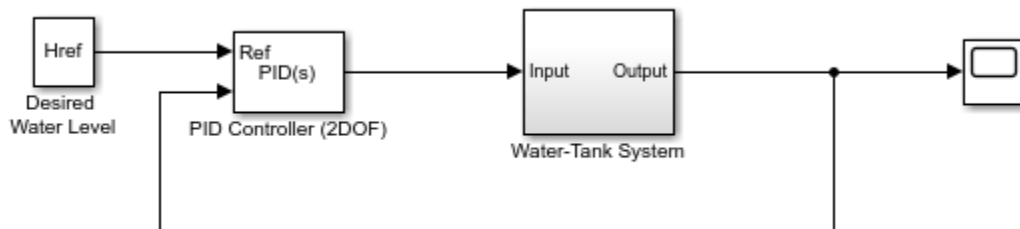

When the reference signal is a vector, the block acts separately on each signal, vectorizing the PID coefficients and producing a vector output signal of the same dimensions. You can specify the PID coefficients and some other parameters as vectors of the same dimensions as the input signal. Doing so is equivalent to specifying a separate PID controller for each entry in the input signal.

Data Types: single | double | int8 | int16 | int32 | int64 | uint8 | uint16 | uint32 | uint64 | fixed point

Port_1(y) — Measured system output

scalar | vector

Feedback signal for the controller, from the plant output.

Data Types: single | double | int8 | int16 | int32 | int64 | uint8 | uint16 | uint32 | uint64 | fixed point

P — Proportional gain

scalar | vector

Proportional gain, provided from a source external to the block. External gain input is useful, for example, when you want to map a different PID parameterization to the PID gains of the block. You can also use external gain input to implement gain-scheduled PID control. In gain-scheduled control, you determine the PID coefficients by logic or other calculation in your model and feed them to the block.

Dependencies

To enable this port, set **Controller parameters Source** to external.

Data Types: single | double | int8 | int16 | int32 | int64 | uint8 | uint16 | uint32 | uint64 | fixed point

I — Integral gain

scalar | vector

Integral gain, provided from a source external to the block. External gain input is useful, for example, when you want to map a different PID parameterization to the PID gains of the block. You can also use external gain input to implement gain-scheduled PID control. In gain-scheduled control, you determine the PID coefficients by logic or other calculation in your model and feed them to the block.

When you supply gains externally, time variations in the integral gain are also integrated. This result occurs because of the way the PID gains are implemented within the block. For details, see the **Controller parameters Source** parameter.

Dependencies

To enable this port, set **Controller parameters Source** to external, and set **Controller** to a controller type that has integral action.

Data Types: single | double | int8 | int16 | int32 | int64 | uint8 | uint16 | uint32 | uint64 | fixed point

D — Derivative gain

scalar | vector

Derivative gain, provided from a source external to the block. External gain input is useful, for example, when you want to map a different PID parameterization to the PID gains of the block. You can also use external gain input to implement gain-scheduled PID control. In gain-scheduled control, you determine the PID coefficients by logic or other calculation in your model and feed them to the block.

When you supply gains externally, time variations in the derivative gain are also differentiated. This result occurs because of the way the PID gains are implemented within the block. For details, see the **Controller parameters Source** parameter.

Dependencies

To enable this port, set **Controller parameters Source** to external, and set **Controller** to a controller type that has derivative action.

Data Types: single | double | int8 | int16 | int32 | int64 | uint8 | uint16 | uint32 | uint64 | fixed point

N – Filter coefficient

scalar | vector

Derivative filter coefficient, provided from a source external to the block. External coefficient input is useful, for example, when you want to map a different PID parameterization to the PID gains of the block. You can also use the external input to implement gain-scheduled PID control. In gain-scheduled control, you determine the PID coefficients by logic or other calculation in your model and feed them to the block.

Dependencies

To enable this port, set **Controller parameters Source** to `external`, and set **Controller** to a controller type that has a filtered derivative.

Data Types: `single` | `double` | `int8` | `int16` | `int32` | `int64` | `uint8` | `uint16` | `uint32` | `uint64` | `fixed point`

b – Proportional setpoint weight

scalar | vector

Proportional setpoint weight, provided from a source external to the block. External input is useful, for example, when you want to map a different PID parameterization to the PID gains of the block. You can also use the external input to implement gain-scheduled PID control. In gain-scheduled control, you determine the PID coefficients by logic or other calculation in your model and feed them to the block.

Dependencies

To enable this port, set **Controller parameters Source** to `external`.

Data Types: `single` | `double` | `int8` | `int16` | `int32` | `int64` | `uint8` | `uint16` | `uint32` | `uint64` | `fixed point`

c – Derivative setpoint weight

scalar | vector

Derivative setpoint weight, provided from a source external to the block. External input is useful, for example, when you want to map a different PID parameterization to the PID gains of the block. You can also use the external input to implement gain-scheduled PID control. In gain-scheduled control, you determine the PID coefficients by logic or other calculation in your model and feed them to the block.

Dependencies

To enable this port, set **Controller parameters Source** to `external`, and set **Controller** to a controller type that has derivative action.

Data Types: `single` | `double` | `int8` | `int16` | `int32` | `int64` | `uint8` | `uint16` | `uint32` | `uint64` | `fixed point`

Reset – External reset trigger

scalar

Trigger to reset the integrator and filter to their initial conditions. Use the **External reset** parameter to specify what kind of signal triggers a reset. The port icon indicates the trigger type specified in that parameter. For example, the following illustration shows a continuous-time PID Controller (2DOF) block with **External reset** set to `rising`.

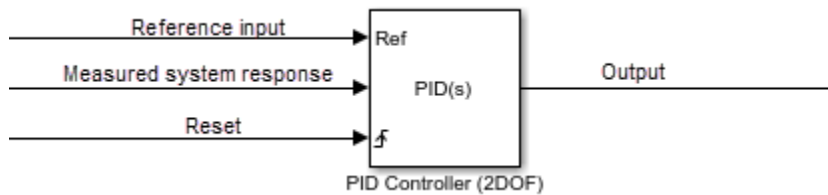

When the trigger occurs, the block resets the integrator and filter to the initial conditions specified by the **Integrator Initial condition** and **Filter Initial condition** parameters or the I_0 and D_0 ports.

Note To be compliant with the Motor Industry Software Reliability Association (MISRA) software standard, your model must use Boolean signals to drive the external reset ports of the PID controller block.

Dependencies

To enable this port, set **External reset** to any value other than none.

Data Types: single | double | int8 | int16 | int32 | int64 | uint8 | uint16 | uint32 | uint64 | fixed point | Boolean

I_0 – Integrator initial condition

scalar | vector

Integrator initial condition, provided from a source external to the block.

Dependencies

To enable this port, set **Initial conditions Source** to external, and set **Controller** to a controller type that has integral action.

Data Types: single | double | int8 | int16 | int32 | int64 | uint8 | uint16 | uint32 | uint64 | fixed point

D_0 – Filter initial condition

scalar | vector

Initial condition of the derivative filter, provided from a source external to the block.

Dependencies

To enable this port, set **Initial conditions Source** to external, and set **Controller** to a controller type that has derivative action.

Data Types: single | double | int8 | int16 | int32 | int64 | uint8 | uint16 | uint32 | uint64 | fixed point

up – Output saturation upper limit

scalar | vector

Upper limit of the block output, provided from a source external to the block. If the weighted sum of the proportional, integral, and derivative actions exceeds the value provided at this port, the block output is held at that value.

Dependencies

To enable this port, select **Limit output** and set the output saturation **Source** to **external**.

Data Types: `single` | `double` | `int8` | `int16` | `int32` | `int64` | `uint8` | `uint16` | `uint32` | `uint64` | `fixed point`

Lo — Output saturation lower limit

scalar | vector

Lower limit of the block output, provided from a source external to the block. If the weighted sum of the proportional, integral, and derivative actions goes below the value provided at this port, the block output is held at that value.

Dependencies

To enable this port, select **Limit output** and set the output saturation **Source** to **external**.

Data Types: `single` | `double` | `int8` | `int16` | `int32` | `int64` | `uint8` | `uint16` | `uint32` | `uint64` | `fixed point`

TR — Tracking signal

scalar | vector

Signal for controller output to track. When signal tracking is active, the difference between the tracking signal and the block output is fed back to the integrator input. Signal tracking is useful for implementing bumpless control transfer in systems that switch between two controllers. It can also be useful to prevent block windup in multiloop control systems. For more information, see the **Enable tracking mode** parameter.

Dependencies

To enable this port, select the **Enable tracking mode** parameter.

Data Types: `single` | `double` | `int8` | `int16` | `int32` | `int64` | `uint8` | `uint16` | `uint32` | `uint64` | `fixed point`

T_{DTI} — Discrete-integrator time

scalar

Discrete-integrator time, provided as a scalar to the block. You can use your own value of discrete-time integrator sample time that defines the rate at which the block is going to be run either in Simulink or on external hardware. The value of the discrete-time integrator time should match the average sampling rate of the external interrupts, when the block is used inside a conditionally-executed subsystem.

In other words, you can specify T_s for any of the integrator methods below such that the value matches the average sampling rate of the external interrupts. In discrete time, the derivative term of the controller transfer function is:

$$D \left[\frac{N}{1 + N\alpha(z)} \right],$$

where $\alpha(z)$ depends on the integrator method you specify with this parameter.

Forward Euler

$$\alpha(z) = \frac{T_s}{z - 1}.$$

Backward Euler

$$\alpha(z) = \frac{T_s z}{z - 1}.$$

Trapezoidal

$$\alpha(z) = \frac{T_s z + 1}{2 z - 1} \cdot$$

For more information about discrete-time integration, see the Discrete-Time Integrator block reference page. For more information on conditionally executed subsystems, see “Conditionally Executed Subsystems Overview”.

Dependencies

To enable this port, set **Time Domain** to Discrete-time and select the **PID Controller is inside a conditionally executed subsystem** option.

Data Types: single | double | int8 | int16 | int32 | int64 | uint8 | uint16 | uint32 | uint64

Output

Port_1(u) – Controller output

scalar | vector

Controller output, generally based on a sum of the input signal, the integral of the input signal, and the derivative of the input signal, weighted by the setpoint weights and by the proportional, integral, and derivative gain parameters. A first-order pole filters the derivative action. Which terms are present in the controller signal depends on what you select for the **Controller** parameter. The base controller transfer function for the current settings is displayed in the **Compensator formula** section of the block parameters and under the mask. Other parameters modify the block output, such as saturation limits specified by the **Upper Limit** and **Lower Limit** saturation parameters.

The controller output is a vector signal when any of the inputs is a vector signal. In that case, the block acts as N independent PID controllers, where N is the number of signals in the input vector.

Data Types: single | double | int8 | int16 | int32 | int64 | uint8 | uint16 | uint32 | uint64 | fixed point

Parameters

Controller – Controller type

PID (default) | PI | PD

Specify which of the proportional, integral, and derivative terms are in the controller.

PID

Proportional, integral, and derivative action.

PI

Proportional and integral action only.

PD

Proportional and derivative action only.

Tip The controller output for the current setting is displayed in the **Compensator formula** section of the block parameters and under the mask.

Programmatic Use

Block Parameter: Controller

Type: string, character vector

Values: "PID", "PI", "PD"

Default: "PID"

Form – Controller structure

Parallel (default) | Ideal

Specify whether the controller structure is parallel or ideal.

Parallel

The proportional, integral, and derivative gains **P**, **I**, and **D**, are applied independently. For example, for a continuous-time 2-DOF PID controller in parallel form, the controller output u is:

$$u = P(br - y) + I\frac{1}{s}(r - y) + D\frac{N}{1 + N\frac{1}{s}}(cr - y),$$

where r is the reference signal, y is the measured plant output signal, and b and c are the setpoint weights.

For a discrete-time 2-DOF controller in parallel form, the controller output is:

$$u = P(br - y) + I\alpha(z)(r - y) + D\frac{N}{1 + N\beta(z)}(cr - y),$$

where the **Integrator method** and **Filter method** parameters determine $\alpha(z)$ and $\beta(z)$, respectively.

Ideal

The proportional gain **P** acts on the sum of all actions. For example, for a continuous-time 2-DOF PID controller in ideal form, the controller output is:

$$u = P\left[(br - y) + I\frac{1}{s}(r - y) + D\frac{N}{1 + N\frac{1}{s}}(cr - y)\right].$$

For a discrete-time 2-DOF PID controller in ideal form, the transfer function is:

$$u = P\left[(br - y) + I\alpha(z)(r - y) + D\frac{N}{1 + N\beta(z)}(cr - y)\right],$$

where the **Integrator method** and **Filter method** parameters determine $\alpha(z)$ and $\beta(z)$, respectively.

Tip The controller output for the current settings is displayed in the **Compensator formula** section of the block parameters and under the mask.

Programmatic Use

Block Parameter: Controller

Type: string, character vector

Values: "Parallel", "Ideal"

Default: "Parallel"

Time domain — Specify continuous-time or discrete-time controller

Continuous-time (default) | Discrete-time

When you select **Discrete-time**, it is recommended that you specify an explicit sample time for the block. See the **Sample time (-1 for inherited)** parameter. Selecting **Discrete-time** also enables the **Integrator method**, and **Filter method** parameters.

When the PID Controller block is in a model with synchronous state control (see the State Control block), you cannot select **Continuous-time**.

Note The PID Controller (2DOF) and Discrete PID Controller (2DOF) blocks are identical except for the default value of this parameter.

Programmatic Use

Block Parameter: TimeDomain

Type: string, character vector

Values: "Continuous-time", "Discrete-time"

Default: "Continuous-time"

PID Controller is inside a conditionally executed subsystem — Enable the discrete-integrator time port

off (default) | on

For discrete-time PID controllers, enable the discrete-time integrator port to use your own value of discrete-time integrator sample time. To ensure proper integration, Use the T_{DTI} port to provide a scalar value of Δt for accurate discrete-time integration.

Dependencies

To enable this parameter, set **Time Domain** to **Discrete-time**.

Programmatic Use

Block Parameter: UseExternalTs

Type: string, character vector

Values: "on", "off"

Default: "off"

Sample time (-1 for inherited) — Discrete interval between samples

-1 (default) | positive scalar

Specify a sample time by entering a positive scalar value, such as 0.1. The default discrete sample time of -1 means that the block inherits its sample time from upstream blocks. However, it is recommended that you set the controller sample time explicitly, especially if you expect the sample time of upstream blocks to change. The effect of the controller coefficients P, I, D, and N depend on

the sample time. Thus, for a given set of coefficient values, changing the sample time changes the performance of the controller.

See “Specify Sample Time” for more information.

To implement a continuous-time controller, set **Time domain** to Continuous -time.

Tip If you want to run the block with an externally specified or variable sample time, set this parameter to -1 and put the block in a Triggered Subsystem. Then, trigger the subsystem at the desired sample time.

Dependencies

To enable this parameter, set **Time domain** to Discrete -time.

Programmatic Use

Block Parameter: SampleTime

Type: scalar

Values: -1, positive scalar

Default: -1

Integrator method — Method for computing integral in discrete-time controller

Forward Euler (default) | Backward Euler | Trapezoidal

In discrete time, the integral term of the controller transfer function is $Ia(z)$, where $a(z)$ depends on the integrator method you specify with this parameter.

Forward Euler

Forward rectangular (left-hand) approximation,

$$\alpha(z) = \frac{T_s}{z - 1} \cdot$$

This method is best for small sampling times, where the Nyquist limit is large compared to the bandwidth of the controller. For larger sampling times, the Forward Euler method can result in instability, even when discretizing a system that is stable in continuous time.

Backward Euler

Backward rectangular (right-hand) approximation,

$$\alpha(z) = \frac{T_s z}{z - 1} \cdot$$

An advantage of the Backward Euler method is that discretizing a stable continuous-time system using this method always yields a stable discrete-time result.

Trapezoidal

Bilinear approximation,

$$\alpha(z) = \frac{T_s z + 1}{2 z - 1} \cdot$$

An advantage of the Trapezoidal method is that discretizing a stable continuous-time system using this method always yields a stable discrete-time result. Of all available integration methods, the Trapezoidal method yields the closest match between frequency-domain properties of the discretized system and the corresponding continuous-time system.

Tip The controller formula for the current setting is displayed in the **Compensator formula** section of the block parameters and under the mask.

For more information about discrete-time integration, see the Discrete-Time Integrator block reference page.

Dependencies

To enable this parameter, set **Time Domain** to Discrete-time and set **Controller** to a controller type with integral action.

Programmatic Use

Block Parameter: IntegratorMethod

Type: string, character vector

Values: "Forward Euler", "Backward Euler", "Trapezoidal"

Default: "Forward Euler"

Filter method – Method for computing derivative in discrete-time controller

Forward Euler (default) | Backward Euler | Trapezoidal

In discrete time, the derivative term of the controller transfer function is:

$$D \left[\frac{N}{1 + N\alpha(z)} \right],$$

where $\alpha(z)$ depends on the filter method you specify with this parameter.

Forward Euler

Forward rectangular (left-hand) approximation,

$$\alpha(z) = \frac{T_s}{z - 1}.$$

This method is best for small sampling times, where the Nyquist limit is large compared to the bandwidth of the controller. For larger sampling times, the Forward Euler method can result in instability, even when discretizing a system that is stable in continuous time.

Backward Euler

Backward rectangular (right-hand) approximation,

$$\alpha(z) = \frac{T_s z}{z - 1}.$$

An advantage of the Backward Euler method is that discretizing a stable continuous-time system using this method always yields a stable discrete-time result.

Trapezoidal

Bilinear approximation,

$$\alpha(z) = \frac{T_s z + 1}{2 z - 1}.$$

An advantage of the Trapezoidal method is that discretizing a stable continuous-time system using this method always yields a stable discrete-time result. Of all available integration methods, the Trapezoidal method yields the closest match between frequency-domain properties of the discretized system and the corresponding continuous-time system.

Tip The controller formula for the current setting is displayed in the **Compensator formula** section of the block parameters and under the mask.

For more information about discrete-time integration, see the Discrete-Time Integrator block reference page.

Dependencies

To enable this parameter, set **Time Domain** to Discrete-time and enable **Use filtered derivative**.

Programmatic Use

Block Parameter: FilterMethod

Type: string, character vector

Values: "Forward Euler", "Backward Euler", "Trapezoidal"

Default: "Forward Euler"

Main

Source — Source for controller gains and filter coefficient

internal (default) | external

internal

Specify the controller gains, filter coefficient, and setpoint weights using the block parameters **P**, **I**, **D**, **N**, **b**, and **c** respectively.

external

Specify the PID gains, filter coefficient, and setpoint weights externally using block inputs. An additional input port appears on the block for each parameter that is required for the current controller type.

Enabling external inputs for the parameters allows you to compute their values externally to the block and provide them to the block as signal inputs.

External input is useful, for example, when you want to map a different PID parameterization to the PID gains of the block. You can also use external gain input to implement gain-scheduled PID control. In gain-scheduled control, you determine the PID gains by logic or other calculation in your model and feed them to the block.

When you supply gains externally, time variations in the integral and derivative gain values are integrated and differentiated, respectively. The derivative setpoint weight c is also differentiated. This result occurs because in both continuous time and discrete time, the gains are applied to the signal before integration or differentiation. For example, for a continuous-time PID controller with external inputs, the integrator term is implemented as shown in the following illustration.



Within the block, the input signal u is multiplied by the externally supplied integrator gain, I , before integration. This implementation yields:

$$u_i = \int (r - y)I dt.$$

Thus, the integrator gain is included in the integral. Similarly, in the derivative term of the block, multiplication by the derivative gain precedes the differentiation, which causes the derivative gain D and the derivative setpoint weight c to be differentiated.

Programmatic Use

Block Parameter: ControllerParametersSource

Type: string, character vector

Values: "internal", "external"

Default: "internal"

Proportional (P) — Proportional gain

1 (default) | scalar | vector

Specify a finite, real gain value for the proportional gain. When **Controller form** is:

- **Parallel** — Proportional action is independent of the integral and derivative actions. For example, for a continuous-time 2-DOF PID controller in parallel form, the controller output u is:

$$u = P(br - y) + I\frac{1}{s}(r - y) + D\frac{N}{1 + N\frac{1}{s}}(cr - y),$$

where r is the reference signal, y is the measured plant output signal, and b and c are the setpoint weights.

For a discrete-time 2-DOF controller in parallel form, the controller output is:

$$u = P(br - y) + I\alpha(z)(r - y) + D\frac{N}{1 + N\beta(z)}(cr - y),$$

where the **Integrator method** and **Filter method** parameters determine $\alpha(z)$ and $\beta(z)$, respectively.

- **Ideal** — The proportional gain multiplies the integral and derivative terms. For example, for a continuous-time 2-DOF PID controller in ideal form, the controller output is:

$$u = P\left[(br - y) + I\frac{1}{s}(r - y) + D\frac{N}{1 + N\frac{1}{s}}(cr - y)\right].$$

For a discrete-time 2-DOF PID controller in ideal form, the transfer function is:

$$u = P\left[(br - y) + I\alpha(z)(r - y) + D\frac{N}{1 + N\beta(z)}(cr - y)\right],$$

where the **Integrator method** and **Filter method** parameters determine $\alpha(z)$ and $\beta(z)$, respectively.

Tunable: Yes

Dependencies

To enable this parameter, set the Controller parameters **Source** to `internal`.

Programmatic Use

Block Parameter: P

Type: scalar, vector

Default: 1

Integral (I) — Integral gain

1 (default) | scalar | vector

Specify a finite, real gain value for the integral gain.

Tunable: Yes

Dependencies

To enable this parameter, in the **Main** tab, set the controller-parameters **Source** to `internal`, and set **Controller** to a type that has integral action.

Programmatic Use**Block Parameter:** I**Type:** scalar, vector**Default:** 1**Derivative (D) – Derivative gain**

0 (default) | scalar | vector

Specify a finite, real gain value for the derivative gain.

Tunable: Yes**Dependencies**

To enable this parameter, in the **Main** tab, set the controller-parameters **Source** to `internal`, and set **Controller** to PID or PD.

Programmatic Use**Block Parameter:** D**Type:** scalar, vector**Default:** 0**Use filtered derivative – Apply filter to derivative term**`on` (default) | `off`

For discrete-time PID controllers only, clear this option to replace the filtered derivative with an unfiltered discrete-time differentiator. When you do so, the derivative term of the controller output becomes:

$$D \frac{z - 1}{z T_s} (cr - y) .$$

For continuous-time PID controllers, the derivative term is always filtered.

Dependencies

To enable this parameter, set **Time domain** to `Discrete-time`, and set **Controller** to a type that has a derivative term.

Programmatic Use**Block Parameter:** UseFilter**Type:** string, character vector**Values:** "on", "off"**Default:** "on"

Filter coefficient (N) – Derivative filter coefficient

100 (default) | scalar | vector

Specify a finite, real gain value for the filter coefficient. The filter coefficient determines the pole location of the filter in the derivative action of the block. The location of the filter pole depends on the **Time domain** parameter.

- When **Time domain** is Continuous-time, the pole location is $s = -N$.
- When **Time domain** is Discrete-time, the pole location depends on the **Filter method** parameter.

| Filter Method | Location of Filter Pole |
|----------------|--|
| Forward Euler | $z_{pole} = 1 - NT_s$ |
| Backward Euler | $z_{pole} = \frac{1}{1 + NT_s}$ |
| Trapezoidal | $z_{pole} = \frac{1 - NT_s/2}{1 + NT_s/2}$ |

The block does not support $N = \text{Inf}$ (ideal unfiltered derivative). When the **Time domain** is Discrete-time, you can clear **Use filtered derivative** to remove the derivative filter.

Tunable: Yes

Dependencies

To enable this parameter, in the **Main** tab, set the controller-parameters **Source** to internal and set **Controller** to PID or PD.

Programmatic Use

Block Parameter: N

Type: scalar, vector

Default: 100

Setpoint weight (b) – Proportional setpoint weight

1 (default) | scalar | vector

Setpoint weight on the proportional term of the controller. The proportional term of a 2-DOF controller output is $P(br-y)$, where r is the reference signal and y is the measured plant output. Setting b to 0 eliminates proportional action on the reference signal, which can reduce overshoot in the system response to step changes in the setpoint. Changing the relative values of b and c changes the balance between disturbance rejection and setpoint tracking.

Tunable: Yes

Dependencies

To enable this parameter, in the **Main** tab, set the controller-parameters **Source** to internal.

Programmatic Use

Block Parameter: b

Type: scalar, vector

Default: 1

Setpoint weight (c) – Derivative setpoint weight

1 (default) | scalar | vector

Setpoint weight on the derivative term of the controller. The derivative term of a 2-DOF controller acts on $cr-y$, where r is the reference signal and y is the measured plant output. Thus, setting c to 0 eliminates derivative action on the reference signal, which can reduce transient response to step changes in the setpoint. Setting c to 0 can yield a controller that achieves both effective disturbance rejection and smooth setpoint tracking without excessive transient response. Changing the relative values of b and c changes the balance between disturbance rejection and setpoint tracking.

Tunable: Yes**Dependencies**

To enable this parameter, in the **Main** tab, set the controller-parameters **Source** to `internal` and set **Controller** to a type that has derivative action.

Programmatic Use**Block Parameter:** `c`**Type:** scalar, vector**Default:** 1**Select tuning method – Tool for automatic tuning of controller coefficients**

Transfer Function Based (PID Tuner App) (default) | Frequency Response Based

If you have Simulink Control Design software, you can automatically tune the PID coefficients when they are internal to the block. To do so, use this parameter to select a tuning tool, and click **Tune**.

Transfer Function Based (PID Tuner App)

Use **PID Tuner**, which lets you interactively tune PID coefficients while examining relevant system responses to validate performance. **PID Tuner** can tune all the coefficients **P**, **I**, **D**, and **N**, and the setpoint coefficients **b** and **c**. By default, **PID Tuner** works with a linearization of your plant model. For models that cannot be linearized, you can tune PID coefficients against a plant model estimated from simulated or measured response data. For more information, see “Design Two-Degree-of-Freedom PID Controllers” (Simulink Control Design).

Frequency Response Based

Use **Frequency Response Based PID Tuner**, which tunes PID controller coefficients based on frequency-response estimation data obtained by simulation. This tuning approach is especially useful for plants that are not linearizable or that linearize to zero. **Frequency Response Based PID Tuner** tunes the coefficients **P**, **I**, **D**, and **N**, but does not tune the setpoint coefficients **b** and **c**. For more information, see “Design PID Controller from Plant Frequency-Response Data” (Simulink Control Design).

Both of these tuning methods assume a single-loop control configuration. Simulink Control Design software includes other tuning approaches that suit more complex configurations. For information about other ways to tune a PID Controller block, see “Choose a Control Design Approach” (Simulink Control Design).

Dependencies

To enable this parameter, in the **Main** tab, set the controller-parameters **Source** to `internal`.

Enable zero-crossing detection – Detect zero crossings on reset and on entering or leaving a saturation state

on (default) | off

Zero-crossing detection can accurately locate signal discontinuities without resorting to excessively small time steps that can lead to lengthy simulation times. If you select **Limit output** or activate **External reset** in your PID Controller block, activating zero-crossing detection can reduce computation time in your simulation. Selecting this parameter activates zero-crossing detection:

- At initial-state reset
- When entering an upper or lower saturation state
- When leaving an upper or lower saturation state

For more information about zero-crossing detection, see “Zero-Crossing Detection”.

Programmatic Use

Block Parameter: ZeroCross

Type: string, character vector

Values: "on", "off"

Default: "on"

Initialization

Source — Source for integrator and derivative initial conditions

`internal` (default) | `external`

Simulink uses initial conditions to initialize the integrator and derivative-filter (or the unfiltered derivative) output at the start of a simulation or at a specified trigger event. (See the **External reset** parameter.) These initial conditions determine the initial block output. Use this parameter to select how to supply the initial condition values to the block.

`internal`

Specify the initial conditions using the **Integrator Initial condition** and **Filter Initial condition** parameters. If **Use filtered derivative** is not selected, use the **Differentiator** parameter to specify the initial condition for the unfiltered differentiator instead of a filter initial condition.

`external`

Specify the initial conditions externally using block inputs. Additional input ports **I_o** and **D_o** appear on the block. If **Use filtered derivative** is not selected, supply the initial condition for the unfiltered differentiator at **D_o** instead of a filter initial condition.

Programmatic Use

Block Parameter: InitialConditionSource

Type: string, character vector

Values: "internal", "external"

Default: "internal"

Integrator — Integrator initial condition

0 (default) | scalar | vector

Simulink uses the integrator initial condition to initialize the integrator at the start of a simulation or at a specified trigger event (see **External reset**). The integrator initial condition and the filter initial condition determine the initial output of the PID controller block.

The integrator initial condition cannot be NaN or Inf.

Dependencies

To use this parameter, in the **Initialization** tab, set **Source** to `internal`, and set **Controller** to a type that has integral action.

Programmatic Use

Block Parameter: `InitialConditionForIntegrator`

Type: scalar, vector

Default: 0

Filter – Filter initial condition

0 (default) | scalar | vector

Simulink uses the filter initial condition to initialize the derivative filter at the start of a simulation or at a specified trigger event (see **External reset**). The integrator initial condition and the filter initial condition determine the initial output of the PID controller block.

The filter initial condition cannot be NaN or Inf.

Dependencies

To use this parameter, in the **Initialization** tab, set **Source** to `internal`, and use a controller that has a derivative filter.

Programmatic Use

Block Parameter: `InitialConditionForFilter`

Type: scalar, vector

Default: 0

Differentiator – Initial condition for unfiltered derivative

0 (default) | scalar | vector

When you use an unfiltered derivative, Simulink uses this parameter to initialize the differentiator at the start of a simulation or at a specified trigger event (see **External reset**). The integrator initial condition and the derivative initial condition determine the initial output of the PID controller block.

The derivative initial condition cannot be NaN or Inf.

Dependencies

To use this parameter, set **Time domain** to `Discrete-time`, clear the **Use filtered derivative** check box, and in the **Initialization** tab, set **Source** to `internal`.

Programmatic Use

Block Parameter: `DifferentiatorICPrevScaledInput`

Type: scalar, vector

Default: 0

Initial condition setting – Location at which initial condition is applied

State (most efficient) (default) | Output

Use this parameter to specify whether to apply the **Integrator Initial condition** and **Filter Initial condition** parameter to the corresponding block state or output. You can change this parameter at the command line only, using `set_param` to set the `InitialConditionSetting` parameter of the block.

State (most efficient)

Use this option in all situations except when the block is in a triggered subsystem or a function-call subsystem and simplified initialization mode is enabled.

Output

Use this option when the block is in a triggered subsystem or a function-call subsystem and simplified initialization mode is enabled.

For more information about the **Initial condition setting** parameter, see the Discrete-Time Integrator block.

This parameter is only accessible through programmatic use.

Programmatic Use

Block Parameter: InitialConditionSetting

Type: string, character vector

Values: "state", "output"

Default: "state"

External reset — Trigger for resetting integrator and filter values

none (default) | rising | falling | either | level

Specify the trigger condition that causes the block to reset the integrator and filter to initial conditions. (If **Use filtered derivative** is not selected, the trigger resets the integrator and differentiator to initial conditions.) Selecting any option other than **none** enables the **Reset** port on the block for the external reset signal.

none

The integrator and filter (or differentiator) outputs are set to initial conditions at the beginning of simulation, and are not reset during simulation.

rising

Reset the outputs when the reset signal has a rising edge.

falling

Reset the outputs when the reset signal has a falling edge.

either

Reset the outputs when the reset signal either rises or falls.

level

Reset the outputs when the reset signal either:

- Is nonzero at the current time step
- Changes from nonzero at the previous time step to zero at the current time step

This option holds the outputs to the initial conditions while the reset signal is nonzero.

Dependencies

To enable this parameter, set **Controller** to a type that has derivative or integral action.

Programmatic Use

Block Parameter: ExternalReset

Type: string, character vector

Values: "none", "rising", "falling", "either", "level"

Default: "none"

Ignore reset when linearizing – Force linearization to ignore reset

off (default) | on

Select to force Simulink and Simulink Control Design linearization commands to ignore any reset mechanism specified in the **External reset** parameter. Ignoring reset states allows you to linearize a model around an operating point even if that operating point causes the block to reset.

Programmatic Use

Block Parameter: IgnoreLimit

Type: string, character vector

Values: "off", "on"

Default: "off"

Enable tracking mode – Activate signal tracking

off (default) | on

Signal tracking lets the block output follow a tracking signal that you provide at the **TR** port. When signal tracking is active, the difference between the tracking signal and the block output is fed back to the integrator input with a gain K_t , specified by the **Tracking gain (Kt)** parameter. Signal tracking has several applications, including bumpless control transfer and avoiding windup in multiloop control structures.

Bumpless control transfer

Use signal tracking to achieve bumpless control transfer in systems that switch between two controllers. Suppose you want to transfer control between a PID controller and another controller. To do so, connecting the controller output to the **TR** input as shown in the following illustration.

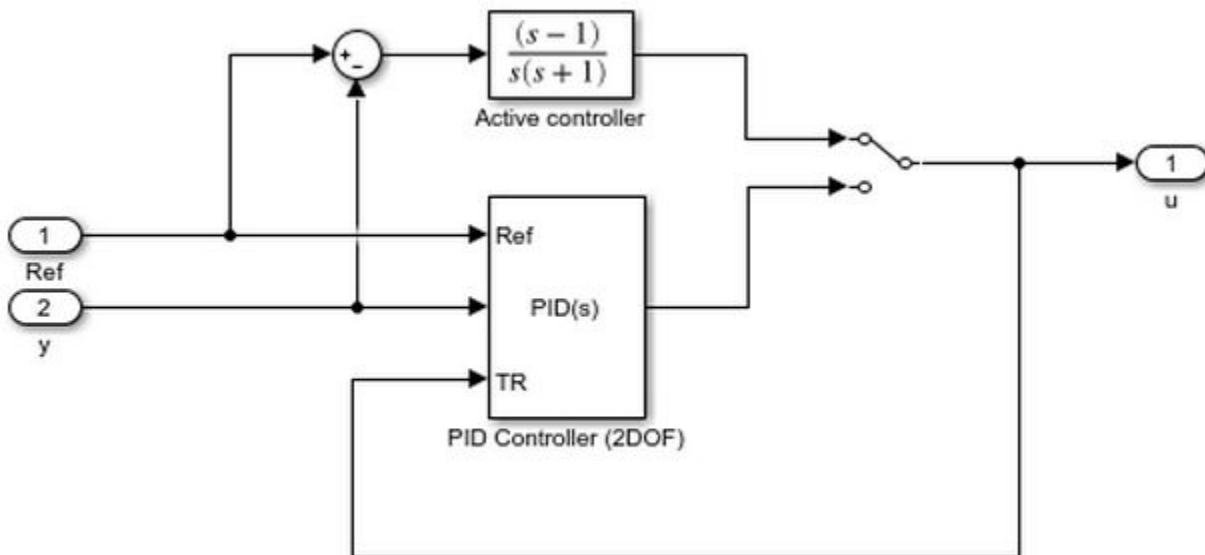

For more information, see “Bumpless Control Transfer with a Two-Degree-of-Freedom PID Controller” on page 12-101.

Multiloop control

Use signal tracking to prevent block windup in multiloop control approaches. For an example illustrating this approach with a 1DOF PID controller, see “Prevent Block Windup in Multiloop Control” on page 12-99.

Dependencies

To enable this parameter, set **Controller** to a type that has integral action.

Programmatic Use

Block Parameter: TrackingMode

Type: string, character vector

Values: "off", "on"

Default: "off"

Tracking coefficient (Kt) — Gain of signal-tracking feedback loop

1 (default) | scalar

When you select **Enable tracking mode**, the difference between the signal **TR** and the block output is fed back to the integrator input with a gain K_t . Use this parameter to specify the gain in that feedback loop.

Dependencies

To enable this parameter, select **Enable tracking mode**.

Programmatic Use

Block Parameter: Kt

Type: scalar

Default: 1

Output saturation

Limit Output — Limit block output to specified saturation values

off (default) | on

Activating this option limits the block output, so that you do not need a separate Saturation on page 1-1512 block after the controller. It also allows you to activate the anti-windup mechanism built into the block (see the **Anti-windup method** parameter). Specify the output saturation limits using the **Lower limit** and **Upper limit** parameters. You can also specify the saturation limits externally as block input ports.

Programmatic Use

Block Parameter: LimitOutput

Type: string, character vector

Values: "off", "on"

Default: "off"

Source — Source for output saturation limits

internal (default) | external

Use this parameter to specify how to supply the upper and lower saturation limits of the block output.

internal

Specify the output saturation limits using the **Upper limit** and **Lower limit** parameters.

external

Specify the output saturation limits externally using block input ports. The additional input ports **up** and **lo** appear on the block. You can use the input ports to implement the upper and lower output saturation limits determined by logic or other calculations in the Simulink model and passed to the block.

Programmatic Use

Block Parameter: SatLimitsSource

Type: string, character vector

Values: "internal", "external"

Default: "internal"

Upper limit — Upper saturation limit for block output

Inf (default) | scalar

Specify the upper limit for the block output. The block output is held at the **Upper saturation limit** whenever the weighted sum of the proportional, integral, and derivative actions exceeds that value.

Dependencies

To enable this parameter, select **Limit output**.

Programmatic Use

Block Parameter: UpperSaturationLimit

Type: scalar

Default: Inf

Lower limit — Lower saturation limit for block output

-Inf (default) | scalar

Specify the lower limit for the block output. The block output is held at the **Lower saturation limit** whenever the weighted sum of the proportional, integral, and derivative actions goes below that value.

Dependencies

To enable this parameter, select **Limit output**.

Programmatic Use

Block Parameter: LowerSaturationLimit

Type: scalar

Default: -Inf

Ignore saturation when linearizing — Force linearization to ignore output limits

off (default) | on

Force Simulink and Simulink Control Design linearization commands to ignore block output limits specified in the **Upper limit** and **Lower limit** parameters. Ignoring output limits allows you to linearize a model around an operating point even if that operating point causes the block to exceed the output limits.

Dependencies

To enable this parameter, select the **Limit output** parameter.

Programmatic Use**Block Parameter:** LinearizeAsGain**Type:** string, character vector**Values:** "off", "on"**Default:** "off"**Anti-windup method — Integrator anti-windup method**

none (default) | back-calculation | clamping

When you select **Limit output** and the weighted sum of the controller components exceeds the specified output limits, the block output holds at the specified limit. However, the integrator output can continue to grow (integrator windup), increasing the difference between the block output and the sum of the block components. In other words, the internal signals in the block can be unbounded even if the output appears bounded by saturation limits. Without a mechanism to prevent integrator windup, two results are possible:

- If the sign of the signal entering the integrator never changes, the integrator continues to integrate until it overflows. The overflow value is the maximum or minimum value for the data type of the integrator output.
- If the sign of the signal entering the integrator changes once the weighted sum has grown beyond the output limits, it can take a long time to unwind the integrator and return the weighted sum within the block saturation limit.

In either case, controller performance can suffer. To combat the effects of windup without an anti-windup mechanism, it may be necessary to detune the controller (for example, by reducing the controller gains), resulting in a sluggish controller. To avoid this problem, activate an anti-windup mechanism using this parameter.

none

Do not use an anti-windup mechanism.

back-calculation

Unwind the integrator when the block output saturates by feeding back to the integrator the difference between the saturated and unsaturated control signal. The following diagram represents the back-calculation feedback circuit for a continuous-time controller. To see the actual feedback circuit for your controller configuration, right-click on the block and select **Mask > Look Under Mask**.

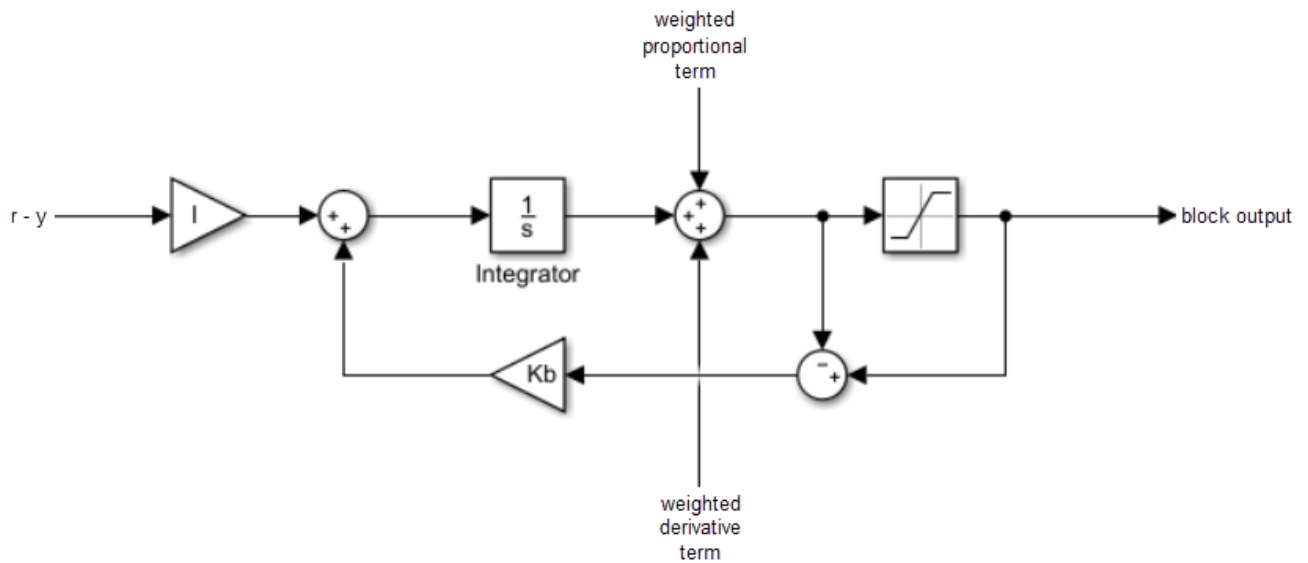

Use the **Back-calculation coefficient (Kb)** parameter to specify the gain of the anti-windup feedback circuit. It is usually satisfactory to set $Kb = I$, or for controllers with derivative action, $Kb = \sqrt{I \cdot D}$. Back-calculation can be effective for plants with relatively large dead time [1].

clamping

Integration stops when the sum of the block components exceeds the output limits and the integrator output and block input have the same sign. Integration resumes when the sum of the block components exceeds the output limits and the integrator output and block input have opposite sign. Clamping is sometimes referred to as conditional integration.

Clamping can be useful for plants with relatively small dead times, but can yield a poor transient response for large dead times [1].

Dependencies

To enable this parameter, select the **Limit output** parameter.

Programmatic Use

Block Parameter: AntiWindupMode

Type: string, character vector

Values: "none", "back-calculation", "clamping"

Default: "none"

Back-calculation coefficient (Kb) — Gain coefficient of anti-windup feedback loop

1 (default) | scalar

The **back-calculation** anti-windup method unwinds the integrator when the block output saturates. It does so by feeding back to the integrator the difference between the saturated and unsaturated control signal. Use the **Back-calculation coefficient (Kb)** parameter to specify the gain of the anti-windup feedback circuit. For more information, see the **Anti-windup method** parameter.

Dependencies

To enable this parameter, select the **Limit output** parameter, and set the **Anti-windup method** parameter to back-calculation.

Programmatic Use

Block Parameter: Kb

Type: scalar

Default: 1

Data Types

The parameters in this tab are primarily of use in fixed-point code generation using Fixed-Point Designer. They define how numeric quantities associated with the block are stored and processed when you generate code.

If you need to configure data types for fixed-point code generation, click **Open Fixed-Point Tool** and use that tool to configure the rest of the parameters in the tab. For information about using Fixed-Point Tool, see “Autoscaling Data Objects Using the Fixed-Point Tool” (Fixed-Point Designer).

After you use Fixed-Point Tool, you can use the parameters in this tab to make adjustments to fixed-point data-type settings if necessary. For each quantity associated with the block, you can specify:

- Floating-point or fixed-point data type, including whether the data type is inherited from upstream values in the block.
- The minimum and maximum values for the quantity, which determine how the quantity is scaled for fixed-point representation.

For assistance in selecting appropriate values, click  to open the Data Type Assistant for the corresponding quantity. For more information, see “Specify Data Types Using Data Type Assistant”.

| Main | | Initialization | | Output saturation | | Data Types | | State Attributes | |
|------------------------------------|------------------------------------|--|---------|-------------------|---------|------------|--|--------------------------|--|
| Fixed-point operational parameters | | | | | | | | | |
| Integer rounding mode: | | Floor | | | | | | | |
| <input type="checkbox"/> | | Saturate on integer overflow | | | | | | | |
| <input type="checkbox"/> | | Lock data type settings against changes by the fixed-point tools | | | | | | | |
| | | | | | | | | Open Fixed-Point Tool... | |
| Data Type | | | Minimum | | Maximum | | | | |
| P product output: | Inherit: Inherit via internal rule | >> | | : | | : | | : | |
| I product output: | Inherit: Inherit via internal rule | >> | | : | | : | | : | |
| D product output: | Inherit: Inherit via internal rule | >> | | : | | : | | : | |
| N product output: | Inherit: Inherit via internal rule | >> | | : | | : | | : | |
| b product output: | Inherit: Inherit via internal rule | >> | | : | | : | | : | |
| c product output: | Inherit: Inherit via internal rule | >> | | : | | : | | : | |
| Sum output: | Inherit: Inherit via internal rule | >> | | : | | : | | : | |
| ▶ Additional data types | | | | | | | | | |

The specific quantities listed in the Data Types tab vary depending on how you configure the PID controller block. In general, you can configure data types for the following types of quantities:

- Product output — Stores the result of a multiplication carried out under the block mask. For example, **P product output** stores the output of the gain block that multiplies the block input with the proportional gain **P**.
- Parameter — Stores the value of a numeric block parameter, such as **P**, **I**, or **D**.
- Block output — Stores the output of a block that resides under the PID controller block mask. For example, use **Integrator output** to specify the data type of the output of the block called Integrator. This block resides under the mask in the Integrator subsystem, and computes integrator term of the controller action.
- Accumulator — Stores values associated with a sum block. For example, **SumI2 Accumulator** sets the data type of the accumulator associated with the sum block SumI2. This block resides under the mask in the Back Calculation subsystem of the Anti-Windup subsystem.

In general, you can find the block associated with any listed parameter by looking under the PID Controller block mask and examining its subsystems. You can also use the Model Explorer to search under the mask for the listed parameter name, such as SumI2. (See **Model Explorer**.)

Matching Input and Internal Data Types

By default, all data types in the block are set to `Inherit: Inherit via internal rule`. With this setting, Simulink chooses data types to balance numerical accuracy, performance, and generated code size, while accounting for the properties of the embedded target hardware.

Under some conditions, incompatibility can occur between data types within the block. For instance, in continuous time, the Integrator block under the mask can accept only signals of type `double`. If the block input signal is a type that cannot be converted to `double`, such as `uint16`, the internal rules for type inheritance generate an error when you generate code.

To avoid such errors, you can use the Data Types settings to force a data type conversion. For instance, you can explicitly set **P product output**, **I product output**, and **D product output** to `double`, ensuring that the signals reaching the continuous-time integrators are of type `double`.

In general, it is not recommended to use the block in continuous time for code generation applications. However, similar data type errors can occur in discrete time, if you explicitly set some values to data types that are incompatible with downstream signal constraints within the block. In such cases, use the Data Types settings to ensure that all data types are internally compatible.

Fixed-Point Operational Parameters

Integer rounding mode — Rounding mode for fixed-point operations

Floor (default) | Ceiling | Convergent | Nearest | Round | Simplest | Zero

Specify the rounding mode for fixed-point operations. For more information, see “Rounding” (Fixed-Point Designer).

Block parameters always round to the nearest representable value. To control the rounding of a block parameter, enter an expression using a MATLAB rounding function into the mask field.

Programmatic Use

Block Parameter: RndMeth

Type: character vector

Values: 'Ceiling' | 'Convergent' | 'Floor' | 'Nearest' | 'Round' | 'Simplest' | 'Zero'

Default: 'Floor'

Saturate on integer overflow — Method of overflow action

off (default) | on

Specify whether overflows saturate or wrap.

- `off` — Overflows wrap to the appropriate value that the data type can represent.
For example, the number 130 does not fit in a signed 8-bit integer and wraps to -126.
- `on` — Overflows saturate to either the minimum or maximum value that the data type can represent.

For example, an overflow associated with a signed 8-bit integer can saturate to -128 or 127.

Tip

- Consider selecting this check box when your model has a possible overflow and you want explicit saturation protection in the generated code.
- Consider clearing this check box when you want to optimize efficiency of your generated code.

Clearing this check box also helps you to avoid overspecifying how a block handles out-of-range signals. For more information, see “Troubleshoot Signal Range Errors”.

- When you select this check box, saturation applies to every internal operation on the block, not just the output or result.
- In general, the code generation process can detect when overflow is not possible. In this case, the code generator does not produce saturation code.

Programmatic Use**Block Parameter:** SaturateOnIntegerOverflow**Type:** character vector**Values:** 'off' | 'on'**Default:** 'off'**Lock data type settings against changes by the fixed-point tools – Prevent fixed-point tools from overriding data types**

off (default) | on

Select this parameter to prevent the fixed-point tools from overriding the data types you specify on this block. For more information, see “Lock the Output Data Type Setting” (Fixed-Point Designer).

Programmatic Use**Block Parameter:** LockScale**Type:** character vector**Values:** 'off' | 'on'**Default:** 'off'**State Attributes**

The parameters in this tab are primarily of use in code generation.

State name (e.g., 'position') – Name for continuous-time filter and integrator states

' ' (default) | character vector

Assign a unique name to the state associated with the integrator or the filter, for continuous-time PID controllers. (For information about state names in a discrete-time PID controller, see the **State name** parameter.) The state name is used, for example:

- For the corresponding variable in generated code
- As part of the storage name when logging states during simulation
- For the corresponding state in a linear model obtain by linearizing the block

A valid state name begins with an alphabetic or underscore character, followed by alphanumeric or underscore characters.

Dependencies

To enable this parameter, set **Time domain** to Continuous-time.

Programmatic Use**Parameter:** IntegratorContinuousStateAttributes, FilterContinuousStateAttributes**Type:** character vector**Default:** ' '**State name – Names for discrete-time filter and integrator states**

empty string (default) | string | character vector

Assign a unique name to the state associated with the integrator or the filter, for discrete-time PID controllers. (For information about state names in a continuous-time PID controller, see the **State name (e.g., 'position')** parameter.)

A valid state name begins with an alphabetic or underscore character, followed by alphanumeric or underscore characters. The state name is used, for example:

- For the corresponding variable in generated code
- As part of the storage name when logging states during simulation
- For the corresponding state in a linear model obtain by linearizing the block

For more information about the use of state names in code generation, see “C Code Generation Configuration for Model Interface Elements” (Simulink Coder).

Dependencies

To enable this parameter, set **Time domain** to Discrete-time.

Programmatic Use

Parameter: IntegratorStateIdentifier, FilterStateIdentifier

Type: string, character vector

Default: ""

State name must resolve to Simulink signal object — Require that state name resolve to a signal object

off (default) | on

Select this parameter to require that the discrete-time integrator or filter state name resolves to a Simulink signal object.

Dependencies

To enable this parameter for the discrete-time integrator or filter state:

- 1 Set **Time domain** to Discrete-time.
- 2 Specify a value for the integrator or filter **State name**.
- 3 Set the model configuration parameter **Signal resolution** to a value other than None.

Programmatic Use

Block Parameter: IntegratorStateMustResolveToSignalObject, FilterStateMustResolveToSignalObject

Type: string, character vector

Values: "off", "on"

Default: "off"

Block Characteristics

| | |
|---------------------------------|---|
| Data Types | double fixed point integer single |
| Direct Feedthrough | no |
| Multidimensional Signals | no |
| Variable-Size Signals | no |

| | |
|--------------------------------|----|
| Zero-Crossing Detection | no |
|--------------------------------|----|

More About

Decomposition of 2-DOF PID Controllers

A 2-DOF PID controller can be interpreted as a PID controller with a prefilter, or a PID controller with a feedforward element.

Prefilter Decomposition

In parallel form, a two-degree-of-freedom PID controller can be equivalently modeled by the following block diagram, where C is a single degree-of-freedom PID controller and F is a prefilter on the reference signal.

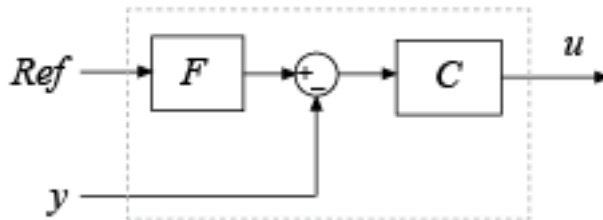

Ref is the reference signal, y is the feedback from the measured system output, and u is the controller output. For a continuous-time 2-DOF PID controller in parallel form, the transfer functions for F and C are

$$F_{par}(s) = \frac{(bP + cDN)s^2 + (bPN + I)s + IN}{(P + DN)s^2 + (PN + I)s + IN},$$

$$C_{par}(s) = \frac{(P + DN)s^2 + (PN + I)s + IN}{s(s + N)},$$

where b and c are the setpoint weights.

For a 2-DOF PID controller in ideal form, the transfer functions are

$$F_{id}(s) = \frac{(b + cDN)s^2 + (bN + I)s + IN}{(1 + DN)s^2 + (N + I)s + IN},$$

$$C_{id}(s) = P \frac{(1 + DN)s^2 + (N + I)s + IN}{s(s + N)}.$$

A similar decomposition applies for a discrete-time 2-DOF controller.

Feedforward Decomposition

Alternatively, the parallel two-degree-of-freedom PID controller can be modeled by the following block diagram.

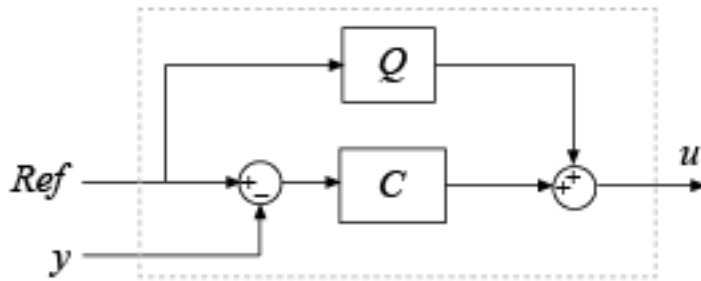

In this realization, Q acts as feed-forward conditioning on the reference signal. For a continuous-time 2-DOF PID controller in parallel form, the transfer function for Q is

$$Q_{par}(s) = \frac{((b-1)P + (c-1)DN)s + (b-1)PN}{s + N}.$$

For a 2-DOF PID controller in ideal form, the transfer function is

$$Q_{id}(s) = P \frac{((b-1) + (c-1)DN)s + (b-1)N}{s + N}.$$

The transfer functions for C are the same as in the filter decomposition.

A similar decomposition applies for a discrete-time 2-DOF controller.

Compatibility Considerations

ReferenceBlock parameter returns different path

Behavior changed in R2021b

Starting in R2021b, the `get_param` function returns a different value for the `ReferenceBlock` parameter. The `ReferenceBlock` parameter is a property common to all Simulink blocks and gives the path of the library block to which a block links. The PID Controller (2DOF) and Discrete PID Controller (2DOF) blocks now link to `'slpidlib/PID Controller (2DOF)'`. Previously, the blocks linked to `'pid_lib/PID Controller (2DOF)'`.

This change does not affect any other functionality or workflows. You can still use the previous path with the `set_param` function.

ReferenceBlock parameter returns different path

Behavior changed in R2020b

Starting in R2020b, the `get_param` function returns a different value for the `ReferenceBlock` parameter. The `ReferenceBlock` parameter is a property common to all Simulink blocks and gives the path of the library block to which a block links. The PID Controller (2DOF) and Discrete PID Controller (2DOF) blocks now link to `'pid_lib/PID Controller (2DOF)'`. Previously, the blocks linked to `'simulink/Continuous/PID Controller (2DOF)'`.

This change does not affect any other functionality or workflows. You can still use the previous path with the `set_param` function.

References

- [1] Visioli, A., "Modified Anti-Windup Scheme for PID Controllers," *IEE Proceedings - Control Theory and Applications*, Vol. 150, Number 1, January 2003

Extended Capabilities

C/C++ Code Generation

Generate C and C++ code using Simulink® Coder™.

For continuous-time PID controllers (**Time domain** set to **Continuous-time**):

- Consider using "Model Discretizer" to map continuous-time blocks to discrete equivalents that support code generation. To access Model Discretizer, in the **Apps** tab, under **Control Systems**, click **Model Discretizer**.
- Not recommended for production code.

For discrete-time PID controllers (**Time domain** set to **Discrete-time**):

- Depends on absolute time when placed inside a triggered subsystem hierarchy.
- Generated code relies on memcpy or memset functions (`string.h`) under certain conditions.

PLC Code Generation

Generate Structured Text code using Simulink® PLC Coder™.

Fixed-Point Conversion

Design and simulate fixed-point systems using Fixed-Point Designer™.

Fixed-point code generation is supported for discrete-time PID controllers only (**Time domain** set to **Discrete-time**).

See Also

PID Controller | Gain | Integrator | Derivative | Discrete PID Controller (2DOF)

Introduced in R2009b

Polynomial

Perform evaluation of polynomial coefficients on input values

Library: Simulink / Math Operations

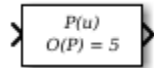

Description

The Polynomial block evaluates $P(u)$ at each time step for the input u . You define a set of polynomial coefficients in the form that the MATLAB `polyval` command accepts.

Ports

Input

Port_1 — Input signal

real scalar or vector

Value at which to evaluate the polynomial $P(u)$.

Data Types: `single` | `double`

Output

Port_1 — Evaluated polynomial value

real scalar or vector

Value of the polynomial $P(u)$ evaluated at the input signal.

Data Types: `single` | `double`

Parameters

Polynomial coefficients — Coefficients of polynomial to be evaluated

[+2.081618890e-019, -1.441693666e-014, +4.719686976e-010, -8.536869453e-006, +1.621573104e-001, -8.087801117e+001] (default) | real array

Specify polynomial coefficients in MATLAB `polyval` form. The first coefficient corresponds to x^N and the remaining coefficients correspond to decreasing orders of x . The last coefficient represents the constant for the polynomial.

Programmatic Use

Block Parameter: `coefs`

Type: real array

Default: [+2.081618890e-019, -1.441693666e-014, +4.719686976e-010, -8.536869453e-006, +1.621573104e-001, -8.087801117e+001]

Block Characteristics

| | |
|---------------------------------|-----------------|
| Data Types | double single |
| Direct Feedthrough | yes |
| Multidimensional Signals | no |
| Variable-Size Signals | no |
| Zero-Crossing Detection | no |

Extended Capabilities

C/C++ Code Generation

Generate C and C++ code using Simulink® Coder™.

PLC Code Generation

Generate Structured Text code using Simulink® PLC Coder™.

See Also

Topics

polyval

Introduced before R2006a

Prelookup

Compute index and fraction for Interpolation Using Prelookup block

Library: Simulink / Lookup Tables
HDL Coder / Lookup Tables

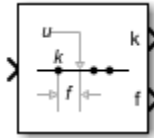

Description

The Prelookup block calculates the index and interval fraction that specify how its input value u relates to the breakpoint dataset. The Prelookup block works best with the Interpolation Using Prelookup block. Feed the resulting index and fraction values into an Interpolation Using Prelookup block to interpolate an n -dimensional table. These two blocks have distributed algorithms. When combined together, they perform the same operation as the integrated algorithm in the n -D Lookup Table block. However, the Prelookup and Interpolation Using Prelookup blocks offer greater flexibility and more efficient simulation and code generation than the n -D Lookup Table block. For more information, see “Efficiency of Performance”.

Supported Block Operations

To use the Prelookup block, you must specify a set of breakpoint values. You choose whether to specify the breakpoint values directly on the dialog box or by feeding the values to a `bp` input port by setting the **Source** parameter to `Dialog` or `Input port`. Typically, this breakpoint data set corresponds to one dimension of the table data in an Interpolation Using Prelookup block. The Prelookup block generates a pair of outputs for each input value u by calculating:

- The index of the breakpoint set element that is less than or equal to u and forms an interval containing u
- The interval fraction in the range $0 \leq f < 1$, representing the normalized position of u on the breakpoint interval between the index and the next index value for in-range input

For example, if the breakpoint data set is `[0 5 10 20 50 100]` and the input value u is 55, the index is 4 and the fractional value is 0.1. Labels for the index and interval fraction appear as **k** and **f** on the Prelookup block icon. The index value is zero based.

The interval fraction can be negative or greater than 1 for out-of-range input. See the **Extrapolation method** block parameter for more information.

Ports

Input

Port_1 — Input signal, u

scalar | vector | matrix

The Prelookup block accepts real-valued signals of any numeric data type that Simulink supports, except Boolean. The Prelookup block supports fixed-point data types for signals and breakpoint data.

Data Types: half | single | double | int8 | int16 | int32 | int64 | uint8 | uint16 | uint32 | uint64 | fixed point | enumerated | bus

bp — Breakpoint data

1-D vector of real-valued signals

The Prelookup block accepts real-valued signals as breakpoint data of any numeric data type that Simulink supports, except Boolean.

Data Types: half | single | double | int8 | int16 | int32 | int64 | uint8 | uint16 | uint32 | uint64 | fixed point | enumerated

Output

k — Index of the interval containing the input, u

scalar | vector | matrix

The zero-based index, k , is a real-valued integer that specifies the interval containing the input, u .

Dependencies

To enable this port, set the **Output selection** to Index and fraction or Index only.

Data Types: int8 | int16 | int32 | int64 | uint8 | uint16 | uint32 | uint64 | fixed point

f — Fraction representing the normalized position of the input, u, within the interval, k

scalar | vector | matrix

Fraction, f , represents the normalized position of the input, u , within the interval k .

Dependencies

To enable this port, set the **Output selection** to Index and fraction.

Data Types: single | double | fixed point

Port_2 — Bus containing index, k, and fraction, f

bus

Outputting the index, k , and fraction f , as a bus object can help simplify the model.

Dependencies

To enable this port, set the **Output selection** to Index and fraction as bus.

Data Types: bus

Parameters

Main

Breakpoints data

Specification — Choose how to enter breakpoint data

Explicit values (default) | Even spacing | Breakpoint object

If you set this parameter to:

- Explicit values, the **Source** and **Value** parameters are visible on the dialog box.
- Even spacing, the **First point**, **Spacing**, and **Number of points** parameters are visible on the dialog box.
- Breakpoint object, the **Name** parameter is visible on the dialog box.

Programmatic Use**Block Parameter:** BreakpointsSpecification**Type:** character vector**Values:** 'Explicit values' | 'Even spacing' | 'Breakpoint object'**Default:** 'Explicit values'**Source — Specify source of breakpoint data**

Dialog (default) | Input port

If you set **Source** to:

- Dialog, specify breakpoint data under **Value**.
- Input port, verify that an upstream signal supplies breakpoint data to the bp input port. Each breakpoint data set must be a strictly monotonically increasing vector that contains two or more elements. For this option, your block inherits breakpoint attributes from the bp input port.

DependenciesTo enable this parameter, set **Specification** to Explicit values.**Programmatic Use****Block Parameter:** BreakpointsDataSource**Type:** character vector**Values:** 'Dialog' | 'Input port'**Default:** 'Dialog'**Value — Breakpoint data values**

[10:10:110] (default) | vector of strictly monotonically increasing values containing two or more elements

Explicitly specify the breakpoint data. Each breakpoint data set must be a strictly monotonically increasing vector that contains two or more elements. For this option, you specify additional breakpoint attributes on the **Data Types** pane.

To open the Lookup Table Editor, click **Edit** (see “Edit Lookup Tables”).

Note When you set **Specification** to Explicit values and **Source** to Input port, verify that an upstream signal supplies breakpoint data to the bp input port. Each breakpoint data set must be a strictly monotonically increasing vector that contains two or more elements. For this option, your block inherits breakpoint attributes (including data type) from the bp input port.

DependenciesTo enable this parameter, set **Specification** to Explicit values and **Source** to Dialog.**Programmatic Use****Block Parameter:** BreakpointsData**Type:** character vector

Values: vector of strictly monotonically increasing values containing two or more elements
Default: '[10:10:110]'

First point — First point in evenly spaced breakpoint data

10 (default) | real-valued scalar

Dependencies

To enable this parameter, set **Specification** to Even spacing.

Programmatic Use

Block Parameter: BreakpointsFirstPoint

Type: character vector

Values: real-valued scalar

Default: '10'

Spacing — Spacing between evenly spaced breakpoints

10 (default) | real-valued, positive scalar

Dependencies

To enable this parameter, set **Specification** to Even spacing.

Programmatic Use

Block Parameter: BreakpointsSpacing

Type: character vector

Values: real-valued, positive scalar

Default: '10'

Number of points — Number of evenly spaced points

11 (default) | real-valued, positive scalar

Dependencies

To enable this parameter, set **Specification** to Even spacing.

Programmatic Use

Block Parameter: BreakpointsNumPoints

Type: character vector

Values: real-valued, positive scalar

Default: '11'

Name — Name of a Simulink.Breakpoint object

no default | Simulink.Breakpoint

Specify the name of a Simulink.Breakpoint object. A breakpoint object references Simulink

breakpoint objects. If a Simulink.Breakpoint object does not exist, click the action button  and select **Create**. The corresponding parameters of the new breakpoint object are automatically populated with the block information.

Dependencies

To enable this parameter, set **Specification** to Breakpoint object.

Programmatic Use

Block Parameter: BreakpointObject

Type: character vector
Values: Simulink.Breakpoint object
Default: ''

Algorithm

Output selection — Specify the signals the block outputs

Index and fraction (default) | Index and fraction as bus | Index only

If you want the block to output the index and interval fraction, you can specify whether the block outputs individual signals or a bus signal that includes both the index and fraction signals.

- `Index only` outputs just the index, without the fraction. Typical applications for this option include:
 - Feeding a Direct Lookup Table (n-D) block, with no interpolation on the interval
 - Feeding selection ports of a subtable selection for an Interpolation Using Prelookup block
 - Performing nonlinear quantizations
- `Index and fraction` outputs the index and fraction as individual signals.
- `Index and fraction as bus` outputs a bus signal that includes the index and fraction signals. Using a bus for these signals:
 - Simplifies the model by tying these two related signals together
 - Creates a testpoint `DpResult` structure for the AUTOSAR 4.0 library
 - For the AUTOSAR 4.0 library, avoids the creation of extra copies during code generation when the Prelookup and Interpolation Using Prelookup blocks are in separate models

Note Selecting `Index and fraction as bus` displays the **Output** parameter in the **Data Types** pane and sets the **Output** parameter to `Inherit: auto`. Change this default value to specify a user-defined bus object. For details about defining the bus object, see the **Output** parameter description.

Programmatic Use

Block Parameter: OutputSelection

Type: character vector

Values: 'Index and fraction' | 'Index and fraction as bus' | 'Index only'

Default: 'Index and fraction'

Index search method — Method for searching breakpoint data

Binary search (default) | Linear search | Evenly spaced points

Each search method has speed advantages in different situations:

- For evenly spaced breakpoint sets (for example, 10, 20, 30, and so on), you achieve optimal speed by selecting `Evenly spaced points` to calculate table indices. This algorithm uses only the first two breakpoints of a set to determine the offset and spacing of the remaining points.
- For unevenly spaced breakpoint sets, follow these guidelines:
 - If input values for `u` do not vary significantly between time steps, selecting `Linear search` with **Begin index search using previous index result** produces the best performance.
 - If input values for `u` jump more than one or two table intervals per time step, selecting `Binary search` produces the best performance.

A suboptimal choice of index search method can lead to slow performance of models that rely heavily on lookup tables.

Note The generated code stores only the first breakpoint, the spacing, and the number of breakpoints when:

- The breakpoint data is not tunable.
 - The index search method is `Evenly spaced points`.
-

Programmatic Use

Block Parameter: `IndexSearchMethod`

Type: character vector

Values: `'Evenly spaced points' | 'Linear search' | 'Binary search'`

Default: `'Binary search'`

Begin index search using previous index result — Start search using the index found at the previous time step

`off (default) | on`

For input values of u that change slowly with respect to the interval size, enabling this option can improve performance. Otherwise, the linear search and binary search methods can take longer, especially for large breakpoint sets.

Programmatic Use

Block Parameter: `BeginIndexSearchUsingPreviousIndexResult`

Type: character vector

Values: `'off' | 'on'`

Default: `'off'`

Extrapolation method — Method for handling out-of-range input values

`Clip (default) | Linear`

Options include:

- `Clip`

| Block Input | Block Outputs |
|----------------------------------|--|
| Less than the first breakpoint | <ul style="list-style-type: none"> • Index of the first breakpoint (for example, 0) • Interval fraction of 0 |
| Greater than the last breakpoint | <ul style="list-style-type: none"> • Index of the next-to-last breakpoint • Interval fraction of 1 |

Suppose the range is $[1 \ 2 \ 3]$ and you select this option. If u is 0.5, the index is 0 and the interval fraction is 0. If u is 3.5, the index is 1 and the interval fraction is 1.

- `Linear`

| Block Input | Block Outputs |
|----------------------------------|--|
| Less than the first breakpoint | <ul style="list-style-type: none"> • Index of the first breakpoint (for example, 0) • Interval fraction that represents the linear distance from u to the first breakpoint |
| Greater than the last breakpoint | <ul style="list-style-type: none"> • Index of the next-to-last breakpoint • Interval fraction that represents the linear distance from the next-to-last breakpoint to u |

Suppose the range is [1 2 3] and you select this option. If u is 0.5, the index is 0 and the interval fraction is -0.5. If u is 3.5, the index is 1 and the interval fraction is 1.5.

Note The Prelookup block supports linear extrapolation only when all of the following conditions are true:

- The input u, breakpoint data, and fraction output use floating-point data types.
- The index uses a built-in integer data type.

Programmatic Use

Block Parameter: ExtrapMethod

Type: character vector

Values: 'Clip' | 'Linear'

Default: 'Clip'

Use last breakpoint for input at or above upper limit — Method of handling inputs at or above upper limit

off (default) | on

Specify how to index input values of u that are greater than or equal to the last breakpoint. The index value is zero based. When input equals the last breakpoint, block outputs differ as follows.

| Check Box | Block Outputs |
|---------------|--|
| Selected (on) | <ul style="list-style-type: none"> • Index of the last element in the breakpoint data set • Interval fraction of 0 |
| Cleared (off) | <ul style="list-style-type: none"> • Index of the next-to-last breakpoint • Interval fraction of 1 |

Tip When you select **Use last breakpoint for input at or above upper limit** for a Prelookup block, you must also select **Valid index input may reach last index** for the Interpolation Using Prelookup block to which it connects. This action allows the blocks to use the same indexing convention when accessing the last elements of their breakpoint and table data sets.

Dependencies

This check box is visible only when:

- **Output only the index** is cleared
- **Extrapolation method** is Clip

However, when **Output only the index** is selected and **Extrapolation method** is Clip, the block behaves as if this check box is selected, even though it is invisible.

Programmatic Use

Block Parameter: UseLastBreakpoint

Type: character vector

Values: 'off' | 'on'

Default: 'off'

Diagnostic for out-of-range input – Block action when input is out of range

None (default) | Warning | Error

Options include:

- None — Produce no response.
- Warning — Display a warning and continue the simulation.
- Error — Terminate the simulation and display an error.

Programmatic Use

Block Parameter: DiagnosticForOutOfRangeInput

Type: character vector

Values: 'None' | 'Warning' | 'Error'

Default: 'None'

Code generation

Remove protection against out-of-range input in generated code – Remove code that checks for out-of-range breakpoint inputs

Off (default) | On

| Check Box | Result | When to Use |
|-----------|--|----------------------------------|
| On | Generated code does not include conditional statements to check for out-of-range breakpoint inputs. When the input is out-of-range, it may cause undefined behavior for generated code. | For code efficiency |
| Off | Generated code includes conditional statements to check for out-of-range breakpoint inputs. | For safety-critical applications |

If your input is not out-of-range, you can select the **Remove protection against out-of-range index in generated code** check box for code efficiency. By default, this check box is cleared. For safety-critical applications, do not select this check box. If you want to select the **Remove protection against out-of-range index in generated code** check box, first check that your model inputs are in range. For example:

- 1 Clear the **Remove protection against out-of-range index in generated code** check box.
- 2 Set the **Diagnostic for out-of-range input** parameter to Error.
- 3 Simulate the model in normal mode.
- 4 If there are out-of-range errors, fix them to be in range and run the simulation again.
- 5 When the simulation no longer generates out-of-range input errors, select the **Remove protection against out-of-range index in generated code** check box.

Note When you select the **Remove protection against out-of-range index in generated code** check box and the input is out-of-range, the behavior is undefined for generated code

Depending on your application, you can run the following Model Advisor checks to verify the usage of this check box:

Additionally, to determine if it is safe to select this check box, if you have a Simulink Design Verifier license, consider using the “Detect Block Input Range Violations” (Simulink Design Verifier) check.

- **By Product > Embedded Coder > Identify lookup table blocks that generate expensive out-of-range checking code**
- **By Product > Simulink Check > Modeling Standards > DO-178C/DO-331 Checks > Check usage of lookup table blocks**

For more information about the Model Advisor, see “Run Model Advisor Checks”.

Programmatic Use

Block Parameter: RemoveProtectionInput

Type: character vector

Values: 'off' | 'on'

Default: 'off'

Sample time — Specify sample time as a value other than -1

-1 (default) | scalar | vector

Specify the sample time as a value other than -1. For more information, see “Specify Sample Time”.

Dependencies

This parameter is not visible unless it is explicitly set to a value other than -1. To learn more, see “Blocks for Which Sample Time Is Not Recommended”.

Programmatic Use

Block Parameter: SampleTime

Type: character vector

Values: scalar or vector

Default: '-1'

Data Types

Breakpoint — Breakpoint data type

Inherit: Same as input (default) | Inherit: Inherit from 'Breakpoint data' | double | single | int8 | uint8 | int16 | uint16 | int32 | uint32 | int64 | uint64 | fixdt(1,16) | fixdt(1,16,0) | fixdt(1,16,2^0,0) | Enum: <class name> | <data type expression>

Specify the breakpoint data type. You can set it to:

- A rule that inherits a data type, for example, `Inherit: Same as input`
- The name of a built-in data type, for example, `single`
- The name of a data type class, for example, an enumerated data type class
- An expression that evaluates to a data type, for example, `fixdt(1,16,0)`

Click the **Show data type assistant** button  to display the **Data Type Assistant**, which helps you set the data type attributes. For more information, see “Specify Data Types Using Data Type Assistant”.

Tip

- Specify a breakpoint data type different from the data type of input `u` for these cases:
 - Lower memory requirement for storing breakpoint data that uses a smaller type than the input signal `u`
 - Sharing of prescaled breakpoint data between two Prelookup blocks with different data types for input `u`
 - Sharing of custom storage breakpoint data in the generated code for blocks with different data types for input `u`
- Specify the same slope and bias for a breakpoint data type and its corresponding input data type if either of them has a fixed-point data type.
- Enumerated data:
 - Breakpoints support unordered enumerated data. As a result, linear searches are also unordered, which offers flexibility but can impact performance. The search begins from the first element in the breakpoint.
 - If the **Begin index search using previous index result** check box is selected, you must use ordered monotonically increasing data. This ordering improves performance.
 - For enumerated data, **Extrapolation method** must be `Clip`.
 - Because the fraction is 1 or 0, select **Output selection > Index only**.

If you are using the index only output selection setting with the Interpolation Using Prelookup block, consider using the **Number of sub-table selection dimensions** parameter.

These are limitations for using enumerated data with this block:

- The block does not support out-of-range input for enumerated data. When specifying enumerated data, include the entire enumeration set in the breakpoint data set. For example, use the enumeration function.
- When breakpoints data source is set to `Inport port`, the enumeration data type must have 0 as the default value. For example, for this enumeration class, the default value of `GEAR1` must be 0.

```
classdef(Enumeration) Gears < Simulink.IntEnumType
    enumeration
        GEAR1(1),
        GEAR2(2),
        GEAR3(4),
        GEAR4(8),
```

```

        SPORTS(16),
        REVERSE(32),
        NEUTRAL(0)
    end
end

```

Dependencies

To enable this parameter, set the breakpoints data **Source** to Dialog.

Note When you set **Source** to Input port, the block inherits all breakpoint attributes (data type, minimum, and maximum) from the bp input port.

Programmatic Use

Block Parameter: BreakpointDataTypeStr

Type: character vector

Values: 'Inherit: Same as input' | 'Inherit: Inherit from 'Breakpoint data'' | 'double' | 'single' | 'int8' | 'uint8' | 'int16' | 'uint16' | 'int32' | 'uint32' | 'int64' | 'uint64' | 'fixdt(1,16)' | 'fixdt(1,16,0)' | 'fixdt(1,16,2^0,0)' | '<data type expression>'

Default: 'Inherit: Same as input'

Index — Index data type

uint32 (default) | int8 | uint8 | int16 | uint16 | int32 | uint32 | int64 | uint64 | fixdt(1,16) | <data type expression>

Specify a data type that can index all elements in the breakpoint data set. You can:

- Select a built-in integer data type from the list.
- Specify an integer data type using a fixed-point representation.

Click the **Show data type assistant** button  to display the **Data Type Assistant**, which helps you set the data type attributes. For more information, see “Specify Data Types Using Data Type Assistant”.

Programmatic Use

Block Parameter: IndexDataTypeStr

Type: character vector

Values:

'int8' | 'uint8' | 'int16' | 'uint16' | 'int32' | 'uint32' | 'int64' | 'uint64' | 'fixdt(1,16)' | '<data type expression>'

Default: 'uint32'

Fraction — Fraction data type

Inherit: Inherit via internal rule (default) | double | single | fixdt(1,16,0) | <data type expression>

Specify the data type of the interval fraction. You can:

- Select a built-in data type from the list.
- Specify data type inheritance through an internal rule.

- Specify a fixed-point data type using the [Slope Bias] or binary-point-only scaling representation.
 - If you use the [Slope Bias] representation, the scaling must be trivial — that is, the slope is 1 and the bias is 0.
 - If you use the binary-point-only representation, the fixed power-of-two exponent must be less than or equal to zero.

Click the **Show data type assistant** button  to display the **Data Type Assistant**, which helps you set the data type attributes. For more information, see “Specify Data Types Using Data Type Assistant”.

Dependencies

This parameter displays only when you set **Output selection** on the **Main** tab to `Index` and `fraction`.

Programmatic Use

Block Parameter: `FractionDataTypeStr`

Type: character vector

Values: `'Inherit: Inherit via internal rule'` | `'double'` | `'single'` | `'fixdt(1,16,0)'` | `'<data type expression>'`

Default: `'Inherit: Inherit via internal rule'`

Output — Output data type

`Inherit: auto (default)` | `bus: <object name>`

To output a virtual bus, use the `Inherit: auto` setting. The resulting virtual bus contains two elements, the index and the fraction signals.

To output and specify a nonvirtual bus, use the `Bus: <object name>` template. Replace `<object name>` with the name of a bus object that contains the index and fraction signals.

- The bus object must contain two elements. The first element corresponds to the index signal and the second to the fraction signal.
- The index and fraction bus element signals cannot be bus signals.
- The data type and the complexity of the bus elements must meet the same constraints that apply to the index and fraction signals if you set **Output selection** to `Index` and `fraction`.

To create the bus object with the index and fraction bus elements, use MATLAB code similar to this, customizing the bus object name and the names and data types of the bus elements.

```
% Bus object: kfBus
elems(1) = Simulink.BusElement;
elems(1).Name = 'Index';
elems(1).DataType = 'int8';

elems(2) = Simulink.BusElement;
elems(2).Name = 'Fraction';
elems(2).DataType = 'double';

kfBus = Simulink.Bus;
kfBus.Elements = elems;
clear elems;
```

Alternatively, you can use the Bus Editor to create or modify the bus object to use with the Prelookup block.

If you feed the bus output signal from this block to an Interpolation Using Prelookup block, select the **Require index and fraction as bus** check box in that block.

Note Use the Fixed-Point Tool data type override option to override bus objects with new bus objects that replace fixed-point data types with floating-point data types.

Overridden bus objects used with the Prelookup block can cause an error because the block does not accept floating-point data types for the first element in the bus.

If you encounter this issue, use the **Fix** button to redefine the original bus object and protect it from being overridden. For example, suppose you define the first element of the bus object to be an `int32`.

```
myBus.Elements(1).DataType
int32
```

Clicking the **Fix** button redefines the first bus element:

```
myBus.Elements(1).DataType = 'fixdt('int32','DataTypeOverride','0ff')
```

Click the **Show data type assistant** button  to display the **Data Type Assistant**, which helps you set the data type attributes. For more information, see “Specify Data Types Using Data Type Assistant”.

Dependencies

This parameter displays only when you set **Output selection** on the **Main** tab to `Index` and `fraction as bus`.

Programmatic Use

Block Parameter: `OutputBusDataTypeStr`

Type: character vector

Values: `'Inherit: auto'` | `'Bus: <object name>'` | `'<data type expression>'`

Default: `'Inherit: auto'`

Breakpoint Minimum — Minimum value breakpoint data can have

`[]` (default) | scalar

Specify the minimum value that the breakpoint data can have. The default value is `[]` (unspecified).

Dependencies

To enable this parameter, set the breakpoints data **Source** to `Dialog` on the **Main** tab.

Programmatic Use

Block Parameter: `BreakpointMin`

Type: character vector

Value: scalar

Default: `'[]'`

Breakpoint Maximum — Maximum value breakpoint data can have

`[]` (default) | scalar

Specify the maximum value that the breakpoint data can have. The default value is [] (unspecified).

Dependencies

To enable this parameter, set the breakpoints data **Source** to Dialog on the **Main** tab.

Programmatic Use

Block Parameter: BreakpointMax

Type: character vector

Value: scalar

Default: '[]'

Lock output data type setting against changes by the fixed-point tools — Prevent fixed-point tools from overriding Output data type

off (default) | on

Select this parameter to prevent the fixed-point tools from overriding the **Output** data type you specify on the block. For more information, see “Use Lock Output Data Type Setting” (Fixed-Point Designer).

Programmatic Use

Block Parameter: LockScale

Type: character vector

Values: 'off' | 'on'

Default: 'off'

Integer rounding mode — Rounding mode for fixed-point operations

Floor (default) | Ceiling | Convergent | Nearest | Round | Simplest | Zero

Specify the rounding mode for fixed-point operations. For more information, see “Rounding” (Fixed-Point Designer).

Block parameters always round to the nearest representable value. To control the rounding of a block parameter, enter an expression using a MATLAB rounding function into the mask field.

Programmatic Use

Block Parameter: RndMeth

Type: character vector

Values: 'Ceiling' | 'Convergent' | 'Floor' | 'Nearest' | 'Round' | 'Simplest' | 'Zero'

Default: 'Floor'

Block Characteristics

| | |
|---------------------------------|--|
| Data Types | double enumerated fixed point integer single |
| Direct Feedthrough | yes |
| Multidimensional Signals | yes |
| Variable-Size Signals | no |
| Zero-Crossing Detection | no |

More About

Enumerated Values in Prelookup

Simulate a Prelookup block with enumerated values.

Suppose that you have a Prelookup block with an enumerated class like this defined:

```
classdef(Enumeration) Gears < Simulink.IntEnumType
    enumeration
        GEAR1(1),
        GEAR2(2),
        GEAR3(4),
        GEAR4(8),
        SPORTS(16),
        REVERSE(-1),
        NEUTRAL(0)
    end
end
```

Prelookup block has these settings:

- **Breakpoints data** value is enumeration('Gears').
- **Output selection** is Index only.
- For an unordered search, set **Index search method** to Linear search and clear the **Begin index search using previous index result** check box.
- **Extrapolation method** is Clip.

Interpolation using Prelookup block has these settings:

- **Number of dimensions** to 1.
- **Table data** value is [5 10 20 40 80 -5 0].
- **Interpolation method** is Flat.
- **Number of sub-table selection dimensions** is 1.

Simulation produces a vector [10 -5 80], which correspond to GEAR2, REVERSE, and SPORTS.

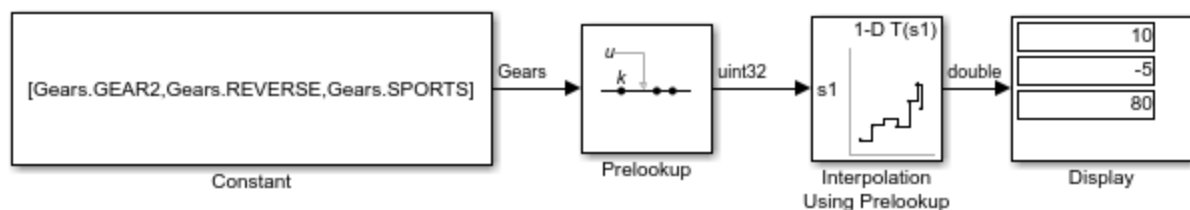

Extended Capabilities

C/C++ Code Generation

Generate C and C++ code using Simulink® Coder™.

HDL Code Generation

Generate Verilog and VHDL code for FPGA and ASIC designs using HDL Coder™.

HDL Coder provides additional configuration options that affect HDL implementation and synthesized logic.

HDL Architecture

This block has a single, default HDL architecture.

HDL Block Properties

| | |
|----------------------------------|--|
| ConstrainedOutputPipeline | Number of registers to place at the outputs by moving existing delays within your design. Distributed pipelining does not redistribute these registers. The default is 0. For more details, see “ConstrainedOutputPipeline” (HDL Coder). |
| InputPipeline | Number of input pipeline stages to insert in the generated code. Distributed pipelining and constrained output pipelining can move these registers. The default is 0. For more details, see “InputPipeline” (HDL Coder). |
| OutputPipeline | Number of output pipeline stages to insert in the generated code. Distributed pipelining and constrained output pipelining can move these registers. The default is 0. For more details, see “OutputPipeline” (HDL Coder). |

Restrictions

Required Block Settings

- **Breakpoint data:** For **Source**, select Dialog.
- **Specification:** You can select either Explicit values or Even spacing.
- **Index search method:** Select Evenly spaced points.
- **Extrapolation method:** Select Clip.
- **Diagnostic for out-of-range input:** Select Error.
- **Use last breakpoint for input at or above upper limit:** Select this check box.
- **Breakpoint:** For **Data Type**, select Inherit: Same as input.
- **Integer rounding mode:** Select Zero, Floor, or Simplest.

Table Data Typing and Sizing

- It is good practice to structure your table such that the spacing between breakpoints is a power of two. If the breakpoint spacing does not meet this condition, HDL Coder issues a warning. When the breakpoint spacing is a power of two, you can replace division operations in the prelookup step with right-shift operations.
- All ports on the block require scalar values.
- The coder permits floating-point data for breakpoints.

PLC Code Generation

Generate Structured Text code using Simulink® PLC Coder™.

Simulink PLC Coder has limited support for lookup table blocks. The coder does not support:

- Number of dimensions greater than 2

- Cubic spline interpolation method
- Begin index search using a previous index mode
- Cubic spline extrapolation method

Fixed-Point Conversion

Design and simulate fixed-point systems using Fixed-Point Designer™.

See Also

Interpolation Using Prelookup | n-D Lookup Table | `Simulink.Breakpoint`

Topics

“About Lookup Table Blocks”

“Anatomy of a Lookup Table”

“Enter Breakpoints and Table Data”

“Guidelines for Choosing a Lookup Table”

Introduced in R2006b

Probe

Output signal attributes, including width, dimensionality, sample time, and complex signal flag

Library: Simulink / Signal Attributes
HDL Coder / Signal Attributes

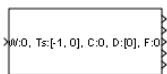

Description

The Probe block outputs selected information about the signal on its input. The block can output the following attributes of the input signal: width, dimensionality, sample time, and a flag indicating whether the input is a complex-valued signal. The block has one input port. The number of output ports depends on the information that you select for probing, that is, signal dimensionality, sample time, and/or complex signal flag. Each probed value is output as a separate signal on a separate output port, with an independent data type control. During simulation, the block icon displays the probed data.

Ports

Input

Port_1 — Input signal

scalar | vector | matrix | N-D array

Input signal to probe, specified as a scalar, vector, matrix, or N-D array. The block accepts real or complex-valued signals of any built-in data type.

You can use an array of buses as an input signal to a Probe block. For details about defining and using an array of buses, see “Group Nonvirtual Buses in Arrays of Buses”.

Data Types: single | double | half | int8 | int16 | int32 | int64 | uint8 | uint16 | uint32 | uint64 | string | Boolean | fixed point | enumerated | bus

Output

Port_1 (W) — Signal width

scalar

Width, or number of elements, in the input signal, specified as a scalar. The width is also displayed on the block icon with the notation W .

Dependencies

To enable this port, select **Probe width**.

Data Types: single | double | half | int8 | int16 | int32 | int64 | uint8 | uint16 | uint32 | uint64 | fixed point

Port_2 (Ts) — Sample time

vector

Sample time of the input signal, as a two-element vector that specifies the period and offset of the sample time, respectively. The sample time is also displayed on the block icon with the notation T_s :. See “Specify Sample Time” for more information.

Dependencies

To enable this port, select **Probe sample time**.

Data Types: `single` | `double` | `half` | `int8` | `int16` | `int32` | `int64` | `uint8` | `uint16` | `uint32` | `uint64` | `fixed point`

Port_3 (C) – Signal complexity

scalar

Indication of input signal complexity:

- When the input signal is complex, the block outputs 1.
- When the input signal is real-valued, the block outputs 0.

The indication of signal complexity is also displayed on the block icon with the notation C :.

Dependencies

To enable this port, select **Detect complex signal**.

Data Types: `single` | `double` | `half` | `int8` | `int16` | `int32` | `int64` | `uint8` | `uint16` | `uint32` | `uint64` | `fixed point`

Port_4 (D) – Signal dimensions

scalar | vector

Dimensions of the input signal, output as a scalar or vector. The signal dimensions are also displayed on the block icon with the notation D :.

Dependencies

To enable this port, select **Probe signal dimensions**.

Data Types: `single` | `double` | `half` | `int8` | `int16` | `int32` | `int64` | `uint8` | `uint16` | `uint32` | `uint64` | `fixed point`

Parameters**Main****Probe width – Output width of the input signal**

`on` (default) | `off`

Select to output the width, or number of elements, of the probed signal.

Programmatic Use

Block Parameter: `ProbWidth`

Type: character vector

Values: `'off'` | `'on'`

Default: `'on'`

Probe sample time – Output sample time of input signal

`on` (default) | `off`

Select to output the sample time of the probed signal. The output is a two-element vector that specifies the period and offset of the sample time, respectively. See “Specify Sample Time” for more information.

Programmatic Use

Block Parameter: ProbeSampleTime

Type: character vector

Values: 'off' | 'on'

Default: 'on'

Detect complex signal — Indicate the complexity of input signal

on (default) | off

Select to output 1 if the probed signal is complex; otherwise, 0.

Programmatic Use

Block Parameter: ProbeComplexSignal

Type: character vector

Values: 'off' | 'on'

Default: 'on'

Probe signal dimensions — Output dimensions of input signal

on (default) | off

Select to output the dimensions of the probed signal.

Programmatic Use

Block Parameter: ProbeSignalDimensions

Type: character vector

Values: 'off' | 'on'

Default: 'on'

Signal Attributes

Data type for width — Data type of signal width output

double (default) | single | int8 | uint8 | int16 | uint16 | int32 | uint32 | Same as input

Select the output data type for the signal width.

Programmatic Use

Block Parameter: ProbeWidthDataType

Type: character vector

Values: 'double' | 'single' | 'int8' | 'uint8' | 'int16' | 'uint16' | 'int32' | 'uint32' | 'Same as input'

Default: 'double'

Data type for sample time — Data type of sample time output

double (default) | single | int8 | uint8 | int16 | uint16 | int32 | uint32 | Same as input

Select the output data type for the sample time information.

Programmatic Use

Block Parameter: ProbeSampleTimeDataType

Type: character vector

Values: 'double' | 'single' | 'int8' | 'uint8' | 'int16' | 'uint16' | 'int32' | 'uint32' | 'Same as input'

Default: 'double'

Data type for signal complexity — Data type of complexity output

double (default) | single | int8 | uint8 | int16 | uint16 | int32 | uint32 | boolean | Same as input

Select the output data type for the complexity information.

Programmatic Use

Block Parameter: ProbeComplexityDataType

Type: character vector

Values: 'double' | 'single' | 'int8' | 'uint8' | 'int16' | 'uint16' | 'int32' | 'uint32' | 'Same as input'

Default: 'double'

Data type for signal dimensions — Data type for signal dimension output

double (default) | single | int8 | uint8 | int16 | uint16 | int32 | uint32 | Same as input

Select the output data type for the signal dimension output.

Programmatic Use

Block Parameter: ProbeDimensionsDataType

Type: character vector

Values: 'double' | 'single' | 'int8' | 'uint8' | 'int16' | 'uint16' | 'int32' | 'uint32' | 'Same as input'

Default: 'double'

Block Characteristics

| | |
|---------------------------------|--|
| Data Types | Boolean bus double enumerated fixed point half integer single string |
| Direct Feedthrough | yes |
| Multidimensional Signals | yes |
| Variable-Size Signals | yes |
| Zero-Crossing Detection | no |

Extended Capabilities

C/C++ Code Generation

Generate C and C++ code using Simulink® Coder™.

HDL Code Generation

Generate Verilog and VHDL code for FPGA and ASIC designs using HDL Coder™.

HDL Coder provides additional configuration options that affect HDL implementation and synthesized logic.

HDL Architecture

This block has a single, default HDL architecture.

HDL Block Properties

| | |
|----------------------------------|--|
| ConstrainedOutputPipeline | Number of registers to place at the outputs by moving existing delays within your design. Distributed pipelining does not redistribute these registers. The default is 0. For more details, see “ConstrainedOutputPipeline” (HDL Coder). |
| OutputPipeline | Number of output pipeline stages to insert in the generated code. Distributed pipelining and constrained output pipelining can move these registers. The default is 0. For more details, see “OutputPipeline” (HDL Coder). |

Complex Data Support

This block supports code generation for complex signals.

Fixed-Point Conversion

Design and simulate fixed-point systems using Fixed-Point Designer™.

See Also

Clock | Digital Clock | Weighted Sample Time Math

Topics

“Specify Sample Time”

Introduced before R2006a

Product

Multiply and divide scalars and nonscalars or multiply and invert matrices

Library: Simulink / Commonly Used Blocks
 Simulink / Math Operations
 HDL Coder / Commonly Used Blocks
 HDL Coder / HDL Floating Point Operations
 HDL Coder / Math Operations



Description

The Product block outputs the result of multiplying two inputs: two scalars, a scalar and a nonscalar, or two nonscalars that have the same dimensions. The default parameter values that specify this behavior are:

- **Multiplication:** Element-wise (.*)
- **Number of inputs:** 2

This table shows the output of the Product block for example inputs using default block parameter values.

| Inputs and Behavior | Example |
|---|---------|
| <p>Scalar X Scalar</p> <p>Output the product of the two inputs.</p> | |
| <p>Scalar X Nonscalar</p> <p>Output a nonscalar having the same dimensions as the input nonscalar. Each element of the output nonscalar is the product of the input scalar and the corresponding element of the input nonscalar.</p> | |
| <p>Nonscalar X Nonscalar</p> <p>Output a nonscalar having the same dimensions as the inputs. Each element of the output is the product of corresponding elements of the inputs.</p> | |

The Divide and Product of Elements blocks are variants of the Product block.

- For information on the Divide block, see Divide.
- For information on the Product of Elements block, see Product of Elements.

The Product block (or the Divide block or Product of Elements block, if appropriately configured) can:

- Numerically multiply and divide any number of scalar, vector, or matrix inputs
- Perform matrix multiplication and division on any number of matrix inputs

The Product block performs scalar or matrix multiplication, depending on the value of the **Multiplication** parameter. The block accepts one or more inputs, depending on the **Number of inputs** parameter. The **Number of inputs** parameter also specifies the operation to perform on each input.

The Product block can input any combination of scalars, vectors, and matrices for which the operation to perform has a mathematically defined result. The block performs the specified operations on the inputs, then outputs the result.

The Product block has two modes: *Element-wise mode*, which processes nonscalar inputs element by element, and *Matrix mode*, which processes nonscalar inputs as matrices.

Element-Wise Mode

When you set **Multiplication** to *Element-wise (.*)*, the Product block is in *Element-wise mode*, in which it operates on the individual numeric elements of any nonscalar inputs. The MATLAB equivalent is the `.*` operator. In element-wise mode, the Product block can perform a variety of multiplication, division, and arithmetic inversion operations.

The value of the **Number of inputs** parameter controls both how many inputs exist and whether each is multiplied or divided to form the output. When the Product block is in element-wise mode and has only one input, it is functionally equivalent to a Product of Elements block. When the block has multiple inputs, any nonscalar inputs must have identical dimensions, and the block outputs a nonscalar with those dimensions. To calculate the output, the block first expands any scalar input to a nonscalar that has the same dimensions as the nonscalar inputs.

This table shows the output of the Product block for example inputs, using the indicated values for the **Number of inputs** parameter.

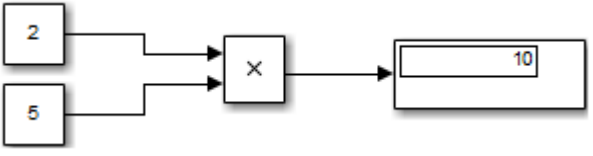
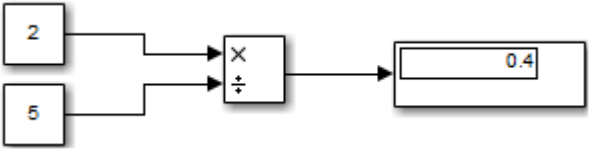
| Parameter Values | Examples |
|----------------------|--|
| Number of inputs: 2 |  |
| Number of inputs: */ |  |

| Parameter Values | Examples |
|------------------------|----------|
| Number of inputs: /**/ | |
| Number of inputs:** | |
| Number of inputs: */* | |

Matrix Mode

When the value of the **Multiplication** parameter is `Matrix(*)`, the Product block is in *Matrix mode*, in which it processes nonscalar inputs as matrices. The MATLAB equivalent is the `*` operator. In Matrix mode, the Product block can invert a single square matrix, or multiply and divide any number of matrices that have dimensions for which the result is mathematically defined.

The value of the **Number of inputs** parameter controls both how many inputs exist and whether each input matrix is multiplied or divided to form the output. The syntax of **Number of inputs** is the same as in element-wise mode. The difference between the modes is in the type of multiplication and division that occur.

Expected Differences Between Simulation and Code Generation

For element-wise operations on complex floating-point inputs, simulation and code generation results might differ in near-overflow cases. Although **complex numbers** is selected and **non-finite numbers** is not selected on the **Code Generation > Interface** pane of the Configuration Parameters dialog box, the code generator does not emit special case code for intermediate overflows. This method improves the efficiency of embedded operations for the general case that does not include extreme values. If the inputs could include extreme values, you must manage these cases explicitly.

The generated code might not produce the same pattern of NaN and inf values as simulation when these values are mathematically meaningless. For example, if the simulation output contains a NaN, output from the generated code also contains a NaN, but not necessarily in the same place.

Ports

Input

Port_1 — First input to multiply or divide

scalar | vector | matrix | N-D array

First input to multiply or divide, provided as a scalar, vector, matrix, or N-D array.

Data Types: half | single | double | int8 | int16 | int32 | int64 | uint8 | uint16 | uint32 | uint64 | Boolean | fixed point

Port_N – Nth input to multiply or divide

scalar | vector | matrix | N-D array

Nth input to multiply or divide, provided as a scalar, vector, matrix, or N-D array.

Data Types: half | single | double | int8 | int16 | int32 | int64 | uint8 | uint16 | uint32 | uint64 | Boolean | fixed point

X – Input signal to multiply

scalar | vector | matrix | N-D array

Input signal to be multiplied with other inputs.

Dependencies

To enable one or more **X** ports, specify one or more * characters for the **Number of inputs** parameter and set the **Multiplication** parameter to **Element-wise(.*)**.

Data Types: half | single | double | int8 | int16 | int32 | int64 | uint8 | uint16 | uint32 | uint64 | Boolean | fixed point

÷ – Input signal to divide or invert

scalar | vector | matrix | N-D array

Input signal for division or inversion operations.

Dependencies

To enable one or more **÷** ports, specify one or more / characters for the **Number of inputs** parameter and set the **Multiplication** parameter to **Element-wise(.*)**.

Data Types: half | single | double | int8 | int16 | int32 | int64 | uint8 | uint16 | uint32 | uint64 | Boolean | fixed point

*** – Input signal to multiply**

scalar | vector | matrix | N-D array

Input signal to be multiplied with other inputs.

Dependencies

To enable one or more ***** ports, specify one or more * characters for the **Number of inputs** parameter and set the **Multiplication** parameter to **Matrix(*)**.

Data Types: half | single | double | int8 | int16 | int32 | int64 | uint8 | uint16 | uint32 | uint64 | Boolean | fixed point

Inv – Input signal to divide or invert

scalar | vector | matrix | N-D array

Input signal for division or inversion operations.

Dependencies

To enable one or more **Inv** ports, specify one or more / characters for the **Number of inputs** parameter and set the **Multiplication** parameter to `Matrix(*)`.

Data Types: `half` | `single` | `double` | `int8` | `int16` | `int32` | `int64` | `uint8` | `uint16` | `uint32` | `uint64` | `Boolean` | `fixed point`

Output

Port_1 — Output computed by multiplying, dividing, or inverting inputs

`scalar` | `vector` | `matrix` | N-D array

Output computed by multiplying, dividing, or inverting inputs.

Data Types: `half` | `single` | `double` | `int8` | `int16` | `int32` | `int64` | `uint8` | `uint16` | `uint32` | `uint64` | `Boolean` | `fixed point`

Parameters

Main

Number of inputs — Control number of inputs and type of operation

2 (default) | `scalar` | `*` or `/` for each input port

Control two properties of the block:

- The number of input ports on the block
- Whether each input is multiplied or divided into the output

When you specify:

- **1 or * or /**

The block has one input port. In element-wise mode, the block processes the input as described for the Product of Elements block. In matrix mode, if the parameter value is `1` or `*`, the block outputs the input value. If the value is `/`, the input must be a square matrix (including a scalar as a degenerate case) and the block outputs the matrix inverse. See “Element-Wise Mode” on page 1-1279 and “Matrix Mode” on page 1-1280 for more information.

- **Integer value > 1**

The block has the number of inputs given by the integer value. The inputs are multiplied together in element-wise mode or matrix mode, as specified by the **Multiplication** parameter. See “Element-Wise Mode” on page 1-1279 and “Matrix Mode” on page 1-1280 for more information.

- **Unquoted string of two or more * and / characters**

The block has the number of inputs given by the length of the character vector. Each input that corresponds to a `*` character is multiplied into the output. Each input that corresponds to a `/` character is divided into the output. The operations occur in element-wise mode or matrix mode, as specified by the **Multiplication** parameter. See “Element-Wise Mode” on page 1-1279 and “Matrix Mode” on page 1-1280 for more information.

Programmatic Use

Block Parameter: Inputs

Type: character vector

Values: '2' | '**' | '*' | '*/*' | ...

Default: '2'

Multiplication — Element-wise (.) or Matrix (*) multiplication

Element-wise(.) (default) | Matrix(*)

Specify whether the block performs Element-wise(.) or Matrix(*) multiplication.

Programmatic Use

Block Parameter: Multiplication

Type: character vector

Values: 'Element-wise(.)' | 'Matrix(*)'

Default: 'Element-wise(.)'

Multiply over — All dimensions or specified dimension

All dimensions (default) | Specified dimension

Specify the dimension to multiply over as All dimensions, or Specified dimension. When you select Specified dimension, you can specify the **Dimension** as 1 or 2.

Dependencies

To enable this parameter, set **Number of inputs** to * and **Multiplication** to Element-wise (.).

Programmatic Use

Block Parameter: CollapseMode

Type: character vector

Values: 'All dimensions' | 'Specified dimension'

Default: 'All dimensions'

Dimension — Dimension to multiply over

1 (default) | 2 | ... | N

Specify the dimension to multiply over as an integer less than or equal to the number of dimensions of the input signal.

Dependencies

To enable this parameter, set:

- **Number of inputs** to *
- **Multiplication** to Element-wise (.)
- **Multiply over** to Specified dimension

Programmatic Use

Block Parameter: CollapseDim

Type: character vector

Values: '1' | '2' | ...

Default: '1'

Sample time — Specify sample time as a value other than -1

-1 (default) | scalar | vector

Specify the sample time as a value other than -1. For more information, see “Specify Sample Time”.

Dependencies

This parameter is not visible unless it is explicitly set to a value other than -1. To learn more, see “Blocks for Which Sample Time Is Not Recommended”.

Programmatic Use

Block Parameter: SampleTime

Type: character vector

Values: scalar or vector

Default: '-1'

Signal Attributes**Require all inputs to have the same data type – Require that all inputs have the same data type**

off (default) | on

Specify if input signals must all have the same data type. If you enable this parameter, then an error occurs during simulation if the input signal types are different.

Programmatic Use

Block Parameter: InputSameDT

Type: character vector

Values: 'off' | 'on'

Default: 'off'

Output minimum – Minimum output value for range checking

[] (default) | scalar

Lower value of the output range that Simulink checks.

Simulink uses the minimum to perform:

- Parameter range checking (see “Specify Minimum and Maximum Values for Block Parameters”) for some blocks.
- Simulation range checking (see “Specify Signal Ranges” and “Enable Simulation Range Checking”).
- Automatic scaling of fixed-point data types.
- Optimization of the code that you generate from the model. This optimization can remove algorithmic code and affect the results of some simulation modes such as SIL or external mode. For more information, see “Optimize using the specified minimum and maximum values” (Embedded Coder).

Note **Output minimum** does not saturate or clip the actual output signal. Use the Saturation block instead.

Programmatic Use

Block Parameter: OutMin

Type: character vector

Values: '[]' | scalar

Default: '[]'

Output maximum — Maximum output value for range checking

[] (default) | scalar

Upper value of the output range that Simulink checks.

Simulink uses the maximum value to perform:

- Parameter range checking (see “Specify Minimum and Maximum Values for Block Parameters”) for some blocks.
- Simulation range checking (see “Specify Signal Ranges” and “Enable Simulation Range Checking”).
- Automatic scaling of fixed-point data types.
- Optimization of the code that you generate from the model. This optimization can remove algorithmic code and affect the results of some simulation modes such as SIL or external mode. For more information, see “Optimize using the specified minimum and maximum values” (Embedded Coder).

Note **Output maximum** does not saturate or clip the actual output signal. Use the Saturation block instead.

Programmatic Use**Block Parameter:** OutMax**Type:** character vector**Values:** '[]' | scalar**Default:** '[]'**Output data type — Specify the output data type**

Inherit: Inherit via internal rule (default) | Inherit: Keep MSB | Inherit: Match scaling | Inherit: Inherit via back propagation | Inherit: Same as first input | double | single | half | int8 | uint8 | int16 | uint16 | int32 | uint32 | int64 | uint64 | fixdt(1,16) | fixdt(1,16,0) | fixdt(1,16,2^0,0) | <data type expression>

Choose the data type for the output. The type can be inherited, specified directly, or expressed as a data type object such as `Simulink.NumericType`. For more information, see “Control Data Types of Signals”.

When you select an inherited option, the block behaves as follows:

- **Inherit: Inherit via internal rule** — Simulink chooses a data type to balance numerical accuracy, performance, and generated code size, while taking into account the properties of the embedded target hardware. If you change the embedded target settings, the data type selected by the internal rule might change. For example, if the block multiplies an input of type `int8` by a gain of `int16` and ASIC/FPGA is specified as the targeted hardware type, the output data type is `sfix24`. If `Unspecified (assume 32-bit Generic)`, in other words, a generic 32-bit microprocessor, is specified as the target hardware, the output data type is `int32`. If none of the word lengths provided by the target microprocessor can accommodate the output range, Simulink software displays an error in the Diagnostic Viewer.
- **Inherit: Keep MSB**— Simulink chooses a data type that maintains the full range of the operation, then reduces the precision of the output to a size appropriate for the embedded target hardware.

Tip For more efficient generated code, deselect the **Saturate on integer overflow** parameter.

This rule never produces overflows.

- **Inherit: Match scaling**– Simulink chooses a data type whose scaling matches the scaling of the input types. If the full range of the type does not fit on the embedded target hardware, the range is reduced yielding a type appropriate for the embedded target hardware. This rule can produce overflows. This rule does not support multiplication between complex signals

The **Inherit: Keep MSB** and **Inherit: Match scaling** rules do not support multiplication between complex signals or signals with non-zero bias. The rules support only multiplication and division ('**', '*/', '/*') between two inputs, matrix multiplication of two inputs, and collapsing product of two elements of a vector.

It is not always possible for the software to optimize code efficiency and numerical accuracy at the same time. If the internal rule doesn't meet your specific needs for numerical accuracy or performance, use one of the following options:

- Specify the output data type explicitly.
- Use the simple choice of **Inherit: Same as input**.
- Explicitly specify a default data type such as `fixdt(1,32,16)` and then use the Fixed-Point Tool to propose data types for your model. For more information, see `fxptdlg`.
- To specify your own inheritance rule, use **Inherit: Inherit via back propagation** and then use a Data Type Propagation block. Examples of how to use this block are available in the Signal Attributes library Data Type Propagation Examples block.
- **Inherit: Inherit via back propagation** — Use data type of the driving block.
- **Inherit: Same as first input** — Use data type of first input signal.

Dependencies

When input is a floating-point data type smaller than single precision, the **Inherit: Inherit via internal rule** output data type depends on the setting of the “Inherit floating-point output type smaller than single precision” configuration parameter. Data types are smaller than single precision when the number of bits needed to encode the data type is less than the 32 bits needed to encode the single-precision data type. For example, `half` and `int16` are smaller than single precision.

Programmatic Use

Block Parameter: `OutDataTypeStr`

Type: character vector

Values: `'Inherit: Inherit via internal rule'|'Inherit: Keep MSB'|'Inherit: Match scaling'|'Inherit: Same as first input'|'Inherit: Inherit via back propagation'|'double'|'single'|'half'|'int8'|'uint8'|'int16'|'uint16'|'int32'|'uint32'|'uint64'|'int64'|'fixdt(1,16)'|'fixdt(1,16,0)'|'fixdt(1,16,2^0,0)'|'<data type expression>'`

Default: `'Inherit: Inherit via internal rule'`

Lock output data type setting against changes by the fixed-point tools — Prevent fixed-point tools from overriding Output data type

`off (default) | on`

Select this parameter to prevent the fixed-point tools from overriding the **Output** data type you specify on the block. For more information, see “Use Lock Output Data Type Setting” (Fixed-Point Designer).

Programmatic Use**Block Parameter:** LockScale**Type:** character vector**Values:** 'off' | 'on'**Default:** 'off'**Integer rounding mode — Rounding mode for fixed-point operations**

Floor (default) | Ceiling | Convergent | Nearest | Round | Simplest | Zero

Select the rounding mode for fixed-point operations. You can select:

CeilingRounds positive and negative numbers toward positive infinity. Equivalent to the MATLAB `ceil` function.**Convergent**Rounds number to the nearest representable value. If a tie occurs, rounds to the nearest even integer. Equivalent to the Fixed-Point Designer `convergent` function.**Floor**Rounds positive and negative numbers toward negative infinity. Equivalent to the MATLAB `floor` function.**Nearest**Rounds number to the nearest representable value. If a tie occurs, rounds toward positive infinity. Equivalent to the Fixed-Point Designer `nearest` function.**Round**Rounds number to the nearest representable value. If a tie occurs, rounds positive numbers toward positive infinity and rounds negative numbers toward negative infinity. Equivalent to the Fixed-Point Designer `round` function.**Simplest**

Chooses between rounding toward floor and rounding toward zero to generate rounding code that is as efficient as possible.

ZeroRounds number toward zero. Equivalent to the MATLAB `fix` function.

For more information, see “Rounding” (Fixed-Point Designer).

Block parameters always round to the nearest representable value. To control the rounding of a block parameter, enter an expression using a MATLAB rounding function into the mask field.

Programmatic Use**Block Parameter:** RndMeth**Type:** character vector**Values:** 'Ceiling' | 'Convergent' | 'Floor' | 'Nearest' | 'Round' | 'Simplest' | 'Zero'**Default:** 'Floor'**Saturate on integer overflow — Method of overflow action**

off (default) | on

Specify whether overflows saturate or wrap.

| Action | Rationale | Impact on Overflows | Example |
|-------------------------------------|---|---|---|
| Select this check box (on). | Your model has possible overflow, and you want explicit saturation protection in the generated code. | Overflows saturate to either the minimum or maximum value that the data type can represent. | The maximum value that the <code>int8</code> (signed, 8-bit integer) data type can represent is 127. Any block operation result greater than this maximum value causes overflow of the 8-bit integer. With the check box selected, the block output saturates at 127. Similarly, the block output saturates at a minimum output value of -128. |
| Do not select this check box (off). | You want to optimize efficiency of your generated code. You want to avoid overspecifying how a block handles out-of-range signals. For more information, see "Troubleshoot Signal Range Errors". | Overflows wrap to the appropriate value that is representable by the data type. | The maximum value that the <code>int8</code> (signed, 8-bit integer) data type can represent is 127. Any block operation result greater than this maximum value causes overflow of the 8-bit integer. With the check box cleared, the software interprets the overflow-causing value as <code>int8</code> , which can produce an unintended result. For example, a block result of 130 (binary 1000 0010) expressed as <code>int8</code> , is -126. |

When you select this check box, saturation applies to every internal operation on the block, not just the output, or result. Usually, the code generation process can detect when overflow is not possible. In this case, the code generator does not produce saturation code.

Programmatic Use

Block Parameter: SaturateOnIntegerOverflow

Type: character vector

Values: 'off' | 'on'

Default: 'off'

Block Characteristics

| | |
|---------------------------------|--|
| Data Types | Boolean double fixed point half integer single |
| Direct Feedthrough | yes |
| Multidimensional Signals | yes |
| Variable-Size Signals | yes |
| Zero-Crossing Detection | no |

Extended Capabilities

C/C++ Code Generation

Generate C and C++ code using Simulink® Coder™.

HDL Code Generation

Generate Verilog and VHDL code for FPGA and ASIC designs using HDL Coder™.

HDL Coder provides additional configuration options that affect HDL implementation and synthesized logic.

HDL Architecture

The default Linear implementation generates a chain of N operations (multipliers) for N inputs.

| Architecture | Parameters | Description |
|---------------|------------------------|---|
| Lineardefault | None | Generate a product operator * in the generated code. |
| ShiftAdd | LatencyStrategy | <p>Perform product operations on fixed-point types by using multiple shift and add operations. The block has pipelined implementation that introduces additional latency in the generated code. ShiftAdd architecture maps to efficient circuits in ASIC applications. This architecture is useful in applications on FPGA target boards that do not have DSP units.</p> <p>The MAX latency for different word lengths is calculated by using this formula: $\text{ceil}(\log_2(\min(\text{in1WL}, \text{in2WL})))$. in1WL is the first input word length and in2WL is the second input word length. For example, if both inputs are of word length four the MAX latency is two.</p> |

HDL Block Properties

If you use the block in matrix multiplication mode, you can specify the **DotProductStrategy**. This setting determines whether you want to implement the matrix multiplication by using a tree of adders and multipliers, or use the Multiply-Accumulate block implementation. The default is Fully Parallel.

Note The **DotProductStrategy** must be set to Fully Parallel when you use the Native Floating Point mode.

For more information, see “DotProductStrategy” (HDL Coder).

See also “Design Considerations for Matrices and Vectors” (HDL Coder).

| General | |
|----------------------------------|---|
| ConstrainedOutputPipeline | Number of registers to place at the outputs by moving existing delays within your design. Distributed pipelining does not redistribute these registers. The default is 0. For more details, see “ConstrainedOutputPipeline” (HDL Coder). |
| DSPStyle | Synthesis attributes for multiplier mapping. The default is none. See also “DSPStyle” (HDL Coder). |
| InputPipeline | Number of input pipeline stages to insert in the generated code. Distributed pipelining and constrained output pipelining can move these registers. The default is 0. For more details, see “InputPipeline” (HDL Coder). |
| OutputPipeline | Number of output pipeline stages to insert in the generated code. Distributed pipelining and constrained output pipelining can move these registers. The default is 0. For more details, see “OutputPipeline” (HDL Coder). |
| LatencyStrategy | To enable this property, set HDL architecture to ShiftAdd. Specify whether to map the blocks in your design to MAX, CUSTOM, or ZERO latency for fixed-point and floating-point types. The default is MAX. See also “LatencyStrategy” (HDL Coder). |
| CustomLatency | To enable this property, set HDL architecture to ShiftAdd. When LatencyStrategy is set to CUSTOM, use this property to specify a custom latency value between ZERO and MAX for fixed-point types. See also “LatencyStrategy” (HDL Coder). |

| Native Floating Point | |
|---------------------------------|--|
| HandleDenormals | Specify whether you want HDL Coder to insert additional logic to handle denormal numbers in your design. Denormal numbers are numbers that have magnitudes less than the smallest floating-point number that can be represented without leading zeros in the mantissa. The default is inherit. See also “HandleDenormals” (HDL Coder). |
| LatencyStrategy | Specify whether to map the blocks in your design to inherit, Max, Min, Zero, or Custom for the floating-point operator. The default is inherit. See also “LatencyStrategy” (HDL Coder). |
| NFPCustomLatency | To specify a value, set LatencyStrategy to Custom. HDL Coder adds latency equal to the value that you specify for the NFPCustomLatency setting. See also “NFPCustomLatency” (HDL Coder). |
| MantissaMultiplyStrategy | Specify how to implement the mantissa multiplication operation during code generation. By using different settings, you can control the DSP usage on the target FPGA device. The default is inherit. See also “MantissaMultiplyStrategy” (HDL Coder). |

Complex Data Support

The default (linear) implementation supports complex data.

Complex division is not supported. For block implementations of the Product block in divide mode or reciprocal mode, see “HDL Code Generation” on page 1-524 on the Divide block reference page.

Restrictions

- HDL code generation does not support more than two inputs at the ports of the block when you use the block in matrix multiplication mode.
- Product block with /* for **Number of inputs** block parameter performs a division where the second input is divided by the first input. This mode has the same restrictions that apply to the Divide block. See “HDL Code Generation” on page 1-524.
- The Product block does not support the sharing optimization in ShiftAdd architecture. To apply the sharing optimization on the Product block, consider using Linear architecture. To view sharing optimization results for your subsystem, generate the **Streaming and Sharing Report**.

PLC Code Generation

Generate Structured Text code using Simulink® PLC Coder™.

Fixed-Point Conversion

Design and simulate fixed-point systems using Fixed-Point Designer™.

See Also

Divide | Dot Product | Product of Elements

Introduced before R2006a

Product of Elements

Copy or invert one scalar input, or collapse one nonscalar input

Library: Simulink / Math Operations
 HDL Coder / HDL Floating Point Operations
 HDL Coder / Math Operations



Description

The Product of Elements block inputs one scalar, vector, or matrix. You can use the block to:

- Copy a scalar input unchanged
- Invert a scalar input (divide 1 by it)
- Collapse a vector or matrix to a scalar by multiplying together all elements or taking successive inverses of the elements
- Collapse a matrix to a vector using one of these options:
 - Multiply together the elements of each row or column
 - Take successive inverses of the elements of each row or column

The Product of Elements block is functionally a Product block that has two preset parameter values:

- **Multiplication:** Element-wise (.*)
- **Number of inputs:** *

Setting nondefault values for either of those parameters can change a Product of Elements block to be functionally equivalent to a Product block or a Divide block.

Ports

Input

Port_1 — First input to multiply or divide

scalar | vector | matrix | N-D array

First input to multiply or divide, provided as a scalar, vector, matrix, or N-D array.

Data Types: half | single | double | int8 | int16 | int32 | int64 | uint8 | uint16 | uint32 | uint64 | Boolean | fixed point

Port_N — Nth input to multiply or divide

scalar | vector | matrix | N-D array

Nth input to multiply or divide, provided as a scalar, vector, matrix, or N-D array.

Data Types: half | single | double | int8 | int16 | int32 | int64 | uint8 | uint16 | uint32 | uint64 | Boolean | fixed point

X — Input signal to multiply

scalar | vector | matrix | N-D array

Input signal to be multiplied with other inputs.

Dependencies

To enable one or more **X** ports, specify one or more * characters for the **Number of inputs** parameter.

Data Types: half | single | double | int8 | int16 | int32 | int64 | uint8 | uint16 | uint32 | uint64 | Boolean | fixed point

÷ — Input signal to divide or invert

scalar | vector | matrix | N-D array

Input signal for division or inversion operations.

Dependencies

To enable one or more **÷** ports, specify one or more / characters for the **Number of inputs** parameter.

Data Types: half | single | double | int8 | int16 | int32 | int64 | uint8 | uint16 | uint32 | uint64 | Boolean | fixed point

Output

Port_1 — Output computed by multiplying, dividing, or inverting inputs

scalar | vector | matrix | N-D array

Output computed by multiplying, dividing, or inverting inputs.

Data Types: half | single | double | int8 | int16 | int32 | int64 | uint8 | uint16 | uint32 | uint64 | Boolean | fixed point

Parameters

Main

Number of inputs — Control number of inputs and type of operation

* (default) | positive integer scalar | * or / for each input port

Control two properties of the block:

- The number of input ports on the block
- Whether each input is multiplied or divided into the output

When you specify:

- **1 or * or /**

The block has one input port. In element-wise mode, the block processes the input as described for the Product of Elements block. In matrix mode, if the parameter value is 1 or *, the block

outputs the input value. If the value is /, the input must be a square matrix (including a scalar as a degenerate case) and the block outputs the matrix inverse. See “Element-Wise Mode” on page 1-1279 and “Matrix Mode” on page 1-1280 for more information.

- **Integer value > 1**

The block has the number of inputs given by the integer value. The inputs are multiplied together in element-wise mode or matrix mode, as specified by the **Multiplication** parameter. See “Element-Wise Mode” on page 1-1279 and “Matrix Mode” on page 1-1280 for more information.

- **Unquoted string of two or more * and / characters**

The block has the number of inputs given by the length of the character vector. Each input that corresponds to a * character is multiplied into the output. Each input that corresponds to a / character is divided into the output. The operations occur in element-wise mode or matrix mode, as specified by the **Multiplication** parameter. See “Element-Wise Mode” on page 1-1279 and “Matrix Mode” on page 1-1280 for more information.

Programmatic Use

Block Parameter: Inputs

Type: character vector

Values: '2' | '*' | '**' | '*/' | '*/*' | ...

Default: '*'

Multiplication — Element-wise (.*) or Matrix (*) multiplication

Element-wise(.*) (default) | Matrix(*)

Specify whether the block performs Element-wise(.*) or Matrix(*) multiplication.

Programmatic Use

Block Parameter: Multiplication

Type: character vector

Values: 'Element-wise(.*)' | 'Matrix(*)'

Default: 'Element-wise(.*)'

Multiply over — All dimensions or specified dimension

All dimensions (default) | Specified dimension

Specify the dimension to multiply over as All dimensions, or Specified dimension.

When you select All dimensions and select configuration parameter **Use algorithms optimized for row-major array layout**, Simulink enables row-major algorithms for simulation. To generate row-major code, set configuration parameter **Array layout** (Simulink Coder) to Row-major in addition to selecting **Use algorithms optimized for row-major array layout**. The column-major and row-major algorithms differ only in the multiplication order. In some cases, due to different operation order on the same data set, you might experience minor numeric differences in the outputs of column-major and row-major algorithms.

When you select Specified dimension, you can specify the **Dimension** as 1 or 2.

Dependencies

To enable this parameter, set **Number of inputs** to * and **Multiplication** to Element-wise (.*).

Programmatic Use

Block Parameter: CollapseMode

Type: character vector

Values: 'All dimensions' | 'Specified dimension'

Default: 'All dimensions'

Dimension — Dimension to multiply over

1 (default) | 2 | ... | N

Specify the dimension to multiply over as an integer less than or equal to the number of dimensions of the input signal.

Dependencies

To enable this parameter, set:

- **Number of inputs** to *
- **Multiplication** to Element-wise (.*)
- **Multiply over** to Specified dimension

Programmatic Use

Block Parameter: CollapseDim

Type: character vector

Values: '1' | '2' | ...

Default: '1'

Sample time — Specify sample time as a value other than -1

-1 (default) | scalar | vector

Specify the sample time as a value other than -1. For more information, see “Specify Sample Time”.

Dependencies

This parameter is not visible unless it is explicitly set to a value other than -1. To learn more, see “Blocks for Which Sample Time Is Not Recommended”.

Programmatic Use

Block Parameter: SampleTime

Type: character vector

Values: scalar or vector

Default: '-1'

Signal Attributes

Require all inputs to have the same data type — Require that all inputs have the same data type

off (default) | on

Specify if input signals must all have the same data type. If you enable this parameter, then an error occurs during simulation if the input signal types are different.

Programmatic Use

Block Parameter: InputSameDT

Type: character vector

Values: 'off' | 'on'

Default: 'off'

Output minimum — Minimum output value for range checking

[] (default) | scalar

Lower value of the output range that Simulink checks.

Simulink uses the minimum to perform:

- Parameter range checking (see “Specify Minimum and Maximum Values for Block Parameters”) for some blocks.
- Simulation range checking (see “Specify Signal Ranges” and “Enable Simulation Range Checking”).
- Automatic scaling of fixed-point data types.
- Optimization of the code that you generate from the model. This optimization can remove algorithmic code and affect the results of some simulation modes such as SIL or external mode. For more information, see “Optimize using the specified minimum and maximum values” (Embedded Coder).

Note Output minimum does not saturate or clip the actual output signal. Use the Saturation block instead.

Programmatic Use**Block Parameter:** OutMin**Type:** character vector**Values:** '[]' | scalar**Default:** '[]'**Output maximum — Maximum output value for range checking**

[] (default) | scalar

Upper value of the output range that Simulink checks.

Simulink uses the maximum value to perform:

- Parameter range checking (see “Specify Minimum and Maximum Values for Block Parameters”) for some blocks.
- Simulation range checking (see “Specify Signal Ranges” and “Enable Simulation Range Checking”).
- Automatic scaling of fixed-point data types.
- Optimization of the code that you generate from the model. This optimization can remove algorithmic code and affect the results of some simulation modes such as SIL or external mode. For more information, see “Optimize using the specified minimum and maximum values” (Embedded Coder).

Note Output maximum does not saturate or clip the actual output signal. Use the Saturation block instead.

Programmatic Use**Block Parameter:** OutMax

Type: character vector

Values: '[]' | scalar

Default: '[]'

Output data type — Specify the output data type

Inherit: Inherit via internal rule (default) | Inherit: Inherit via back propagation | Inherit: Same as first input | double | single | int8 | uint8 | int16 | uint16 | int32 | uint32 | int64 | uint64 | fixdt(1,16) | fixdt(1,16,0) | fixdt(1,16,2^0,0) | <data type expression>

Choose the data type for the output. The type can be inherited, specified directly, or expressed as a data type object such as Simulink.NumericType. For more information, see “Control Data Types of Signals”.

When you select an inherited option, the block behaves as follows:

- **Inherit: Inherit via internal rule** — Simulink chooses a data type to balance numerical accuracy, performance, and generated code size, while taking into account the properties of the embedded target hardware. If you change the embedded target settings, the data type selected by the internal rule might change. For example, if the block multiplies an input of type `int8` by a gain of `int16` and ASIC/FPGA is specified as the targeted hardware type, the output data type is `sfix24`. If `Unspecified` (assume 32-bit Generic), in other words, a generic 32-bit microprocessor, is specified as the target hardware, the output data type is `int32`. If none of the word lengths provided by the target microprocessor can accommodate the output range, Simulink software displays an error in the Diagnostic Viewer.

It is not always possible for the software to optimize code efficiency and numerical accuracy at the same time. If the internal rule doesn't meet your specific needs for numerical accuracy or performance, use one of the following options:

- Specify the output data type explicitly.
- Use the simple choice of **Inherit: Same as input**.
- Explicitly specify a default data type such as `fixdt(1,32,16)` and then use the Fixed-Point Tool to propose data types for your model. For more information, see `fxptdlg`.
- To specify your own inheritance rule, use **Inherit: Inherit via back propagation** and then use a Data Type Propagation block. Examples of how to use this block are available in the Signal Attributes library Data Type Propagation Examples block.
- **Inherit: Inherit via back propagation** — Use data type of the driving block.
- **Inherit: Same as first input** — Use data type of first input signal.

Dependencies

When input is a floating-point data type smaller than single precision, the **Inherit: Inherit via internal rule** output data type depends on the setting of the “Inherit floating-point output type smaller than single precision” configuration parameter. Data types are smaller than single precision when the number of bits needed to encode the data type is less than the 32 bits needed to encode the single-precision data type. For example, `half` and `int16` are smaller than single precision.

Programmatic Use

Block Parameter: `OutDataTypeStr`

Type: character vector

Values: 'Inherit: Inherit via internal rule' | 'Inherit: Same as first input' | 'Inherit: Inherit via back propagation' | 'double' | 'single' | 'int8' | 'uint8' | 'int16' | 'uint16' | 'int32' | 'uint32' | 'int64' | 'uint64' | 'fixdt(1,16)' | 'fixdt(1,16,0)' | 'fixdt(1,16,2^0,0)' | '<data type expression>'

Default: 'Inherit: Inherit via internal rule'

Lock output data type setting against changes by the fixed-point tools – Prevent fixed-point tools from overriding Output data type

off (default) | on

Select this parameter to prevent the fixed-point tools from overriding the **Output** data type you specify on the block. For more information, see “Use Lock Output Data Type Setting” (Fixed-Point Designer).

Programmatic Use

Block Parameter: LockScale

Type: character vector

Values: 'off' | 'on'

Default: 'off'

Integer rounding mode – Rounding mode for fixed-point operations

Floor (default) | Ceiling | Convergent | Nearest | Round | Simplest | Zero

Select the rounding mode for fixed-point operations. You can select:

Ceiling

Rounds positive and negative numbers toward positive infinity. Equivalent to the MATLAB `ceil` function.

Convergent

Rounds number to the nearest representable value. If a tie occurs, rounds to the nearest even integer. Equivalent to the Fixed-Point Designer `convergent` function.

Floor

Rounds positive and negative numbers toward negative infinity. Equivalent to the MATLAB `floor` function.

Nearest

Rounds number to the nearest representable value. If a tie occurs, rounds toward positive infinity. Equivalent to the Fixed-Point Designer `nearest` function.

Round

Rounds number to the nearest representable value. If a tie occurs, rounds positive numbers toward positive infinity and rounds negative numbers toward negative infinity. Equivalent to the Fixed-Point Designer `round` function.

Simplest

Chooses between rounding toward floor and rounding toward zero to generate rounding code that is as efficient as possible.

Zero

Rounds number toward zero. Equivalent to the MATLAB `fix` function.

For more information, see “Rounding” (Fixed-Point Designer).

Block parameters always round to the nearest representable value. To control the rounding of a block parameter, enter an expression using a MATLAB rounding function into the mask field.

Programmatic Use

Block Parameter: RndMeth

Type: character vector

Values: 'Ceiling' | 'Convergent' | 'Floor' | 'Nearest' | 'Round' | 'Simplest' | 'Zero'

Default: 'Floor'

Saturate on integer overflow — Method of overflow action

off (default) | on

Specify whether overflows saturate or wrap.

| Action | Rationale | Impact on Overflows | Example |
|-------------------------------------|---|---|---|
| Select this check box (on). | Your model has possible overflow, and you want explicit saturation protection in the generated code. | Overflows saturate to either the minimum or maximum value that the data type can represent. | The maximum value that the <code>int8</code> (signed, 8-bit integer) data type can represent is 127. Any block operation result greater than this maximum value causes overflow of the 8-bit integer. With the check box selected, the block output saturates at 127. Similarly, the block output saturates at a minimum output value of -128. |
| Do not select this check box (off). | You want to optimize efficiency of your generated code. You want to avoid overspecifying how a block handles out-of-range signals. For more information, see “Troubleshoot Signal Range Errors”. | Overflows wrap to the appropriate value that is representable by the data type. | The maximum value that the <code>int8</code> (signed, 8-bit integer) data type can represent is 127. Any block operation result greater than this maximum value causes overflow of the 8-bit integer. With the check box cleared, the software interprets the overflow-causing value as <code>int8</code> , which can produce an unintended result. For example, a block result of 130 (binary 1000 0010) expressed as <code>int8</code> , is -126. |

When you select this check box, saturation applies to every internal operation on the block, not just the output, or result. Usually, the code generation process can detect when overflow is not possible. In this case, the code generator does not produce saturation code.

Programmatic Use

Block Parameter: SaturateOnIntegerOverflow

Type: character vector

Values: 'off' | 'on'
 Default: 'off'

Block Characteristics

| | |
|---------------------------------|--|
| Data Types | Boolean double fixed point half integer single |
| Direct Feedthrough | yes |
| Multidimensional Signals | yes |
| Variable-Size Signals | yes |
| Zero-Crossing Detection | no |

Algorithms

The Product of Elements block uses these algorithms to perform element-wise operations on inputs of floating-point, built-in integer, and fixed-point types.

| Input | Element-Wise Operation | Algorithm |
|--|------------------------|--------------------------------------|
| Real scalar, u | Multiplication | $y = u$ |
| | Division | $y = 1/u$ |
| Real vector or matrix with elements $u_1, u_2, u_3, \dots, u_N$ | Multiplication | $y = u_1 * u_2 * u_3 * \dots * u_N$ |
| | Division | $y = (((1/u_1)/u_2)/u_3) \dots /u_N$ |
| Complex scalar, u | Multiplication | $y = u$ |
| | Division | $y = 1/u$ |
| Complex vector or matrix with elements $u_1, u_2, u_3, \dots, u_N$ | Multiplication | $y = u_1 * u_2 * u_3 * \dots * u_N$ |
| | Division | $y = (((1/u_1)/u_2)/u_3) \dots /u_N$ |

If the specified dimension for element-wise multiplication or division is a row or column of a matrix, the algorithm applies to that row or column. Consider this model.

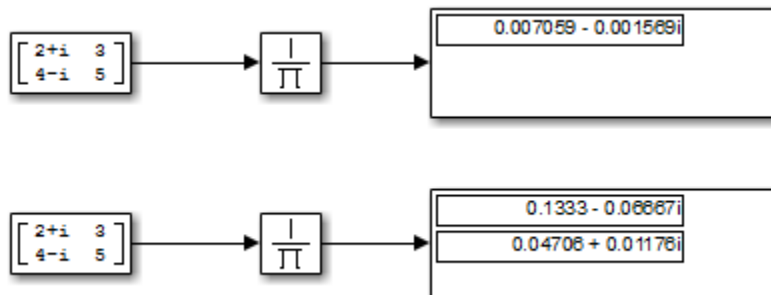

The top Product of Elements block collapses the matrix input to a scalar by taking successive inverses of the four elements:

$$\bullet y = (((1/2+i)/3)/4-i)/5$$

The bottom Product of Elements block collapses the matrix input to a vector by taking successive inverses along the second dimension:

$$\bullet y(1) = ((1/2+i)/3)$$

$$\bullet y(2) = ((1/4-i)/5)$$

Extended Capabilities

C/C++ Code Generation

Generate C and C++ code using Simulink® Coder™.

HDL Code Generation

Generate Verilog and VHDL code for FPGA and ASIC designs using HDL Coder™.

HDL Coder provides additional configuration options that affect HDL implementation and synthesized logic.

HDL Architecture

HDL Coder supports **Tree** and **Cascade** architectures for Product or Product of Elements blocks that have a single vector input with multiple elements.

This block has multi-cycle implementations that introduce additional latency in the generated code. To see the added latency, view the generated model or validation model. See “Generated Model and Validation Model” (HDL Coder).

| Architecture | Additional cycles of latency | Description |
|------------------|---|---|
| Linear (default) | 0 | Generates a linear chain of adders to compute the sum of products. |
| Tree | 0 | Generates a tree structure of adders to compute the sum of products. |
| Cascade | 1, when block has a single vector input port. | This implementation optimizes latency * area and is faster than the Tree implementation. It computes partial products and cascades multipliers. See “Cascade Architecture Best Practices” (HDL Coder). |

Note The Product of Element block does not support HDL code generation with double data types in the Native Floating Point mode.

HDL Block Properties

If you use the block in matrix multiplication mode, you can specify the **DotProductStrategy**. This setting determines whether you want to implement the matrix multiplication by using a tree of adders and multipliers, or use the Multiply-Accumulate block implementation. The default is Fully Parallel.

Note The **DotProductStrategy** must be set to **Fully Parallel** when you use the **Native Floating Point** mode.

For more information, see “DotProductStrategy” (HDL Coder).

See also “Design Considerations for Matrices and Vectors” (HDL Coder).

| General | |
|----------------------------------|--|
| ConstrainedOutputPipeline | Number of registers to place at the outputs by moving existing delays within your design. Distributed pipelining does not redistribute these registers. The default is 0. For more details, see “ConstrainedOutputPipeline” (HDL Coder). |
| DSPStyle | Synthesis attributes for multiplier mapping. The default is none. See also “DSPStyle” (HDL Coder). |
| InputPipeline | Number of input pipeline stages to insert in the generated code. Distributed pipelining and constrained output pipelining can move these registers. The default is 0. For more details, see “InputPipeline” (HDL Coder). |
| OutputPipeline | Number of output pipeline stages to insert in the generated code. Distributed pipelining and constrained output pipelining can move these registers. The default is 0. For more details, see “OutputPipeline” (HDL Coder). |

| Native Floating Point | |
|---------------------------------|--|
| HandleDenormals | Specify whether you want HDL Coder to insert additional logic to handle denormal numbers in your design. Denormal numbers are numbers that have magnitudes less than the smallest floating-point number that can be represented without leading zeros in the mantissa. The default is inherit . See also “HandleDenormals” (HDL Coder). |
| LatencyStrategy | Specify whether to map the blocks in your design to inherit , Max , Min , Zero , or Custom for the floating-point operator. The default is inherit . See also “LatencyStrategy” (HDL Coder). |
| NFPCustomLatency | To specify a value, set LatencyStrategy to Custom . HDL Coder adds latency equal to the value that you specify for the NFPCustomLatency setting. See also “NFPCustomLatency” (HDL Coder). |
| MantissaMultiplyStrategy | Specify how to implement the mantissa multiplication operation during code generation. By using different settings, you can control the DSP usage on the target FPGA device. The default is inherit . See also “MantissaMultiplyStrategy” (HDL Coder). |

Complex Data Support

The default (linear) implementation supports complex data.

Complex division is not supported. For block implementations of the Product block in divide mode or reciprocal mode, see “HDL Code Generation” on page 1-524 on the Divide block reference page.

PLC Code Generation

Generate Structured Text code using Simulink® PLC Coder™.

Fixed-Point Conversion

Design and simulate fixed-point systems using Fixed-Point Designer™.

See Also

Product | Divide | Dot Product

Introduced before R2006a

Pulse Generator

Generate square wave pulses at regular intervals

Library: Simulink / Sources



Description

The Pulse Generator block generates square wave pulses at regular intervals. The block waveform parameters, **Amplitude**, **Pulse Width**, **Period**, and **Phase delay**, determine the shape of the output waveform. The following diagram shows how each parameter affects the waveform.

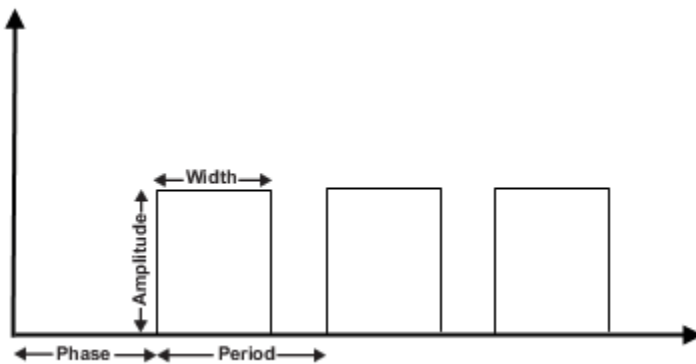

The Pulse Generator block can emit scalar, vector, or matrix signals of any real data type. To emit a scalar signal, use scalars to specify the waveform parameters. To emit a vector or matrix signal, use vectors or matrices, respectively, to specify the waveform parameters. Each element of the waveform parameters affects the corresponding element of the output signal. For example, the first element of a vector amplitude parameter determines the amplitude of the first element of a vector output pulse. All the waveform parameters must have the same dimensions after scalar expansion. The data type of the output is the same as the data type of the **Amplitude** parameter.

The block output can be generated in time-based or sample-based modes, determined by the **Pulse type** parameter.

Time-Based Mode

In time-based mode, Simulink computes the block output only at times when the output actually changes. This approach results in fewer computations for the block output over the simulation time period. Activate this mode by setting the **Pulse type** parameter to Time based.

The block does not support a time-based configuration that results in a constant output signal. Simulink returns an error if the parameters **Pulse Width** and **Period** satisfy either of these conditions:

$$Period * \frac{PulseWidth}{100} = 0$$

$$Period * \frac{PulseWidth}{100} = Period$$

Depending on the pulse waveform characteristics, the intervals between changes in the block output can vary. For this reason, a time-based Pulse Generator block has a variable sample time. The sample time color of such blocks is brown (see “View Sample Time Information” for more information).

Simulink cannot use a fixed-step solver to compute the output of a time-based pulse generator. If you specify a fixed-step solver for models that contain time-based pulse generators, Simulink computes a fixed sample time for the time-based pulse generators. Then the time-based pulse generators simulate as sample based.

If you use a fixed-step solver and the **Pulse type** is **Time based**, choose the step size such that the period, phase delay, and pulse width (in seconds) are integer multiples of the solver step size. For example, suppose that the period is 4 seconds, the pulse width is 75% (that is, 3 s), and the phase delay is 1 s. In this case, the computed sample time is 1 s. Therefore, choose a fixed-step size of 1 or a number that divides 1 exactly (for example, 0.25). To ensure this setting, select **auto** on the **Solver** pane of the Configuration Parameters dialog box.

Sample-Based Mode

In sample-based mode, the block computes its outputs at fixed intervals that you specify. Activate this mode by setting the **Pulse type** parameter to **Sample based**.

An important difference between the time-based and sample-based modes is that in time-based mode, the block output is based on simulation time, and in sample-based mode, the block output depends only on the simulation start, regardless of elapsed simulation time.

This block supports reset semantics in sample-based mode. For example, if a Pulse Generator block is in a resettable subsystem that hits a reset trigger, the block output resets to its initial condition.

Ports

Output

Port_1 — Output signal

scalar | vector | matrix

Generated square wave pulse signal specified by the parameters.

Data Types: single | double | int8 | int16 | int32 | int64 | uint8 | uint16 | uint32 | uint64 | fixed point

Parameters

Pulse type — Computational technique

Time based (default) | Sample based

Computational technique to generate the type of square wave that this block generates, either time- or sample-based. Some parameters in the dialog box appear depending on whether you select time-based or sample-based.

Programmatic Use**Block Parameter:** PulseType**Type:** character vector**Values:** 'Time based' | 'Sample based'**Default:** 'Time based'**Time (t) — Source of time variable**

Use simulation time (default) | Use external signal

Specifies whether to use simulation time or an external signal as the source of values for the output pulse's time variable. If you specify an external source, the block displays an input port for connecting the source. The output pulse differs as follows:

- **Use simulation time:** The block generates an output pulse where the time variable equals the simulation time.
- **Use external signal:** The block generates an output pulse where the time variable equals the value from the input port, which can differ from the simulation time.

Programmatic Use**Block Parameter:** TimeSource**Type:** character vector**Values:** 'Use simulation time' | 'Use external signal'**Default:** 'Use simulation time'**Amplitude — Signal amplitude**

1 (default) | scalar

Specify the amplitude of the signal.

Programmatic Use**Block Parameter:** Amplitude**Type:** character vector**Value:** scalar**Default:** '1'**Period (secs) — Pulse period**

10 (default) | scalar

Pulse period specified in seconds if the pulse type is time-based. If the pulse type is sample-based, then the period is specified as the number of sample times.

Programmatic Use**Block Parameter:** Period**Type:** character vector**Value:** scalar**Default:** '10'**Pulse width — Duty cycle**

5 (default) | scalar in the range [0,100]

Duty cycle specified as the percentage of the pulse period that the signal is on if time-based or as number of sample times if sample-based.

Programmatic Use**Block Parameter:** PulseWidth

Type: character vector

Value: scalar

Default: '5'

Phase delay (secs) — Delay before pulse

0 (default) | scalar

Delay before the pulse is generated, specified in seconds, if the pulse type is time-based or as number of sample times if the pulse type is sample-based.

Programmatic Use

Block Parameter: PhaseDelay

Type: character vector

Value: scalar

Default: '0'

Sample time — Length of sample time

0 (default) | scalar | vector

Length of the sample time for this block in seconds. This parameter appears only if the block's pulse type is sample-based. See “Specify Sample Time”.

Programmatic Use

Block Parameter: SampleTime

Type: character vector

Value: scalar

Default: '0'

Interpret vector parameters as 1-D — Treat vectors as 1-D

on (default) | off

Select this check box to output a vector of length N if the **Constant value** parameter evaluates to an N-element row or column vector.

- When you select this check box, the block outputs a vector of length N if the **Constant value** parameter evaluates to an N-element row or column vector. For example, the block outputs a matrix of dimension 1-by-N or N-by-1.
- When you clear this check box, the block does not output a vector of length N if the **Constant value** parameter evaluates to an N-element row or column vector.

Programmatic Use

Block Parameter: VectorParams1D

Type: character vector

Values: 'on' | 'off'

Default: 'on'

Block Characteristics

| | |
|---------------------------------|---|
| Data Types | Boolean double fixed point integer single |
| Direct Feedthrough | yes |
| Multidimensional Signals | no |

| | |
|--------------------------------|----|
| Variable-Size Signals | no |
| Zero-Crossing Detection | no |

Extended Capabilities

C/C++ Code Generation

Generate C and C++ code using Simulink® Coder™.

Cannot be used inside a triggered subsystem hierarchy.

These blocks do not reference absolute time when configured for sample-based operation. In time-based operation, they depend on absolute time.

PLC Code Generation

Generate Structured Text code using Simulink® PLC Coder™.

Fixed-Point Conversion

Design and simulate fixed-point systems using Fixed-Point Designer™.

See Also

Signal Generator | Waveform Generator

Introduced before R2006a

Push Button

Change parameter or variable value using button with customizable appearance

Library: Simulink / Dashboard / Customizable Blocks



Description

Use the Push Button block to change the value of the connected variable or parameter before or during simulation. You can configure the button to change the value only while you press the button or to latch the value change until you click the button again. When you use the Push Button block in the Customizable Blocks library, you can modify the appearance of the block so it looks like a button in your real system. Use the Push Button block with other Dashboard blocks to create an interactive dashboard to control your model.

Double-clicking the Push Button block does not open its dialog box during simulation or when the block is selected. To edit the block parameters, you can use the **Property Inspector** or open the block dialog box by:

- Double-clicking the block when the block is not selected and the model is not simulating.
- Right-clicking the block and selecting **Block Parameters** from the context menu.

Customize Push Button Blocks

When you add a Push Button block to your model, the block is preconfigured with a default design. You can use the block with the default design or customize the appearance of the block. When you design a Push Button block, you configure the block appearance for each possible state. When you configure the **Block Type** as **Momentary**, the block has two states, and when you configure the **Block Type** as **Latch**, the block has four. For each state, you can:

- Add an image to define the appearance of the block in that state.
- Specify text for the button label and configure its color and position within the block.
- Add an icon and specify the position of the icon relative to the label.

When you want an aspect of the block, such as the label text or color, to indicate the state of the block, configure that aspect of the design differently for each state. When you want an aspect of the block to remain the same for all states, configure that aspect of the block design so it is the same for all states.

You can also design the block background and foreground, which apply for all states. To configure the foreground for the block, upload a foreground image. To configure the background for the block, you can upload a background image or use a solid background color.

To customize the appearance of the block, use design mode. You can enter design mode in one of three ways after selecting the block:

- On the **Button** tab, under **Design**, click **Edit**.
- In the **Property Inspector**, on the **Design** tab, click **Edit Design**.
- Pause on the ellipsis that appears above the block and click the **Edit Custom Block** button.

Design mode gives you access to block parameters and settings that allow you to customize the appearance of the block. You can use the toolbar above the block to configure the image, the icon, and the label color and opacity for each state. For more customization options, use the **Design** tab in the Property Inspector.

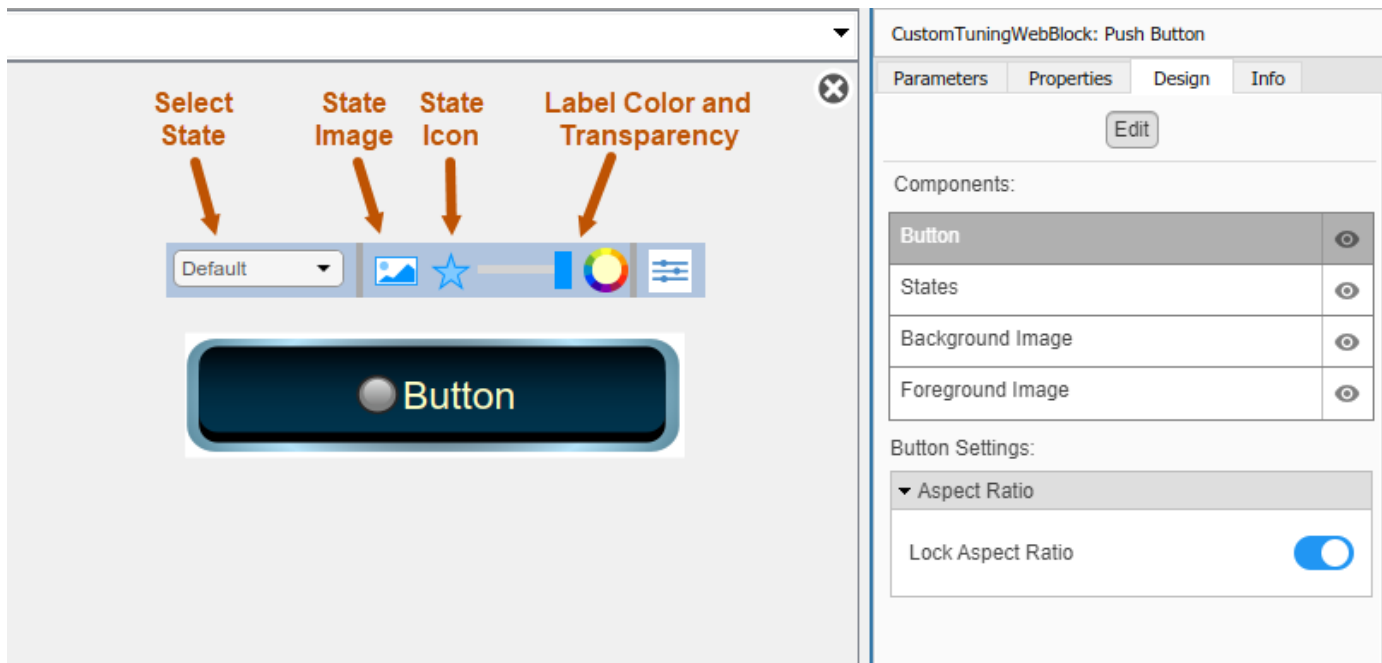

When you finish designing the button, click **Exit** in the upper-right of the canvas to exit design mode.

Connect Dashboard Blocks

Dashboard blocks do not use ports to connect to model elements. To connect dashboard blocks to variables and block parameters, use connect mode. Connect mode facilitates the process of connecting dashboard blocks in your model, especially when you want to connect multiple blocks at once. To connect a single dashboard block, you can also use the **Connection** table in the block dialog box.

Tip You can modify dashboard block connections in your model during normal and accelerator mode simulations.

Note Dashboard blocks cannot connect to variables until you update the model diagram. To connect dashboard blocks to variables or modify variable values between opening your model and running a simulation, update the model diagram using **Ctrl+D**.

To enter connect mode, select the block. Then, on the block tab, click **Connect**. In connect mode, when you select one or more blocks, a list of parameters and variables available for connection appears. Select a variable or parameter from the list to connect to the selected dashboard block.

When the value of the selected variable or block parameter is nonscalar, use the text box at the bottom of the **Connection** table to specify the element you want to connect to the dashboard block. To connect to an element of a vector, matrix, or array, specify the element index, for example, 3 or

(1,3). To connect to an element in a bus or structure, specify the element in the context of the bus or structure hierarchy by using dots to indicate different levels in the hierarchy, and omit the top level. For example, specify `a.b` to connect to scalar element `b` of the structure or bus `a` nested inside the selected composite variable or parameter.

To connect another dashboard block, pause on another dashboard block and click the **Connect** button above it. Then, make a selection of signals and blocks in your model and choose a model element to connect.

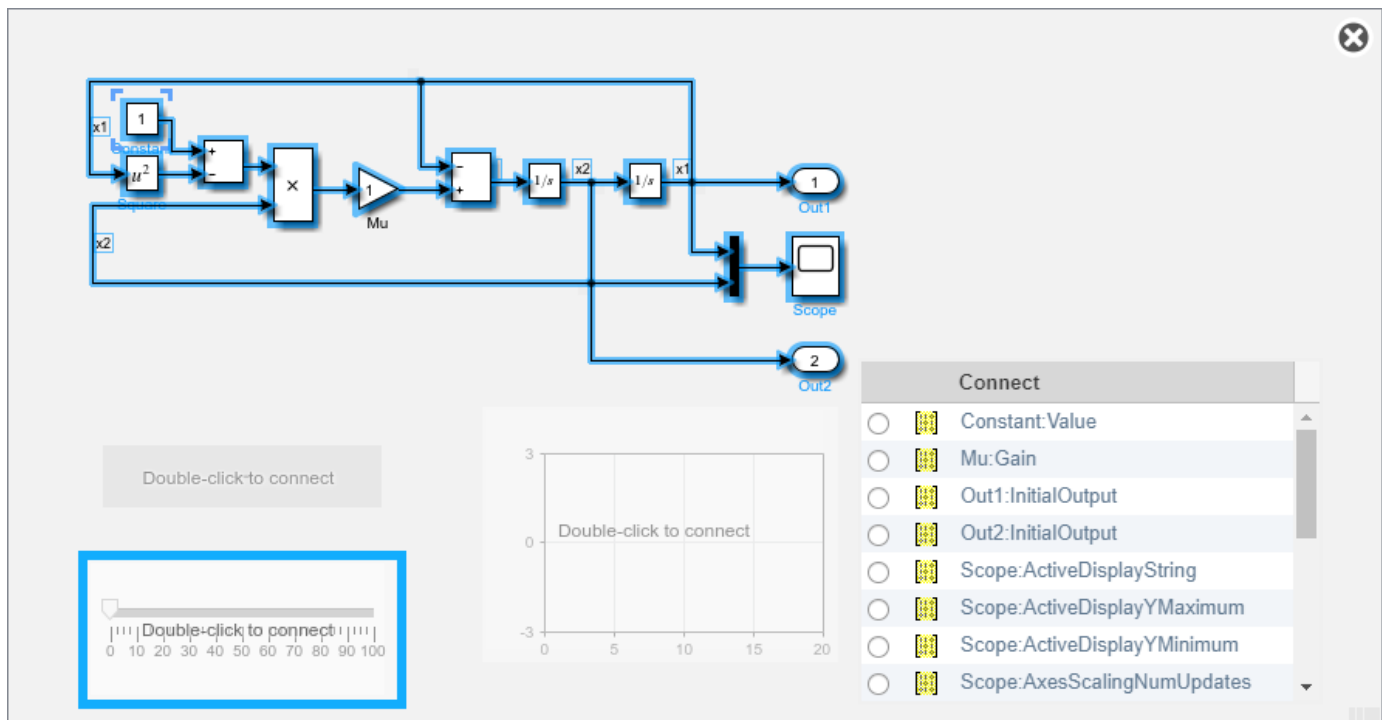

When you finish connecting the dashboard blocks in your model, on the block tab, click **Done Connecting**.

Tip You can hide the message shown on unconnected blocks using the `set_param` function with the `ShowInitialText` block parameter. The message also disappears when you connect the block.

Parameter Logging

Tunable parameters connected to dashboard blocks are logged to the Simulation Data Inspector, where you can view the parameter values along with logged signal data. You can access logged parameter data in the MATLAB workspace by exporting the parameter data from the Simulation Data Inspector by using the UI or the `Simulink.sdi.exportRun` function. For more information about exporting data using the Simulation Data Inspector UI, see "Export Data to the Workspace or a File". The parameter data is stored in a `Simulink.SimulationData.Parameter` object, accessible as an element in the exported `Simulink.SimulationData.Dataset`.

Limitations

- Except for the Dashboard Scope block and the Display block, dashboard blocks can only connect to real scalar signals.
- The toolstrip does not support blocks that are inside a panel.
- You cannot use the **Connection** table in the block dialog to connect a dashboard block to a block that is commented out. When you connect a dashboard block to a commented block using connect mode, the dashboard block does not display the connected value until the you uncomment the block.
- Dashboard blocks cannot connect to model elements inside referenced models.
- When you simulate a model hierarchy, dashboard blocks inside referenced models do not update.
- Dashboard blocks do not support rapid accelerator simulation.
- When you connect a dashboard block to a variable or parameter during simulation, the data for that variable or parameter is not logged to the Simulation Data Inspector. To log variable and parameter data to the Simulation Data Inspector, connect the dashboard block to the variable or parameter prior to simulation.
- When you simulate a model in external mode with the **Default parameter behavior** set to **Inlined**, dashboard blocks can appear to change parameter and variable values. However, the change does not propagate to the simulation. For example, Gain blocks display changes made to the **Gain** parameter using the dashboard blocks, but the **Gain** value used in the simulation does not change.

Parameters

Connection — Select a variable or block parameter to connect

variable and parameter connection options

Select the variable or block parameter to control using the **Connection** table. To connect the block to a signal:

- 1 Make a selection in the model that includes one or more blocks.
- 2 Select the variable or parameter you want to connect.

When the value of the selected variable or block parameter is nonscalar, use the text box at the bottom of the **Connection** table to specify the element you want to connect to the dashboard block. To connect to an element of a vector, matrix, or array, specify the element index, for example, 3 or (1,3). To connect to an element in a bus or structure, specify the element in the context of the bus or structure hierarchy by using dots to indicate different levels in the hierarchy, and omit the top level. For example, specify a.b to connect to scalar element b of the structure or bus a nested inside the selected composite variable or parameter.

- 3 Click **Apply**.

To facilitate understanding and debugging your model, you can connect Dashboard blocks to variables and parameters in your model during simulation.

Note To see workspace variables in the connection table, update the model diagram using **Ctrl+D**.

Programmatic Use

To programmatically connect a dashboard block to a tunable parameter or a variable, use a `Simulink.HMI.ParamSourceInfo` object. The `Simulink.HMI.ParamSourceInfo` object contains four properties. Some of the properties apply to connecting dashboard blocks to parameters, and some apply to connecting dashboard blocks to variables. Not all fields have a value for a connection because a given dashboard block connects to either a parameter or a variable.

Block Parameter: Binding**Type:** `Simulink.HMI.ParamSourceInfo`**Default:** `[]`**Button Type — Button response to click**

Momentary (default) | Latch

Specify how the block responds to a click.

- **Momentary** — The button changes state only while pressed. When you release the mouse, the button returns to its default state.
- **Latch** — The button latches the state change when clicked. The button remains in the pressed state until you click it again.

When you configure **Button Type** as **Momentary**, the block has these states:

- **Default** — Default state for the block when it is not pressed
- **Pressed** — Block state when the block is pressed

When you configure **Button Type** as **Latch**, the block has these states:

- **Default** — Default state for the block when it is not pressed.
- **Pressed** — Transitional state when you press the button while it is in the **Default** state. The block transitions to the **Latched** state when you release the mouse.
- **Latched** — Latched state for the block when it is not pressed.
- **Latched and Pressed** — Transitional state when you press the button while it is in the **Latched** state. The block transitions to the **Default** state when you release the mouse.

On Value — Value assigned to connected parameter when button is pressed or latched

1 (default) | scalar

The value assigned to the connected block parameter when the button is pressed or latched.

Tips

Use the **Block Type** parameter to configure how the block responds to a click:

- **Momentary** — The button applies the **On Value** only while you press it.
- **Latch** — The button latches the state change when you click it and applies the **On value** until you click it again.

Programmatic Use**Block Parameter:** `OnValue`**Type:** string or character array**Default:** `'1'`

Label — Block label position

Hide (default) | Bottom | Top

Position of the block label. When the block is connected to an element in the model, the label is the name of the connected element.

Programmatic Use**Block Parameter:** LabelPosition**Type:** character vector**Values:** 'Hide' | 'Bottom' | 'Top'**Default:** 'Hide'**Lock Aspect Ratio — Whether to maintain block aspect ratio**

on (default) | off

Whether to maintain the block aspect ratio when resizing the block and when you specify a new background image.

Block Characteristics

| | |
|---------------------------------|----------------------------------|
| Data Types | double half integer single |
| Direct Feedthrough | no |
| Multidimensional Signals | no |
| Variable-Size Signals | no |
| Zero-Crossing Detection | no |

Extended Capabilities**C/C++ Code Generation**

Generate C and C++ code using Simulink® Coder™.

Dashboard blocks are ignored for code generation.

See Also

Push Button | Callback Button

Introduced in R2021b

Push Button

Change parameter or variable value using button

Library: Simulink / Dashboard



Description

Use the Push Button block to change the value of the connected variable or parameter before or during simulation. You can configure the button to change the value only while you press the button or to latch the value change until you click the button again. Use the Push Button block with other Dashboard blocks to create an interactive dashboard to control your model.

Double-clicking the Push Button block does not open its dialog box during simulation or when the block is selected. To edit the block parameters, you can use the **Property Inspector** or open the block dialog box by:

- Double-clicking the block when the block is not selected and the model is not simulating.
- Right-clicking the block and selecting **Block Parameters** from the context menu.

Push Button Icons

You can add an icon to the Push Button block that is displayed alongside the button text. You can choose an icon from a predefined set that includes basic shapes, automotive indicators, and wireless icons, or you can upload your own custom icon. For more information, including a complete list of the built-in icons, see “Icon” on page 1-0 .

When you add an icon to the Push Button block, you can configure an on color and an off color for the icon so its color changes with the state of the block and specify the alignment of the icon relative to the button text. For example, this Push Button block is configured to use a circle icon with the on color specified as bright green, aligned to the left of the button text.



The icon settings for the Push Button block allow you to configure the appearance of the block in your model. When you want to customize the appearance of the block further, consider using the Push Button block in the Customizable Blocks library. The Push Button block in the Customizable Blocks library supports adding a custom icon but does not include any built-in icons.

Connect Dashboard Blocks

Dashboard blocks do not use ports to connect to model elements. To connect dashboard blocks to variables and block parameters, use connect mode. Connect mode facilitates the process of

connecting dashboard blocks in your model, especially when you want to connect multiple blocks at once. To connect a single dashboard block, you can also use the **Connection** table in the block dialog box.

Tip You can modify dashboard block connections in your model during normal and accelerator mode simulations.

Note Dashboard blocks cannot connect to variables until you update the model diagram. To connect dashboard blocks to variables or modify variable values between opening your model and running a simulation, update the model diagram using **Ctrl+D**.

To enter connect mode, select the block. Then, on the block tab, click **Connect**. In connect mode, when you select one or more blocks, a list of parameters and variables available for connection appears. Select a variable or parameter from the list to connect to the selected dashboard block.

When the value of the selected variable or block parameter is nonscalar, use the text box at the bottom of the **Connection** table to specify the element you want to connect to the dashboard block. To connect to an element of a vector, matrix, or array, specify the element index, for example, 3 or (1, 3). To connect to an element in a bus or structure, specify the element in the context of the bus or structure hierarchy by using dots to indicate different levels in the hierarchy, and omit the top level. For example, specify a.b to connect to scalar element b of the structure or bus a nested inside the selected composite variable or parameter.

To connect another dashboard block, pause on another dashboard block and click the **Connect** button above it. Then, make a selection of signals and blocks in your model and choose a model element to connect.

The screenshot displays the Simulink dashboard connection interface. The main window shows a Simulink model with a 'Connect' dialog box open. The dialog lists available variables and parameters for connection, including 'Constant: Value', 'Mu: Gain', and various 'Scope' parameters. A 'Scope' block is highlighted in the model, and its connection options are shown in the dialog. A 'Double-click to connect' button is visible in the bottom left corner of the dialog.

| Connect | |
|-----------------------|------------------------------|
| <input type="radio"/> | Constant: Value |
| <input type="radio"/> | Mu: Gain |
| <input type="radio"/> | Out1: InitialOutput |
| <input type="radio"/> | Out2: InitialOutput |
| <input type="radio"/> | Scope: ActiveDisplayString |
| <input type="radio"/> | Scope: ActiveDisplayYMaximum |
| <input type="radio"/> | Scope: ActiveDisplayYMinimum |
| <input type="radio"/> | Scope: AxesScalingNumUpdates |

When you finish connecting the dashboard blocks in your model, on the block tab, click **Done Connecting**.

Tip You can hide the message shown on unconnected blocks using the `set_param` function with the `ShowInitialText` block parameter. The message also disappears when you connect the block.

Parameter Logging

Tunable parameters connected to dashboard blocks are logged to the Simulation Data Inspector, where you can view the parameter values along with logged signal data. You can access logged parameter data in the MATLAB workspace by exporting the parameter data from the Simulation Data Inspector by using the UI or the `Simulink.sdi.exportRun` function. For more information about exporting data using the Simulation Data Inspector UI, see “Export Data to the Workspace or a File”. The parameter data is stored in a `Simulink.SimulationData.Parameter` object, accessible as an element in the exported `Simulink.SimulationData.Dataset`.

Limitations

- Except for the Dashboard Scope block and the Display block, dashboard blocks can only connect to real scalar signals.
- The toolstrip does not support blocks that are inside a panel.
- You cannot use the **Connection** table in the block dialog to connect a dashboard block to a block that is commented out. When you connect a dashboard block to a commented block using connect mode, the dashboard block does not display the connected value until the you uncomment the block.
- Dashboard blocks cannot connect to model elements inside referenced models.
- When you simulate a model hierarchy, dashboard blocks inside referenced models do not update.
- Dashboard blocks do not support rapid accelerator simulation.
- When you connect a dashboard block to a variable or parameter during simulation, the data for that variable or parameter is not logged to the Simulation Data Inspector. To log variable and parameter data to the Simulation Data Inspector, connect the dashboard block to the variable or parameter prior to simulation.
- When you simulate a model in external mode with the **Default parameter behavior** set to **Inlined**, dashboard blocks can appear to change parameter and variable values. However, the change does not propagate to the simulation. For example, Gain blocks display changes made to the **Gain** parameter using the dashboard blocks, but the **Gain** value used in the simulation does not change.

Parameters

Connection

Connection — Select a variable or block parameter to connect

variable and parameter connection options

Select the variable or block parameter to control using the **Connection** table. To connect the block to a signal:

- 1 Make a selection in the model that includes one or more blocks.
- 2 Select the variable or parameter you want to connect.

When the value of the selected variable or block parameter is nonscalar, use the text box at the bottom of the **Connection** table to specify the element you want to connect to the dashboard block. To connect to an element of a vector, matrix, or array, specify the element index, for example, 3 or (1, 3). To connect to an element in a bus or structure, specify the element in the context of the bus or structure hierarchy by using dots to indicate different levels in the hierarchy, and omit the top level. For example, specify a.b to connect to scalar element b of the structure or bus a nested inside the selected composite variable or parameter.

- 3 Click **Apply**.

To facilitate understanding and debugging your model, you can connect Dashboard blocks to variables and parameters in your model during simulation.

Note To see workspace variables in the connection table, update the model diagram using **Ctrl+D**.

Programmatic Use

To programmatically connect a dashboard block to a tunable parameter or a variable, use a `Simulink.HMI.ParamSourceInfo` object. The `Simulink.HMI.ParamSourceInfo` object contains four properties. Some of the properties apply to connecting dashboard blocks to parameters, and some apply to connecting dashboard blocks to variables. Not all fields have a value for a connection because a given dashboard block connects to either a parameter or a variable.

Block Parameter: Binding

Type: `Simulink.HMI.ParamSourceInfo`

Default: []

Main

Button Text — Text label for button

Button (default) | string | character vector

The text displayed on the Push Button block in your model.

Tips

To design a button that displays different text depending on the state of the block, use the Push Button block in the Customizable Blocks library.

Programmatic Use

Block Parameter: `ButtonText`

Type: string or character array

Default: 'Button'

On Value — Value assigned to connected parameter when button is pressed or latched

1 (default) | scalar

The value assigned to the connected block parameter when the button is pressed or latched.

Tips

Use the **Block Type** parameter to configure how the block responds to a click:

- **Momentary** — The button applies the **On Value** only while you press it.
- **Latch** — The button latches the state change when you click it and applies the **On value** until you click it again.

Programmatic Use**Block Parameter:** OnValue**Type:** string or character array**Default:** '1'**Button Type — Button response to click**

Momentary (default) | Latch

Specify how the button responds to a click.

- **Momentary** — The button applies the **On Value** only while you press it.
- **Latch** — The button latches the state change when you click it and applies the **On value** until you click it again.

Programmatic Use**Block Parameter:** ButtonType**Type:** string or character array**Value:** 'Momentary' | 'Latch'**Label — Block label position**

Hide (default) | Bottom | Top

Position of the block label. When the block is connected to an element in the model, the label is the name of the connected element.

Programmatic Use**Block Parameter:** LabelPosition**Type:** character vector**Values:** 'Hide' | 'Bottom' | 'Top'**Default:** 'Hide'**Format****Opacity — Block background opacity**

1 (default) | scalar

Block background opacity, specified as a scalar value between 0 and 1.

Example: 0.5

Programmatic Use**Block Parameter:** Opacity**Type:** scalar**Default:** 1**Foreground Color — Block foreground color**

[r g b] vector

Block foreground color, including the text. You can select a color from a palette of standard colors or specify a custom color.

Programmatic Use

Specify the `ForegroundColor` parameter for the block as a 1-by-3 `[r g b]` vector with values between 0 and 1.

Block Parameter: `ForegroundColor`

Type: `[r g b]` vector

Background Color — Block background color

`[r g b]` vector

Block background color. You can select a color from a palette of standard colors or specify a custom color.

Programmatic Use

Specify the `BackgroundColor` parameter for the block as a 1-by-3 `[r g b]` vector with values between 0 and 1.

Block Parameter: `BackgroundColor`

Type: `[r g b]` vector

Icon**Icon — Icon to display on button**

[SVG file](#) | [PNG file](#) | [JPEG file](#)

You can add an icon to the Push Button block to display alongside or instead of the button text. You can choose from built-in shape, automotive, and wireless icons, or you can upload your own custom SVG, PNG, or JPEG file to use as the icon.

To view icon options, on the **Icon** tab of the block dialog box, select an **Icon Type**. To use your own custom icon, select **Custom** as the **Icon Type** and upload the image file.

When you add an icon, you can configure the icon appearance using these parameters:

- **Icon Alignment** — Alignment of icon relative to button text
- **On Color** — Icon color when block is pressed or latched and applying the **On value** to the connected parameter
- **Off Color** — Icon color when the block is not pressed or latched and is not applying the **On value** to the connected parameter

To specify an **On Color** and **Off Color** for the icon, you must select **Customize Icon Color**.

Shape Icons

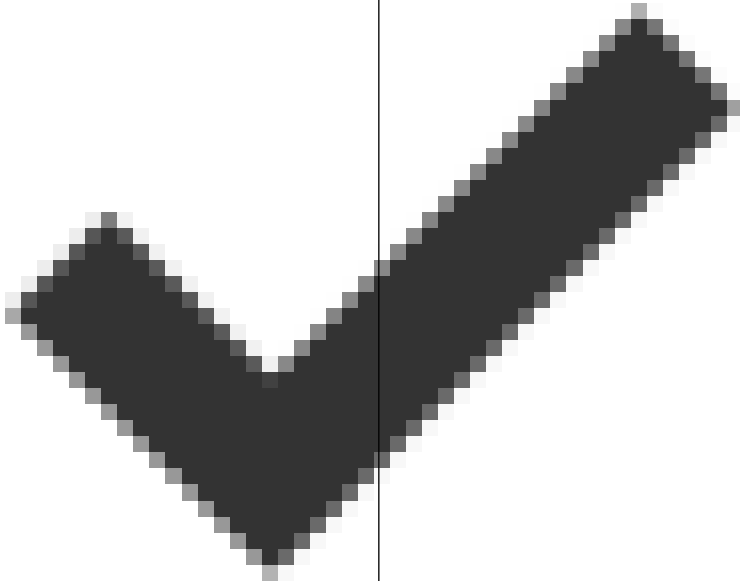
| Icon | Basic Shapes Library Block Name | Programmatic Use Value |
|---|--|-------------------------------|
|  | Check1 | Check1 |

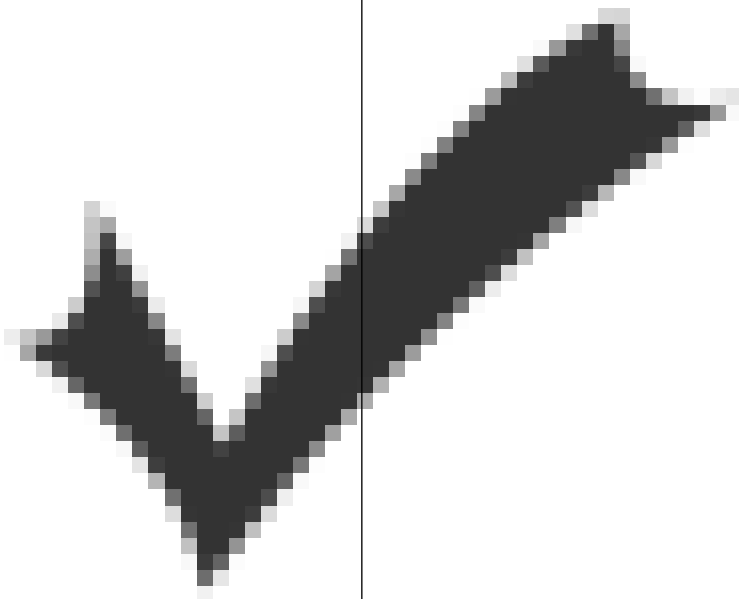
| Icon | Basic Shapes Library Block Name | Programmatic Use Value |
|---|--|-------------------------------|
|  | Check2 | Check2 |

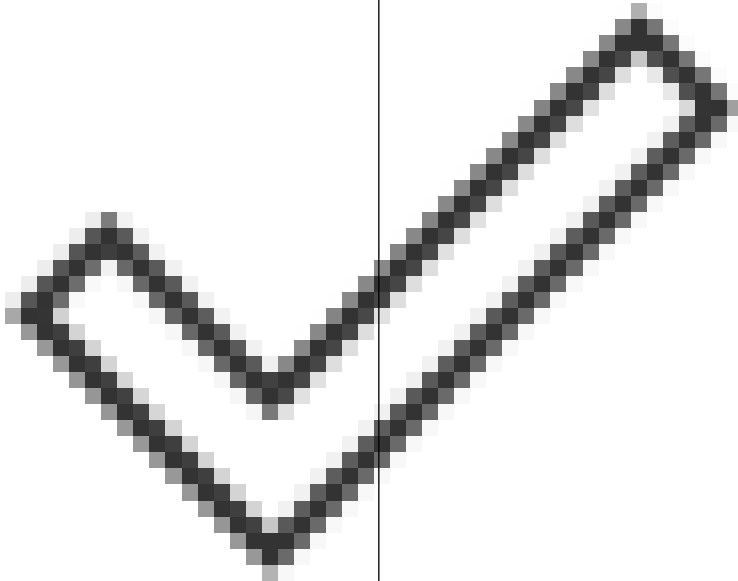
| Icon | Basic Shapes Library Block Name | Programmatic Use Value |
|---|---------------------------------|------------------------|
|  | Check3 | Check3 |

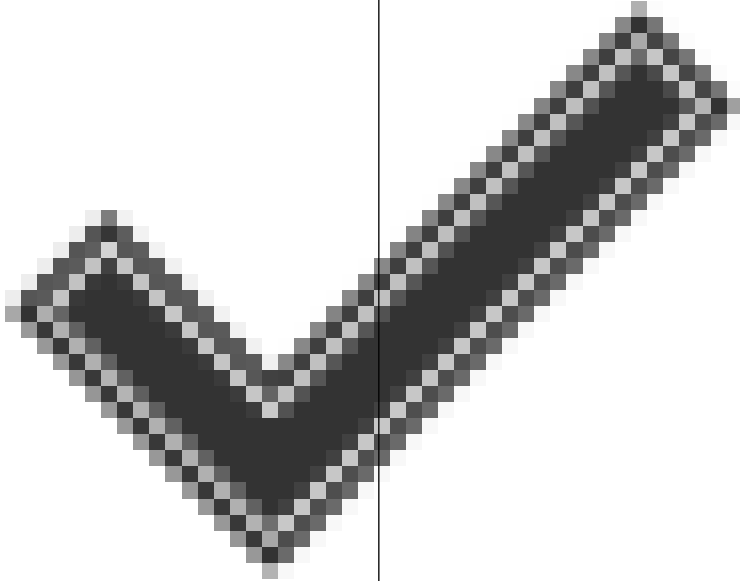
| Icon | Basic Shapes Library Block Name | Programmatic Use Value |
|---|--|-------------------------------|
|  | Check4 | Check4 |

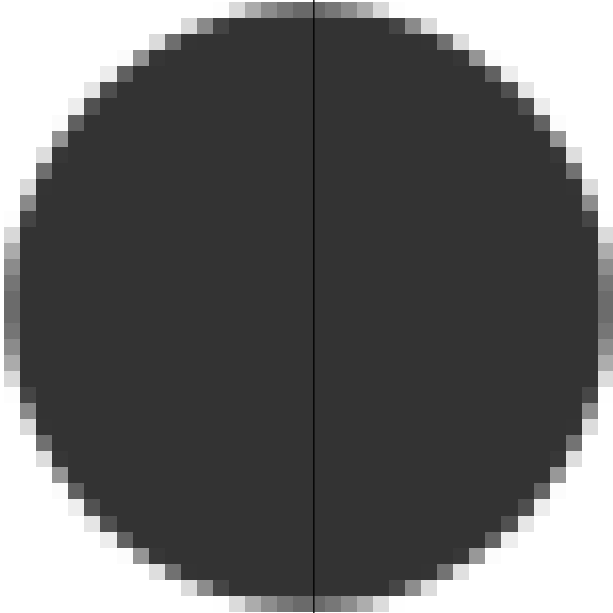
| Icon | Basic Shapes Library Block Name | Programmatic Use Value |
|--|---------------------------------|------------------------|
|  | Circle | Circle |

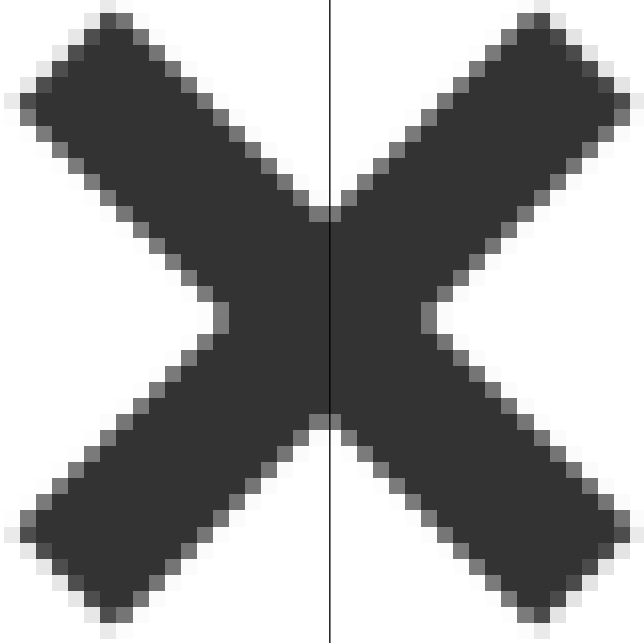
| Icon | Basic Shapes Library Block Name | Programmatic Use Value |
|--|--|-------------------------------|
|  | Ex1 | Ex1 |

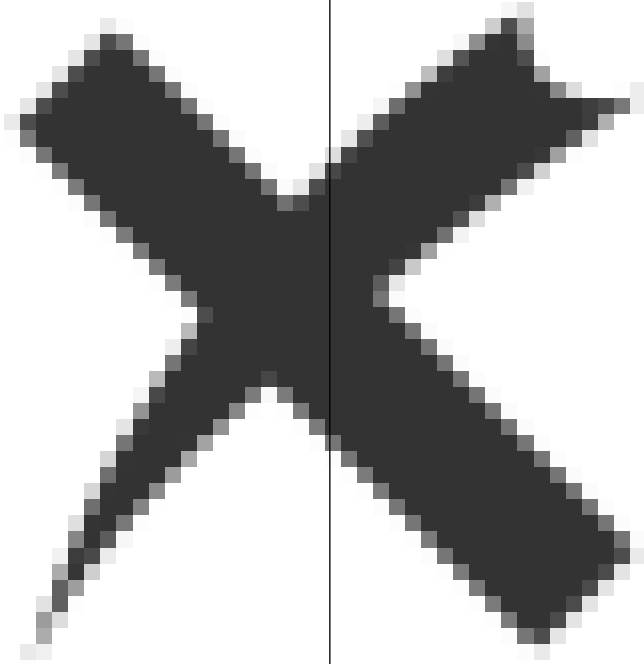
| Icon | Basic Shapes Library Block Name | Programmatic Use Value |
|--|---------------------------------|------------------------|
|  | Ex2 | Ex2 |

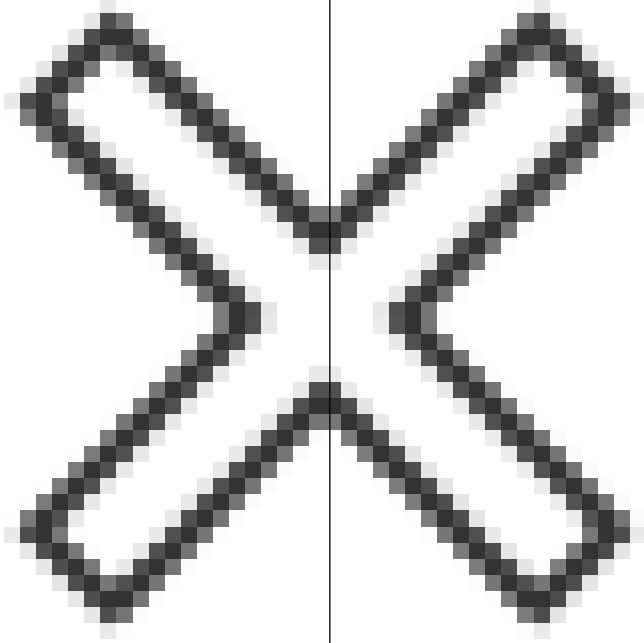
| Icon | Basic Shapes Library Block Name | Programmatic Use Value |
|--|---------------------------------|------------------------|
|  | Ex3 | Ex3 |

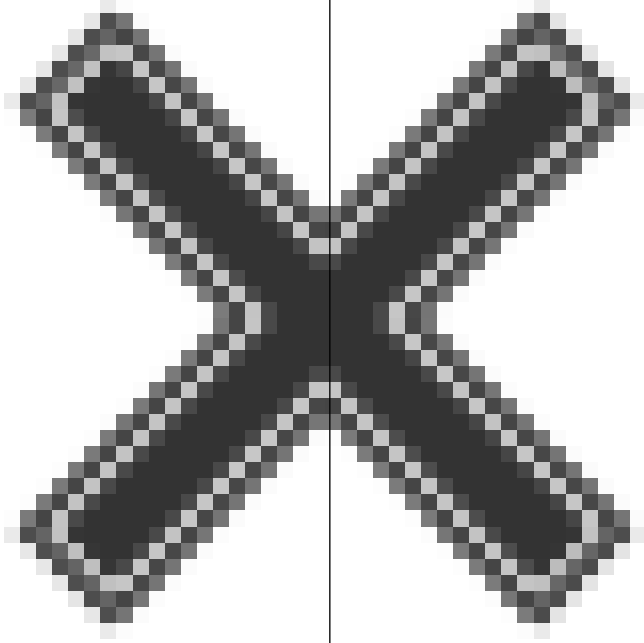
| Icon | Basic Shapes Library Block Name | Programmatic Use Value |
|--|---------------------------------|------------------------|
|  | Ex4 | Ex4 |

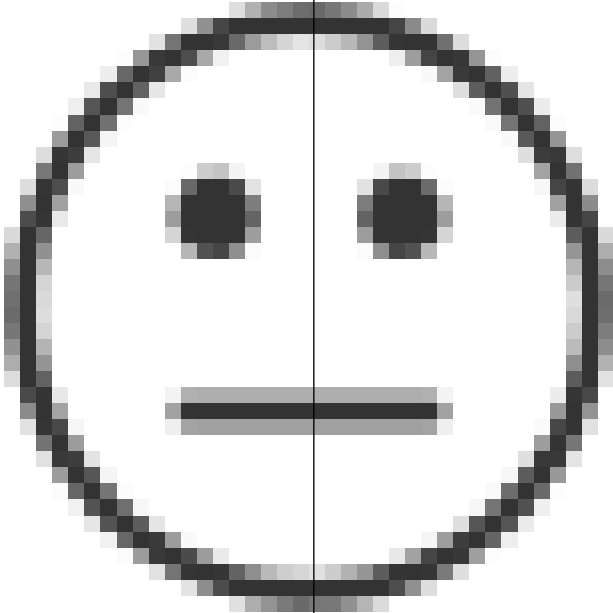
| Icon | Basic Shapes Library Block Name | Programmatic Use Value |
|--|--|-------------------------------|
|  | Face | Face |

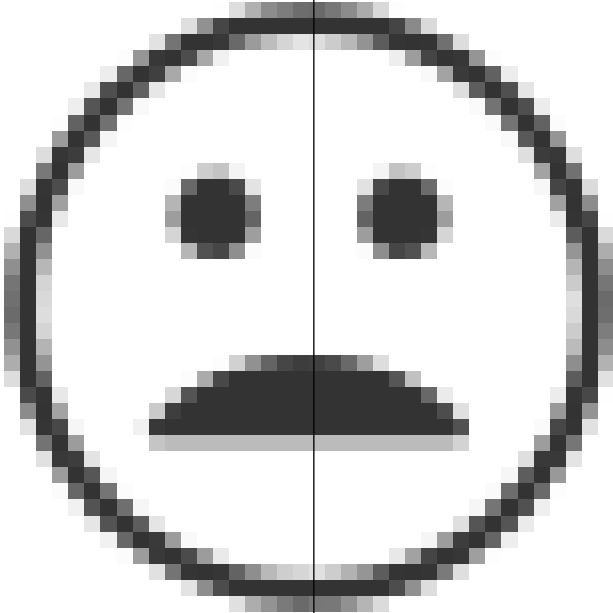
| Icon | Basic Shapes Library Block Name | Programmatic Use Value |
|--|---------------------------------|------------------------|
|  | Frown1 | Frown1 |

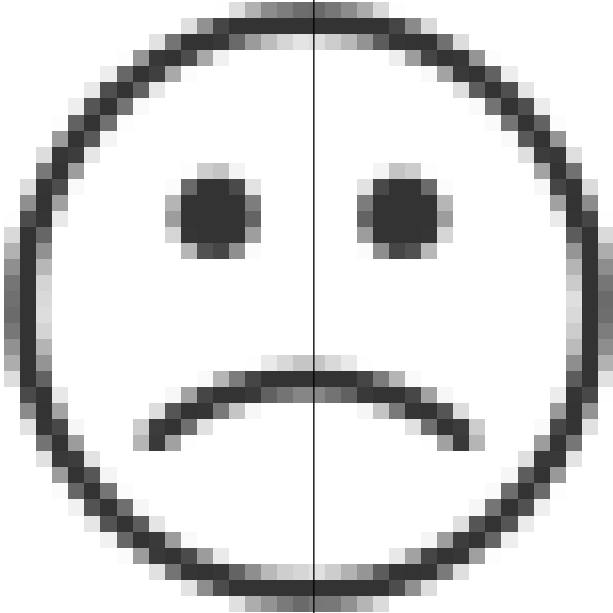
| Icon | Basic Shapes Library Block Name | Programmatic Use Value |
|--|--|-------------------------------|
|  | Frown2 | Frown2 |

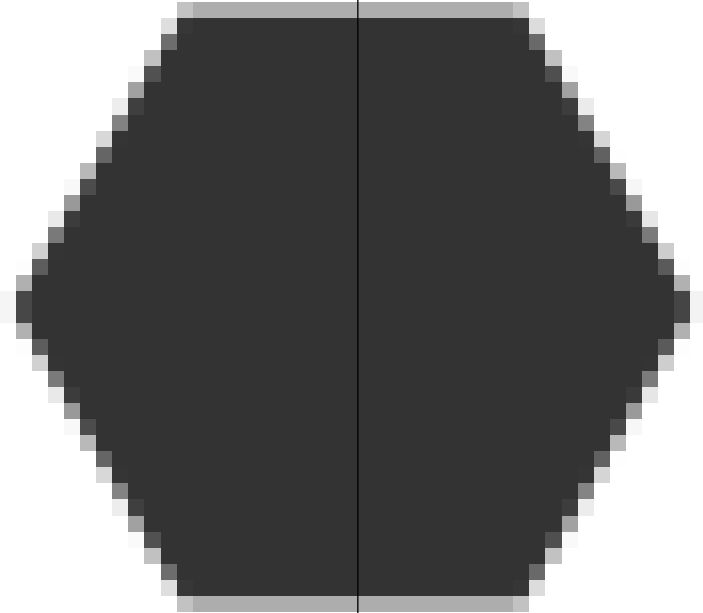
| Icon | Basic Shapes Library Block Name | Programmatic Use Value |
|--|---------------------------------|------------------------|
|  | Hexagon | Hexagon |

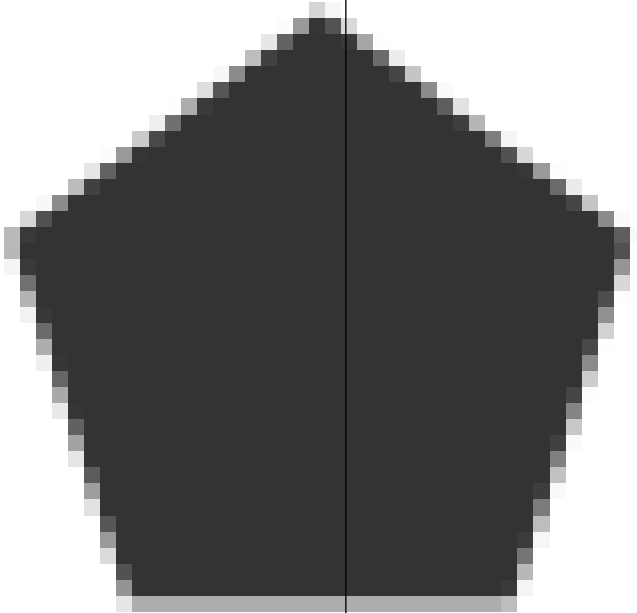
| Icon | Basic Shapes Library Block Name | Programmatic Use Value |
|--|--|-------------------------------|
|  | Pentagon | Pentagon |

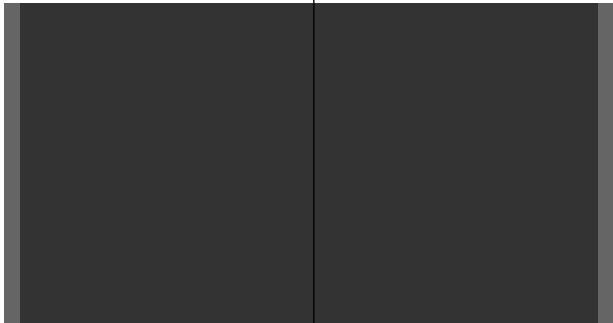
| Icon | Basic Shapes Library Block Name | Programmatic Use Value |
|---|---------------------------------|------------------------|
|  | Rectangle | Rectangle |

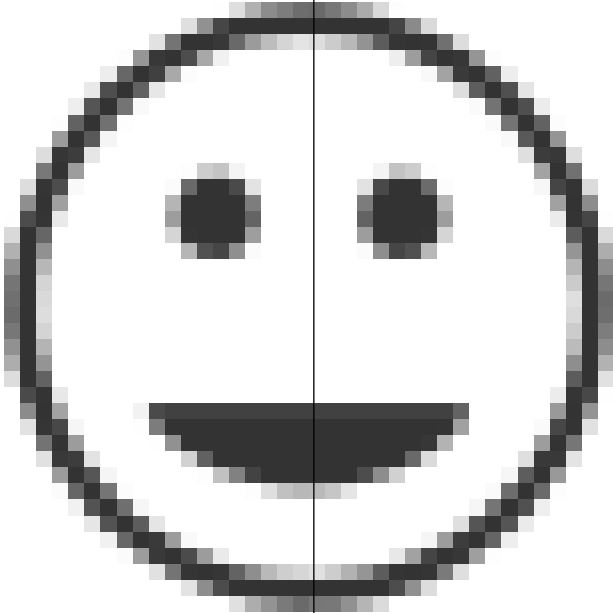
| Icon | Basic Shapes Library Block Name | Programmatic Use Value |
|--|--|-------------------------------|
|  | Smile1 | Smile1 |

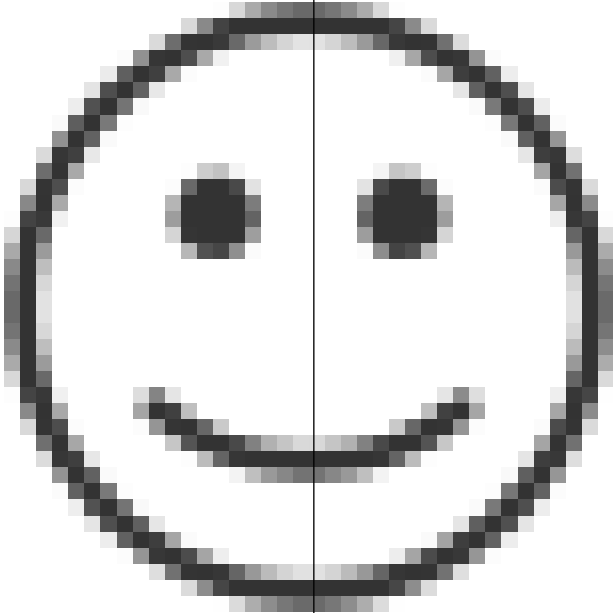
| Icon | Basic Shapes Library Block Name | Programmatic Use Value |
|--|---------------------------------|------------------------|
|  | Smile2 | Smile2 |

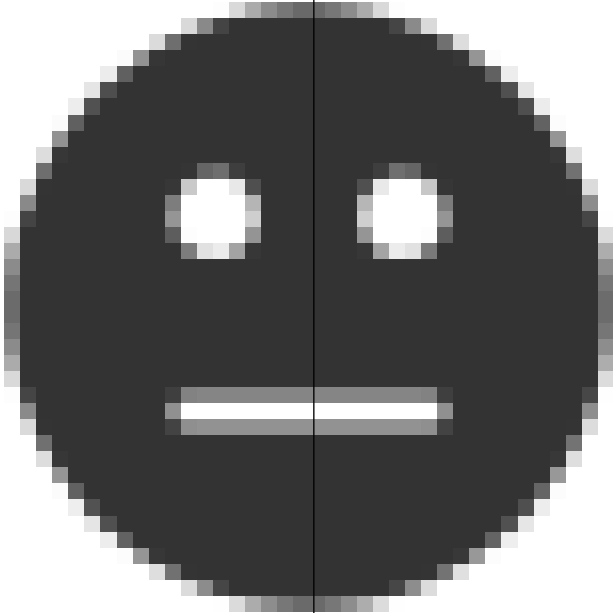
| Icon | Basic Shapes Library Block Name | Programmatic Use Value |
|--|--|-------------------------------|
|  | Solid Face | SolidFace |

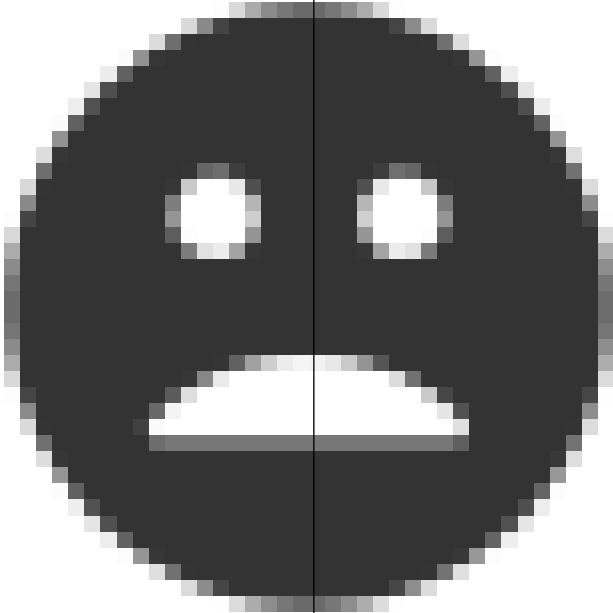
| Icon | Basic Shapes Library Block Name | Programmatic Use Value |
|--|---------------------------------|------------------------|
|  | Solid Frown1 | SolidFrown1 |

| Icon | Basic Shapes Library Block Name | Programmatic Use Value |
|--|--|-------------------------------|
|  | Solid Frown2 | SolidFrown2 |

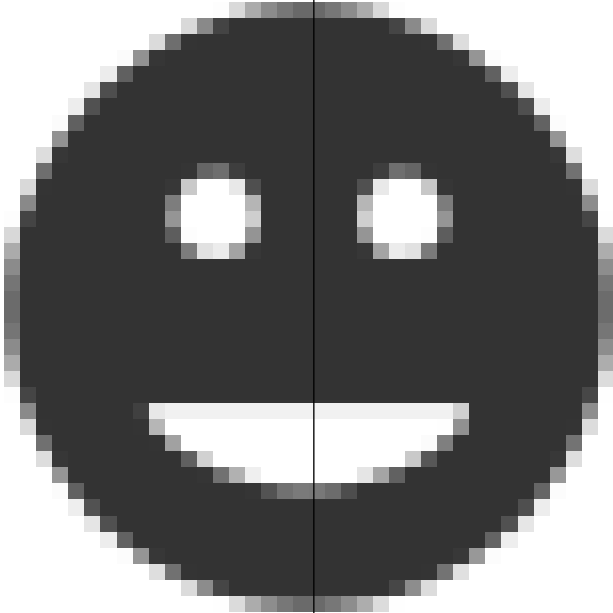
| Icon | Basic Shapes Library Block Name | Programmatic Use Value |
|--|---------------------------------|------------------------|
|  | Solid Smile1 | SolidSmile1 |

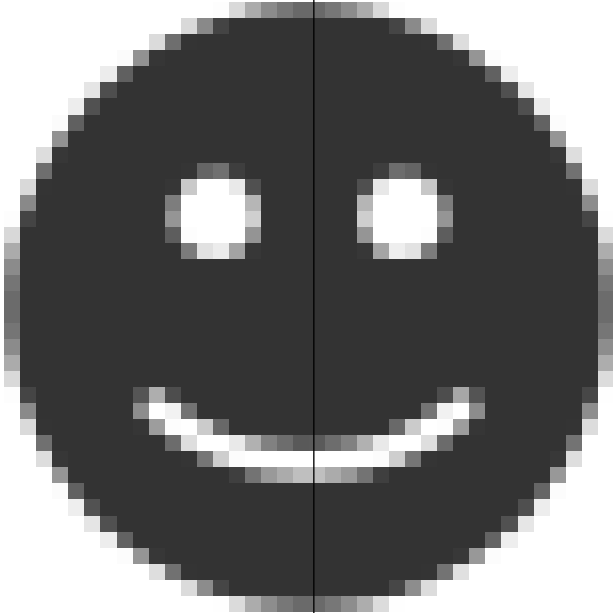
| Icon | Basic Shapes Library Block Name | Programmatic Use Value |
|--|--|-------------------------------|
|  | Solid Smile2 | SolidSmile2 |

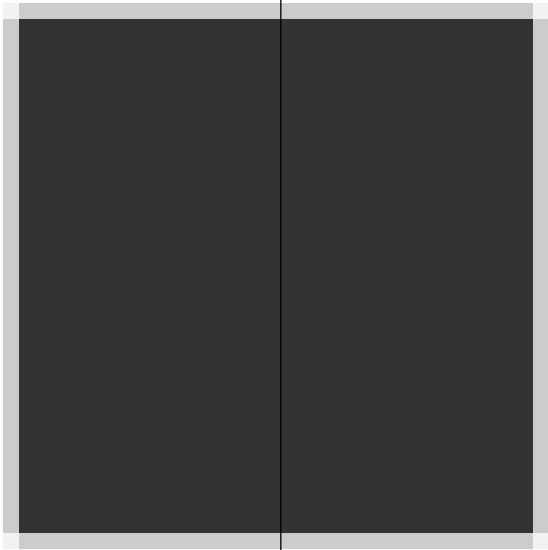
| Icon | Basic Shapes Library Block Name | Programmatic Use Value |
|--|---------------------------------|------------------------|
|  | Square | Square |

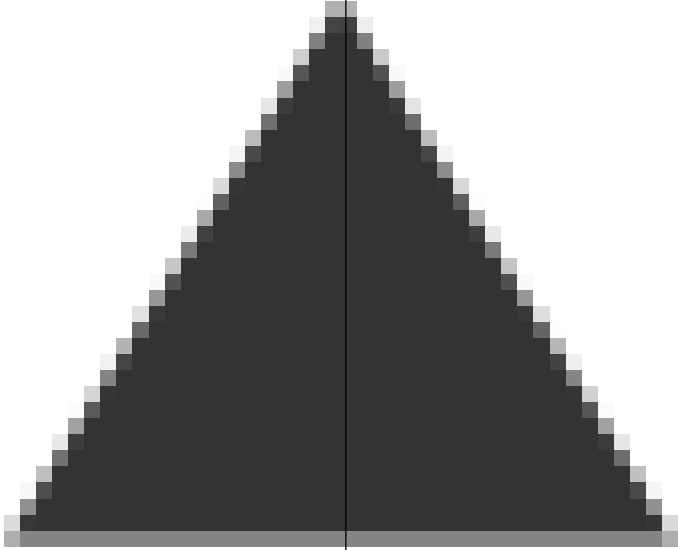
| Icon | Basic Shapes Library Block Name | Programmatic Use Value |
|---|--|-------------------------------|
|  | Triangle | Triangle |

Automotive Icons

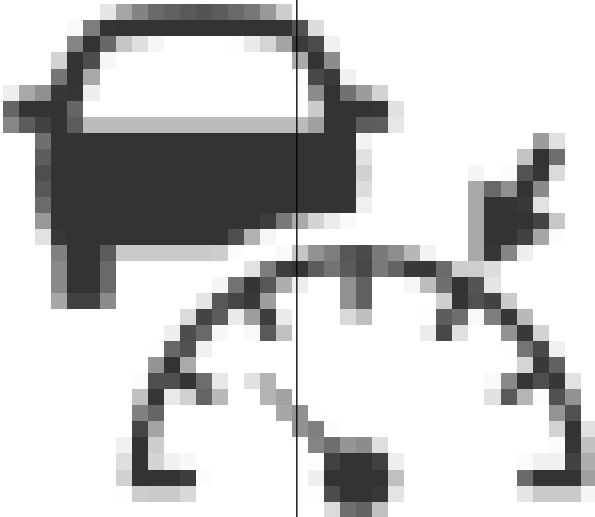
| Icon | Automotive Indicator Lamps Library Block Name | Programmatic Use Value |
|--|--|-------------------------------|
|  | Adaptive Cruise Control | AdaptiveCruiseControl |

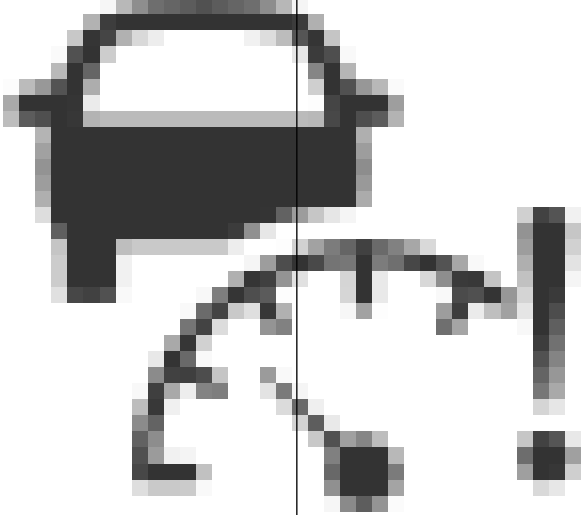
| Icon | Automotive Indicator Lamps Library Block Name | Programmatic Use Value |
|--|--|------------------------------|
|  A pixelated black and white icon showing a car from a side profile. A line extends from the front of the car to a large exclamation mark, indicating a warning or error. | Adaptive Cruise Control Failure | AdaptiveCruiseControlFailure |

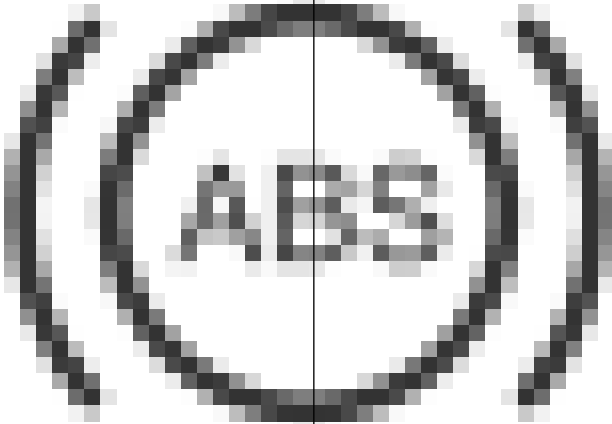
| Icon | Automotive Indicator Lamps Library Block Name | Programmatic Use Value |
|---|--|------------------------|
|  | Antilock Brake System | AntilockBrakeSystem |

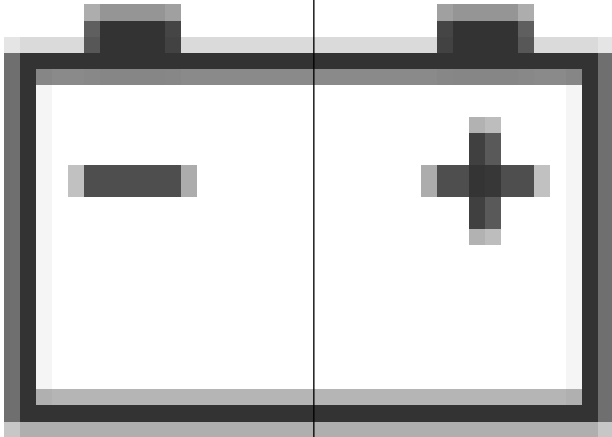
| Icon | Automotive Indicator Lamps Library Block Name | Programmatic Use Value |
|---|--|-------------------------------|
|  | Battery | Battery |

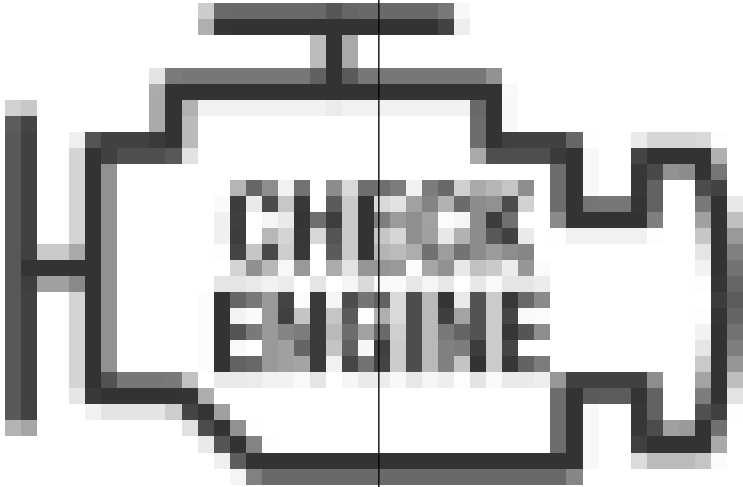
| Icon | Automotive Indicator Lamps Library Block Name | Programmatic Use Value |
|--|---|------------------------|
|  A pixelated, black and white icon of an engine. The engine is depicted with various components like the cylinder head, intake manifold, and a timing belt. The words "CHECK ENGINE" are written across the center of the engine in a bold, blocky font. | Check Engine | CheckEngine |

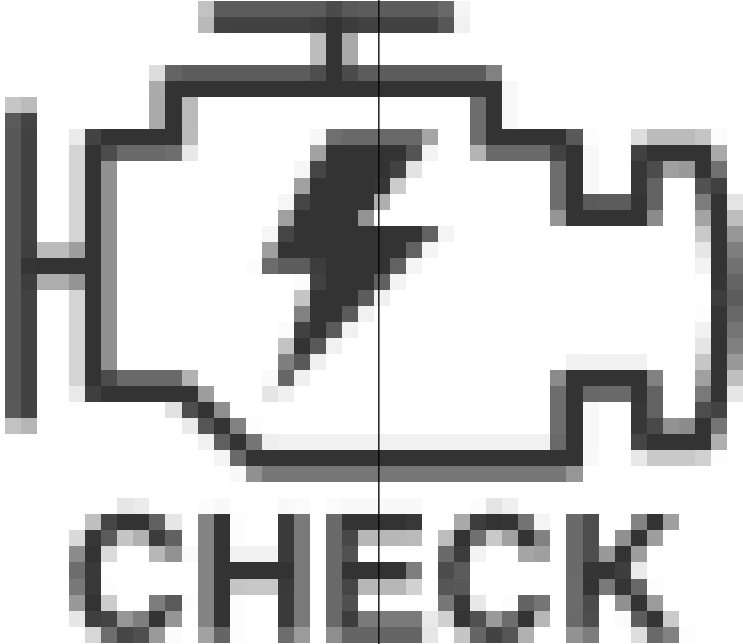
| Icon | Automotive Indicator Lamps Library Block Name | Programmatic Use Value |
|---|--|------------------------|
|  | Check Engine2 | CheckEngine2 |

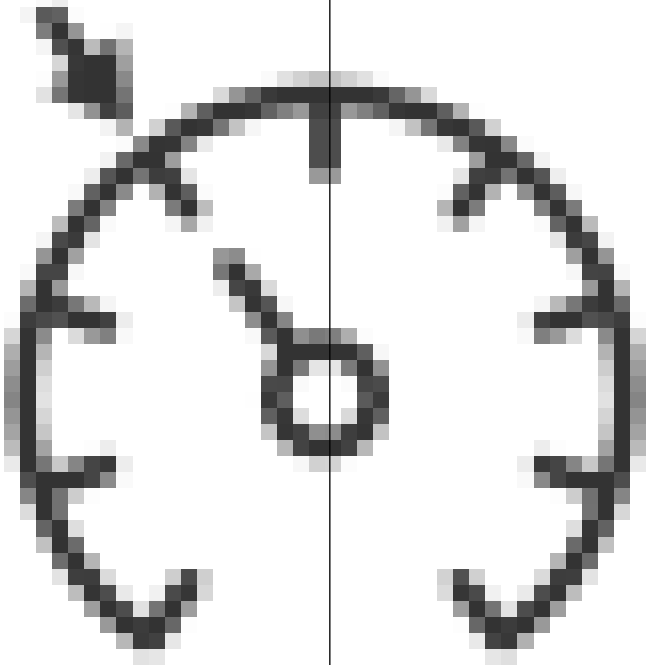
| Icon | Automotive Indicator Lamps Library Block Name | Programmatic Use Value |
|--|--|------------------------|
|  | Cruise Control | CruiseControl |

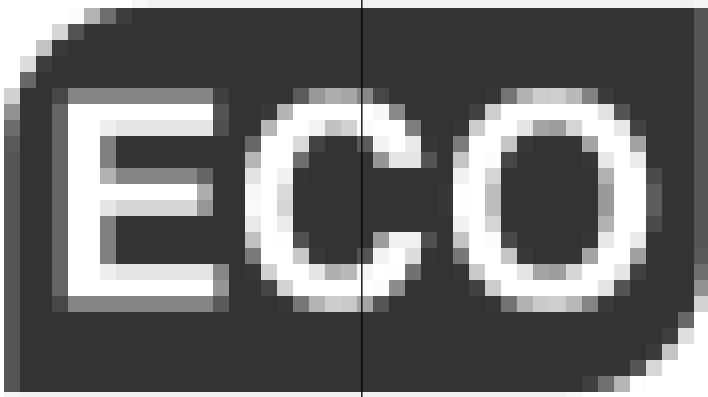
| Icon | Automotive Indicator Lamps Library Block Name | Programmatic Use Value |
|---|--|-------------------------------|
|  | Eco Mode | EcoMode |

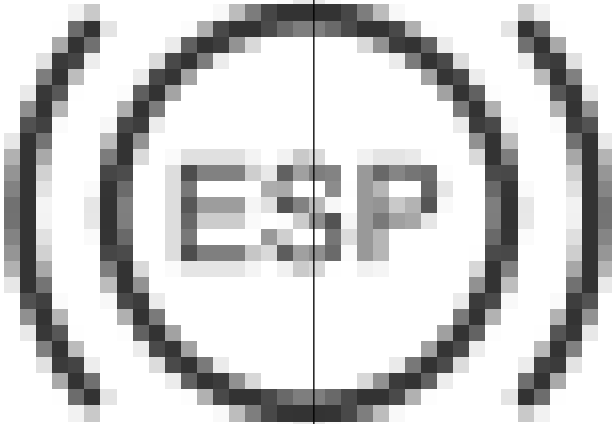
| Icon | Automotive Indicator Lamps Library Block Name | Programmatic Use Value |
|--|--|------------------------|
|  The icon is a circular symbol with a thick black border. Inside the circle, the letters "ESP" are written in a bold, sans-serif font. The entire icon is rendered in a pixelated, grayscale style. | Electronic Stability | ElectronicStability |

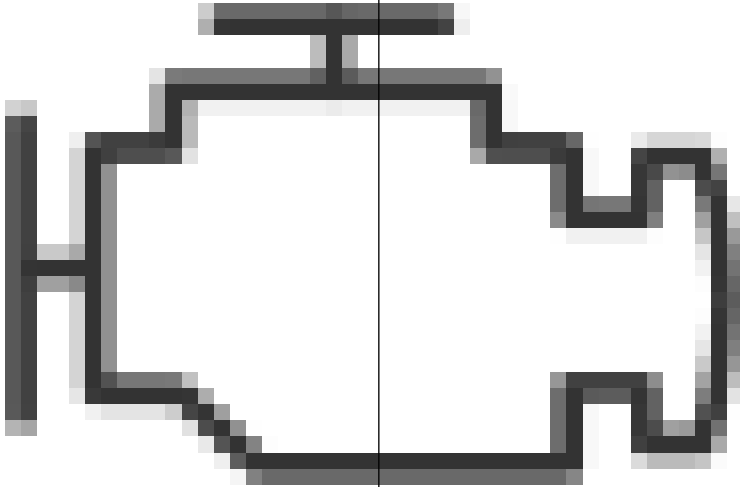
| Icon | Automotive Indicator Lamps Library Block Name | Programmatic Use Value |
|---|--|------------------------|
|  A stylized, pixelated black and white icon of an engine. It features a central vertical shaft with a horizontal bar at the top, and a complex, irregular shape representing the engine block and various components. | Engine | Engine |

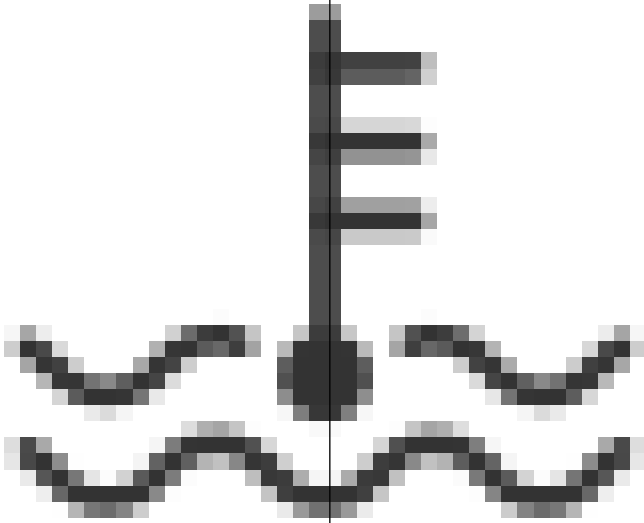
| Icon | Automotive Indicator Lamps Library Block Name | Programmatic Use Value |
|---|--|--------------------------|
|  | <p>Engine Coolant Temp</p> | <p>EngineCoolantTemp</p> |

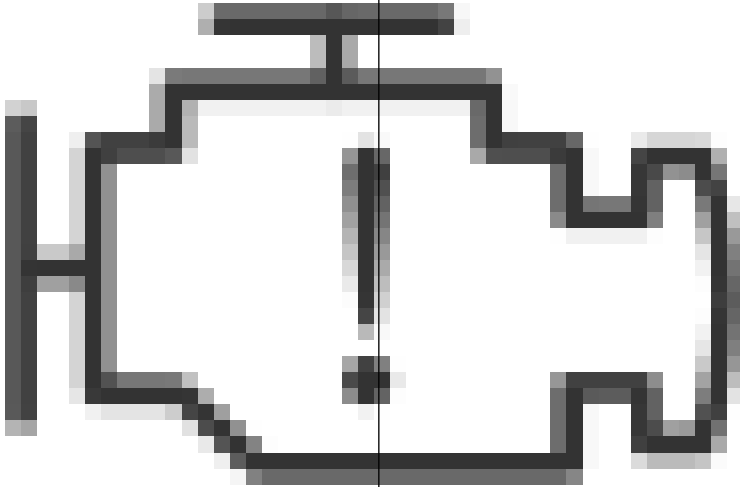
| Icon | Automotive Indicator Lamps Library Block Name | Programmatic Use Value |
|--|--|-------------------------------|
|  | Engine Failure | EngineFailure |

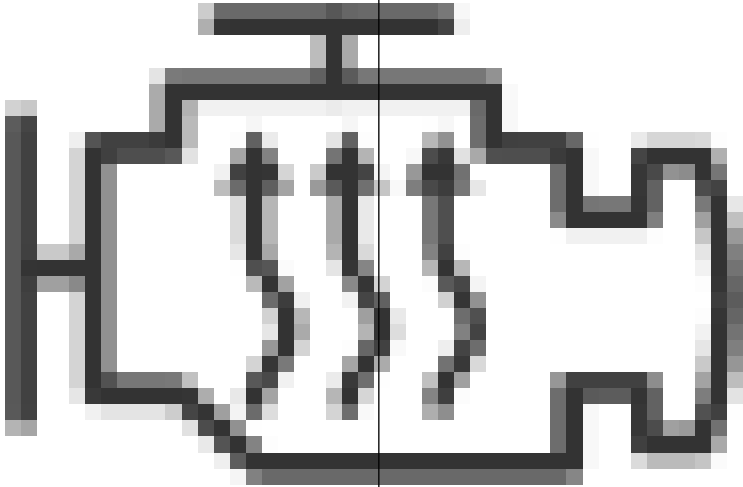
| Icon | Automotive Indicator Lamps Library Block Name | Programmatic Use Value |
|--|--|------------------------|
|  | Engine Heating | EngineHeating |

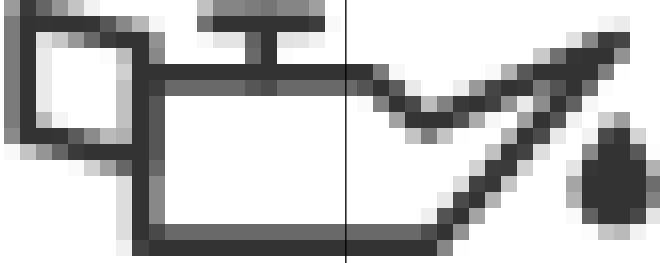
| Icon | Automotive Indicator Lamps Library Block Name | Programmatic Use Value |
|---|--|------------------------|
|  A black and white icon of an engine oil lamp. It features a rectangular base with a vertical line on the left side. A horizontal line extends from the top of the base to the right, where it meets a vertical line. From this junction, a diagonal line goes down and to the right, ending in a circular shape. A horizontal line also extends from the top of the base to the right, ending in a small rectangular shape. | Engine Oil | EngineOil |

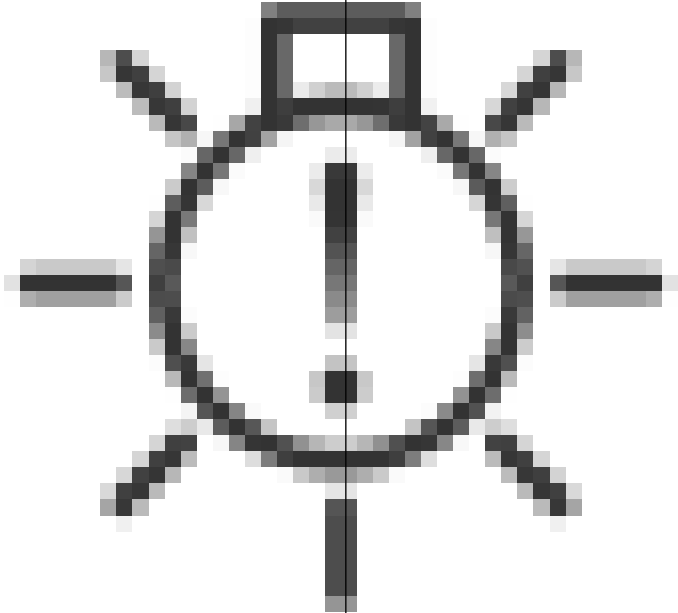
| Icon | Automotive Indicator Lamps Library Block Name | Programmatic Use Value |
|--|--|------------------------|
|  | Exterior Bulb Failure | ExteriorBulbFailure |

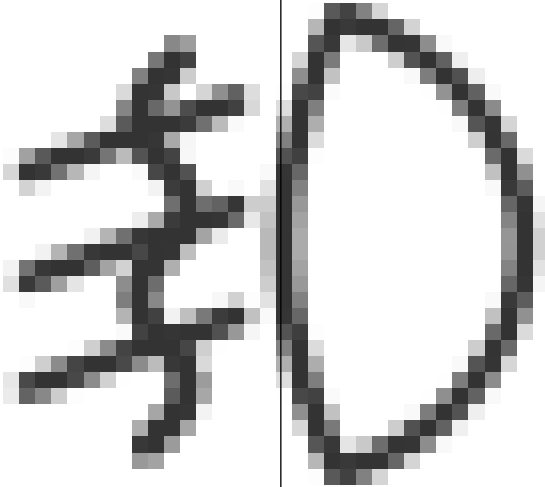
| Icon | Automotive Indicator Lamps Library Block Name | Programmatic Use Value |
|---|--|-------------------------------|
|  | Front Fog Light | FrontFogLight |

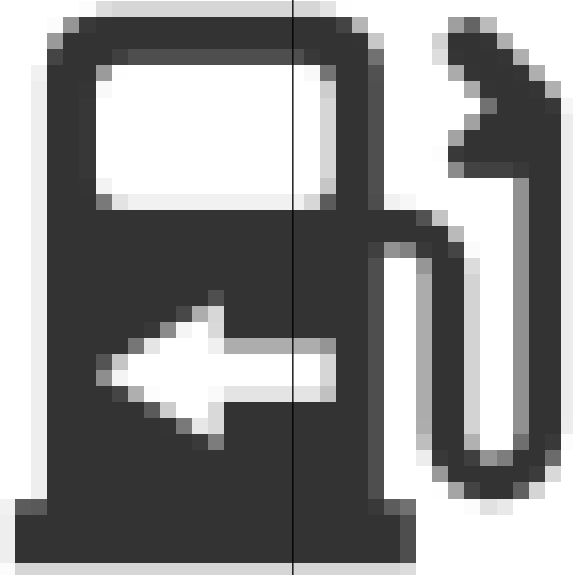
| Icon | Automotive Indicator Lamps Library Block Name | Programmatic Use Value |
|--|--|------------------------|
|  A black and white icon of a fuel pump nozzle. The nozzle is on the right, with a curved handle. A hose extends from the nozzle to a rectangular fuel tank on the left. The tank has a white cross symbol on its front face. | Fuel | Fuel |

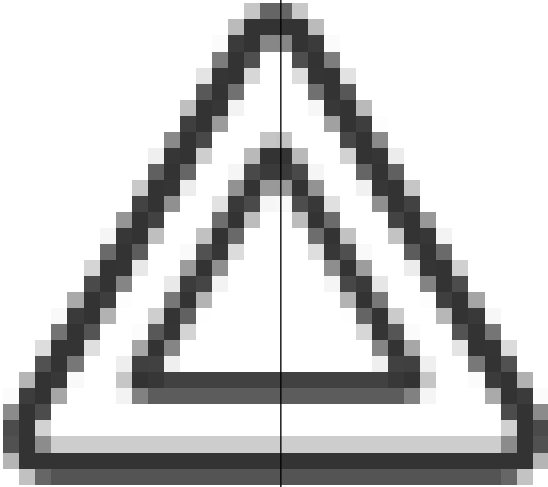
| Icon | Automotive Indicator Lamps Library Block Name | Programmatic Use Value |
|---|--|-------------------------------|
|  | Hazards | Hazards |

| Icon | Automotive Indicator Lamps Library Block Name | Programmatic Use Value |
|---|--|------------------------|
|  A black and white icon depicting a headlamp. The headlamp is shown in profile, facing right. It has a rectangular body with a curved top and bottom. To the left of the headlamp, there are several horizontal lines of varying lengths, representing light rays or a leveling mechanism. The entire icon is rendered in a pixelated, grayscale style. | Headlamp Leveling | HeadlampLeveling |

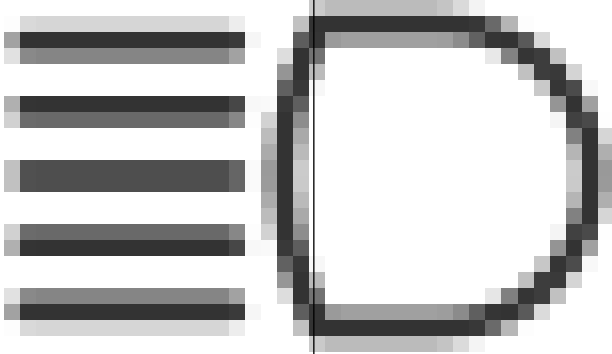
| Icon | Automotive Indicator Lamps Library Block Name | Programmatic Use Value |
|---|--|------------------------|
|  | High Beams | HighBeams |

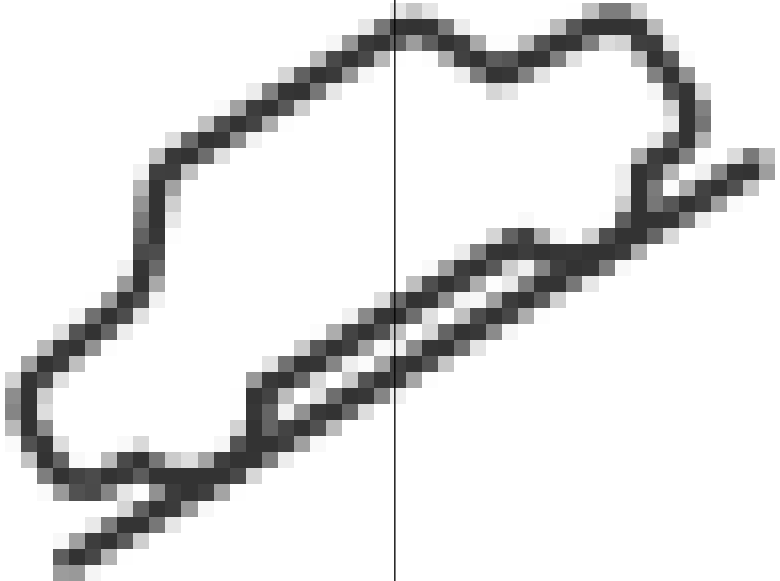
| Icon | Automotive Indicator Lamps Library Block Name | Programmatic Use Value |
|---|---|------------------------|
|  | Hill Descent Control | HillDescentControl |

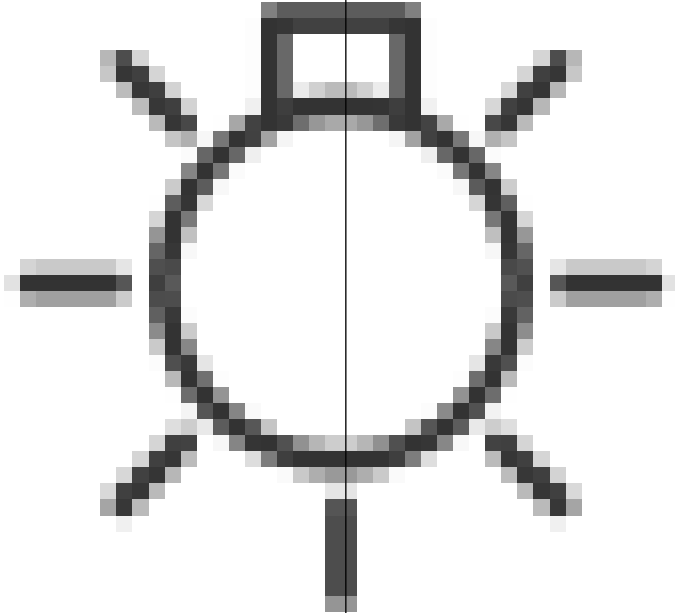
| Icon | Automotive Indicator Lamps Library Block Name | Programmatic Use Value |
|--|--|------------------------|
|  | Lighting Switch | LightingSwitch |

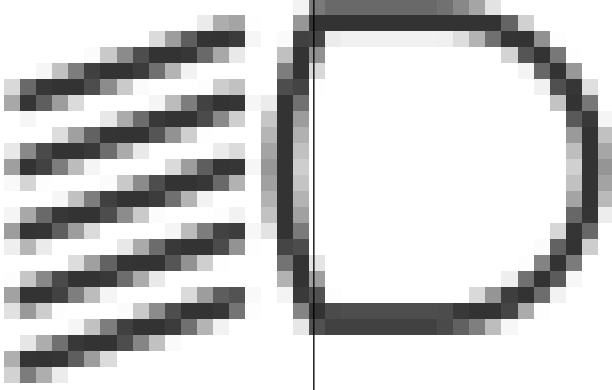
| Icon | Automotive Indicator Lamps Library Block Name | Programmatic Use Value |
|---|--|------------------------|
|  A pixelated icon of a low beam headlight. It features a series of horizontal lines on the left side, representing the light beam, and a large, rounded 'D' shape on the right side, representing the headlight housing. | Low Beams | LowBeams |

| Icon | Automotive Indicator Lamps Library Block Name | Programmatic Use Value |
|---|--|-------------------------------|
|  | Parking Assistance | ParkingAssistance |

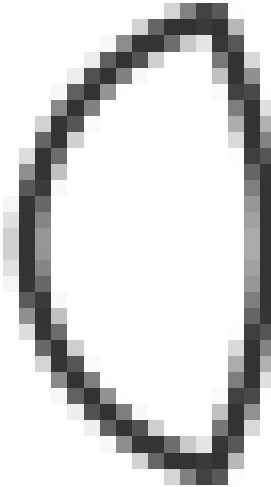
| Icon | Automotive Indicator Lamps Library Block Name | Programmatic Use Value |
|--|--|------------------------|
|  A pixelated icon of a rear fog light, consisting of a large, vertically-oriented oval shape with a thick, dark border. | Rear Fog Light | RearFogLight |

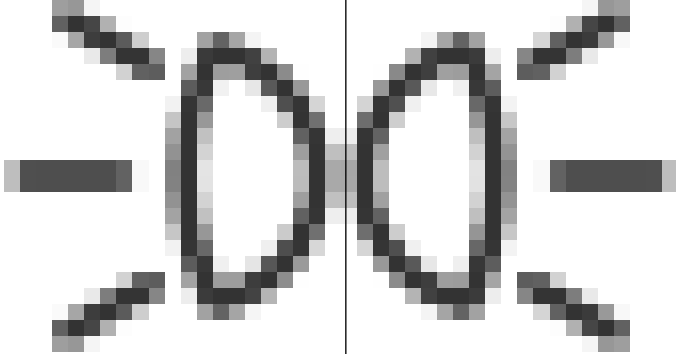
| Icon | Automotive Indicator Lamps Library Block Name | Programmatic Use Value |
|---|--|-------------------------------|
|  | Side Lights | SideLights |

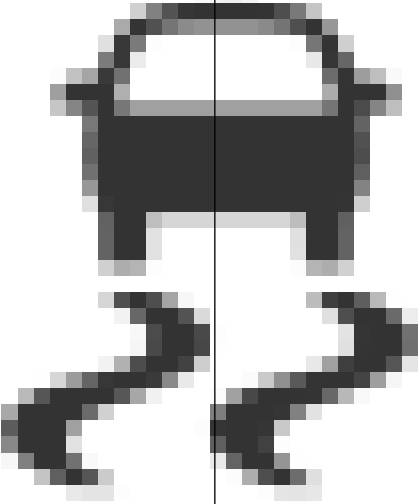
| Icon | Automotive Indicator Lamps Library Block Name | Programmatic Use Value |
|---|--|------------------------|
|  | Stability Control | StabilityControl |

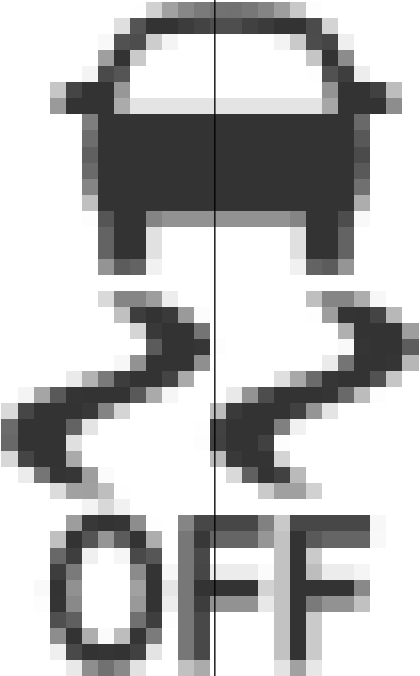
| Icon | Automotive Indicator Lamps Library Block Name | Programmatic Use Value |
|--|--|------------------------|
|  | Stability Control Off | StabilityControlOff |

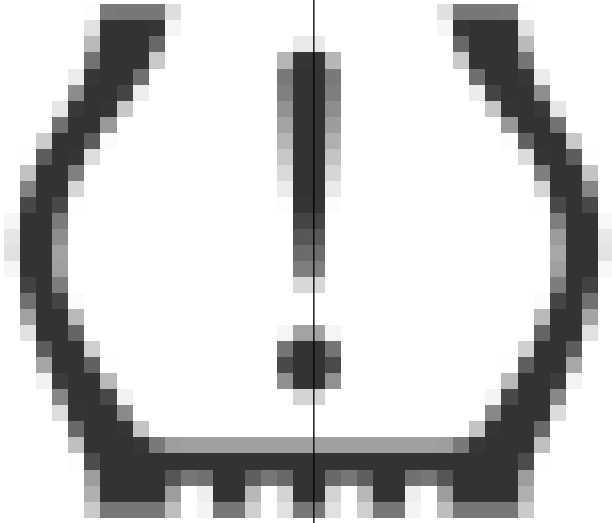
| Icon | Automotive Indicator Lamps Library Block Name | Programmatic Use Value |
|---|--|------------------------|
|  | Tire Monitor | TireMonitor |

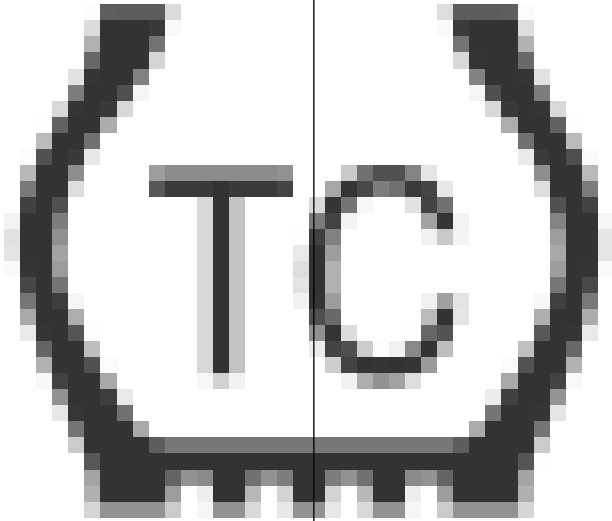
| Icon | Automotive Indicator Lamps Library Block Name | Programmatic Use Value |
|---|--|------------------------|
|  | Traction Control | TractionControl |

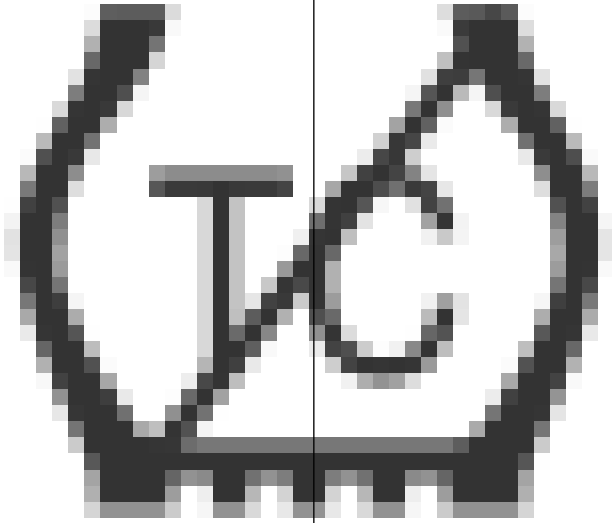
| Icon | Automotive Indicator Lamps Library Block Name | Programmatic Use Value |
|--|--|------------------------|
|  A pixelated black and white icon showing a gear with the letters 'TC' inside it, representing a traction control system. | Traction Control Off | TractionControlOff |

| Icon | Automotive Indicator Lamps Library Block Name | Programmatic Use Value |
|--|--|------------------------|
|  | Traction Control Failure | TractionControlFailure |

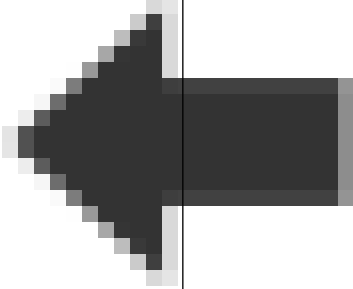
| Icon | Automotive Indicator Lamps Library Block Name | Programmatic Use Value |
|--|--|------------------------|
|  A black, pixelated arrow pointing to the left, centered in the cell. | Turn Signal Left | TurnSignalLeft |

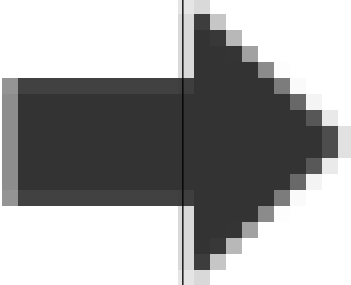
| Icon | Automotive Indicator Lamps Library Block Name | Programmatic Use Value |
|---|--|-------------------------------|
|  | Turn Signal Right | TurnSignalRight |

Wireless Icons

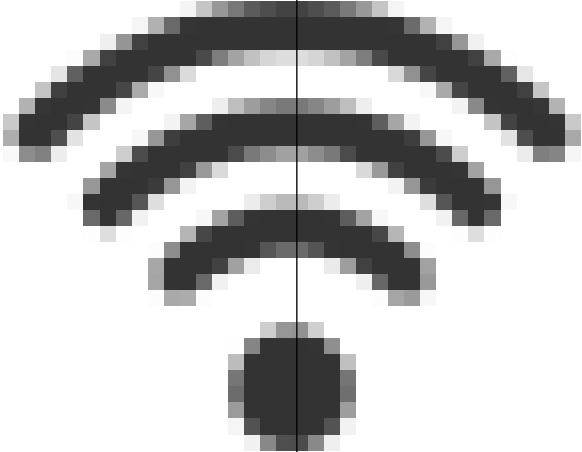
| Icon | Wireless Icons Library Block Name | Programmatic Use Value |
|---|--|-------------------------------|
|  A black and white icon representing a wireless network. It consists of three curved lines of decreasing size from top to bottom, with a solid black circle at the bottom center, resembling a signal strength indicator. | Network | Network |

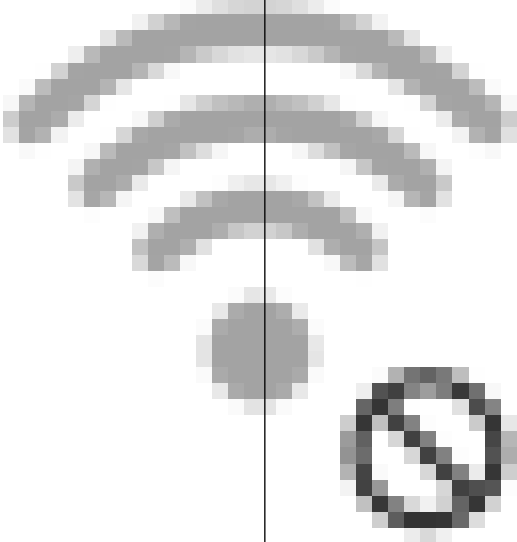
| Icon | Wireless Icons Library Block Name | Programmatic Use Value |
|---|-----------------------------------|------------------------|
|  A pixelated icon representing a network with no signal. It features three curved lines at the top, a solid circle in the middle, and a circle with a diagonal slash at the bottom right. | Network No Signal | NetworkNoSignal |

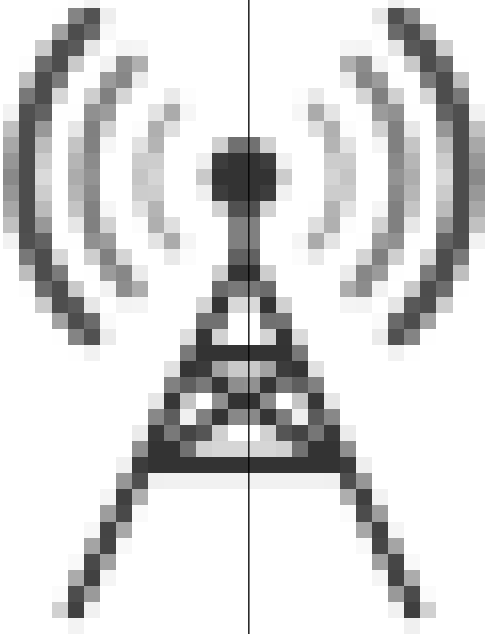
| Icon | Wireless Icons Library Block Name | Programmatic Use Value |
|--|-----------------------------------|------------------------|
|  | Network Transmission | NetworkTransmission |

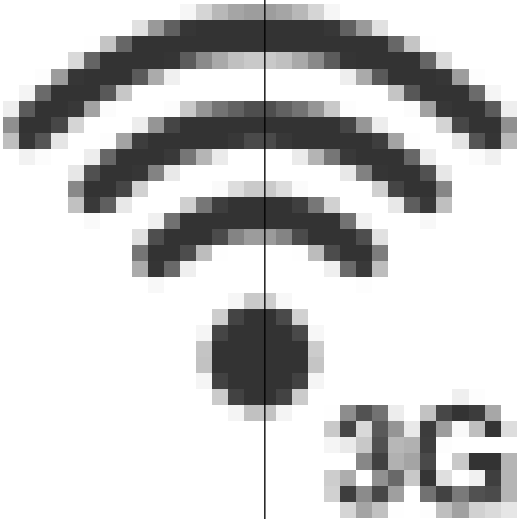
| Icon | Wireless Icons Library Block Name | Programmatic Use Value |
|---|-----------------------------------|------------------------|
|  | Network3G | Network3G |

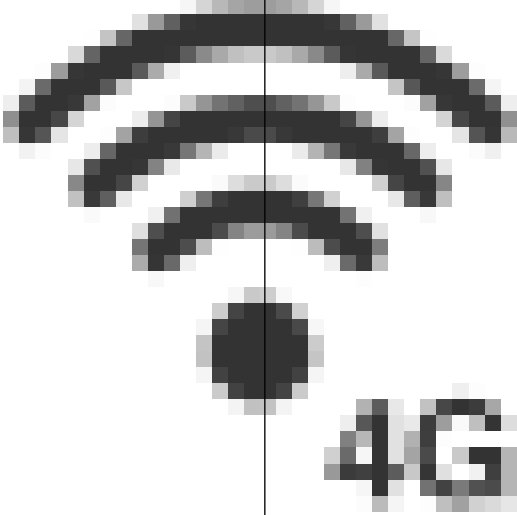
| Icon | Wireless Icons Library Block Name | Programmatic Use Value |
|--|-----------------------------------|------------------------|
|  A black and white icon representing a 4G wireless network. It features a stylized signal tower with three curved lines above it, and the letters "4G" positioned to the right of the tower's base. | Network4G | Network4G |

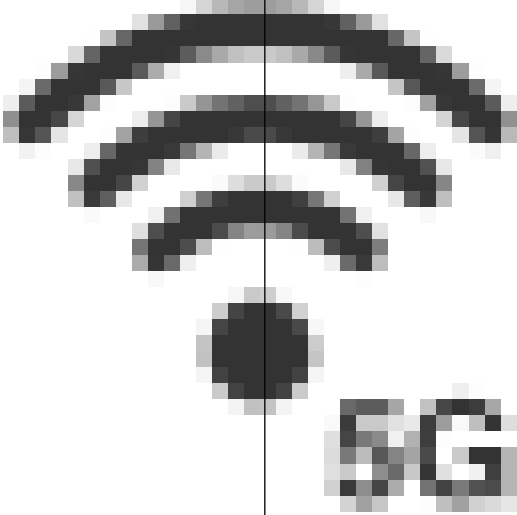
| Icon | Wireless Icons Library Block Name | Programmatic Use Value |
|---|-----------------------------------|------------------------|
|  | Network5G | Network5G |

Tips

- You can change the icon for a Push Button block using the **Button** tab in the toolbar.
- If you want to customize the appearance of the Push Button block further, consider designing your own button using the Push Button block in the Customizable Blocks library.

The Push Button block in the Customizable Blocks library supports adding a custom icon but does not include any built-in icons.

- The on and off colors for the icon can apply to these SVG elements:
 - altGlyph
 - circle
 - ellipse
 - path
 - polygon
 - rect
 - text
 - textPath
 - tref
 - tspan

Programmatic Use**Block Parameter:** Icon**Type:** string | character vector**Default:** 'Default'**Icon Alignment — Icon alignment relative to button text**

Left (default) | Right | Top | Bottom | Center

Alignment of the icon relative to the button text. When you do not specify button text, the icon is always in the center of the block.

Programmatic Use**Block Parameter:** IconAlignment**Type:** string | character vector**Value:** 'Left' | 'Right' | 'Top' | 'Bottom' | 'Center'**Default:** 'Left'**Customize Icon Color — Whether to use icon on and off colors**

Off (default) | On

When you add an icon to the Push Button block, you can specify on and off colors so the icon color changes to reflect the state of the block. To use and specify the **On Color** and **Off Color** for an icon, select **Customize Icon Color**.

Programmatic Use**Block Parameter:** IconColor**Type:** string | character vector**Value:** 'On' | 'Off'**Default:** 'Off'**On Color — Icon color when block is pressed or latched**

[r g b] vector

When you add an icon to the Push Button block, you can specify on and off colors so the icon color changes to reflect the state of the block. The **On Color** specifies the color of the icon when the block is pressed or latched and is applying the **On value** to the connected parameter. You can select a color from a palette of standard colors or specify a custom color.

Dependencies

To enable the **On Color** parameter, select **Customize Icon Color**.

Programmatic Use

Specify the IconOnColor parameter for the block as a 1-by-3 [r g b] vector with values between 0 and 1.

Block Parameter: IconOnColor**Type:** [r g b] vector**Off Color — Icon color when block is not pressed or latched**

[r g b] vector

When you add an icon to the Push Button block, you can specify on and off colors so the icon color changes to reflect the state of the block. The **Off Color** specifies the color of the icon when the block is not pressed or latched and is not applying the **On value** to the connected parameter. You can select a color from a palette of standard colors or specify a custom color.

Dependencies

To enable the **On Color** parameter, select **Customize Icon Color**.

Programmatic Use

Specify the `IconOffColor` parameter for the block as a 1-by-3 [r g b] vector with values between 0 and 1.

Block Parameter: `IconOffColor`

Type: [r g b] vector

Block Characteristics

| | |
|---------------------------------|----------------------------------|
| Data Types | double half integer single |
| Direct Feedthrough | no |
| Multidimensional Signals | no |
| Variable-Size Signals | no |
| Zero-Crossing Detection | no |

Extended Capabilities**C/C++ Code Generation**

Generate C and C++ code using Simulink® Coder™.

Dashboard blocks are ignored for code generation.

See Also

Rocker Switch | Slider Switch | Toggle Switch | Push Button

Topics

“Tune and Visualize Your Model with Dashboard Blocks”

“Decide How to Visualize Simulation Data”

Introduced in R2015a

PWM

Generate ideal pulse width modulated signal corresponding to input duty cycle

Library: Simulink / Discontinuities



Description

Use the PWM block to generate an ideal pulse width modulated signal.

Pulse Width Modulation (PWM) is a technique for encoding an analog signal using square pulses. This encoding is achieved by controlling the fraction of one period of the square wave that is set to high. This fraction is the duty cycle of the signal. The relationship between the modulated signal and the input duty cycle can be simply described as:

$$\bar{y} = Dy_{max} + (1 - D)y_{min}$$

where y_{max} and y_{min} are the upper and lower bounds of the duty cycle, respectively. For the PWM block, the duty cycle is constrained to [0,1]. Thus the idealized PWM signal is proportional to the duty cycle D .

Ports

Input

D – Duty Cycle

scalar

Desired duty cycle of the pulse P , specified as scalar within the range [0,1].

Data Types: double

Output

Port 1 – Output pulse

scalar

PWM signal corresponding to the input duty cycle.

Data Types: double

Parameters

Period (s) – Pulse width

1 (default) | real scalar

Time between rising edges of consecutive pulses of the output signal. A smaller value represents a higher frequency pulse.

Run at fixed time intervals – Choose continuous or discrete-time behavior

continuous (default) | discrete

Select whether the block should operate in continuous or discrete sampling modes.

By default, the block uses continuous sampling mode as it improves simulation performance with variable step solvers.

Select discrete sampling mode if you need to:

- use a fixed-step solver
- generate code
- sample the block output

Sampling rate – Set pulse resolution

0.1 (default) | scalar

Specify the rate at which the block samples input duty cycle signal. This sampling rate becomes the resolution of the output pulse signal.

Dependencies

This parameter requires that **Sampling mode** is set to discrete

Disallow zero duty cycle – Avoid algebraic loops

off | on

Enable this parameter to break algebraic loops containing the PWM block.

Note Enabling this parameter causes a signal value of 0 or below for the Duty Cycle input to throw an error.

Data Types: Boolean

Block Characteristics

| | |
|---------------------------------|--------|
| Data Types | double |
| Direct Feedthrough | no |
| Multidimensional Signals | no |
| Variable-Size Signals | no |
| Zero-Crossing Detection | no |

Algorithms

Continuous Sampling Mode

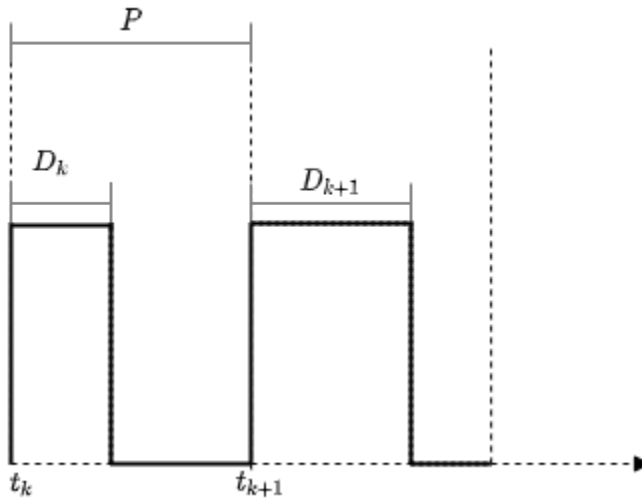

For a pulse starting at time t_k

$$y(t) = \begin{cases} 1 & t_k < t < t_k + pw \\ 0 & t_{k+1} < t < t_k + pw \end{cases}$$

where pw is the pulse width. For a given period P , pw is proportional to the duty cycle D

$$pw = D(t_k) * P(t_k)$$

Discrete Sampling Mode

In Discrete sampling mode, the input duty cycle signal is sampled at the rate specified by the **Sampling rate** parameter.

For a specified sampling rate t_s , the number of samples needed for a pulse of width pw can be expressed as follows

$$n_{pw} = \left\lceil \frac{D_k \cdot P_k}{T_S} \right\rceil \quad 0 < n_{pw} < n_P$$

$$n_P = \left\lceil \frac{P}{T_S} \right\rceil$$

where n_P is the number of samples needed to simulate a pulse of period P .

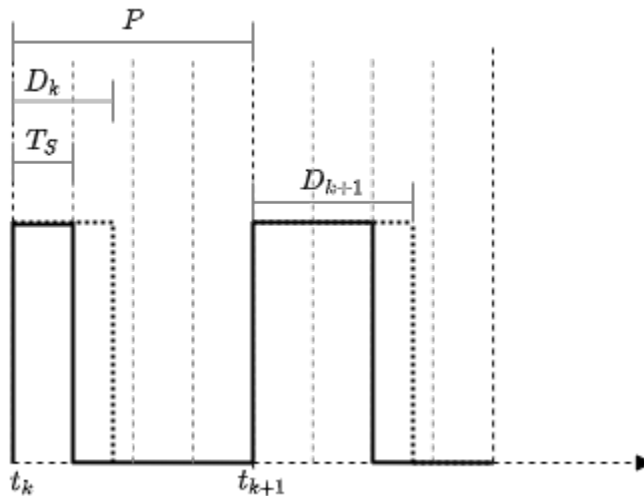

Consider a nominal pulse of period P with the sampling rate of the block set to be $t_s = 0.25 P$. The number of samples needed for one period of the pulse, $n_p = 4$. Thus, for the input duty cycle $D = 0.47$, the number of samples n_{pw} is floored to $\left\lfloor \frac{0.47P}{0.25} \right\rfloor = 1$. Therefore, the pulse is high for 1 of the 4 samples in the period.

Extended Capabilities

C/C++ Code Generation

Generate C and C++ code using Simulink® Coder™.

Not recommended for production-quality code. Relates to resource limits and restrictions on speed and memory often found in embedded systems. The code generated can contain dynamic allocation and freeing of memory, recursion, additional memory overhead, and widely-varying execution times. While the code is functionally valid and generally acceptable in resource-rich environments, smaller embedded targets often cannot support such code.

In general, consider using the Simulink Model Discretizer to map continuous blocks into discrete equivalents that support production code generation. To start the Model Discretizer, in the Simulink Editor, on the **Apps** tab, under **Apps**, under **Control Systems**, click **Model Discretizer**. One exception is the Second-Order Integrator block because, for this block, the Model Discretizer produces an approximate discretization.

See Also

Variable Pulse Generator

Introduced in R2020b

Quantizer

Discretize input at given interval

Library: Simulink / Discontinuities



Description

The Quantizer block discretizes the input signal using a quantization algorithm. The block uses a round-to-nearest method to map signal values to quantized values at the output that are defined by the **Quantization interval**. A smooth input signal can take on a stair-step shape after quantization.

This equation mathematically describes the round-to-nearest method:

$$y = q * \text{round}(u/q)$$

where y is the quantized output, u is the input, and q is the **Quantization interval**.

Ports

Input

Port_1 — Input signal to quantize

scalar | vector

Input signal to the quantization algorithm.

Data Types: single | double

Output

Port_1 — Quantized output signal

scalar | vector

Output signal composed of discrete values, quantized with a round-to-nearest approach:

$$y = q * \text{round}(u/q)$$

where y is the output, u is the input, and q is the **Quantization interval**.

Data Types: single | double

Parameters

Quantization interval — Interval that defines quantization levels for the output signal

0.5 (default) | scalar | vector

Specify the quantization interval used in the algorithm. Quantization levels for the Quantizer block output are integer multiples of the **Quantization interval**.

Programmatic Use**Block Parameter:** QuantizationInterval**Type:** character vector**Value:** Any real or complex value**Default:** '0.5'**Treat as gain when linearizing — Specify the gain value**

On (default) | boolean

The linearization commands in Simulink software treat this block as a gain in state space. Select this check box to cause the commands to treat the gain as 1. Clear the box to have the commands treat the gain as 0.

Programmatic Use**Block Parameter:** LinearizeAsGain**Type:** character vector**Value:** 'off' | 'on'**Default:** 'on'**Sample time — Specify sample time as a value other than -1**

-1 (default) | scalar | vector

Specify the sample time as a value other than -1. For more information, see “Specify Sample Time”.

Dependencies

This parameter is not visible unless it is explicitly set to a value other than -1. To learn more, see “Blocks for Which Sample Time Is Not Recommended”.

Programmatic Use**Block Parameter:** SampleTime**Type:** character vector**Values:** scalar or vector**Default:** '-1'**Block Characteristics**

| | |
|---------------------------------|-----------------|
| Data Types | double single |
| Direct Feedthrough | yes |
| Multidimensional Signals | no |
| Variable-Size Signals | no |
| Zero-Crossing Detection | no |

Extended Capabilities**C/C++ Code Generation**

Generate C and C++ code using Simulink® Coder™.

See Also

Relay | Rate Limiter

Introduced before R2006a

Quarter Gauge

Display input value on quadrant scale

Library: Simulink / Dashboard



Description

The Quarter Gauge block displays the connected signal on a quadrant scale during simulation. You can use the Quarter Gauge block with other Dashboard blocks to build an interactive dashboard of controls and indicators for your model. The Quarter Gauge block provides an indication of the instantaneous value of the connected signal throughout simulation. You can modify the range of the Quarter Gauge block to fit your data. You can also customize the appearance of the Quarter Gauge block to provide more information about your signal. For example, you can color-code in-specification and out-of-specification ranges.

Connect Dashboard Blocks

Dashboard blocks do not use ports to connect to model elements. To connect dashboard blocks to signals in your model, use connect mode. Connect mode facilitates the process of connecting dashboard blocks in your model, especially when you want to connect multiple blocks at once. To connect a single dashboard block, you can also use the **Connection** table in the block dialog box.

Tip You can modify dashboard block connections during normal and accelerator mode simulations.

To enter connect mode, select a dashboard block to connect. Then, on the block tab, click **Connect**. In connect mode, when you select one or more signals or blocks, a list of signals that are available for connection appears. Select a signal from the list to connect to the selected dashboard block. To connect another dashboard block, pause on the block you want to connect and click the **Connect** button above it. Then, select one or more signals and blocks in the model and choose a signal to connect.

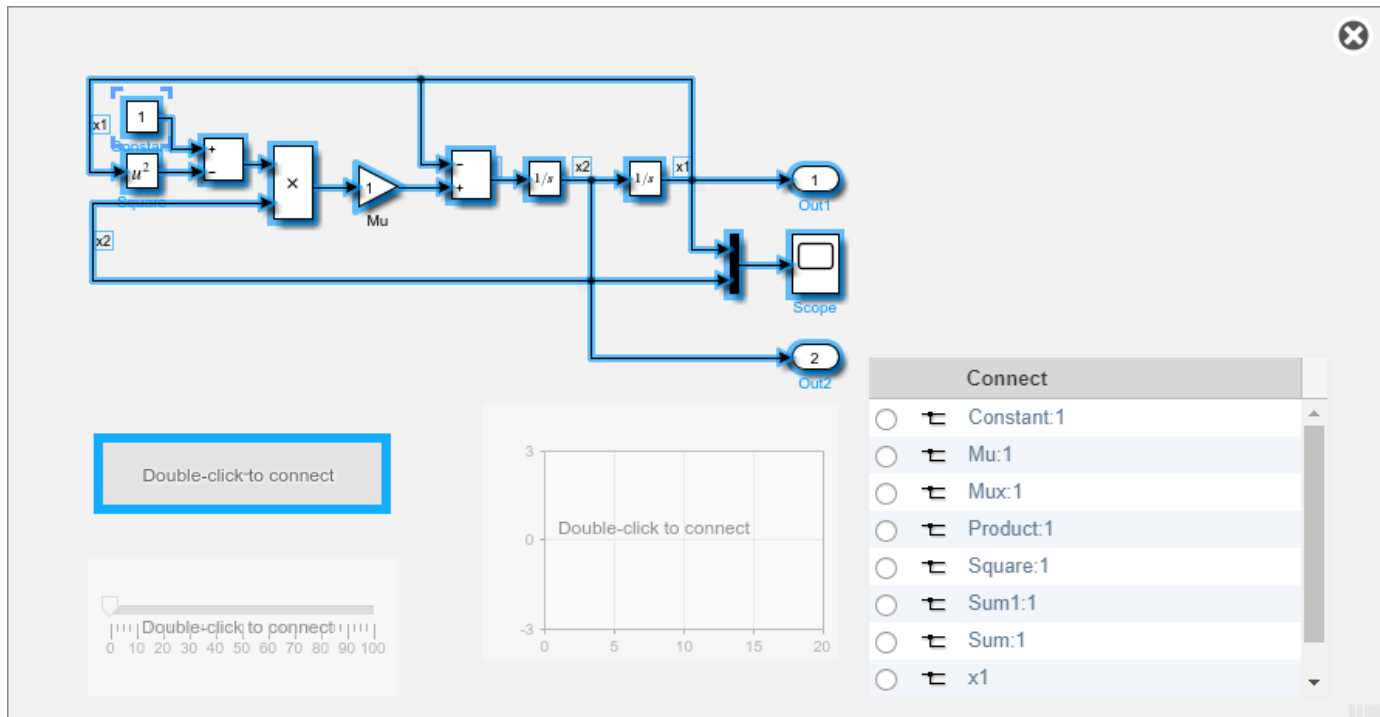

When you finish connecting the dashboard blocks in your model, on the block tab, click **Done Connecting**.

Tip You can hide the message shown on unconnected blocks using the `set_param` function with the `ShowInitialText` block parameter. The message also disappears when you connect the block.

Limitations

- Except for the Dashboard Scope block and the Display block, dashboard blocks can only connect to real scalar signals.
- The toolstrip does not support blocks that are inside a panel.
- You cannot use the **Connection** table in the block dialog to connect a dashboard block to a block that is commented out. When you connect a dashboard block to a commented block using connect mode, the dashboard block does not display the connected value until the you uncomment the block.
- Dashboard blocks cannot connect to model elements inside referenced models.
- When you simulate a model hierarchy, dashboard blocks inside referenced models do not update.
- Dashboard blocks do not support rapid accelerator simulation.
- You cannot connect a dashboard block to data or activity in Stateflow during simulation.
- Some signals do not have data available during simulation due to block reduction or optimization for accelerator mode simulations. To view such a signal using a dashboard block, mark the signal for logging.

Parameters

Signal

Connection — Signal to connect and display

signal connection options

Use the connection table to select the signal to connect to the block. To connect the block to a signal:

- 1 Make a selection in the model that includes one or more signals.
- 2 In the table, select the signal you want to connect.
- 3 Click **Apply**.

Tip You can connect dashboard blocks to signals in the model during simulation.

Programmatic Use

Block Parameter: Binding

Type: Simulink.HMI.SignalSpecification

Default: []

Main

Minimum — Minimum tick mark value

0 (default) | scalar

Finite, real, double, scalar value specifying the minimum tick mark value for the scale. The minimum must be less than the value of the **Maximum** parameter.

Programmatic Use

To programmatically set the Minimum parameter, use a 1-by-3 vector containing values for the Minimum, Tick Interval, and Maximum parameters, in that order. To use the `auto` value for the Tick Interval, leave the Tick Interval position in the vector empty or specify -1.

Block Parameter: Limits

Type: 1x3 vector

Default: [0 -1 100]

Maximum — Maximum tick mark value

100 (default) | scalar

Finite, real, double, scalar value specifying the maximum tick mark value for the scale. The maximum must be greater than the value of the **Minimum** parameter.

Programmatic Use

To programmatically set the Maximum parameter, use a 1-by-3 vector containing values for the Minimum, Tick Interval, and Maximum parameters, in that order. To use the `auto` value for the Tick Interval, leave the Tick Interval position in the vector empty or specify -1.

Block Parameter: Limits

Type: 1x3 vector

Default: [0 -1 100]

Tick Interval — Interval between major tick marks

auto (default) | scalar

Finite, real, positive, whole, scalar value specifying the interval of major tick marks on the scale. When set to `auto`, the block automatically adjusts the tick interval based on the values of the **Maximum** and **Minimum** parameters.

Programmatic Use

To programmatically set the `Tick Interval` parameter, use a 1-by-3 vector containing values for the `Minimum`, `Tick Interval`, and `Maximum` parameters, in that order. To use the `auto` value for the `Tick Interval`, leave the `Tick Interval` position in the vector empty or specify `-1`.

Block Parameter: Limits

Type: 1x3 vector

Default: [0 -1 100]

Scale Colors — Color indications on gauge scale

colors for scale ranges

Color specifications for value ranges on the scale. Press the **+** button to add a scale color. For each color added, specify the minimum and maximum values of the range in which you want to display that color.

Programmatic Use

To programmatically specify the `Scale Colors` parameter, use an array of structures with the fields:

- `Min` — Minimum value for the color range on the scale
- `Max` — Maximum value for the color range on the scale
- `Color` — 1-by-3 vector of double values between 0 and 1 that specify the color for the range in the form [r g b]

Include a structure in the array for each scale range for which you want to specify a color.

```
range1.Min = 0;
range1.Max = 10;
range1.Color = [0 0 1];
range2.Min = 10;
range2.Max = 15;
range2.Color = [0 1 0];
scaleRanges = [range1 range2];
```

Block Parameter: ScaleColors

Type: structure array

Default: 0x1 struct array

Label — Block label position

Top (default) | Bottom | Hide

Position of the block label. When the block is connected to an element in the model, the label is the name of the connected element.

Programmatic Use

Block Parameter: LabelPosition

Type: character vector

Values: 'Top' | 'Bottom' | 'Hide'

Default: 'Top'

Scale Direction — Gauge scale direction

Clockwise (default) | Counterclockwise

Gauge scale direction.

Programmatic Use

Block Parameter: ScaleDirection

Type: character vector

Values: 'Clockwise' | 'Counterclockwise'

Default: 'Clockwise'

Format**Opacity — Block background opacity**

1 (default) | scalar

Block background opacity, specified as a scalar value between 0 and 1.

Example: 0.5

Programmatic Use

Block Parameter: Opacity

Type: scalar

Default: 1

Foreground Color — Block foreground color

[r g b] vector

Block foreground color, excluding the text. The **Foreground Color** applies to the scale and the block name. You can select a color from a palette of standard colors or specify a custom color. To specify the color for the block text, use the **Font Color**.

Programmatic Use

Specify the `ForegroundColor` parameter for the block as a 1-by-3 [r g b] vector with values between 0 and 1.

Block Parameter: ForegroundColor

Type: [r g b] vector

Background Color — Block background color

[r g b] vector

Block background color. You can select a color from a palette of standard colors or specify a custom color.

Programmatic Use

Specify the `BackgroundColor` parameter for the block as a 1-by-3 [r g b] vector with values between 0 and 1.

Block Parameter: BackgroundColor

Type: [r g b] vector

Font Color — Block font color

[r g b] vector

Block font color. The **Font Color** applies to the tick labels on the scale. You can select a color from a palette of standard colors or specify a custom color.

Programmatic Use

Specify the `FontColor` parameter for the block as a 1-by-3 [r g b] vector with values between 0 and 1.

Block Parameter: `FontColor`

Type: [r g b] vector

Block Characteristics

| | |
|---------------------------------|---|
| Data Types | Boolean double enumerated fixed point half integer single |
| Direct Feedthrough | no |
| Multidimensional Signals | no |
| Variable-Size Signals | no |
| Zero-Crossing Detection | no |

Extended Capabilities**C/C++ Code Generation**

Generate C and C++ code using Simulink® Coder™.

Dashboard blocks are ignored for code generation.

See Also

Gauge | Half Gauge | Linear Gauge | Circular Gauge

Topics

“Tune and Visualize Your Model with Dashboard Blocks”

“Decide How to Visualize Simulation Data”

Introduced in R2015a

Queue, Entity Queue

Enqueue messages and entities

Library: Simulink / Messages & Events
SimEvents



Description

This block stores entities or messages in a queue, based on the order of arrival or priority. Each element at the head of the queue departs when the downstream block is ready to accept it. The Queue block and the Entity Queue block are the same blocks with different default values for the **Overwrite the oldest element if queue is full** check box.

You can specify the capacity of the queue, and the policy when the queue is full. The block supports three different message or queue sorting policies, first-in-first out (FIFO), last-in-first out (LIFO), and priority. The priority queue can be used only when the **Overwrite the oldest element if queue is full** check box is cleared.

Ports

Input

Port_1 — Input entity or message

scalar | vector | matrix

Input entity or message that carries scalar, bus, or vector data to enter the queue.

Data Types: single | double | int8 | int16 | int32 | int64 | uint8 | uint16 | uint32 | uint64 | Boolean | enumerated | bus | fixed point

Output

Port_1 — Output entity or message

scalar | vector | matrix

Output port that allows entities or messages at the head of the queue to depart when a downstream block is ready to accept them.

Data Types: single | double | int8 | int16 | int32 | int64 | uint8 | uint16 | uint32 | uint64 | Boolean | enumerated | bus | fixed point

Port_d — Number of entities that have departed the block

scalar

Number of entities that have departed the block.

Dependencies

To enable this port, select **Overwrite the oldest element if queue is full** check box, and click the **Statistics** tab and select the box labeled **Number of entities departed, d**.

Data Types: double

Port_n – Number of entities that have not yet departed the block

scalar

Number of entities that have not yet departed the block.

Dependencies

To enable this port, select **Overwrite the oldest element if queue is full** check box, and click the **Statistics** tab and select the box labeled **Number of entities in block, n**.

Data Types: double

Port_w – Average wait time for entities in the block

scalar

Average wait time for entities in the block.

Dependencies

To enable this port, select **Overwrite the oldest element if queue is full** check box, and click the **Statistics** tab and select the box labeled **Average wait, w**.

Data Types: double

Port_l – Average length of the entity queue

scalar

Port_l outputs the average length of the entity queue.

Dependencies

To enable this port, select **Overwrite the oldest element if queue is full** check box, and click the **Statistics** tab and select the box labeled **Average queue length, l**.

Data Types: double

Port_ex – Number of entities extracted

scalar

Number of entities that are pulled out of this block.

Dependencies

To enable this port, select **Overwrite the oldest element if queue is full** check box, and click the **Statistics** tab and select the box labeled **Number of entities extracted, ex**.

Data Types: double

Parameters

Overwrite the oldest element if queue is full – Specify queue overwriting policy

on (default for Simulink) | off (default for SimEvents)

Select this check box to choose between two queue overwriting policies.

- If you select the check box, an incoming message overwrites the oldest if the queue is full.

This mode represents a simple message buffer that you can use to generate asynchronous communication between Simulink components and production code.

- If you clear the check box, the block does not accept new messages if the queue is full.

In this mode, you can manipulate entity data using event actions and visualize statistics.

To customize actions when entities or messages enter, exit, or are blocked, enter MATLAB code in the **Entry action**, **Exit action**, or **Blocked action** field of the **Event actions** tab. For more information, see “Events and Event Actions” (SimEvents).

For an example, see “Manage Entities Using Event Actions” (SimEvents).

Programmatic Use**Block Parameter:** QueueOverwriting**Type:** character vector**Values:** 'on' | 'off'**Default:** 'on' (for Simulink) and 'off' (for SimEvents)**Capacity — Specify the capacity of the queue**

25 (default) | scalar

Specify the capacity of the queue.

Programmatic Use**Block Parameter:** Capacity**Type:** character vector**Values:** '25' | scalar**Default:** '25'**Queue type — Choose the queue type**

FIFO (default) | LIFO | Priority

Choose the queue type.

- FIFO — first-in-first-out
- LIFO — last-in-first-out
- Priority — store elements in order of priority, see “Serve High-Priority Customers by Sorting Entities Based on Priority” (SimEvents). Priority can be selected when you clear the **Overwrite the oldest element if queue is full** check box.

Note Priority queue does not support fixed point data type.

Programmatic Use**Block Parameter:** QueueType**Type:** character vector**Values:** 'FIFO' | 'LIFO' | 'Priority'**Default:** 'FIFO'**Multicast tag — Specify the tag when accepting entities broadcast via multicast sources**

A (default) | character vector

Specify the tag when accepting entities broadcast via multicast sources. The Entity Multicast block requires SimEvents license.

Dependencies

This parameter is visible when you clear the **Overwrite the oldest element if queue is full** check box, and set **Entity arrival source** to Multicast.

Programmatic Use

Block Parameter: MulticastTag

Type: character vector

Values: 'A' | character vector

Default: 'A'

Priority source — Specify which attribute of the entity determines its priority

PriorityAttribute (default) | character vector

Specify which attribute of the entity determines its priority.

Dependencies

This parameter is visible when you clear the **Overwrite the oldest element if queue is full** check box, and set **Queue type** to Priority.

Programmatic Use

Block Parameter: PrioritySource

Type: character vector

Values: 'PriorityAttribute' | character vector

Default: 'PriorityAttribute'

Sorting direction — Choose the direction of sorting based on priority

Ascending (default) | Descending

Choose the direction of sorting based on priority.

- Ascending — Elements with smaller priority values appear in front of the queue.
- Descending — Elements with greater priority values appear in front of the queue.

Dependencies

This parameter is visible when you clear the **Overwrite the oldest element if queue is full** check box, and set **Queue type** to Priority.

Programmatic Use

Block Parameter: SortingDirection

Type: character vector

Values: 'Ascending' | 'Descending'

Default: 'Ascending'

Entity arrival source — Choose the source of arrival for the entities

Input port (default) | Multicast

Choose the source of arrival for the entities.

- Input port — Input port is source of messages or entities.
- Multicast — Entity Multicast block is source of entities. The Entity Multicast block requires SimEvents license.

Dependencies

This parameter is visible when you clear the **Overwrite the oldest element if queue is full** check box, and set **Queue type** to Priority.

Programmatic Use

Block Parameter: EntityArrivalSource

Type: character vector

Values: 'Input port' | 'Multicast'

Default: 'Input port'

Event action — Specify the behavior of the entity in certain events

Entry (default) | Exit | Blocked

Specify the behavior of the entity in certain events. Define the behavior in the **Event action** parameter. The **Entry** and the **Exit** actions are called just after the entity entry and just before entity exit. The **Blocked** action is called after an entity is blocked. For more information, see “Events and Event Actions” (SimEvents).

Note If an event action changes an entity, related block behavior such as resorting a priority queue, and rescheduling of any events, will occur after the event action has fully finished and returned.

Note Event actions do not support fixed point data type.

Dependencies

Event actions are visible when you clear the **Overwrite the oldest element if queue is full** check box.

Programmatic Use

Block Parameter: EntryAction, ExitAction, BlockedAction

Type: character vector

Values: MATLAB code

Default: ''

Number of entities departed, d — Outputs the number of entities that have departed the block

off (default) | on

Number of entities that have departed the block.

Dependencies

Number of entities departed, d is visible when you clear the **Overwrite the oldest element if queue is full** check box.

Programmatic Use

Block Parameter: NumberEntitiesDeparted

Type: character vector

Values: 'on' | 'off'

Default: 'off'

Number of entities in block, n – Outputs the number of entities present in the block, that are yet to depart

off (default) | on

Number of entities present in the block, but which are yet to depart.

Dependencies

Number of entities in block, n is visible when you clear the **Overwrite the oldest element if queue is full** check box.

Programmatic Use

Block Parameter: NumberEntitiesInBlock

Type: character vector

Values: 'on' | 'off'

Default: 'off'

Average wait, w – Outputs the average wait time

off (default) | on

Sum of the wait times for entities departing the block divided by their total number. Wait time is the duration between the Entity Queue block entry and exit of an entity. For more information, see “Interpret SimEvents Models Using Statistical Analysis” (SimEvents).

Dependencies

Average wait, w is visible when you clear the **Overwrite the oldest element if queue is full** check box.

Programmatic Use

Block Parameter: AverageWait

Type: character vector

Values: 'on' | 'off'

Default: 'off'

Average queue length, l – Outputs the average length of the entity queue

off (default) | on

Accumulated time-weighted average queue size. The block computes this value by:

- 1 Multiplying the size of the queue by its duration to calculate time-weighted queue size
- 2 Summing up all time-weighted queue sizes and averaging them over total time

For more information, see “Interpret SimEvents Models Using Statistical Analysis” (SimEvents).

Dependencies

Average queue length, l is visible when you clear the **Overwrite the oldest element if queue is full** check box.

Programmatic Use

Block Parameter: AverageQueueLength

Type: character vector

Values: 'on' | 'off'

Default: 'off'

Number of entities extracted, ex — Number of entities extracted from this block
off (default) | on

Outputs the number of extracted entities which are pulled out from this block by the Entity Find block. The Entity Find block requires a SimEvents license. If the extracted entity is the first entity in the queue, the next entity is set as the pending entity to leave the block. If an entity attribute defines the priority in a priority queue and it is modified by the Entity Find block, the queue is sorted again. When an entity is extracted, **Number of entities departed, d**, **Number of entities in block, n**, **Average wait, w**, and **Average queue length, l** statistics are updated accordingly. For more information about finding and extracting entities, see “Find and Extract Entities in SimEvents Models” (SimEvents).

Dependencies

Number of entities extracted, ex is visible when you clear the **Overwrite the oldest element if queue is full** check box.

Programmatic Use

Block Parameter: NumEntitiesExtracted

Type: character vector

Values: 'on' | 'off'

Default: 'off'

Block Characteristics

| | |
|---------------------------------|---|
| Data Types | Boolean bus double enumerated fixed point integer single string |
| Direct Feedthrough | no |
| Multidimensional Signals | yes |
| Variable-Size Signals | no |
| Zero-Crossing Detection | no |

Extended Capabilities

C/C++ Code Generation

Generate C and C++ code using Simulink® Coder™.

Code generation is not supported for event actions and statistics.

See Also

Send | Receive

Topics

“Overview of Queues and Servers in Discrete-Event Simulation” (SimEvents)

Introduced in R2016a

Radio Button

Select parameter value

Library: Simulink / Dashboard



Description

The Radio Button block lets you change the value of the connected parameter during simulation. You can specify a list of values and labels and then select the value for the parameter from that list. Use the Radio Button block with other Dashboard blocks to build an interactive dashboard of controls and indicators for your model.

Double-clicking the Radio Button block does not open its dialog box during simulation and when the block is selected. To edit the block's parameters, you can use the **Property Inspector**, or you can right-click the block and select **Block Parameters** from the context menu.

Connect Dashboard Blocks

Dashboard blocks do not use ports to connect to model elements. To connect dashboard blocks to variables and block parameters, use connect mode. Connect mode facilitates the process of connecting dashboard blocks in your model, especially when you want to connect multiple blocks at once. To connect a single dashboard block, you can also use the **Connection** table in the block dialog box.

Tip You can modify dashboard block connections in your model during normal and accelerator mode simulations.

Note Dashboard blocks cannot connect to variables until you update the model diagram. To connect dashboard blocks to variables or modify variable values between opening your model and running a simulation, update the model diagram using **Ctrl+D**.

To enter connect mode, select the block. Then, on the block tab, click **Connect**. In connect mode, when you select one or more blocks, a list of parameters and variables available for connection appears. Select a variable or parameter from the list to connect to the selected dashboard block.

When the value of the selected variable or block parameter is nonscalar, use the text box at the bottom of the **Connection** table to specify the element you want to connect to the dashboard block. To connect to an element of a vector, matrix, or array, specify the element index, for example, 3 or (1, 3). To connect to an element in a bus or structure, specify the element in the context of the bus or structure hierarchy by using dots to indicate different levels in the hierarchy, and omit the top level. For example, specify a.b to connect to scalar element b of the structure or bus a nested inside the selected composite variable or parameter.

To connect another dashboard block, pause on another dashboard block and click the **Connect** button above it. Then, make a selection of signals and blocks in your model and choose a model element to connect.

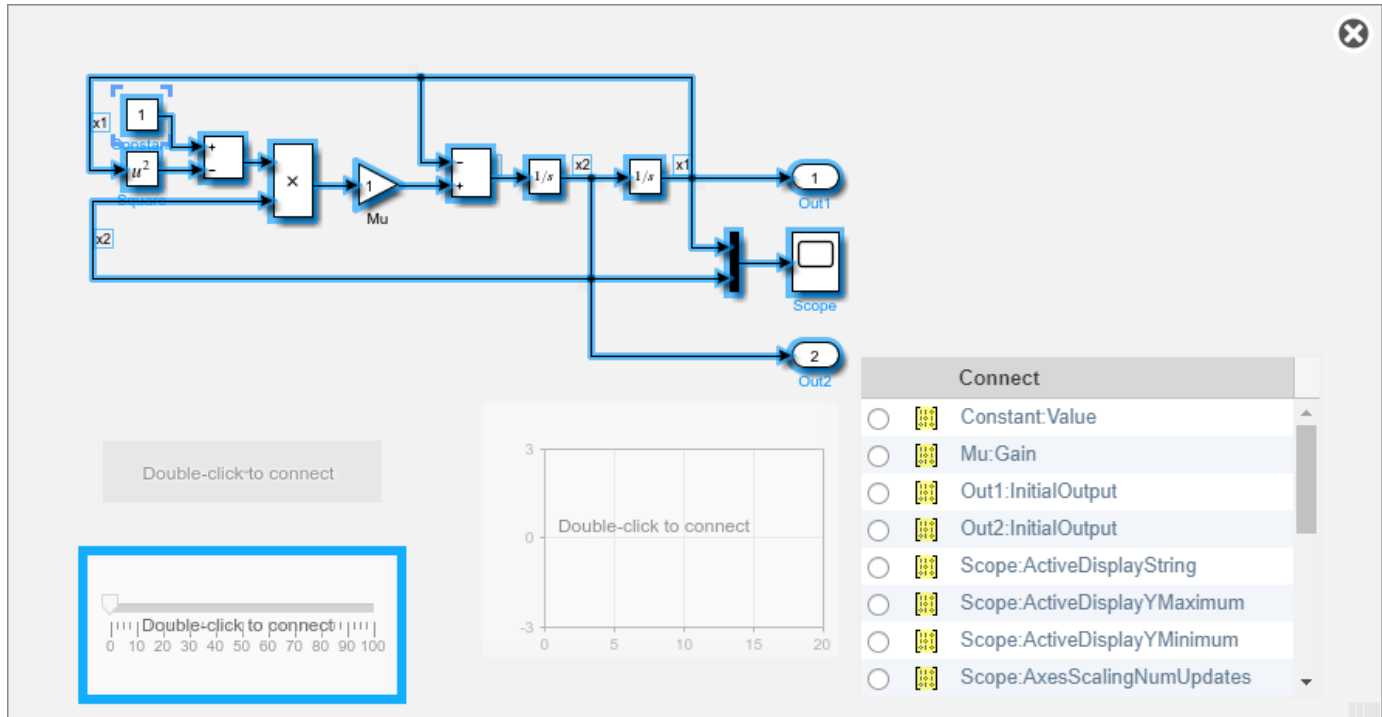

When you finish connecting the dashboard blocks in your model, on the block tab, click **Done Connecting**.

Tip You can hide the message shown on unconnected blocks using the `set_param` function with the `ShowInitialText` block parameter. The message also disappears when you connect the block.

Parameter Logging

Tunable parameters connected to dashboard blocks are logged to the Simulation Data Inspector, where you can view the parameter values along with logged signal data. You can access logged parameter data in the MATLAB workspace by exporting the parameter data from the Simulation Data Inspector by using the UI or the `Simulink.sdi.exportRun` function. For more information about exporting data using the Simulation Data Inspector UI, see “Export Data to the Workspace or a File”. The parameter data is stored in a `Simulink.SimulationData.Parameter` object, accessible as an element in the exported `Simulink.SimulationData.Dataset`.

Limitations

- Except for the Dashboard Scope block and the Display block, dashboard blocks can only connect to real scalar signals.
- The toolstrip does not support blocks that are inside a panel.
- You cannot use the **Connection** table in the block dialog to connect a dashboard block to a block that is commented out. When you connect a dashboard block to a commented block using connect

mode, the dashboard block does not display the connected value until the you uncomment the block.

- Dashboard blocks cannot connect to model elements inside referenced models.
- When you simulate a model hierarchy, dashboard blocks inside referenced models do not update.
- Dashboard blocks do not support rapid accelerator simulation.
- When you connect a dashboard block to a variable or parameter during simulation, the data for that variable or parameter is not logged to the Simulation Data Inspector. To log variable and parameter data to the Simulation Data Inspector, connect the dashboard block to the variable or parameter prior to simulation.
- When you simulate a model in external mode with the **Default parameter behavior** set to **Inlined**, dashboard blocks can appear to change parameter and variable values. However, the change does not propagate to the simulation. For example, Gain blocks display changes made to the **Gain** parameter using the dashboard blocks, but the **Gain** value used in the simulation does not change.

Parameters

Connection — Select a variable or block parameter to connect

variable and parameter connection options

Select the variable or block parameter to control using the **Connection** table. To connect the block to a signal:

- 1 Make a selection in the model that includes one or more blocks.
- 2 Select the variable or parameter you want to connect.

When the value of the selected variable or block parameter is nonscalar, use the text box at the bottom of the **Connection** table to specify the element you want to connect to the dashboard block. To connect to an element of a vector, matrix, or array, specify the element index, for example, 3 or (1, 3). To connect to an element in a bus or structure, specify the element in the context of the bus or structure hierarchy by using dots to indicate different levels in the hierarchy, and omit the top level. For example, specify a.b to connect to scalar element b of the structure or bus a nested inside the selected composite variable or parameter.

- 3 Click **Apply**.

To facilitate understanding and debugging your model, you can connect Dashboard blocks to variables and parameters in your model during simulation.

Note To see workspace variables in the connection table, update the model diagram using **Ctrl+D**.

Programmatic Use

To programmatically connect a dashboard block to a tunable parameter or a variable, use a `Simulink.HMI.ParamSourceInfo` object. The `Simulink.HMI.ParamSourceInfo` object contains four properties. Some of the properties apply to connecting dashboard blocks to parameters, and some apply to connecting dashboard blocks to variables. Not all fields have a value for a connection because a given dashboard block connects to either a parameter or a variable.

Block Parameter: Binding

Type: Simulink.HMI.ParamSourceInfo

Default: []

States — Set of states to select for connected parameter

scalar and character vector

Set of states from which to select a value for the connected parameter. Each **State** consists of a **State Value** and a **State Label**.

- **State Value** — Value assigned to the connected variable or parameter when you select the state with the corresponding **Label**.
- **State Label** — Label for each state. You can use the **Label** to display the value the connected parameter takes when the switch is positioned at the bottom, or you can enter a descriptive text label.

Click the + button to add additional **States**.

The default configuration for the block includes these **States**.

States

| State Value | State Label |
|-------------|-------------|
| 0 | Label1 |
| 1 | Label2 |
| 2 | Label3 |

Programmatic Use

To programmatically configure the **States** for a block, use an array of structures containing the fields **Value** and **Label**. Include a structure in the array for each state you want to configure on the block.

```
state1.Value = 1;
state1.Label = 'State 1';
state2.Value = 2;
state2.Label = 'State 2';
radioStates = [state1 state2];
```

Block Parameter: States

Type: structure

Default: 3x1 structure array

Enumerated Data Type — Specify state values and labels using an enumerated data type

off (default) | on

You can use an enumerated data type that pairs a numeric value with each enumeration to configure the state values and labels for the block. To specify the states for the block using an enumerated data type, first select the **Enumerated Data Type** option. Then, specify the name of the enumerated data type in the text box. The definition for the specified enumerated data type must be saved on the MATLAB path or in the base workspace.

Example: myEnumType

Programmatic Use

To programmatically specify the state labels and values for the block using an enumerated data type, specify 'on' for the `UseEnumeratedDataType` parameter and the name of the enumerated data type for the `EnumeratedDataType` parameter.

Block Parameter: `UseEnumeratedDataType`

Type: string or character array

Values: 'on' | 'off'

Default: 'off'

Block Parameter: `EnumeratedDataType`

Type: string or character array

Default: ''

Group Name — Radio Button group name

`RadioButtonGroup` (default) | character vector

Name for the group of values displayed on the Radio Button block. Unlike the **Block Name** and **Label**, the **Group Name** always shows on the Radio Button block.

Example: `Input Amplitude`

Programmatic Use

Block Parameter: `ButtonGroupName`

Type: string or character array

Default: 'Group'

Label — Block label position

`Top` (default) | `Bottom` | `Hide`

Position of the block label. When the block is connected to an element in the model, the label is the name of the connected element.

Programmatic Use

Block Parameter: `LabelPosition`

Type: character vector

Values: 'Top' | 'Bottom' | 'Hide'

Default: 'Top'

Opacity — Block background opacity

1 (default) | scalar

Block background opacity, specified as a scalar value between 0 and 1.

Example: `0.5`

Programmatic Use

Block Parameter: `Opacity`

Type: scalar

Default: 1

Foreground Color — Block foreground color

[r g b] vector

Block foreground color, including the text. You can select a color from a palette of standard colors or specify a custom color.

Programmatic Use

Specify the `ForegroundColor` parameter for the block as a 1-by-3 `[r g b]` vector with values between 0 and 1.

Block Parameter: `ForegroundColor`

Type: `[r g b]` vector

Background Color — Block background color

`[r g b]` vector

Block background color. You can select a color from a palette of standard colors or specify a custom color.

Programmatic Use

Specify the `BackgroundColor` parameter for the block as a 1-by-3 `[r g b]` vector with values between 0 and 1.

Block Parameter: `BackgroundColor`

Type: `[r g b]` vector

Block Characteristics

| | |
|---------------------------------|----------------------------------|
| Data Types | double half integer single |
| Direct Feedthrough | no |
| Multidimensional Signals | no |
| Variable-Size Signals | no |
| Zero-Crossing Detection | no |

Extended Capabilities**C/C++ Code Generation**

Generate C and C++ code using Simulink® Coder™.

Dashboard blocks are ignored for code generation.

See Also

Combo Box | Rotary Switch | Check Box

Topics

“Tune and Visualize Your Model with Dashboard Blocks”

“Decide How to Visualize Simulation Data”

Introduced in R2017b

Ramp

Generate constantly increasing or decreasing signal

Library: Simulink / Sources



Description

The Ramp block generates a signal that starts at a specified time and value and changes by a specified rate. The block's **Slope**, **Start time**, and **Initial output** parameters determine the characteristics of the output signal. All must have the same dimensions after scalar expansion.

Ports

Output

Port_1 — Output signal

scalar | vector | matrix

Generated output ramp signal characterized by the **Slope**, **Start time**, and **Initial output** parameters.

Data Types: double

Parameters

Slope — Slope of signal

1 (default) | scalar | vector | matrix

Specify the rate of change of the generated signal.

Programmatic Use

Block Parameter: slope

Type: character vector

Values: scalar

Default: '1'

Start time — Time output begins

0 (default) | scalar

Specify the time at which the block begins generating the signal.

Programmatic Use

Block Parameter: start

Type: character vector

Values: scalar

Default: '0'

Initial output — Initial value of output signal

0 (default) | scalar | vector | matrix

Specify the initial value of the output signal.

Programmatic Use**Block Parameter:** InitialOutput**Type:** character vector**Values:** scalar**Default:** '0'**Interpret vector parameters as 1-D — Treat vectors as 1-D**

on (default) | off

Select this check box to output a vector of length N if the **Constant value** parameter evaluates to an N-element row or column vector.

- When you select this check box, the block outputs a vector of length N if the **Constant value** parameter evaluates to an N-element row or column vector. For example, the block outputs a matrix of dimension 1-by-N or N-by-1.
- When you clear this check box, the block does not output a vector of length N if the **Constant value** parameter evaluates to an N-element row or column vector.

Programmatic Use**Block Parameter:** VectorParams1D**Type:** character vector**Values:** 'on' | 'off'**Default:** 'on'**Block Characteristics**

| | |
|---------------------------------|--------|
| Data Types | double |
| Direct Feedthrough | no |
| Multidimensional Signals | no |
| Variable-Size Signals | no |
| Zero-Crossing Detection | no |

Extended Capabilities**C/C++ Code Generation**

Generate C and C++ code using Simulink® Coder™.

Not recommended for production code.

See Also

Repeating Sequence | Pulse Generator

Introduced before R2006a

Random Number

Generate normally distributed random numbers

Library: Simulink / Sources

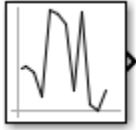

Description

The Random Number block generates normally distributed random numbers. To generate uniformly distributed random numbers, use the Uniform Random Number block. Both blocks use the Normal (Gaussian) random number generator ('v4': legacy MATLAB 4.0 generator of the `rng` function).

You can generate a repeatable sequence using any Random Number block with the same nonnegative seed and parameters. The seed resets to the specified value each time a simulation starts. By default, the block produces a sequence that has a mean of 0 and a variance of 1. To generate a vector of random numbers with the same mean and variance, specify the **Seed** parameter as a vector.

Avoid integrating a random signal, because solvers must integrate relatively smooth signals. Instead, use the Band-Limited White Noise block.

The numeric parameters of this block must have the same dimensions after scalar expansion. If you select the **Interpret vector parameters as 1-D** check box, and the numeric parameters are row or column vectors after scalar expansion, the block outputs a 1-D signal. If you clear the **Interpret vector parameters as 1-D** check box, the block outputs a signal of the same dimensionality as the parameters.

Ports

Output

Port_1 — Output signal

scalar | vector | matrix

Output signal that is the generated random numbers falling within a normal Gaussian distribution. The output is repeatable for a given seed.

Data Types: `double`

Parameters

Mean — Mean of random numbers

0 (default) | scalar

Specify the mean of the random numbers generated.

Programmatic Use

Block Parameter: Mean

Type: character vector

Values: scalar

Default: '0'

Variance — Variance of random numbers

1 (default) | scalar

Specify the variance of the random numbers.

Programmatic Use

Block Parameter: Variance

Type: character vector

Values: scalar

Default: '1'

Seed — Starting seed

0 (default) | positive integer

Specify the starting seed for the random number generator.

The output of number generated is repeatable for a given seed.

Programmatic Use

Block Parameter: Seed

Type: character vector

Values: scalar

Default: '0'

Sample time — Time between intervals

0.1 (default) | integer

Specify the time interval between samples. The default is 0.1, which matches the default sample time of the Band-Limited White Noise block. See “Specify Sample Time” for more information.

Programmatic Use

Block Parameter: SampleTime

Type: character vector

Values: scalar

Default: '0.1'

Interpret vector parameters as 1-D — Treat vectors as 1-D

on (default) | off

Select this check box to output a vector of length N if the **Constant value** parameter evaluates to an N-element row or column vector.

- When you select this check box, the block outputs a vector of length N if the **Constant value** parameter evaluates to an N-element row or column vector. For example, the block outputs a matrix of dimension 1-by-N or N-by-1.
- When you clear this check box, the block does not output a vector of length N if the **Constant value** parameter evaluates to an N-element row or column vector.

Programmatic Use

Block Parameter: VectorParams1D

Type: character vector

Values: 'on' | 'off'
Default: 'on'

Block Characteristics

| | |
|---------------------------------|--------|
| Data Types | double |
| Direct Feedthrough | no |
| Multidimensional Signals | yes |
| Variable-Size Signals | no |
| Zero-Crossing Detection | no |

Extended Capabilities

C/C++ Code Generation

Generate C and C++ code using Simulink® Coder™.

See Also

Uniform Random Number | Band-Limited White Noise | rng

Introduced before R2006a

Rate Limiter

Limit rate of change of signal

Library: Simulink / Discontinuities



Description

The Rate Limiter block limits the first derivative of the signal passing through it. The output changes no faster than the specified limit. The derivative is calculated using this equation:

$$rate = \frac{u(i) - y(i-1)}{t(i) - t(i-1)}$$

where $u(i)$ and $t(i)$ are the current block input and time, and $y(i-1)$ and $t(i-1)$ are the output and time at the previous step. The output is determined by comparing $rate$ to the **Rising slew rate** and **Falling slew rate** parameters:

- If $rate$ is greater than the **Rising slew rate** parameter (R), the output is calculated as

$$y(i) = \Delta t \cdot R + y(i-1).$$

- If $rate$ is less than the **Falling slew rate** parameter (F), the output is calculated as

$$y(i) = \Delta t \cdot F + y(i-1).$$

- If $rate$ is between the bounds of R and F , the change in output is equal to the change in input:

$$y(i) = u(i)$$

When the block is running in continuous mode (for example, **Sample time mode** is inherited and **Sample time** of the driving block is zero), the **Initial condition** is ignored. The block output at $t = 0$ is equal to the initial input:

$$y(0) = u(0)$$

When the block is running in discrete mode (for example, **Sample time mode** is inherited and **Sample time** of the driving block is nonzero), the **Initial condition** is preserved:

$$y(-1) = I_c$$

where I_c is the initial condition. The block output at $t = 0$ is calculated as if $rate$ is outside the bounds of R and F . For $t = 0$, $rate$ is calculated as follows:

$$rate = \frac{u(0) - y(-1)}{sample\ time}$$

Limitations

- You cannot use a Rate Limiter block inside a Triggered Subsystem. Use the Rate Limiter Dynamic block instead.

Ports

Input

Port_1 — Input signal

scalar

The input signal to the rate limiter algorithm.

Data Types: `single` | `double` | `int8` | `int16` | `int32` | `int64` | `uint8` | `uint16` | `uint32` | `uint64` | `fixed point`

Output

Port_1 — Output signal

scalar

Output signal from the rate limiter algorithm.

Data Types: `single` | `double` | `int8` | `int16` | `int32` | `int64` | `uint8` | `uint16` | `uint32` | `uint64` | `fixed point`

Parameters

Rising slew rate — Limit of derivative for increasing input

1 (default) | real number

Specify the limit of the rising rate of the input signal. This parameter is tunable for fixed-point inputs.

Programmatic Use

Block Parameter: `RisingSlewLimit`

Type: character vector

Values: real number

Default: '1'

Falling slew rate — Limit of derivative for decreasing input

-1 (default) | real number

Specify the lower limit on the falling rate of the input signal. This parameter is tunable for fixed-point inputs.

Programmatic Use

Block Parameter: `FallingSlewLimit`

Type: character vector

Values: real number

Default: '-1'

Sample time mode — Sample time mode

`inherited` (default) | `continuous`

Specify the sample time mode, `continuous` or `inherited` from the driving block.

Programmatic Use

Block Parameter: `SampleTimeMode`

Type: character vector

Values: 'inherited' | 'continuous' |
Default: 'inherited'

Initial condition — Initial output

0 (default) | scalar

Set the initial output of the simulation. Simulink does not allow you to set the initial condition of this block to `inf` or `NaN`.

Programmatic Use

Block Parameter: InitialCondition

Type: character vector

Values: scalar

Default: '0'

Treat as gain when linearizing — Specify the gain value

On (default) | Boolean

Select this check box to cause the commands to treat the gain as 1. The linearization commands in Simulink software treat this block as a gain in state space. Clear the box to have the commands treat the gain as 0.

Programmatic Use

Block Parameter: LinearizeAsGain

Type: character vector

Values: 'off' | 'on'

Default: 'on'

Block Characteristics

| | |
|---------------------------------|---|
| Data Types | double fixed point integer single |
| Direct Feedthrough | yes |
| Multidimensional Signals | no |
| Variable-Size Signals | no |
| Zero-Crossing Detection | no |

Extended Capabilities

C/C++ Code Generation

Generate C and C++ code using Simulink® Coder™.

Cannot be used inside a triggered subsystem hierarchy.

PLC Code Generation

Generate Structured Text code using Simulink® PLC Coder™.

Fixed-Point Conversion

Design and simulate fixed-point systems using Fixed-Point Designer™.

See Also

Rate Limiter Dynamic | Saturation

Introduced before R2006a

Rate Limiter Dynamic

Limit rate of change of signal

Library: Simulink / Discontinuities



Description

The Rate Limiter Dynamic block limits the rising and falling rates of the signal.

- The external signal `up` sets the upper limit on the rising rate of the signal.
- The external signal `lo` sets the lower limit on the falling rate of the signal.

Follow these guidelines when using the Rate Limiter Dynamic block:

- Ensure that the data types of `up` and `lo` are the same as the data type of the input signal `u`.

When the lower limit uses a signed type and the input signal uses an unsigned type, the output signal keeps increasing regardless of the input and the limits.

- Use a fixed-step solver to simulate models that contain this block.

Because the Rate Limiter Dynamic block supports only discrete sample time.

Ports

Input

u — Input signal

scalar

Input signal to the rate limiter algorithm.

Data Types: `single` | `double` | `int8` | `int16` | `int32` | `int64` | `uint8` | `uint16` | `uint32` | `uint64` | `fixed point`

lo — Limit of derivative for decreasing input

scalar

Dynamic value providing the limit of the falling rate of the input signal. Make the signal data type of `lo` the same data type of the input signal `u`.

Data Types: `single` | `double` | `int8` | `int16` | `int32` | `int64` | `uint8` | `uint16` | `uint32` | `uint64` | `fixed point`

up — Limit of derivative for increasing input

scalar

Dynamic value providing the limit of the rising rate of the input signal. Make the signal data type of `up` the same data type of the input signal `u`.

Data Types: single | double | int8 | int16 | int32 | int64 | uint8 | uint16 | uint32 | uint64 | fixed point

Output

Y — Output signal

scalar

Output signal from the rate limiter algorithm.

Data Types: single | double | int8 | int16 | int32 | int64 | uint8 | uint16 | uint32 | uint64 | fixed point | enumerated | bus

Block Characteristics

| | |
|---------------------------------|---|
| Data Types | double fixed point integer single |
| Direct Feedthrough | no |
| Multidimensional Signals | no |
| Variable-Size Signals | no |
| Zero-Crossing Detection | no |

Extended Capabilities

C/C++ Code Generation

Generate C and C++ code using Simulink® Coder™.

The code generator does not explicitly group primitive blocks that constitute a nonatomic masked subsystem block in the generated code. This flexibility allows for more efficient code generation. In certain cases, you can achieve grouping by configuring the masked subsystem block to execute as an atomic unit by selecting the **Treat as atomic unit** option.

PLC Code Generation

Generate Structured Text code using Simulink® PLC Coder™.

Fixed-Point Conversion

Design and simulate fixed-point systems using Fixed-Point Designer™.

See Also

Rate Limiter

Introduced before R2006a

Rate Transition

Handle transfer of data between blocks operating at different rates

Library: Simulink / Signal Attributes
HDL Coder / Signal Attributes

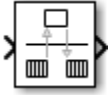

Description

The Rate Transition block transfers data from the output of a block operating at one rate to the input of a block operating at a different rate. Use the block parameters to trade data integrity and deterministic transfer for faster response or lower memory requirements. To learn about data integrity and deterministic data transfer, see “Data Transfer Problems” (Simulink Coder).

Transition Handling Options

| Transition Handling Options | Block Parameter Settings |
|--|--|
| <ul style="list-style-type: none"> Data integrity Deterministic data transfer Maximum latency | Select: <ul style="list-style-type: none"> Ensure data integrity during data transfer Ensure deterministic data transfer |
| <ul style="list-style-type: none"> Data integrity Nondeterministic data transfer Minimum latency Higher memory requirements | Select: <ul style="list-style-type: none"> Ensure data integrity during data transfer Clear: <ul style="list-style-type: none"> Ensure deterministic data transfer |
| <ul style="list-style-type: none"> Potential loss of data integrity Nondeterministic data transfer Minimum latency Lower memory requirements | Clear: <ul style="list-style-type: none"> Ensure data integrity during data transfer Ensure deterministic data transfer |

Dependencies

The behavior of the Rate Transition block depends on:

- Sample times of the ports to which the block connects (see “Effects of Synchronous Sample Times” on page 1-1426 and “Effects of Asynchronous Sample Times” on page 1-1427)
- Priorities of the tasks for the source and destination sample times (see “Sample time properties” in the Simulink documentation)
- Whether the model specifies a fixed- or variable-step solver (see “Compare Solvers” in the Simulink documentation)

- Setting of model configuration parameters **Device vendor** and **Device type** (see “Effects of Device Configuration” on page 1-1427)

Block Labels

When you update your diagram, a label appears on the Rate Transition block to indicate simulation behavior.

| Label | Block Behavior |
|--------|---|
| ZOH | Acts as a zero-order hold |
| 1/z | Acts as a unit delay |
| Buf | Copies input to output under semaphore control |
| Db_buf | Copies input to output using double buffers |
| 3buf | Copies input to output using triple buffers |
| Copy | Unprotected copy of input to output |
| NoOp | Does nothing |
| Mixed | Expands to multiple blocks with different behaviors |
| RT | Indicates data transfer between partitions when using the Schedule Editor. For more information on using the Schedule Editor, see “Using the Schedule Editor”. |

The block behavior label shows the method that ensures safe transfer of data between tasks operating at different rates. You can use the sample-time colors feature (see “View Sample Time Information”) to display the relative rates that the block bridges. Consider, for example, the following model:

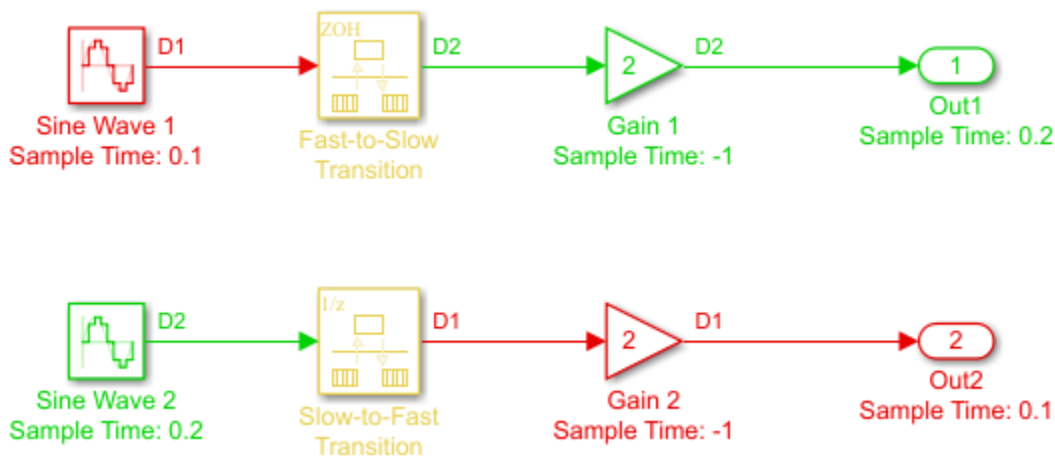

Sample-time colors and the block behavior label show:

- The Rate Transition block at the top of the diagram acts as a zero-order hold in a fast-to-slow transition.
- The Rate Transition block at the bottom of the diagram acts as a unit delay in a slow-to-fast transition.

For more information, see “Handle Rate Transitions” (Simulink Coder).

Effects of Synchronous Sample Times

The following table summarizes how each label appears when the sample times of the input and output ports (inTs and outTs) are periodic, or synchronous.

| Block Settings | | Block Label | | |
|--|--|--|--|--|
| Rate Transition | Conditions for Rate Transition Block | With Data Integrity and Determinism | With Only Data Integrity | Without Data Integrity or Determinism |
| inTs = outTs (Equal) | inTsOffset < outTsOffset | None (error) | Buf | Copy or NoOp (see note that follows the table) |
| | inTsOffset = outTsOffset | Copy or NoOp (see note that follows the table) | Copy or NoOp (see note that follows the table) | |
| | inTsOffset > outTsOffset | None (error) | Db_buf | |
| inTs < outTs (Fast to slow) | inTs = outTs / N | ZOH | Buf | |
| | inTsOffset, outTsOffset = 0 | | | |
| | inTs = outTs / N | None (error) | | |
| | inTsOffset ≤ outTsOffset | | | |
| | inTs = outTs / N inTsOffset > outTsOffset | None (error) | Db_buf | |
| inTs > outTs (Slow to fast) | inTs = outTs * N | 1/z | Db_buf | |
| | inTsOffset, outTsOffset = 0 | | | |
| | inTs = outTs * N | None (error) | | |
| | inTsOffset ≤ outTsOffset | | | |
| | inTs = outTs * N inTsOffset > outTsOffset | None (error) | | |
| | inTs ≠ outTs * N | None (error) | | |
| KEY | | | | |
| <ul style="list-style-type: none"> • inTs, outTs: Sample times of input and output ports, respectively • inTsOffset, outTsOffset: Sample time offsets of input and output ports, respectively • N: Integer value > 1 | | | | |

When you select the **Block reduction** parameter on the Configuration Parameters dialog box, Copy reduces to NoOp. No code generation occurs for a Rate Transition block with a NoOp label. To prevent a block from being reduced when block reduction is on, add a test point to the block output (see “Configure Signals as Test Points” in the Simulink documentation).

Effects of Asynchronous Sample Times

The following table summarizes how each label appears when the sample time of the input or output port (inTs or outTs) is not periodic, or asynchronous.

| Block Settings | Block Label | | |
|---|-------------------------------------|--------------------------|---------------------------------------|
| | With Data Integrity and Determinism | With Only Data Integrity | Without Data Integrity or Determinism |
| inTs = outTs | Copy | Copy | Copy |
| inTs ≠ outTs | None (error) | Db_buf | |
| KEY | | | |
| <ul style="list-style-type: none"> • inTs, outTs: Sample times of input and output ports, respectively | | | |

Effects of Device Configuration

If the settings of model configuration parameters **Device vendor** and **Device type** specify hardware that supports atomic data load and store operations, the code generator optimizes the generated rate transition code when the target hardware supports atomic load and store operations for the data type of the signal being transferred. The code generator takes advantage of the hardware data load and store capability by replacing double-buffering code between asynchronous tasks with code that performs a single memory copy.

Ports

Input

Port_1 — Input signal

scalar | vector | matrix | N-D array

Input signal to transition to a new sample rate, specified as a scalar, vector, matrix, or N-D array. To learn about the block parameters that enable you to trade data integrity and deterministic transfer for faster response or lower memory requirements, see “Transition Handling Options” on page 1-1424.

Data Types: single | double | half | int8 | int16 | int32 | int64 | uint8 | uint16 | uint32 | uint64 | Boolean | fixed point | enumerated | bus

Output

Port_1 — Output signal

scalar | vector | matrix | N-D array

Output signal is the input signal converted to the sample rate you specify. The default configuration ensures safe and deterministic data transfer. To learn about the block parameters that enable you to trade data integrity and deterministic transfer for faster response or lower memory requirements, see “Transition Handling Options” on page 1-1424.

Data Types: single | double | half | int8 | int16 | int32 | int64 | uint8 | uint16 | uint32 | uint64 | Boolean | fixed point | enumerated | bus

Parameters

Ensure data integrity during data transfer — Ensure data integrity

on (default) | off

Selecting this check box results in generated code that ensures data integrity when the block transfers data. If you select this check box and the transfer is nondeterministic (see **Ensure deterministic data transfer**), depending on the priority of input rate and output rate, the generated code uses a proper algorithm using single or multiple buffers to protect data integrity during data transfer.

Otherwise, the Rate Transition block is either reduced or generates code using a copy operation to affect the data transfer. This unprotected mode consumes less memory. But the copy operation is also interruptible, which can lead to loss of data integrity during data transfers. Select this check box if you want the generated code to operate with maximum responsiveness (that is, nondeterministically) and data integrity. For more information, see “Rate Transition Block Options” (Simulink Coder).

Programmatic Use

Block Parameter: Integrity

Type: character vector

Values: 'off' | 'on'

Default: 'on'

Ensure deterministic data transfer (maximum delay) — Ensure deterministic data transfer

on (default) | off

Selecting this check box results in generated code that transfers data at the sample rate of the slower block, that is, deterministically. If you do not select this check box, data transfers occur when new data is available from the source block and the receiving block is ready to receive the data. You avoid transfer delays, thus ensuring that the system operates with maximum responsiveness. However, transfers can occur unpredictably, which is undesirable in some applications. For more information, see “Rate Transition Block Options” (Simulink Coder).

Programmatic Use

Block Parameter: Deterministic

Type: character vector

Values: 'off' | 'on'

Default: 'on'

Initial conditions — Initial conditions

0 (default) | scalar | vector | matrix | N-D array

This parameter applies only to slow-to-fast transitions. It specifies the initial output of the Rate Transition block at the beginning of a transition, when there is no output signal due to the absence of input signal coming from the slow block connected to the input of the Rate Transition block. Simulink does not allow the initial output of this block to be Inf or NaN. The value you specify must be a scalar, or have the same dimensions as the input signal.

Programmatic Use

Block Parameter: InitialCondition

Type: character vector

Values: finite scalar

Default: '0'

Output port sample time options – Mode for specifying output port sample time

Specify (default) | Inherit | Multiple of input port sample time

Specifies a mode for setting the output port sample time. The options are:

- **Specify** — Allows you to use the **Output port sample time** parameter to specify the output rate to which the Rate Transition block converts its input rate.
- **Inherit** — Specifies that the Rate Transition block inherits an output rate from the block to which the output port is connected.
- **Multiple of input port sample time** — Allows you to use the **Sample time multiple (>0)** parameter to specify the Rate Transition block output rate as a multiple of its input rate.

If you select **Inherit** and all blocks connected to the output port also inherit sample time, the fastest sample time in the model applies.

Programmatic Use**Block Parameter:** OutPortSampleTimeOpt**Type:** character vector**Values:** 'Specify' | 'Inherit' | 'Multiple of input port sample time'**Default:** 'Specify'**Output port sample time – Output rate**

-1 (default) | scalar | vector

Enter a value that specifies the output rate to which the block converts its input rate. The default value (-1) specifies that the Rate Transition block inherits the output rate from the block to which the output port is connected. See “Specify Sample Time” for information on how to specify the output rate.

Dependencies

To enable this parameter, set **Output port sample time options** to **Specify**.

Programmatic Use**Block Parameter:** OutPortSampleTime**Type:** character vector**Values:** scalar | vector**Default:** '-1'**Sample time multiple(>0) – Sample time multiple**

1 (default) | positive scalar

Enter a positive value that specifies the output rate as a multiple of the input port sample time. The default value (1) specifies that the output rate is the same as the input rate. A value of 0.5 specifies that the output rate is half of the input rate. A value of 2 specifies that the output rate is twice the input rate.

Dependencies

To enable this parameter, set **Output port sample time options** to **Multiple of input port sample time**.

Programmatic Use**Block Parameter:** OutPortSampleTimeMultiple**Type:** character vector

Values: scalar

Default: '1'

Block Characteristics

| | |
|---------------------------------|---|
| Data Types | Boolean bus double enumerated fixed point half integer single |
| Direct Feedthrough | yes |
| Multidimensional Signals | yes |
| Variable-Size Signals | no |
| Zero-Crossing Detection | no |

Extended Capabilities

C/C++ Code Generation

Generate C and C++ code using Simulink® Coder™.

- Generated code relies on memcpy or memset functions (string.h) under certain conditions.
- Cannot use inside a triggered subsystem hierarchy.
- Generated code for concurrent programs is platform specific and assumes deployment platform and host platform are the same.

HDL Code Generation

Generate Verilog and VHDL code for FPGA and ASIC designs using HDL Coder™.

HDL Coder provides additional configuration options that affect HDL implementation and synthesized logic.

Best Practices

- When the Rate Transition block is operating at a faster input rate and slower output rate, it is good practice to follow the Rate Transition block with a unit delay. Doing so prevents the code generator from inserting an extra bypass register in the HDL code. See also “Multirate Model Requirements for HDL Code Generation” (HDL Coder).
- To upsample the input signal without incurring a unit delay, in the Block Parameters dialog box of the Rate Transition block:
 - Clear the **Ensure data integrity during data transfer** check box.

Clearing this check box makes the **Ensure deterministic data transfer (maximum delay)** check box to disappear.

- Configure the output port sample time of the block to be an integer multiple of the input port sample time. Specify a fractional value of 1/n for **Sample time multiple** where n is an integer. You can choose any value for the block parameter **Output port sample time options** as long as **Sample time multiple** uses a value 1/n.

Note When downsampling the input signal, leave the **Ensure data integrity during data transfer** and **Ensure deterministic data transfer (maximum delay)** check boxes selected. This mode generates an additional bypass register in the HDL code.

See also “Usage of Rate Change and Constant Blocks” (HDL Coder).

Restrictions

- Sample rate cannot be 0 or Inf for block input or output ports.

HDL Architecture

This block has a single, default HDL architecture.

HDL Block Properties

| | |
|----------------------------------|--|
| ConstrainedOutputPipeline | Number of registers to place at the outputs by moving existing delays within your design. Distributed pipelining does not redistribute these registers. The default is 0. For more details, see “ConstrainedOutputPipeline” (HDL Coder). |
| InputPipeline | Number of input pipeline stages to insert in the generated code. Distributed pipelining and constrained output pipelining can move these registers. The default is 0. For more details, see “InputPipeline” (HDL Coder). |
| OutputPipeline | Number of output pipeline stages to insert in the generated code. Distributed pipelining and constrained output pipelining can move these registers. The default is 0. For more details, see “OutputPipeline” (HDL Coder). |

Complex Data Support

This block supports code generation for complex signals.

Fixed-Point Conversion

Design and simulate fixed-point systems using Fixed-Point Designer™.

See Also

Probe | Weighted Sample Time

Topics

“Specify Sample Time”

“View Sample Time Information”

“Handle Rate Transitions” (Simulink Coder)

Introduced before R2006a

Real-Imag to Complex

Convert real and/or imaginary inputs to complex signal

Library: Simulink / Math Operations
HDL Coder / Math Operations



Description

The Real-Imag to Complex block converts real and/or imaginary inputs to a complex-valued output signal.

The inputs can both be arrays (vectors or matrices) of equal dimensions, or one input can be an array and the other a scalar. If the block has an array input, the output is a complex array of the same dimensions. The elements of the real input map to the real parts of the corresponding complex output elements. The imaginary input similarly maps to the imaginary parts of the complex output signals. If one input is a scalar, it maps to the corresponding component (real or imaginary) of all the complex output signals.

Ports

Input

Re — Real part of complex output

scalar | vector | matrix

Real value to be converted to complex-valued output signal, specified as a scalar, vector, or matrix.

Data Types: single | double | int8 | int16 | int32 | int64 | uint8 | uint16 | uint32 | uint64 | fixed point | bus

Im — Imaginary part of complex output

scalar | vector | matrix

Imaginary value to be converted to complex-valued output signal, specified as a scalar, vector, or matrix.

Data Types: single | double | int8 | int16 | int32 | int64 | uint8 | uint16 | uint32 | uint64 | fixed point | bus

Port_1 — Real or imaginary part of complex output

scalar | vector | matrix

Real or imaginary value to convert to complex output signal, specified as a finite scalar, vector, or matrix.

Data Types: single | double | int8 | int16 | int32 | int64 | uint8 | uint16 | uint32 | uint64 | fixed point | bus

Output

Port_1 — Complex signal

scalar | vector | matrix

Complex signal, formed from real and imaginary values.

Data Types: single | double | int8 | int16 | int32 | int64 | uint8 | uint16 | uint32 | uint64 | fixed point

Parameters

Input — Real, imaginary, or both

Real (default) | Imag | Real and imag

Specify the type of input: a real input, an imaginary input, or both.

Programmatic Use

Block Parameter: Input

Type: character vector

Values: 'Real and imag' | 'Real' | 'Imag'

Default: 'Real and imag'

Imag part — Imaginary part of complex output

0 (default) | finite scalar, vector, or matrix

Specify the imaginary value to use when converting the input to a complex-valued output signal.

Dependencies

To enable this parameter, set **Input** to Real.

Programmatic Use

Block Parameter: ConstantPart

Type: character vector

Values: imaginary value

Default: '0'

Real part — Real part of complex output

0 (default) | finite scalar, vector, or matrix

Specify the constant real value to use when converting the input to a complex-valued output signal.

Dependencies

To enable this parameter, set **Input** to Imag.

Programmatic Use

Block Parameter: ConstantPart

Type: character vector

Values: finite, real-valued scalar, vector, or matrix

Default: '0'

Sample time — Specify sample time as a value other than -1

-1 (default) | scalar | vector

Specify the sample time as a value other than -1. For more information, see “Specify Sample Time”.

Dependencies

This parameter is not visible unless it is explicitly set to a value other than -1. To learn more, see “Blocks for Which Sample Time Is Not Recommended”.

Programmatic Use

Block Parameter: SampleTime

Type: character vector

Values: scalar or vector

Default: '-1'

Block Characteristics

| | |
|---------------------------------|---|
| Data Types | double fixed point integer single |
| Direct Feedthrough | yes |
| Multidimensional Signals | yes |
| Variable-Size Signals | yes |
| Zero-Crossing Detection | no |

Extended Capabilities

C/C++ Code Generation

Generate C and C++ code using Simulink® Coder™.

HDL Code Generation

Generate Verilog and VHDL code for FPGA and ASIC designs using HDL Coder™.

HDL Coder provides additional configuration options that affect HDL implementation and synthesized logic.

HDL Architecture

This block has a single, default HDL architecture.

HDL Block Properties

| | |
|----------------------------------|--|
| ConstrainedOutputPipeline | Number of registers to place at the outputs by moving existing delays within your design. Distributed pipelining does not redistribute these registers. The default is 0. For more details, see “ConstrainedOutputPipeline” (HDL Coder). |
| InputPipeline | Number of input pipeline stages to insert in the generated code. Distributed pipelining and constrained output pipelining can move these registers. The default is 0. For more details, see “InputPipeline” (HDL Coder). |
| OutputPipeline | Number of output pipeline stages to insert in the generated code. Distributed pipelining and constrained output pipelining can move these registers. The default is 0. For more details, see “OutputPipeline” (HDL Coder). |

Complex Data Support

This block supports code generation for complex signals.

Fixed-Point Conversion

Design and simulate fixed-point systems using Fixed-Point Designer™.

See Also

[Complex to Real-Imag](#) | [Magnitude-Angle to Complex](#) | [Complex to Magnitude-Angle](#)

Topics

“Complex Signals”

Introduced before R2006a

Record, XY Graph

Log data to the workspace, to a file, or both

Library: Simulink / Sinks



Description

You can use the Record block or the XY Graph block to record data to the workspace, to a file, or to both the workspace and a file. When you log data to a file, you can choose to log to a MAT file, an MLDATX file, or an Excel file. Signals connected to a Record block always log to the Simulation Data Inspector. If you decide that you need to save data after simulation, you can export data from the Record block to the workspace or to any supported file type.

You can also use the Record block to visualize connected signals. To view data for signals connected to the Record block, double-click the block. You have access to simulation controls, such as the **Run** button, while viewing data in the Record block.

By default, the Record block displays all connected signals as sparklines. A sparkline is added for each connected signal. After sparklines fill the visible space, a scrollbar allows you to continue plotting signals.

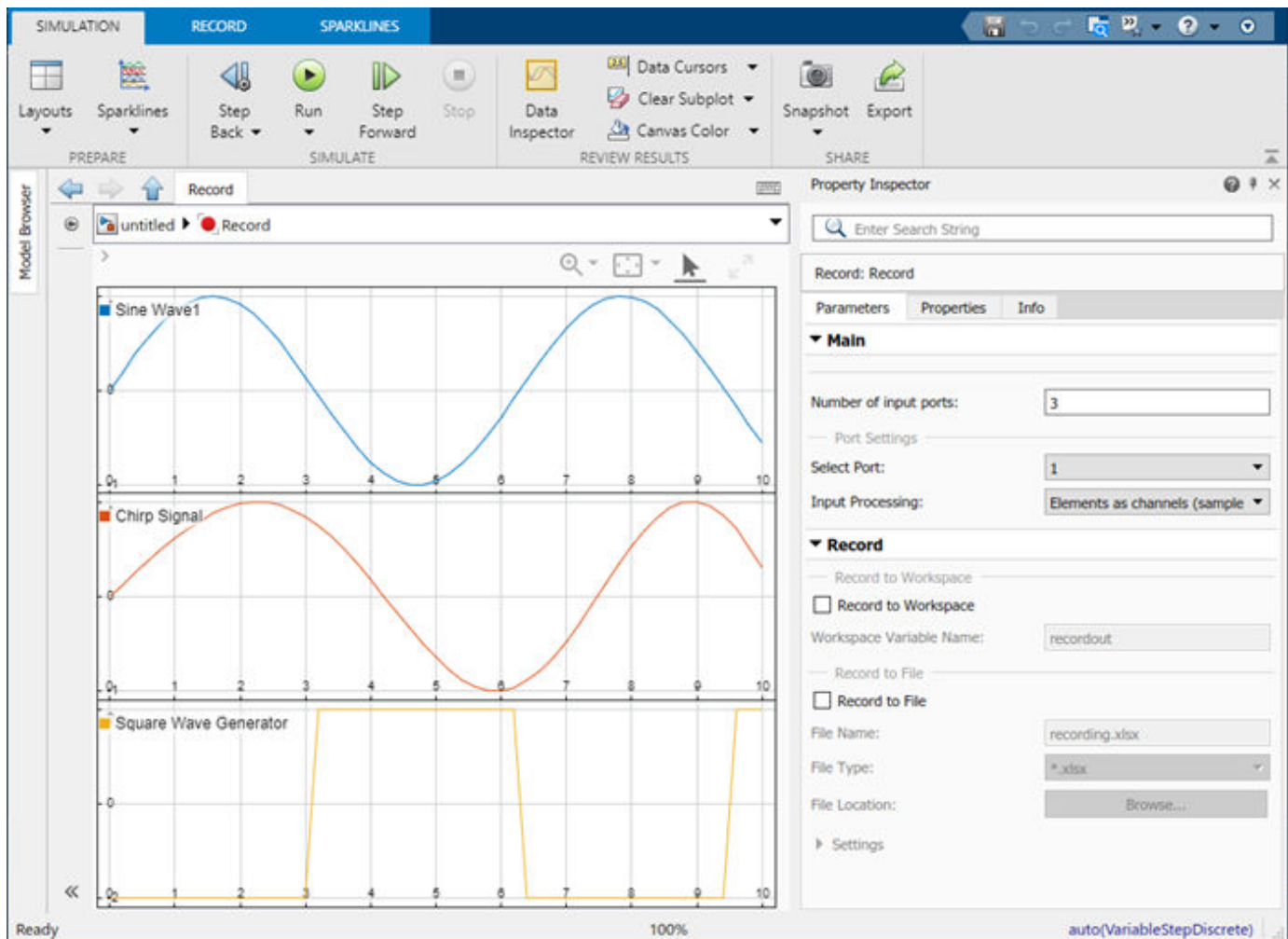

Build Visualizations

The Record block supports most visualizations available in the Simulation Data Inspector. When a different visualization makes sense for your data, you can modify the plot layout and plot types using the **Layouts** option and the plot types selector, labeled **Sparklines** by default. Use the **Layouts** list to select a layout of subplots. To change the plot type of a subplot, select the subplot then select the desired plot type from the plot types selector.

For more information, see “Log Data to the Workspace and a File Using the Record Block”. For examples that show how to use each visualization type, see:

- Sparklines — “View Many Signals Together Using Sparklines”
- XY — “Visualize Simulation Data on an XY Plot” and “Analyze Data Using the XY Plot”
- Map — “View and Replay Map Data”
- Time plot and text editor — “Create Plots Using the Simulation Data Inspector”

The Record block does not support the array visualization available in the Simulation Data Inspector. The Record block supports logging multidimensional signal data, including variable-size signals, but does not support visualizing multidimensional data. To visualize the data for a multidimensional

signal using the Record block, convert the signal with multidimensional sample values to a set of signals, called channels, that each have scalar sample values. For more information, see “Analyze Multidimensional Signal Data”.

XY Graph Block

The XY Graph block in the Simulink Sinks library is an alternative configuration of the Record block that visualizes two input signals on an XY plot. The first input port provides the x data for the XY plot, and the second input port provides the y data.

The XY Graph block supports logging and visualizing data for nonscalar inputs. However, the XY visualization does not support multidimensional data. When you connect nonscalar signals to the XY Graph block, you must manually configure which channels or elements of the nonscalar signal provide the x and y data for the XY plot.

Ports

Input

Port_1 — Signal to record

scalar | vector | matrix | N-D array | bus

Signal to record. You can add ports to the Record block by dragging lines to the edge of the block or by using the **Ports** parameter.

The Record block supports logging variable-size signals but does not support visualizing variable-size signals.

The XY Graph block is an alternative configuration of the Record block that visualizes data connected to two input ports on an XY plot. The first input port provides the x data for the XY plot, and the second input port provides the y data.

Tips

- To log frame-based data, specify the **Input Processing** parameter for each port that receives a frame-based signal.
- When you connect a nonscalar signal to an input port of the XY Graph block, you must manually configure which channels or elements of the nonscalar signal provide the x and y data for the XY plot.

Data Types: single | double | half | int8 | int16 | int32 | int64 | uint8 | uint16 | uint32 | uint64 | Boolean | fixed point | enumerated | bus

Parameters

To modify Record block parameters, use the Property Inspector.

Main

Number of input ports — Number of input ports

1 (default) | integer in the range [1, 100]

Number of input ports, specified as an integer between 1 and 100, inclusive.

The XY Graph block is an alternative configuration of the Record block that visualizes data connected to two input ports on an XY plot. The first input port provides the x data for the XY plot, and the second input port provides the y data.

Programmatic Use

Block Parameter: 'NumPorts'

Type: integer | character vector

Values: integer in the range [1,100]

Default: 1

Port — Port for which to specify input processing mode

1 (default) | integer

Use the **Port** and **Input Processing** parameters together to specify the input processing mode for a port. The input processing mode determines how the Record block interprets matrix data:

- Sample-based — Each element in the matrix is a separate channel.
- Frame-based — Each column in the matrix is a separate channel.

By default, each port processes the input signal as sample-based.

To change the input processing mode for a port:

- 1 Select the port number using the **Port** parameter.
- 2 Select the input processing mode using the **Input Processing** parameter.

Programmatic Use

Programmatically specify the input processing mode for each port by specifying the `FrameSettings` parameter as a row vector with as many elements as block ports. The element index corresponds to the port number on the block. Specify 1 to use frame-based input processing for the port and 0 to use sample-based processing.

Block Parameter: 'FrameSettings'

Type: logical array

Values: 1-by-n row vector, where n is equal to the number of ports

Default: 0

Input Processing — Input processing mode for selected port

Elements as channels (sample-based) (default) | Columns as channels (frame-based)

Use the **Port** and **Input Processing** parameters together to specify the input processing mode for a port. The input processing mode determines how the Record block interprets matrix data:

- Sample-based — Each element in the matrix is a separate channel.
- Frame-based — Each column in the matrix is a separate channel.

By default, each port processes the input signal as sample-based.

To change the input processing mode for a port:

- 1 Select the port number using the **Port** parameter.
- 2 Select the input processing mode using the **Input Processing** parameter.

Programmatic Use

Programmatically specify the input processing mode for each port by specifying the `FrameSettings` parameter as a row vector with as many elements as block ports. The element index corresponds to the port number on the block. Specify 1 to use frame-based input processing for the port and 0 to use sample-based processing.

Block Parameter: 'FrameSettings'

Type: logical array

Values: 1-by-n row vector, where n is equal to the number of ports

Default: 0

Record

Record to Workspace — Workspace logging option

off (default) | on

Workspace logging option. By default, the Record block logs data to the Simulation Data Inspector only. Select **Record to Workspace** to log data for signals connected to the Record block to the MATLAB workspace in a `Simulink.SimulationData.Dataset` object.

Use the **Workspace Variable Name** parameter to specify the name of the Dataset object that contains the logged Record block data.

Tips

- When you log data to the workspace, the way you access the data depends on your model configuration. By default, models provide all logged data in a single output variable as a `Simulink.SimulationOutput` object. You can access the Record block data using the `get` function or a dot with the Record block workspace variable name. When the **Single simulation output** option is disabled, logging data appears in separate variables in the workspace, and you access the Record block data directly.
- Logging intervals specified using the **Logging intervals** configuration parameter apply to data logged to the workspace using the Record block.
- You can use a single Record block to log data to the Simulation Data Inspector, to the workspace, and to a file.

Programmatic Use

Block Parameter: 'RecordToWorkspace'

Type: character vector | boolean | numeric

Values: 'on' | 'off' | true or 1 | false or 0

Default: 'off'

Workspace Variable Name — Name for workspace variable that contains logged block data

recordout (default) | character vector | string

Name for the workspace variable that contains the logged block data.

Dependencies

To enable this parameter, select the **Record to Workspace** parameter.

Programmatic Use

Block Parameter: 'VariableName'

Type: character vector | string

Default: 'recordout'

Record to File — Log to file option

off (default) | on

Log to file option. By default, the Record block logs data to the Simulation Data Inspector only. Select **Record to File** to log data for signals connected to the Record block to a file.

Tips

- Use the **File Name** parameter to specify a name for the file.
- Use the **File Type** parameter to specify whether to log data to an MLDATX file, a MAT file, or an Excel file.
- Use the **File Location** parameter to specify the path to the file.
- Logging intervals specified using the **Logging intervals** configuration parameter do not apply to data logged to a file using the Record block.

Programmatic Use**Block Parameter:** 'RecordToFile'**Type:** character vector | boolean | numeric**Values:** 'on' | 'off' | true or 1 | false or 0**Default:** 'off'**File Name — Name of file with logged data**

recording.mldatx (default) | character vector | string

Name of the file that contains the logged data. The name does not need to include the file extension. If you do include the file extension in the name, ensure the name uses a valid extension for the specified **File Type**.

Tips

- If you do not change the name or location of the file you log to from one run to the next, the Record block overwrites prior data in the file.
- When you want to save the file in a location other than your working directory, use the **File Location** parameter to specify the path to the directory where you want to save the file.

Dependencies

To enable this parameter, select the **Record to File** parameter.

Programmatic Use

Use the FileName parameter to specify the **File Name**, **File Type**, and **File Location** parameters. Include the extension for the desired file type in the name you pass to set_param. When you want to save the file somewhere other than the current working directory, specify the path with the file name and extension.

Block Parameter: 'FileName'**Type:** character vector | string**Default:** 'recording.mldatx'**File Type — Type of file for logged data**

*.mldatx (default) | *.mat | *.xlsx

Use the **File Type** parameter to specify whether you want to log data to an MLDATX file, a MAT file, or an Excel file.

Tips

- When you log data to an Excel file, the data is formatted as described in “Microsoft Excel Import, Export, and Logging Format”.
- When you log data to an Excel file, you can specify whether to share time columns using the **Time** parameter and which signal attributes to log using the **Attributes** parameter.

Dependencies

To enable this parameter, select **Record to File**.

Programmatic Use

Use the `FileName` parameter to specify the **File Name**, **File Type**, and **File Location** parameters. Include the extension for the desired file type in the name you pass to `set_param`. When you want to save the file somewhere other than the current working directory, specify the path with the file name and extension.

Block Parameter: 'FileName'

Type: character vector | string

Default: 'recording.mldatx'

File Location — Path to file with logged data

working directory (default) | character vector | string

Use the **File Location** parameter to specify the location where you want to save the file with the logged data when you want to save the file somewhere other than the working directory. Ensure you have write permissions in the directory you specify.

Dependencies

To enable this parameter, select **Record to File**.

Programmatic Use

Use the `FileName` parameter to specify the **File Name**, **File Type**, and **File Location** parameters. Include the extension for the desired file type in the name you pass to `set_param`. When you want to save the file somewhere other than the current working directory, specify the path with the file name and extension.

Block Parameter: 'FileName'

Type: character vector | string

Default: 'recording.mldatx'

Time — Options for exporting time data to Excel file

Shared Time Columns (default) | Individual Time Columns

Use the **Time** parameter to specify how to log signal time data when you log the Record block data to an Excel file.

- **Shared Time Columns** — When time data is identical for multiple signals, the signals share a single time column in the logging file. The logging file may still include multiple time columns if the Record block logs data for signals with unique time data.
- **Individual Time Columns** — Each logged signal always has its own time column in the logging file.

Dependencies

To enable this parameter, select **Record to File** and specify **File Type** as `*.xlsx`.

Attributes — Signal attributes to export to Excel file

Data Type | Units | Port Index | Block Path | Interpolation

Select one or more signal attribute options to include in the logging file when you log data to an Excel file. Selected signal attributes appear in the signal column above the first data point according to the format described in “Microsoft Excel Import, Export, and Logging Format”.

Dependencies

To enable this parameter, select **Record to File** and specify **File Type** as `*.xlsx`.

Block Characteristics

| | |
|---------------------------------|--|
| Data Types | Boolean bus double enumerated fixed point half integer single string |
| Direct Feedthrough | no |
| Multidimensional Signals | yes |
| Variable-Size Signals | yes |
| Zero-Crossing Detection | no |

See Also**Tools**

Simulation Data Inspector

Blocks

Outport | To Workspace | To File

Simulink Configuration Parameters

Single simulation output

Introduced in R2021a

Relational Operator

Perform specified relational operation on inputs

Library: Simulink / Commonly Used Blocks
 Simulink / Logic and Bit Operations
 HDL Coder / Commonly Used Blocks
 HDL Coder / HDL Floating Point Operations
 HDL Coder / Logic and Bit Operations



Description

The Relational Operator block performs the specified relational operation on the input. The value you choose for the **Relational operator** parameter determines whether the block accepts one or two input signals.

Two-Input Mode

By default, the Relational Operator block compares two inputs using the **Relational operator** parameter that you specify. The first input corresponds to the top input port and the second input to the bottom input port. (See “Port Location After Rotating or Flipping” for a description of the port order for various block orientations.)

You can specify one of the following operations in two-input mode:

| Operation | Description |
|-----------|--|
| == | True if the first input is equal to the second input |
| ~= | True if the first input is not equal to the second input |
| < | True if the first input is less than the second input |
| <= | True if the first input is less than or equal to the second input |
| >= | True if the first input is greater than or equal to the second input |
| > | True if the first input is greater than the second input |

You can specify inputs as scalars, arrays, or a combination of a scalar and an array.

| For... | The output is... |
|-------------------------------|---|
| Scalar inputs | A scalar |
| Array inputs | An array of the same dimensions, where each element is the result of an element-by-element comparison of the input arrays |
| Mixed scalar and array inputs | An array, where each element is the result of a comparison between the scalar and the corresponding array element |

The input with the smaller positive range is converted to the data type of the other input offline using round-to-nearest and saturation. This conversion occurs before the comparison.

You can specify the output data type using the **Output data type** parameter. The output equals 1 for true and 0 for false.

Tip Select an output data type that represents zero exactly. Data types that satisfy this condition include signed and unsigned integers and any floating-point data type.

One-Input Mode

When you select one of the following operations for **Relational operator**, the block switches to one-input mode.

| Operation | Description |
|-----------|-----------------------------|
| isInf | True if the input is Inf |
| isNaN | True if the input is NaN |
| isFinite | True if the input is finite |

For an input that is not floating point, the block produces the following output.

| Data Type | Operation | Block Output |
|--|-----------|--------------|
| <ul style="list-style-type: none"> • Fixed point • Boolean • Built-in integer | isInf | False |
| | isNaN | False |
| | isFinite | True |

Rules for Data Type Propagation

The following rules apply for data type propagation when your block has one or more input ports with unspecified data types.

| When the block is in... | And... | The block uses... |
|-------------------------|--|--|
| Two-input mode | Both input ports have unspecified data types | double as the default data type for both inputs |
| | One input port has an unspecified data type | The data type from the specified input port as the default data type of the other port |
| One-input mode | The input port has an unspecified data type | double as the default data type for the input |

Ports

Input

Port_1 — First input signal

scalar | vector | matrix

First input signal, specified as a scalar, vector, or matrix.

Data Types: half | single | double | int8 | int16 | int32 | int64 | uint8 | uint16 | uint32 | uint64 | Boolean | fixed point | enumerated

Port_2 — Second input signal

scalar | vector | matrix

Second input signal, specified as a scalar, vector, or matrix.

Dependencies

To enable this port, set the **Relational operator** to ==, ~=, <, <=, >=, or >.

Data Types: half | single | double | int8 | int16 | int32 | int64 | uint8 | uint16 | uint32 | uint64 | Boolean | fixed point | enumerated

Output**Port_1 — Output signal**

scalar | vector | matrix

Output signal, consisting of zeros and ones, with the same dimensions as the input. You control the output data type with the **Output data type** parameter.

Data Types: half | single | double | int8 | int16 | int32 | int64 | uint8 | uint16 | uint32 | uint64 | Boolean | fixed point | enumerated

Parameters**Main****Relational operator — Relational operator**

<= (default) | ~= | == | < | >= | > | isInf | isNaN | isFinite

Specify the operation for comparing two inputs or determining the signal type of one input.

- == — True if the first input is equal to the second input
- ~= — True if the first input is not equal to the second input
- < — True if the first input is less than the second input
- <= — True if the first input is less than or equal to the second input
- >= — True if the first input is greater than or equal to the second input
- > — True if the first input is greater than the second input
- isInf — True if the input is Inf
- isNaN — True if the input is NaN
- isFinite — True if the input is finite

Programmatic Use**Block Parameter:** Operator**Type:** character vector**Values:** '==' | '~=' | '<' | '<=' | '>=' | '>' | 'isInf' | 'isNaN' | 'isFinite'**Default:** '<='**Enable zero-crossing detection — Enable zero-crossing detection**

on (default) | off

Select to enable zero-crossing detection. For more information, see “Zero-Crossing Detection”.

Programmatic Use**Parameter:** ZeroCross**Type:** character vector, string**Values:** 'on' | 'off'**Default:** 'on'**Sample time — Specify sample time as a value other than -1**`-1 (default) | scalar | vector`

Specify the sample time as a value other than -1. For more information, see “Specify Sample Time”.

Dependencies

This parameter is not visible unless it is explicitly set to a value other than -1. To learn more, see “Blocks for Which Sample Time Is Not Recommended”.

Programmatic Use**Block Parameter:** SampleTime**Type:** character vector**Values:** scalar or vector**Default:** '-1'**Data Type****Require all inputs to have the same data type — Require all inputs to have same data type**`off (default) | on`

To require that all block inputs have the same data type, select this check box. When you clear this check box, the inputs can have different data types.

Dependencies

This check box is not available when you set **Relational operator** to `isInf`, `isNaN`, or `isFinite` because, in those modes, the block only has one input port.

Programmatic Use**Block Parameter:** InputSameDT**Type:** character vector**Values:** 'off' | 'on'**Default:** 'off'**Output data type — Output data type**`boolean (default) | Inherit: Logical (see Configuration Parameters: Optimization) | fixdt(1,16) | <data type expression>`

Specify the output data type. When you select:

- `boolean` — The block output has data type `boolean`.
- `Inherit: Logical (see Configuration Parameters: Optimization)` — The block uses the **Implement logic signals as Boolean data** configuration parameter to specify the output data type (see “Implement logic signals as Boolean data (vs. double)”).

Note This option supports models created before the `boolean` option was available. Use one of the other options, preferably `boolean`, for new models.

- `fixdt(1,16)` — The block output has the specified fixed-point data type `fixdt(1,16)`.

Tip Click the **Show data type assistant** button  to display the **Data Type Assistant**, which helps you set the data type attributes. For more information, see “Specify Data Types Using Data Type Assistant”.

- `<data type expression>` — The block output has the data type you specify as a data type expression, for example, `Simulink.NumericType`.

Tip To enter a built-in data type (`double`, `single`, `int8`, `uint8`, `int16`, `uint16`, `int32`, or `uint32`), enclose the expression in single quotes. For example, enter `'double'` instead of `double`.

Programmatic Use

Block Parameter: `OutDataTypeStr`

Type: character vector

Values: `'Inherit: Logical (see Configuration Parameters: Optimization)'` | `'boolean'` | `'fixdt(1,16)'` | `'<data type expression>'`

Default: `'boolean'`

Integer rounding mode — Rounding mode for fixed-point operations

`Simplest (default)` | `Convergent` | `Floor` | `Nearest` | `Round` | `Ceiling` | `Zero`

Specify the rounding mode for fixed-point operations. You can select:

Ceiling

Rounds positive and negative numbers toward positive infinity. Equivalent to the MATLAB `ceil` function.

Convergent

Rounds number to the nearest representable value. If a tie occurs, rounds to the nearest even integer. Equivalent to the Fixed-Point Designer `convergent` function.

Floor

Rounds positive and negative numbers toward negative infinity. Equivalent to the MATLAB `floor` function.

Nearest

Rounds number to the nearest representable value. If a tie occurs, rounds toward positive infinity. Equivalent to the Fixed-Point Designer `nearest` function.

Round

Rounds number to the nearest representable value. If a tie occurs, rounds positive numbers toward positive infinity and rounds negative numbers toward negative infinity. Equivalent to the Fixed-Point Designer `round` function.

Simplest

Chooses between rounding toward floor and rounding toward zero to generate rounding code that is as efficient as possible.

Zero

Rounds number toward zero. Equivalent to the MATLAB `fix` function.

For more information, see “Rounding” (Fixed-Point Designer).

Programmatic Use**Block Parameter:** RndMeth**Type:** character vector**Values:** 'Ceiling' | 'Convergent' | 'Floor' | 'Nearest' | 'Round' | 'Simplest' | 'Zero'**Default:** 'Simplest'**Block Characteristics**

| | |
|---------------------------------|---|
| Data Types | Boolean double enumerated fixed point half integer single |
| Direct Feedthrough | yes |
| Multidimensional Signals | yes |
| Variable-Size Signals | yes |
| Zero-Crossing Detection | yes |

Extended Capabilities**C/C++ Code Generation**

Generate C and C++ code using Simulink® Coder™.

HDL Code Generation

Generate Verilog and VHDL code for FPGA and ASIC designs using HDL Coder™.

HDL Coder provides additional configuration options that affect HDL implementation and synthesized logic.

HDL Architecture

This block has a single, default HDL architecture.

HDL Block Properties

| General | |
|----------------------------------|--|
| ConstrainedOutputPipeline | Number of registers to place at the outputs by moving existing delays within your design. Distributed pipelining does not redistribute these registers. The default is 0. For more details, see “ConstrainedOutputPipeline” (HDL Coder). |
| InputPipeline | Number of input pipeline stages to insert in the generated code. Distributed pipelining and constrained output pipelining can move these registers. The default is 0. For more details, see “InputPipeline” (HDL Coder). |
| OutputPipeline | Number of output pipeline stages to insert in the generated code. Distributed pipelining and constrained output pipelining can move these registers. The default is 0. For more details, see “OutputPipeline” (HDL Coder). |

| Native Floating Point | |
|------------------------------|---|
| LatencyStrategy | Specify whether to map the blocks in your design to <code>inherit</code> , <code>Max</code> , <code>Min</code> , <code>Zero</code> , or <code>Custom</code> for the floating-point operator. The default is <code>inherit</code> . See also “ <code>LatencyStrategy</code> ” (HDL Coder). |
| NFPCustomLatency | To specify a value, set LatencyStrategy to <code>Custom</code> . HDL Coder adds latency equal to the value that you specify for the NFPCustomLatency setting. See also “ <code>NFPCustomLatency</code> ” (HDL Coder). |

Complex Data Support

The `~=` and `==` operators are supported for code generation.

PLC Code Generation

Generate Structured Text code using Simulink® PLC Coder™.

Fixed-Point Conversion

Design and simulate fixed-point systems using Fixed-Point Designer™.

See Also

Logical Operator

Introduced before R2006a

Relay

Switch output between two constants

Library: Simulink / Discontinuities
HDL Coder / Discontinuities

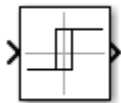

Description

The output for the Relay block switches between two specified values. When the relay is on, it remains on until the input drops below the value of the **Switch off point** parameter. When the relay is off, it remains off until the input exceeds the value of the **Switch on point** parameter. The block accepts one input and generates one output.

Note When the initial input falls *between* the **Switch off point** and **Switch on point** values, the initial output is the value when the relay is off.

Ports

Input

Port_1 — Input signal

scalar

The input signal that switches the relay on or off.

Data Types: `single` | `double` | `int8` | `int16` | `int32` | `int64` | `uint8` | `uint16` | `uint32` | `uint64` | `Boolean` | `fixed point`

Output

Port_1 — Output signal

scalar

The output signal switches between two values determined by the parameters **Output when on** and **Output when off**.

Data Types: `single` | `double` | `int8` | `int16` | `int32` | `int64` | `uint8` | `uint16` | `uint32` | `uint64` | `Boolean` | `fixed point`

Parameters

Switch on point — Input value which switches the relay on

'eps' (default) | scalar

When the input crosses this threshold, the relay switches on. The **Switch on point** value must be greater than or equal to the **Switch off point**. Specifying a **Switch on point** value greater than the

Switch off point models hysteresis, whereas specifying equal values models a switch with a threshold at that value.

The **Switch on point** parameter is converted to the input data type offline using round-to-nearest and saturation methods.

Programmatic Use

Block Parameter: OnSwitchValue

Type: character vector

Values: scalar

Default: 'eps'

Switch off point — Input value which switches the relay off

'eps' (default) | scalar

When the input crosses this threshold the relay switches off. The value of **Switch off point** must be less than or equal to **Switch on point**. The **Switch off point** parameter is converted to the input data type offline using round-to-nearest and saturation.

Programmatic Use

Block Parameter: OffSwitchValue

Type: character vector

Values: scalar

Default: 'eps'

Output when on — Output value when the relay is on

1 (default) | scalar

The output value when the relay is on.

Programmatic Use

Block Parameter: OnOutputValue

Type: character vector

Values: scalar

Default: '1'

Output when off — Output value when the relay is off

0 (default) | scalar

The output value when the relay is off.

Programmatic Use

Block Parameter: OffOutputValue

Type: character vector

Values: scalar

Default: '0'

Input processing — Specify sample- or frame-based processing

Elements as channels (sample based) (default) | Columns as channels (frame based)

Specify whether the block performs sample- or frame-based processing:

- Columns as channels (frame based) — Treat each column of the input as a separate channel (frame-based processing).

Note Frame-based processing requires a DSP System Toolbox license.

For more information, see “Sample- and Frame-Based Concepts” (DSP System Toolbox).

- **Elements as channels (sample based)** — Treat each element of the input as a separate channel (sample-based processing).

Use **Input processing** to specify whether the block performs sample- or frame-based processing. For more information about these two processing modes, see “Sample- and Frame-Based Concepts” (DSP System Toolbox).

Programmatic Use

Block Parameter: InputProcessing

Type: character vector

Values: 'Columns as channels (frame based)' | 'Elements as channels (sample based)'

Default: 'Elements as channels (sample based)'

Enable zero-crossing detection — Enable zero-crossing detection

on (default) | Boolean

Select to enable zero-crossing detection. For more information, see “Zero-Crossing Detection” in the Simulink documentation.

Programmatic Use

Block Parameter: ZeroCross

Type: character vector, string

Values: 'off' | 'on'

Default: 'on'

Sample time — Specify sample time as a value other than -1

-1 (default) | scalar | vector

Specify the sample time as a value other than -1. For more information, see “Specify Sample Time”.

Dependencies

This parameter is not visible unless it is explicitly set to a value other than -1. To learn more, see “Blocks for Which Sample Time Is Not Recommended”.

Programmatic Use

Block Parameter: SampleTime

Type: character vector

Values: scalar or vector

Default: '-1'

Output minimum — Minimum output value for range checking

[] (default) | scalar

Lower value of the output range that Simulink checks.

Simulink uses the minimum to perform:

- Parameter range checking (see “Specify Minimum and Maximum Values for Block Parameters”) for some blocks.
- Simulation range checking (see “Specify Signal Ranges” and “Enable Simulation Range Checking”).

- Automatic scaling of fixed-point data types.
- Optimization of the code that you generate from the model. This optimization can remove algorithmic code and affect the results of some simulation modes such as SIL or external mode. For more information, see “Optimize using the specified minimum and maximum values” (Embedded Coder).

Note Output minimum does not saturate or clip the actual output signal. Use the Saturation block instead.

Programmatic Use**Block Parameter:** OutMin**Type:** character vector**Values:** '[]' | scalar**Default:** '[]'**Output maximum — Maximum output value for range checking**

[] (default) | scalar

Upper value of the output range that Simulink checks.

Simulink uses the maximum value to perform:

- Parameter range checking (see “Specify Minimum and Maximum Values for Block Parameters”) for some blocks.
- Simulation range checking (see “Specify Signal Ranges” and “Enable Simulation Range Checking”).
- Automatic scaling of fixed-point data types.
- Optimization of the code that you generate from the model. This optimization can remove algorithmic code and affect the results of some simulation modes such as SIL or external mode. For more information, see “Optimize using the specified minimum and maximum values” (Embedded Coder).

Note Output maximum does not saturate or clip the actual output signal. Use the Saturation block instead.

Programmatic Use**Block Parameter:** OutMax**Type:** character vector**Values:** '[]' | scalar**Default:** '[]'**Output data type — Data type of output signal**

Inherit: All ports same datatype (default) | Inherit: Inherit via back propagation | double | single | int8 | int32 | uint32 | int64 | uint64 | fixdt(1,16,2^0,0) | <data type expression> | ...

Specify the output data type. You can set it to:

- A rule that inherits a data type, for example, Inherit: Inherit via back propagation

- The name of a built-in data type, for example, `single`
- The name of a data type object, for example, a `Simulink.NumericType` object
- An expression that evaluates to a data type, for example, `fixdt(1,16,0)`

Click the **Show data type assistant** button  to display the **Data Type Assistant**, which helps you set the **Output data type** parameter.

See “Control Data Types of Signals” in *Simulink User's Guide* for more information.

Programmatic Use

Block Parameter: `OutDataTypeStr`

Type: character vector

Values: 'Inherit: Same as input', 'Inherit: Inherit via back propagation', 'single', 'int8', 'uint8', 'int16', 'uint16', 'int32', 'uint32', 'int64', 'uint64', 'fixdt(1,16,0)', 'fixdt(1,16,2^0,0)', 'fixdt(1,16,2^0,0)'. '<data type expression>'

Default: 'Inherit: Same as input'

Lock data type settings against changes by the fixed-point tools — Prevent fixed-point tools from overriding data types

off (default) | on

Select this parameter to prevent the fixed-point tools from overriding the data types you specify on this block. For more information, see “Lock the Output Data Type Setting” (Fixed-Point Designer).

Programmatic Use

Block Parameter: `LockScale`

Type: character vector

Values: 'off' | 'on'

Default: 'off'

Block Characteristics

| | |
|---------------------------------|---|
| Data Types | Boolean double fixed point integer single |
| Direct Feedthrough | yes |
| Multidimensional Signals | no |
| Variable-Size Signals | no |
| Zero-Crossing Detection | yes |

Extended Capabilities

C/C++ Code Generation

Generate C and C++ code using Simulink® Coder™.

HDL Code Generation

Generate Verilog and VHDL code for FPGA and ASIC designs using HDL Coder™.

HDL Coder provides additional configuration options that affect HDL implementation and synthesized logic.

HDL Architecture

This block has a single, default HDL architecture.

HDL Block Properties

| | |
|----------------------------------|--|
| ConstrainedOutputPipeline | Number of registers to place at the outputs by moving existing delays within your design. Distributed pipelining does not redistribute these registers. The default is 0. For more details, see "ConstrainedOutputPipeline" (HDL Coder). |
| InputPipeline | Number of input pipeline stages to insert in the generated code. Distributed pipelining and constrained output pipelining can move these registers. The default is 0. For more details, see "InputPipeline" (HDL Coder). |
| OutputPipeline | Number of output pipeline stages to insert in the generated code. Distributed pipelining and constrained output pipelining can move these registers. The default is 0. For more details, see "OutputPipeline" (HDL Coder). |

PLC Code Generation

Generate Structured Text code using Simulink® PLC Coder™.

Fixed-Point Conversion

Design and simulate fixed-point systems using Fixed-Point Designer™.

See Also

Saturation | Backlash

Introduced before R2006a

Repeating Sequence

Generate arbitrarily shaped periodic signal

Library: Simulink / Sources



Description

The Repeating Sequence block outputs a periodic scalar signal having a waveform that you specify using the **Time values** and **Output values** parameters. The **Time values** parameter specifies a vector of output times. The **Output values** parameter specifies a vector of signal amplitudes at the corresponding output times. Together, the two parameters specify a sampling of the output waveform at points measured from the beginning of the interval over which the waveform repeats (the period of the signal).

By default, both parameters are `[0 2]`. These default settings specify a sawtooth waveform that repeats every 2 seconds from the start of the simulation and has a maximum amplitude of 2.

Ports

Output

Port_1 — Periodic output signal

scalar

Output signal specified by the **Time values** and **Output values** parameters to create a periodic scalar signal.

Data Types: double

Parameters

Time values — Vector of output times

`[0 2]` (default) | vector

Vector of strictly monotonically increasing time values. The period of the generated waveform is the difference of the last and first values of this parameter.

Programmatic Use

Block Parameter: `rep_seq_t`

Type: character vector

Values: vector

Default: `[0 2]`

Output values — Vector of output values

`[0 2]` (default) | vector

Vector of output values that specify the output waveform. Each element corresponds to the time value in the **Time values** parameter.

Programmatic Use

Block Parameter: rep_seq_y

Type: character vector

Values: vector

Default: [0 2]

Block Characteristics

| | |
|---------------------------------|--------|
| Data Types | double |
| Direct Feedthrough | no |
| Multidimensional Signals | no |
| Variable-Size Signals | no |
| Zero-Crossing Detection | no |

Algorithms

The block sets the input period as the difference between the first and last value of the **Time values** parameter. The output at any time t is the output at time $t = t - n \cdot \text{period}$, where n is an integer. The sequence repeats at $t = n \cdot \text{period}$. The block uses linear interpolation to compute the value of the waveform between the output times that you specify.

Extended Capabilities

C/C++ Code Generation

Generate C and C++ code using Simulink® Coder™.

Not recommended for production code.

Consider using Repeating Sequence Stair or Repeating Sequence Interpolated blocks for code generation.

See Also

Repeating Sequence Stair | Repeating Sequence Interpolated

Introduced before R2006a

Repeating Sequence Interpolated

Output discrete-time sequence and repeat, interpolating between data points

Library: Simulink / Sources



Description

The Repeating Sequence Interpolated block outputs a periodic discrete-time sequence based on the values in **Vector of time values** and **Vector of output values** parameters. Between data points, the block uses the method you specify for the **Lookup Method** parameter to determine the output.

Ports

Output

Port_1 — Periodic output signal

scalar

Output signal generated based on the values in the **Vector of time values** and **Vector of output values** parameters.

Data Types: `single` | `double` | `int8` | `int16` | `int32` | `int64` | `uint8` | `uint16` | `uint32` | `uint64` | `Boolean` | `fixed point`

Parameters

Main

Vector of output values — Vector of output values

`[3 1 4 2 1].'` (default) | vector

Vector of output values that specify the output waveform. Each element corresponds to the time value in the **Vector of time values** parameter.

Programmatic Use

Block Parameter: OutValues

Type: character vector

Values: vector

Default: `[3 1 4 2 1].'`

Vector of time values — Vector of time values

`[0 0.1 0.5 0.6 1].'` (default) | vector

Specify the column vector containing time values. The time values must be strictly increasing, and the vector must have the same size as the vector of output values.

Programmatic Use**Block Parameter:** TimeValues**Type:** character vector**Values:** vector**Default:** [0 0.1 0.5 0.6 1].'**Lookup Method — Lookup method for output**

Interpolation-Use End Values (default) | Use Input Nearest | Use Input Below | Use Input Above

Specify the lookup method to determine the output between data points.

Programmatic Use**Block Parameter:** LookUpMeth**Type:** character vector**Values:** 'Interpolation-Use End Values' | 'Use Input Nearest' | Use Input Below | Use Input Above**Default:** 'Interpolation-Use End Values'**Sample time — Time interval between samples**

0.01 (default) | scalar

Specify the time interval between samples. To inherit the sample time, set this parameter to -1. See “Specify Sample Time” for more information.

Programmatic Use**Block Parameter:** tsamp**Type:** character vector**Values:** scalar**Default:** '0.01'**Signal Attributes****Output minimum — Minimum output value for range checking**

[] (default) | scalar

Lower value of the output range that Simulink checks.

Simulink uses the minimum to perform:

- Parameter range checking (see “Specify Minimum and Maximum Values for Block Parameters”) for some blocks.
- Simulation range checking (see “Specify Signal Ranges” and “Enable Simulation Range Checking”).
- Automatic scaling of fixed-point data types.
- Optimization of the code that you generate from the model. This optimization can remove algorithmic code and affect the results of some simulation modes such as SIL or external mode. For more information, see “Optimize using the specified minimum and maximum values” (Embedded Coder).

Note Output minimum does not saturate or clip the actual output signal. Use the Saturation block instead.

Programmatic Use**Block Parameter:** OutMin**Type:** character vector**Values:** '[]' | scalar**Default:** '[]'**Output maximum — Maximum output value for range checking**

[] (default) | scalar

Upper value of the output range that Simulink checks.

Simulink uses the maximum value to perform:

- Parameter range checking (see “Specify Minimum and Maximum Values for Block Parameters”) for some blocks.
- Simulation range checking (see “Specify Signal Ranges” and “Enable Simulation Range Checking”).
- Automatic scaling of fixed-point data types.
- Optimization of the code that you generate from the model. This optimization can remove algorithmic code and affect the results of some simulation modes such as SIL or external mode. For more information, see “Optimize using the specified minimum and maximum values” (Embedded Coder).

Note **Output maximum** does not saturate or clip the actual output signal. Use the Saturation block instead.

Programmatic Use**Block Parameter:** OutMax**Type:** character vector**Values:** '[]' | scalar**Default:** '[]'**Output data type — Specify the output data type**

double (default) | Inherit: Inherit via back propagation | single | int8 | int32 | uint32 | int64 | uint64 | fixdt(1,16,2^0,0) | <data type expression> | ...

Choose the data type for the output. The type can be inherited, specified directly, or expressed as a data type object such as Simulink.NumericType.

Programmatic Use**Block Parameter:** OutDataTypeStr**Type:** character vector

Values: , 'Inherit: Inherit via back propagation', 'single', 'int8', 'uint8', int16, 'uint16', 'int32', 'uint32', 'int64', 'uint64', fixdt(1,16,0), fixdt(1,16,2^0,0), fixdt(1,16,2^0,0). '<data type expression>'

Default: 'Double'**Lock output data type setting against changes by the fixed-point tools — Prevent fixed-point tools from overriding data types**

off (default) | on

Select to lock the output data type setting of this block against changes by the Fixed-Point Tool and the Fixed-Point Advisor. For more information, see “Use Lock Output Data Type Setting” (Fixed-Point Designer).

Programmatic Use

Block Parameter: LockScale

Type: character vector

Values: 'off' | 'on'

Default: 'off'

Block Characteristics

| | |
|---------------------------------|---|
| Data Types | Boolean double fixed point integer single |
| Direct Feedthrough | no |
| Multidimensional Signals | no |
| Variable-Size Signals | no |
| Zero-Crossing Detection | no |

Extended Capabilities**C/C++ Code Generation**

Generate C and C++ code using Simulink® Coder™.

Cannot be used inside a triggered subsystem hierarchy.

PLC Code Generation

Generate Structured Text code using Simulink® PLC Coder™.

Fixed-Point Conversion

Design and simulate fixed-point systems using Fixed-Point Designer™.

See Also

Repeating Sequence | Repeating Sequence Stair

Introduced before R2006a

Repeating Sequence Stair

Output and repeat discrete time sequence

Library: Simulink / Sources



Description

The Repeating Sequence Stair block outputs and repeats a stair sequence that you specify with the **Vector of output values** parameter. For example, you can specify the vector as $[3 \ 1 \ 2 \ 4 \ 1]'$. A value in **Vector of output values** is output at each time interval, and then the sequence repeats.

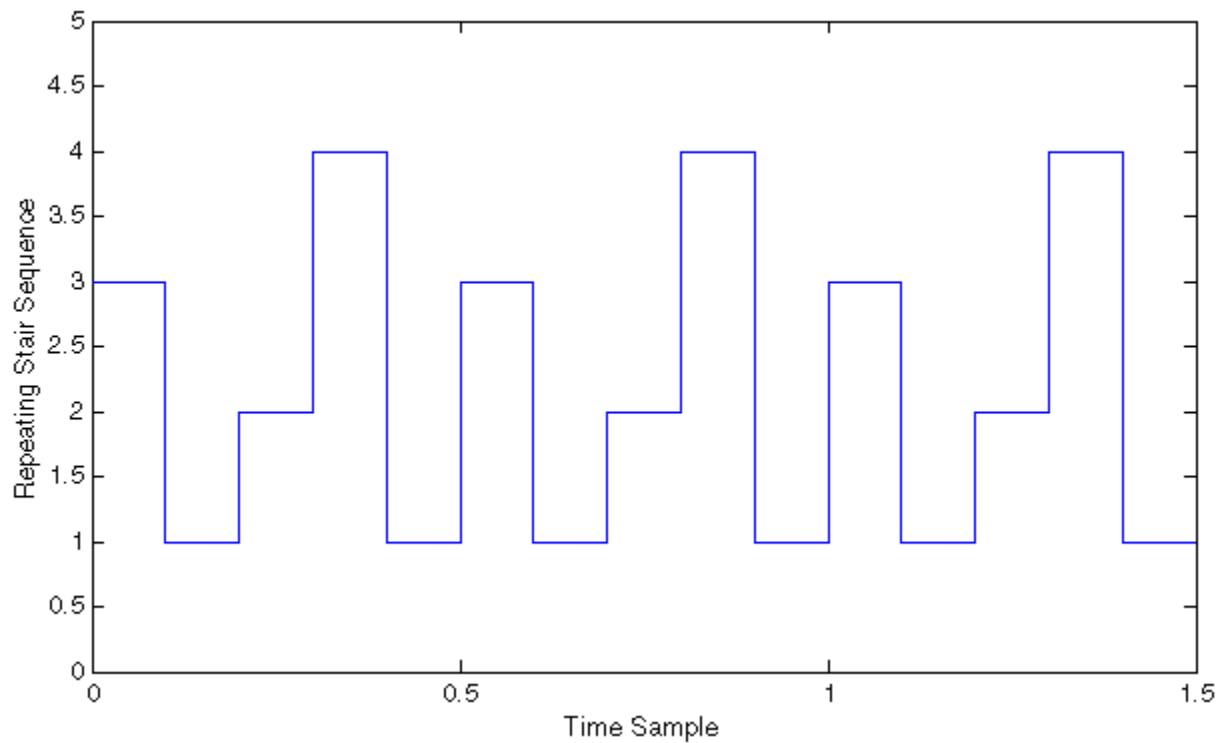

Ports

Output

Port_1 — Repeating discrete output signal

scalar

Output signal generated based on the values in the **Vector of time values** and **Sample time** parameters.

Data Types: `single` | `double` | `int8` | `int16` | `int32` | `int64` | `uint8` | `uint16` | `uint32` | `uint64` | `Boolean` | `fixed point` | `enumerated`

Parameters

Main

Vector of output values — Vector of output values

`[3 1 4 2 1].'` (default) | vector

Specify the vector containing values of the repeating stair sequence.

Programmatic Use

Block Parameter: `OutValues`

Type: character vector

Values: vector

Default: `[3 1 4 2 1].'`

Sample time — Time interval between samples

`-1` (default) | scalar

Specify the time interval between samples. To inherit the sample time, set this parameter to `-1`. See “Specify Sample Time” for more information.

Programmatic Use

Block Parameter: `tsamp`

Type: character vector

Values: scalar

Default: `'-1'`

Signal Attributes

Output minimum — Minimum output value for range checking

`[]` (default) | scalar

Lower value of the output range that Simulink checks.

Simulink uses the minimum to perform:

- Parameter range checking (see “Specify Minimum and Maximum Values for Block Parameters”) for some blocks.
- Simulation range checking (see “Specify Signal Ranges” and “Enable Simulation Range Checking”).
- Automatic scaling of fixed-point data types.
- Optimization of the code that you generate from the model. This optimization can remove algorithmic code and affect the results of some simulation modes such as SIL or external mode. For more information, see “Optimize using the specified minimum and maximum values” (Embedded Coder).

Note Output minimum does not saturate or clip the actual output signal. Use the Saturation block instead.

Programmatic Use**Block Parameter:** OutMin**Type:** character vector**Values:** '[]' | scalar**Default:** '[]'**Output maximum — Maximum output value for range checking**

[] (default) | scalar

Upper value of the output range that Simulink checks.

Simulink uses the maximum value to perform:

- Parameter range checking (see “Specify Minimum and Maximum Values for Block Parameters”) for some blocks.
- Simulation range checking (see “Specify Signal Ranges” and “Enable Simulation Range Checking”).
- Automatic scaling of fixed-point data types.
- Optimization of the code that you generate from the model. This optimization can remove algorithmic code and affect the results of some simulation modes such as SIL or external mode. For more information, see “Optimize using the specified minimum and maximum values” (Embedded Coder).

Note Output maximum does not saturate or clip the actual output signal. Use the Saturation block instead.

Programmatic Use**Block Parameter:** OutMax**Type:** character vector**Values:** '[]' | scalar**Default:** '[]'**Output data type — Specify the output data type**

double (default) | Inherit: Inherit via back propagation | single | int8 | int32 | uint32 | int64 | uint64 | fixdt(1,16,2^0,0) | <data type expression> | ...

Choose the data type for the output. The type can be inherited, specified directly, or expressed as a data type object such as Simulink.NumericType.

Click the **Show data type assistant** button  to display the **Data Type Assistant**, which helps you set the data type attributes. For more information, see “Specify Data Types Using Data Type Assistant”.

Programmatic Use**Block Parameter:** OutDataTypeStr**Type:** character vector

Values: 'Inherit: Inherit via back propagation' | 'single' | 'int8' | 'uint8' | int16 | 'uint16' | 'int32' | 'uint32' | 'int64' | 'uint64' | fixdt(1,16,0) | fixdt(1,16,2^0,0) | fixdt(1,16,2^0,0) | '<data type expression>'

Default: 'Double'

Lock output data type setting against changes by the fixed-point tools — Prevent fixed-point tools from overriding data types

off (default) | on

Select to lock the output data type setting of this block against changes by the Fixed-Point Tool and the Fixed-Point Advisor. For more information, see “Use Lock Output Data Type Setting” (Fixed-Point Designer).

Programmatic Use

Block Parameter: LockScale

Type: character vector

Values: 'off' | 'on'

Default: 'off'

Block Characteristics

| | |
|---------------------------------|--|
| Data Types | Boolean double enumerated fixed point integer single |
| Direct Feedthrough | no |
| Multidimensional Signals | no |
| Variable-Size Signals | no |
| Zero-Crossing Detection | no |

Extended Capabilities

C/C++ Code Generation

Generate C and C++ code using Simulink® Coder™.

PLC Code Generation

Generate Structured Text code using Simulink® PLC Coder™.

Fixed-Point Conversion

Design and simulate fixed-point systems using Fixed-Point Designer™.

See Also

Repeating Sequence | Repeating Sequence Interpolated

Introduced before R2006a

Reset

Control block for resettable subsystem

Description

A Reset block placed at the root level of a Subsystem block adds a control port to the block. When a reset trigger signal occurs on the signal connected to the port, the block states of the subsystem are reset to their initial condition. See Resettable Subsystem.

Parameters

Reset trigger type — Select the type of trigger event

level (default) | rising | falling | either | level hold

Select the type of trigger signal that resets the subsystem block states.

level

Reset the block states when the trigger signal is nonzero at the current time step or changes from nonzero at the previous time step to zero at the current time step.

rising

Reset the block states when the trigger signal rises from a zero to a positive value or from a negative to a positive value.

falling

Reset the block states when the trigger signal falls from a positive value to zero or from a positive to a negative value.

either

Reset the block states when the trigger signal changes from a zero to a nonzero value or changes sign.

level hold

Reset the block states when the trigger signal is nonzero at the current time step.

Programmatic Use

Block Parameter: ResetTriggerType

Type: character vector

Value: 'level' | 'rising' | 'falling' | 'either' | 'level hold'

Default: 'level'

Propagate sizes of variable-size signals — Select when to propagate a variable-size signal

During execution (default) | Only when enabling

Select when to propagate a variable-size signal.

During execution

Propagate variable-size signals at each time step.

Only when resetting

Propagate variable-size signals when resetting a Subsystem block containing a Reset port block. When you select this option, sample time must be periodic.

Programmatic Use

Block Parameter: PropagateVarSize

Type: character vector

Value: 'During execution' | 'Only when resetting'

Default: 'During execution'

Enable zero-crossing detection — Control zero-crossing detection

on (default) | off

Control zero-crossing detection.

on

Detect zero crossings.

off

Do not detect zero crossings.

Programmatic Use

Block Parameter: ZeroCross

Type: character vector

Value: 'on' | 'off'

Default: 'on'

See Also

Blocks

Resettable Subsystem | Subsystem

Topics

“Using Resettable Subsystems”

“Simulink Block Support for Variable-Size Signals”

Introduced in R2015a

Reset Function

Execute subsystem on model reset event

Library: Simulink / User-Defined Functions

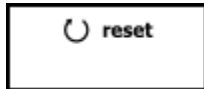

Description

The Reset Function block is a pre-configured Subsystem block that executes on a model reset event. By default, the Reset Function block includes an Event Listener block with **Event** set to **Reset**, a Constant block with **Constant value** set to **0**, and a State Writer block.

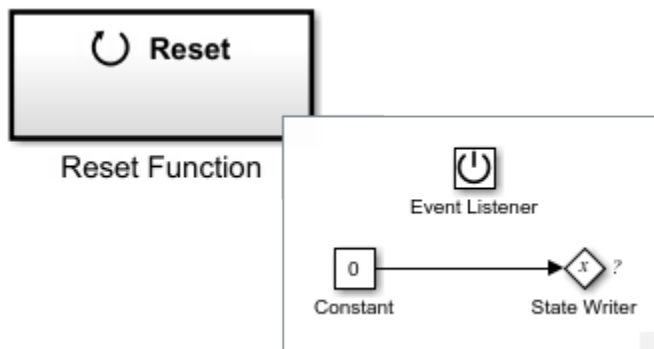

Replace the Constant block with source blocks that generate the state value for the State Writer block.

Conditionally executed subsystem blocks with output ports are fully supported within Reset Function blocks.

For a list of unsupported blocks and features, see “Initialize, Reset, and Terminate Function Limitations”.

A model can potentially have multiple Reset Function blocks with each block having a different **Event name**. Each of these reset events appear in the generated code as a different function.

You can select an Initialize Function, Reset Function, or Terminate Function block or a corresponding state owner block to highlight blocks related to it. To show a related block in an open diagram or new

tab, pause on the ellipsis that appears after selection. Then, select **Related Blocks**  from the action bar. When multiple blocks correspond to the selected block, a list of related blocks opens. You can filter the list of related blocks by entering a search term in the text box. After you select a related block from the list, window focus goes to the open diagram or new tab that shows the related block.

Block Characteristics

| | |
|-------------------|---|
| Data Types | Boolean ^a bus ^a double ^a enumerated ^a fixed point ^a half ^a integer ^a single ^a string ^a |
|-------------------|---|

| | |
|---------------------------------|----------------------|
| Direct Feedthrough | no |
| Multidimensional Signals | limited ^a |
| Variable-Size Signals | no |
| Zero-Crossing Detection | no |

a. Actual data type or capability support depends on block implementation.

Extended Capabilities

C/C++ Code Generation

Generate C and C++ code using Simulink® Coder™.

Actual code generation support depends on block implementation.

Fixed-Point Conversion

Design and simulate fixed-point systems using Fixed-Point Designer™.

Actual data type support depends on block implementation.

See Also

[Initialize Function](#) | [Terminate Function](#) | [Event Listener](#) | [State Reader](#) | [State Writer](#)

Topics

“Using Initialize, Reset, and Terminate Functions”

“Create Test Harness to Generate Function Calls”

“Generate Code That Responds to Initialize, Reset, and Terminate Events” (Simulink Coder)

Resettable Delay

Delay input signal by variable sample period and reset with external signal

Library: Simulink / Discrete
HDL Coder / Discrete

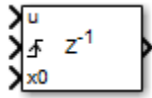

Description

The Resettable Delay block is a variant of the Delay block that has the source of the initial condition set to `Input port` and the external reset algorithm set to `Rising`, by default.

Ports

Input

u — Data input signal

scalar | vector

Input data signal delayed according to parameters settings.

Data Types: half | single | double | int8 | int16 | int32 | int64 | uint8 | uint16 | uint32 | uint64 | string | Boolean | fixed point | enumerated | bus

d — Delay length

scalar

Delay length specified as inherited from an input port. Enabled when you select the **Delay length: Source** parameter as `Input port`.

Data Types: half | single | double | int8 | int16 | int32 | int64 | uint8 | uint16 | uint32 | uint64 | fixed point

Enable — External enable signal

scalar

Enable signal that enables or disables execution of the block. To create this port, select the **Show enable port** parameter.

Data Types: single | double | int8 | int16 | int32 | int64 | uint8 | uint16 | uint32 | uint64 | Boolean | fixed point

External reset — External reset signal

scalar

External signal that resets execution of the block to the initial condition. To create this port, select the **External reset** parameter.

Data Types: single | double | int8 | int16 | int32 | int64 | uint8 | uint16 | uint32 | uint64 | Boolean | fixed point

x0 — Initial condition

scalar | vector

Initial condition specified as inherited from an input port. Enabled when you select the **Initial Condition: Source** parameter as `Input port`.

Data Types: `half` | `single` | `double` | `int8` | `int16` | `int32` | `int64` | `uint8` | `uint16` | `uint32` | `uint64` | `fixed point`

Output**Port_1 — Output signal**

scalar | vector

Output signal that is the input signal delayed by the length of time specified by the parameter **Delay length**. The initial value of the output signal depends on several conditions. See “Initial Block Output” on page 1-277.

Data Types: `half` | `single` | `double` | `int8` | `int16` | `int32` | `int64` | `uint8` | `uint16` | `uint32` | `uint64` | `Boolean` | `fixed point` | `enumerated` | `bus`

Parameters**Main****Delay length — Delay length**`Dialog` (default) | `Input port`

Specify whether to enter the delay length directly on the dialog box (fixed delay) or to inherit the delay from an input port (variable delay).

- If you set **Source** to `Dialog`, enter the delay length in the edit field under **Value**.
- If you set **Source** to `Input port`, verify that an upstream signal supplies a delay length for the `d` input port. You can also specify its maximum value by specifying the parameter **Upper limit**.

Specify the scalar delay length as a real, non-negative integer. An out-of-range or non-integer value in the dialog box (fixed delay) returns an error. An out-of-range value from an input port (variable delay) casts it into the range. A non-integer value from an input port (variable delay) truncates it to the integer.

Programmatic Use**Block Parameter:** `DelayLengthSource`**Type:** character vector**Values:** `'Dialog'` | `'Input port'` |**Default:** `'Dialog'`**Block Parameter:** `DelayLength`**Type:** character vector**Values:** scalar**Default:** `'2'`**Block Parameter:** `DelayLengthUpperLimit`**Type:** character vector**Values:** scalar**Default:** `'100'`

Initial condition — Initial condition

Input port (default) | Dialog

Specify whether to enter the initial condition directly on the dialog box or to inherit the initial condition from an input port.

- If you set **Source** to Dialog, enter the initial condition in the edit field under **Value**.
- If you set **Source** to Input port, verify that an upstream signal supplies an initial condition for the x0 input port.

Simulink converts offline the data type of **Initial condition** to the data type of the input signal u using a round-to-nearest operation and saturation.

Note When **State name must resolve to Simulink signal object** is selected on the **State Attributes** pane, the block copies the initial value of the signal object to the **Initial condition** parameter. However, when the source for **Initial condition** is Input port, the block ignores the initial value of the signal object.

Programmatic Use**Block Parameter:** InitialConditionSource**Type:** character vector**Values:** 'Dialog' | 'Input port' |**Default:** 'Input Port'**Block Parameter:** InitialCondition**Type:** character vector**Values:** scalar**Default:** ''**Input processing — Specify sample- or frame-based processing**

Elements as channels (sample based) (default) | Columns as channels (frame based)

Specify whether the block performs sample- or frame-based processing:

- Columns as channels (frame based) — Treat each column of the input as a separate channel (frame-based processing).

Note Frame-based processing requires a DSP System Toolbox license.

For more information, see “Sample- and Frame-Based Concepts” (DSP System Toolbox).

- Elements as channels (sample based) — Treat each element of the input as a separate channel (sample-based processing).

Use **Input processing** to specify whether the block performs sample- or frame-based processing. For more information about these two processing modes, see “Sample- and Frame-Based Concepts” (DSP System Toolbox).

Programmatic Use**Block Parameter:** InputProcessing**Type:** character vector**Values:** 'Columns as channels (frame based)' | 'Elements as channels (sample based)'

Default: 'Elements as channels (sample based)'

Use circular buffer for state – Circular buffer for storing state

off (default) | on

Select to use a circular buffer for storing the state in simulation and code generation. Otherwise, an array buffer stores the state.

Using a circular buffer can improve execution speed when the delay length is large. For an array buffer, the number of copy operations increases as the delay length goes up. For a circular buffer, the number of copy operations is constant for increasing delay length.

If one of the following conditions is true, an array buffer always stores the state because a circular buffer does not improve execution speed:

- For sample-based signals, the delay length is 1.
- For frame-based signals, the delay length is no larger than the frame size.

Programmatic Use

Block Parameter: UseCircularBuffer

Type: character vector

Values: 'off' | 'on'

Default: 'off'

Prevent direct feedthrough – Prevent direct feedthrough

off (default) | on

Select to increase the delay length from zero to the lower limit for the **Input processing** mode:

- For sample-based signals, increase the minimum delay length to 1.
- For frame-based signals, increase the minimum delay length to the frame length.

Selecting this check box prevents direct feedthrough from the input port, *u*, to the output port. However, this check box cannot prevent direct feedthrough from the initial condition port, *x0*, to the output port.

Dependency

To enable this parameter, set **Delay length: Source** to Input port.

Programmatic Use

Block Parameter: PreventDirectFeedthrough

Type: character vector

Values: 'off' | 'on'

Default: 'off'

Remove delay length check in generated code – Remove delay length out-of-range check

off (default) | on

Select to remove code that checks for out-of-range delay length.

| Check Box | Result | When to Use |
|-----------|--|----------------------------------|
| Selected | Generated code does not include conditional statements to check for out-of-range delay length. | For code efficiency |
| Cleared | Generated code includes conditional statements to check for out-of-range delay length. | For safety-critical applications |

Dependency

To enable this parameter, set **Delay length: Source** to Input port.

Programmatic Use

Block Parameter: RemoveDelayLengthCheckInGeneratedCode

Type: character vector

Values: 'off' | 'on'

Default: 'off'

Diagnostic for delay length — Diagnostic checks for delay length

None (default) | Warning | Error

Specify whether to produce a warning or error when the input d is less than the lower limit or greater than the **Delay length: Upper limit**. The lower limit depends on the setting for **Prevent direct feedthrough**.

- If the check box is cleared, the lower limit is zero.
- If the check box is selected, the lower limit is 1 for sample-based signals and frame length for frame-based signals.

Options for the diagnostic include:

- None — Simulink software takes no action.
- Warning — Simulink software displays a warning and continues the simulation.
- Error — Simulink software terminates the simulation and displays an error.

Dependency

To enable this parameter, set **Delay length: Source** to Input port.

Programmatic Use

Block Parameter: DiagnosticForDelayLength

Type: character vector

Values: 'None' | 'Warning' | 'Error'

Default: 'None'

Show enable port — Create enable port

off (default) | on

Select to control execution of this block with an enable port. The block is considered enabled when the input to this port is nonzero, and is disabled when the input is 0. The value of the input is checked at the same time step as the block execution.

Programmatic Use**Block Parameter:** ShowEnablePort**Type:** character vector**Values:** 'off' | 'on'**Default:** 'off'**External reset — External state reset**

Rising (default) | None | Falling | Either | Level | Level hold

Specify the trigger event to use to reset the states to the initial conditions.

| Reset Mode | Behavior |
|------------|--|
| None | No reset. |
| Rising | Reset on a rising edge. |
| Falling | Reset on a falling edge. |
| Either | Reset on either a rising or falling edge. |
| Level | Reset in either of these cases: <ul style="list-style-type: none"> when the reset signal is nonzero at the current time step when the reset signal value changes from nonzero at the previous time step to zero at the current time step |
| Level hold | Reset when the reset signal is nonzero at the current time step |

The reset signal must be a scalar of type single, double, boolean, or integer. Fixed point data types, except for `ufix1`, are not supported.

Programmatic Use**Block Parameter:** ExternalReset**Type:** character vector**Values:** 'None' | 'Rising' | 'Falling' | 'Either' | 'Level' | 'Level hold'**Default:** 'Rising'**Sample time (-1 for inherited) — Discrete interval between sample time hits**

-1 (default) | scalar

Specify the time interval between samples. To inherit the sample time, set this parameter to -1. This block supports discrete sample time, but not continuous sample time.

Programmatic Use**Block Parameter:** SampleTime**Type:** character vector**Value:** real scalar**Default:** '-1'**State Attributes****State name — Unique name for block state**

' ' (default) | alphanumeric string

Use this parameter to assign a unique name to the block state. The default is ' '. When this field is blank, no name is assigned. When using this parameter, remember these considerations:

- A valid identifier starts with an alphabetic or underscore character, followed by alphanumeric or underscore characters.
- The state name applies only to the selected block.

This parameter enables **State name must resolve to Simulink signal object** when you click **Apply**.

For more information, see “C Code Generation Configuration for Model Interface Elements” (Simulink Coder).

Programmatic Use

Block Parameter: StateName

Type: character vector

Values: unique name

Default: ' '

State name must resolve to Simulink signal object – Require state name resolve to a signal object

off (default) | on

Select this check box to require that the state name resolves to a Simulink signal object.

Dependencies

To enable this parameter, specify a value for **State name**. This parameter appears only if you set the model configuration parameter **Signal resolution** to a value other than None.

Programmatic Use

Block Parameter: StateMustResolveToSignalObject

Type: character vector

Values: 'off' | 'on'

Default: 'off'

Block Characteristics

| | |
|---------------------------------|--|
| Data Types | Boolean bus double enumerated fixed point half integer single string |
| Direct Feedthrough | yes |
| Multidimensional Signals | yes |
| Variable-Size Signals | yes |
| Zero-Crossing Detection | no |

Extended Capabilities

C/C++ Code Generation

Generate C and C++ code using Simulink® Coder™.

Consider using the Model Discretizer to map these continuous blocks into discrete equivalents that support code generation. From a model, in the **Apps** tab, under **Control Systems**, click **Model Discretizer**.

Not recommended for production code.

HDL Code Generation

Generate Verilog and VHDL code for FPGA and ASIC designs using HDL Coder™.

For information about HDL code generation, see the “HDL Code Generation” on page 1-286 section on the Delay page.

Fixed-Point Conversion

Design and simulate fixed-point systems using Fixed-Point Designer™.

See Also

Delay | Unit Delay | Variable Integer Delay

Topics

“Using Enabled Subsystems”

Introduced in R2012b

Resettable Subsystem

Subsystem whose block states reset with external trigger

Library: Simulink / Ports & Subsystems

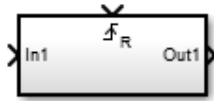

Description

The Resettable Subsystem block is a Subsystem block preconfigured as a starting point for creating a subsystem that resets the block states each time the control port receives a trigger signal. The behavior of the subsystem is controlled by a Reset block placed inside the subsystem.

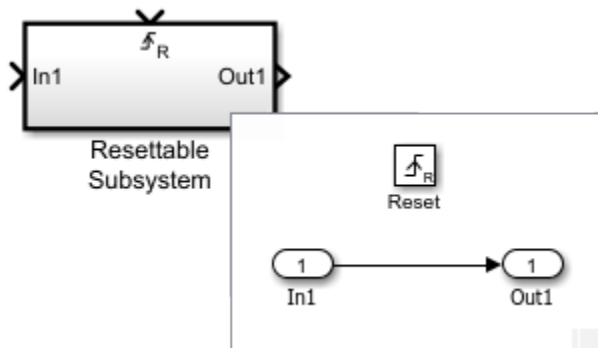

Ports

Input

In — Signal input to a subsystem block

scalar | vector | matrix

Placing an Inport block in a Subsystem block adds an external input port to the block. The port label matches the name of the Inport block.

Use Inport blocks to receive signals from the local environment.

Data Types: half | single | double | int8 | int16 | int32 | int64 | uint8 | uint16 | uint32 | uint64 | Boolean | fixed point | enumerated | bus

Reset — Control signal input to a subsystem block

scalar | vector | matrix

Placing a Reset block in a Subsystem block adds an external input port to the block and changes the block to a Resettable Subsystem block.

Data Types: single | double | int8 | int16 | int32 | int64 | uint8 | uint16 | uint32 | uint64 | Boolean | fixed point

Output

Out — Signal output from a subsystem

scalar | vector | matrix

Placing an Output block in a Subsystem block adds an output port from the block. The port label on the Subsystem block is the name of the Output block.

Use Output blocks to send signals to the local environment.

Data Types: half | single | double | int8 | int16 | int32 | int64 | uint8 | uint16 | uint32 | uint64 | Boolean | fixed_point | enumerated | bus

Block Characteristics

| | |
|---------------------------------|---|
| Data Types | Boolean ^a bus ^a double ^a enumerated ^a fixed_point ^a half ^a integer ^a single ^a string ^a |
| Direct Feedthrough | no |
| Multidimensional Signals | limited ^a |
| Variable-Size Signals | limited ^a |
| Zero-Crossing Detection | no |

a. Actual data type or capability support depends on block implementation.

Extended Capabilities

C/C++ Code Generation

Generate C and C++ code using Simulink® Coder™.

Actual code generation support depends on block implementation.

Fixed-Point Conversion

Design and simulate fixed-point systems using Fixed-Point Designer™.

Actual data type support depends on block implementation.

See Also

Blocks

Reset | Subsystem

Topics

“Using Resettable Subsystems”

Introduced in R2015a

Reshape

Change dimensionality of signal

Library: Simulink / Math Operations
HDL Coder / Math Operations



Description

The Reshape block changes the dimensionality of the input signal to a dimensionality that you specify, using the **Output dimensionality** parameter. For example, you can use the block to change an N -element vector to a 1-by- N or N -by-1 matrix signal.

Ports

Input

Port_1 — Input signal

scalar | vector | matrix

Input signal whose dimensions are changed based on the **Output dimensionality** parameter.

Data Types: half | single | double | int8 | int16 | int32 | int64 | uint8 | uint16 | uint32 | uint64 | Boolean | fixed point | enumerated | bus

Output

Port_1 — Output signal

scalar | vector | matrix

Output signal created with the dimensions specified in the **Output dimensionality** parameter.

Data Types: half | single | double | int8 | int16 | int32 | int64 | uint8 | uint16 | uint32 | uint64 | Boolean | fixed point | enumerated | bus

Parameters

Output dimensionality — Dimensions of output signal

1-D array (default) | Column vector (2-D) | Row vector (2-D) | Customize | Derive from reference input port

Specify the dimensionality of the output signal.

| Output Dimensionality | Description |
|----------------------------------|---|
| 1-D array | Converts a multidimensional array to a vector (1-D array) array signal. The output vector consists of the first column of the input matrix followed by the second column, and so on. (This option leaves a vector input unchanged.) |
| Column vector | Converts a vector, matrix, or multidimensional input signal to a column matrix, a M -by-1 matrix, where M is the number of elements in the input signal. For matrices, the conversion is done in column-major order. For multidimensional arrays, the conversion is done along the first dimension. |
| Row vector | Converts a vector, matrix, or multidimensional input signal to a row matrix, a 1-by- N matrix where N is the number of elements in the input signal. For matrices, the conversion is done in column-major order. For multidimensional arrays, the conversion is done along the first dimension. |
| Customize | Converts the input signal to an output signal whose dimensions you specify, using the Output dimensions parameter. |
| Derive from reference input port | Creates a second input port, Ref , on the block. Derives the dimensions of the output signal from the dimensions of the signal input to the Ref input port. Selecting this option disables the Output dimensions parameter. When you select this parameter, the input signals for both input ports, U and Ref , must have the same sampling mode (sample-based or frame-based). |

Programmatic Use**Block Parameter:** OutputDimensionality**Type:** character vector**Value:** '1-D array' | 'Column vector (2-D)' | 'Row vector (2-D)' | 'Customize' | 'Derive from reference input port'**Default:** '1-D array'**Output dimensions — Custom dimensions of output signal**

[1,1] (default) | [integer] | [integer, integer]

Specify the dimensions for the output signal. The value can be a one- or multi-element vector. A value of $[N]$ outputs a vector of size N . A value of $[M N]$ outputs an M -by- N matrix. The number of elements of the input signal must match the number of elements specified by the **Output dimensions** parameter. For multidimensional arrays, the conversion is done along the first dimension.

DependencyTo enable this parameter, set **Output dimensionality** to Customize.**Programmatic Use****Block Parameter:** OutputDimensions**Type:** character vector**Value:** '[integer, integer]' |**Default:** '[1,1]'

Block Characteristics

| | |
|---------------------------------|---|
| Data Types | Boolean bus double enumerated fixed point half integer single |
| Direct Feedthrough | yes |
| Multidimensional Signals | yes |
| Variable-Size Signals | yes |
| Zero-Crossing Detection | no |

Extended Capabilities

C/C++ Code Generation

Generate C and C++ code using Simulink® Coder™.

HDL Code Generation

Generate Verilog and VHDL code for FPGA and ASIC designs using HDL Coder™.

HDL Coder provides additional configuration options that affect HDL implementation and synthesized logic.

HDL Architecture

This block has a single, default HDL architecture.

HDL Block Properties

| | |
|----------------------------------|--|
| ConstrainedOutputPipeline | Number of registers to place at the outputs by moving existing delays within your design. Distributed pipelining does not redistribute these registers. The default is 0. For more details, see “ConstrainedOutputPipeline” (HDL Coder). |
| InputPipeline | Number of input pipeline stages to insert in the generated code. Distributed pipelining and constrained output pipelining can move these registers. The default is 0. For more details, see “InputPipeline” (HDL Coder). |
| OutputPipeline | Number of output pipeline stages to insert in the generated code. Distributed pipelining and constrained output pipelining can move these registers. The default is 0. For more details, see “OutputPipeline” (HDL Coder). |

Complex Data Support

This block supports code generation for complex signals.

FOR-GENERATE Loop Support

For this block, HDL Coder generates code using FOR-GENERATE loop when you set the target language to VHDL.

The loop unrolled code is generated when target language is Verilog. For more information, see “Unroll For-Generate Loops in VHDL code” (HDL Coder)

PLC Code Generation

Generate Structured Text code using Simulink® PLC Coder™.

Fixed-Point Conversion

Design and simulate fixed-point systems using Fixed-Point Designer™.

See Also

Squeeze

Topics

“Group Nonvirtual Buses in Arrays of Buses”

Introduced before R2006a

Rocker Switch

Change parameter or variable value using switch with customizable appearance

Library: Simulink / Dashboard / Customizable Blocks



Description

Use the Rocker Switch block to change the value of the connected variable or parameter before or during simulation. When you use the Rocker Switch block in the Customizable Blocks library, you can customize the appearance of the block to look like a real switch in your system and configure any number of states to customize the behavior. For example, you could design a three-way toggle switch or a switch that represents a gear shift. Use the Rocker Switch block with other dashboard blocks to create an interactive dashboard for your model.

Double-clicking the Rocker Switch block does not open its dialog box during simulation or when the block is selected. To edit the block parameters, you can use the Property Inspector or open the block dialog box by:

- Double-clicking the block when the block is not selected and the model is not simulating.
- Right-clicking the block and selecting **Block Parameters** from the context menu.

Customize Rocker Switch Blocks

When you add a Rocker Switch block to your model, the block is preconfigured with a default design. You can use the block with the default design or customize the appearance of the block. When you design a switch using the Rocker Switch block, you can add any number of states to the block. For each state, you can:

- Add an image that defines the appearance of the block in that state.
- Specify the value for the block to assign to the connected variable or parameter.
- Specify the label text, color, and position for the state and whether the label is visible on the block design.
- Configure the size and position of the click area for the state. When you click the click area for a state, the block transitions to that state.

You can also design the block background and foreground, which apply for all states. To configure the foreground for the block, upload a foreground image. To configure the background for the block, you can upload a background image or use a solid background color.

To customize the appearance of the block, use design mode. You can enter design mode in one of three ways after selecting the block:

- On the **Button** tab, under **Design**, click **Edit**.
- In the **Property Inspector**, on the **Design** tab, click **Edit Design**.
- Pause on the ellipsis that appears above the block and click the **Edit Custom Block** button.

Design mode gives you access to block parameters and settings that allow you to customize the appearance of the block. You can use the toolbar above the block to configure the image, the icon, and the label color and opacity for each state. For more customization options, use the **Design** tab in the Property Inspector.

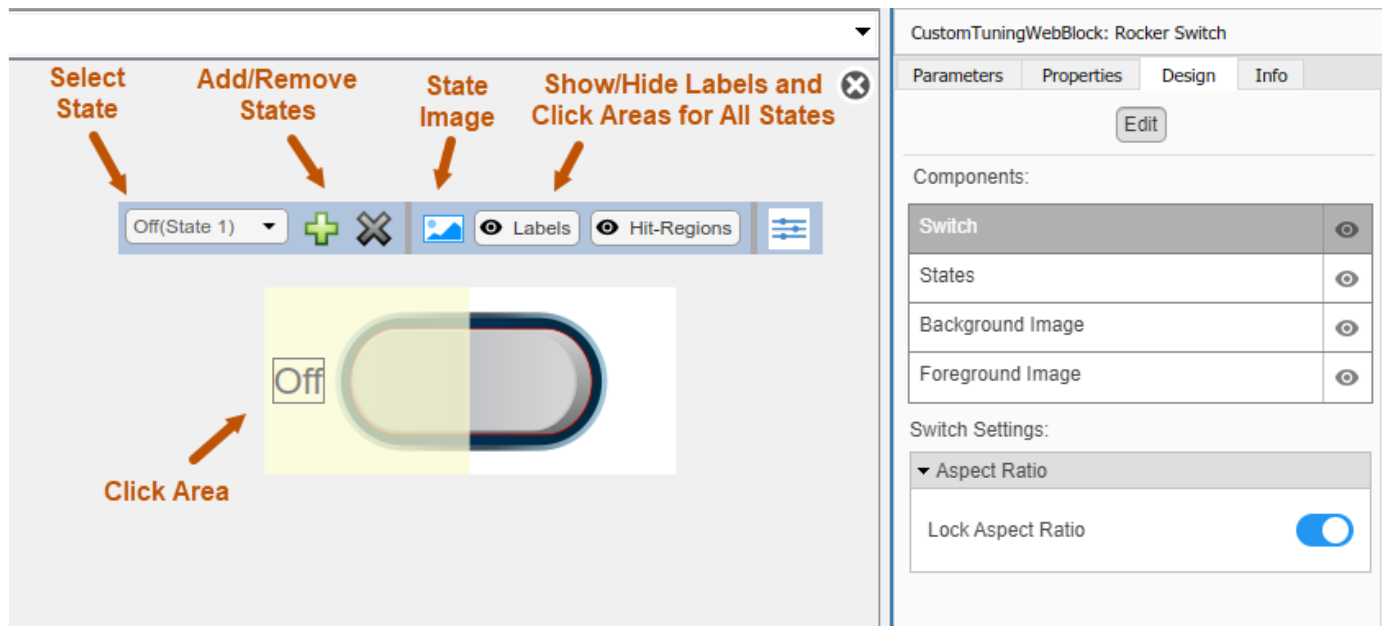

When you finish designing the switch, click **Exit** in the upper-right of the canvas to exit design mode.

Connect Dashboard Blocks

Dashboard blocks do not use ports to connect to model elements. To connect dashboard blocks to variables and block parameters, use connect mode. Connect mode facilitates the process of connecting dashboard blocks in your model, especially when you want to connect multiple blocks at once. To connect a single dashboard block, you can also use the **Connection** table in the block dialog box.

Tip You can modify dashboard block connections in your model during normal and accelerator mode simulations.

Note Dashboard blocks cannot connect to variables until you update the model diagram. To connect dashboard blocks to variables or modify variable values between opening your model and running a simulation, update the model diagram using **Ctrl+D**.

To enter connect mode, select the block. Then, on the block tab, click **Connect**. In connect mode, when you select one or more blocks, a list of parameters and variables available for connection appears. Select a variable or parameter from the list to connect to the selected dashboard block.

When the value of the selected variable or block parameter is nonscalar, use the text box at the bottom of the **Connection** table to specify the element you want to connect to the dashboard block. To connect to an element of a vector, matrix, or array, specify the element index, for example, 3 or (1, 3). To connect to an element in a bus or structure, specify the element in the context of the bus

or structure hierarchy by using dots to indicate different levels in the hierarchy, and omit the top level. For example, specify `a.b` to connect to scalar element `b` of the structure or bus `a` nested inside the selected composite variable or parameter.

To connect another dashboard block, pause on another dashboard block and click the **Connect** button above it. Then, make a selection of signals and blocks in your model and choose a model element to connect.

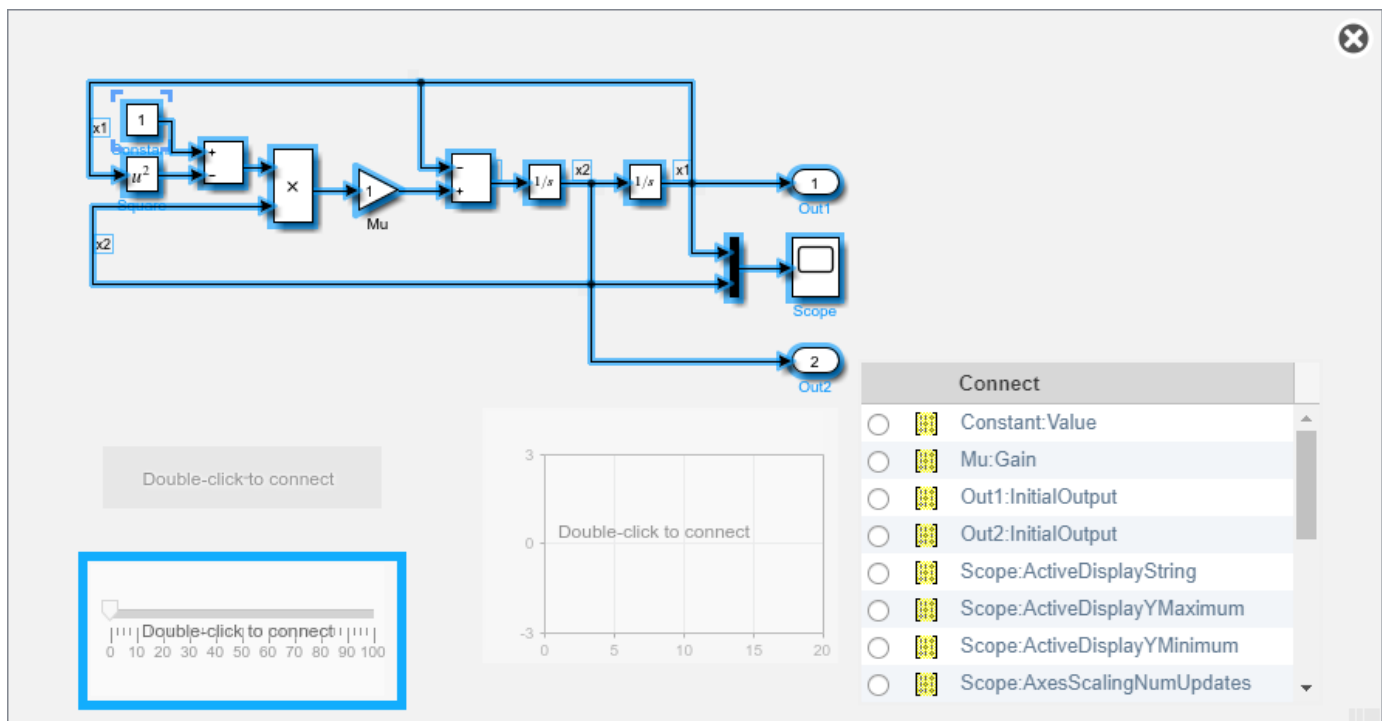

When you finish connecting the dashboard blocks in your model, on the block tab, click **Done Connecting**.

Tip You can hide the message shown on unconnected blocks using the `set_param` function with the `ShowInitialText` block parameter. The message also disappears when you connect the block.

Parameter Logging

Tunable parameters connected to dashboard blocks are logged to the Simulation Data Inspector, where you can view the parameter values along with logged signal data. You can access logged parameter data in the MATLAB workspace by exporting the parameter data from the Simulation Data Inspector by using the UI or the `Simulink.sdi.exportRun` function. For more information about exporting data using the Simulation Data Inspector UI, see “Export Data to the Workspace or a File”. The parameter data is stored in a `Simulink.SimulationData.Parameter` object, accessible as an element in the exported `Simulink.SimulationData.Dataset`.

Limitations

- Except for the Dashboard Scope block and the Display block, dashboard blocks can only connect to real scalar signals.

- The toolbar does not support blocks that are inside a panel.
- You cannot use the **Connection** table in the block dialog to connect a dashboard block to a block that is commented out. When you connect a dashboard block to a commented block using connect mode, the dashboard block does not display the connected value until the you uncomment the block.
- Dashboard blocks cannot connect to model elements inside referenced models.
- When you simulate a model hierarchy, dashboard blocks inside referenced models do not update.
- Dashboard blocks do not support rapid accelerator simulation.
- When you connect a dashboard block to a variable or parameter during simulation, the data for that variable or parameter is not logged to the Simulation Data Inspector. To log variable and parameter data to the Simulation Data Inspector, connect the dashboard block to the variable or parameter prior to simulation.
- When you simulate a model in external mode with the **Default parameter behavior** set to **Inlined**, dashboard blocks can appear to change parameter and variable values. However, the change does not propagate to the simulation. For example, Gain blocks display changes made to the **Gain** parameter using the dashboard blocks, but the **Gain** value used in the simulation does not change.

Parameters

Connection — Select a variable or block parameter to connect

variable and parameter connection options

Select the variable or block parameter to control using the **Connection** table. To connect the block to a signal:

- 1 Make a selection in the model that includes one or more blocks.
- 2 Select the variable or parameter you want to connect.

When the value of the selected variable or block parameter is nonscalar, use the text box at the bottom of the **Connection** table to specify the element you want to connect to the dashboard block. To connect to an element of a vector, matrix, or array, specify the element index, for example, 3 or (1, 3). To connect to an element in a bus or structure, specify the element in the context of the bus or structure hierarchy by using dots to indicate different levels in the hierarchy, and omit the top level. For example, specify a.b to connect to scalar element b of the structure or bus a nested inside the selected composite variable or parameter.

- 3 Click **Apply**.

To facilitate understanding and debugging your model, you can connect Dashboard blocks to variables and parameters in your model during simulation.

Note To see workspace variables in the connection table, update the model diagram using **Ctrl+D**.

Programmatic Use

To programmatically connect a dashboard block to a tunable parameter or a variable, use a `Simulink.HMI.ParamSourceInfo` object. The `Simulink.HMI.ParamSourceInfo` object contains four properties. Some of the properties apply to connecting dashboard blocks to parameters, and

some apply to connecting dashboard blocks to variables. Not all fields have a value for a connection because a given dashboard block connects to either a parameter or a variable.

Block Parameter: Binding

Type: Simulink.HMI.ParamSourceInfo

Default: []

States — Block state labels and values

scalar and character vector

Each state pairs a **State Value** with a **State Label**. When the block is in a given state, it assigns the **State Value** for that state to the connected variable or parameter. You can use the **State Label** to display the value assigned to the connected variable or parameter on the block or to provide a descriptive text label. Using the **Design** tab in the Property Inspector, you can choose to show or hide the specified **State Label** in the block design.

By default, the switch has two states:

- In the **Off** state, the block assigns the connected variable or parameter a value of 0.
- In the **On** state, the block assigns the connected variable or parameter a value of 1.

You can use a customizable switch block to design a block with any number of states. Click the + button to add a state.

Tips

You can also configure the states for the block in design mode, by using the toolbar above the block or the **Design** tab in the Property Inspector.

Label — Block label position

Top (default) | Bottom | Hide

Position of the block label. When the block is connected to an element in the model, the label is the name of the connected element.

Programmatic Use

Block Parameter: LabelPosition

Type: character vector

Values: 'Top' | 'Bottom' | 'Hide'

Default: 'Top'

Lock Aspect Ratio — Whether to maintain block aspect ratio

on (default) | off

Whether to maintain the block aspect ratio when resizing the block and when you specify a new background image.

Block Characteristics

| | |
|---------------------------------|----------------------------------|
| Data Types | double half integer single |
| Direct Feedthrough | no |
| Multidimensional Signals | no |

| | |
|--------------------------------|----|
| Variable-Size Signals | no |
| Zero-Crossing Detection | no |

Tips

- When you want to design a circular switch that distributes the state labels and the click areas that cause state transitions on an arc, consider using the Rotary Switch block.
- To design a control that applies values to a connected variable or parameter from a continuous range, use the Knob, Horizontal Slider, or Vertical Slider blocks.

Extended Capabilities

C/C++ Code Generation

Generate C and C++ code using Simulink® Coder™.

Dashboard blocks are ignored for code generation.

See Also

Slider Switch | Toggle Switch

Introduced in R2021b

Rocker Switch

Toggle parameter between two values

Library: Simulink / Dashboard



Description

The Rocker Switch block toggles the value of the connected block parameter between two values during simulation. For example, you can connect the Rocker Switch block to a Switch block in your model and change its state during simulation. Use the Rocker Switch block with other Dashboard blocks to create an interactive dashboard for your model.

Double-clicking the Rocker Switch block does not open its dialog box during simulation and when the block is selected. To edit the block's parameters, you can use the **Property Inspector**, or you can right-click the block and select **Block Parameters** from the context menu.

Connect Dashboard Blocks

Dashboard blocks do not use ports to connect to model elements. To connect dashboard blocks to variables and block parameters, use connect mode. Connect mode facilitates the process of connecting dashboard blocks in your model, especially when you want to connect multiple blocks at once. To connect a single dashboard block, you can also use the **Connection** table in the block dialog box.

Tip You can modify dashboard block connections in your model during normal and accelerator mode simulations.

Note Dashboard blocks cannot connect to variables until you update the model diagram. To connect dashboard blocks to variables or modify variable values between opening your model and running a simulation, update the model diagram using **Ctrl+D**.

To enter connect mode, select the block. Then, on the block tab, click **Connect**. In connect mode, when you select one or more blocks, a list of parameters and variables available for connection appears. Select a variable or parameter from the list to connect to the selected dashboard block.

When the value of the selected variable or block parameter is nonscalar, use the text box at the bottom of the **Connection** table to specify the element you want to connect to the dashboard block. To connect to an element of a vector, matrix, or array, specify the element index, for example, 3 or (1, 3). To connect to an element in a bus or structure, specify the element in the context of the bus or structure hierarchy by using dots to indicate different levels in the hierarchy, and omit the top level. For example, specify a.b to connect to scalar element b of the structure or bus a nested inside the selected composite variable or parameter.

To connect another dashboard block, pause on another dashboard block and click the **Connect** button above it. Then, make a selection of signals and blocks in your model and choose a model element to connect.

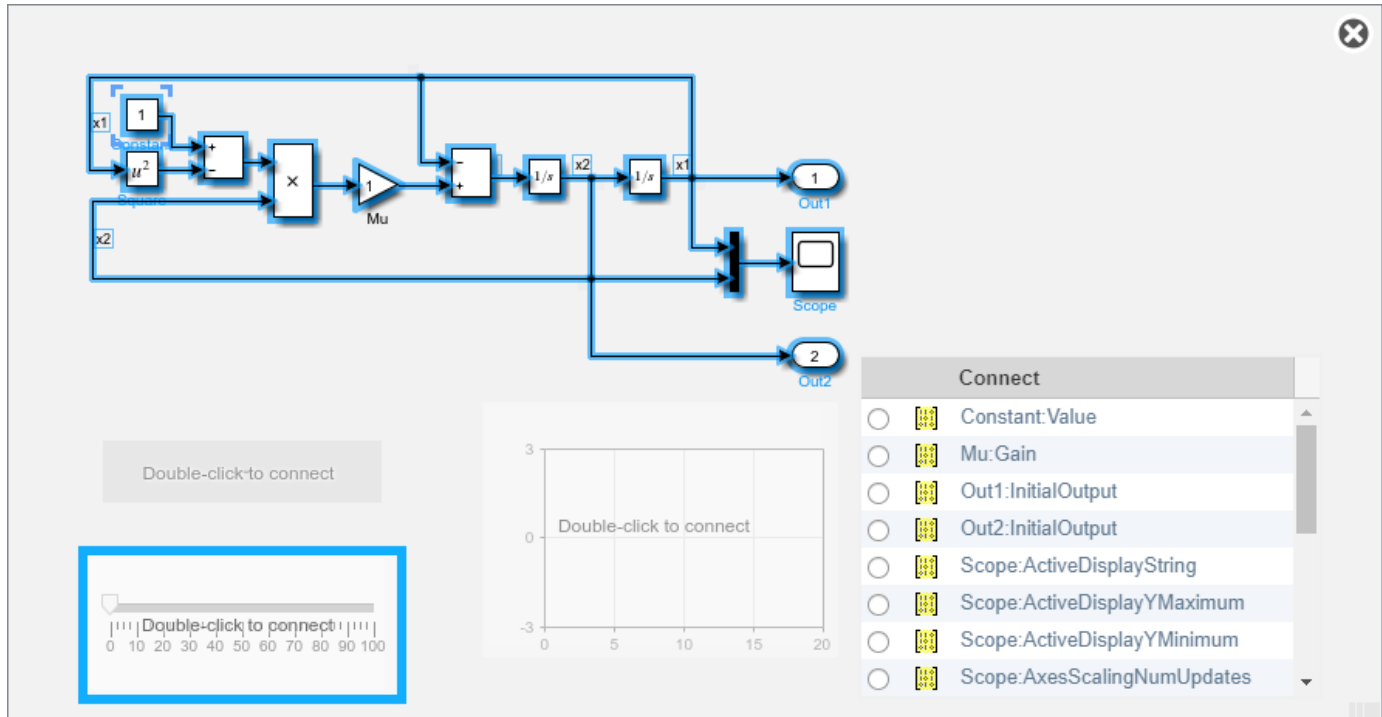

When you finish connecting the dashboard blocks in your model, on the block tab, click **Done Connecting**.

Tip You can hide the message shown on unconnected blocks using the `set_param` function with the `ShowInitialText` block parameter. The message also disappears when you connect the block.

Parameter Logging

Tunable parameters connected to dashboard blocks are logged to the Simulation Data Inspector, where you can view the parameter values along with logged signal data. You can access logged parameter data in the MATLAB workspace by exporting the parameter data from the Simulation Data Inspector by using the UI or the `Simulink.sdi.exportRun` function. For more information about exporting data using the Simulation Data Inspector UI, see “Export Data to the Workspace or a File”. The parameter data is stored in a `Simulink.SimulationData.Parameter` object, accessible as an element in the exported `Simulink.SimulationData.Dataset`.

Limitations

- Except for the Dashboard Scope block and the Display block, dashboard blocks can only connect to real scalar signals.
- The toolstrip does not support blocks that are inside a panel.
- You cannot use the **Connection** table in the block dialog to connect a dashboard block to a block that is commented out. When you connect a dashboard block to a commented block using connect

mode, the dashboard block does not display the connected value until the you uncomment the block.

- Dashboard blocks cannot connect to model elements inside referenced models.
- When you simulate a model hierarchy, dashboard blocks inside referenced models do not update.
- Dashboard blocks do not support rapid accelerator simulation.
- When you connect a dashboard block to a variable or parameter during simulation, the data for that variable or parameter is not logged to the Simulation Data Inspector. To log variable and parameter data to the Simulation Data Inspector, connect the dashboard block to the variable or parameter prior to simulation.
- When you simulate a model in external mode with the **Default parameter behavior** set to **Inlined**, dashboard blocks can appear to change parameter and variable values. However, the change does not propagate to the simulation. For example, Gain blocks display changes made to the **Gain** parameter using the dashboard blocks, but the **Gain** value used in the simulation does not change.

Parameters

Connection — Select a variable or block parameter to connect

variable and parameter connection options

Select the variable or block parameter to control using the **Connection** table. To connect the block to a signal:

- 1 Make a selection in the model that includes one or more blocks.
- 2 Select the variable or parameter you want to connect.

When the value of the selected variable or block parameter is nonscalar, use the text box at the bottom of the **Connection** table to specify the element you want to connect to the dashboard block. To connect to an element of a vector, matrix, or array, specify the element index, for example, 3 or (1, 3). To connect to an element in a bus or structure, specify the element in the context of the bus or structure hierarchy by using dots to indicate different levels in the hierarchy, and omit the top level. For example, specify a.b to connect to scalar element b of the structure or bus a nested inside the selected composite variable or parameter.

- 3 Click **Apply**.

To facilitate understanding and debugging your model, you can connect Dashboard blocks to variables and parameters in your model during simulation.

Note To see workspace variables in the connection table, update the model diagram using **Ctrl+D**.

Programmatic Use

To programmatically connect a dashboard block to a tunable parameter or a variable, use a `Simulink.HMI.ParamSourceInfo` object. The `Simulink.HMI.ParamSourceInfo` object contains four properties. Some of the properties apply to connecting dashboard blocks to parameters, and some apply to connecting dashboard blocks to variables. Not all fields have a value for a connection because a given dashboard block connects to either a parameter or a variable.

Block Parameter: Binding

Type: Simulink.HMI.ParamSourceInfo

Default: []

States — Pair values and labels

scalar and character vector

Pairs of values to assign to the connected variable or parameter and text to display on the block. Switches have two states — **Top** and **Bottom** — one corresponding to each switch position. Each state contains a **Value** and a **Label**.

- **Value** — Value to assign to the connected variable or parameter when the switch is in the corresponding position.
- **Label** — Text to display on the block for the corresponding position.

This table describes the default configuration for the block.

States

| Position | State Value | State Label |
|----------|-------------|-------------|
| Top | 0 | on |
| Bottom | 1 | off |

Programmatic Use

To configure the **States** for the block programmatically, specify the value of the **States** parameter as a structure array containing two elements with fields:

- **Value** — Scalar double value for the state.
- **Label** — String or character array to use as the label for the switch position.

```
topState.Value = 0;
topState.Label = 'Off';
bottomState.Value = 1;
bottomState.Label = 'On';
switchStates = [topState bottomState];
```

Block Parameter: States

Type: two element array of structures

Label — Block label position

Top (default) | Bottom | Hide

Position of the block label. When the block is connected to an element in the model, the label is the name of the connected element.

Programmatic Use

Block Parameter: LabelPosition

Type: character vector

Values: 'Top' | 'Bottom' | 'Hide'

Default: 'Top'

Block Characteristics

| | |
|---------------------------------|----------------------------------|
| Data Types | double half integer single |
| Direct Feedthrough | no |
| Multidimensional Signals | no |
| Variable-Size Signals | no |
| Zero-Crossing Detection | no |

Extended Capabilities

C/C++ Code Generation

Generate C and C++ code using Simulink® Coder™.

Dashboard blocks are ignored for code generation.

See Also

Rotary Switch | Slider Switch | Toggle Switch

Topics

“Tune and Visualize Your Model with Dashboard Blocks”

“Decide How to Visualize Simulation Data”

Introduced in R2015a

Rotary Switch

Change parameter or variable value using rotary switch with customizable appearance

Library: Simulink / Dashboard / Customizable Blocks



Description

Use the Rotary Switch block to change the value of the connected variable or parameter before or during simulation. When you use the Rotary Switch block in the Customizable Blocks library, you can customize the appearance of the block to look like a real rotary switch in your system. Use the Rotary Switch block with other dashboard blocks to create an interactive dashboard for your model.

Double-clicking the Rotary Switch block does not open its dialog box during simulation or when the block is selected. To edit the block parameters, you can use the Property Inspector or open the block dialog box by:

- Double-clicking the block when the block is not selected and the model is not simulating.
- Right-clicking the block and selecting **Block Parameters** from the context menu.

Customize Rotary Switch Blocks

When you add a Rotary Switch block to your model, the block is preconfigured with a default design. You can use the block with the default design or customize the appearance of the block.

When you design a rotary switch using the Rotary Switch block, you configure:

- The block background.

You can upload a background image or specify a solid background color.

- The handle that rotates to indicate the state of the block.

After you add a handle image, you can rotate the image in 90 degree increments and change the handle size and position.

- The circular arc along which the block evenly distributes the states.

Set the start and end points of the arc by specifying a start angle and the arc angle.

- The label radius that sets the position for the state labels.
- The number of states for the block.
- The labels for each state, which are visible on the block.

To change the color of the labels, on the **Format** tab, under **Style**, click the arrow on the **Foreground** button and select a color. You can select from a palette of standard colors or click

Custom Colors  to specify a custom color.

- The value the block assigns to the connected variable or parameter for each state.

You can also add a foreground image to the design.

To customize the appearance of the block, use design mode. You can enter design mode in one of three ways after selecting the block:

- On the **Button** tab, under **Design**, click **Edit**.
- In the **Property Inspector**, on the **Design** tab, click **Edit Design**.
- Pause on the ellipsis that appears above the block and click the **Edit Custom Block** button.

Design mode gives you access to block parameters and settings that allow you to customize the appearance of the block. You can use the toolbar above the block to configure the image, the icon, and the label color and opacity for each state. For more customization options, use the **Design** tab in the Property Inspector.

When you finish designing the rotary switch, click **Exit** in the upper-right of the canvas to exit design mode.

Connect Dashboard Blocks

Dashboard blocks do not use ports to connect to model elements. To connect dashboard blocks to variables and block parameters, use connect mode. Connect mode facilitates the process of connecting dashboard blocks in your model, especially when you want to connect multiple blocks at once. To connect a single dashboard block, you can also use the **Connection** table in the block dialog box.

Tip You can modify dashboard block connections in your model during normal and accelerator mode simulations.

Note Dashboard blocks cannot connect to variables until you update the model diagram. To connect dashboard blocks to variables or modify variable values between opening your model and running a simulation, update the model diagram using **Ctrl+D**.

To enter connect mode, select the block. Then, on the block tab, click **Connect**. In connect mode, when you select one or more blocks, a list of parameters and variables available for connection appears. Select a variable or parameter from the list to connect to the selected dashboard block.

When the value of the selected variable or block parameter is nonscalar, use the text box at the bottom of the **Connection** table to specify the element you want to connect to the dashboard block. To connect to an element of a vector, matrix, or array, specify the element index, for example, 3 or (1, 3). To connect to an element in a bus or structure, specify the element in the context of the bus or structure hierarchy by using dots to indicate different levels in the hierarchy, and omit the top level. For example, specify `a.b` to connect to scalar element `b` of the structure or bus `a` nested inside the selected composite variable or parameter.

To connect another dashboard block, pause on another dashboard block and click the **Connect** button above it. Then, make a selection of signals and blocks in your model and choose a model element to connect.

The screenshot displays the Simulink dashboard in connect mode. The main workspace shows a Simulink model with several blocks and signals. A 'Connect' panel is open on the right, listing available variables and parameters for connection. The panel includes a search bar and a list of items with radio buttons for selection. A 'Double-click to connect' tooltip is visible over a scope block in the model.

| Connect | |
|-----------------------|------------------------------|
| <input type="radio"/> | Constant: Value |
| <input type="radio"/> | Mu: Gain |
| <input type="radio"/> | Out1: InitialOutput |
| <input type="radio"/> | Out2: InitialOutput |
| <input type="radio"/> | Scope: ActiveDisplayString |
| <input type="radio"/> | Scope: ActiveDisplayYMaximum |
| <input type="radio"/> | Scope: ActiveDisplayYMinimum |
| <input type="radio"/> | Scope: AxesScalingNumUpdates |

When you finish connecting the dashboard blocks in your model, on the block tab, click **Done Connecting**.

Tip You can hide the message shown on unconnected blocks using the `set_param` function with the `ShowInitialText` block parameter. The message also disappears when you connect the block.

Parameter Logging

Tunable parameters connected to dashboard blocks are logged to the Simulation Data Inspector, where you can view the parameter values along with logged signal data. You can access logged parameter data in the MATLAB workspace by exporting the parameter data from the Simulation Data Inspector by using the UI or the `Simulink.sdi.exportRun` function. For more information about exporting data using the Simulation Data Inspector UI, see “Export Data to the Workspace or a File”. The parameter data is stored in a `Simulink.SimulationData.Parameter` object, accessible as an element in the exported `Simulink.SimulationData.Dataset`.

Limitations

- Except for the Dashboard Scope block and the Display block, dashboard blocks can only connect to real scalar signals.
- The toolstrip does not support blocks that are inside a panel.
- You cannot use the **Connection** table in the block dialog to connect a dashboard block to a block that is commented out. When you connect a dashboard block to a commented block using connect mode, the dashboard block does not display the connected value until the you uncomment the block.
- Dashboard blocks cannot connect to model elements inside referenced models.
- When you simulate a model hierarchy, dashboard blocks inside referenced models do not update.
- Dashboard blocks do not support rapid accelerator simulation.
- When you connect a dashboard block to a variable or parameter during simulation, the data for that variable or parameter is not logged to the Simulation Data Inspector. To log variable and parameter data to the Simulation Data Inspector, connect the dashboard block to the variable or parameter prior to simulation.
- When you simulate a model in external mode with the **Default parameter behavior** set to **Inlined**, dashboard blocks can appear to change parameter and variable values. However, the change does not propagate to the simulation. For example, Gain blocks display changes made to the **Gain** parameter using the dashboard blocks, but the **Gain** value used in the simulation does not change.

Parameters

Connection — Select a variable or block parameter to connect

variable and parameter connection options

Select the variable or block parameter to control using the **Connection** table. To connect the block to a signal:

- 1 Make a selection in the model that includes one or more blocks.
- 2 Select the variable or parameter you want to connect.

When the value of the selected variable or block parameter is nonscalar, use the text box at the bottom of the **Connection** table to specify the element you want to connect to the dashboard

block. To connect to an element of a vector, matrix, or array, specify the element index, for example, 3 or (1,3). To connect to an element in a bus or structure, specify the element in the context of the bus or structure hierarchy by using dots to indicate different levels in the hierarchy, and omit the top level. For example, specify a.b to connect to scalar element b of the structure or bus a nested inside the selected composite variable or parameter.

3 Click **Apply**.

To facilitate understanding and debugging your model, you can connect Dashboard blocks to variables and parameters in your model during simulation.

Note To see workspace variables in the connection table, update the model diagram using **Ctrl+D**.

Programmatic Use

To programmatically connect a dashboard block to a tunable parameter or a variable, use a `Simulink.HMI.ParamSourceInfo` object. The `Simulink.HMI.ParamSourceInfo` object contains four properties. Some of the properties apply to connecting dashboard blocks to parameters, and some apply to connecting dashboard blocks to variables. Not all fields have a value for a connection because a given dashboard block connects to either a parameter or a variable.

Block Parameter: Binding

Type: `Simulink.HMI.ParamSourceInfo`

Default: []

States — Block state labels and values

scalar and character vector

Each state pairs a **State Value** with a **State Label**. When the block is in a given state, it assigns the **State Value** for that state to the connected variable or parameter. You can use the **State Label** to display the value assigned to the connected variable or parameter on the block or to provide a descriptive text label.

By default, the switch has these states.

States

| State Value | State Label |
|-------------|-------------|
| 0 | Off |
| 1 | Low |
| 2 | Medium |
| 3 | High |

To add a state, click the + button. To remove a state, click the - button.

Tips

You can also configure the states for the block in design mode by using the toolbar above the block or the **Design** tab in the Property Inspector.

Enumerated Data Type — Specify state values and labels using an enumerated data type

off (default) | on

You can use an enumerated data type that pairs a numeric value with each enumeration to configure the state values and labels for the block. To specify the states for the block using an enumerated data type, first select the **Enumerated Data Type** option. Then, specify the name of the enumerated data type in the text box. The definition for the specified enumerated data type must be saved on the MATLAB path or in the base workspace.

Label — Block label position

Top (default) | Bottom | Hide

Position of the block label. When the block is connected to an element in the model, the label is the name of the connected element.

Programmatic Use

Block Parameter: LabelPosition

Type: character vector

Values: 'Top' | 'Bottom' | 'Hide'

Default: 'Top'

Lock Aspect Ratio — Whether to maintain block aspect ratio

on (default) | off

Whether to maintain the block aspect ratio when resizing the block and when you specify a new background image.

Block Characteristics

| | |
|---------------------------------|----------------------------------|
| Data Types | double half integer single |
| Direct Feedthrough | no |
| Multidimensional Signals | no |
| Variable-Size Signals | no |
| Zero-Crossing Detection | no |

Tips

- The Rotary Switch block allows you to design a circular control, with the state labels and the click areas that cause state transitions distributed along an arc. For more flexibility in the design of a control block with several states, use one of the customizable switch blocks. Each block is preconfigured with two states, but you can add and configure any number of states as required by your design.
 - Rocker Switch
 - Slider Switch
 - Toggle Switch
- To design a control that applies values to a connected variable or parameter from a continuous range, use the Knob, Horizontal Slider, or Vertical Slider blocks.

Extended Capabilities

C/C++ Code Generation

Generate C and C++ code using Simulink® Coder™.

Dashboard blocks are ignored for code generation.

See Also

Rocker Switch | Slider Switch | Toggle Switch

Introduced in R2021b

Rotary Switch

Switch parameter to set values on dial

Library: Simulink / Dashboard



Description

The Rotary Switch changes the value of the connected block parameter to several specified values during simulation. For example, you can connect the Rotary Switch block to the amplitude or frequency of an input signal in your model and change its characteristics during simulation. Use the Rotary Switch block with other Dashboard blocks to create an interactive dashboard to control your model.

Double-clicking the Rotary Switch block does not open its dialog box during simulation and when the block is selected. To edit the block's parameters, you can use the **Property Inspector**, or you can right-click the block and select **Block Parameters** from the context menu.

Connect Dashboard Blocks

Dashboard blocks do not use ports to connect to model elements. To connect dashboard blocks to variables and block parameters, use connect mode. Connect mode facilitates the process of connecting dashboard blocks in your model, especially when you want to connect multiple blocks at once. To connect a single dashboard block, you can also use the **Connection** table in the block dialog box.

Tip You can modify dashboard block connections in your model during normal and accelerator mode simulations.

Note Dashboard blocks cannot connect to variables until you update the model diagram. To connect dashboard blocks to variables or modify variable values between opening your model and running a simulation, update the model diagram using **Ctrl+D**.

To enter connect mode, select the block. Then, on the block tab, click **Connect**. In connect mode, when you select one or more blocks, a list of parameters and variables available for connection appears. Select a variable or parameter from the list to connect to the selected dashboard block.

When the value of the selected variable or block parameter is nonscalar, use the text box at the bottom of the **Connection** table to specify the element you want to connect to the dashboard block. To connect to an element of a vector, matrix, or array, specify the element index, for example, 3 or (1, 3). To connect to an element in a bus or structure, specify the element in the context of the bus or structure hierarchy by using dots to indicate different levels in the hierarchy, and omit the top

level. For example, specify `a.b` to connect to scalar element `b` of the structure or bus `a` nested inside the selected composite variable or parameter.

To connect another dashboard block, pause on another dashboard block and click the **Connect** button above it. Then, make a selection of signals and blocks in your model and choose a model element to connect.

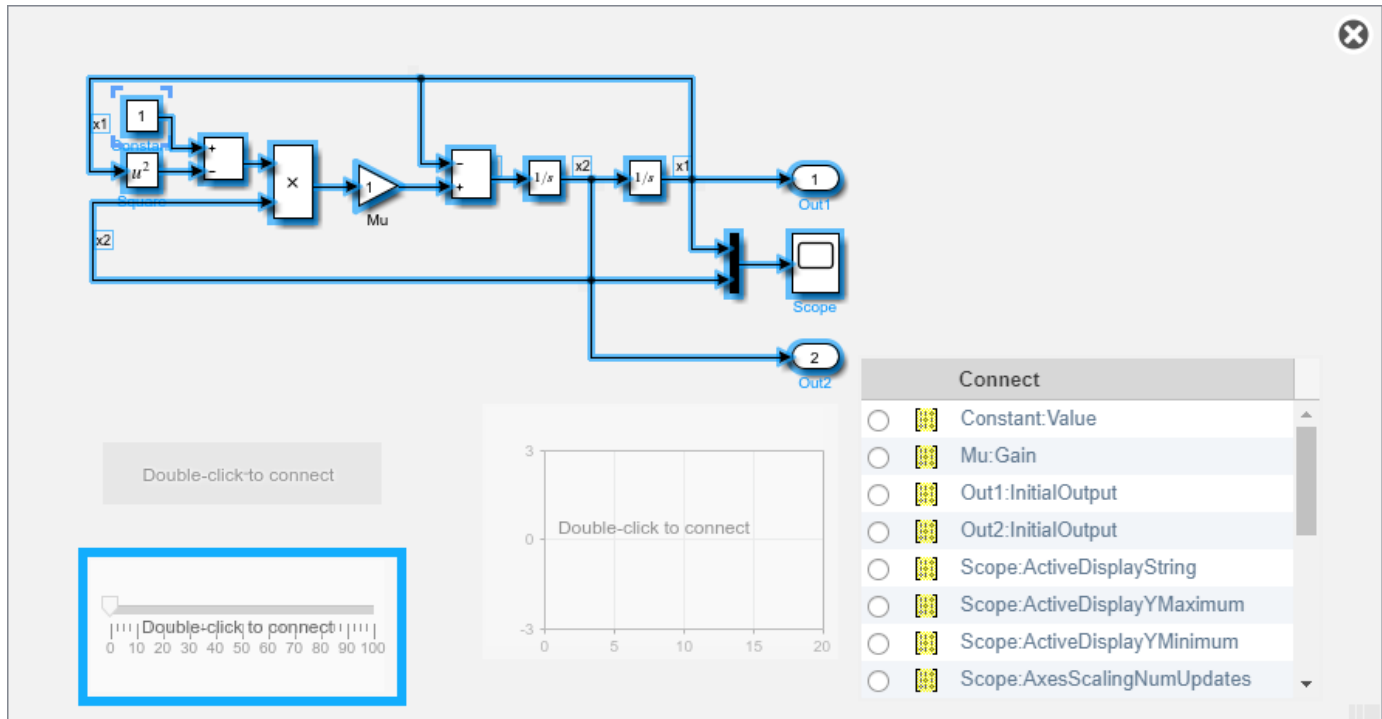

When you finish connecting the dashboard blocks in your model, on the block tab, click **Done Connecting**.

Tip You can hide the message shown on unconnected blocks using the `set_param` function with the `ShowInitialText` block parameter. The message also disappears when you connect the block.

Parameter Logging

Tunable parameters connected to dashboard blocks are logged to the Simulation Data Inspector, where you can view the parameter values along with logged signal data. You can access logged parameter data in the MATLAB workspace by exporting the parameter data from the Simulation Data Inspector by using the UI or the `Simulink.sdi.exportRun` function. For more information about exporting data using the Simulation Data Inspector UI, see “Export Data to the Workspace or a File”. The parameter data is stored in a `Simulink.SimulationData.Parameter` object, accessible as an element in the exported `Simulink.SimulationData.Dataset`.

Limitations

- Except for the Dashboard Scope block and the Display block, dashboard blocks can only connect to real scalar signals.

- The toolstrip does not support blocks that are inside a panel.
- You cannot use the **Connection** table in the block dialog to connect a dashboard block to a block that is commented out. When you connect a dashboard block to a commented block using connect mode, the dashboard block does not display the connected value until the you uncomment the block.
- Dashboard blocks cannot connect to model elements inside referenced models.
- When you simulate a model hierarchy, dashboard blocks inside referenced models do not update.
- Dashboard blocks do not support rapid accelerator simulation.
- When you connect a dashboard block to a variable or parameter during simulation, the data for that variable or parameter is not logged to the Simulation Data Inspector. To log variable and parameter data to the Simulation Data Inspector, connect the dashboard block to the variable or parameter prior to simulation.
- When you simulate a model in external mode with the **Default parameter behavior** set to **Inlined**, dashboard blocks can appear to change parameter and variable values. However, the change does not propagate to the simulation. For example, Gain blocks display changes made to the **Gain** parameter using the dashboard blocks, but the **Gain** value used in the simulation does not change.

Parameters

Connection — Select a variable or block parameter to connect

variable and parameter connection options

Select the variable or block parameter to control using the **Connection** table. To connect the block to a signal:

- 1 Make a selection in the model that includes one or more blocks.
- 2 Select the variable or parameter you want to connect.

When the value of the selected variable or block parameter is nonscalar, use the text box at the bottom of the **Connection** table to specify the element you want to connect to the dashboard block. To connect to an element of a vector, matrix, or array, specify the element index, for example, 3 or (1, 3). To connect to an element in a bus or structure, specify the element in the context of the bus or structure hierarchy by using dots to indicate different levels in the hierarchy, and omit the top level. For example, specify a.b to connect to scalar element b of the structure or bus a nested inside the selected composite variable or parameter.

- 3 Click **Apply**.

To facilitate understanding and debugging your model, you can connect Dashboard blocks to variables and parameters in your model during simulation.

Note To see workspace variables in the connection table, update the model diagram using **Ctrl+D**.

Programmatic Use

To programmatically connect a dashboard block to a tunable parameter or a variable, use a `Simulink.HMI.ParamSourceInfo` object. The `Simulink.HMI.ParamSourceInfo` object contains four properties. Some of the properties apply to connecting dashboard blocks to parameters, and

some apply to connecting dashboard blocks to variables. Not all fields have a value for a connection because a given dashboard block connects to either a parameter or a variable.

Block Parameter: Binding

Type: Simulink.HMI.ParamSourceInfo

Default: []

States — Position labels and values

scalar and character vector

Pairs of numeric values to assign to the connected variable or parameter with labels for the block. A State consists of a **State Value** and a **State Label**.

- **State Value** — Value assigned to the connected variable or parameter when the Rotary Switch block is positioned at the corresponding **State Label**.
- **State Label** — Label for the switch position. You can use the **State Label** to display the value the connected variable or parameter takes when the Rotary Switch block points to the **State Label**, or you can use a descriptive text label.

Click the + button to add **States**.

The default configuration for the block includes these **States**:

States

| State Value | State Label |
|-------------|-------------|
| 0 | Off |
| 1 | Low |
| 2 | Medium |
| 3 | High |

Programmatic Use

To configure the **States** for the block programmatically, specify the value of the **States** parameter as a structure array with fields:

- **Value** — Scalar double value for the state.
- **Label** — String or character array to use as the label for the switch position.

Include a structure element in the array for each state you want to specify for the block.

```
state1.Value = 1;
state1.Label = 'State 1';
state2.Value = 2;
state2.Label = 'State 2';
states = [state1 state2];
```

Block Parameter: States

Type: structure array

Enumerated Data Type — Specify state values and labels using an enumerated data type

off (default) | on

You can use an enumerated data type that pairs a numeric value with each enumeration to configure the state values and labels for the block. To specify the states for the block using an enumerated data

type, first select the **Enumerated Data Type** option. Then, specify the name of the enumerated data type in the text box. The definition for the specified enumerated data type must be saved on the MATLAB path or in the base workspace.

Example: `myEnumType`

Programmatic Use

To programmatically specify the state labels and values for the block using an enumerated data type, specify 'on' for the `UseEnumeratedDataType` parameter and the name of the enumerated data type for the `EnumeratedDataType` parameter.

Block Parameter: `UseEnumeratedDataType`

Type: string or character array

Values: 'on' | 'off'

Default: 'off'

Block Parameter: `EnumeratedDataType`

Type: string or character array

Default: ''

Label — Block label position

Top (default) | Bottom | Hide

Position of the block label. When the block is connected to an element in the model, the label is the name of the connected element.

Programmatic Use

Block Parameter: `LabelPosition`

Type: character vector

Values: 'Top' | 'Bottom' | 'Hide'

Default: 'Top'

Block Characteristics

| | |
|---------------------------------|----------------------------------|
| Data Types | double half integer single |
| Direct Feedthrough | no |
| Multidimensional Signals | no |
| Variable-Size Signals | no |
| Zero-Crossing Detection | no |

Extended Capabilities

C/C++ Code Generation

Generate C and C++ code using Simulink® Coder™.

Dashboard blocks are ignored for code generation.

See Also

Rocker Switch | Slider Switch | Toggle Switch | Knob | Slider

Topics

“Tune and Visualize Your Model with Dashboard Blocks”

“Decide How to Visualize Simulation Data”

Introduced in R2015a

Rounding Function

Apply rounding function to signal

Library: Simulink / Math Operations



Description

The Rounding Function block rounds each element of the input signal to produce the output signal.

You select the type of rounding from the **Function** parameter list. The name of the selected function appears on the block.

Tip Use the Rounding Function block when you want vector or matrix output.

Ports

Input

Port_1 – Input signal

scalar | vector | matrix

Input signal to which the rounding function is applied.

Data Types: single | double

Output

Port_1 – Output signal

scalar | vector | matrix

Output signal after the rounding function is applied to the input signal. The output signal has the same dimensions and data type as the input. Each element of the output signal is the result of applying the selected rounding function to the corresponding element of the input signal.

Data Types: single | double

Parameters

Function – Rounding function

floor (default) | ceil | round | fix

Choose the rounding function applied to the input signal.

| Rounding function | Rounds each element of the input signal |
|-------------------|---|
| floor | To the nearest integer value towards minus infinity |
| ceil | To the nearest integer towards positive infinity |
| round | To the nearest integer |
| fix | To the nearest integer towards zero |

Programmatic Use**Block Parameter:** Operator**Type:** character vector**Values:** 'floor' | 'ceil' | 'round' | 'fix'**Default:** 'floor'**Sample time — Specify sample time as a value other than -1**

-1 (default) | scalar | vector

Specify the sample time as a value other than -1. For more information, see “Specify Sample Time”.

Dependencies

This parameter is not visible unless it is explicitly set to a value other than -1. To learn more, see “Blocks for Which Sample Time Is Not Recommended”.

Programmatic Use**Block Parameter:** SampleTime**Type:** character vector**Values:** scalar or vector**Default:** '-1'**Block Characteristics**

| | |
|---------------------------------|-----------------|
| Data Types | double single |
| Direct Feedthrough | yes |
| Multidimensional Signals | no |
| Variable-Size Signals | yes |
| Zero-Crossing Detection | no |

Extended Capabilities**C/C++ Code Generation**

Generate C and C++ code using Simulink® Coder™.

HDL Code Generation

Generate Verilog and VHDL code for FPGA and ASIC designs using HDL Coder™.

HDL Coder provides additional configuration options that affect HDL implementation and synthesized logic.

HDL Code Generation Requirements

HDL code generation for the block requires that you use single data types as inputs to the block, and enable the native floating point mode. In the Configuration Parameters dialog box, on the **HDL Code Generation > Floating Point** pane, for **Library**, select **Native Floating Point**. To learn more about using the native floating-point mode, see “Getting Started with HDL Coder Native Floating-Point Support” (HDL Coder) and “Generate Target-Independent HDL Code with Native Floating-Point” (HDL Coder).

HDL Architecture

This block has a single, default HDL architecture.

HDL Block Properties

| General | |
|----------------------------------|--|
| ConstrainedOutputPipeline | Number of registers to place at the outputs by moving existing delays within your design. Distributed pipelining does not redistribute these registers. The default is 0. For more details, see “ConstrainedOutputPipeline” (HDL Coder). |
| InputPipeline | Number of input pipeline stages to insert in the generated code. Distributed pipelining and constrained output pipelining can move these registers. The default is 0. For more details, see “InputPipeline” (HDL Coder). |
| OutputPipeline | Number of output pipeline stages to insert in the generated code. Distributed pipelining and constrained output pipelining can move these registers. The default is 0. For more details, see “OutputPipeline” (HDL Coder). |
| Native Floating Point | |
| LatencyStrategy | Specify whether to map the blocks in your design to <code>inherit</code> , <code>Max</code> , <code>Min</code> , <code>Zero</code> , or <code>Custom</code> for the floating-point operator. The default is <code>inherit</code> . See also “LatencyStrategy” (HDL Coder). |
| NFPCustomLatency | To specify a value, set LatencyStrategy to <code>Custom</code> . HDL Coder adds latency equal to the value that you specify for the NFPCustomLatency setting. See also “NFPCustomLatency” (HDL Coder). |

Complex Data Support

This block supports code generation for complex signals.

PLC Code Generation

Generate Structured Text code using Simulink® PLC Coder™.

See Also

Introduced before R2006a

Saturation

Limit input signal to the upper and lower saturation values

Library: Simulink / Commonly Used Blocks
 Simulink / Discontinuities
 HDL Coder / Discontinuities

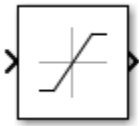

Description

The Saturation block produces an output signal that is the value of the input signal bounded to the upper and lower saturation values. The upper and lower limits are specified by the parameters **Upper limit** and **Lower limit**.

| Input | Output |
|--|-------------|
| $\text{Lower limit} \leq \text{Input value} \leq \text{Upper limit}$ | Input value |
| Input value < Lower limit | Lower limit |
| Input value > Upper limit | Upper limit |

Ports

Input

Port_1 – Input signal

scalar | vector

The input signal to the saturation algorithm.

Data Types: double | single | int8 | int16 | int32 | int64 | uint8 | uint16 | uint32 | uint64 | fixed point

Output

Port_1 – Output signal

scalar | vector

Output signal that is the value of the input signal, upper saturation limit, or lower saturation limit.

Data Types: double | single | int8 | int16 | int32 | int64 | uint8 | uint16 | uint32 | uint64 | fixed point

Parameters

Main

Upper limit – Upper saturation boundary for the input signal

0.5 (default) | scalar | vector

Specify the upper bound on the input signal. If the input signal is greater than this boundary, then the output signal is set to this saturation value. The **Upper limit** parameter is converted to the output data type using round-to-nearest and saturation. **Upper limit** must be greater than the **Output minimum** parameter and less than the **Output maximum** parameter.

Programmatic Use

Block Parameter: UpperLimit

Type: character vector

Value: real scalar or vector

Default: '0.5'

Lower limit – Lower saturation boundary for the input signal

-0.5 (default) | scalar | vector

Specify the lower bound on the input signal. If the input signal is less than this boundary, then the output signal is set to this saturation value. The **Lower limit** parameter is converted to the output data type using round-to-nearest and saturation. **Lower limit** must be greater than the **Output minimum** parameter and less than the **Output maximum** parameter.

Programmatic Use

Block Parameter: LowerLimit

Type: character vector

Value: real scalar or vector

Default: '-0.5'

Treat as gain when linearizing – Specify the gain value

On (default) | Boolean

Select this check box to cause the commands to treat the gain as 1. The linearization commands in Simulink software treat this block as a gain in state space. Clear the box to have the commands treat the gain as 0.

Programmatic Use

Block Parameter: LinearizeAsGain

Type: character vector

Values: 'off' | 'on'

Default: 'on'

Enable zero-crossing detection – Enable zero-crossing detection

on (default) | Boolean

Select to enable zero-crossing detection. For more information, see “Zero-Crossing Detection” in the Simulink documentation.

Programmatic Use

Block Parameter: ZeroCross

Type: character vector, string

Values: 'off' | 'on'

Default: 'on'

Sample time – Specify sample time as a value other than -1

-1 (default) | scalar | vector

Specify the sample time as a value other than -1. For more information, see “Specify Sample Time”.

Dependencies

This parameter is not visible unless it is explicitly set to a value other than -1. To learn more, see “Blocks for Which Sample Time Is Not Recommended”.

Programmatic Use

Block Parameter: SampleTime

Type: character vector

Values: scalar or vector

Default: '-1'

Signal Attributes

Click the **Show data type assistant** button  to display the **Data Type Assistant**, which helps you set the data type attributes. For more information, see “Specify Data Types Using Data Type Assistant”.

Output minimum — Minimum output value for range checking

[] (default) | scalar

Lower value of the output range that Simulink checks.

Simulink uses the minimum to perform:

- Parameter range checking (see “Specify Minimum and Maximum Values for Block Parameters”) for some blocks.
- Simulation range checking (see “Specify Signal Ranges” and “Enable Simulation Range Checking”).
- Automatic scaling of fixed-point data types.
- Optimization of the code that you generate from the model. This optimization can remove algorithmic code and affect the results of some simulation modes such as SIL or external mode. For more information, see “Optimize using the specified minimum and maximum values” (Embedded Coder).

Note Output minimum does not saturate or clip the actual output signal. Use the Saturation block instead.

Programmatic Use

Block Parameter: OutMin

Type: character vector

Values: '[]' | scalar

Default: '[]'

Output maximum — Maximum output value for range checking

[] (default) | scalar

Upper value of the output range that Simulink checks.

Simulink uses the maximum value to perform:

- Parameter range checking (see “Specify Minimum and Maximum Values for Block Parameters”) for some blocks.

- Simulation range checking (see “Specify Signal Ranges” and “Enable Simulation Range Checking”).
- Automatic scaling of fixed-point data types.
- Optimization of the code that you generate from the model. This optimization can remove algorithmic code and affect the results of some simulation modes such as SIL or external mode. For more information, see “Optimize using the specified minimum and maximum values” (Embedded Coder).

Note **Output maximum** does not saturate or clip the actual output signal. Use the Saturation block instead.

Programmatic Use

Block Parameter: OutMax

Type: character vector

Values: '[]' | scalar

Default: '[]'

Output data type — Specify the output data type

Inherit: Same as input (default) | Inherit: Inherit via back propagation | double | single | int8 | int32 | uint32 | int64 | uint64 | fixdt(1,16,2^0,0) | <data type expression> | ...

Choose the data type for the output. The type can be inherited, specified directly, or expressed as a data type object such as Simulink.NumericType.

Programmatic Use

Block Parameter: OutDataTypeStr

Type: character vector

Values: 'Inherit: Same as input', 'Inherit: Inherit via back propagation', 'single', 'int8', 'uint8', int16, 'uint16', 'int32', 'uint32', 'int64', 'uint64', fixdt(1,16,0), fixdt(1,16,2^0,0), fixdt(1,16,2^0,0). '<data type expression>'

Default: 'Inherit: Same as input'

Lock output data type setting against changes by the fixed-point tools — Prevent fixed-point tools from overriding Output data type

off (default) | on

Select this parameter to prevent the fixed-point tools from overriding the **Output** data type you specify on the block. For more information, see “Use Lock Output Data Type Setting” (Fixed-Point Designer).

Programmatic Use

Block Parameter: LockScale

Type: character vector

Values: 'off' | 'on'

Default: 'off'

Integer rounding mode — Specify the rounding mode for fixed-point operations

Floor (default) | Ceiling | Convergent | Nearest | Round | Simplest | Zero

Choose one of these rounding modes.

Ceiling

Rounds both positive and negative numbers toward positive infinity. Equivalent to the MATLAB `ceil` function.

Convergent

Rounds number to the nearest representable value. If a tie occurs, rounds to the nearest even integer. Equivalent to the Fixed-Point Designer `convergent` function.

Floor

Rounds both positive and negative numbers toward negative infinity. Equivalent to the MATLAB `floor` function.

Nearest

Rounds number to the nearest representable value. If a tie occurs, rounds toward positive infinity. Equivalent to the Fixed-Point Designer `nearest` function.

Round

Rounds number to the nearest representable value. If a tie occurs, rounds positive numbers toward positive infinity and rounds negative numbers toward negative infinity. Equivalent to the Fixed-Point Designer `round` function.

Simplest

Automatically chooses between round toward floor and round toward zero to generate rounding code that is as efficient as possible.

Zero

Rounds number toward zero. Equivalent to the MATLAB `fix` function.

Programmatic Use

Block Parameter: `RndMeth`

Type: character vector

Values: `'Ceiling' | 'Convergent' | 'Floor' | 'Nearest' | 'Round' | 'Simplest' | 'Zero'`

Default: `'Floor'`

See Also

For more information, see “Rounding” (Fixed-Point Designer).

Block Characteristics

| | |
|---------------------------------|--|
| Data Types | <code>double fixed point integer single</code> |
| Direct Feedthrough | <code>yes</code> |
| Multidimensional Signals | <code>no</code> |
| Variable-Size Signals | <code>no</code> |
| Zero-Crossing Detection | <code>yes</code> |

Extended Capabilities**C/C++ Code Generation**

Generate C and C++ code using Simulink® Coder™.

HDL Code Generation

Generate Verilog and VHDL code for FPGA and ASIC designs using HDL Coder™.

HDL Coder provides additional configuration options that affect HDL implementation and synthesized logic.

HDL Architecture

This block has a single, default HDL architecture.

HDL Block Properties

| | |
|----------------------------------|--|
| ConstrainedOutputPipeline | Number of registers to place at the outputs by moving existing delays within your design. Distributed pipelining does not redistribute these registers. The default is 0. For more details, see “ConstrainedOutputPipeline” (HDL Coder). |
| InputPipeline | Number of input pipeline stages to insert in the generated code. Distributed pipelining and constrained output pipelining can move these registers. The default is 0. For more details, see “InputPipeline” (HDL Coder). |
| OutputPipeline | Number of output pipeline stages to insert in the generated code. Distributed pipelining and constrained output pipelining can move these registers. The default is 0. For more details, see “OutputPipeline” (HDL Coder). |

PLC Code Generation

Generate Structured Text code using Simulink® PLC Coder™.

Fixed-Point Conversion

Design and simulate fixed-point systems using Fixed-Point Designer™.

See Also

Saturation Dynamic | Backlash

Introduced before R2006a

Saturation Dynamic

Limit input signal to dynamic upper and lower saturation values

Library: Simulink / Discontinuities
HDL Coder / Discontinuities



Description

The Saturation Dynamic block produces an output signal that is the value of the input signal bounded to the saturation values from the input ports **up** and **lo**.

| Input | Output |
|--------------------------------------|-------------|
| $lo \leq \text{Input value} \leq up$ | Input value |
| Input value < lo | Lower limit |
| Input value > up | Upper limit |

Ports

Input

u – Input signal

scalar | vector

The input signal to the saturation algorithm.

Data Types: double | single | int8 | int16 | int32 | int64 | uint8 | uint16 | uint32 | uint64 | fixed point

up – Signal that provides the upper saturation limit

scalar | vector

Dynamic value providing the upper saturation limit. When the input is greater than **up** then the output value is bound to **up**.

Data Types: double | single | int8 | int16 | int32 | int64 | uint8 | uint16 | uint32 | uint64 | fixed point

lo – Signal that provides the lower saturation limit

scalar | vector

Dynamic value providing the lower saturation limit. When the input is less than **lo** then the output value is bound to **lo**.

Data Types: double | single | int8 | int16 | int32 | int64 | uint8 | uint16 | uint32 | uint64 | fixed point

Output

y — Output signal

scalar | vector

Output signal that is the value of the input signal, upper saturation limit, or lower saturation limit.

Data Types: double | single | int8 | int16 | int32 | int64 | uint8 | uint16 | uint32 | uint64 | fixed point

Parameters

To edit the parameters for the Saturation Dynamic block, double-click the block icon.

Click the **Show data type assistant** button  to display the **Data Type Assistant**, which helps you set the data type attributes. For more information, see “Specify Data Types Using Data Type Assistant”.

Output minimum — Minimum output value for range checking

[] (default) | scalar

Lower value of the output range that Simulink checks.

Simulink uses the minimum to perform:

- Parameter range checking (see “Specify Minimum and Maximum Values for Block Parameters”) for some blocks.
- Simulation range checking (see “Specify Signal Ranges” and “Enable Simulation Range Checking”).
- Automatic scaling of fixed-point data types.
- Optimization of the code that you generate from the model. This optimization can remove algorithmic code and affect the results of some simulation modes such as SIL or external mode. For more information, see “Optimize using the specified minimum and maximum values” (Embedded Coder).

Note **Output minimum** does not saturate or clip the actual output signal. Use the Saturation block instead.

Programmatic Use

Block Parameter: OutMin

Type: character vector

Values: '[]' | scalar

Default: '[]'

Output maximum — Maximum output value for range checking

[] (default) | scalar

Upper value of the output range that Simulink checks.

Simulink uses the maximum value to perform:

- Parameter range checking (see “Specify Minimum and Maximum Values for Block Parameters”) for some blocks.
- Simulation range checking (see “Specify Signal Ranges” and “Enable Simulation Range Checking”).
- Automatic scaling of fixed-point data types.
- Optimization of the code that you generate from the model. This optimization can remove algorithmic code and affect the results of some simulation modes such as SIL or external mode. For more information, see “Optimize using the specified minimum and maximum values” (Embedded Coder).

Note Output maximum does not saturate or clip the actual output signal. Use the Saturation block instead.

Programmatic Use

Block Parameter: OutMax

Type: character vector

Values: '[]' | scalar

Default: '[]'

Output data type — Specify the output data type

Inherit: Same as input (default) | Inherit: Inherit via back propagation | double | single | int8 | int32 | uint32 | int64 | uint64 | fixdt(1,16,2^0,0) | <data type expression> | ...

Choose the data type for the output. The type can be inherited, specified directly, or expressed as a data type object such as Simulink.NumericType.

Programmatic Use

Block Parameter: OutDataTypeStr

Type: character vector

Values: 'Inherit: Same as input', 'Inherit: Inherit via back propagation', 'single', 'int8', 'uint8', 'int16', 'uint16', 'int32', 'uint32', 'int64', 'uint64', 'fixdt(1,16,0)', 'fixdt(1,16,2^0,0)', 'fixdt(1,16,2^0,0)'. '<data type expression>'

Default: 'Inherit: Same as input'

Lock output data type setting against changes by the fixed-point tools — Prevent fixed-point tools from overriding Output data type

off (default) | on

Select this parameter to prevent the fixed-point tools from overriding the **Output** data type you specify on the block. For more information, see “Use Lock Output Data Type Setting” (Fixed-Point Designer).

Programmatic Use

Block Parameter: LockScale

Type: character vector

Values: 'off' | 'on'

Default: 'off'

Integer rounding mode — Specify the rounding mode for fixed-point operations

Floor (default) | Ceiling | Convergent | Nearest | Round | Simplest | Zero

Choose one of these rounding modes.

Ceiling

Rounds both positive and negative numbers toward positive infinity. Equivalent to the MATLAB `ceil` function.

Convergent

Rounds number to the nearest representable value. If a tie occurs, rounds to the nearest even integer. Equivalent to the Fixed-Point Designer `convergent` function.

Floor

Rounds both positive and negative numbers toward negative infinity. Equivalent to the MATLAB `floor` function.

Nearest

Rounds number to the nearest representable value. If a tie occurs, rounds toward positive infinity. Equivalent to the Fixed-Point Designer `nearest` function.

Round

Rounds number to the nearest representable value. If a tie occurs, rounds positive numbers toward positive infinity and rounds negative numbers toward negative infinity. Equivalent to the Fixed-Point Designer `round` function.

Simplest

Automatically chooses between round toward floor and round toward zero to generate rounding code that is as efficient as possible.

Zero

Rounds number toward zero. Equivalent to the MATLAB `fix` function.

Programmatic Use

Block Parameter: `RndMeth`

Type: character vector

Values: `'Ceiling'` | `'Convergent'` | `'Floor'` | `'Nearest'` | `'Round'` | `'Simplest'` | `'Zero'`

Default: `'Floor'`

See Also

For more information, see “Rounding” (Fixed-Point Designer).

Saturate on integer overflow — Choose the behavior when integer overflow occurs

`off` (default) | `on`

| Action | Reasons for Taking This Action | What Happens for Overflows | Example |
|-------------------------------|---|---|---|
| Select this check box. | Your model has possible overflow, and you want explicit saturation protection in the generated code. | Overflows saturate to either the minimum or maximum value that the data type can represent. | The maximum value that the <code>int8</code> (signed, 8-bit integer) data type can represent is 127. Any block operation result greater than this maximum value causes overflow of the 8-bit integer. With the check box selected, the block output saturates at 127. Similarly, the block output saturates at a minimum output value of -128. |
| Do not select this check box. | You want to optimize efficiency of your generated code. You want to avoid overspecifying how a block handles out-of-range signals. For more information, see "Troubleshoot Signal Range Errors". | Overflows wrap to the appropriate value that is representable by the data type. | The maximum value that the <code>int8</code> (signed, 8-bit integer) data type can represent is 127. Any block operation result greater than this maximum value causes overflow of the 8-bit integer. With the check box cleared, the software interprets the overflow-causing value as <code>int8</code> , which can produce an unintended result. For example, a block result of 130 (binary 1000 0010) expressed as <code>int8</code> , is -126. |

When you select this check box, saturation applies to every internal operation on the block, not just the output or result. Usually, the code generation process can detect when overflow is not possible. In this case, the code generator does not produce saturation code.

Programmatic Use

Block Parameter: DoSatur

Type: character vector

Value: 'off' | 'on'

Default: 'off'

Block Characteristics

| | |
|---------------------------------|--|
| Data Types | Boolean ^a double fixed point integer single |
| Direct Feedthrough | no |
| Multidimensional Signals | no |
| Variable-Size Signals | no |

| | |
|--------------------------------|----|
| Zero-Crossing Detection | no |
|--------------------------------|----|

- a. This block is not recommended for use with Boolean signals.

Extended Capabilities

C/C++ Code Generation

Generate C and C++ code using Simulink® Coder™.

HDL Code Generation

Generate Verilog and VHDL code for FPGA and ASIC designs using HDL Coder™.

HDL Coder provides additional configuration options that affect HDL implementation and synthesized logic.

HDL Architecture

This block has a single, default HDL architecture.

HDL Block Properties

| | |
|----------------------------------|--|
| ConstrainedOutputPipeline | Number of registers to place at the outputs by moving existing delays within your design. Distributed pipelining does not redistribute these registers. The default is 0. For more details, see “ConstrainedOutputPipeline” (HDL Coder). |
| InputPipeline | Number of input pipeline stages to insert in the generated code. Distributed pipelining and constrained output pipelining can move these registers. The default is 0. For more details, see “InputPipeline” (HDL Coder). |
| OutputPipeline | Number of output pipeline stages to insert in the generated code. Distributed pipelining and constrained output pipelining can move these registers. The default is 0. For more details, see “OutputPipeline” (HDL Coder). |

PLC Code Generation

Generate Structured Text code using Simulink® PLC Coder™.

Fixed-Point Conversion

Design and simulate fixed-point systems using Fixed-Point Designer™.

See Also

Saturation

Introduced before R2006a

Scan String

Scan input string and convert to signals per specified format

Library: Simulink / String

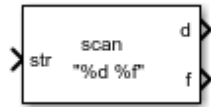

Description

The Scan String block scans an input string and converts it to signals per the format specified by the **Format** parameter. The block converts values to their decimal (base 10) representation and outputs the results as numeric or string signals. Use this block when you want to deconstruct a string, for example a sentence, into its individual components. For example, if the **Format** parameter is set to "%s is %f.", the block outputs two parts, a string signal and a single signal. If the input is the string "Pi is 3.14", the two outputs are "Pi" and "3.14".

Note If you specify a numeric display format that is not large enough to display all the digits of a value, the displayed values may lose precision. The result depends on your computer hardware and operating system.

The Scan String, String to Double, and String to Single blocks are identical blocks. When configured for String to Double, the block converts the input string signal to a double numerical output. When configured for String to Single, the block converts the input string signal to a single numerical output.

For code generation, configure models that contain this block for non-finite number support by selecting the **Configuration Parameters > Code Generation > Interface > Support non-finite numbers** check box.

Ports

Input

Port_1 – Input string

scalar

Input string, specified as a scalar.

Data Types: `string`

Output

d – Output data whose format matches %d format

scalar

Output data whose format matches the specified format, defined as a scalar. Total maximum number of outputs is 128.

If the block cannot match an input string to a format operator specified in **Format**, it returns a warning and outputs an appropriate value (0 or "") for each unmatched format operator.

Data Types: `single` | `double` | `int8` | `int16` | `int32` | `uint8` | `uint16` | `uint32` | `Boolean` | `fixed point` | `enumerated` | `bus`

f – Output data whose format matches %f format

scalar

Output data whose format matches the %f format, specified as a scalar. Total maximum number of outputs is 128.

Data Types: `single` | `double` | `int8` | `int16` | `int32` | `uint8` | `uint16` | `uint32` | `Boolean` | `fixed point` | `enumerated` | `bus`

Port_N – Output data whose format matches N format

scalar

Output data whose format matches *N* format, specified as a scalar. Total maximum number of outputs is 128.

Data Types: `single` | `double` | `int8` | `int16` | `int32` | `uint8` | `uint16` | `uint32` | `Boolean` | `fixed point` | `enumerated` | `bus`

Parameters

Format – Format operator for input

"%d %f" (default) | scalar

Format operator for input, specified as a scalar. If the block cannot match the input string with the specified format, it returns 0. The return of 0 differs from the `sscanf` function return, which is an empty matrix if the function cannot match the input with the specified format.

- For the String to Double block, this parameter has a default value of %lf.
- For the String to Single block, this parameter has a default value of %f.

For more information about acceptable format operators, see the Algorithms section.

Block Characteristics

| | |
|---------------------------------|--|
| Data Types | <code>double</code> <code>integer</code> <code>single</code> <code>string</code> |
| Direct Feedthrough | yes |
| Multidimensional Signals | no |
| Variable-Size Signals | no |
| Zero-Crossing Detection | no |

Algorithms

The Scan String block uses this format specifier prototype:

`%[width][length]specifier`

Numeric Fields

This table lists available conversion specifiers to convert text to numeric outputs. The block converts values to their decimal (base 10) representation.

| Output Port Data Type | Conversion Specifier | Description |
|-----------------------|--|--|
| Integer, signed | <code>%d</code> | Base 10 |
| Integer, unsigned | <code>%u</code> | Base 10 |
| Floating-point number | <code>%f</code> , <code>%e</code> , or <code>%g</code> | Floating-point values. Input fields can contain NaN (case sensitive). Input fields that represents floating-point numbers can include leading + or - symbols and exponential notation using e or E. The conversion specifiers <code>%f</code> , <code>%e</code> , and <code>%g</code> all treat input fields the same way. |

Character Fields

This table lists available conversion specifiers to convert text so that the output is a string.

| Character Field Type | Conversion Specifier | Description |
|----------------------|--------------------------|--|
| String scalar | <code>%s</code> | Read the text until the block encounters whitespace. |
| | <code>%c</code> | Read any single character, including whitespace. To read multiple characters at a time, specify field width. For example, <code>%10c</code> reads 10 characters at a time. |
| Pattern-matching | <code>%[. . .]</code> | Read only the characters in the brackets up to the first nonmatching character or whitespace. Example: <code>%[mus]</code> reads 'summer' as 'summ'. |
| | <code>%[^ . . .]</code> | Read any characters not in the brackets up to the first matching character or whitespace. Example: <code>%[^m]</code> reads 'summer' as 'su'. |

Optional Operators

- **Field Width** — To specify the maximum number of digits or text characters to read at a time, insert a number after the percent character. For example, `%10s` reads up to 10 characters at a time, including whitespace. `%4f` reads up to four digits at a time, including the decimal point.
- **Literal Text to Ignore** — This block must match the specified text immediately before or after the conversion specifier.

Example: `Hell%s` reads "Hello!" as "o!".

Length Specifiers

The Scan String block supports the `h` and `l` length subspecifiers. These specifiers can change according to the **Configuration Parameters > Hardware Implementation > Number of bits** settings.

| Length | i | u | f e g | s c [...] [^...] |
|---------------------|-------|----------------|--------|------------------|
| No length specifier | int | unsigned int | single | string |
| <code>h</code> | short | unsigned short | — | — |
| <code>l</code> | long | unsigned long | double | — |

Notes for Specifiers that Specify Integer Data Types (d, u)

- Target `int`, `long`, and `short` type sizes are controlled by settings in the **Configuration Parameters > Hardware Implementation** pane. For example, if the target `int` is 32 bits and the specifier is `%u`, then the expected input type will be `uint32`. For this example, the Scan String block requires that the output type be exactly `int32`. It cannot be any other data type.

Extended Capabilities

C/C++ Code Generation

Generate C and C++ code using Simulink® Coder™.

See Also

`sscanf` | ASCII to String | Compose String | String Compare | String Concatenate | String Constant | String Find | String Length | String to Double | String to Enum | String to ASCII | String to Single | Substring | To String

Topics

“Display and Extract Coordinate Data”

“Simulink Strings”

Introduced in R2018a

Scope

Display signals generated during simulation

Library: Simulink / Commonly Used Blocks
Simulink / Sinks
HDL Coder / Commonly Used Blocks
HDL Coder / Sinks



Description

The Simulink Scope block and DSP System Toolbox Time Scope block display time domain signals.

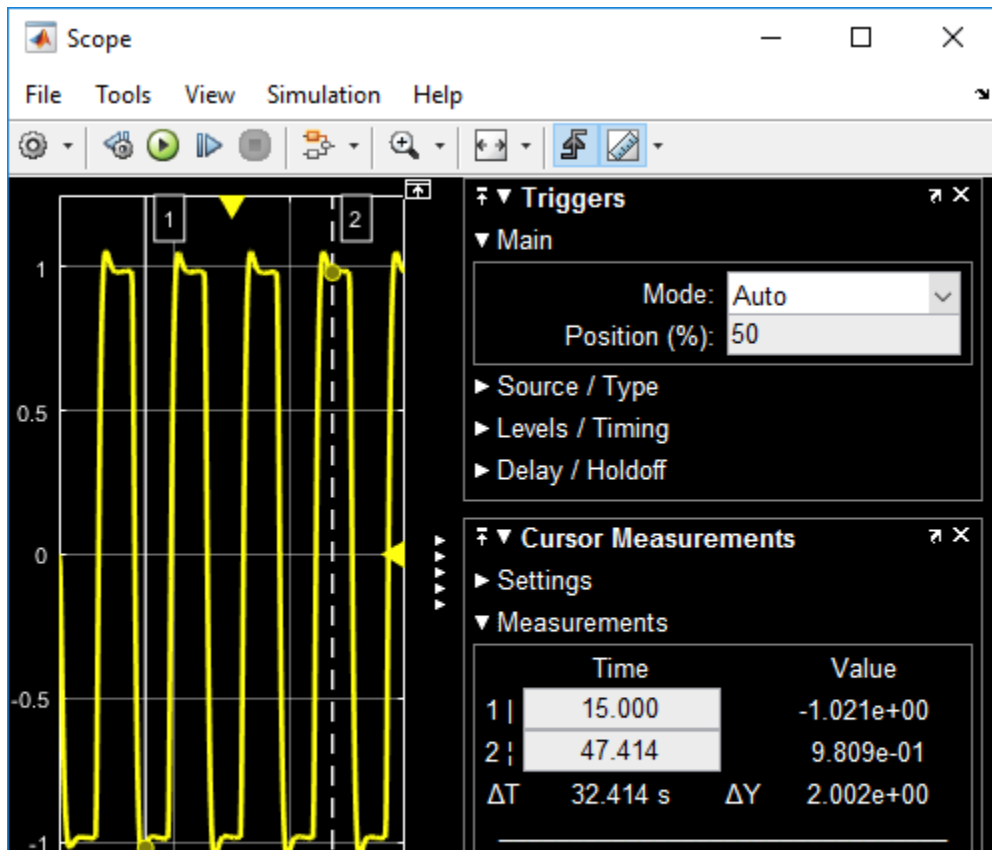
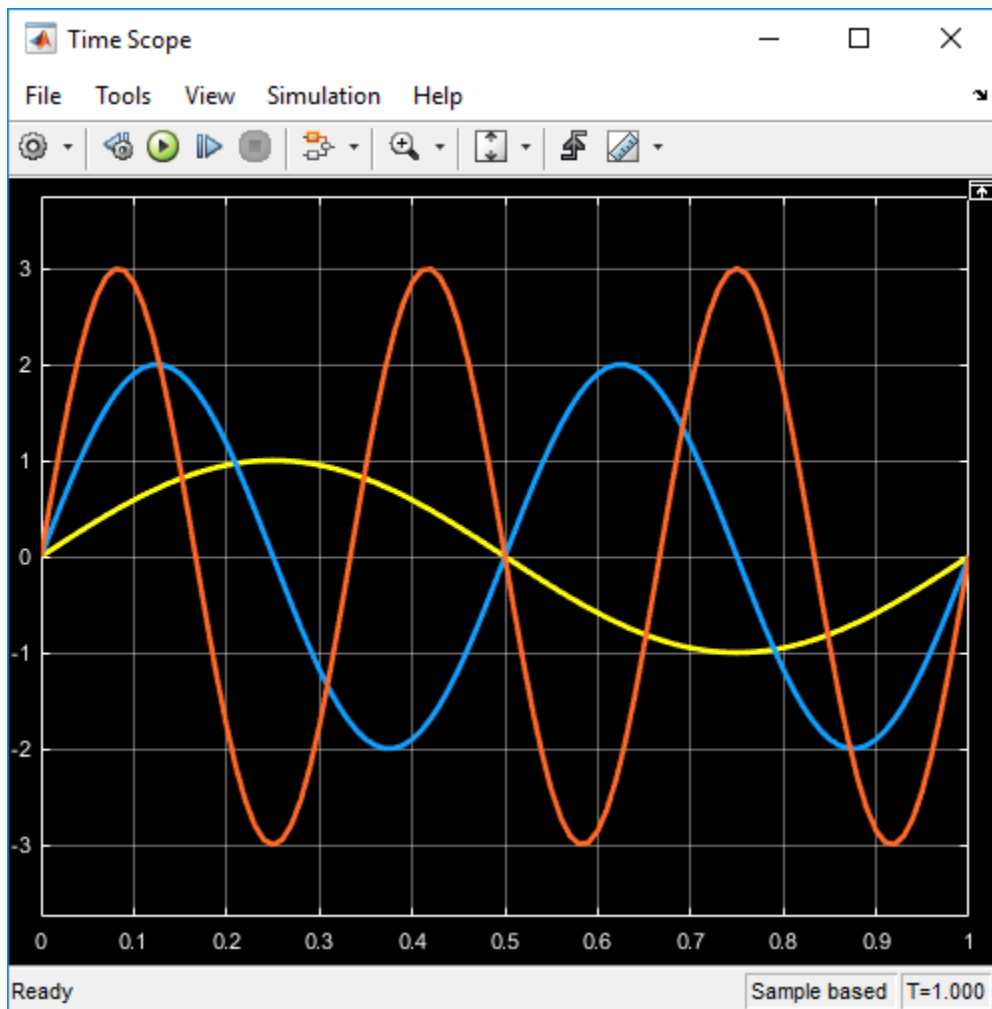

The two blocks have identical functionality, but different default settings. The Time Scope is optimized for discrete time processing. The Scope is optimized for general time-domain simulation. For a side-by-side comparison, see “Simulink Scope Versus DSP System Toolbox Time Scope”.

Oscilloscope features:

- Triggers — Set triggers to sync repeating signals and pause the display when events occur.
- Cursor Measurements — Measure signal values using vertical and horizontal cursors.
- Signal Statistics — Display the maximum, minimum, peak-to-peak difference, mean, median, and RMS values of a selected signal.
- Peak Finder — Find maxima, showing the x-axis values at which they occur.
- Bilevel Measurements — Measure transitions, overshoots, undershoots, and cycles.

You must have a Simscape or DSP System Toolbox license to use the Peak Finder, Bilevel Measurements, and Signal Statistics.

Scope display features:

- Simulation control — Debug models from a Scope window using **Run**, **Step Forward**, and **Step Backward** toolbar buttons.
- Multiple signals — Plot multiple signals on the same y-axis (display) using multiple input ports.
- Multiple y-axes (displays) — Display multiple y-axes. All the y-axes have a common time range on the x-axis.
- Modify parameters — Modify scope parameter values before and during a simulation.
- Axis autoscaling — Autoscale axes during or at the end of a simulation. Margins are drawn at the top and bottom of the axes.
- Display data after simulation — Scope data is saved during a simulation. If a scope is closed at the start of a simulation, when you open the scope after a simulation, the scope displays simulation results for attached input signals.

Note If you have a high sample rate or long simulation time, you may run into issues with memory or system performance because the scope saves data internally. To limit the amount of data saved for scope visualization, use the Limit data points to last property.

For information on controlling a scope programmatically, see “Control Scope Blocks Programmatically”.

Limitations

- Do not use scope blocks in a Library. If you place a scope block inside a library block with a locked link or in a locked library, Simulink displays an error when trying to open the scope window. To display internal data from a library block, add an output port to the library block, and then connect the port to a Scope block in your model.
- If you step through a model, the scope only updates when the scope block runs. This means that the time shown in the status bar may not match the model time.
- When connected to a constant signal, a scope block may plot a single point.
- The scope shows gaps in the display when the signal value is NaN.

- When you visualize multiple frame-based signals in the scope, some samples of signals with a frame size of 1 might not be displayed. To visualize these signals, move the signals with frame size of 1 to a separate scope.
- Scope displays have limitations in Rapid Accelerator mode. See “Behavior of Scopes and Viewers with Rapid Accelerator Mode”
- When the Scope is in a ForEach subsystem, the scope only displays the last index.

Ports

Input

Port_1 — Signal or signals to visualize

scalar | vector | matrix | array | bus | nonvirtual bus

Connect the signals you want to visualize. You can have up to 96 input ports. Input signals can have these characteristics:

- **Type** — Continuous (sample-based) or discrete (sample-based and frame-based).
- **Data type** — Any data type that Simulink supports. See “Data Types Supported by Simulink”.
- **Dimension** — Scalar, one dimensional (vector), two dimensional (matrix), or multidimensional (array). Display multiple channels within one signal depending on the dimension. See “Signal Dimensions” and “Determine Signal Dimensions”.

Input Limitations

- When the input is a constant signal, the scope plots a single point.
- The scope shows gaps in the display when the signal value is NaN.
- When you visualize multiple frame-based signals in the scope, some samples of signals with a frame size of 1 might not be displayed. To visualize these signals, move the signals with frame size of 1 to a separate scope.

Bus Support

You can connect nonvirtual bus and arrays of bus signals to a scope. To display the bus signals, use normal or accelerator simulation mode. The scope displays each bus element signal in the order the elements appear in the bus, from the top to the bottom. Nested bus elements are flattened.

To log nonvirtual bus signals with a scope, set the **Save format** parameter to Dataset. You can use any **Save format** to log virtual bus signals.

Data Types: single | double | half | int8 | int16 | int32 | int64 | uint8 | uint16 | uint32 | uint64 | Boolean | fixed point | enumerated | bus

Properties

Configuration Properties

The Configuration Properties dialog box controls various properties about the scope displays. From the scope menu, select **View > Configuration Properties**.

Main**Open at simulation start — Specify when scope window opens**

off (default for Scope) | on (default for Time Scope)

Select this check box to open the scope window when simulation starts.

Programmatic Use

See `OpenAtSimulationStart`.

Display the full path — Display block path on scope title bar

off (default) | on

Select this check box to display the block path in addition to the block name.

Number of input ports — Number of input ports on scope block

1 (default) | integer

Specify number of input ports on a Scope block, specified as an integer. The maximum number of input ports is 96.

Programmatic Use

See `NumInputPorts`.

Layout — Number and arrangement of displays

1-by-1 display (default) | an arrangement of m-by-n axes

Specify number and arrangement of displays. The maximum layout is 16 rows by 16 columns.

To expand the layout grid beyond 4 by 4, click within the dialog box and drag. Maximum of 16 rows by 16 columns.

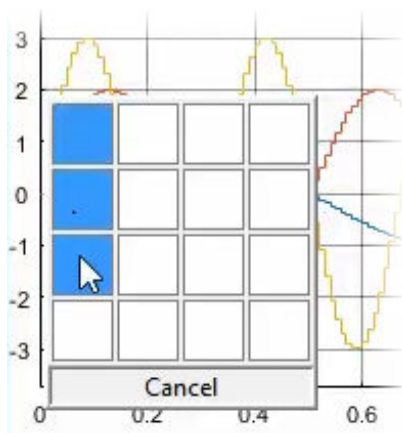

If the number of displays is equal to the number of ports, signals from each port appear on separate displays. If the number of displays is less than the number of ports, signals from additional ports appear on the last display. For layouts with multiple columns and rows, ports are mapped down then across.

Programmatic Use

See `LayoutDimensions`.

Sample time — Simulation interval between scope updates

-1 (for inherited) (default) | positive real number

Specify the time interval between updates of the scope display. This property does not apply to floating scopes and scope viewers. For a more detailed explanation of sample time with the scope, see “Sample Time with Scope Blocks”

Programmatic Use

See `SampleTime`.

Input processing — Channel or element signal processing

Elements as channels (sample based) (default for Scope) | Columns as channels (frame based) (default for Time Scope)

- Elements as channels (sample based) - Process each element as a unique sample.
- Columns as channels (frame based) - Process signal values in a channel as a group of values from multiple time intervals. Frame-based processing is available only with discrete input signals.

Programmatic Use

See `FrameBasedProcessing`.

Maximize axes — Maximize size of plots

Off (default for Scope) | Auto (default for Time Scope) | On

- Auto - If “Title” on page 1-0 and “Y-label” on page 1-0 properties are not specified, maximize all plots.
- On - Maximize all plots. Values in **Title** and **Y-label** are hidden.
- Off - Do not maximize plots.

Programmatic Use

See `MaximizeAxes`.

Time**Time span — Length of x-axis to display**

Auto (default) | User defined | One frame period

- Auto — Difference between the simulation start and stop times.

The block calculates the beginning and end times of the time range using the “Time display offset” on page 1-0 and “Time span” on page 1-0 properties. For example, if you set the **Time display offset** to 10 and the **Time span** to 20, the scope sets the time range from 10 to 30.

- User defined — Enter any value less than the total simulation time.
- One frame period — Use the frame period of the input signal to the Time Scope block. This option is only available when the **Input processing** parameter is set to Columns as channels (frame based).

Programmatic Use

See `TimeSpan`.

Time span overrun action — Display data beyond visible x-axis

Wrap (default) | Scroll

Specify how to display data beyond the visible x-axis range.

You can see the effects of this option only when plotting is slow with large models or small step sizes.

- **Wrap** — Draw a full screen of data from left to right, clear the screen, and then restart drawing the data from the left.
- **Scroll** — Move data to the left as new data is drawn on the right. This mode is graphically intensive and can affect run-time performance.

Programmatic Use

See `TimeSpanOverrunAction`.

Time units — x-axis units

None (default for Scope) | Metric (default for Time Scope) | Seconds

- **Metric** — Display time units based on the length of “Time span” on page 1-0 .
- **Seconds** — Display time in seconds.
- **None** — Do not display time units.

Programmatic Use

See `TimeUnits`.

Time display offset — x-axis offset

0 (default) | scalar | vector

Offset the x-axis by a specified time value, specified as a real number or vector of real numbers.

For input signals with multiple channels, you can enter a scalar or vector:

- **Scalar** — Offset all channels of an input signal by the same time value.
- **Vector** — Independently offset the channels.

Programmatic Use

See `TimeDisplayOffset`.

Time-axis labels — Display of x-axis labels

Bottom Displays Only (default for Scope) | All (default for Time Scope) | None

Specify how x-axis (time) labels display:

- **All** — Display x-axis labels on all y-axes.
- **None** — Do not display labels. Selecting **None** also clears the **Show time-axis label** check box.
- **Bottom displays only** — Display x-axis label on the bottom y-axis.

Dependencies

To enable this property, set:

- “Show time-axis label” on page 1-0 to on.
- “Maximize axes” on page 1-0 to off.

The “Active display” on page 1-0 property determines which display is affected.

Programmatic Use

See `TimeAxisLabels`.

Show time-axis label — Display or hide x-axis labels

off (default for Scope) | on (default for Time Scope)

Select this check box to show the x-axis label for the active display

Dependencies

To enable this property, set “Time-axis labels” on page 1-0 to **All or Bottom Displays Only**.

The “Active display” on page 1-0 property determines which display is affected.

Programmatic Use

See `ShowTimeAxisLabel`.

Display

Active display — Selected display

1 (default) | positive integer

Selected display. Use this property to control which display is changed when changing style properties and axes-specific properties.

Specify the desired display using a positive integer that corresponds to the column-wise placement index. For layouts with multiple columns and rows, display numbers are mapped down and then across.

Programmatic Use

See `ActiveDisplay`.

Title — Display name

%<SignalLabel> (default) | string

Title for a display. The default value %<SignalLabel> uses the input signal name for the title.

Dependency

The “Active display” on page 1-0 property determines which display is affected.

Programmatic Use

See `Title`.

Show legend — Display signal legend

off (default) | on

Toggle signal legend. The names listed in the legend are the signal names from the model. For signals with multiple channels, a channel index is appended after the signal name. Continuous signals have straight lines before their names, and discrete signals have step-shaped lines.

From the legend, you can control which signals are visible. This control is equivalent to changing the visibility in the **Style** properties. In the scope legend, click a signal name to hide the signal in the scope. To show the signal, click the signal name again. To show only one signal, right-click the signal name, which hides all other signals. To show all signals, press **Esc**.

Note The legend only shows the first 20 signals. Any additional signals cannot be controlled from the legend.

Dependency

The “Active display” on page 1-0 property determines which display is affected.

Programmatic Use

See ShowLegend.

Show grid — Show internal grid lines

on (default) | off

Select this check box to show grid lines.

Dependency

The “Active display” on page 1-0 property determines which display is affected.

Programmatic Use

See ShowGrid.

Plot signals as magnitude and phase — Split display into magnitude and phase plots

off (default) | on

- On — Display magnitude and phase plots. If the signal is real, plots the absolute value of the signal for the magnitude. The phase is 0 degrees for positive values and 180 degrees for negative values. This feature is useful for complex-valued input signals. If the input is a real-valued signal, selecting this check box returns the absolute value of the signal for the magnitude.
- Off — Display signal plot. If the signal is complex, plots the real and imaginary parts on the same y-axis.

Dependency

The “Active display” on page 1-0 property determines which display is affected.

Programmatic Use

See PlotAsMagnitudePhase.

Y-limits (Minimum) — Minimum y-axis value

-10 (default) | real scalar

Specify the minimum value of the y-axis as a real number.

Tunable: Yes

Dependency

If you select **Plot signals as magnitude and phase**, this property only applies to the magnitude plot. The y-axis limits of the phase plot are always [-180 180].

The “Active display” on page 1-0 property determines which display is affected.

Programmatic Use

See YLimits.

Y-limits (Maximum) — Maximum y-axis value

10 (default) | real scalar

Specify the maximum value of the y-axis as a real number.

Tunable: Yes

Dependency

If you select **Plot signals as magnitude and phase**, this property only applies to the magnitude plot. The y-axis limits of the phase plot are always [-180 180].

The “Active display” on page 1-0 property determines which display is affected.

Programmatic Use

See YLimits.

Y-label — Y-axis label

none (default for Scope) | Amplitude (default for Time Scope) | string

Specify the text to display on the y-axis. To display signal units, add (%<SignalUnits>) to the label. At the beginning of a simulation, Simulink replaces (%SignalUnits) with the units associated with the signals.

Example: For a velocity signal with units of m/s, enter Velocity (%<SignalUnits>).

Dependency

If you select **Plot signals as magnitude and phase**, this property does not apply. The y-axes are labeled Magnitude and Phase.

The “Active display” on page 1-0 property determines which display is affected.

Programmatic Use

See YLabel.

Logging**Limit data points to last — Limit buffered data values**

off and 5000 (default) | on | positive integer

Limit data saved by the scope internally. By default all data points are saved so that you can view the scope visualization after the simulation finishes. For simulations with **Stop time** set to `inf`, consider selecting **Limit data points to last**.

Note If you do not select **Limit data points to last** and you have a high sample rate or long simulation time, you may run into issues with memory or system performance.

When you select this property, the scope saves the latest n data points, where n the specified number of data points.

- Off — Save and plot all data values.
- On — Save specified number of data values for each signal. If the signal is frame-based, the number of buffered data values is the specified number of data values multiplied by the frame size.

In some cases, selecting this property can have the effect of plotting signals for less than the entire time range of a simulation (for example if your sample time is small). If the scope plots a portion of your signals, consider increasing the number of data points to save.

This property limits the data values plotted in the scope and the data values saved to a MATLAB variable specified in “Variable name” on page 1-0 .

Programmatic Use

See `DataLoggingLimitDataPoints` and `DataLoggingMaxPoints`.

Decimation — Reduce amount of scope data to display and save

off, 2 (default) | on | positive integer

- On — Plot and log (save) scope data every Nth data point, where N is the decimation factor entered in the text box. A value of 1 buffers all data values.
- Off — Save all scope data values.

Dependency

To enable this property, select “Log data to workspace” on page 1-0 .

This property limits the data values plotted in the scope and the data values saved to a MATLAB variable specified in “Variable name” on page 1-0 .

Programmatic Use

See `DataLoggingDecimateData` and `DataLoggingDecimation`.

Log data to workspace — Save data to MATLAB workspace

off (default) | on

Select this check box to enable logging and enable the **Variable name**, **Save format**, and **Decimation** properties. This property does not apply to floating scopes and scope viewers.

For an example of saving signals to the MATLAB Workspace using a Scope block, see “Save Simulation Data Using Scope Block”.

Programmatic Use

See `DataLogging`.

Variable name — Name of saved data variable

`ScopeData` (default) | string

Specify a variable name for saving scope data in the MATLAB workspace. This property does not apply to floating scopes and scope viewers.

Dependency

To enable this property, select “Log data to workspace” on page 1-0 .

Programmatic Use

See `DataLoggingVariableName`.

Save format — MATLAB variable format

Dataset (default) | Structure With Time | Structure | Array

Select variable format for saving data to the MATLAB workspace. This property does not apply to floating scopes and scope viewers.

- Dataset — Save data as a Dataset object, by default a timeseries object.
- Structure With Time — Save data as a structure with associated time information.
- Structure — Save data as a structure.
- Array — Save data as an array with associated time information. This format does not support variable-size data.

Dependency

To enable this property, select “Log data to workspace” on page 1-0 .

Programmatic Use

See `DataLoggingSaveFormat`.

Axes Scaling Properties

The **Axes Scaling** dialog controls the axes limits of the scope. To open the Axes Scaling properties, in the scope menu, select **Tools > Axes Scaling > Axes Scaling Properties**.

Axes scaling — Y-axis scaling mode

Manual (default) | Auto | After N Updates

- Manual — Manually scale the y-axis range with the **Scale Y-axis Limits** toolbar button.
- Auto — Scale the y-axis range during and after simulation. Selecting this option displays the **Do not allow Y-axis limits to shrink** check box. If you want the y-axis range to increase and decrease with the maximum value of a signal, set **Axes scaling** to Auto and clear the **Do not allow Y-axis limits to shrink** check box.
- After N Updates — Scale y-axis after the number of time steps specified in the **Number of updates** text box (10 by default). Scaling occurs only once during each run.

Programmatic Use

See `AxesScaling`.

Do not allow Y-axis limits to shrink — When y-axis limits can change

on (default) | off

Allow y-axis range limits to increase but not decrease during a simulation.

Dependency

To use this property, set **Axes scaling** to Auto.

Number of updates — Number of updates before scaling

10 (default) | integer

Set this property to delay auto scaling the y-axis.

Dependency

To use this property, set **Axes scaling** to After N Updates.

Programmatic Use

See AxesScalingNumUpdates.

Scale axes limits at stop — When y-axis limits can change

on (default) | off

- On — Scale axes when simulation stops.
- Off — Scale axes continually.

Dependency

To use this property, set **Axes scaling** to Auto.

Y-axis Data range (%) — Percent of y-axis to use for plotting

80 (default) | integer between [1, 100]

Specify the percentage of the y-axis range used for plotting data. If you set this property to 100, the plotted data uses the entire y-axis range.

Y-axis Align — Alignment along y-axis

Center (default) | Top | Bottom

Specify where to align plotted data along the y-axis data range when **Y-axis Data range** is set to less than 100 percent.

- Top — Align signals with the maximum values of the y-axis range.
- Center — Center signals between the minimum and maximum values.
- Bottom — Align signals with the minimum values of the y-axis range.

Autoscale X-axis limits — Scale x-axis range limits

off (default) | on

Scale x-axis range to fit all signal values. If **Axes scaling** is set to Auto, the data currently within the axes is scaled, not the entire signal in the data buffer.

X-axis Data range (%) — Percent of x-axis to use for plotting

100 (default) | integer in the range [1, 100]

Specify the percentage of the x-axis range to plot data on. For example, if you set this property to 100, plotted data uses the entire x-axis range.

X-axis Align — Alignment along x-axis

Center (default) | Top | Bottom

Specify where to align plotted data along the x-axis data range when **X-axis Data range** is set to less than 100 percent.

- **Top** — Align signals with the maximum values of the x-axis range.
- **Center** — Center signals between the minimum and maximum values.
- **Bottom** — Align signals with the minimum values of the x-axis range.

Style Properties

To open the Style dialog box, from the scope menu, select **View > Style**.

Figure color — Background color for window

black (default) | color

Background color for the scope.

Plot type — How to plot signal

Auto (default for Scope) | Line (default for Time Scope) | Stairs | Stem

When you select **Auto**, the plot type is a line graph for continuous signals, a stair-step graph for discrete signals, and a stem graph for Simulink message signals.

Axes colors — Background and axes color for individual displays

black (default) | color

Select the background color for axes (displays) with the first color palette. Select the grid and label color with the second color palette.

Preserve colors for copy to clipboard — Copy scope without changing colors

off (default) | on

Specify whether to use the displayed color of the scope when copying.

When you select **File > Copy to Clipboard**, the software changes the color of the scope to be printer friendly (white background, visible lines). If you want to copy and paste the scope with the colors displayed, select this check box.

Properties for line — Line to change

Channel 1 (default)

Select active line for setting line style properties.

Visible — Line visibility

on (default) | off

Show or hide a signal on the plot.

Dependency

The values of “Active display” on page 1-0 and “Properties for line” on page 1-0 determine which line is affected.

Line – Line style

solid line (default style) | 0.75 (default width) | yellow (default color)

Select line style, width, and color.

Dependency

The values of “Active display” on page 1-0 and “Properties for line” on page 1-0 determine which line is affected.

Marker – Data point marker style

None (default) | marker shape

Select marker shape.

Dependency

The values of “Active display” on page 1-0 and “Properties for line” on page 1-0 determine which line is affected.

Block Characteristics

| | |
|---------------------------------|--|
| Data Types | Boolean bus ^a double enumerated fixed point half integer single |
| Direct Feedthrough | no |
| Multidimensional Signals | yes |
| Variable-Size Signals | yes |
| Zero-Crossing Detection | no |

a. Virtual bus not supported. Nonvirtual bus supported only in normal and accelerator mode simulation. Data logging for nonvirtual bus supported only in the dataset format

Extended Capabilities

C/C++ Code Generation

Generate C and C++ code using Simulink® Coder™.

This block can be used for simulation visibility in systems that generate code, but is not included in the generated code.

HDL Code Generation

Generate Verilog and VHDL code for FPGA and ASIC designs using HDL Coder™.

This block can be used for simulation visibility in subsystems that generate HDL code, but is not included in the hardware implementation.

PLC Code Generation

Generate Structured Text code using Simulink® PLC Coder™.

This block can be used for simulation visibility in systems that generate code, but is not included in the generated code.

Fixed-Point Conversion

Design and simulate fixed-point systems using Fixed-Point Designer™.

This block accepts fixed-point input, but converts it to `double` for display.

See Also

Floating Scope | Scope Viewer

Topics

[“Scope Blocks and Scope Viewer Overview”](#)

[“Step Through a Simulation”](#)

[“Common Scope Block Tasks”](#)

[“Control Scope Blocks Programmatically”](#)

[“Scope Block with Android Devices”](#) (Simulink Support Package for Android Devices)

[Scope Block with Apple iOS Devices](#) (Simulink Support Package for Apple iOS Devices)

[“Simulink Scope Block and Mobile Apps”](#) (Simulink Support Package for Android Devices)

Introduced in R2015b

Second-Order Integrator

Second-order integration of input signal

Library: Simulink / Continuous

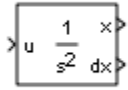

Description

The Second-Order Integrator block and the Second-Order Integrator Limited block solve the second-order initial value problem:

$$\frac{d^2x}{dt^2} = u,$$

$$\left. \frac{dx}{dt} \right|_{t=0} = dx_0,$$

$$x|_{t=0} = x_0,$$

where u is the input to the system. The block is therefore a dynamic system with two continuous states: x and dx/dt .

Note These two states have a mathematical relationship, namely, that dx/dt is the derivative of x . To satisfy this relationship throughout the simulation, Simulink places various constraints on the block parameters and behavior.

The Second-Order Integrator Limited block is identical to the Second-Order Integrator block with the exception that it defaults to limiting the states based on the specified upper and lower limits. For more information, see “Limiting the States” on page 1-1545.

Simulink software can use several different numerical integration methods to compute the outputs of the block. Each has advantages for specific applications. Use the **Solver** pane of the Configuration Parameters dialog box to select the technique best suited to your application. (For more information, see “Solver Selection Criteria”.) The selected solver computes the states of the Second-Order Integrator block at the current time step using the current input value.

Use the block parameter dialog box to:

- Specify whether the source of each state initial condition is internal or external
- Specify a value for the state initial conditions
- Define upper and lower limits on either or both states
- Specify absolute tolerances for each state
- Specify names for both states
- Choose an external reset condition

- Enable zero-crossing detection
- Reinitialize dx/dt when x reaches saturation
- Specify that Simulink disregard the state limits and external reset for linearization operations

Defining Initial Conditions

You can define the initial conditions of each state individually as a parameter on the block dialog box or input one or both of them from an external signal.

- To define the initial conditions of state x as a block parameter, use the **Initial condition source x** drop-down menu to select `internal` and enter the value in the **Initial condition x** field.
- To provide the initial conditions from an external source for state x , specify the **Initial condition source x** parameter as `external`. An additional input port appears on the block.
- To define the initial conditions of state dx/dt as a block parameter, use the **Initial condition source dx/dt** drop-down menu to select `internal` and enter the value in the **Initial condition dx/dt** field.
- To provide the initial conditions from an external source for state dx/dt , specify **Initial condition source dx/dt** as `external`. An additional input port appears on the block.

If you choose to use an external source for both state initial conditions, your block appears as follows.

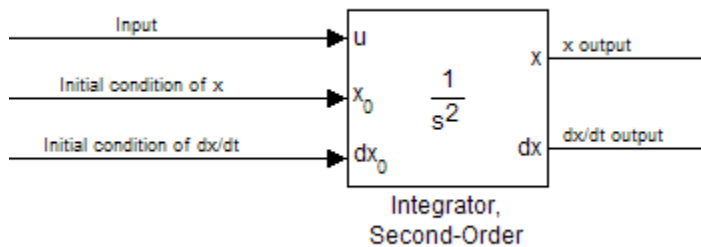

Note

- Simulink does not allow initial condition values of `inf` or `NaN`.
- If you limit state x or state dx/dt by specifying saturation limits (see "Limiting the States" on page 1-1545) and one or more initial conditions are outside the corresponding limits, then the respective states are initialized to the closest valid value and a set of consistent initial conditions is calculated.

Limiting the States

When modeling a second-order system, you may need to limit the block states. For example, the motion of a piston within a cylinder is governed by Newton's Second Law and has constraints on the piston position (x). With the Second-Order Integrator block, you can limit the states x and dx/dt independent of each other. You can even change the limits during simulation; however, you cannot change whether or not the states are limited. An important rule to follow is that an upper limit must be strictly greater than its corresponding lower limit.

The block appearance changes when you limit one or both states. With both states limited, the block appears as follows.

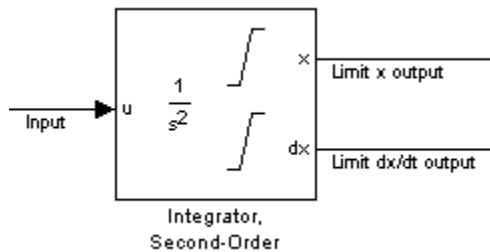

For each state, you can use the block parameter dialog box to set appropriate saturation limits.

Limiting x Only

If you use the Second-Order Integrator Limited block, both states are limited by default. But you can also manually limit state x on the Second-Order Integrator block by selecting **Limit x** and entering the limits in the appropriate parameter fields.

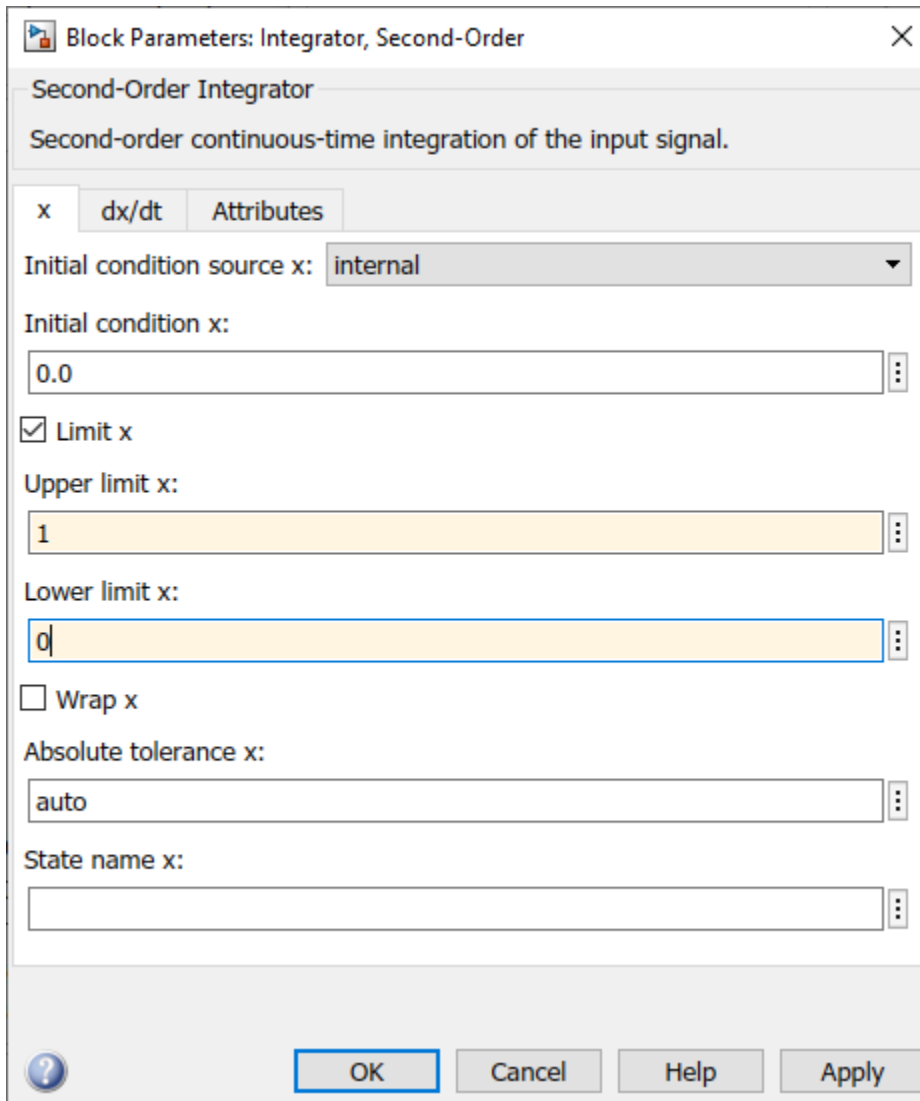

The block then determines the values of the states as follows:

- When x is less than or equal to its lower limit, the value of x is held at its lower limit and dx/dt is set to zero.
- When x is in between its lower and upper limits, both states follow the trajectory given by the second-order ODE.
- When x is greater than or equal to its upper limit, the value of x is held at its upper limit and dx/dt is set to zero.

You can choose to reinitialize dx/dt to a new value at the time when x reaches saturation. See “Reinitializing dx/dt When x Reaches Saturation” on page 1-1550.

Limiting dx/dt Only

As with state x , state dx/dt is set as limited by default on the **dx/dt** pane of the Second-Order Integrator Limited block dialog box. You can manually set this parameter, **Limit dx/dt**, on the Second-Order Integrator block. In either case, you must enter the appropriate limits for dx/dt .

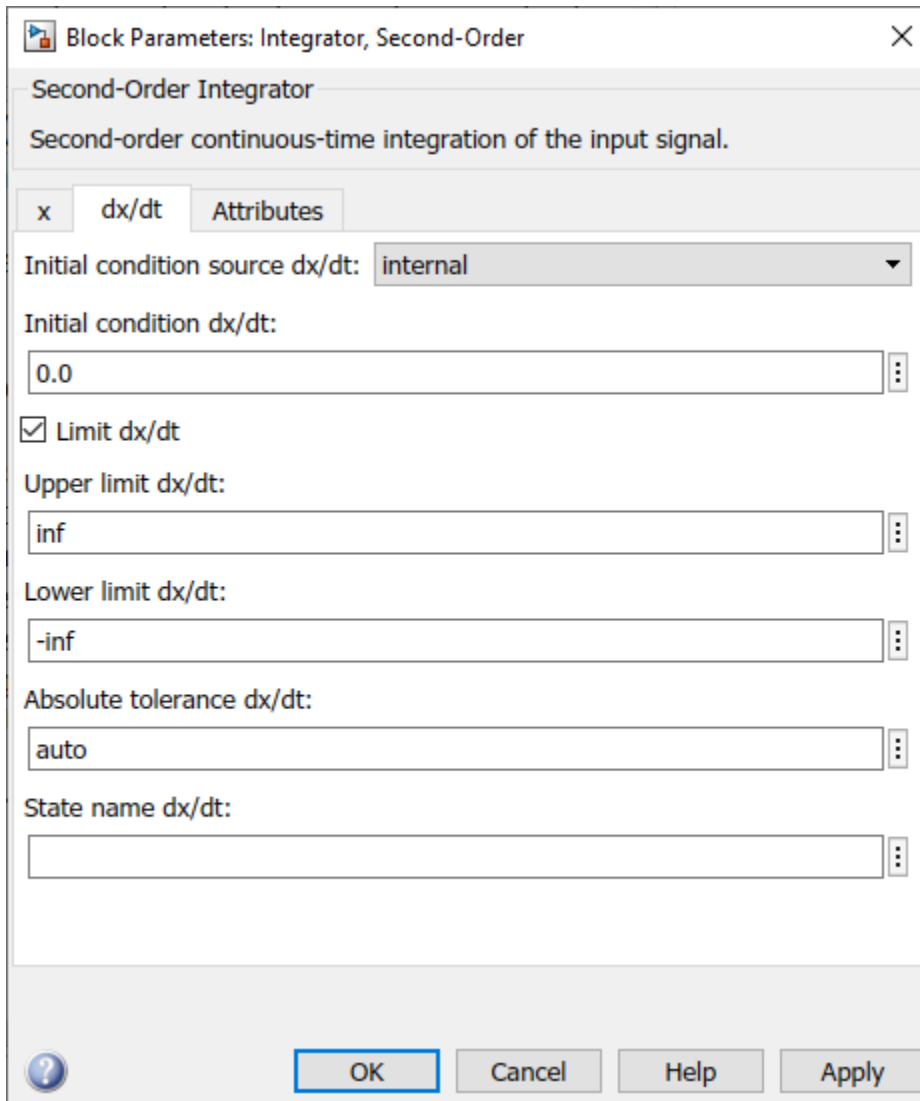

If you limit only the state dx/dt , then the block determines the values of dx/dt as follows:

- When dx/dt is less than or equal to its lower limit, the value of dx/dt is held at its lower limit.
- When dx/dt is in between its lower and upper limits, both states follow the trajectory given by the second-order ODE.
- When dx/dt is greater than or equal to its upper limit, the value of dx/dt is held at its upper limit.

When state dx/dt is held at its upper or lower limit, the value of x is governed by the first-order initial value problem:

$$\begin{aligned}\frac{dx}{dt} &= L, \\ x(t_L) &= x_L,\end{aligned}$$

where L is the dx/dt limit (upper or lower), t_L is the time when dx/dt reaches this limit, and x_L is the value of state x at that time.

Limiting Both States

When you limit both states, Simulink maintains mathematical consistency of the states by limiting the allowable values of the upper and lower limits for dx/dt . Such limitations are necessary to satisfy the following constraints:

- When x is at its saturation limits, the value of dx/dt must be zero.
- In order for x to leave the upper limit, the value of dx/dt must be strictly negative.
- In order for x to leave its lower limit, the value of dx/dt must be strictly positive.

For such cases, the upper limit of dx/dt must be strictly positive and the lower limit of dx/dt must be strictly negative.

When both states are limited, the block determines the states as follows:

- Whenever x reaches its limits, the resulting behavior is the same as that described in “Limiting x only”.
- Whenever dx/dt reaches one of its limits, the resulting behavior is the same as that described in “Limiting dx/dt only” — including the computation of x using a first-order ODE when dx/dt is held at one of its limits. In such cases, when x reaches one of its limits, it is held at that limit and dx/dt is set to zero.
- Whenever both reach their respective limits simultaneously, the state x behavior overrides dx/dt behavior to maintain consistency of the states.

When you limit both states, you can choose to reinitialize dx/dt at the time when state x reaches saturation. If the reinitialized value is outside specified limits on dx/dt , then dx/dt is reinitialized to the closest valid value and a consistent set of initial conditions is calculated. See “Reinitializing dx/dt When x Reaches Saturation” on page 1-1550

Resetting the State

The block can reset its states to the specified initial conditions based on an external signal. To cause the block to reset its states, select one of the **External reset** choices on the **Attributes** pane. A trigger port appears on the block below its input port and indicates the trigger type.

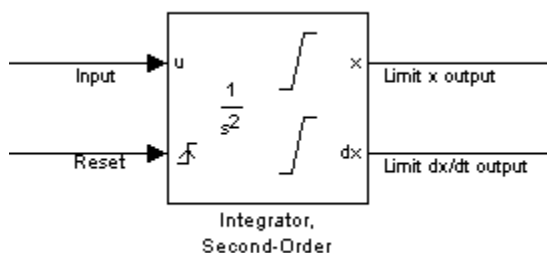

- Select **rising** to reset the states when the reset signal rises from zero to a positive value, from a negative to a positive value, or a negative value to zero.
- Select **falling** to reset the states when the reset signal falls from a positive value to zero, from a positive to a negative value, or from zero to negative.
- Select **either** to reset the states when the reset signal changes from zero to a nonzero value or changes sign.

The reset port has direct feedthrough. If the block output feeds back into this port, either directly or through a series of blocks with direct feedthrough, an algebraic loop results (see “Algebraic Loop Concepts”).

Enabling Zero-Crossing Detection

This parameter controls whether zero-crossing detection is enabled for this block. By default, the **Enable zero-crossing detection** parameter is selected on the **Attributes** pane. However, this parameter is only in affect if the **Zero-crossing control**, on the **Solver** pane of the Configuration Parameters dialog box, is set to Use local settings. For more information, see “Zero-Crossing Detection”.

Reinitializing dx/dt When x Reaches Saturation

For certain modeling applications, dx/dt must be reinitialized when state x reaches its limits in order to pull x out of saturation immediately. You can achieve this by selecting **Reinitialize dx/dt when x reaches saturation** on the **Attributes** pane.

If this option is on, then at the instant when x reaches saturation, Simulink checks whether the current value of the dx/dt initial condition (parameter or signal) allows the state x to leave saturation immediately. If so, Simulink reinitializes state dx/dt with the value of the initial condition (parameter or signal) at that instant. If not, Simulink ignores this parameter at the current instant and sets dx/dt to zero to make the block states consistent.

This parameter only applies at the time when x actually reaches saturation limit. It does not apply at any future time when x is being held at saturation.

Refer to the sections on limiting the states for more information. For an example, see “Simulation of a Bouncing Ball” on page 13-5.

Disregarding State Limits and External Reset for Linearization

For cases where you simplify your model by linearizing it, you can have Simulink disregard the limits of the states and the external reset by selecting **Ignore state limits and the reset for linearization**.

Specifying the Absolute Tolerance for the Block Outputs

By default Simulink software uses the absolute tolerance value specified in the Configuration Parameters dialog box (see “Error Tolerances for Variable-Step Solvers”) to compute the output of the integrator blocks. If this value does not provide sufficient error control, specify a more appropriate value for state x in the **Absolute tolerance x** field and for state dx/dt in the **Absolute tolerance dx/dt** field of the parameter dialog box. Simulink uses the values that you specify to compute the state values of the block.

Specifying the Display of the Output Ports

You can control whether to display the x or the dx/dt output port using the ShowOutput parameter. You can display one output port or both; however, you must select at least one.

Specifying the State Names

You can specify the name of x states and dx/dt states using the StateNameX and StateNameDXDT parameters. However, you must specify names for both or neither; you cannot specify names for just x

or just dx/dt . Both state names must have identical type and length. Furthermore, the number of names must evenly divide the number of states.

Selecting All Options

When you select all options, the block icon looks like this.

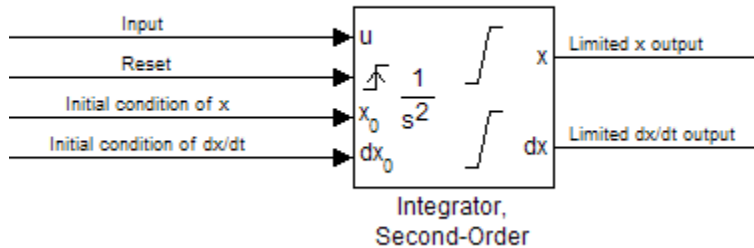

Ports

Input

u — Input signal **u**

scalar | vector | matrix

Input signal **u** to the integrator system, specified as a scalar, vector, or matrix.

Data Types: double

x0 — Initial condition **x0**

scalar | vector | matrix

External signal specifying the initial condition **x0** to the integrator system. You can specify the initial condition as a scalar, vector, or matrix.

Dependencies

To enable this input port, set the **Initial condition source x** parameter to `external`.

Data Types: double

dx0 — Initial condition **dx0**

scalar | vector | matrix

External signal specifying the initial condition **dx0** to the integrator system. You can specify the initial condition **dx0** as a scalar, vector, or matrix.

Dependencies

To enable this input port, set the **Initial condition source dx/dt** parameter to `external`.

Data Types: double

Output

x — Output signal x

scalar | vector | matrix

x state output signal, provided as a scalar, vector, or matrix.

Data Types: double

dx — Output signal dx

scalar | vector | matrix

dx state output signal, specified as a scalar, vector, or matrix.

Data Types: double

Parameters

x

Initial condition source x — Source of initial condition for state x

internal (default) | external

Specify the source of the initial conditions for state x.

- `internal` — Get the initial conditions of state x from the **Initial condition x** parameter.
- `external` — Get the initial conditions of state x from an external block connected to the **X₀** input port.

Limitations

Simulink software does not allow the initial condition of this block to be `inf` or `NaN`.

Dependencies

Selecting `internal` enables the **Initial condition x** parameter and removes the **X₀** input port.

Selecting `external` disables the **Initial condition x** parameter and enables the **X₀** input port.

Programmatic Use

Block Parameter: `ICSourceX`

Type: character vector, string

Values: `'internal'` | `'external'`

Default: `'internal'`

Initial condition x — Initial condition of state x

0.0 (default) | scalar | vector | matrix

Specify the initial condition of state x.

Limitations

Simulink software does not allow the initial condition of this block to be `inf` or `NaN`.

Dependencies

To enable this parameter, set **Initial condition source x** to `internal`.

Setting **Initial condition source x** to external disables this parameter and enables the X_0 input port.

Programmatic Use

Block Parameter: ICX

Type: character vector, string

Values: scalar | vector | matrix

Default: '0.0'

Limit x – Limit values of state x

off | on

Limit state x of the block to a value between the **Lower limit x** and **Upper limit x** parameters. The default value of the Second-Order Integrator block is off. The default value of the Second-Order Integrator Limited is on.

- To limit state x to a value between the **Lower limit x** and **Upper limit x** parameters, select this check box.
- To remove range limitations on state x , clear this check box.

Dependencies

Selecting this check box enables the **Upper limit x** and **Lower limit x** parameters.

Programmatic Use

Block Parameter: LimitX

Type: character vector, string

Values: 'off' | 'on'

Default: 'off' (Second-Order Integrator) | 'on' (Second-Order Integrator Limited)

Upper limit x – Upper limit of state x

1 | inf | scalar | vector | matrix

Specify the upper limit of state x . The default value for the Second-Order Integrator block is inf. The default value for the Second-Order Integrator Limited block is 1.

Tips

The upper saturation limit for state x must be strictly greater than the lower saturation limit.

Dependencies

To enable this parameter, select the **Limit x** check box.

Programmatic Use

Block Parameter: UpperLimitX

Type: character vector, string

Values: '1' | 'inf' | scalar | vector | matrix

Default: '1' (Second-Order Integrator Limited) | 'inf' (Second-Order Integrator)

Lower limit x – Lower limit of state x

0 (default) | -inf | scalar | vector | matrix

Specify the lower limit of state x . The default value for the Second-Order Integrator block is -inf. The default value for the Second-Order Integrator Limited block is 0.

Tip

The lower saturation limit for state x must be strictly less than the upper saturation limit.

Dependencies

To enable this parameter, select the **Limit x** check box.

Programmatic Use

Block Parameter: LowerLimitX

Type: character vector, string

Values: '0' | '-inf' | scalar | vector | matrix

Default: '0' (Second-Order Integrator Limited) | '-inf' (Second-Order Integrator)

Wrap x — Enable wrapping of x

off (default) | on

Enable wrapping of x between the **Wrapped upper value x** and **Wrapped lower value x** parameters. Enabling wrapping of x eliminates the need for zero-crossing detection, reduces solver resets, improves solver performance and accuracy, and increases simulation time span when modeling rotary and cyclic state trajectories.

If you specify **Wrapped upper value x** as `inf` and **Wrapped lower value x** as `-inf`, wrapping will never occur.

Dependencies

Selecting this check box enables **Wrapped upper value x** and **Wrapped lower value x** .

Programmatic Use

Block Parameter: WrapX

Type: character vector, string

Values: 'off' | 'on'

Default: 'off'

Wrapped upper value x — Upper value for wrapping x

π (default) | scalar | vector | matrix

Specify the upper value for wrapping x .

Dependencies

To enable this parameter, select the **Wrap x** check box.

Programmatic Use

Block Parameter: WrappedUpperValueX

Type: character vector, string

Values: scalar | vector | matrix

Default: 'pi'

Wrapped lower value x — Lower value for wrapping x

$-\pi$ (default) | scalar | vector | matrix

Specify the lower value for wrapping x .

Dependencies

To enable this parameter, select the **Wrap x** check box.

Programmatic Use**Block Parameter:** WrappedLowerValueX**Type:** character vector, string**Values:** scalar | vector | matrix**Default:** '-pi'**Absolute tolerance x — Absolute tolerance for computing state x**

auto (default) | -1 | scalar | vector

Specify the absolute tolerance for computing state x .

- You can enter `auto`, `-1`, a positive real scalar or vector.
- If you enter `auto` or `-1`, Simulink uses the absolute tolerance value in the Configuration Parameters dialog box (see “Solver Pane”) to compute state x .
- If you enter a real scalar value, that value overrides the absolute tolerance in the Configuration Parameters dialog box and is used for computing all x states.
- If you enter a real vector, the dimension of that vector must match the dimension of state x . These values override the absolute tolerance in the Configuration Parameters dialog box.

Programmatic Use**Block Parameter:** AbsoluteToleranceX**Type:** character vector, string**Values:** 'auto' | '-1' | any positive real scalar or vector**Default:** 'auto'**State name x — Name for state x**

' ' (default) | character vector | string

Assign a unique name to state x .**Tips**

- To assign a name to a single state, enter the name between quotes, for example, `position'`.
- To assign names to multiple x states, enter a comma-delimited list surrounded by braces, for example, `{'a', 'b', 'c'}`. Each name must be unique.
- The state names apply only to the selected block.
- If you specify a state name for x , you must also specify a state name for dx/dt .
- State names for x and dx/dt must have identical types and lengths.
- The number of states must be evenly divided by the number of state names. You can specify fewer names than x states, but you cannot specify more names than x states. For example, you can specify two names in a system with four states. The first name applies to the first two states and the second name to the last two states. However, you must be consistent and apply the same scheme to the state names for dx/dt .
- To assign state names with a variable in the MATLAB workspace, enter the variable without quotes. A variable can be a character vector, string or a cell array.

Programmatic Use**Block Parameter:** StateNameX**Type:** character vector, string**Values:** ' ' | user-defined**Default:** ' '

dx/dt**Initial condition source dx/dt — Source of initial condition for state dx/dt** `internal` (default) | `external`

Specify the source of initial conditions for state dx/dt as `internal` or `external`.

Limitations

Simulink software does not allow the initial condition of this block to be `inf` or `NaN`.

Dependencies

- Selecting `internal` enables the **Initial condition dx/dt** parameter and removes the **dx₀** input port.
- Selecting `external` disables the **Initial condition dx/dt** parameter and enables the **dx₀** input port.

Programmatic Use**Block Parameter:** `ICSourceDXDT`**Type:** character vector**Values:** `'internal'` | `'external'`**Default:** `'internal'`**Initial condition dx/dt — Initial condition of state dx/dt** `0.0` (default) | `scalar` | `vector` | `matrix`

Specify the initial condition of state dx/dt .

Limitations

Simulink software does not allow the initial condition of this block to be `inf` or `NaN`.

Dependencies

- Setting **Initial condition source dx/dt** to `internal` enables this parameter.
- Setting **Initial condition source dx/dt** to `external` disables this parameter.

Programmatic Use**Block Parameter:** `ICDXDT`**Type:** character vector**Values:** `scalar` | `vector` | `matrix`**Default:** `'0.0'`**Limit dx/dt — Limit values of state dx/dt** `off` | `on`

Limit the dx/dt state of the block to a value between the **Lower limit dx/dt** and **Upper limit dx/dt** parameters. The default value of the Second-Order Integrator block is `off`. The default value of the Second-Order Integrator Limited is `on`.

Tip

If you set saturation limits for x , then the interval defined by the **Upper limit dx/dt** and **Lower limit dx/dt** must contain zero.

Dependencies

Selecting this check box enables the **Upper limit dx/dt** and **Lower limit dx/dt** parameters.

Programmatic Use

Parameter: LimitDXDT

Type: character vector

Values: 'off' | 'on'

Default: 'off' (Second-Order Integrator) | 'on' (Second-Order Integrator Limited)

Upper limit dx/dt — Upper limit of state dx/dt

inf (default) | scalar | vector | matrix

Specify the upper limit for state dx/dt .

Dependencies

If you limit x , then this parameter must have a strictly positive value.

To enable this parameter, select the **Limit dx/dt** check box.

Programmatic Use

Block Parameter: UpperLimitDXDT

Type: character vector

Values: scalar | vector | matrix

Default: 'inf'

Lower limit dx/dt — Lower limit of state dx/dt

-inf (default) | scalar | vector | matrix

Specify the lower limit for state dx/dt .

Dependencies

If you limit x , then this parameter must have a strictly negative value.

To enable this parameter, select the **Limit dx/dt** check box.

Programmatic Use

Block Parameter: LowerLimitDXDT

Type: character vector

Values: scalar | vector | matrix

Default: '-inf'

Absolute tolerance dx/dt — Absolute tolerance for computing state dx/dt

auto (default) | -1 | scalar | vector

Specify the absolute tolerance for computing state dx/dt .

- You can enter `auto`, `-1`, a positive real scalar or vector.
- If you enter `auto` or `-1`, then Simulink uses the absolute tolerance value in the Configuration Parameters dialog box (see “Solver Pane”) to compute the dx/dt output of the block.
- If you enter a numeric value, that value overrides the absolute tolerance in the Configuration Parameters dialog box.

Programmatic Use**Block Parameter:** AbsoluteToleranceDXDT**Type:** character vector, string, scalar, or vector**Values:** 'auto' | '-1' | any positive real scalar or vector**Default:** 'auto'**State name dx/dt — Name for state dx/dt**

' ' (default) | character vector | string

Assign a unique name to state dx/dt .**Tips**

- To assign a name to a single state, enter the name between quotes, for example, 'velocity'.
- To assign names to multiple dx/dt states, enter a comma-delimited list surrounded by braces, for example, {'a', 'b', 'c'}. Each name must be unique.
- The state names apply only to the selected block.
- If you specify a state name for dx/dt , you must also specify a state name for x .
- State names for x and dx/dt must have identical types and lengths.
- The number of states must be evenly divided by the number of state names. You can specify fewer names than dx/dt states, but you cannot specify more names than dx/dt states. For example, you can specify two names in a system with four states. The first name applies to the first two states and the second name to the last two states. However, you must be consistent and apply the same scheme to the state names for x .
- To assign state names with a variable in the MATLAB workspace, enter the variable without quotes. A variable can be a character vector, string, or a cell array.

Programmatic Use**Block Parameter:** StateNameDXDT**Type:** character vector, string**Values:** ' ' | user-defined**Default:** ' '**Attributes****External reset — Reset states to their initial conditions**

none (default) | rising | falling | either

Reset the states to their initial conditions when a trigger event occurs in the reset signal.

- **none** — Do not reset the state to initial conditions.
- **rising** — Reset the state when the reset signal rises from a zero to a positive value or from a negative to a positive value.
- **falling** — Reset the state when the reset signal falls from a positive value to zero or from a positive to a negative value.
- **either** — Reset the state when the reset signal changes from zero to a nonzero value or changes sign.

Programmatic Use**Block Parameter:** ExternalReset**Type:** character vector, string

Values: 'none' | 'rising' | 'falling' | 'either'
Default: 'none'

Enable zero-crossing detection — Enable zero-crossing detection

on (default) | off

Select to enable zero-crossing detection. For more information, see “Zero-Crossing Detection”.

Programmatic Use

Parameter: ZeroCross

Type: character vector, string

Values: 'on' | 'off'

Default: 'on'

Reinitialize dx/dt when x reaches saturation — Reset dx/dt when x reaches saturation

off (default) | on

At the instant when state x reaches saturation, reset dx/dt to its current initial conditions.

Tip

The dx/dt initial condition must have a value that enables x to leave saturation immediately. Otherwise, Simulink ignores the initial conditions for dx/dt to preserve mathematical consistency of block states.

Programmatic Use

Block Parameter: ReinitDXDTwhenXreachesSaturation

Type: character vector, string

Values: 'off' | 'on'

Default: 'off'

Ignore state limits and the reset for linearization — Ignore state limits and external reset for linearization

off (default) | on

For linearization purposes, have Simulink ignore the specified state limits and the external reset.

Programmatic Use

Block Parameter: IgnoreStateLimitsAndResetForLinearization

Type: character vector, string

Values: 'off' | 'on'

Default: 'off'

Show output — Output ports to display

both (default) | x | dxdt

Specify the output ports on the block.

- both — Show both x and dx/dt output ports.
- x — Show only the x output port.
- dx/dt — Show only the dx/dt output port.

Programmatic Use

Block Parameter: ShowOutput

Type: character vector, string
Values: 'both' | 'x' | 'dxdt'
Default: 'both'

Block Characteristics

| | |
|---------------------------------|--------|
| Data Types | double |
| Direct Feedthrough | yes |
| Multidimensional Signals | no |
| Variable-Size Signals | no |
| Zero-Crossing Detection | yes |

Extended Capabilities

C/C++ Code Generation

Generate C and C++ code using Simulink® Coder™.

Not recommended for production-quality code. Relates to resource limits and restrictions on speed and memory often found in embedded systems. The code generated can contain dynamic allocation and freeing of memory, recursion, additional memory overhead, and widely-varying execution times. While the code is functionally valid and generally acceptable in resource-rich environments, smaller embedded targets often cannot support such code.

In general, consider using the Simulink Model Discretizer to map continuous blocks into discrete equivalents that support production code generation. To start the Model Discretizer, in the Simulink Editor, on the **Apps** tab, under **Apps**, under **Control Systems**, click **Model Discretizer**. One exception is the Second-Order Integrator block because, for this block, the Model Discretizer produces an approximate discretization.

See Also

Second-Order Integrator Limited | Integrator | Integrator Limited

Topics

“Zero-Crossing Detection”

“Error Tolerances for Variable-Step Solvers”

“Algebraic Loop Concepts”

Introduced in R2010a

Second-Order Integrator Limited

Second-order integration of input signal

Library: Simulink / Continuous

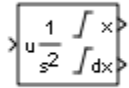

Description

The Second-Order Integrator block and the Second-Order Integrator Limited block solve the second-order initial value problem:

$$\begin{aligned}\frac{d^2x}{dt^2} &= u, \\ \frac{dx}{dt} \Big|_{t=0} &= dx_0, \\ x \Big|_{t=0} &= x_0,\end{aligned}$$

where u is the input to the system. The block is therefore a dynamic system with two continuous states: x and dx/dt .

Note These two states have a mathematical relationship, namely, that dx/dt is the derivative of x . To satisfy this relationship throughout the simulation, Simulink places various constraints on the block parameters and behavior.

The Second-Order Integrator Limited block is identical to the Second-Order Integrator block with the exception that it defaults to limiting the states based on the specified upper and lower limits. For more information, see “Limiting the States” on page 1-1562.

Simulink software can use several different numerical integration methods to compute the outputs of the block. Each has advantages for specific applications. Use the **Solver** pane of the Configuration Parameters dialog box to select the technique best suited to your application. (For more information, see “Solver Selection Criteria”.) The selected solver computes the states of the Second-Order Integrator block at the current time step using the current input value.

Use the block parameter dialog box to:

- Specify whether the source of each state initial condition is internal or external
- Specify a value for the state initial conditions
- Define upper and lower limits on either or both states
- Specify absolute tolerances for each state
- Specify names for both states
- Choose an external reset condition

- Enable zero-crossing detection
- Reinitialize dx/dt when x reaches saturation
- Specify that Simulink disregard the state limits and external reset for linearization operations

Defining Initial Conditions

You can define the initial conditions of each state individually as a parameter on the block dialog box or input one or both of them from an external signal.

- To define the initial conditions of state x as a block parameter, use the **Initial condition source x** drop-down menu to select `internal` and enter the value in the **Initial condition x** field.
- To provide the initial conditions from an external source for state x , specify the **Initial condition source x** parameter as `external`. An additional input port appears on the block.
- To define the initial conditions of state dx/dt as a block parameter, use the **Initial condition source dx/dt** drop-down menu to select `internal` and enter the value in the **Initial condition dx/dt** field.
- To provide the initial conditions from an external source for state dx/dt , specify **Initial condition source dx/dt** as `external`. An additional input port appears on the block.

If you choose to use an external source for both state initial conditions, your block appears as follows.

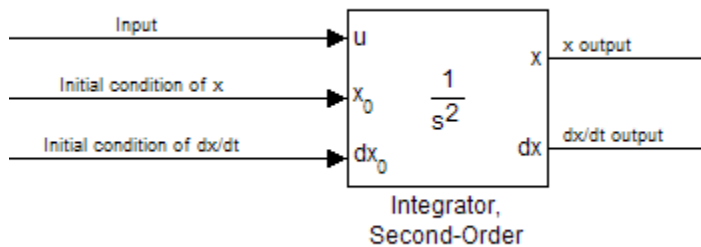

Note

- Simulink does not allow initial condition values of `inf` or `NaN`.
- If you limit state x or state dx/dt by specifying saturation limits (see "Limiting the States" on page 1-1562) and one or more initial conditions are outside the corresponding limits, then the respective states are initialized to the closest valid value and a set of consistent initial conditions is calculated.

Limiting the States

When modeling a second-order system, you may need to limit the block states. For example, the motion of a piston within a cylinder is governed by Newton's Second Law and has constraints on the piston position (x). With the Second-Order Integrator block, you can limit the states x and dx/dt independent of each other. You can even change the limits during simulation; however, you cannot change whether or not the states are limited. An important rule to follow is that an upper limit must be strictly greater than its corresponding lower limit.

The block appearance changes when you limit one or both states. With both states limited, the block appears as follows.

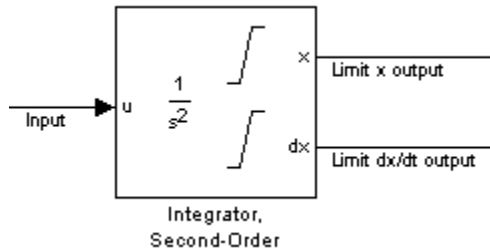

For each state, you can use the block parameter dialog box to set appropriate saturation limits.

Limiting x Only

If you use the Second-Order Integrator Limited block, both states are limited by default. But you can also manually limit state x on the Second-Order Integrator block by selecting **Limit x** and entering the limits in the appropriate parameter fields.

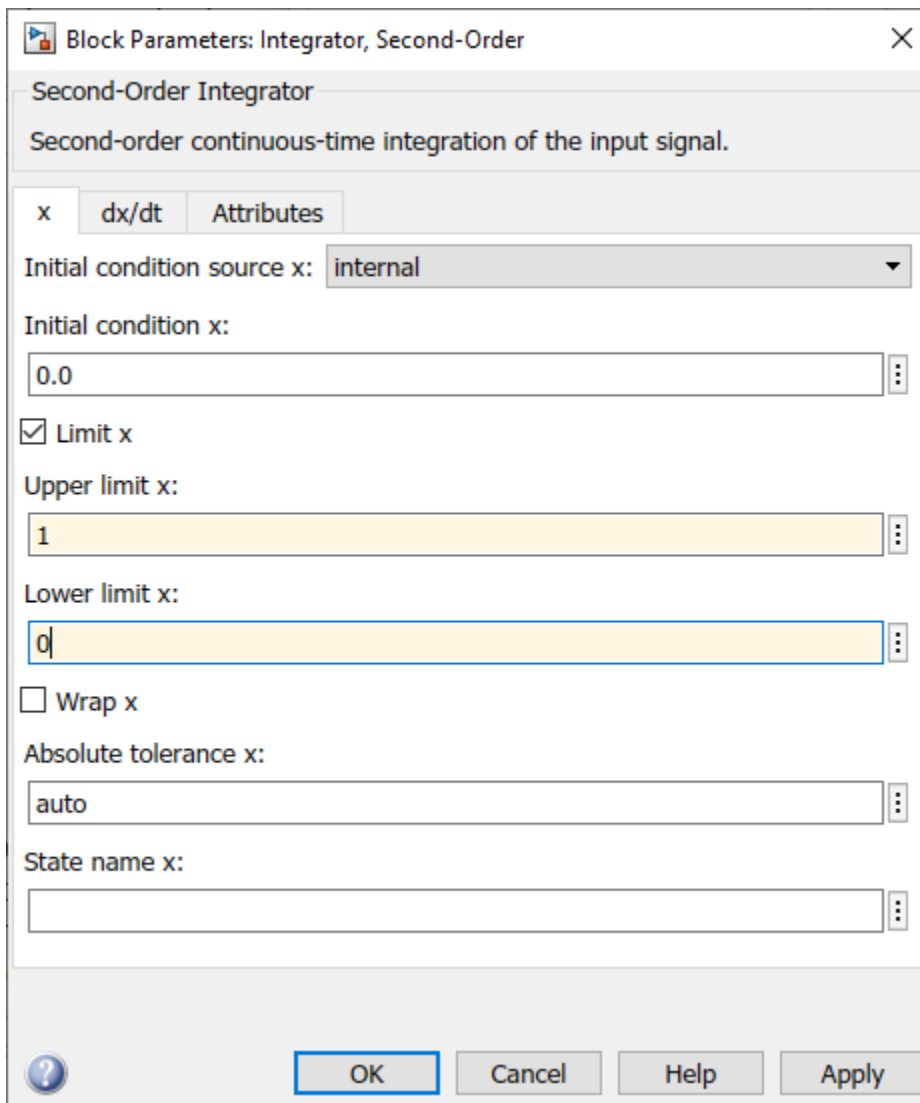

The block then determines the values of the states as follows:

- When x is less than or equal to its lower limit, the value of x is held at its lower limit and dx/dt is set to zero.
- When x is in between its lower and upper limits, both states follow the trajectory given by the second-order ODE.
- When x is greater than or equal to its upper limit, the value of x is held at its upper limit and dx/dt is set to zero.

You can choose to reinitialize dx/dt to a new value at the time when x reaches saturation. See “Reinitializing dx/dt When x Reaches Saturation” on page 1-1567.

Limiting dx/dt Only

As with state x , state dx/dt is set as limited by default on the **dx/dt** pane of the Second-Order Integrator Limited block dialog box. You can manually set this parameter, **Limit dx/dt**, on the Second-Order Integrator block. In either case, you must enter the appropriate limits for dx/dt .

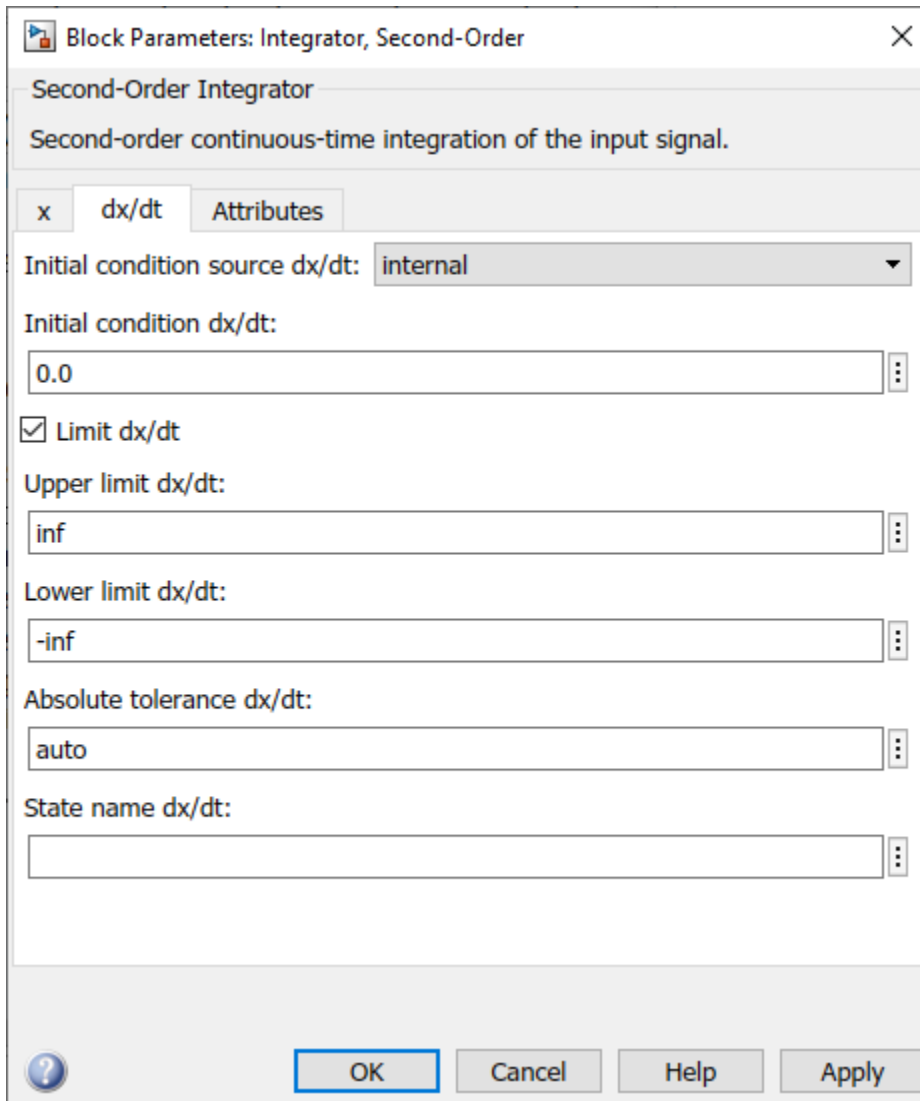

If you limit only the state dx/dt , then the block determines the values of dx/dt as follows:

- When dx/dt is less than or equal to its lower limit, the value of dx/dt is held at its lower limit.
- When dx/dt is in between its lower and upper limits, both states follow the trajectory given by the second-order ODE.
- When dx/dt is greater than or equal to its upper limit, the value of dx/dt is held at its upper limit.

When state dx/dt is held at its upper or lower limit, the value of x is governed by the first-order initial value problem:

$$\begin{aligned}\frac{dx}{dt} &= L, \\ x(t_L) &= x_L,\end{aligned}$$

where L is the dx/dt limit (upper or lower), t_L is the time when dx/dt reaches this limit, and x_L is the value of state x at that time.

Limiting Both States

When you limit both states, Simulink maintains mathematical consistency of the states by limiting the allowable values of the upper and lower limits for dx/dt . Such limitations are necessary to satisfy the following constraints:

- When x is at its saturation limits, the value of dx/dt must be zero.
- In order for x to leave the upper limit, the value of dx/dt must be strictly negative.
- In order for x to leave its lower limit, the value of dx/dt must be strictly positive.

For such cases, the upper limit of dx/dt must be strictly positive and the lower limit of dx/dt must be strictly negative.

When both states are limited, the block determines the states as follows:

- Whenever x reaches its limits, the resulting behavior is the same as that described in “Limiting x only”.
- Whenever dx/dt reaches one of its limits, the resulting behavior is the same as that described in “Limiting dx/dt only” — including the computation of x using a first-order ODE when dx/dt is held at one of its limits. In such cases, when x reaches one of its limits, it is held at that limit and dx/dt is set to zero.
- Whenever both reach their respective limits simultaneously, the state x behavior overrides dx/dt behavior to maintain consistency of the states.

When you limit both states, you can choose to reinitialize dx/dt at the time when state x reaches saturation. If the reinitialized value is outside specified limits on dx/dt , then dx/dt is reinitialized to the closest valid value and a consistent set of initial conditions is calculated. See “Reinitializing dx/dt When x Reaches Saturation” on page 1-1567

Resetting the State

The block can reset its states to the specified initial conditions based on an external signal. To cause the block to reset its states, select one of the **External reset** choices on the **Attributes** pane. A trigger port appears on the block below its input port and indicates the trigger type.

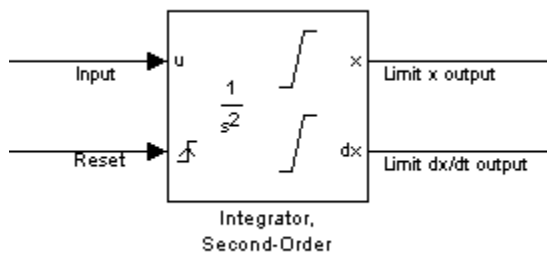

- Select **rising** to reset the states when the reset signal rises from zero to a positive value, from a negative to a positive value, or a negative value to zero.
- Select **falling** to reset the states when the reset signal falls from a positive value to zero, from a positive to a negative value, or from zero to negative.
- Select **either** to reset the states when the reset signal changes from zero to a nonzero value or changes sign.

The reset port has direct feedthrough. If the block output feeds back into this port, either directly or through a series of blocks with direct feedthrough, an algebraic loop results (see “Algebraic Loop Concepts”).

Enabling Zero-Crossing Detection

This parameter controls whether zero-crossing detection is enabled for this block. By default, the **Enable zero-crossing detection** parameter is selected on the **Attributes** pane. However, this parameter is only in affect if the **Zero-crossing control**, on the **Solver** pane of the Configuration Parameters dialog box, is set to Use local settings. For more information, see “Zero-Crossing Detection”.

Reinitializing dx/dt When x Reaches Saturation

For certain modeling applications, dx/dt must be reinitialized when state x reaches its limits in order to pull x out of saturation immediately. You can achieve this by selecting **Reinitialize dx/dt when x reaches saturation** on the **Attributes** pane.

If this option is on, then at the instant when x reaches saturation, Simulink checks whether the current value of the dx/dt initial condition (parameter or signal) allows the state x to leave saturation immediately. If so, Simulink reinitializes state dx/dt with the value of the initial condition (parameter or signal) at that instant. If not, Simulink ignores this parameter at the current instant and sets dx/dt to zero to make the block states consistent.

This parameter only applies at the time when x actually reaches saturation limit. It does not apply at any future time when x is being held at saturation.

Refer to the sections on limiting the states for more information. For an example, see “Simulation of a Bouncing Ball” on page 13-5.

Disregarding State Limits and External Reset for Linearization

For cases where you simplify your model by linearizing it, you can have Simulink disregard the limits of the states and the external reset by selecting **Ignore state limits and the reset for linearization**.

Specifying the Absolute Tolerance for the Block Outputs

By default Simulink software uses the absolute tolerance value specified in the Configuration Parameters dialog box (see “Error Tolerances for Variable-Step Solvers”) to compute the output of the integrator blocks. If this value does not provide sufficient error control, specify a more appropriate value for state x in the **Absolute tolerance x** field and for state dx/dt in the **Absolute tolerance dx/dt** field of the parameter dialog box. Simulink uses the values that you specify to compute the state values of the block.

Specifying the Display of the Output Ports

You can control whether to display the x or the dx/dt output port using the ShowOutput parameter. You can display one output port or both; however, you must select at least one.

Specifying the State Names

You can specify the name of x states and dx/dt states using the StateNameX and StateNameDXDT parameters. However, you must specify names for both or neither; you cannot specify names for just x

or just dx/dt . Both state names must have identical type and length. Furthermore, the number of names must evenly divide the number of states.

Selecting All Options

When you select all options, the block icon looks like this.

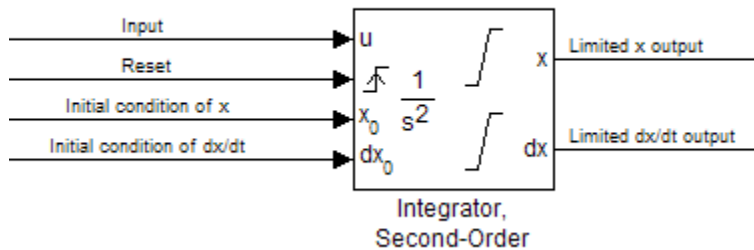

Ports

Input

u — Input signal u

scalar | vector | matrix

Input signal u to the integrator system, specified as a scalar, vector, or matrix.

Data Types: double

x0 — Initial condition x0

scalar | vector | matrix

External signal specifying the initial condition x_0 to the integrator system. You can specify the initial condition as a scalar, vector, or matrix.

Dependencies

To enable this input port, set the **Initial condition source x** parameter to external.

Data Types: double

dx0 — Initial condition dx0

scalar | vector | matrix

External signal specifying the initial condition dx_0 to the integrator system. You can specify the initial condition dx_0 as a scalar, vector, or matrix.

Dependencies

To enable this input port, set the **Initial condition source dx/dt** parameter to external.

Data Types: double

Output

x — Output signal x

scalar | vector | matrix

x state output signal, provided as a scalar, vector, or matrix.

Data Types: double

dx — Output signal dx

scalar | vector | matrix

dx state output signal, specified as a scalar, vector, or matrix.

Data Types: double

Parameters

x

Initial condition source x — Source of initial condition for state x

internal (default) | external

Specify the source of the initial conditions for state x.

- `internal` — Get the initial conditions of state x from the **Initial condition x** parameter.
- `external` — Get the initial conditions of state x from an external block connected to the **X₀** input port.

Limitations

Simulink software does not allow the initial condition of this block to be `inf` or `NaN`.

Dependencies

Selecting `internal` enables the **Initial condition x** parameter and removes the **X₀** input port.

Selecting `external` disables the **Initial condition x** parameter and enables the **X₀** input port.

Programmatic Use

Block Parameter: `ICSourceX`

Type: character vector, string

Values: `'internal'` | `'external'`

Default: `'internal'`

Initial condition x — Initial condition of state x

0.0 (default) | scalar | vector | matrix

Specify the initial condition of state x.

Limitations

Simulink software does not allow the initial condition of this block to be `inf` or `NaN`.

Dependencies

To enable this parameter, set **Initial condition source x** to `internal`.

Setting **Initial condition source x** to external disables this parameter and enables the X_0 input port.

Programmatic Use

Block Parameter: ICX

Type: character vector, string

Values: scalar | vector | matrix

Default: '0.0'

Limit x – Limit values of state x

off | on

Limit state x of the block to a value between the **Lower limit x** and **Upper limit x** parameters. The default value of the Second-Order Integrator block is off. The default value of the Second-Order Integrator Limited is on.

- To limit state x to a value between the **Lower limit x** and **Upper limit x** parameters, select this check box.
- To remove range limitations on state x , clear this check box.

Dependencies

Selecting this check box enables the **Upper limit x** and **Lower limit x** parameters.

Programmatic Use

Block Parameter: LimitX

Type: character vector, string

Values: 'off' | 'on'

Default: 'off' (Second-Order Integrator) | 'on' (Second-Order Integrator Limited)

Upper limit x – Upper limit of state x

1 | inf | scalar | vector | matrix

Specify the upper limit of state x . The default value for the Second-Order Integrator block is inf. The default value for the Second-Order Integrator Limited block is 1.

Tips

The upper saturation limit for state x must be strictly greater than the lower saturation limit.

Dependencies

To enable this parameter, select the **Limit x** check box.

Programmatic Use

Block Parameter: UpperLimitX

Type: character vector, string

Values: '1' | 'inf' | scalar | vector | matrix

Default: '1' (Second-Order Integrator Limited) | 'inf' (Second-Order Integrator)

Lower limit x – Lower limit of state x

0 (default) | -inf | scalar | vector | matrix

Specify the lower limit of state x . The default value for the Second-Order Integrator block is -inf. The default value for the Second-Order Integrator Limited block is 0.

Tip

The lower saturation limit for state x must be strictly less than the upper saturation limit.

Dependencies

To enable this parameter, select the **Limit x** check box.

Programmatic Use

Block Parameter: LowerLimitX

Type: character vector, string

Values: '0' | '-inf' | scalar | vector | matrix

Default: '0' (Second-Order Integrator Limited) | '-inf' (Second-Order Integrator)

Wrap x — Enable wrapping of x

off (default) | on

Enable wrapping of x between the **Wrapped upper value x** and **Wrapped lower value x** parameters. Enabling wrapping of x eliminates the need for zero-crossing detection, reduces solver resets, improves solver performance and accuracy, and increases simulation time span when modeling rotary and cyclic state trajectories.

If you specify **Wrapped upper value x** as inf and **Wrapped lower value x** as $-inf$, wrapping will never occur.

Dependencies

Selecting this check box enables **Wrapped upper value x** and **Wrapped lower value x** .

Programmatic Use

Block Parameter: WrapX

Type: character vector, string

Values: 'off' | 'on'

Default: 'off'

Wrapped upper value x — Upper value for wrapping x

π (default) | scalar | vector | matrix

Specify the upper value for wrapping x .

Dependencies

To enable this parameter, select the **Wrap x** check box.

Programmatic Use

Block Parameter: WrappedUpperValueX

Type: character vector, string

Values: scalar | vector | matrix

Default: 'pi'

Wrapped lower value x — Lower value for wrapping x

$-\pi$ (default) | scalar | vector | matrix

Specify the lower value for wrapping x .

Dependencies

To enable this parameter, select the **Wrap x** check box.

Programmatic Use**Block Parameter:** WrappedLowerValueX**Type:** character vector, string**Values:** scalar | vector | matrix**Default:** '-pi'**Absolute tolerance x — Absolute tolerance for computing state x**

auto (default) | -1 | scalar | vector

Specify the absolute tolerance for computing state x .

- You can enter `auto`, `-1`, a positive real scalar or vector.
- If you enter `auto` or `-1`, Simulink uses the absolute tolerance value in the Configuration Parameters dialog box (see “Solver Pane”) to compute state x .
- If you enter a real scalar value, that value overrides the absolute tolerance in the Configuration Parameters dialog box and is used for computing all x states.
- If you enter a real vector, the dimension of that vector must match the dimension of state x . These values override the absolute tolerance in the Configuration Parameters dialog box.

Programmatic Use**Block Parameter:** AbsoluteToleranceX**Type:** character vector, string**Values:** 'auto' | '-1' | any positive real scalar or vector**Default:** 'auto'**State name x — Name for state x**

' ' (default) | character vector | string

Assign a unique name to state x .

Tips

- To assign a name to a single state, enter the name between quotes, for example, `position'`.
- To assign names to multiple x states, enter a comma-delimited list surrounded by braces, for example, `{'a', 'b', 'c'}`. Each name must be unique.
- The state names apply only to the selected block.
- If you specify a state name for x , you must also specify a state name for dx/dt .
- State names for x and dx/dt must have identical types and lengths.
- The number of states must be evenly divided by the number of state names. You can specify fewer names than x states, but you cannot specify more names than x states. For example, you can specify two names in a system with four states. The first name applies to the first two states and the second name to the last two states. However, you must be consistent and apply the same scheme to the state names for dx/dt .
- To assign state names with a variable in the MATLAB workspace, enter the variable without quotes. A variable can be a character vector, string or a cell array.

Programmatic Use**Block Parameter:** StateNameX**Type:** character vector, string**Values:** ' ' | user-defined**Default:** ' '

dx/dt**Initial condition source dx/dt — Source of initial condition for state dx/dt**

internal (default) | external

Specify the source of initial conditions for state dx/dt as `internal` or `external`.

Limitations

Simulink software does not allow the initial condition of this block to be `inf` or `NaN`.

Dependencies

- Selecting `internal` enables the **Initial condition dx/dt** parameter and removes the dx_0 input port.
- Selecting `external` disables the **Initial condition dx/dt** parameter and enables the dx_0 input port.

Programmatic Use**Block Parameter:** ICSourceDXDT**Type:** character vector**Values:** 'internal' | 'external'**Default:** 'internal'**Initial condition dx/dt — Initial condition of state dx/dt**

0.0 (default) | scalar | vector | matrix

Specify the initial condition of state dx/dt .

Limitations

Simulink software does not allow the initial condition of this block to be `inf` or `NaN`.

Dependencies

- Setting **Initial condition source dx/dt** to `internal` enables this parameter.
- Setting **Initial condition source dx/dt** to `external` disables this parameter.

Programmatic Use**Block Parameter:** ICDXDT**Type:** character vector**Values:** scalar | vector | matrix**Default:** '0.0'**Limit dx/dt — Limit values of state dx/dt**

off | on

Limit the dx/dt state of the block to a value between the **Lower limit dx/dt** and **Upper limit dx/dt** parameters. The default value of the Second-Order Integrator block is `off`. The default value of the Second-Order Integrator Limited is `on`.

Tip

If you set saturation limits for x , then the interval defined by the **Upper limit dx/dt** and **Lower limit dx/dt** must contain zero.

Dependencies

Selecting this check box enables the **Upper limit dx/dt** and **Lower limit dx/dt** parameters.

Programmatic Use

Parameter: LimitDXDT

Type: character vector

Values: 'off' | 'on'

Default: 'off' (Second-Order Integrator) | 'on' (Second-Order Integrator Limited)

Upper limit dx/dt — Upper limit of state dx/dt

inf (default) | scalar | vector | matrix

Specify the upper limit for state dx/dt .

Dependencies

If you limit x , then this parameter must have a strictly positive value.

To enable this parameter, select the **Limit dx/dt** check box.

Programmatic Use

Block Parameter: UpperLimitDXDT

Type: character vector

Values: scalar | vector | matrix

Default: 'inf'

Lower limit dx/dt — Lower limit of state dx/dt

-inf (default) | scalar | vector | matrix

Specify the lower limit for state dx/dt .

Dependencies

If you limit x , then this parameter must have a strictly negative value.

To enable this parameter, select the **Limit dx/dt** check box.

Programmatic Use

Block Parameter: LowerLimitDXDT

Type: character vector

Values: scalar | vector | matrix

Default: '-inf'

Absolute tolerance dx/dt — Absolute tolerance for computing state dx/dt

auto (default) | -1 | scalar | vector

Specify the absolute tolerance for computing state dx/dt .

- You can enter `auto`, `-1`, a positive real scalar or vector.
- If you enter `auto` or `-1`, then Simulink uses the absolute tolerance value in the Configuration Parameters dialog box (see “Solver Pane”) to compute the dx/dt output of the block.
- If you enter a numeric value, that value overrides the absolute tolerance in the Configuration Parameters dialog box.

Programmatic Use**Block Parameter:** AbsoluteToleranceDXDT**Type:** character vector, string, scalar, or vector**Values:** 'auto' | '-1' | any positive real scalar or vector**Default:** 'auto'**State name dx/dt — Name for state dx/dt**

' ' (default) | character vector | string

Assign a unique name to state dx/dt .**Tips**

- To assign a name to a single state, enter the name between quotes, for example, 'velocity'.
- To assign names to multiple dx/dt states, enter a comma-delimited list surrounded by braces, for example, {'a', 'b', 'c'}. Each name must be unique.
- The state names apply only to the selected block.
- If you specify a state name for dx/dt , you must also specify a state name for x .
- State names for x and dx/dt must have identical types and lengths.
- The number of states must be evenly divided by the number of state names. You can specify fewer names than dx/dt states, but you cannot specify more names than dx/dt states. For example, you can specify two names in a system with four states. The first name applies to the first two states and the second name to the last two states. However, you must be consistent and apply the same scheme to the state names for x .
- To assign state names with a variable in the MATLAB workspace, enter the variable without quotes. A variable can be a character vector, string, or a cell array.

Programmatic Use**Block Parameter:** StateNameDXDT**Type:** character vector, string**Values:** ' ' | user-defined**Default:** ' '**Attributes****External reset — Reset states to their initial conditions**

none (default) | rising | falling | either

Reset the states to their initial conditions when a trigger event occurs in the reset signal.

- **none** — Do not reset the state to initial conditions.
- **rising** — Reset the state when the reset signal rises from a zero to a positive value or from a negative to a positive value.
- **falling** — Reset the state when the reset signal falls from a positive value to zero or from a positive to a negative value.
- **either** — Reset the state when the reset signal changes from zero to a nonzero value or changes sign.

Programmatic Use**Block Parameter:** ExternalReset**Type:** character vector, string

Values: 'none' | 'rising' | 'falling' | 'either'
Default: 'none'

Enable zero-crossing detection — Enable zero-crossing detection

on (default) | off

Select to enable zero-crossing detection. For more information, see “Zero-Crossing Detection”.

Programmatic Use

Parameter: ZeroCross

Type: character vector, string

Values: 'on' | 'off'

Default: 'on'

Reinitialize dx/dt when x reaches saturation — Reset dx/dt when x reaches saturation

off (default) | on

At the instant when state x reaches saturation, reset dx/dt to its current initial conditions.

Tip

The dx/dt initial condition must have a value that enables x to leave saturation immediately. Otherwise, Simulink ignores the initial conditions for dx/dt to preserve mathematical consistency of block states.

Programmatic Use

Block Parameter: ReinitDXDTwhenXreachesSaturation

Type: character vector, string

Values: 'off' | 'on'

Default: 'off'

Ignore state limits and the reset for linearization — Ignore state limits and external reset for linearization

off (default) | on

For linearization purposes, have Simulink ignore the specified state limits and the external reset.

Programmatic Use

Block Parameter: IgnoreStateLimitsAndResetForLinearization

Type: character vector, string

Values: 'off' | 'on'

Default: 'off'

Show output — Output ports to display

both (default) | x | dxdt

Specify the output ports on the block.

- both — Show both x and dx/dt output ports.
- x — Show only the x output port.
- dx/dt — Show only the dx/dt output port.

Programmatic Use

Block Parameter: ShowOutput

Type: character vector, string
Values: 'both' | 'x' | 'dxdt'
Default: 'both'

Block Characteristics

| | |
|---------------------------------|--------|
| Data Types | double |
| Multidimensional Signals | No |
| Variable-Size Signals | No |

Extended Capabilities

C/C++ Code Generation

Generate C and C++ code using Simulink® Coder™.

Not recommended for production-quality code. Relates to resource limits and restrictions on speed and memory often found in embedded systems. The code generated can contain dynamic allocation and freeing of memory, recursion, additional memory overhead, and widely-varying execution times. While the code is functionally valid and generally acceptable in resource-rich environments, smaller embedded targets often cannot support such code.

In general, consider using the Simulink Model Discretizer to map continuous blocks into discrete equivalents that support production code generation. To start the Model Discretizer, in the Simulink Editor, on the **Apps** tab, under **Apps**, under **Control Systems**, click **Model Discretizer**. One exception is the Second-Order Integrator block because, for this block, the Model Discretizer produces an approximate discretization.

See Also

Second-Order Integrator | Integrator | Integrator Limited

Topics

“Zero-Crossing Detection”

“Error Tolerances for Variable-Step Solvers”

“Algebraic Loop Concepts”

Introduced in R2010a

Selector

Select input elements from vector, matrix, or multidimensional signal

Library: Simulink / Signal Routing
HDL Coder / Signal Routing



Description

The Selector block generates as output selected or reordered elements of an input vector, matrix, or multidimensional signal.

Based on the value you enter for the **Number of input dimensions** parameter, a table of indexing settings is displayed. Each row of the table corresponds to one of the input dimensions in **Number of input dimensions**. For each dimension, you define the elements of the signal to work with. Specify a vector signal as a 1-D signal and a matrix signal as a 2-D signal. When you configure the Selector block for multidimensional signal operations, the block icon changes.

For example, assume a 6-D signal with a one-based index mode. The table of the Selector block dialog changes to include one row for each dimension. If you define dimensions as shown in the next table, the output is $Y = U(1:\text{end}, 2:6, [1\ 3\ 5], \text{Idx}4:\text{Idx}4+7, \text{Idx}5, \text{Idx}6(1):\text{Idx}6(2))$, where $\text{Idx}4$, $\text{Idx}5$, and $\text{Idx}6$ are the index ports for dimensions 4, 5, and 6.

| Row | Index Option | Index | Output Size |
|-----|------------------------------------|---------|-------------|
| 1 | Select all | | |
| 2 | Starting index (dialog) | 2 | 5 |
| 3 | Index vector (dialog) | [1 3 5] | |
| 4 | Starting index (port) | | 8 |
| 5 | Index vector (port) | | |
| 6 | Starting and ending indices (port) | | |

You can use an array of buses as an input signal to a Selector block. For details about defining and using an array of buses, see “Group Nonvirtual Buses in Arrays of Buses”.

Ports

Input

Port_1 — Input signal

scalar | vector | matrix | multidimensional

Input signal and source of elements to output signal.

Data Types: single | double | half | int8 | int16 | int32 | int64 | uint8 | uint16 | uint32 | uint64 | Boolean | fixed point | enumerated | bus

IndxN — Nth index signal

scalar | vector | matrix

External port specifying an index for the selection of the corresponding output element.

Dependencies

To enable an external index port, in the corresponding row of the **Index Option** table, set **Index Option** to Index vector (port), Starting index (port), or Starting and ending indices (port).

Data Types: single | double | int8 | int16 | int32 | uint8 | uint16 | uint32

Output

Port_1 — Output signal

scalar | vector | matrix | multidimensional

Output signal generated from selected or reordered elements of input signal.

Data Types: single | double | half | int8 | int16 | int32 | int64 | uint8 | uint16 | uint32 | uint64 | Boolean | fixed point | enumerated | bus

Parameters

Number of input dimensions — Number of dimensions of the input signal

1 (default) | integer

Specifies the number of dimensions of the input signal.

Programmatic Use

Block Parameter: NumberOfDimensions

Type: character vector

Values: integer

Default: '1'

Index mode — Index mode

One-based (default) | Zero-based

Specifies the indexing mode. If One-based is selected, an index of 1 specifies the first element of the input vector. If Zero-based is selected, an index of 0 specifies the first element of the input vector.

Programmatic Use

Block Parameter: IndexMode

Type: character vector

Values: 'One-based' | 'Zero-based'

Default: 'One-based'

Index Option — Index method for elements

Index vector (dialog) (default) | Select all | Index vector (port) | Starting index (dialog) | Starting index (port) | Starting and ending indices (port)

Defines, by dimension, how the elements of the signal are to be indexed. From the list, select:

- Select all

No further configuration is required. All elements are selected.

- Index vector (dialog)

Enables the **Index** column. Enter the vector of indices of the elements. Do not select this option when the input signal is variable-sized.

- Index vector (port)

No further configuration is required.

- Starting index (dialog)

Enables the **Index** and **Output Size** columns. Enter the starting index of the range of elements to select in the **Index** column and the number of elements to select in the **Output Size** column. Do not select this option when the input signal is variable-sized.

- Starting index (port)

Enables the **Output Size** column. Enter the number of elements to be selected in the **Output Size** column.

- Starting and ending indices (port)

No further configuration is required.

Using this option results in a variable-size output signal. When you update, the output dimension is set to be the same as the input signal dimension. During execution, the output dimension is updated based on the signal feeding the index.

When logging output signal data, signals not selected are padded with NaN values.

The **Index** and **Output Size** columns appear as needed.

Programmatic Use

Block Parameter: IndexOptionArray

Type: character vector

Values: 'Select all' | 'Index vector (dialog)' | 'Index option (port)' | 'Starting index (dialog)' | 'Starting index (port)' | Starting and ending indices (port)

Default: 'Index vector (dialog)'

Index — Index of elements

1 (default) | integer

If the **Index Option** is Index vector (dialog), enter the index of each element you are interested in.

If the **Index Option** is Starting index (dialog), enter the starting index of the range of elements to be selected.

Programmatic Use

Block Parameter: IndexParamArray

Type: character vector

Values: cell array

Default: '{ }'

Output Size — Width of the block output signal

1 (default) | integer

Specifies the width of the block output signal.

Programmatic Use

Block Parameter: OutputSizeArray

Type: character vector

Values: cell array

Default: '{ }'

Input port size — Width of the input signal

3 (default) | integer

Specify the width of the block input signal for 1-D signals. Enter -1 to inherit from the driving block.

Programmatic Use

Block Parameter: InputPortWidth

Type: character vector

Values: integer

Default: '1'

Sample time — Specify sample time as a value other than -1

-1 (default) | scalar | vector

Specify the sample time as a value other than -1. For more information, see “Specify Sample Time”.

Dependencies

This parameter is not visible unless it is explicitly set to a value other than -1. To learn more, see “Blocks for Which Sample Time Is Not Recommended”.

Programmatic Use

Block Parameter: SampleTime

Type: character vector

Values: scalar or vector

Default: '-1'

Block Characteristics

| | |
|---------------------------------|---|
| Data Types | Boolean double enumerated fixed point half integer single |
| Direct Feedthrough | no |
| Multidimensional Signals | yes |

| | |
|--------------------------------|-----|
| Variable-Size Signals | yes |
| Zero-Crossing Detection | no |

Extended Capabilities

C/C++ Code Generation

Generate C and C++ code using Simulink® Coder™.

HDL Code Generation

Generate Verilog and VHDL code for FPGA and ASIC designs using HDL Coder™.

HDL Coder provides additional configuration options that affect HDL implementation and synthesized logic.

HDL Architecture

This block has a single, default HDL architecture.

HDL Block Properties

| General | |
|----------------------------------|--|
| ConstrainedOutputPipeline | Number of registers to place at the outputs by moving existing delays within your design. Distributed pipelining does not redistribute these registers. The default is 0. For more details, see “ConstrainedOutputPipeline” (HDL Coder). |
| InputPipeline | Number of input pipeline stages to insert in the generated code. Distributed pipelining and constrained output pipelining can move these registers. The default is 0. For more details, see “InputPipeline” (HDL Coder). |
| OutputPipeline | Number of output pipeline stages to insert in the generated code. Distributed pipelining and constrained output pipelining can move these registers. The default is 0. For more details, see “OutputPipeline” (HDL Coder). |

| Native Floating Point | |
|------------------------|--|
| LatencyStrategy | Specify whether to map the blocks in your design to <code>inherit</code> , <code>Max</code> , <code>Min</code> , or <code>Zero</code> for the floating-point operator. The default is <code>inherit</code> . See also “LatencyStrategy” (HDL Coder). |

Complex Data Support

This block supports code generation for complex signals.

PLC Code Generation

Generate Structured Text code using Simulink® PLC Coder™.

Fixed-Point Conversion

Design and simulate fixed-point systems using Fixed-Point Designer™.

See Also

Assignment | Switch | Bus Selector

Introduced before R2006a

Sequence Viewer

Display messages, events, states, transitions, and functions between blocks during simulation

Library: Simulink / Messages & Events
 Simulink Test
 SimEvents
 Stateflow



Description

The Sequence Viewer block displays messages, events, states, transitions, and functions between certain blocks during simulation. The blocks that you can display are called lifeline blocks and include:

- Subsystems
- Referenced models
- Blocks that contain messages, such as Stateflow charts
- Blocks that call functions or generate events, such as Function Caller, Function-Call Generator, and MATLAB Function blocks
- Blocks that contain functions, such as Function-Call Subsystem and Simulink Function blocks

To see states, transitions, and events for lifeline blocks in a referenced model, you must have a Sequence Viewer block in the referenced model. Without a Sequence Viewer block in the referenced model, you can see only messages and functions for lifeline blocks in the referenced model.

Note The Sequence Viewer block does not display function calls generated by MATLAB Function blocks and S-functions.

Parameters

Time Precision for Variable Step — Digits for time increment precision

3 (default) | scalar

Number of digits for time increment precision. When using a variable step solver, change this parameter to adjust the time precision for the sequence viewer. By default the block supports 3 digits of precision.

Suppose the block displays two events that occur at times 0.1215 and 0.1219. Displaying these two events precisely requires 4 digits of precision. If the precision is 3, then the block displays two events at time 0.121.

Programmatic Use

Block Parameter: VariableStepTimePrecision

Type: character vector

Values: '3' | scalar
Default: '3'

History — Maximum number of previous events to display

5000 (default) | scalar

Total number of events before the last event to display.

For example, if **History** is 5 and there are 10 events in your simulation, then the block displays 6 events, including the last event and the five events prior the last event. Earlier events are not displayed. The time ruler is greyed to indicate the time between the beginning of the simulation and the time of the first displayed event.

Each send, receive, drop, or function call event is counted as one event, even if they occur at the same simulation time.

Programmatic Use

Block Parameter: History

Type: character vector

Values: '1000' | scalar

Default: '1000'

Block Characteristics

| | |
|---------------------------------|--|
| Data Types | Boolean bus double enumerated fixed point integer single |
| Direct Feedthrough | no |
| Multidimensional Signals | yes |
| Variable-Size Signals | no |
| Zero-Crossing Detection | no |

Extended Capabilities

C/C++ Code Generation

Generate C and C++ code using Simulink® Coder™.

This block can be used for visualizing message transitions during simulation, but is not included in the generated code.

HDL Code Generation

Generate Verilog and VHDL code for FPGA and ASIC designs using HDL Coder™.

This block displays messages during simulation when used in subsystems that generate HDL code, but it is not included in the hardware implementation.

See Also

“Use the Sequence Viewer to Visualize Messages, Events, and Entities” (SimEvents)

Introduced in R2015b

S-Function

Include S-function in model

Library: Simulink / User-Defined Functions

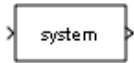

Description

The S-Function block provides access to S-functions from a block diagram. The S-function named as the **S-function name** parameter can be a Level-2 MATLAB or a Level-1 or Level-2 C MEX S-function (see “MATLAB S-Function Basics” for information on how to create S-functions).

Note Use the Level-2 MATLAB S-Function block to include a Level-2 MATLAB S-function in a block diagram.

The S-Function block displays the name of the specified S-function and the number of input and output ports specified by the S-function. Signals connected to the inputs must have the dimensions specified by the S-function for the inputs.

Parameters

S-function name — Name of the S-function

character array (default)

Use this parameter to specify the name of your S-function.

Programmatic Use

Block Parameter: FunctionName

Type: character vector

Value: name of the S-function

Default: 'system'

S-function parameters — Additional S-function parameters

cell array (default)

Specify the additional S-function parameters.

The function parameters can be specified as MATLAB expressions or as variables separated by commas. For example,

```
A, B, C, D, [eye(2,2);zeros(2,2)]
```

Note that although individual parameters can be enclosed in brackets, the list of parameters must not be enclosed in brackets.

Programmatic Use**Block Parameter:** Parameters**Type:** character vector**Value:** S-function parameters**Default:** ' '**S-function modules — List additional files for code generation**

cell array (default)

This parameter applies only if this block represents a C MEX S-function and you intend to use the Simulink Coder software to generate code from the model containing the block. If you use it, when you are ready to generate code, you must force the coder to rebuild the top model as explained in “Control Regeneration of Top Model Code” (Simulink Coder).

For more information on using this parameter, see “Specify Additional Source Files for an S-Function” (Simulink Coder).

Programmatic Use**Block Parameter:** SFunctionModules**Type:** character vector**Value:** character vector of file names**Default:** ' '**Block Characteristics**

| | |
|---------------------------------|--|
| Data Types | Boolean ^a bus ^a double ^a fixed point ^{ba} half ^a integer ^a single ^a string ^a |
| Direct Feedthrough | limited ^a |
| Multidimensional Signals | limited ^a |
| Variable-Size Signals | limited ^a |
| Zero-Crossing Detection | limited ^a |

a. Actual data type or capability support depends on block implementation.

b. See Writing Fixed-Point S-Functions for details on using fixed-point data types in S-functions.

Extended Capabilities**C/C++ Code Generation**

Generate C and C++ code using Simulink® Coder™.

- Actual code generation support depends on block implementation.
- S-functions that call into MATLAB are not supported for code generation.

Fixed-Point Conversion

Design and simulate fixed-point systems using Fixed-Point Designer™.

- Actual data type support depends on block implementation.
- See “Integrate External Code” (Fixed-Point Designer) for details on using fixed-point data types in S-functions.

See Also

Level-2 MATLAB S-Function | S-Function Builder

Topics

“Implementing S-Functions”

“Create a Basic C MEX S-Function”

“Write Level-2 MATLAB S-Functions”

Introduced before R2006a

S-Function Builder

Integrate C or C++ code to create S-functions

Library: Simulink / User-Defined Functions



Description

The S-function builder integrates new or existing C or C++ code and creates a C MEX S-function from specifications you provide. See “Use a Bus Signal with S-Function Builder to Create an S-Function” for detailed instructions on using the S-Function Builder block to generate an S-function.

Instances of the S-Function Builder block also serve as wrappers for generated S-functions in Simulink models. When simulating a model containing instances of an S-Function Builder block, Simulink software invokes the generated S-function in order to call your C or C++ code in the instance's `mdlStart`, `mdlOutputs`, `mdlDerivatives`, `mdlUpdate` and `mdlTerminate` methods. To learn how Simulink engine interacts with S-functions, see “Simulink Engine Interaction with C S-Functions”.

Note The S-Function Builder block does not support masking. However, you can mask a Subsystem block that contains an S-Function Builder block. For more information, see “Dynamic Masked Subsystem”.

Ports

Input

In — Input to an S-function builder

scalar | vector | matrix

The S-Function Builder can accept and complex, 1-D, or 2-D signals and nonvirtual buses. For each of these cases, the signals must have a data type that Simulink supports.

For more information, see “Data Types Supported by Simulink” in the Simulink documentation.

Data Types: `single` | `double` | `int8` | `int16` | `int32` | `int64` | `uint8` | `uint16` | `uint32` | `uint64` | `Boolean` | `fixed point` | `enumerated` | `bus`

Output

Out — Output from an S-function builder

scalar | vector | matrix

The S-Function Builder can output complex, 1-D, or 2-D signals and nonvirtual buses. For each of these cases, the signals must have a data type that Simulink supports.

For more information, see “Data Types Supported by Simulink” in the Simulink documentation.

Data Types: `single` | `double` | `int8` | `int16` | `int32` | `int64` | `uint8` | `uint16` | `uint32` | `uint64` | `Boolean` | `fixed point` | `enumerated` | `bus`

Parameters

See “Build S-Functions Automatically Using S-Function Builder” for information on parameters on the S-Function Builder editor.

Block Characteristics

| | |
|---------------------------------|--|
| Data Types | <code>Boolean</code> <code>double</code> <code>fixed point</code> <code>integer</code> <code>single</code> |
| Direct Feedthrough | no |
| Multidimensional Signals | yes |
| Variable-Size Signals | no |
| Zero-Crossing Detection | no |

Extended Capabilities

C/C++ Code Generation

Generate C and C++ code using Simulink® Coder™.

S-functions that call into MATLAB are not supported for code generation.

Fixed-Point Conversion

Design and simulate fixed-point systems using Fixed-Point Designer™.

See Also

S-Function | Level-2 MATLAB S-Function

Topics

“Use a Bus Signal with S-Function Builder to Create an S-Function”

“Build S-Functions Automatically Using S-Function Builder”

Introduced before R2006a

Shift Arithmetic

Shift bits or binary point of signal

Library: Simulink / Logic and Bit Operations
HDL Coder / Logic and Bit Operations

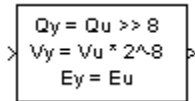

Description

The Shift Arithmetic block can shift the bits or the binary point of an input signal, or both.

For example, shifting the binary point on an input of data type `sfixed(8)` by two places to the right and left gives these decimal values.

| Shift Operation | Binary Value | Decimal Value |
|--|--------------|---------------|
| No shift (original number) | 11001.011 | -6.625 |
| Binary point shift right by two places | 1100101.1 | -26.5 |
| Binary point shift left by two places | 110.01011 | -1.65625 |

This block performs arithmetic bit shifts on signed numbers. Therefore, the block recycles the most significant bit for each bit shift. Shifting the bits on an input of data type `sfixed(8)` by two places to the right and left gives these decimal values.

| Shift Operation | Binary Value | Decimal Value |
|-------------------------------|--------------|---------------|
| No shift (original number) | 11001.011 | -6.625 |
| Bit shift right by two places | 11110.010 | -1.75 |
| Bit shift left by two places | 00101.100 | 5.5 |

Ports

Input

u – Number to be operated on

scalar | vector | array

Number to be operated on, specified as a scalar, vector, or array.

Data Types: `single` | `double` | `half` | `int8` | `int16` | `int32` | `int64` | `uint8` | `uint16` | `uint32` | `uint64` | `fixed point`

s – Number of bits to shift

scalar

Number of bits to shift, specified as a scalar.

Data Types: `single` | `double` | `half` | `int8` | `int16` | `int32` | `int64` | `uint8` | `uint16` | `uint32` | `uint64` | `fixed point`

Output**Port_1 — Result of operation**

scalar | vector | array

Result of operation, returned as a scalar, vector, or array.

Data Types: single | double | half | int8 | int16 | int32 | int64 | uint8 | uint16 | uint32 | uint64 | fixed point

Parameters**Bits to shift: Source — Source of bits to shift**

Dialog (default) | Input port

Specify whether to enter the bits to shift on the dialog box or to inherit the values from an input port.

Tunable: No**Programmatic Use****Block Parameter:** BitShiftNumberSource**Type:** character vector, string**Values:** 'Dialog' | 'Input port'**Default:** 'Dialog'**Bits to shift: Number — Bits to shift**

8 (default) | scalar

Specify a scalar, vector, or array of bit shift values. This parameter is available when **Bits to shift: Source** is Dialog.

| If the direction is... | Then... |
|------------------------|---|
| Left or Right | Use positive integers to specify bit shifts. |
| Bidirectional | Use positive integers for right shifts and negative integers for left shifts. |

Tunable: No**Programmatic Use****Block Parameter:** BitShiftNumber**Type:** character vector, string**Values:** scalar**Default:** '9'**Bits to shift: Direction — Direction in which to shift bits**

Left (default) | Right | Bidirectional

Specify the direction in which to shift bits: left, right, or bidirectional.

Tunable: No**Programmatic Use****Block Parameter:** BitShiftDirection**Type:** character vector, string

Values: 'Left' | 'Right' | 'Bidirectional'

Default: 'Bidirectional'

Binary points to shift: Number — Number of places to shift binary point

0 (default) | scalar

Specify an integer number of places to shift the binary point of the input signal. A positive value indicates a right shift, while a negative value indicates a left shift.

Tunable: No

Programmatic Use

Block Parameter: BinPtShiftNumber

Type: character vector, string

Values: 'Dialog' | 'Input port'

Default: 'Dialog'

Diagnostic for out of range shift value — Diagnostic action

None (default) | Warning | Error

Specify whether to produce a warning or error during simulation when the block contains an out-of-range shift value. Options include:

- None — Simulink takes no action.
- Warning — Simulink displays a warning and continues the simulation.
- Error — Simulink terminates the simulation and displays an error.

For more information, see “Simulation and Accelerator Mode Results for Out-of-Range Bit Shift Values” on page 1-1598.

Programmatic Use

Block Parameter: DiagnosticFor00RShift

Type: character vector, string

Values: 'None' | 'Warning' | 'Error'

Default: 'None'

Check for out-of-range 'Bits to shift' in generated code — Check for out-of-range bits to shift in generated code

off (default) | on

Select this check box to include conditional statements in the generated code that protect against out-of-range bit shift values. This check box is available when **Bits to shift: Source** is Input port.

For more information, see “Code Generation for Out-of-Range Bit Shift Values” on page 1-1599.

Programmatic Use

Block Parameter: Check00RBitShift

Type: character vector, string

Values: 'on' | 'off'

Default: 'off'

Block Characteristics

| | |
|-------------------|--|
| Data Types | double fixed point half integer single |
|-------------------|--|

| | |
|---------------------------------|-----|
| Direct Feedthrough | yes |
| Multidimensional Signals | no |
| Variable-Size Signals | no |
| Zero-Crossing Detection | no |

More About

Block Icon Variables

The Shift Arithmetic block icon shows the block behavior using these variables:

- Q — Stored integer value
- V — Real world value
- E — Exponent
- Qy — Stored integer value of output
- Qu — Stored integer value of input
- Vy — Value of output
- Vu — Value of input
- Ey — Exponent of output
- Eu — Exponent of input

Block Output for Right Bit Shifts

The following model compares the behavior of right bit shifts using the dialog box versus the block input port.

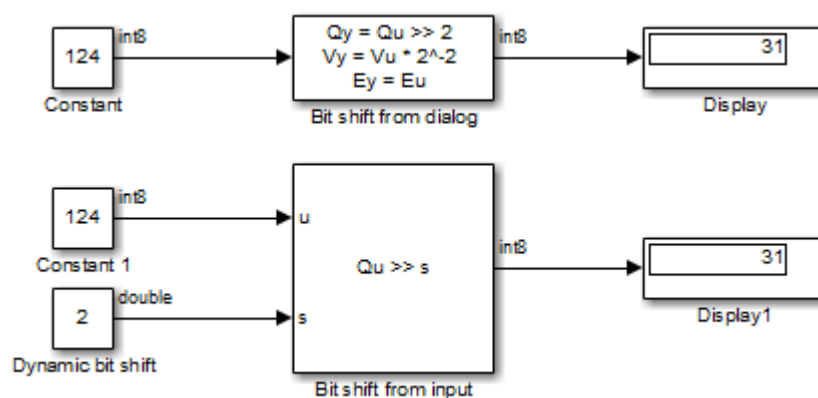

The key block parameter settings of the Constant blocks are:

| Block | Parameter | Setting |
|------------------------|------------------|---------|
| Constant and Constant1 | Constant value | 124 |
| | Output data type | int8 |

| Block | Parameter | Setting |
|-------------------|------------------|--|
| Dynamic bit shift | Constant value | 2 |
| | Output data type | Inherit: Inherit from 'Constant value' |

The key block parameter settings of the Shift Arithmetic blocks are:

| Block | Parameter | Setting |
|-----------------------|--------------------------|------------|
| Bit shift from dialog | Bits to shift: Source | Dialog |
| | Bits to shift: Direction | Right |
| | Bits to shift: Number | 2 |
| Bit shift from input | Bits to shift: Source | Input port |
| | Bits to shift: Direction | Right |

The top Shift Arithmetic block takes an input of 124, which corresponds to 01111100 in binary format. Shifting the number of bits two places to the right produces 00011111 in binary format. Therefore, the block outputs 31.

The bottom Shift Arithmetic block performs the same operation as the top block. However, the bottom block receives the bit shift value through an input port instead of the dialog box. By supplying this value as an input signal, you can change the number of bits to shift during simulation.

Block Output for Binary Point Shifts

The following model shows the effect of binary point shifts.

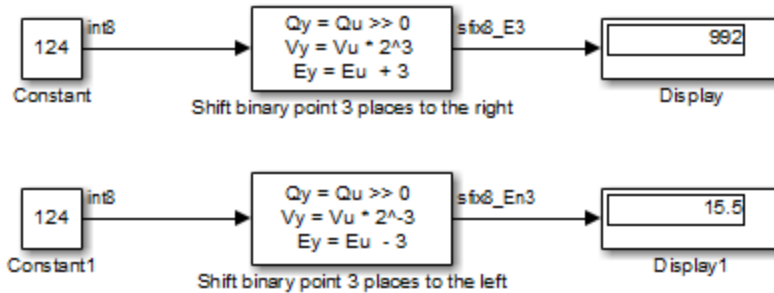

The key block parameter settings of the Constant blocks are:

| Block | Parameter | Setting |
|------------------------|------------------|---------|
| Constant and Constant1 | Constant value | 124 |
| | Output data type | int8 |

The key block parameter settings of the Shift Arithmetic blocks are:

| Block | Parameter | Setting |
|--|--------------------------|---------------|
| Shift binary point 3 places to the right | Bits to shift: Source | Dialog |
| | Bits to shift: Direction | Bidirectional |

| Block | Parameter | Setting |
|---|---------------------------------------|---------------|
| | Bits to shift: Number | 0 |
| | Binary points to shift: Number | 3 |
| Shift binary point 3 places to the left | Bits to shift: Source | Dialog |
| | Bits to shift: Direction | Bidirectional |
| | Bits to shift: Number | 0 |
| | Binary points to shift: Number | - 3 |

The top Shift Arithmetic block takes an input of 124, which corresponds to 01111100 in binary format. Shifting the binary point three places to the right produces 01111100000 in binary format. Therefore, the top block outputs 995.

The bottom Shift Arithmetic block also takes an input of 124. Shifting the binary point three places to the left produces 01111.100 in binary format. Therefore, the bottom block outputs 15.5.

Algorithms

Out-of-Range Bit Shift

Suppose that WL is the input word length. The shaded regions in the following diagram show out-of-range bit shift values for left and right shifts.

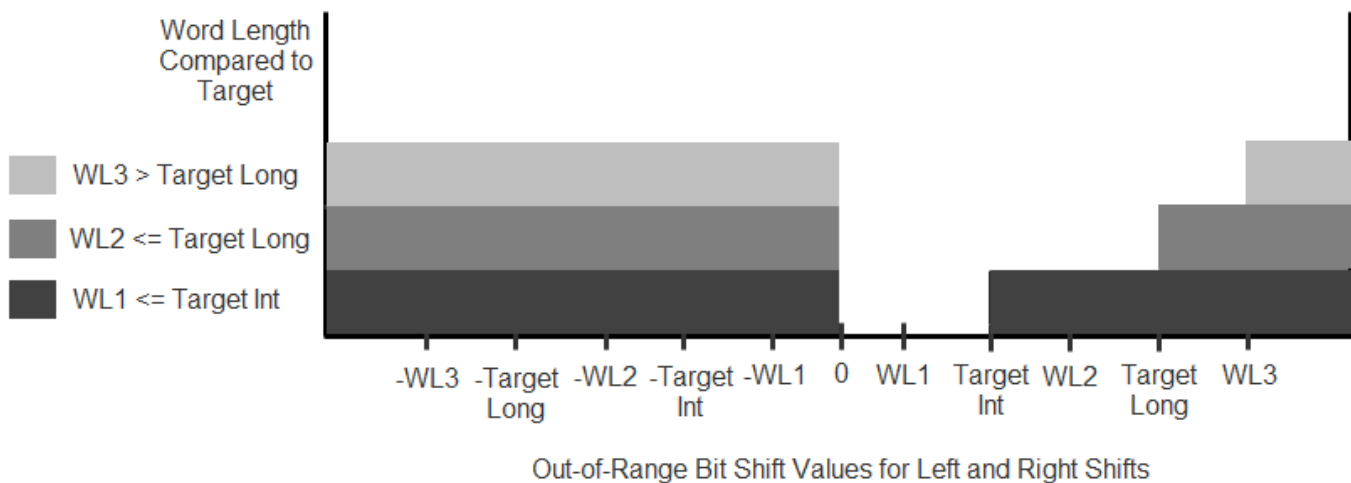

Similarly, the shaded regions in the following diagram show out-of-range bit shift values for bidirectional shifts.

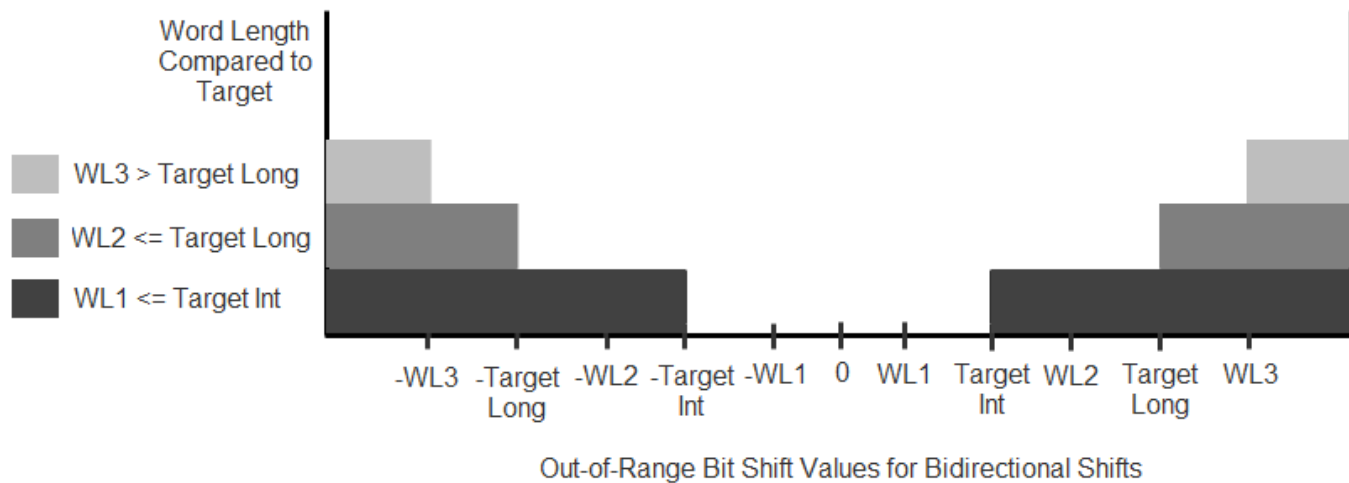

The diagnostic for out-of-range bit shifts responds as follows, depending on the mode of operation:

| Mode | Diagnostic for out-of-range shift value | | |
|------------------|---|---|--------------------------------------|
| | None | Warning | Error |
| Simulation modes | Do not report any warning or error. | Report a warning but continue simulation. | Report an error and stop simulation. |
| Code generation | Has no effect. | | |

Simulation and Accelerator Mode Results for Out-of-Range Bit Shift Values

Suppose that U is the input, WL is the input word length, and Y is the output. The output for an out-of-range bit shift value for left shifts is as follows:

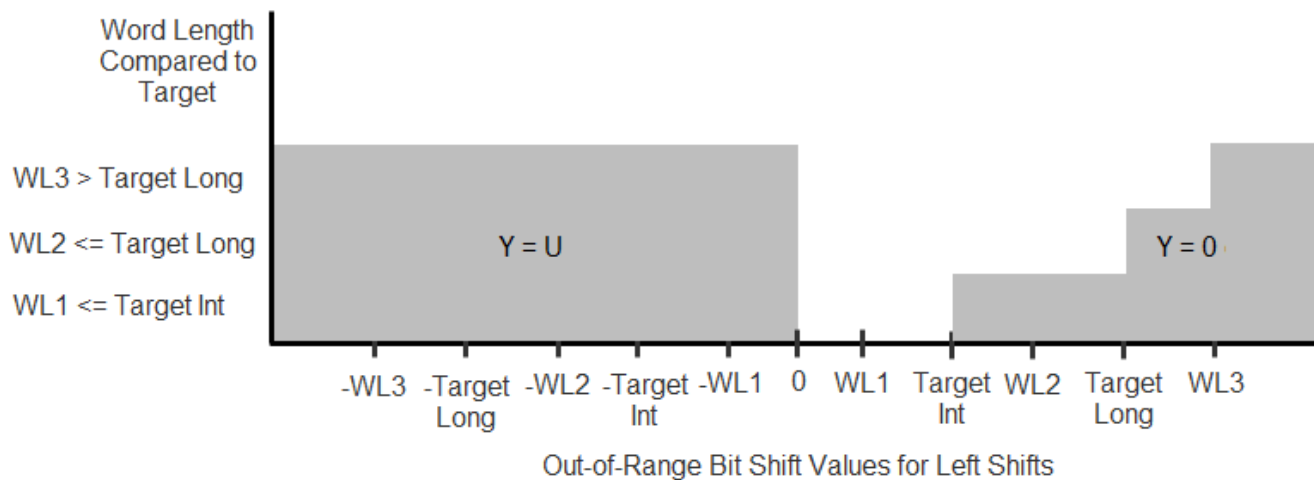

Similarly, the output for an out-of-range bit shift value for right shifts is as follows:

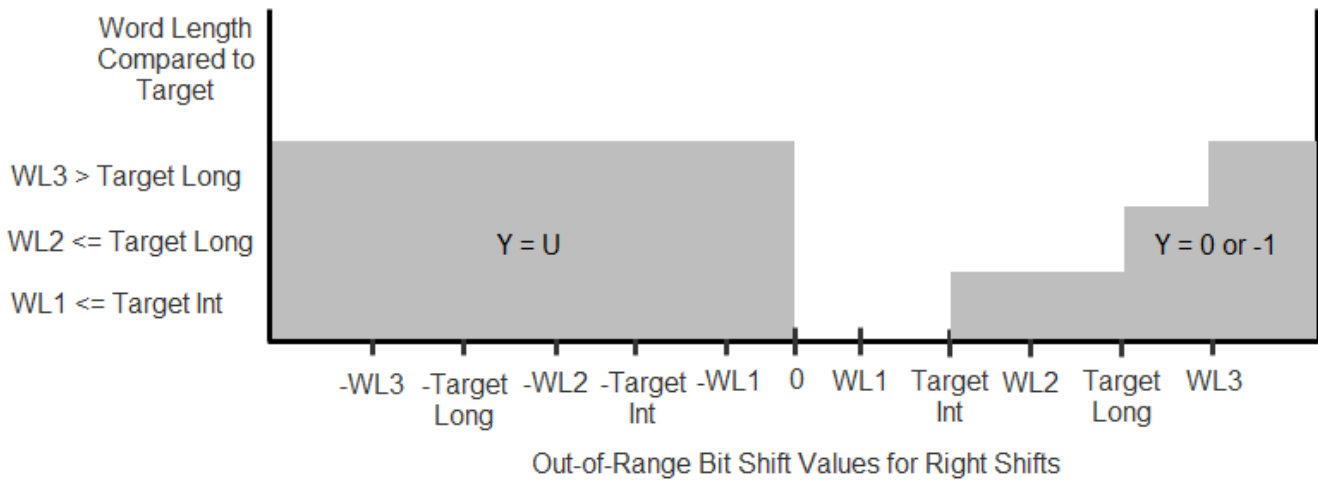

For bidirectional shifts, the output for an out-of-range bit shift value is as follows:

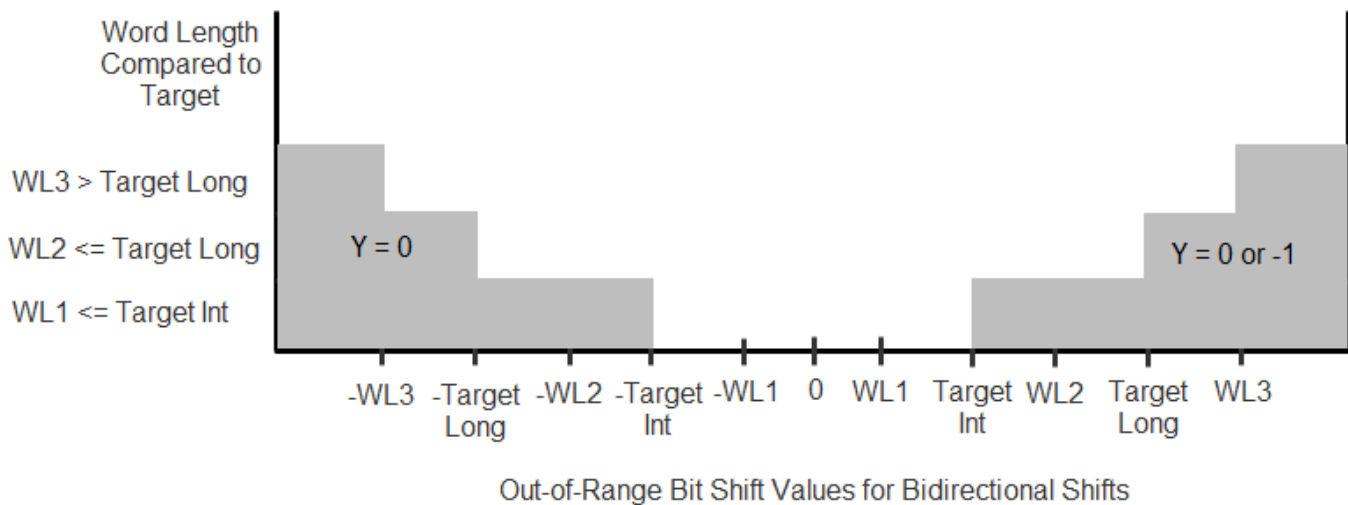

Code Generation for Out-of-Range Bit Shift Values

For generated code, the method for handling out-of-range bit shifts depends on the setting of **Check for out-of-range 'Bits to shift' in generated code**.

| Check Box Setting | Generated Code | Simulation Results Compared to Generated Code |
|-------------------|---|---|
| Selected | Includes conditional statements to protect against out-of-range bit shift values. | Simulation and Accelerator mode results match those of code generation. |

| Check Box Setting | Generated Code | Simulation Results Compared to Generated Code |
|-------------------|---|---|
| Cleared | Does not protect against out-of-range bit shift values. | <ul style="list-style-type: none"> For in-range values, simulation and Accelerator mode results match those of code generation. For out-of-range values, the code generation results are compiler specific. |

For right shifts on signed negative inputs, most C compilers use an arithmetic shift instead of a logical shift. Generated code for the Shift Arithmetic block depends on this compiler behavior.

Extended Capabilities

C/C++ Code Generation

Generate C and C++ code using Simulink® Coder™.

HDL Code Generation

Generate Verilog and VHDL code for FPGA and ASIC designs using HDL Coder™.

HDL Coder provides additional configuration options that affect HDL implementation and synthesized logic.

You can generate HDL code when **Bits to shift: Source** is **Dialog** or **Input port**.

HDL Architecture

The generated VHDL code uses the `shift_right` function and `sll` operator.

The generated Verilog code uses the `>>>` and `<<<` shift operators.

HDL Block Properties

| | |
|----------------------------------|--|
| ConstrainedOutputPipeline | Number of registers to place at the outputs by moving existing delays within your design. Distributed pipelining does not redistribute these registers. The default is 0. For more details, see “ConstrainedOutputPipeline” (HDL Coder). |
| InputPipeline | Number of input pipeline stages to insert in the generated code. Distributed pipelining and constrained output pipelining can move these registers. The default is 0. For more details, see “InputPipeline” (HDL Coder). |
| OutputPipeline | Number of output pipeline stages to insert in the generated code. Distributed pipelining and constrained output pipelining can move these registers. The default is 0. For more details, see “OutputPipeline” (HDL Coder). |

Complex Data Support

This block supports code generation for complex signals.

Restrictions

When **Bits to shift: Source** is **Input port**, binary point shifting is not supported.

PLC Code Generation

Generate Structured Text code using Simulink® PLC Coder™.

Fixed-Point Conversion

Design and simulate fixed-point systems using Fixed-Point Designer™.

See Also

[Bitwise Operator](#) | [Compare To Constant](#) | [Compare To Zero](#) | [Logical Operator](#) | [Relational Operator](#)

Introduced before R2006a

Sign

Indicate sign of input

Library: Simulink / Math Operations
HDL Coder / HDL Floating Point Operations
HDL Coder / Math Operations



Description

Block Behavior for Real Inputs

For real inputs, the Sign block outputs the sign of the input:

| Input | Output |
|-------------------|--------|
| Greater than zero | 1 |
| Equal to zero | 0 |
| Less than zero | -1 |

For vector and matrix inputs, the block outputs a vector or matrix where each element is the sign of the corresponding input element, as shown in this example:

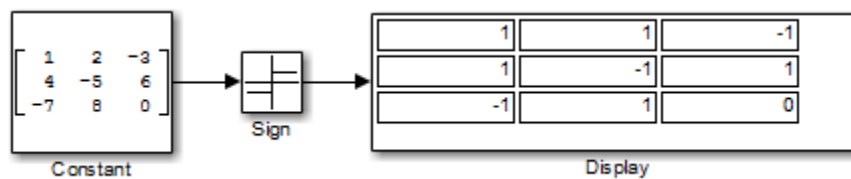

Block Behavior for Complex Inputs

When the input u is a complex scalar, the block output matches the MATLAB result for:

$$\text{sign}(u) = u ./ \text{abs}(u)$$

When an element of a vector or matrix input is complex, the block uses the same formula that applies to scalar input, as shown in this example:

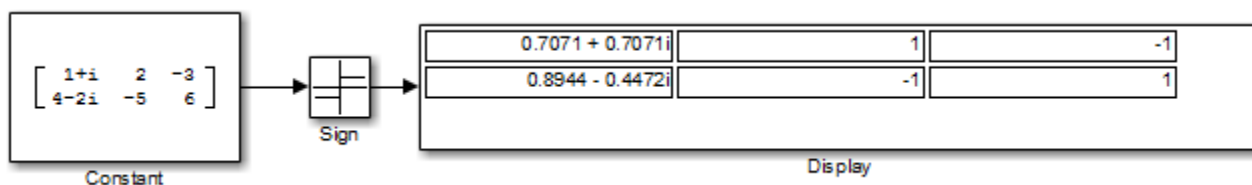

Ports

Input

Port_1 — Input signal

scalar | vector | matrix

Input signal whose sign will determine the output.

The block supports complex input signals only for floating-point data types, `double` and `single`.

Data Types: `single` | `double` | `int8` | `int16` | `int32` | `int64` | `uint8` | `uint16` | `uint32` | `uint64` | `Boolean` | `fixed point`

Output

Port_1 — Output signal

scalar | vector | matrix

Output signal that is the sign of the input signal.

Data Types: `single` | `double` | `int8` | `int16` | `int32` | `int64` | `uint8` | `uint16` | `uint32` | `uint64` | `Boolean` | `fixed point`

Parameters

Enable zero-crossing detection — Enable zero-crossing detection

on (default) | Boolean

Select to enable zero-crossing detection. For more information, see “Zero-Crossing Detection” in the Simulink documentation.

Programmatic Use

Block Parameter: ZeroCross

Type: character vector, string

Values: 'off' | 'on'

Default: 'on'

Sample time — Specify sample time as a value other than -1

-1 (default) | scalar | vector

Specify the sample time as a value other than -1. For more information, see “Specify Sample Time”.

Dependencies

This parameter is not visible unless it is explicitly set to a value other than -1. To learn more, see “Blocks for Which Sample Time Is Not Recommended”.

Programmatic Use

Block Parameter: SampleTime

Type: character vector

Values: scalar or vector

Default: '-1'

Block Characteristics

| | |
|---------------------------------|---|
| Data Types | Boolean double fixed point integer single |
| Direct Feedthrough | yes |
| Multidimensional Signals | no |
| Variable-Size Signals | no |
| Zero-Crossing Detection | yes |

Extended Capabilities

C/C++ Code Generation

Generate C and C++ code using Simulink® Coder™.

HDL Code Generation

Generate Verilog and VHDL code for FPGA and ASIC designs using HDL Coder™.

HDL Coder provides additional configuration options that affect HDL implementation and synthesized logic.

HDL Architecture

This block has a single, default HDL architecture.

HDL Block Properties

| | |
|----------------------------------|--|
| ConstrainedOutputPipeline | Number of registers to place at the outputs by moving existing delays within your design. Distributed pipelining does not redistribute these registers. The default is 0. For more details, see “ConstrainedOutputPipeline” (HDL Coder). |
| InputPipeline | Number of input pipeline stages to insert in the generated code. Distributed pipelining and constrained output pipelining can move these registers. The default is 0. For more details, see “InputPipeline” (HDL Coder). |
| OutputPipeline | Number of output pipeline stages to insert in the generated code. Distributed pipelining and constrained output pipelining can move these registers. The default is 0. For more details, see “OutputPipeline” (HDL Coder). |

Complex Data Support

This block supports code generation for complex signals.

PLC Code Generation

Generate Structured Text code using Simulink® PLC Coder™.

Fixed-Point Conversion

Design and simulate fixed-point systems using Fixed-Point Designer™.

See Also

Abs

Introduced before R2006a

Signal Builder

Create and generate interchangeable groups of signals whose waveforms are piecewise linear

Library: Simulink / Sources



Description

Note The Signal Builder block is not recommended. Use the Signal Editor block instead.

The Signal Builder block allows you to create interchangeable groups of piecewise linear signal sources and use them in a model. You can quickly switch the signal groups into and out of a model to facilitate testing. In the Signal Builder window, create signals and define the output waveforms. To open the window, double-click the block. See “Signal Groups”.

Note Use the `signalbuilder` function to create and access Signal Builder blocks programmatically.

Ports

Output

Signal 1 – First output signal

scalar | vector | matrix

First output signal from the signal group currently visible in the Signal Builder window.

Data Types: double | bus

Signal n – nth output signal

scalar | vector | matrix

nth output signal from the signal group currently visible in the Signal Builder window. n corresponds to the signal index.

Data Types: double | bus

Block Characteristics

| | |
|---------------------------------|--------|
| Data Types | double |
| Direct Feedthrough | no |
| Multidimensional Signals | no |

| | |
|--------------------------------|-----|
| Variable-Size Signals | no |
| Zero-Crossing Detection | yes |

Extended Capabilities

C/C++ Code Generation

Generate C and C++ code using Simulink® Coder™.

Not recommended for production code.

See Also

Signal Editor | Subsystem, Atomic Subsystem, Nonvirtual Subsystem, CodeReuse Subsystem | signalbuilder | signalBuilderToSignalEditor

Topics

“Signal Groups”

“Load Data with Interchangeable Scenarios”

“Signal Basics”

Introduced before R2006a

Signal Conversion

Convert signal to new type without altering signal values

Library: Simulink / Signal Attributes
HDL Coder / Signal Attributes



Description

The Signal Conversion block converts a signal from one type to another. To select the type of conversion to perform, use the **Output** parameter or one of these preconfigured Signal Conversion blocks:

- Signal Copy block
- To Virtual Bus block
- To Nonvirtual Bus block

Ports

Input

Port_1 — Input signal to convert

scalar | vector | matrix | N-D array

Input signal to convert, specified as a scalar, vector, matrix, or N-D array.

Data Types: single | double | half | int8 | int16 | int32 | int64 | uint8 | uint16 | uint32 | uint64 | string | Boolean | fixed point | enumerated | bus

Output

Port_1 — Converted signal

scalar | vector | matrix | N-D array

Output signal is the input signal converted to the specified type.

Data Types: single | double | half | int8 | int16 | int32 | int64 | uint8 | uint16 | uint32 | uint64 | Boolean | fixed point | enumerated | bus

Parameters

Output — Type of conversion

Signal copy (default) | Virtual bus | Nonvirtual bus

Specify the type of conversion to perform. The type of conversion that you use depends on your modeling goal.

| Modeling Goal | Output Option |
|--|----------------|
| Reduce generated code for a muxed signal. For an example involving Simulink Coder software, see “Generate Reentrant Code from Subsystems” (Simulink Coder). | Signal copy |
| Connect a block with a constant sample time to an output port of an enabled subsystem. | Signal copy |
| Save memory by converting a nonvirtual bus to a virtual bus. | Virtual bus |
| Pass a virtual bus to a modeling construct that requires a nonvirtual bus, such as a Model block. | Nonvirtual bus |

- The Signal copy option is the default. The type of conversion that the Signal Conversion block performs using the Signal copy option depends on the type of input signal.

| Type of Input Signal | Conversion That the Signal Copy Option Performs |
|-----------------------|--|
| Muxed (nonbus) signal | Converts the muxed signal, whose elements occupy discontinuous areas of memory, to a vector signal, whose elements occupy contiguous areas of memory. The conversion allocates a contiguous area of memory for the elements of the muxed signal and copies the values from the discontinuous areas (represented by the block input) to the contiguous areas (represented by the block output) at each time step. |
| Bus | Outputs a contiguous copy of the bus that is the input to the Signal Conversion block. |

For an array of buses input signal, use the Signal copy option.

- The Virtual bus option converts a nonvirtual bus to a virtual bus.
- The Nonvirtual bus option converts a virtual bus to a nonvirtual bus.

Programmatic Use

Block Parameter: ConversionOutput

Type: character vector

Values: 'Signal copy' | 'Virtual bus' | 'Nonvirtual bus'

Default: 'Signal copy'

Data type — Nonvirtual bus data type

Inherit: auto (default) | Bus: <object name> | <data type expression>

Specify the output data type of the nonvirtual bus that the Signal Conversion block produces.

This option is available only when you set the **Output** parameter to Nonvirtual bus.

The default option is Inherit: auto, which uses a rule that inherits a data type.

Specify a Simulink.Bus object in the **Data type** parameter for one or both of the following blocks:

- Signal Conversion block
- An upstream Bus Creator block

If you specify a bus object for the Signal Conversion block, but not for its upstream Bus Creator block, then use a bus object that matches the hierarchy of the bus that upstream Bus Creator block outputs.

If you specify a bus object for both the Signal Conversion block and its upstream Bus Creator block, use the same bus object for both blocks.

Click the **Show data type assistant** button  to display the **Data Type Assistant**, which helps you set the data type attributes. For more information, see “Specify Data Types Using Data Type Assistant”.

Dependencies

To enable this parameter, set **Output** to Nonvirtual bus.

Programmatic Use

Block Parameter: OutDataTypeStr

Type: character vector

Values: 'Inherit: auto' | 'Bus: <object name>' | '<data type expression>'

Default: 'Inherit: auto'

Exclude this block from 'Block reduction' optimization — Exclude from block reduction optimization

off (default) | on

This option is available only when you set the **Output** parameter to Signal copy. If the elements of the input signal occupy contiguous areas of memory, then as an optimization, Simulink software eliminates the block from the compiled model. If you select the **Exclude this block from 'Block reduction' optimization** check box, the optimization occurs the next time you compile the model. For more information, see “Block reduction”.

Programmatic Use

Block Parameter: OverrideOpt

Type: character vector

Values: 'off' | 'on'

Default: 'off'

Block Characteristics

| | |
|---------------------------------|--|
| Data Types | Boolean double enumerated fixed point half integer single string |
| Direct Feedthrough | yes |
| Multidimensional Signals | yes |
| Variable-Size Signals | yes |
| Zero-Crossing Detection | no |

Extended Capabilities

C/C++ Code Generation

Generate C and C++ code using Simulink® Coder™.

HDL Code Generation

Generate Verilog and VHDL code for FPGA and ASIC designs using HDL Coder™.

HDL Coder provides additional configuration options that affect HDL implementation and synthesized logic.

HDL Architecture

This block has a pass-through implementation.

HDL Block Properties

| | |
|----------------------------------|--|
| ConstrainedOutputPipeline | Number of registers to place at the outputs by moving existing delays within your design. Distributed pipelining does not redistribute these registers. The default is 0. For more details, see “ConstrainedOutputPipeline” (HDL Coder). |
| InputPipeline | Number of input pipeline stages to insert in the generated code. Distributed pipelining and constrained output pipelining can move these registers. The default is 0. For more details, see “InputPipeline” (HDL Coder). |
| OutputPipeline | Number of output pipeline stages to insert in the generated code. Distributed pipelining and constrained output pipelining can move these registers. The default is 0. For more details, see “OutputPipeline” (HDL Coder). |

Complex Data Support

This block supports code generation for complex signals.

PLC Code Generation

Generate Structured Text code using Simulink® PLC Coder™.

Fixed-Point Conversion

Design and simulate fixed-point systems using Fixed-Point Designer™.

See Also

Data Type Conversion | Bus Creator

Topics

“Virtual Bus”

Introduced before R2006a

Signal Editor

Display, create, edit, and switch interchangeable scenarios

Library: Simulink / Sources

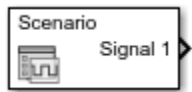

Description

The Signal Editor block displays, creates, and edits interchangeable scenarios. You can also use the block to switch scenarios in and out of models.

The Signal Editor block supports MAT-files that contain one or more scalar `Simulink.SimulationData.Dataset` objects.

You can port Signal Builder block configurations to the Signal Editor block using the `signalBuilderToSignalEditor` function. For more information, see “Replace Signal Builder Block with Signal Editor Block”.

To programmatically get the total number of scenarios and signals in the Signal Editor block, use the `get_param` `NumberOfScenarios` and `NumberOfSignals` properties. These properties contain the values as character vectors. To convert these values to doubles, use the `str2double` function.

To programmatically enable the Signal Editor block to label output signal lines, set the `set_param` `PreserveSignalName` to 'on' (default). For example:

```
set_param(gcf, 'PreserveSignalName', 'on')
```

Limitations

The Signal Editor block does not support:

- Function-calls
- Ground signals

The Signal Editor block supports dynamic strings. It does not support strings with maximum length. In addition, strings in the Signal Editor block cannot output:

- Non-scalar MATLAB strings.
- String data that contains missing values.
- String data that contains non-ASCII characters.

Ports

Output Arguments

Signal1 — Signals in scenario

multidimensional

One or more signals, which can be:

- A MATLAB `timeseries` object
- A structure of MATLAB `timeseries` objects
- A two-dimensional matrix

The port label depends on the associated variable in the data set MAT-file.

Data Types: `single` | `double` | `half` | `int8` | `int16` | `int32` | `int64` | `uint8` | `uint16` | `uint32` | `uint64` | `string` | `Boolean` | `fixed point` | `enumerated` | `bus`

Parameters

File name — Data set file

`untitled.mat` (default) | character vector

Data set file, specified as character vector, containing one or more scalar `Simulink.SimulationData.Dataset` objects. Do not use a file name from one locale in a different locale. When using the block on multiple platforms, consider specifying just the MAT-file name and having the MAT-file be on the MATLAB path.

Dependencies

- If `untitled.mat` does not exist in the current folder, these parameters are disabled:
 - **Active scenario**
 - **Signals**
 - **Output a bus signal**
 - **Unit**
 - **Sample time**
 - **Interpolate data**
 - **Enable zero-crossing detection**
 - **Form output after final data value by**
- To create a MAT-file, click . This button starts the Signal Editor user interface, which lets you create and edit scenario MAT-files.

Programmatic Use

Block Parameter: `Filename`

Type: character vector

Values: character vector

Default: `'untitled.mat'`

Active scenario — Active scenario

`Scenario` (default) | character vector

Active scenario, specified as a character vector. The specified MAT-file must exist.

Dependencies

- To enable this parameter, ensure that the specified MAT-file exists.
- With fast restart enabled, you can:

- Change the active scenario
- Change the active signal
- Start the Signal Editor user interface and edit data

While you can change the active signal, you cannot edit the signal properties in the block.

Programmatic Use**Block Parameter:** ActiveScenario**Type:** character vector | numeric**Values:** character vector | index value**Default:** 'Scenario'**To create and edit scenarios, launch Signal Editor user interface – Start Signal Editor**

button click

To start Signal Editor user interface, click .

Active signal – Signal to configure

Signal 1 (default) | character vector

Signal to configure, specified as a signal name. This signal is considered the active signal. The MAT-file must exist before you can configure signals.

To enable this parameter, ensure that the specified MAT-file exists.

Tip Do not use the `set_param` function to set the active signal property Name-Value argument ('ActiveSignal') in combination with another Name-Value pair argument for the Signal Editor block.

Programmatic Use**Block Parameter:** ActiveSignal**Type:** character vector | numeric**Values:** character vector | index vector**Default:** 'Signal 1'**Output a bus signal – Configure signal as bus**

off (default) | on

Configure signal as a bus:



On

Configure signal as a bus.



Off

Do not configure signal as a bus.

The specified MAT-file must exist.

Tip Select this check box only if the active signal is a MATLAB structure whose fields are the same as an existing bus object, or create a new matching bus object. If you select this check box for an active signal that is not a MATLAB structure, simulation returns an error.

Dependencies

- Selecting **Output a bus signal** check box enables the **Select bus object** parameter.
- To enable this parameter, ensure that the specified MAT-file exists.

Programmatic Use

Block Parameter: IsBus

Type: character vector

Values: 'off' | 'on'

Default: 'off'

Select bus object — Bus object

Bus: BusObject (default) | bus object name

Select or enter the bus object name. To edit the bus object or create a bus object using the Data Type Assistant, click >>. The active signal must be a MATLAB structure whose fields are the same as this bus object. The specified MAT-file must exist.

Dependencies

To enable this parameter, ensure that the specified MAT-file exists.

Programmatic Use

Block Parameter: OutputBusObjectStr

Type: character vector

Values: bus object name

Default: 'Bus: BusObject'

Mode — Bus object mode

Bus Object (default) | bus object data type

Select the bus object name. If you do not have a bus object, create one by clicking **Edit**, which starts the Bus Editor. For more information, see “Create and Specify Simulink.Bus Objects”.

Unit — Physical unit

inherit (default) | supported physical unit

Physical unit of the signal, specified as an allowed unit. To specify a unit, begin typing in the text box. As you type, the parameter displays potential matching units. For more information, see “Unit Specification in Simulink Models”. For a list of supported units, see Allowed Unit Systems.

To constrain the unit system, click the link to the right of the parameter:

- If a Unit System Configuration block exists in the component, its dialog box opens. Use that dialog box to specify allowed and disallowed unit systems for the component.
- If a Unit System Configuration block does not exist in the component, the model Configuration Parameters dialog box displays. Use that dialog box to specify allowed and disallowed unit systems for the model.

The specified MAT-file must exist.

Dependencies

To enable this parameter, ensure that the specified MAT-file exists.

Programmatic Use

Block Parameter: Unit

Type: character vector

Values: 'inherit' | supported physical unit

Default: 'inherit'

Sample time — Time interval between samples

0 (default) | -1 | sample time in seconds

Time interval between samples, specified in seconds. The specified MAT-file must exist.

Dependencies

To enable this parameter, ensure that the specified MAT-file exists.

Programmatic Use

Block Parameter: SampleTime

Type: character vector

Values: -1 | sample time in seconds

Default: '0'

Interpolate data — Linearly interpolate data

off (default) | on

Linearly interpolate data at time hits for which no corresponding workspace data exist. The specified MAT-file must exist.

The Signal Editor block linearly interpolates:

On

Linearly interpolate at time hits for which no corresponding workspace data exist, select this option.

Off

The current output equals the output at the most recent time for which data exists.

The Signal Editor block interpolates by using the two corresponding workspace samples:

- For `double` data, linearly interpolates the value by using the two corresponding samples
- For `Boolean` data, uses `false` for the first half of the time between two time values and `true` for the second half
- For a built-in data type other than `double` or `Boolean`:
 - Upcasts the data to `double`
 - Performs linear interpolation (as described for `double` data)
 - Downcasts the interpolated value to the original data type

You cannot use linear interpolation with enumerated (`enum`) data.

The block uses the value of the last known data point as the value of time hits that occur after the last known data point.

To determine the block output after the last time hit for which data is available, combine the settings of these parameters:

- **Interpolate data**
- **Form output after final data value by**

For details, see the **Form output after final data value by** parameter.

Dependencies

To enable this parameter, ensure that the specified MAT-file exists.

Programmatic Use

Block Parameter: Interpolate

Type: character vector

Values: 'off' | 'on'

Default: 'off'

Enable zero-crossing detection — Detect zero-crossings

off (default) | on

If you select the **Enable zero-crossing detection** parameter, then when the input array contains multiple entries for the same time hit, Simulink detects a zero crossing. For example, suppose that the input array has this data:

```
time:    0 1 2 2 3
signal:  2 3 4 5 6
```

At time 2, there is a zero crossing from input signal discontinuity. For more information, see “Zero-Crossing Detection”.

For bus signals, Simulink detects zero crossings across all leaf bus elements.

The specified MAT-file must exist.

Dependencies

To enable this parameter, ensure that the specified MAT-file exists.

Programmatic Use

Block Parameter: ZeroCross

Type: character vector

Values: 'off' | 'on'

Default: 'off'

Form output after final data value by — Block output after the last time hit for which data is available

Setting to zero (default) | Extrapolation | Holding final value

To determine the block output after the last time hit for which workspace data is available, combine the settings of these parameters:

- **Interpolate data**

- **Form output after final data value by**

This table lists the block output, based on the values of the two options.

| Setting for Form Output After Final Data Value By | Setting for Interpolate Data | Block Output After Final Data |
|---|------------------------------|------------------------------------|
| Extrapolation | On | Extrapolated from final data value |
| | Off | Error |
| Setting to zero | On | Zero |
| | Off | Zero |
| Holding final value | On | Final value from workspace |
| | Off | Final value from workspace |

For example, the block uses the last two known data points to extrapolate data points that occur after the last known point if you:

- Select **Interpolate data**.
- Set **Form output after final data value by** to Extrapolation.

The specified MAT-file must exist.

Dependencies

To enable this parameter, ensure that the specified MAT-file exists.

Programmatic Use

Block Parameter: OutputAfterFinalValue

Type: character vector

Values: 'Setting to zero' | 'Extrapolation' | 'Holding final value'

Default: 'Setting to zero'

Block Characteristics

| | |
|---------------------------------|--|
| Data Types | Boolean bus double enumerated fixed point half integer single string |
| Direct Feedthrough | no |
| Multidimensional Signals | yes |
| Variable-Size Signals | no |
| Zero-Crossing Detection | yes |

Extended Capabilities

C/C++ Code Generation

Generate C and C++ code using Simulink® Coder™.

Not recommended for production code.

Fixed-Point Conversion

Design and simulate fixed-point systems using Fixed-Point Designer™.

See Also

Signal Builder | `signalEditor` | `signalBuilderToSignalEditor` | `str2double`

Topics

“Create and Specify Simulink.Bus Objects”

“Load Data with Interchangeable Scenarios”

“Create and Edit Signal Data”

Introduced in R2017b

Signal Generator

Generate various waveforms

Library: Simulink / Sources



Description

Supported Operations

The Signal Generator block can produce one of four different waveforms:

- sine
- square
- sawtooth
- random

You can express signal parameters in hertz or radians per second. Using default parameter values, you get one of the following waveforms:

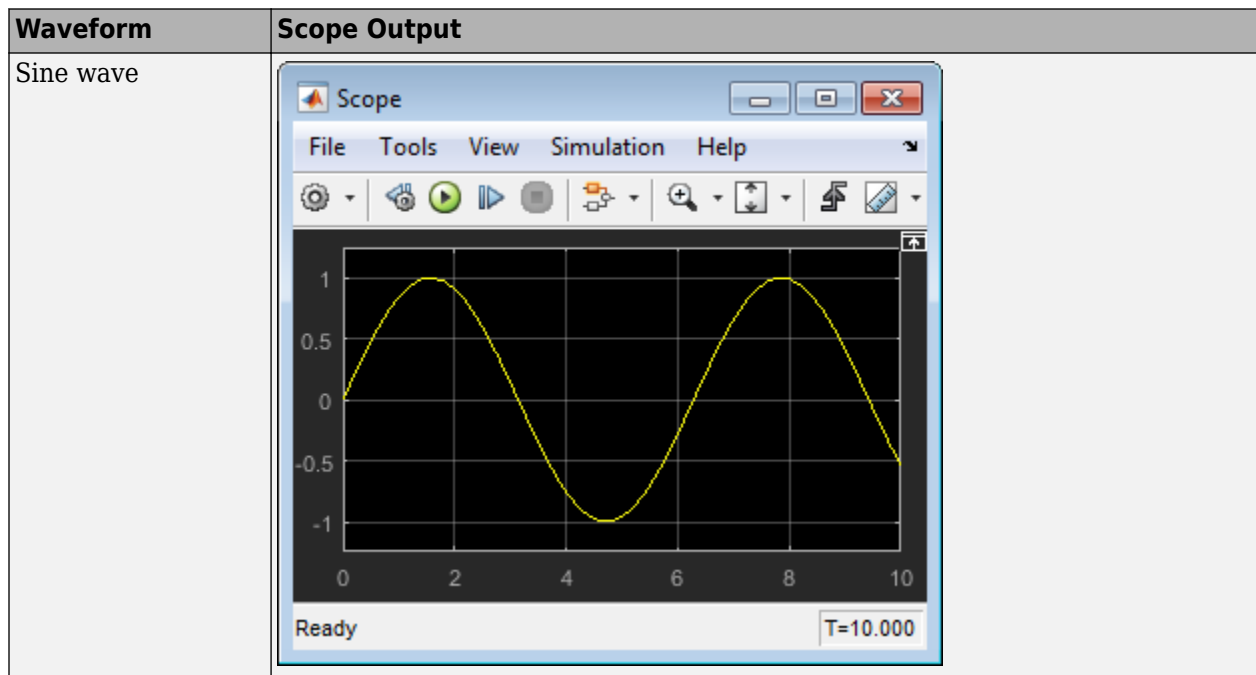

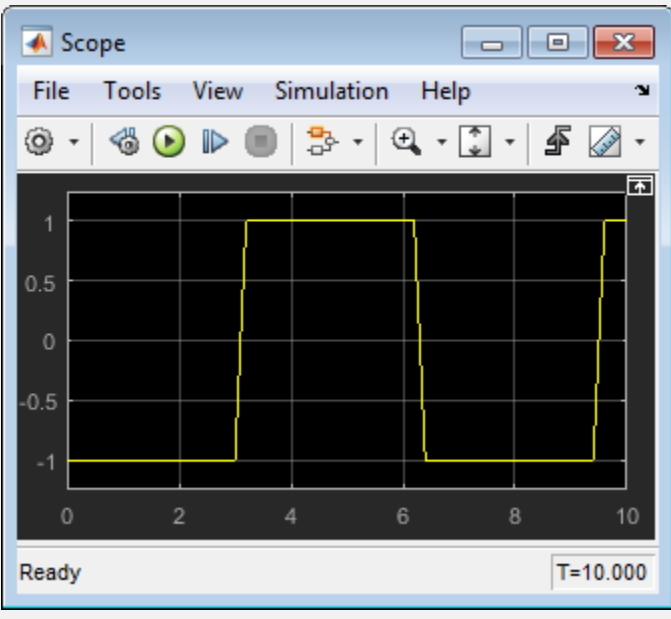
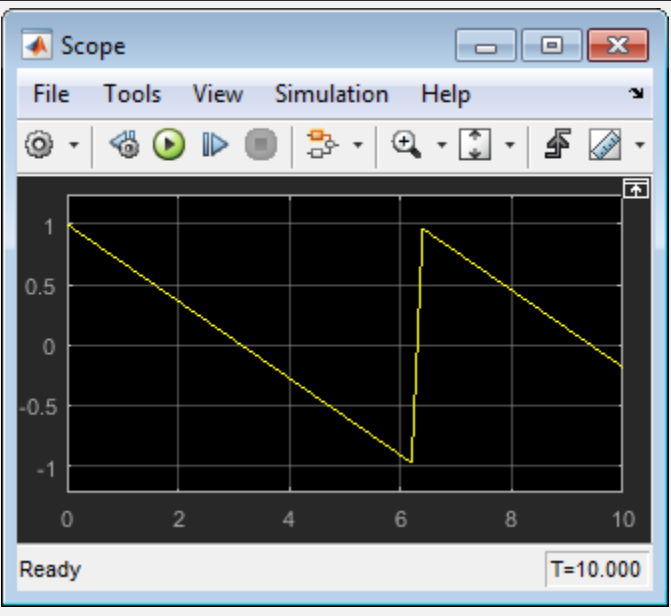
| Waveform | Scope Output |
|---------------|---|
| Square wave |  <p>The image shows a Scope window with a menu bar (File, Tools, View, Simulation, Help) and a toolbar. The plot area displays a square wave signal on a grid. The vertical axis (y-axis) ranges from -1 to 1 with major ticks at -1, -0.5, 0, 0.5, and 1. The horizontal axis (x-axis) ranges from 0 to 10 with major ticks at 0, 2, 4, 6, 8, and 10. The signal is a square wave with a period of 4 units, alternating between -1 and 1. The status bar at the bottom indicates 'Ready' and 'T=10.000'.</p> |
| Sawtooth wave |  <p>The image shows a Scope window with a menu bar (File, Tools, View, Simulation, Help) and a toolbar. The plot area displays a sawtooth wave signal on a grid. The vertical axis (y-axis) ranges from -1 to 1 with major ticks at -1, -0.5, 0, 0.5, and 1. The horizontal axis (x-axis) ranges from 0 to 10 with major ticks at 0, 2, 4, 6, 8, and 10. The signal is a sawtooth wave with a period of 6 units, starting at 1 and decreasing linearly to -1, then jumping back to 1. The status bar at the bottom indicates 'Ready' and 'T=10.000'.</p> |

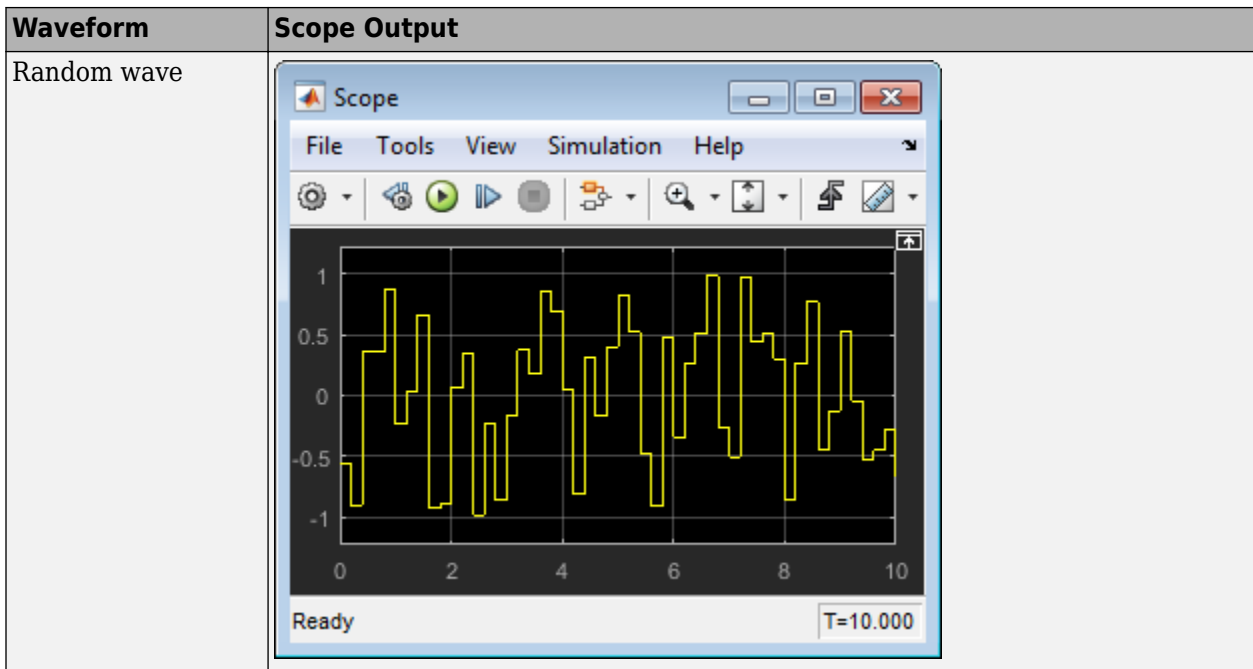

A negative **Amplitude** parameter value causes a 180-degree phase shift. You can generate a phase-shifted wave at other than 180 degrees in many ways. For example, you can connect a Clock block signal to a MATLAB Function block and write the equation for the specific wave.

You can vary the output settings of the Signal Generator block while a simulation is in progress to determine quickly the response of a system to different types of inputs.

The **Amplitude** and **Frequency** parameters determine the amplitude and frequency of the output signal. The parameters must be of the same dimensions after scalar expansion. If you clear the **Interpret vector parameters as 1-D** check box, the block outputs a signal of the same dimensions as the **Amplitude** and **Frequency** parameters (after scalar expansion). If you select the **Interpret vector parameters as 1-D** check box, the block outputs a vector (1-D) signal if the **Amplitude** and **Frequency** parameters are row or column vectors, that is, single-row or column 2-D arrays. Otherwise, the block outputs a signal of the same dimensions as the parameters.

Solver Considerations

If your model uses a fixed-step solver, Simulink uses the same step size for the entire simulation. In this case, the Signal Generator block output provides a uniformly sampled representation of the ideal waveform.

If your model uses a variable-step solver, Simulink might use different step sizes during the simulation. In this case, the Signal Generator block output does not always provide a uniformly sampled representation of the ideal waveform. To ensure that the block output is a uniformly sampled representation, add a Hit Crossing block directly downstream of the Signal Generator block. These models show the difference in Signal Generator block output with and without the Hit Crossing block.

Model That Uses a Variable-Step Solver

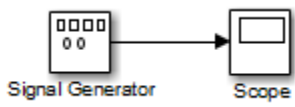

Signal Generator Block Output

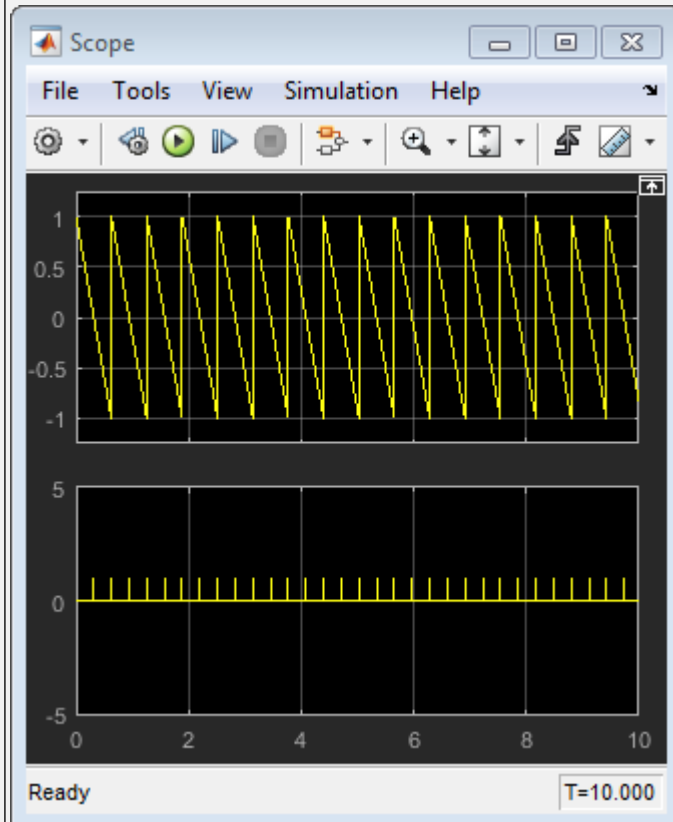
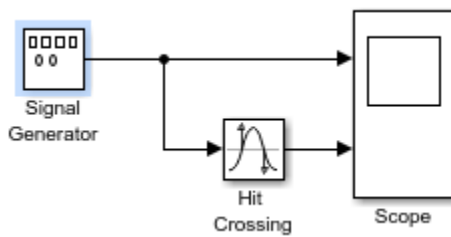
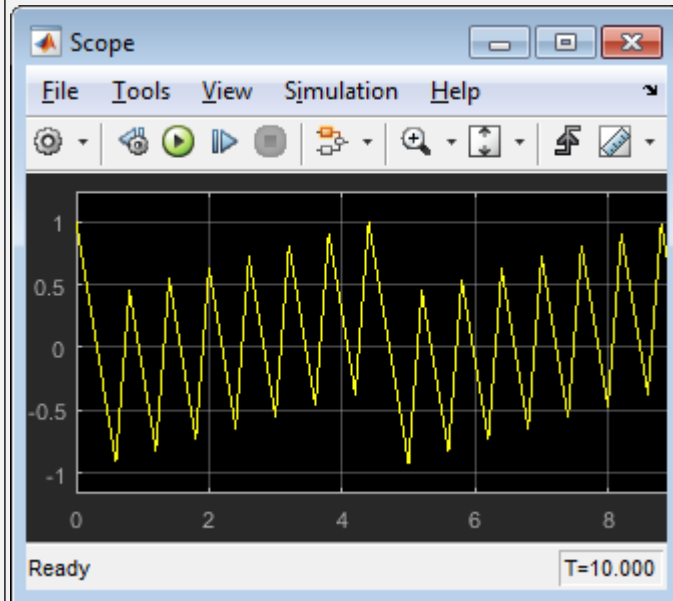

Ports

Output

Port_1 — Generated output signal

scalar | vector | matrix

Output signal specified as one of these waveforms.

- sine
- square
- sawtooth
- random

Data Types: double

Parameters

Wave form — Wave form to generate

sine (default) | square | sawtooth | random

Specify the wave form.

Programmatic Use

Block Parameter: WaveForm

Type: character vector

Values: 'sine' | 'square' | 'sawtooth' | 'random'

Default: 'sine'

Time (t) — Source of time variable

Use simulation time (default) | Use external signal

Specify whether to use simulation time or an external signal as the source of values for the waveform time variable. If you specify an external source, the block displays an input port for connecting the source.

Programmatic Use

Block Parameter: TimeSource

Type: character vector

Values: 'Use simulation time' | 'Use external signal'

Default: 'Use simulation time'

Amplitude — Signal amplitude

1 (default) | scalar | vector | matrix

Specify the amplitude of the generated waveform.

Programmatic Use

Block Parameter: Amplitude

Type: character vector

Values: real scalar

Default: '1'

Frequency — Signal frequency

1 (default) | scalar | vector | matrix

Specify the frequency of the generated waveform.

Programmatic Use**Block Parameter:** Frequency**Type:** character vector**Values:** real scalar**Default:** '1'**Units — Signal units**

rad/sec (default) | Hertz

Specify the signal units as Hertz or rad/sec.

Programmatic Use**Block Parameter:** Units**Type:** character vector**Values:** 'rad/sec' | 'Hertz'**Default:** 'rad/sec'**Interpret vector parameters as 1-D — Treat vectors as 1-D**

on (default) | off

Select this check box to output a vector of length N if the **Constant value** parameter evaluates to an N-element row or column vector.

- When you select this check box, the block outputs a vector of length N if the **Constant value** parameter evaluates to an N-element row or column vector. For example, the block outputs a matrix of dimension 1-by-N or N-by-1.
- When you clear this check box, the block does not output a vector of length N if the **Constant value** parameter evaluates to an N-element row or column vector.

Programmatic Use**Block Parameter:** VectorParams1D**Type:** character vector**Values:** 'on' | 'off'**Default:** 'on'**Block Characteristics**

| | |
|---------------------------------|--------|
| Data Types | double |
| Direct Feedthrough | yes |
| Multidimensional Signals | yes |
| Variable-Size Signals | no |
| Zero-Crossing Detection | no |

Extended Capabilities

C/C++ Code Generation

Generate C and C++ code using Simulink® Coder™.

Cannot be used inside a triggered subsystem hierarchy.

These blocks do not reference absolute time when configured for sample-based operation. In time-based operation, they depend on absolute time.

See Also

Pulse Generator | Waveform Generator | Signal Editor

Introduced before R2006a

Signal Specification

Specify desired dimensions, sample time, data type, numeric type, and other attributes of signal

Library: Simulink / Signal Attributes
HDL Coder / Signal Attributes

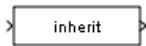

Description

The Signal Specification block allows you to specify the attributes of the signal connected to its input and output ports. If the specified attributes conflict with the attributes specified by the blocks connected to its ports, Simulink software displays an error when it compiles the model. For example, at the beginning of a simulation, if no conflict exists, Simulink eliminates the Signal Specification block from the compiled model. In other words, the Signal Specification block is a virtual block. It exists only to specify the attributes of a signal and plays no role in the simulation of the model.

You can use the Signal Specification block to ensure that the actual attributes of a signal meet desired attributes. For example, suppose that you and a colleague are working on different parts of the same model. You use Signal Specification blocks to connect your part of the model with your colleague's. If your colleague changes the attributes of a signal without informing you, the attributes entering the corresponding Signal Specification block do not match. When you try to simulate the model, you get an error.

You can also use the Signal Specification block to ensure correct propagation of signal attributes throughout a model. However, if some blocks have unspecified attributes for the signals they accept or output, the model does not have enough information to propagate attributes correctly. In these cases, the Signal Specification block can provide the information Simulink needs. Using the Signal Specification block also helps speed up model compilation when blocks are missing signal attributes.

The Signal Specification block supports signal label propagation.

Ports

Input

Port_1 – Input signal

scalar | vector | matrix | N-D array

Input signal whose attributes to check, specified as a scalar, vector, matrix, or N-D array. The block checks the attributes of the input signal against the desired attributes you specify in the block dialog box. If the attributes do not match, the block generates an error.

Data Types: single | double | half | int8 | int16 | int32 | int64 | uint8 | uint16 | uint32 | uint64 | Boolean | fixed point | enumerated | bus

Output

Port_1 – Output signal

scalar | vector | matrix | N-D array

Output signal is the input signal when all attributes of the signal match those specified in the dialog box. If the attributes do not match, the block generates an error.

Data Types: `single` | `double` | `half` | `int8` | `int16` | `int32` | `int64` | `uint8` | `uint16` | `uint32` | `uint64` | `Boolean` | `fixed point` | `enumerated` | `bus`

Parameters

Minimum — Minimum value for range checking

[] (default) | scalar

Specify the minimum value for the block output as a finite real double scalar value.

Note If you specify a bus object as the data type for this block, do not set the minimum value for bus data on the block. Simulink ignores this setting. Instead, set the minimum values for bus elements of the bus object specified as the data type. For information on the Minimum property of a bus element, see `Simulink.BusElement`.

Simulink uses this value to perform:

- Simulation range checking (see “Specify Signal Ranges”)
- Automatic scaling of fixed-point data types

Programmatic Use

Block Parameter: `OutMin`

Type: character vector

Values: scalar

Default: ' [] '

Maximum — Maximum value for range checking

[] (default) | scalar

Specify the maximum value for the block output as a finite real double scalar value.

Note If you specify a bus object as the data type for this block, do not set the maximum value for bus data on the block. Simulink ignores this setting. Instead, set the maximum values for bus elements of the bus object specified as the data type. For information on the Maximum property of a bus element, see `Simulink.BusElement`.

Simulink uses this value to perform:

- Simulation range checking (see “Specify Signal Ranges”)
- Automatic scaling of fixed-point data types

Programmatic Use

Block Parameter: `OutMax`

Type: character vector

Values: scalar

Default: ' [] '

Data type — Output data type

Inherit: auto (default) | double | single | half | int8 | uint8 | int16 | uint16 | ...

Specify the desired output data type. If the data type of the input signal does not match the value you specify, the block generates an error or warning.

Click the **Show data type assistant** button  to display the **Data Type Assistant**, which helps you set the data type attributes. For more information, see “Specify Data Types Using Data Type Assistant”.

You can specify any of these options:

- Inherited data type
- Built-in Simulink data type — For example, specify `single` or `uint8`. See “Data Types Supported by Simulink”.
- Fixed-point data type — Use the `fixdt` function. For example, specify `fixdt(1,16,0)`.
- Enumerated data type — Use the name of the type preceded by `Enum:`. For example, specify `Enum: myEnumType`.
- Bus data type — Use the name of the `Simulink.Bus` object preceded by `Bus:`. For example, specify `Bus: myBusObject`.
- Value type — Use the name of the `Simulink.ValueType` object preceded by `ValueType:`. For example, specify `ValueType: windVelocity`.
- Custom data type — Use a MATLAB expression that specifies the type. For example, you can specify a `Simulink.NumericType` object whose `DataTypeMode` property is set to a value other than `'Fixed-point: unspecified scaling'`.

When you specify a `Simulink.ValueType` or `Simulink.Bus` object, the object defines more than the data type. The object also defines properties such as **Min**, **Max**, and **Unit**. The property values specified by the `ValueType` object override the corresponding property values specified by a block. For example, suppose a block sets **Unit** to ft/s. When the **Data type** of the block specifies a `ValueType` object that has m/s as its unit, the block uses m/s instead of ft/s.

Programmatic Use

Block Parameter: `OutDataTypeStr`

Type: character vector

Value: `'Inherit: auto' | 'double' | 'single' | 'half' | 'int8' | 'uint8' | 'int16' | 'uint16' | 'int32' | 'uint32' | 'int64' | 'uint64' | 'boolean' | 'fixdt(1,16,0)' | 'fixdt(1,16,2^0,0)' | 'string' | 'Enum: <class name>' | 'Bus: <object name>' | 'ValueType: <object name>' | <data type expression>`

Default: `'Inherit: auto'`

Lock output data type setting against changes by the fixed-point tools — Prevent fixed-point tools from overriding Output data type

off (default) | on

Select this parameter to prevent the fixed-point tools from overriding the **Output** data type you specify on the block. For more information, see “Use Lock Output Data Type Setting” (Fixed-Point Designer).

Programmatic Use

Block Parameter: `LockScale`

Type: character vector
Values: 'off' | 'on'
Default: 'off'

Require nonvirtual bus — Accept only nonvirtual bus signals

off (default) | on

If you specify a bus object as the data type, use this parameter to specify whether to accept only nonvirtual bus signals.

- off — Specifies that a signal must come from a *virtual* bus.
- on — Specifies that a signal must come from a *nonvirtual* bus.

Dependencies

To enable this parameter, set **Data type** to one of these values:

- Bus: <object name>
- <data type expression> that specifies a bus object

Programmatic Use

Block Parameter: BusOutputAsStruct

Type: character vector

Value: 'off' | 'on'

Default: 'off'

Unit (e.g., m, m/s², N*m) — Physical unit of the input signal to the block

inherit (default) | <Enter unit>

Specify the physical unit of the input signal to the block. To specify a unit, begin typing in the text box. As you type, the parameter displays potential matching units. For a list of supported units, see Allowed Unit Systems.

To constrain the unit system, click the link to the right of the parameter:

- If a Unit System Configuration block exists in the component, its dialog box opens. Use that dialog box to specify allowed and disallowed unit systems for the component.
- If a Unit System Configuration block does not exist in the component, the model Configuration Parameters dialog box displays. Use that dialog box to specify allowed and disallowed unit systems for the model.

Programmatic Use

Block Parameter: Unit

Type: character vector

Values: 'inherit' | '<Enter unit>'

Default: 'inherit'

Dimensions (-1 for inherited) — Dimensions of input and output signals

-1 (default) | n | [m n]

Specify the dimensions of the input and output signals.

- -1 — Specifies that signals inherit dimensions.
- n — Specifies a vector of width n.

- `[m n]` — Specifies a matrix with `m` rows and `n` columns.

Programmatic Use**Block Parameter:** Dimensions**Type:** character vector**Values:** `'-1'` | `n` | `[m n]`**Default:** `'-1'`**Variable-size signal — Allow signal to be variable-size, fixed-size, or both**`Inherit` (default) | `No` | `Yes`

Specify the signal to be of variable-size, fixed size, or both.

- `Inherit` — Allows variable-size and fixed-size signals.
- `No` — Does not allow variable-size signals.
- `Yes` — Allows only variable-size signals.

Dependencies

When the signal is a variable-size signal, the **Dimensions** parameter specifies the maximum dimensions of the signal.

If you specify a bus object, the simulation allows variable-size signals only with a disabled bus object.

Programmatic Use**Block Parameter:** VarSizeSig**Type:** character vector**Values:** `'Inherit'` | `'No'` | `'Yes'`**Default:** `'Inherit'`**Sample time (-1 for inherited) — Time interval between samples**`-1` (default) | scalar | vector

Specify the time interval between samples. To inherit the sample time, set this parameter to `-1`. See “Specify Sample Time” for more information.

Programmatic Use**Parameter:** SampleTime**Type:** character vector**Values:** Any valid sample time**Default:** `'-1'`**Signal type — Complexity of signal**`auto` (default) | `real` | `complex`

Specify the complexity of the input and output signals.

- `auto` — Accepts either `real` or `complex` as the numeric type.
- `real` — Specifies the numeric type as a real number.
- `complex` — Specifies the numeric type as a complex number.

Programmatic Use**Parameter:** SignalType**Type:** character vector

Values: 'auto' | 'real' | 'complex'

Default: 'auto'

Block Characteristics

| | |
|---------------------------------|--|
| Data Types | Boolean bus double enumerated fixed point half integer single string |
| Direct Feedthrough | no |
| Multidimensional Signals | yes |
| Variable-Size Signals | yes |
| Zero-Crossing Detection | no |

Extended Capabilities

C/C++ Code Generation

Generate C and C++ code using Simulink® Coder™.

HDL Code Generation

Generate Verilog and VHDL code for FPGA and ASIC designs using HDL Coder™.

HDL Coder provides additional configuration options that affect HDL implementation and synthesized logic.

HDL Architecture

This block has a pass-through implementation.

HDL Block Properties

| | |
|----------------------------------|--|
| ConstrainedOutputPipeline | Number of registers to place at the outputs by moving existing delays within your design. Distributed pipelining does not redistribute these registers. The default is 0. For more details, see “ConstrainedOutputPipeline” (HDL Coder). |
| InputPipeline | Number of input pipeline stages to insert in the generated code. Distributed pipelining and constrained output pipelining can move these registers. The default is 0. For more details, see “InputPipeline” (HDL Coder). |
| OutputPipeline | Number of output pipeline stages to insert in the generated code. Distributed pipelining and constrained output pipelining can move these registers. The default is 0. For more details, see “OutputPipeline” (HDL Coder). |

Complex Data Support

This block supports code generation for complex signals.

Fixed-Point Conversion

Design and simulate fixed-point systems using Fixed-Point Designer™.

See Also

Unit System Configuration

Topics

“Unit Specification in Simulink Models”

“Variable-Size Signal Basics”

“Specify Sample Time”

Introduced before R2006a

Simulink Function

Graphically define a function with Simulink blocks

Library: Simulink / User-Defined Functions
SimEvents

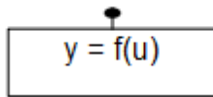

Description

The Simulink Function block is a Subsystem block preconfigured as a starting point for graphically defining a function with Simulink blocks. The block provides a text interface to function callers. You can call a Simulink Function block from a Function Caller block, a MATLAB Function block, or a Stateflow chart. See “Call a Simulink Function from a Model”.

For a description of the block parameters, see Subsystem.

You can visualize Simulink Function calls in the **Sequence Viewer**. The viewer shows when calls were made with the argument and the return values.

You can select a Simulink Function or Function Caller block to highlight blocks related to it. To show a related block in an open diagram or new tab, pause on the ellipsis that appears after selection.

Then, select **Related Blocks**  from the action bar. When multiple blocks correspond to the selected block, a list of related blocks opens. You can filter the list of related blocks by entering a search term in the text box. After you select a related block from the list, window focus goes to the open diagram or new tab that shows the related block.

Function Interface

The function interface appears on the face of a Simulink Function block. Editing the block text adds and deletes Argument Inport blocks and Argument Outport blocks from the function definition. Editing also sets the **Function name** parameter in the Trigger block within the Simulink Function block.

For example, entering `y = myfunction(u)` on the face of a Simulink Function block adds one Argument Inport block (u) and one Argument Outport block (y) within the subsystem.

When calling a function using a Function Caller block, the parameter **Function prototype** in the Function Caller block must match exactly the function interface you specify on the Simulink Function block. This match includes the name of the function and the names of input and output arguments. For example, the Simulink Function block and the Function Caller block both use the argument names u and y.

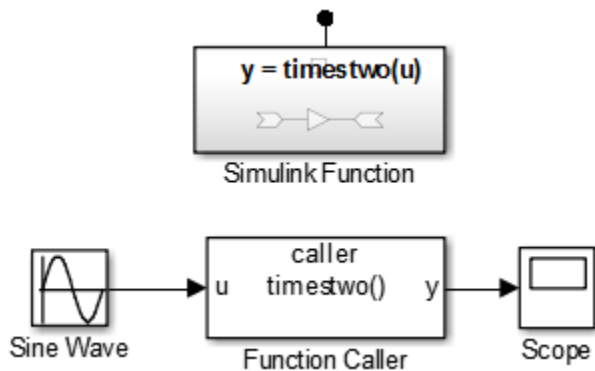

When calling a function from a Stateflow transition or state label, you can use different argument names. For example, the Simulink Function block uses x and y arguments while the Stateflow transition uses $x2$ and $y2$ arguments to call the function.

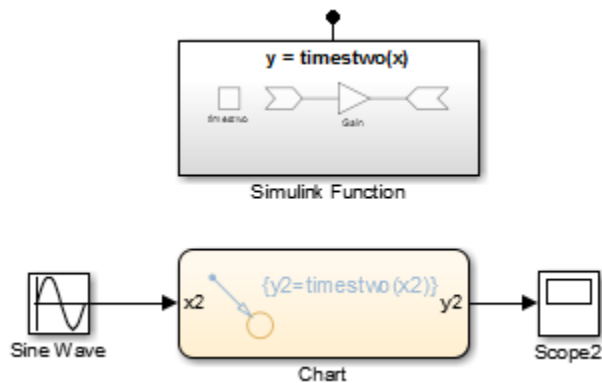

Function-Call Subsystems Versus Simulink Function Blocks

In general, a Function-Call Subsystem block provides better signal traceability with direct signal connections than a Simulink Function block, whereas a Simulink Function block eliminates the need for routing input and output signal lines through the model hierarchy.

| Attribute | Function-Call Subsystem block | Simulink Function block |
|--|-------------------------------|---|
| Method of executing/invoking function | Triggered using a signal line | Called by reference using the function name |
| Formal input arguments (Argument Inport blocks) and output arguments (Argument Outport blocks) | No | Yes |
| Local inputs (Inport block) and outputs (Outport block) | Yes | Yes |

Ports

Input

In — Signal input to a subsystem block

scalar | vector | matrix

Placing an Inport block in a subsystem block adds an external input port to the Simulink Function block. The port label matches the name of the Inport block.

Use Inport blocks to get signals from the local environment.

Data Types: single | double | half | int8 | int16 | int32 | int64 | uint8 | uint16 | uint32 | uint64 | Boolean | fixed point | enumerated | bus | struct

ArgIn — Argument input to a subsystem block

scalar | vector | matrix

An Argument Inport block in a subsystem block provides an input port corresponding to an input argument. A port is not displayed on the subsystem block.

Data Types: single | double | half | int8 | int16 | int32 | int64 | uint8 | uint16 | uint32 | uint64 | Boolean | fixed point | enumerated | bus | struct

Output

Out — Signal output from a subsystem

scalar | vector | matrix

Placing an Outport block in a subsystem block adds an output port from the block. The port label on the subsystem block is the name of the Outport block.

Use Outport blocks to send signals to the local environment.

Data Types: single | double | half | int8 | int16 | int32 | int64 | uint8 | uint16 | uint32 | uint64 | Boolean | fixed point | enumerated | bus | struct

ArgOut — Argument output from a subsystem block

scalar | vector | matrix

An Argument Outport block in a subsystem block provides an output port corresponding to an output argument. A port is not displayed on the subsystem block.

Data Types: single | double | half | int8 | int16 | int32 | int64 | uint8 | uint16 | uint32 | uint64 | Boolean | fixed point | enumerated | bus | struct

Block Characteristics

| | |
|---------------------------------|---|
| Data Types | Boolean ^a bus ^a double ^a enumerated ^a fixed point ^a half ^a integer ^a single ^a string ^a |
| Direct Feedthrough | no |
| Multidimensional Signals | limited ^a |
| Variable-Size Signals | no |

| | |
|--------------------------------|----|
| Zero-Crossing Detection | no |
|--------------------------------|----|

a. Actual data type or capability support depends on block implementation.

Extended Capabilities

C/C++ Code Generation

Generate C and C++ code using Simulink® Coder™.

Actual code generation support depends on block implementation.

Fixed-Point Conversion

Design and simulate fixed-point systems using Fixed-Point Designer™.

Actual data type support depends on block implementation.

See Also

Blocks

Argument Inport | Argument Outport | Trigger | Function Caller | MATLAB Function | Chart | Subsystem | Function-Call Subsystem | Inport | Outport

Topics

“Simulink Functions Overview”

“Scoped Simulink Function Blocks in Models”

“Add a Simulink Function to a Model”

Introduced in R2014b

Sine, Cosine

Implement fixed-point sine or cosine wave using lookup table approach that exploits quarter wave symmetry

Library: Simulink / Lookup Tables

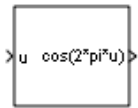
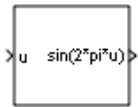

Description

The Sine and Cosine block implements a sine and/or cosine wave in fixed point using a lookup table method that exploits quarter wave symmetry. The block can output the following functions of the input signal, depending upon what you select for the **Output formula** parameter:

- $\sin(2\pi u)$
- $\cos(2\pi u)$
- $\exp(j2\pi u)$
- $\sin(2\pi u)$ and $\cos(2\pi u)$

You define the number of lookup table points in the **Number of data points for lookup table** parameter. The block implementation is most efficient when you specify the lookup table data points to be $(2^n)+1$, where n is an integer.

Use the **Output word length** parameter to specify the word length of the fixed-point output data type. The fraction length of the output is the output word length minus 2.

Ports

Input

u — Input signal to implement as fixed-point sine or cosine wave

real-valued signal

Input signal, u , specified as a real-valued scalar, vector, or matrix.

Tip To obtain meaningful block output, the block input values should fall within the range $[0, 1)$. For input values that fall outside this range, the values are cast to an unsigned data type, where overflows wrap. For these out-of-range inputs, the block output might not be meaningful.

Data Types: `single` | `double` | `int8` | `int16` | `int32` | `int64` | `uint8` | `uint16` | `uint32` | `uint64` | `Boolean` | `fixed point`

Output

`sin(2*pi*u)` — Fixed-point sine wave

real-valued fixed-point signal

Fixed-point sine wave, implemented using a lookup table approach.

Dependencies

This port is enabled when the **Output formula** is set to `sin(2*pi*u)` or `sin(2*pi*u)` and `cos(2*pi*u)`.

Data Types: `fixed point`

`cos(2*pi*u)` — Fixed-point cosine wave

real-valued fixed-point signal

Fixed-point cosine wave, implemented using a lookup table approach.

Dependencies

This port is enabled when the **Output formula** is set to `cos(2*pi*u)` or `sin(2*pi*u)` and `cos(2*pi*u)`.

Data Types: `fixed point`

`exp(j*2*pi*u)` — `exp(j*2*pi*u)`

complex-valued fixed-point signal

`exp(j*2*pi*u)`, implemented using a lookup table approach.

Dependencies

This port is enabled when the **Output formula** is set to `exp(j*2*pi*u)`.

Data Types: `fixed point`

Parameters

Output formula — Select the signal(s) to output

`cos(2*pi*u)` | `sin(2*pi*u)` | `exp(j*2*pi*u)` | `sin(2*pi*u)` and `cos(2*pi*u)`

Programmatic Use

Block Parameter: `Formula`

Values: `'sin(2*pi*u)'` | `'cos(2*pi*u)'` | `'exp(j*2*pi*u)'` | `'sin(2*pi*u) and cos(2*pi*u)'`

Number of data points for lookup table — Specify the number of data points to retrieve from the lookup table

$(2^5)+1$ (default) | integer, greater than or equal to 2

The implementation is most efficient when you specify the lookup table data points to be $(2^n)+1$, where n is an integer. To be compatible with the **Output word length** parameter, the **Number of data points for lookup table** must be less than or equal to $(2^{(\text{Output word length}-2)}+1)$.

Programmatic Use**Block Parameter:** NumDataPoints**Type:** scalar**Value:** integer ≥ 2 **Default:** '(2^5)+1'**Output word length — Specify the word length for the fixed-point data type of the output signal**

16 (default) | integer from 2 to 53

The fraction length of the output is the output word length minus 2. To be compatible with the **Number of data points for lookup table** parameter, $2^{(\text{Output word length} - 2) + 1}$ must be greater than or equal to **Number of data points for lookup table**.

Note The block uses double-precision floating-point values to construct lookup tables. Therefore, the maximum amount of precision you can achieve in your output is 53 bits. Setting the word length to values greater than 53 bits does not improve the precision of your output.

Programmatic Use**Block Parameter:** OutputWordLength**Type:** scalar**Value:** integer from 2 to 53**Default:** '16'**Internal rule priority for lookup table — Specify the internal rule for intermediate calculations**

Speed (default) | Precision

Select Speed for faster calculations. If you do, a loss of accuracy might occur, usually up to 2 bits.

Programmatic Use**Block Parameter:** InternalRulePriority**Values:** 'Speed' | 'Precision'**Default:** 'Speed'**Block Characteristics**

| | |
|---------------------------------|---|
| Data Types | Boolean double fixed point integer single |
| Direct Feedthrough | no |
| Multidimensional Signals | no |
| Variable-Size Signals | no |
| Zero-Crossing Detection | no |

Extended Capabilities**C/C++ Code Generation**

Generate C and C++ code using Simulink® Coder™.

HDL Code Generation

Generate Verilog and VHDL code for FPGA and ASIC designs using HDL Coder™.

HDL Coder provides additional configuration options that affect HDL implementation and synthesized logic.

HDL Architecture

The HDL code implements Cosine and Sine blocks by using the quarter-wave lookup table that you specify in the Simulink block parameters.

To avoid generating a division operator (/) in the HDL code, for **Number of data points for lookup table**, enter $(2^n)+1$. n is an integer.

HDL Block Properties

| | |
|----------------------------------|--|
| ConstrainedOutputPipeline | Number of registers to place at the outputs by moving existing delays within your design. Distributed pipelining does not redistribute these registers. The default is 0. For more details, see “ConstrainedOutputPipeline” (HDL Coder). |
| InputPipeline | Number of input pipeline stages to insert in the generated code. Distributed pipelining and constrained output pipelining can move these registers. The default is 0. For more details, see “InputPipeline” (HDL Coder). |
| OutputPipeline | Number of output pipeline stages to insert in the generated code. Distributed pipelining and constrained output pipelining can move these registers. The default is 0. For more details, see “OutputPipeline” (HDL Coder). |

Limitations

If you use Intel MAX 10 device, to map the lookup table to RAM, add this Tcl command when creating the project in the Quartus tool:

```
set_global_assignment -name INTERNAL_FLASH_UPDATE_MODE "SINGLE IMAGE WITH ERAM"
```

Fixed-Point Conversion

Design and simulate fixed-point systems using Fixed-Point Designer™.

See Also

Sine Wave | Trigonometric Function | Sine HDL Optimized | Cosine HDL Optimized

Topics

“About Lookup Table Blocks”

Introduced before R2006a

Sine Wave

Generate sine wave, using simulation time as time source

Library: Simulink / Sources



Description

The Sine Wave block outputs a sinusoidal waveform. The block can operate in time-based or sample-based mode.

Note This block is the same as the Sine Wave Function block that appears in the Math Operations library. If you select Use external signal for the **Time** parameter in the block dialog box, you get the Sine Wave Function block.

Time-Based Mode

The block calculates the output waveform.

$$y = \text{amplitude} \times \sin(\text{frequency} \times \text{time} + \text{phase}) + \text{bias}.$$

In time-based mode, the value of the **Sample time** parameter determines whether the block operates in continuous mode or discrete mode.

- 0 (the default) causes the block to operate in continuous mode.
- >0 causes the block to operate in discrete mode.

For more information, see “Specify Sample Time”.

Block Behavior in Continuous Mode

When operating in continuous mode, the Sine Wave block can become inaccurate due to loss of precision as time becomes very large.

Block Behavior in Discrete Mode

A **Sample time** parameter value greater than zero causes the block to behave as if it were driving a Zero-Order Hold block whose sample time is set to that value.

This way, you can build models with sine wave sources that are purely discrete, rather than models that are hybrid continuous/discrete systems. Hybrid systems are inherently more complex and as a result take more time to simulate.

In discrete mode, this block uses a differential incremental algorithm instead of one based on absolute time. As a result, the block can be useful in models intended to run for an indefinite length of time, such as in vibration or fatigue testing.

The differential incremental algorithm computes the sine based on the value computed at the previous sample time. This method uses the following trigonometric identities:

$$\begin{aligned}\sin(t + \Delta t) &= \sin(t)\cos(\Delta t) + \sin(\Delta t)\cos(t) \\ \cos(t + \Delta t) &= \cos(t)\cos(\Delta t) - \sin(t)\sin(\Delta t)\end{aligned}$$

In matrix form, these identities are:

$$\begin{bmatrix} \sin(t + \Delta t) \\ \cos(t + \Delta t) \end{bmatrix} = \begin{bmatrix} \cos(\Delta t) & \sin(\Delta t) \\ -\sin(\Delta t) & \cos(\Delta t) \end{bmatrix} \begin{bmatrix} \sin(t) \\ \cos(t) \end{bmatrix}$$

Because Δt is constant, the following expression is a constant:

$$\begin{bmatrix} \cos(\Delta t) & \sin(\Delta t) \\ -\sin(\Delta t) & \cos(\Delta t) \end{bmatrix}$$

Therefore, the problem becomes one of a matrix multiplication of the value of $\sin(t)$ by a constant matrix to obtain $\sin(t + \Delta t)$.

Discrete mode reduces but does not eliminate the accumulation of round-off errors, for example, ($4 \cdot \text{eps}$). This accumulation can happen because computation of the block output at each time step depends on the value of the output at the previous time step.

Methods to Handle Round-Off Errors in Discrete Mode

To handle round-off errors when the Sine Wave block operates in time-based discrete mode, use one of these methods.

| Method | Rationale |
|---|--|
| Insert a Saturation block directly downstream of the Sine Wave block. | By setting saturation limits on the Sine Wave block output, you can remove overshoot due to accumulation of round-off errors. |
| Set up the Sine Wave block to use the <code>sin()</code> math library function to calculate block output. <ol style="list-style-type: none"> 1 On the Sine Wave block dialog box, set Time to Use external signal so that an input port appears on the block icon. 2 Connect a clock signal to this input port using a Digital Clock block. 3 Set the sample time of the clock signal to the sample time of the Sine Wave block. | The <code>sin()</code> math library function computes block output at each time step <i>independently</i> of output values from other time steps, preventing the accumulation of round-off errors. |

Sample-Based Mode

Sample-based mode uses this formula to compute the output of the Sine Wave block.

$$y = A\sin(2\pi(k + o)/p) + b$$

- A is the amplitude of the sine wave.
- p is the number of time samples per sine wave period.
- k is a repeating integer value that ranges from 0 to $p-1$.
- o is the offset (phase shift) of the signal.
- b is the signal bias.

In this mode, Simulink sets k equal to θ at the first time step and computes the block output, using the formula. At the next time step, Simulink increments k and recomputes the output of the block. When k reaches p , Simulink resets k to θ before computing the block output. This process continues until the end of the simulation.

The sample-based method of computing block output at a given time step does not depend on the output of the previous time steps. Therefore, this mode avoids the accumulation of round-off errors. Sample-based mode supports reset semantics in subsystems that offer it. For example, if a Sine Wave block is in a resettable subsystem that receives a reset trigger, the repeating integer k resets and the block output resets to its initial condition.

Ports

Output

Port_1 — Sine wave output signal

scalar | vector

Output sine wave signal created based on the block parameter values.

Data Types: double

Parameters

Sine type — Type of sine wave

Time based (default) | Sample based

Specify the type of sine wave that this block generates. Some parameters in the dialog box appear depending on whether you select time-based or sample-based.

Programmatic Use

Block Parameter: SineType

Type: character vector

Values: 'Time based' | 'Sample based'

Default: 'Time based'

Time (t) — Source of time variable

Use simulation time (default) | Use external signal

Specify whether to use simulation time as the source of values for the time variable, or an external source. If you specify an external time source, the block creates an input port for the time source. When you select an external time source, the block is the same as the Sine Wave Function block.

Programmatic Use

Block Parameter: TimeSource

Type: character vector

Values: 'Use simulation time' | 'Use external signal'

Default: 'Use simulation time'

Amplitude — Amplitude of the sine wave

1 (default) | scalar | vector

Specify the amplitude of the output sine wave signal.

Programmatic Use**Block Parameter:** Amplitude**Type:** character vector**Value:** scalar**Default:** '1'**Bias — Constant added to sine wave** 0 (default) | scalar | vector

Specify the constant value added to the sine to produce the output.

Programmatic Use**Block Parameter:** Bias**Type:** character vector**Value:** scalar**Default:** '0'**Frequency (rad/sec) — Frequency of sine wave**

1 (default) | scalar | vector

Specify the frequency, in rad/sec.

Dependencies

To enable this parameter, set **Sine type** to Time based.

Programmatic Use**Block Parameter:** Frequency**Type:** character vector**Value:** scalar**Default:** '1'**Phase (rad) — Phase shift of sine wave** 0 (default) | scalar | vector

Specify the phase shift of the sine wave.

You cannot configure this parameter to appear in the generated code as a tunable global variable if you set **Time (t)** to Use simulation time. For example, if you set **Default parameter behavior** to Tunable or apply a storage class to a Simulink.Parameter object, the **Phase** parameter does not appear in the generated code as a tunable global variable.

To generate code so that you can tune the phase during execution, set **Time (t)** to Use external signal. You can provide your own time input signal or use a Digital Clock block to generate the time signal. For an example, see “Tune Phase Parameter of Sine Wave Block During Code Execution” (Simulink Coder).

Dependencies

To enable this parameter, set **Sine type** to Time based.

Programmatic Use**Block Parameter:** Phase**Type:** character vector**Value:** scalar**Default:** '0'

Samples per period — Samples per period`0 (default) | integer scalar | integer vector`

Specify the number of samples per period.

Dependencies

To enable this parameter, set **Sine type** to `Sample based`.

Programmatic Use**Block Parameter:** `Samples`**Type:** character vector**Value:** scalar**Default:** `'10'`**Number of offset samples — Offset in number of time samples**`0 (default) | integer scalar | integer vector`

Specify the offset (discrete phase shift) in number of sample times.

Dependencies

To enable this parameter, set **Sine type** to `Sample based`.

Programmatic Use**Block Parameter:** `Offset`**Type:** character vector**Value:** scalar**Default:** `'0'`**Sample time — Sample period**`0 (default) | scalar | vector`

Specify the sample period in seconds. The default is `0`. If the sine type is sample-based, the sample time must be greater than `0`. See “Specify Sample Time”.

Programmatic Use**Block Parameter:** `SampleTime`**Type:** character vector**Value:** scalar**Default:** `'0'`**Interpret vector parameters as 1-D — Output dimensions for one-row or one-column matrices**`off (default) | on`

Specify the output dimensions to be a 1-D vector signal when other parameters are one-row and one-column matrices. If you do not select this box, the block outputs a signal of the same dimensionality as the numeric parameters. See “Determine the Output Dimensions of Source Blocks”. This parameter is not available when an external signal specifies time. In this case, if numeric parameters are column or row matrix values, the output is a 1-D vector.

Programmatic Use**Block Parameter:** `VectorParams1D`**Type:** character vector**Values:** `'off' | 'on'`

Default: 'on'

Block Characteristics

| | |
|---------------------------------|--------|
| Data Types | double |
| Direct Feedthrough | yes |
| Multidimensional Signals | no |
| Variable-Size Signals | no |
| Zero-Crossing Detection | no |

Extended Capabilities

C/C++ Code Generation

Generate C and C++ code using Simulink® Coder™.

Depends on absolute time when placed inside a triggered subsystem hierarchy. These blocks do not reference absolute time when configured for sample-based operation. In time-based operation, they depend on absolute time.

See Also

Sine, Cosine | Sine Wave Function

Introduced before R2006a

Sine Wave Function

Generate sine wave, using external signal as time source

Library: Simulink / Math Operations

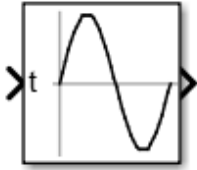

Description

The Sine Wave Function block outputs a sinusoidal waveform. The block can operate in time-based or sample-based mode.

Note This block is the same as the Sine Wave block that appears in the Math Operations library. If you select Use simulation time for the **Time** parameter in the block dialog box, you get the Sine Wave Function block.

Time-Based Mode

The block calculates the output waveform.

$$y = \text{amplitude} \times \sin(\text{frequency} \times \text{time} + \text{phase}) + \text{bias}.$$

In time-based mode, the value of the **Sample time** parameter determines whether the block operates in continuous mode or discrete mode.

- 0 (the default) causes the block to operate in continuous mode.
- >0 causes the block to operate in discrete mode.

For more information, see “Specify Sample Time”.

Block Behavior in Continuous Mode

When operating in continuous mode, the Sine Wave block can become inaccurate due to loss of precision as time becomes very large.

Block Behavior in Discrete Mode

A **Sample time** parameter value greater than zero causes the block to behave as if it were driving a Zero-Order Hold block whose sample time is set to that value.

This way, you can build models with sine wave sources that are purely discrete, rather than models that are hybrid continuous/discrete systems. Hybrid systems are inherently more complex and as a result take more time to simulate.

In discrete mode, this block uses a differential incremental algorithm instead of one based on absolute time. As a result, the block can be useful in models intended to run for an indefinite length of time, such as in vibration or fatigue testing.

The differential incremental algorithm computes the sine based on the value computed at the previous sample time. This method uses the following trigonometric identities:

$$\begin{aligned}\sin(t + \Delta t) &= \sin(t)\cos(\Delta t) + \sin(\Delta t)\cos(t) \\ \cos(t + \Delta t) &= \cos(t)\cos(\Delta t) - \sin(t)\sin(\Delta t)\end{aligned}$$

In matrix form, these identities are:

$$\begin{bmatrix} \sin(t + \Delta t) \\ \cos(t + \Delta t) \end{bmatrix} = \begin{bmatrix} \cos(\Delta t) & \sin(\Delta t) \\ -\sin(\Delta t) & \cos(\Delta t) \end{bmatrix} \begin{bmatrix} \sin(t) \\ \cos(t) \end{bmatrix}$$

Because Δt is constant, the following expression is a constant:

$$\begin{bmatrix} \cos(\Delta t) & \sin(\Delta t) \\ -\sin(\Delta t) & \cos(\Delta t) \end{bmatrix}$$

Therefore, the problem becomes one of a matrix multiplication of the value of $\sin(t)$ by a constant matrix to obtain $\sin(t + \Delta t)$.

Discrete mode reduces but does not eliminate the accumulation of round-off errors, for example, $(4 * \text{eps})$. This accumulation can happen because computation of the block output at each time step depends on the value of the output at the previous time step.

Methods to Handle Round-Off Errors in Discrete Mode

To handle round-off errors when the Sine Wave block operates in time-based discrete mode, use one of these methods.

| Method | Rationale |
|--|--|
| Insert a Saturation block directly downstream of the Sine Wave block. | By setting saturation limits on the Sine Wave block output, you can remove overshoot due to accumulation of round-off errors. |
| Set up the Sine Wave block to use the <code>sin()</code> math library function to calculate block output. <ol style="list-style-type: none"> On the Sine Wave block dialog box, set Time to Use external signal so that an input port appears on the block icon. Connect a clock signal to this input port using a Digital Clock block. Set the sample time of the clock signal to the sample time of the Sine Wave block. | The <code>sin()</code> math library function computes block output at each time step <i>independently</i> of output values from other time steps, preventing the accumulation of round-off errors. |

Sample-Based Mode

Sample-based mode uses this formula to compute the output of the Sine Wave block.

$$y = A \sin(2\pi(k + o)/p) + b$$

- A is the amplitude of the sine wave.
- p is the number of time samples per sine wave period.
- k is a repeating integer value that ranges from 0 to $p-1$.

- o is the offset (phase shift) of the signal.
- b is the signal bias.

In this mode, Simulink sets k equal to 0 at the first time step and computes the block output, using the formula. At the next time step, Simulink increments k and recomputes the output of the block. When k reaches p , Simulink resets k to 0 before computing the block output. This process continues until the end of the simulation.

The sample-based method of computing block output at a given time step does not depend on the output of the previous time steps. Therefore, this mode avoids the accumulation of round-off errors. Sample-based mode supports reset semantics in subsystems that offer it. For example, if a Sine Wave block is in a resettable subsystem that receives a reset trigger, the repeating integer k resets and the block output resets to its initial condition.

Ports

Input

Port_1 — Time source signal

scalar

Input signal representing the time source in the sine wave calculation.

Data Types: double

Output

Output 1 — Output sine wave signal

scalar

Output signal that is the created sine wave.

Data Types: double

Parameters

Sine type — Type of sine wave

Time based (default) | Sample based

Specify the type of sine wave that this block generates. Some parameters in the dialog box appear depending on whether you select time-based or sample-based.

Programmatic Use

Block Parameter: SineType

Type: character vector

Values: 'Time based' | 'Sample based'

Default: 'Time based'

Time (t) — Source of time variable

Use external signal (default) | Use simulation time

Specify whether to use simulation time as the source of values for the time variable, or an external source. If you specify an external time source, the block creates an input port for the time source.

Programmatic Use**Block Parameter:** TimeSource**Type:** character vector**Values:** 'Use simulation time' | 'Use external signal'**Default:** 'Use external signal'**Amplitude — Amplitude of the sine wave**

1 (default) | scalar

Specify the amplitude of the output sine wave signal.

Programmatic Use**Block Parameter:** Amplitude**Type:** character vector**Value:** scalar**Default:** '1'**Bias — Constant added to sine wave**

0 (default) | scalar

Specify the constant value added to the sine to produce the output.

Programmatic Use**Block Parameter:** Bias**Type:** character vector**Value:** scalar**Default:** '0'**Frequency (rad/sec) — Frequency of sine wave**

1 (default) | scalar

Specify the frequency, in radians per second.

DependencyTo enable this parameter, set **Sine type** to Time based.**Programmatic Use****Block Parameter:** Frequency**Type:** character vector**Value:** scalar**Default:** '1'**Phase (rad) — Phase shift of sine wave**

0 (default) | scalar

Specify the phase shift of the sine wave.

You cannot configure this parameter to appear in the generated code as a tunable global variable if you set **Time (t)** to Use simulation time. For example, if you set **Default parameter behavior** to Tunable or apply a storage class to a Simulink.Parameter object, the **Phase** parameter does not appear in the generated code as a tunable global variable.

To generate code so that you can tune the phase during execution, set **Time (t)** to Use external signal. You can provide your own time input signal or use a Digital Clock block to generate the time signal. For an example, see “Tune Phase Parameter of Sine Wave Block During Code Execution” (Simulink Coder).

Dependencies

To enable this parameter, set **Sine type** to Time based.

Programmatic Use

Block Parameter: Phase

Type: character vector

Value: scalar

Default: '0'

Samples per period — Samples per period

0 (default) | integer

Specify the number of samples per period.

Dependencies

To enable this parameter, set **Sine type** to Sample based.

Programmatic Use

Block Parameter: Samples

Type: character vector

Value: scalar

Default: '10'

Number of offset samples — Offset in number of time samples

0 (default) | integer

Specify the offset (discrete phase shift) in number of sample times.

Dependencies

To enable this parameter, set **Sine type** to Sample based.

Programmatic Use

Block Parameter: Offset

Type: character vector

Value: scalar

Default: '0'

Sample time — Sample period

0 (default) | scalar

Specify the sample period in seconds. The default is 0. If the sine type is sample-based, the sample time must be greater than 0. See “Specify Sample Time”.

Programmatic Use

Block Parameter: SampleTime

Type: character vector

Value: scalar

Default: '0'

Interpret vector parameters as 1-D — Output dimensions for one-row or one-column matrices

off (default) | on

Specify the output dimensions to be a 1-D vector signal when other parameters are one-row and one-column matrices. If you do not select this box, the block outputs a signal of the same dimensionality

as the numeric parameters. See “Determine the Output Dimensions of Source Blocks”. This parameter is not available when an external signal specifies time. In this case, if numeric parameters are column or row matrix values, the output is a 1-D vector.

Programmatic Use

Block Parameter: VectorParams1D

Type: character vector

Values: 'off' | 'on'

Default: 'on'

Block Characteristics

| | |
|---------------------------------|--------|
| Data Types | double |
| Direct Feedthrough | yes |
| Multidimensional Signals | no |
| Variable-Size Signals | no |
| Zero-Crossing Detection | no |

Extended Capabilities

C/C++ Code Generation

Generate C and C++ code using Simulink® Coder™.

Depends on absolute time when placed inside a triggered subsystem hierarchy. These blocks do not reference absolute time when configured for sample-based operation. In time-based operation, they depend on absolute time.

See Also

Sine Wave | Sine, Cosine

Introduced before R2006a

Slider

Tune parameter value with sliding scale

Library: Simulink / Dashboard

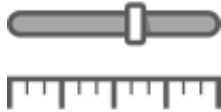

Description

The Slider block tunes the value of the connected block parameter during simulation. For example, you can connect the Slider block to a Gain block in your model and adjust its value during simulation. You can modify the range of the Slider block's scale to fit your data. Use the Slider block with other Dashboard blocks to create an interactive dashboard to control your model.

Connect Dashboard Blocks

Dashboard blocks do not use ports to connect to model elements. To connect dashboard blocks to variables and block parameters, use connect mode. Connect mode facilitates the process of connecting dashboard blocks in your model, especially when you want to connect multiple blocks at once. To connect a single dashboard block, you can also use the **Connection** table in the block dialog box.

Tip You can modify dashboard block connections in your model during normal and accelerator mode simulations.

Note Dashboard blocks cannot connect to variables until you update the model diagram. To connect dashboard blocks to variables or modify variable values between opening your model and running a simulation, update the model diagram using **Ctrl+D**.

To enter connect mode, select the block. Then, on the block tab, click **Connect**. In connect mode, when you select one or more blocks, a list of parameters and variables available for connection appears. Select a variable or parameter from the list to connect to the selected dashboard block.

When the value of the selected variable or block parameter is nonscalar, use the text box at the bottom of the **Connection** table to specify the element you want to connect to the dashboard block. To connect to an element of a vector, matrix, or array, specify the element index, for example, 3 or (1, 3). To connect to an element in a bus or structure, specify the element in the context of the bus or structure hierarchy by using dots to indicate different levels in the hierarchy, and omit the top level. For example, specify a.b to connect to scalar element b of the structure or bus a nested inside the selected composite variable or parameter.

To connect another dashboard block, pause on another dashboard block and click the **Connect** button above it. Then, make a selection of signals and blocks in your model and choose a model element to connect.

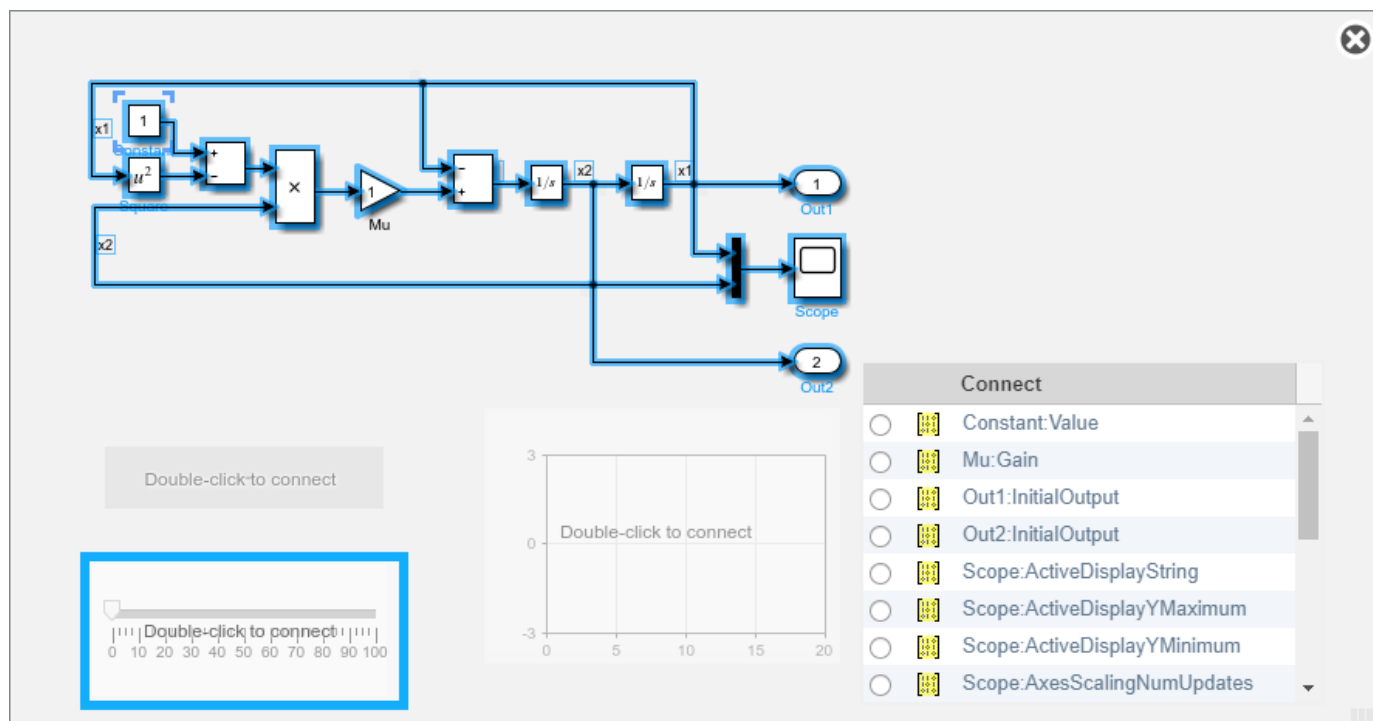

When you finish connecting the dashboard blocks in your model, on the block tab, click **Done Connecting**.

Tip You can hide the message shown on unconnected blocks using the `set_param` function with the `ShowInitialText` block parameter. The message also disappears when you connect the block.

Parameter Logging

Tunable parameters connected to dashboard blocks are logged to the Simulation Data Inspector, where you can view the parameter values along with logged signal data. You can access logged parameter data in the MATLAB workspace by exporting the parameter data from the Simulation Data Inspector by using the UI or the `Simulink.sdi.exportRun` function. For more information about exporting data using the Simulation Data Inspector UI, see “Export Data to the Workspace or a File”. The parameter data is stored in a `Simulink.SimulationData.Parameter` object, accessible as an element in the exported `Simulink.SimulationData.Dataset`.

Limitations

- Except for the Dashboard Scope block and the Display block, dashboard blocks can only connect to real scalar signals.
- The toolstrip does not support blocks that are inside a panel.
- You cannot use the **Connection** table in the block dialog to connect a dashboard block to a block that is commented out. When you connect a dashboard block to a commented block using connect mode, the dashboard block does not display the connected value until the you uncomment the block.
- Dashboard blocks cannot connect to model elements inside referenced models.

- When you simulate a model hierarchy, dashboard blocks inside referenced models do not update.
- Dashboard blocks do not support rapid accelerator simulation.
- When you connect a dashboard block to a variable or parameter during simulation, the data for that variable or parameter is not logged to the Simulation Data Inspector. To log variable and parameter data to the Simulation Data Inspector, connect the dashboard block to the variable or parameter prior to simulation.
- When you simulate a model in external mode with the **Default parameter behavior** set to **Inlined**, dashboard blocks can appear to change parameter and variable values. However, the change does not propagate to the simulation. For example, Gain blocks display changes made to the **Gain** parameter using the dashboard blocks, but the **Gain** value used in the simulation does not change.

Parameters

Connection — Select a variable or block parameter to connect

variable and parameter connection options

Select the variable or block parameter to control using the **Connection** table. To connect the block to a signal:

- 1 Make a selection in the model that includes one or more blocks.
- 2 Select the variable or parameter you want to connect.

When the value of the selected variable or block parameter is nonscalar, use the text box at the bottom of the **Connection** table to specify the element you want to connect to the dashboard block. To connect to an element of a vector, matrix, or array, specify the element index, for example, 3 or (1, 3). To connect to an element in a bus or structure, specify the element in the context of the bus or structure hierarchy by using dots to indicate different levels in the hierarchy, and omit the top level. For example, specify `a.b` to connect to scalar element `b` of the structure or bus `a` nested inside the selected composite variable or parameter.

- 3 Click **Apply**.

To facilitate understanding and debugging your model, you can connect Dashboard blocks to variables and parameters in your model during simulation.

Note To see workspace variables in the connection table, update the model diagram using **Ctrl+D**.

Programmatic Use

To programmatically connect a dashboard block to a tunable parameter or a variable, use a `Simulink.HMI.ParamSourceInfo` object. The `Simulink.HMI.ParamSourceInfo` object contains four properties. Some of the properties apply to connecting dashboard blocks to parameters, and some apply to connecting dashboard blocks to variables. Not all fields have a value for a connection because a given dashboard block connects to either a parameter or a variable.

Block Parameter: Binding

Type: `Simulink.HMI.ParamSourceInfo`

Default: []

Scale Type — Type of scale

Linear (default) | Log

Type of scale displayed on the block. **Linear** specifies a linear scale, and **Log** specifies a logarithmic scale.

Programmatic Use

Block Parameter: ScaleType

Type: string or character vector

Values: 'Linear' | 'Log'

Default: 'Linear'

Minimum — Minimum tick mark value

0 (default) | scalar

Finite, real, double, scalar value specifying the minimum tick mark value for the scale. The minimum must be less than the value of the **Maximum** parameter.

Programmatic Use

To programmatically set the Minimum parameter, use a 1-by-3 vector containing values for the Minimum, Tick Interval, and Maximum parameters, in that order. To use the `auto` value for the Tick Interval, leave the Tick Interval position in the vector empty or specify `-1`.

Block Parameter: Limits

Type: 1×3 vector

Default: [0 -1 100]

Maximum — Maximum tick mark value

100 (default) | scalar

Finite, real, double, scalar value specifying the maximum tick mark value for the scale. The maximum must be greater than the value of the **Minimum** parameter.

Programmatic Use

To programmatically set the Maximum parameter, use a 1-by-3 vector containing values for the Minimum, Tick Interval, and Maximum parameters, in that order. To use the `auto` value for the Tick Interval, leave the Tick Interval position in the vector empty or specify `-1`.

Block Parameter: Limits

Type: 1×3 vector

Default: [0 -1 100]

Tick Interval — Interval between major tick marks

auto (default) | scalar

Finite, real, positive, whole, scalar value specifying the interval of major tick marks on the scale. When set to `auto`, the block automatically adjusts the tick interval based on the values of the **Maximum** and **Minimum** parameters.

Programmatic Use

To programmatically set the Tick Interval parameter, use a 1-by-3 vector containing values for the Minimum, Tick Interval, and Maximum parameters, in that order. To use the `auto` value for the Tick Interval, leave the Tick Interval position in the vector empty or specify `-1`.

Block Parameter: Limits

Type: 1×3 vector

Default: [0 -1 100]

Label — Block label position

Top (default) | Bottom | Hide

Position of the block label. When the block is connected to an element in the model, the label is the name of the connected element.

Programmatic Use**Block Parameter:** LabelPosition**Type:** character vector**Values:** 'Top' | 'Bottom' | 'Hide'**Default:** 'Top'**Block Characteristics**

| | |
|---------------------------------|----------------------------------|
| Data Types | double half integer single |
| Direct Feedthrough | no |
| Multidimensional Signals | no |
| Variable-Size Signals | no |
| Zero-Crossing Detection | no |

Extended Capabilities**C/C++ Code Generation**

Generate C and C++ code using Simulink® Coder™.

Dashboard blocks are ignored for code generation.

See Also

Knob | Rotary Switch

Topics

“Tune and Visualize Your Model with Dashboard Blocks”

“Decide How to Visualize Simulation Data”

Introduced in R2015b

Slider Gain

Vary scalar gain using slider

Library: Simulink / Math Operations



Description

The Slider Gain block performs a scalar gain that you can modify during simulation. Modify the gain using the slider parameter.

Ports

Input

Port_1 — Input signal

scalar | vector | matrix

The Slider Gain block accepts real or complex-valued scalar, vector, or matrix input. The block supports fixed-point data types.

Data Types: single | double | int8 | int16 | int32 | int64 | uint8 | uint16 | uint32 | uint64 | Boolean | fixed point

Output

Port_1 — Input multiplied by gain

scalar | vector | matrix

The Slider Gain block outputs the input multiplied by a constant gain value. When the input to the block is real and gain is complex, the output is complex.

Data Types: single | double | int8 | int16 | int32 | int64 | uint8 | uint16 | uint32 | uint64 | Boolean | fixed point

Parameters

Slider gain — Gain value

0 (default) | real value

Chose the gain value applied to the input.

Programmatic Use

Block Parameter: gain

Type: character vector

Values: real scalar

Default: '1'

Low — Lower limit of slider range 0 (default) | real value

Specify the lower limit of the slider range.

Programmatic Use**Block Parameter:** low**Type:** character vector**Values:** real scalar**Default:** '0'**High — Upper limit of slider range** 2 (default) | real value

Specify the upper limit of the slider range.

Programmatic Use**Block Parameter:** high**Type:** character vector**Values:** real scalar**Default:** '2'**Block Characteristics**

| | |
|---------------------------------|---|
| Data Types | Boolean double fixed point integer single |
| Direct Feedthrough | no |
| Multidimensional Signals | yes |
| Variable-Size Signals | yes |
| Zero-Crossing Detection | no |

Extended Capabilities**C/C++ Code Generation**

Generate C and C++ code using Simulink® Coder™.

PLC Code Generation

Generate Structured Text code using Simulink® PLC Coder™.

Fixed-Point Conversion

Design and simulate fixed-point systems using Fixed-Point Designer™.

See Also

Gain

Introduced before R2006a

Spectrum Analyzer

Display frequency spectrum

Library: DSP System Toolbox / Sinks
 DSP System Toolbox HDL Support / Sinks



Description

The Spectrum Analyzer block, referred to here as the scope, displays the frequency spectra of signals.

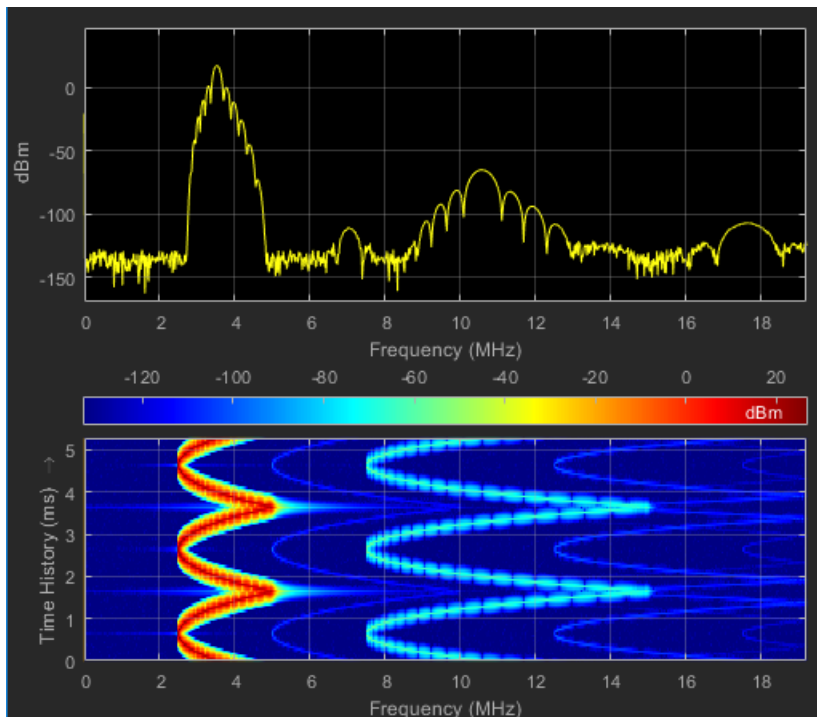

You can use the Spectrum Analyzer block in models running in Normal or Accelerator simulation modes. You can also use the Spectrum Analyzer block in models running in Rapid Accelerator or External simulation modes, with some limitations.

You can use the Spectrum Analyzer block inside all subsystems and conditional subsystems. Conditional subsystems include enabled subsystems, triggered subsystems, enabled and triggered subsystems, and function-call subsystems. See “Conditionally Executed Subsystems Overview” for more information.

Measurements

- Cursors (DSP System Toolbox) — Measure signal values using vertical and horizontal cursors.

- Peak Finder (DSP System Toolbox) — Find maxima, showing the x-axis values at which they occur.
- Channel Measurements (DSP System Toolbox) — Measure the occupied bandwidth or adjacent channel power ratio (ACPR).
- Distortion Measurements (DSP System Toolbox) — Measure harmonic distortion and intermodulation distortion.
- CCDF Measurements (DSP System Toolbox) — Measure the complimentary cumulative distribution function. CCDF measurements show the probability of a signal's instantaneous power being a specified level above the signal's average power.
- "Spectral Masks" (DSP System Toolbox) — Visualize spectrum limits and compare spectrum values to specification values.

Programmatic Control

You can configure and display Spectrum Analyzer settings from the command line with the `SpectrumAnalyzerConfiguration` object.

Ports

Input

Port_1 — Signals to visualize

scalar | vector | matrix | array

Connect the signals you want to visualize. You can have up to 96 input ports. Input signals can have these characteristics:

- **Signal Domain** — Frequency or time signals
- **Type** — Discrete (sample-based and frame-based).
- **Data type** — Any data type that Simulink supports. See "Data Types Supported by Simulink".
- **Dimension** — One dimensional (vector), two dimensional (matrix), or multidimensional (array). Input must have fixed number of channels. See "Signal Dimensions" and "Determine Signal Dimensions".

Data Types: single | double | int8 | int16 | int32 | int64 | uint8 | uint16 | uint32 | uint64 | fixed point

Parameters

Spectrum Settings

The **Spectrum Settings** pane appears at the right side of the Spectrum Analyzer window. These settings control how the spectrum is calculated. To show the Spectrum Settings, in the Spectrum

Analyzer menu, select **View > Spectrum Settings** or use the  button in the toolbar.

Main options

Input domain — Domain of the input signal

Time (default) | Frequency

The domain of the input signal you want to visualize. If you visualize time-domain signals, the signal is transformed to the frequency spectrum based on the algorithm specified by the `Method` parameter.

Programmatic Use

See `InputDomain`.

Type — Type of spectrum to display

`Power` (default) | `Power density` | `RMS`

`Power` — Spectrum Analyzer shows the power spectrum.

`Power density` — Spectrum Analyzer shows the power spectral density. The power spectral density is the magnitude of the spectrum normalized to a bandwidth of 1 hertz.

`RMS` — Spectrum Analyzer shows the root mean squared spectrum.

Tunable: Yes

Programmatic Use

See `SpectrumType`.

View — Spectrum view

`Spectrum` (default) | `Spectrogram` | `Spectrum and spectrogram`

`Spectrum` — Spectrum Analyzer shows the spectrum.

`Spectrogram` — Spectrum Analyzer shows the spectrogram, which displays frequency content over time. The most recent spectrogram update is at the bottom of the display, and time scrolls from the bottom to the top of the display.

`Spectrum and spectrogram` — Spectrum Analyzer shows both the spectrum and spectrogram.

Tunable: Yes

Programmatic Use

See `ViewType`.

Sample rate — Sample rate of the input signal in hertz

`Inherited` (default) | positive scalar

Sample rate of the input signal in hertz, specified as either

- `Inherited` to use the same sample rate as the input signal.
- Positive scalar. The specified sample rate must be at least twice the input signal sample rate. Otherwise, you might see unexpected behavior in your signal visualization due to aliasing.

Programmatic Use

See `SampleRate`.

Method — Spectrum estimation method

`Filter Bank` (default) | `Welch`

Select `Welch` or `Filter Bank` as the spectrum estimation method. For more details about the two spectrum estimation algorithms, see “Algorithms” (DSP System Toolbox).

Tunable: No

Dependency

To use this parameter, set “Input domain” (DSP System Toolbox) to Time.

Programmatic Use

See Method.

Full frequency span — Use entire Nyquist frequency interval

on (default) | off

Select this check box to compute and plot the spectrum over the entire “Nyquist frequency interval” (DSP System Toolbox).

Tunable: Yes

Dependency

To use this parameter, set “Input domain” (DSP System Toolbox) to Time.

Programmatic Use

See FrequencySpan.

Span (Hz) — Frequency span in hertz

10e3 (default) | real positive scalar

Specify the frequency span in hertz. Use this parameter with the CF (Hz) parameter to define the frequency span around a center frequency. This parameter defines the range of values shown on the Frequency axis in the Spectrum Analyzer window.

Tunable: Yes

Dependencies

To use this parameter, you must:

- Set “Input domain” (DSP System Toolbox) to Time.
- Clear the “Full frequency span” (DSP System Toolbox) check box.
- Set the **Span (Hz)/Fstart (Hz)** drop-down to Span (Hz).

Programmatic Use

See FrequencySpan and Span.

CF (Hz) — Center frequency in hertz

0 (default) | scalar

Specify the center frequency, in hertz. Use this parameter with the “Span (Hz)” (DSP System Toolbox) parameter to define the frequency span around a center frequency. This parameter defines the value shown at the middle point of the Frequency axis on the Spectrum Analyzer window.

Tunable: Yes

Dependencies

To use this parameter, you must:

- Set “Input domain” (DSP System Toolbox) to **Time**.
- Clear the “Full frequency span” (DSP System Toolbox) check box.
- Set the **Span (Hz)/Fstart (Hz)** drop-down to “Span (Hz)” (DSP System Toolbox).

Programmatic Use

See CenterFrequency.

FStart (Hz) — Start frequency in hertz

-5e3 (default) | scalar

Specify the start frequency in hertz. Use this parameter with the “FStop (Hz)” (DSP System Toolbox) parameter to define the range of frequency-axis values using start frequency and stop frequency. This parameter defines the value shown at the leftmost side of the Frequency axis on the Spectrum Analyzer window.

Tunable: Yes

Dependencies

To use this parameter, you must:

- Set “Input domain” (DSP System Toolbox) to **Time**.
- Clear the “Full frequency span” (DSP System Toolbox) check box.
- Set the **Span (Hz)/FStart (Hz)** drop-down to **FStart (Hz)**.

Programmatic Use

See StartFrequency.

FStop (Hz) — Stop frequency in hertz

5e3 (default) | scalar

Specify the stop frequency, in hertz. Use this parameter with the “FStart (Hz)” (DSP System Toolbox) parameter to define the range of Frequency axis values. This parameter defines the value shown at the rightmost side of the Frequency axis on the Spectrum Analyzer window.

Tunable: Yes

Dependencies

To use this parameter, you must:

- Set “Input domain” (DSP System Toolbox) to **Time**.
- Clear the “Full frequency span” (DSP System Toolbox) check box.
- Set the **Span (Hz)/FStart (Hz)** drop-down to “FStart (Hz)” (DSP System Toolbox).

Programmatic Use

See StopFrequency.

Frequency (Hz) — Frequency vector

Auto (default) | Input port | monotonically increasing vector

Set the frequency vector which determines the x-axis of the display.

- **Auto** — The frequency vector is calculated from the length of the input. See “Frequency Vector” (DSP System Toolbox).
- **Input port** — When selected, an input port appears on the block for the frequency vector input.
- **Custom vector** — Enter a custom vector as the frequency vector. The length of the custom vector must be equal to the frame size of the input signal.

Tunable: No

Dependency

To use this parameter, set “Input domain” (DSP System Toolbox) to Frequency.

Programmatic Use

See FrequencyVector.

RBW (Hz) — Resolution bandwidth

Auto (default) | Input port | positive scalar

The resolution bandwidth in hertz. This parameter defines the smallest positive frequency that can be resolved. By default, this parameter is set to **Auto**. In this case, the Spectrum Analyzer determines the appropriate value to ensure that there are 1024 RBW intervals over the specified frequency span.

If you set this parameter to a numeric value, the value must allow at least two RBW intervals over the specified frequency span. In other words, the ratio of the overall frequency span to RBW must be greater than two:

$$\frac{span}{RBW} > 2$$

For frequency input only, you can use an input port to set the RBW value.

Tunable: Yes

Dependency

To use this parameter, set either:

- “Input domain” (DSP System Toolbox) to Time and the **RBW (Hz)/Window length/Number of frequency bands** drop-down to RBW (Hz).
- “Input domain” (DSP System Toolbox) to Frequency.

Programmatic Use

See RBW.

Input units — Units of frequency input

Auto (default) | dBm | dBV | dBW | Vrms | Watts

Select the units of the frequency-domain input. This property allows the Spectrum Analyzer to scale frequency data if you choose a different display unit with the “Units” (DSP System Toolbox) property.

Tunable: No

Dependency

This option is only available when “Input domain” (DSP System Toolbox) is set to Frequency.

Programmatic Use

See InputUnits.

Window length — Length of window in samples

1024 (default) | integer greater than 2

The length of the window, in samples. The window length used to control the frequency resolution and compute the spectral estimates. The window length must be an integer greater than 2.

Dependencies

To use this parameter, set:

- “Method” (DSP System Toolbox) to Welch
- Set the **RBW (Hz)/Window length/Number of frequency bands** drop-down to Window Length

Dependency

To use this parameter, set “Input domain” (DSP System Toolbox) to Time.

Programmatic Use

See WindowLength.

Number of frequency bands — FFT length

Auto (default) | positive integer

Specify the fast Fourier transform (FFT) length to control the number of frequency bands. If the value is Auto, the Spectrum Analyzer uses the entire frame size to estimate the spectrum. If you specify the number of frequency bands, you set the input buffer size.

Dependencies

To use this parameter, set:

- “Method” (DSP System Toolbox) to Filter Bank
- Set the **RBW (Hz)/Window length/Number of frequency bands** drop-down to Number of frequency bands

Programmatic Use

See FFTLength

Taps per band — Number of filter taps

12 (default) | positive even integer

Specify the number of filter taps or coefficients for each frequency band. This number must be a positive even integer. This value corresponds to the number of filter coefficients per polyphase branch. The total number of filter coefficients is equal to *Taps Per Band + FFT Length*.

Dependency

To use this parameter, you must set the **RBW (Hz)/Window length/Number of frequency bands** drop-down to “Number of frequency bands” (DSP System Toolbox).

Programmatic Use

See NumTapsPerBand.

NFFT — Number of FFT points

Auto (default) | positive integer

Specify the length of the FFT that Spectrum Analyzer uses to compute spectral estimates. Acceptable options are **Auto** or a positive integer.

The **NFFT** value must be greater than or equal to the value of the **Window length** parameter. By default, when **NFFT** is set to **Auto**, the Spectrum Analyzer sets **NFFT** equal to the value of **Window length**. When in RBW mode, the specified RBW value is used to calculate an FFT length that equals the window length.

When this parameter is set to a positive integer, this parameter is equivalent to the *n* parameter of the `fft` function.

Dependencies

To use this parameter, you must set the **RBW (Hz)/Window length/Number of frequency bands** drop-down to “Window length” (DSP System Toolbox).

Programmatic Use

See `FFTLenght`.

Samples/update — Required number of input samples

positive scalar

This property is read-only.

The number of input samples required to compute one spectral update. You cannot modify this parameter; it is shown in the spectrum analyzer for informational purposes only. This parameter is directly related to **RBW (Hz)/Window length/Number of frequency bands**. For more details, see “Algorithms” (DSP System Toolbox).

If the input does not have enough samples to achieve the resolution bandwidth that you specify, Spectrum Analyzer produces a message on the display.

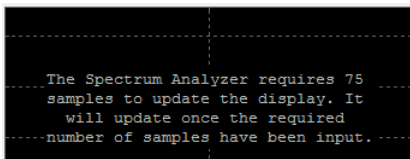
**Spectrogram Settings****Channel — Spectrogram channel**

channel name

Select the signal channel for which the spectrogram settings apply.

Dependencies

To use this option, set “View” (DSP System Toolbox) to `Spectrogram` or `Spectrum` and `spectrogram`.

Programmatic Use

See `SpectrogramChannel`.

Time res. (s) – Time resolution in seconds

Auto (default) | positive number

Time resolution is the amount of data, in seconds, used to compute a spectrogram line. The minimum attainable resolution is the amount of time it takes to compute a single spectral estimate. The tooltip displays the minimum attainable resolution given the current settings.

The time resolution value is determined based on frequency resolution method, the RBW setting, and the time resolution setting.

| Method | Frequency Resolution Method | Frequency Resolution Setting | Time Resolution Setting | Resulting Time Resolution in Seconds |
|----------------------|-----------------------------|------------------------------|-------------------------|--|
| Welch or Filter Bank | RBW (Hz) | Auto | Auto | 1/RBW |
| Welch or Filter Bank | RBW (Hz) | Auto | Manually entered | Time Resolution |
| Welch or Filter Bank | RBW (Hz) | Manually entered | Auto | 1/RBW |
| Welch or Filter Bank | RBW (Hz) | Manually entered | Manually entered | Must be equal to or greater than the minimum attainable time resolution, 1/RBW. Several spectral estimates are combined into one spectrogram line to obtain the desired time resolution. Interpolation is used to obtain time resolution values that are not integer multiples of 1/RBW. |
| Welch | Window length | — | Auto | 1/RBW |
| Welch | Window length | — | Manually entered | Must be equal to or greater than the minimum attainable time resolution. Several spectral estimates are combined into one spectrogram line to obtain the desired time resolution. Interpolation is used to obtain time resolution values that are not integer multiples of 1/RBW. |

| Method | Frequency Resolution Method | Frequency Resolution Setting | Time Resolution Setting | Resulting Time Resolution in Seconds |
|-------------|-----------------------------|------------------------------|-------------------------|---|
| Filter Bank | Number of frequency bands | — | Auto | 1/RBW |
| Filter Bank | Number of frequency bands | — | Manually entered | Must be equal to or greater than the minimum attainable time resolution, 1/RBW. |

Tunable: Yes

Dependency

To use this option, set “View” (DSP System Toolbox) to Spectrogram or Spectrum and spectrogram.

Programmatic Use

See TimeResolution.

Time span — Time span in seconds

Auto (default) | positive scalar

The time span over which the Spectrum Analyzer displays the spectrogram specified in seconds. The time span is the product of the desired number of spectral lines and the time resolution. The tooltip displays the minimum allowable time span, given the current settings. If the time span is set to Auto, 100 spectral lines are used.

Tunable: Yes

Dependency

To use this option, set “View” (DSP System Toolbox) to Spectrogram or Spectrum and spectrogram.

Programmatic Use

See TimeSpan.

Window Options

Overlap (%) — Segment overlap percentage

0 (default) | scalar between 0 and 100

This parameter defines the amount of overlap between the previous and current buffered data segments. The overlap creates a window segment that is used to compute a spectral estimate. The value must be greater than or equal to zero and less than 100.

Tunable: Yes

Programmatic Use

See OverlapPercent.

Window — Windowing method

Hann (default) | Rectangular | Blackman-Harris | Chebyshev | Flat Top | Hamming | Kaiser | custom window function name

The windowing method to apply to the spectrum. Windowing is used to control the effect of sidelobes in spectral estimation. The window you specify affects the window length required to achieve a resolution bandwidth and the required number of samples per update. For more information about windowing, see “Windows” (Signal Processing Toolbox).

Tunable: Yes

Programmatic Use

See Window.

Attenuation — Sidelobe attenuation

60 (default) | scalar greater than or equal to 45

The sidelobe attenuation in decibels (dB). The value must be greater than or equal to 45.

Dependency

This parameter applies only when you set the **Window** parameter to Chebyshev or Kaiser.

Programmatic Use

See SidelobeAttenuation.

NENBW — Normalized effective noise bandwidth

scalar

This property is read-only.

The normalized effective noise bandwidth of the window. You cannot modify this parameter; it is shown for informational purposes only. This parameter is a measure of the noise performance of the window. The value is the width of a rectangular filter that accumulates the same noise power with the same peak power gain.

The rectangular window has the smallest NENBW, with a value of 1. All other windows have a larger NENBW value. For example, the Hann window has an NENBW value of approximately 1.5.

Trace Options**Units — Spectrum units**

dBm (default) | dBW | Watts | Vrms | dBV | dBFS

The units of the spectrum. The available values depend on the value of the “Type” (DSP System Toolbox) parameter.

Tunable: Yes

Programmatic Use

See SpectrumUnits.

Full scale — Full scale for dBFS units

Auto (default) | positive real scalar

The full scale used for the decibel full scale (dBFS) units. By default, the Spectrum Analyzer uses the entire spectrum scale. Specify a positive real scalar for the dBFS full scale.

Tunable: Yes

Dependencies

To enable this parameter, set:

- “Input domain” (DSP System Toolbox) to Time
- “Units” on page 1-0 to dBFS

Programmatic Use

See FullScale.

Averaging method — Smoothing method

Exponential (default) | Running

Specify the smoothing method as:

- Exponential — Weighted average of samples. Use the Forgetting factor property to specify the weighted forgetting factor.
- Running — Running average of the last n samples. Use the Averages property to specify n .

For more information about the averaging methods, see “Averaging Method” on page 1-1685.

Programmatic Use

See AveragingMethod.

Averages — Number of spectral averages

1 (default) | positive integer

Specify the number of spectral averages as a positive integer. The spectrum analyzer computes the current power spectrum estimate by computing a running average of the last N power spectrum estimates. This parameter defines the number of spectral averages, N .

Dependencies

This parameter applies only when:

- **View** is Spectrum or Spectrum and spectrogram.
- **Averaging method** is Running.

Programmatic Use

See SpectralAverages.

Forgetting factor — Weighting forgetting factor

0.9 (default) | scalar in the range (0,1]

Specify the exponential weighting as a scalar value greater than 0 and less than or equal to 1.

Dependency

This parameter applies only when the **Averaging method** is Exponential.

Programmatic Use

See ForgettingFactor.

Reference load — Reference load

1 (default) | positive real scalar

The reference load in ohms that the Spectrum Analyzer uses as a reference to compute power values.

Programmatic Use

See ReferenceLoad.

Scale — Scale of frequency axis

Linear (default) | Logarithmic

Choose a linear or logarithm scale for the frequency axis. When the frequency span contains negative frequency values, you cannot choose the logarithmic option.

Programmatic Use

See FrequencyScale.

Offset — Constant frequency offset

0 (default) | scalar

The constant frequency offset to apply to the entire spectrum, or a vector of frequencies to apply to each spectrum for multiple inputs. The offset parameter is added to the values on the Frequency axis in the Spectrum Analyzer window. This parameter is not used in any spectral computations. You must take the parameter into consideration when you set the **Span (Hz)** and **CF (Hz)** parameters to ensure that the frequency span is within the “Nyquist frequency interval” (DSP System Toolbox).

Dependency

To use this parameter, set “Input domain” (DSP System Toolbox) to Time.

Programmatic Use

See FrequencyOffset.

Normal trace — Normal trace view

on (default) | off

When this check box is selected, the Spectrum Analyzer calculates and plots the power spectrum or power spectrum density. Spectrum Analyzer performs a smoothing operation by averaging several spectral estimates.

Dependencies

To clear this check box, you must first select either the “Max hold trace” (DSP System Toolbox) or the “Min hold trace” (DSP System Toolbox) parameter. This parameter applies only when “View” (DSP System Toolbox) is Spectrum or Spectrum and spectrogram.

Programmatic Use

See PlotNormalTrace.

Max hold trace — Maximum hold trace view

off (default) | on

Select this check box to enable Spectrum Analyzer to plot the maximum spectral values of all the estimates obtained.

Dependency

This parameter applies only when “View” (DSP System Toolbox) is **Spectrum** or **Spectrum and spectrogram**.

Programmatic Use

See `PlotMaxHoldTrace`.

Min hold trace — Minimum hold trace view

off (default) | on

Select this check box to enable Spectrum Analyzer to plot the minimum spectral values of all the estimates obtained.

Dependency

This parameter applies only when “View” (DSP System Toolbox) is **Spectrum** or **Spectrum and spectrogram**.

Programmatic Use

See `PlotMinHoldTrace`.

Two-sided spectrum — Enable two-sided spectrum view

off (default) | on

Select this check box to enable a two-sided spectrum view. In this view, both negative and positive frequencies are shown. If you clear this check box, Spectrum Analyzer shows a one-sided spectrum with only positive frequencies. Spectrum Analyzer requires that this parameter is selected when the input signal is complex-valued.

Programmatic Use

See `PlotAsTwoSidedSpectrum`.

Configuration Properties

The **Configuration Properties** dialog box controls visual aspects of the Spectrum Analyzer. To open the Configuration Properties, in the Spectrum Analyzer menu, select **View > Configuration**

Properties or select the  button in the toolbar drop-down.

Title — Display title

character vector | string

Specify the display title. Enter `%<SignalLabel>` to use the signal labels in the Simulink model as the axes titles.

Tunable: Yes

Programmatic Use

See Title.

Show Legend — Display signal legend

off (default) | on

Show signal legend. The names listed in the legend are the signal names from the model. For signals with multiple channels, a channel index is appended after the signal name. Continuous signals have straight lines before their names and discrete signals have step-shaped lines.

From the legend, you can control which signals are visible. This control is equivalent to changing the visibility in the **Style** parameters. In the scope legend, click a signal name to hide the signal in the scope. To show the signal, click the signal name again. To show only one signal, right-click the signal name, which hides all other signals. To show all signals, press **ESC**.

Note The legend only shows the first 20 signals. Any additional signals cannot be viewed or controlled from the legend.

Dependency

To enable this parameter, set “View” (DSP System Toolbox) to Spectrum or Spectrum and spectrogram.

Programmatic Use

See ShowLegend.

Show grid — Show internal grid lines

on (default) | off

Show internal grid lines on the Spectrum Analyzer

Programmatic Use

See ShowGrid.

Y-limits (minimum) — Y-axis minimum

-80 (default) | scalar

Specify the minimum value of the y-axis.

Programmatic Use

See YLimits.

Y-limits (maximum) — Y-axis maximum

20 (default) | scalar

Specify the maximum value of the y-axis.

Programmatic Use

See YLimits.

Y-label — Y-axis label

character vector | string

To display signal units, add (%<SignalUnits>) to the label. At the beginning of a simulation, Simulink replaces (%<SignalUnits>) with the units associated with the signals. For example, if you have a signal for velocity with units of m/s enter

Velocity (%<SignalUnits>)

Programmatic Use

See YLabel.

Color map — Spectrogram colormap

jet(256) (default) | hot(256) | bone(256) | cool(256) | copper(256) | gray(256) | parula(256) | 3-column matrix

Select the colormap for the spectrogram, or enter a three-column matrix expression for the colormap. For more information about colormaps, see colormap.

Tunable: Yes**Dependency**

To use this parameter, set “View” (DSP System Toolbox) to Spectrogram or Spectrum and spectrogram.

Color-limits (minimum) — Spectrogram minimum

-80 (default) | scalar

Specify the signal power for the minimum color value of the spectrogram.

Tunable: Yes**Dependency**

To use this parameter, set “View” (DSP System Toolbox) to Spectrogram or Spectrum and spectrogram.

Programmatic Use

See ColorLimits.

Color-limits (maximum) — Spectrogram maximum

20 (default) | scalar

Specify the signal power for the maximum color value of the spectrogram.

Tunable: Yes**Dependency**

To use this parameter, set “View” (DSP System Toolbox) to Spectrogram or Spectrum and spectrogram.

Programmatic Use

See ColorLimits.

Style

The **Style** dialog box controls how the Spectrum Analyzer appears. To open the Style properties, in the Spectrum Analyzer menu, select **View > Style** or select the  button in the toolbar drop-down.

Figure color – Window background

gray (default) | color picker

Specify the color that you want to apply to the background of the scope figure.

Plot type – Plot type

Line (default) | Stem

Specify whether to display a Line or Stem plot.

Programmatic Use

See PlotType.

Axes colors – Axes background color

black (default) | color picker

Specify the color that you want to apply to the background of the axes.

Properties for line – Channel for visual property settings

channel names

Specify the channel for which you want to modify the visibility, line properties, and marker properties.

Visible – Channel visibility

on (default) | off

Specify whether the selected channel is visible. If you clear this check box, the line disappears. You can also change signal visibility using the scope legend.

Line – Line style

line, 0.5, yellow (default)

Specify the line style, line width, and line color for the selected channel.

Marker – Data point markers

none (default)

Specify marks for the selected channel to show at its data points. This parameter is similar to the 'Marker' property for plots. You can choose any of the marker symbols from the drop-down.

Axes Scaling

The **Axes Scaling** dialog box controls the axes limits of the Spectrum Analyzer. To open the Axes Scaling properties, in the Spectrum Analyzer menu, select **Tools > Axes Scaling > Axes Scaling Properties**.

Axes scaling/Color scaling – Automatic axes scaling

Auto (default) | Manual | After N Updates

Specify when the scope automatically scales the y-axis. If the spectrogram is displayed, specify when the scope automatically scales the color axis. By default, this parameter is set to **Auto**, and the scope does not shrink the y-axis limits when scaling the axes or color. You can select one of the following options:

- **Auto** — The scope scales the axes or color as needed, both during and after simulation. Selecting this option shows the **Do not allow Y-axis limits to shrink** or **Do not allow color limits to shrink**.
- **Manual** — When you select this option, the scope does not automatically scale the axes or color. You can manually scale the axes or color in any of the following ways:
 - Select **Tools > Scaling Properties**.
 - Press one of the **Scale Axis Limits** toolbar buttons.
 - When the scope figure is the active window, press **Ctrl+A**.
- **After N Updates** — Selecting this option causes the scope to scale the axes or color after a specified number of updates. This option is useful, and most efficient, when your frequency signal values quickly reach steady-state after a short period. Selecting this option shows the **Number of updates** edit box where you can modify the number of updates to wait before scaling.

Tunable: Yes

Programmatic Use

See `AxesScaling`.

Do not allow Y-axis/color limits to shrink — Axes scaling limits

on (default) | off

When you select this parameter, the y-axis is allowed to grow during axes scaling operations. If the spectrogram is displayed, selecting this parameter allows the color limits to grow during axis scaling. If you clear this check box, the y-axis or color limits can shrink during axes scaling operations.

Dependency

This parameter appears only when you select **Auto** for the **Axis scaling** or **Color scaling** parameter. When you set the **Axis scaling** or **Color scaling** parameter to **Manual** or **After N Updates**, the y-axis or color limits can shrink.

Number of updates — Number of updates before scaling

10 (default) | positive number

The number of updates after which the axes scale, specified as a positive integer. If the spectrogram is displayed, this parameter specifies the number of updates after which the color axes scales.

Tunable: Yes

Dependency

This parameter appears only when you set “Axes scaling/Color scaling” (DSP System Toolbox) to **After N Updates**.

Programmatic Use

See `AxesScalingNumUpdates`.

Scale limits at stop — Scale axes at stop

off (default) | on

Select this check box to scale the axes when the simulation stops. If the spectrogram is displayed, select this check box to scale the color when the simulation stops. The y-axis is always scaled. The x-axis limits are only scaled if you also select the **Scale X-axis limits** check box.

Data range (%) — Percent of axes

100 (default) | number in the range [1,100]

Set the percentage of the axis that the scope uses to display the data when scaling the axes. If the spectrogram is displayed, set the percentage of the power values range within the colormap. Valid values are from 1 through 100. For example, if you set this parameter to 100, the scope scales the axis limits such that your data uses the entire axis range. If you then set this parameter to 30, the scope increases the y-axis or color range such that your data uses only 30% of the axis range.

Tunable: Yes**Align — Alignment along axes**

Center (default) | Bottom | Top | Left | Right

Specify where the scope aligns your data along the axis when it scales the axes. If the spectrogram is displayed, specify where the scope aligns your data along the axis when it scales the color. If you are using CCDF Measurements (DSP System Toolbox), the x axis is also configurable.

Tunable: Yes**Block Characteristics**

| | |
|---------------------------------|--|
| Data Types | Boolean double enumerated fixed point integer single |
| Direct Feedthrough | no |
| Multidimensional Signals | yes |
| Variable-Size Signals | yes |
| Zero-Crossing Detection | no |

Algorithms**Spectrum Estimation — Welch's Method**

When you choose the Welch method, the power spectrum estimate is averaged modified periodograms.

Given the signal input, x , the Spectrum Analyzer does the following:

- 1 Multiplies x by the given window and scales the result by the window power. The Spectrum Analyzer uses the RBW or the Window Length setting in the **Spectrum Settings** pane to determine the data window length.
- 2 Computes the FFT of the signal, Y , and takes the square magnitude using $Z = Y \cdot \text{conj}(Y)$.

- 3 Computes the current power spectrum estimate by taking the moving average of the last N number of Z 's, and scales the answer by the sample rate. For details on the moving average methods, see "Averaging Method" on page 1-1685.

Spectrum Analyzer requires that a minimum number of samples to compute a spectral estimate. This number of input samples required to compute one spectral update is shown as **Samples/update** in the **Main options** pane. This value is directly related to resolution bandwidth, RBW , by the following equation, or to the window length, by the equation shown in step 2.

$$N_{samples} = \frac{\left(1 - \frac{O_p}{100}\right) \times NENBW \times F_s}{RBW}$$

The normalized effective noise bandwidth, $NENBW$, is a factor that depends on the windowing method. Spectrum Analyzer shows the value of $NENBW$ in the **Window Options** pane of the **Spectrum Settings** pane. Overlap percentage, O_p , is the value of the **Overlap %** parameter in the **Window Options** pane of the **Spectrum Settings** pane. F_s is the sample rate of the input signal. Spectrum Analyzer shows sample rate in the **Main Options** pane of the **Spectrum Settings** pane.

- 1 When in **RBW (Hz)** mode, the window length required to compute one spectral update, N_{window} , is directly related to the resolution bandwidth and normalized effective noise bandwidth:

$$N_{window} = \frac{NENBW \times F_s}{RBW}$$

When in **Window Length** mode, the window length is used as specified.

- 2 The number of input samples required to compute one spectral update, $N_{samples}$, is directly related to the window length and the amount of overlap by the following equation.

$$N_{samples} = \left(1 - \frac{O_p}{100}\right) N_{window}$$

When you increase the overlap percentage, fewer new input samples are needed to compute a new spectral update. For example, if the window length is 100, then the number of input samples required to compute one spectral update is given as shown in the following table.

| O_p | $N_{samples}$ |
|-------|---------------|
| 0% | 100 |
| 50% | 50 |
| 80% | 20 |

- 3 The normalized effective noise bandwidth, $NENBW$, is a window parameter determined by the window length, N_{window} , and the type of window used. If $w(n)$ denotes the vector of N_{window} window coefficients, then $NENBW$ is given by the following equation.

$$NENBW = N_{window} \times \frac{\sum_{n=1}^{N_{window}} w^2(n)}{\left[\sum_{n=1}^{N_{window}} w(n)\right]^2}$$

- 4 When in **RBW (Hz)** mode, you can set the resolution bandwidth using the value of the **RBW (Hz)** parameter on the **Main options** pane of the **Spectrum Settings** pane. You must specify a

value to ensure that there are at least two RBW intervals over the specified frequency span. The ratio of the overall span to RBW must be greater than two:

$$\frac{span}{RBW} > 2$$

By default, the **RBW (Hz)** parameter on the **Main options** pane is set to Auto. In this case, the Spectrum Analyzer determines the appropriate value to ensure that there are 1024 RBW intervals over the specified frequency span. When you set **RBW (Hz)** to Auto, *RBW* is calculated as:

$$RBW_{auto} = \frac{span}{1024}$$

- 5 When in **Window Length** mode, you specify N_{window} and the resulting *RBW* is:

$$\frac{NENBW \times F_s}{N_{window}}$$

Sometimes, the number of input samples provided are not sufficient to achieve the resolution bandwidth that you specify. When this situation occurs, Spectrum Analyzer displays a message:

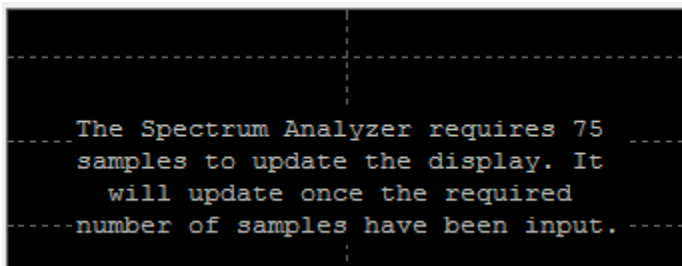

Spectrum Analyzer removes this message and displays a spectral estimate when enough data has been input.

Note The number of FFT points (N_{fft}) is independent of the window length (N_{window}). You can set them to different values if N_{fft} is greater than or equal to N_{window} .

Nyquist frequency interval

When the `PlotAsTwoSidedSpectrum` property is set to `true`, the interval is

$$\left[-\frac{SampleRate}{2}, \frac{SampleRate}{2} \right] + FrequencyOffset \text{ hertz.}$$

When the `PlotAsTwoSidedSpectrum` property is set to `false`, the interval is

$$\left[0, \frac{SampleRate}{2} \right] + FrequencyOffset \text{ hertz.}$$

Periodogram and Spectrogram

Spectrum Analyzer calculates and plots the power spectrum, power spectrum density, and RMS computed by the modified Periodogram estimator. For more information about the Periodogram method, see `periodogram`.

Power Spectral Density — The power spectral density (PSD) is given by the following equation.

$$\text{PSD}(f) = \frac{1}{P} \sum_{p=1}^P \frac{\left| \sum_{n=1}^{N_{FFT}} x^p[n] e^{-j2\pi f(n-1)T} \right|^2}{F_s \times \sum_{n=1}^{N_{window}} w^2[n]}$$

In this equation, $x[n]$ is the discrete input signal. On every input signal frame, Spectrum Analyzer generates as many overlapping windows as possible, with each window denoted as $x^{(p)}[n]$, and computes their periodograms. Spectrum Analyzer displays a running average of the P most current periodograms.

Power Spectrum — The power spectrum is the product of the power spectral density and the resolution bandwidth, as given by the following equation.

$$P_{\text{spectrum}}(f) = \text{PSD}(f) \times \text{RBW} = \text{PSD}(f) \times \frac{F_s \times \text{NENBW}}{N_{\text{window}}} = \frac{1}{P} \sum_{p=1}^P \frac{\left| \sum_{n=1}^{N_{FFT}} x^p[n] e^{-j2\pi f(n-1)T} \right|^2}{\left[\sum_{n=1}^{N_{\text{window}}} w[n] \right]^2}$$

Frequency Vector

When set to Auto, the frequency vector for frequency-domain input is calculated by the software.

When the PlotAsTwoSidedSpectrum property is set to true, the frequency vector is:

$$\left[-\frac{\text{SampleRate}}{2}, \frac{\text{SampleRate}}{2} \right]$$

When the PlotAsTwoSidedSpectrum property is set to false, the frequency vector is:

$$\left[0, \frac{\text{SampleRate}}{2} \right]$$

Occupied BW

The *Occupied BW* is calculated as follows.

- 1 Calculate the total power in the measured frequency range.
- 2 Determine the lower frequency value. Starting at the lowest frequency in the range and moving upward, the power distributed in each frequency is summed until this result is

$$\frac{100 - \text{OccupiedBW}\%}{2}$$

of the total power.

- 3 Determine the upper frequency value. Starting at the highest frequency in the range and moving downward, the power distributed in each frequency is summed until the result reaches

$$\frac{100 - \text{OccupiedBW}\%}{2}$$

of the total power.

- 4 The bandwidth between the lower and upper power frequency values is the occupied bandwidth.
- 5 The frequency halfway between the lower and upper frequency values is the center frequency.

Distortion Measurements

The *Distortion Measurements* are computed as follows.

- 1 Spectral content is estimated by finding peaks in the spectrum. When the algorithm detects a peak, it records the width of the peak and clears all monotonically decreasing values. That is, the algorithm treats all these values as if they belong to the peak. Using this method, all spectral content centered at DC (0 Hz) is removed from the spectrum and the amount of bandwidth cleared (W_0) is recorded.
- 2 The fundamental power (P_1) is determined from the remaining maximum value of the displayed spectrum. A local estimate (Fe_1) of the fundamental frequency is made by computing the central moment of the power near the peak. The bandwidth of the fundamental power content (W_1) is recorded. Then, the power from the fundamental is removed as in step 1.
- 3 The power and width of the higher-order harmonics (P_2, W_2, P_3, W_3 , etc.) are determined in succession by examining the frequencies closest to the appropriate multiple of the local estimate (Fe_1). Any spectral content that decreases monotonically about the harmonic frequency is removed from the spectrum first before proceeding to the next harmonic.
- 4 Once the DC, fundamental, and harmonic content is removed from the spectrum, the power of the remaining spectrum is examined for its sum ($P_{remaining}$), peak value ($P_{maxspur}$), and median value ($P_{estnoise}$).
- 5 The sum of all the removed bandwidth is computed as $W_{sum} = W_0 + W_1 + W_2 + \dots + W_n$.

The sum of powers of the second and higher-order harmonics are computed as $P_{harmonic} = P_2 + P_3 + P_4 + \dots + P_n$.

- 6 The sum of the noise power is estimated as:

$$P_{noise} = (P_{remaining} \cdot dF + P_{est.noise} \cdot W_{sum}) / RBW$$

Where dF is the absolute difference between frequency bins, and RBW is the resolution bandwidth of the window.

- 7 The metrics for SNR, THD, SINAD, and SFDR are then computed from the estimates.

$$THD = 10 \cdot \log_{10} \left(\frac{P_{harmonic}}{P_1} \right)$$

$$SINAD = 10 \cdot \log_{10} \left(\frac{P_1}{P_{harmonic} + P_{noise}} \right)$$

$$SNR = 10 \cdot \log_{10} \left(\frac{P_1}{P_{noise}} \right)$$

$$SFDR = 10 \cdot \log_{10} \left(\frac{P_1}{\max(P_{maxspur}, \max(P_2, P_3, \dots, P_n))} \right)$$

Harmonic Measurements

- 1 The harmonic distortion measurements use the spectrum trace shown in the display as the input to the measurements. The default Hann window setting of the Spectrum Analyzer may exhibit leakage that can completely mask the noise floor of the measured signal.

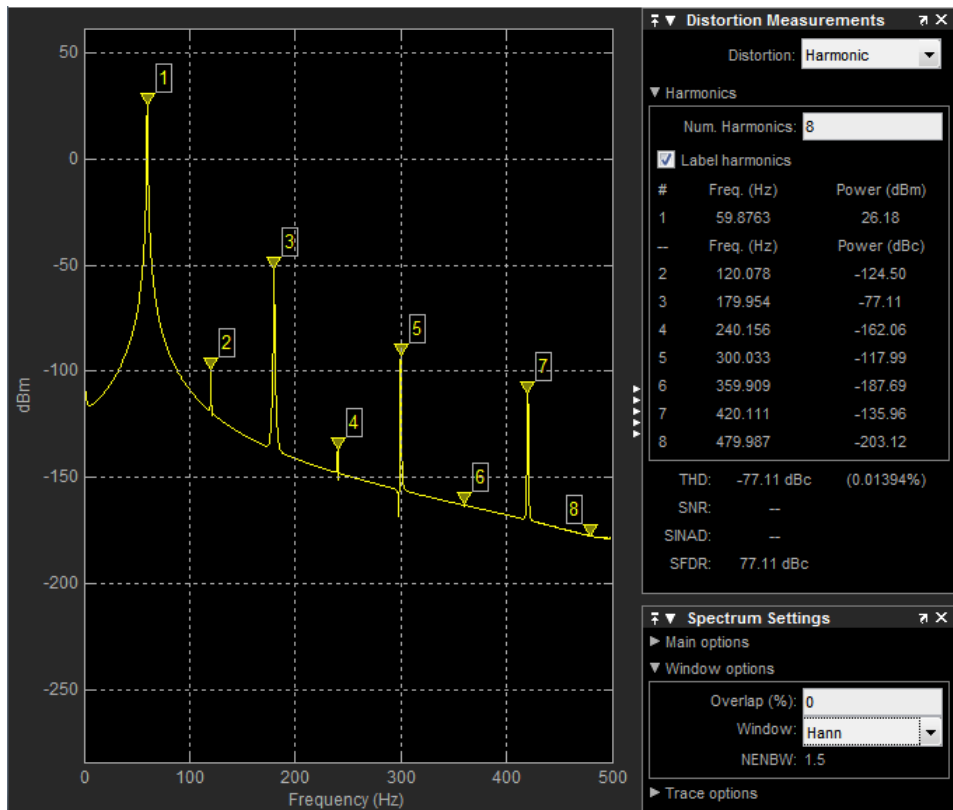

The harmonic measurements attempt to correct for leakage by ignoring all frequency content that decreases monotonically away from the maximum of harmonic peaks. If the window leakage covers more than 70% of the frequency bandwidth in your spectrum, you may see a blank reading (-) reported for **SNR** and **SINAD**. If your application can tolerate the increased equivalent noise bandwidth (ENBW), consider using a Kaiser window with a high attenuation (up to 330 dB) to minimize spectral leakage.

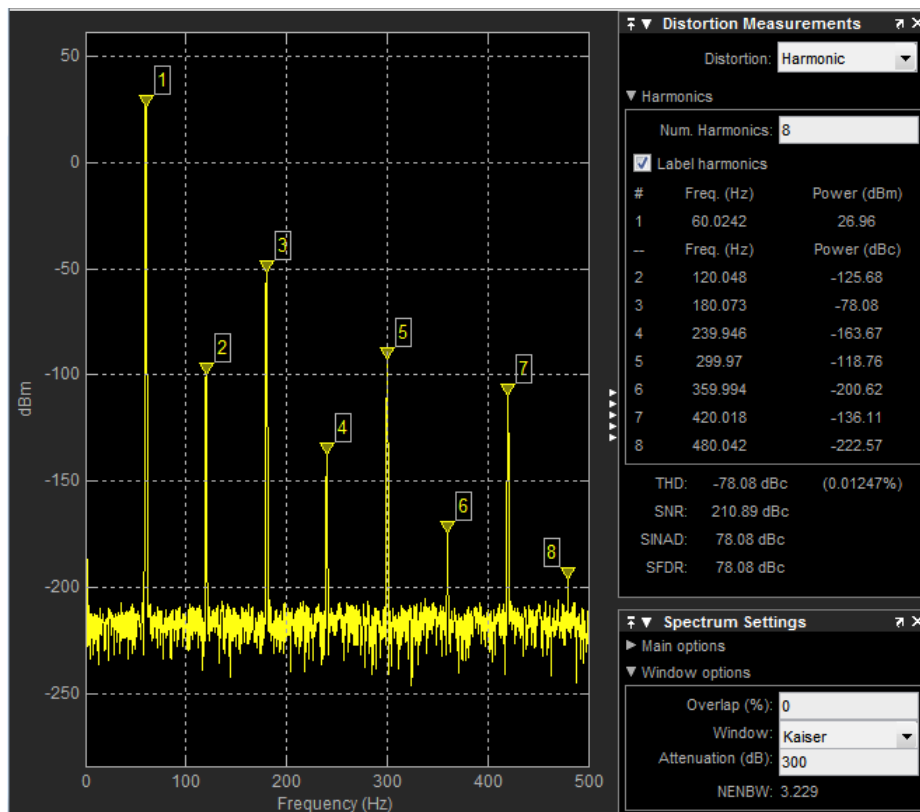

- 2 The DC component is ignored.
- 3 After windowing, the width of each harmonic component masks the noise power in the neighborhood of the fundamental frequency and harmonics. To estimate the noise power in each region, Spectrum Analyzer computes the median noise level in the nonharmonic areas of the spectrum. It then extrapolates that value into each region.
- 4 N^{th} order intermodulation products occur at $A*F1 + B*F2$,
where $F1$ and $F2$ are the sinusoid input frequencies and $|A| + |B| = N$. A and B are integer values.
- 5 For intermodulation measurements, the third-order intercept (TOI) point is computed as follows, where P is power in decibels of the measured power referenced to 1 milliwatt (dBm):

- $TOI_{lower} = P_{F1} + (P_{F2} - P_{(2F1-F2)})/2$
- $TOI_{upper} = P_{F2} + (P_{F1} - P_{(2F2-F1)})/2$
- $TOI = (TOI_{lower} + TOI_{upper})/2$

Averaging Method

The moving average is calculated using one of the two methods:

- Running — For each frame of input, average the last N -scaled Z vectors, which are computed by the algorithm. The variable N is the value you specify for the number of spectral averages. If the algorithm does not have enough Z vectors, the algorithm uses zeros to fill the empty elements.

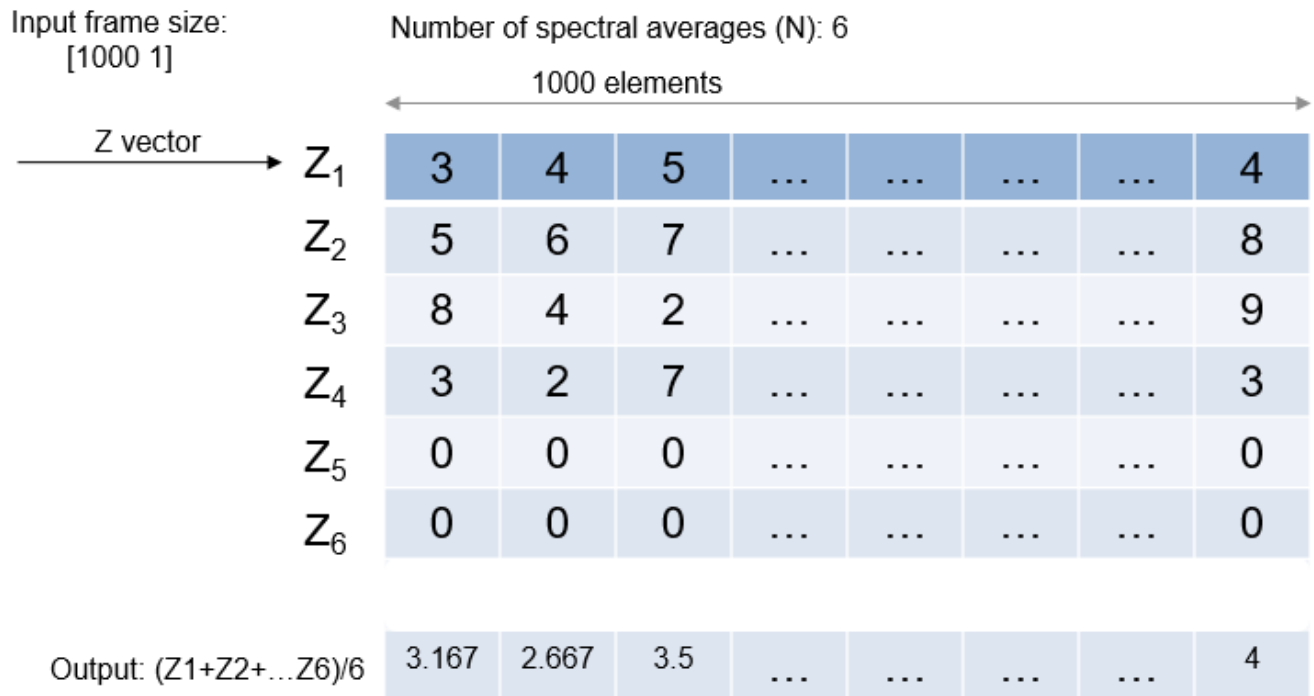

- **Exponential** – The moving average algorithm using the exponential weighting method updates the weights and computes the moving average recursively for each Z vector that comes in by using the following recursive equations:

$$w_N = \lambda w_{N-1} + 1$$

$$\bar{z}_N = \left(1 - \frac{1}{w_N}\right)\bar{z}_{N-1} + \left(\frac{1}{w_N}\right)z_N$$

- λ – Forgetting factor
- w_N – Weighting factor applied to the current Z vector
- z_N – Current Z vector
- \bar{z}_{N-1} – Moving average until the previous Z vector
- $\left(1 - \frac{1}{w_N}\right)\bar{z}_{N-1}$ – Effect of the previous Z vectors on the average
- \bar{z}_N – Moving average including the current Z vector

Extended Capabilities

C/C++ Code Generation

Generate C and C++ code using Simulink® Coder™.

This block can be used for simulation visibility in systems that generate code, but is not included in the generated code.

HDL Code Generation

Generate Verilog and VHDL code for FPGA and ASIC designs using HDL Coder™.

This block can be used for simulation visibility in subsystems that generate HDL code, but is not included in the hardware implementation.

PLC Code Generation

Generate Structured Text code using Simulink® PLC Coder™.

This block can be used for simulation visibility in systems that generate PLC code, but is not included in the generated code.

Fixed-Point Conversion

Design and simulate fixed-point systems using Fixed-Point Designer™.

This block accepts fixed-point input, but converts it to `double` for display.

See Also**Objects**

`SpectrumAnalyzerConfiguration` | `dsp.SpectrumAnalyzer`

Functions

`getSpectralMaskStatus` | `getSpectrumData` | `getMeasurementsData`

Blocks

Time Scope | Array Plot

Topics

“Display Frequency-Domain Data in Spectrum Analyzer” (DSP System Toolbox)

“Spectral Analysis” (DSP System Toolbox)

“Display Frequency-Domain Data in Spectrum Analyzer” (DSP System Toolbox)

Introduced in R2014b

Slider Switch

Change parameter or variable value using switch with customizable appearance

Library: Simulink / Dashboard / Customizable Blocks

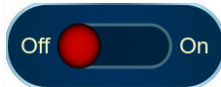

Description

Use the Slider Switch block to change the value of the connected variable or parameter before or during simulation. When you use the Slider Switch block in the Customizable Blocks library, you can customize the appearance of the block to look like a real switch in your system, and you can configure the switch with any number of states to customize the behavior. For example, you could design a three-way toggle switch or a switch that represents a gear shift. Use the Slider Switch block with other dashboard blocks to create an interactive dashboard for your model.

Double-clicking the Slider Switch block does not open its dialog box during simulation or when the block is selected. To edit the block parameters, you can use the Property Inspector or open the block dialog box by:

- Double-clicking the block when the block is not selected and the model is not simulating.
- Right-clicking the block and selecting **Block Parameters** from the context menu.

Customize Slider Switch Blocks

When you add a Slider Switch block to your model, the block is preconfigured with a default design. You can use the block with the default design or customize the appearance of the block. When you design a switch using the Slider Switch block, you can add any number of states to the block. For each state, you can:

- Add an image that defines the appearance of the block in that state.
- Specify the value for the block to assign to the connected variable or parameter.
- Specify the label text, color, and position for the state and whether the label is visible on the block design.
- Configure the size and position of the click area for the state. When you click the click area for a state, the block transitions to that state.

You can also design the block background and foreground, which apply for all states. To configure the foreground for the block, upload a foreground image. To configure the background for the block, you can upload a background image or use a solid background color.

To customize the appearance of the block, use design mode. You can enter design mode in one of three ways after selecting the block:

- On the **Button** tab, under **Design**, click **Edit**.
- In the **Property Inspector**, on the **Design** tab, click **Edit Design**.
- Pause on the ellipsis that appears above the block and click the **Edit Custom Block** button.

Design mode gives you access to block parameters and settings that allow you to customize the appearance of the block. You can use the toolbar above the block to configure the image, the icon,

and the label color and opacity for each state. For more customization options, use the **Design** tab in the Property Inspector.

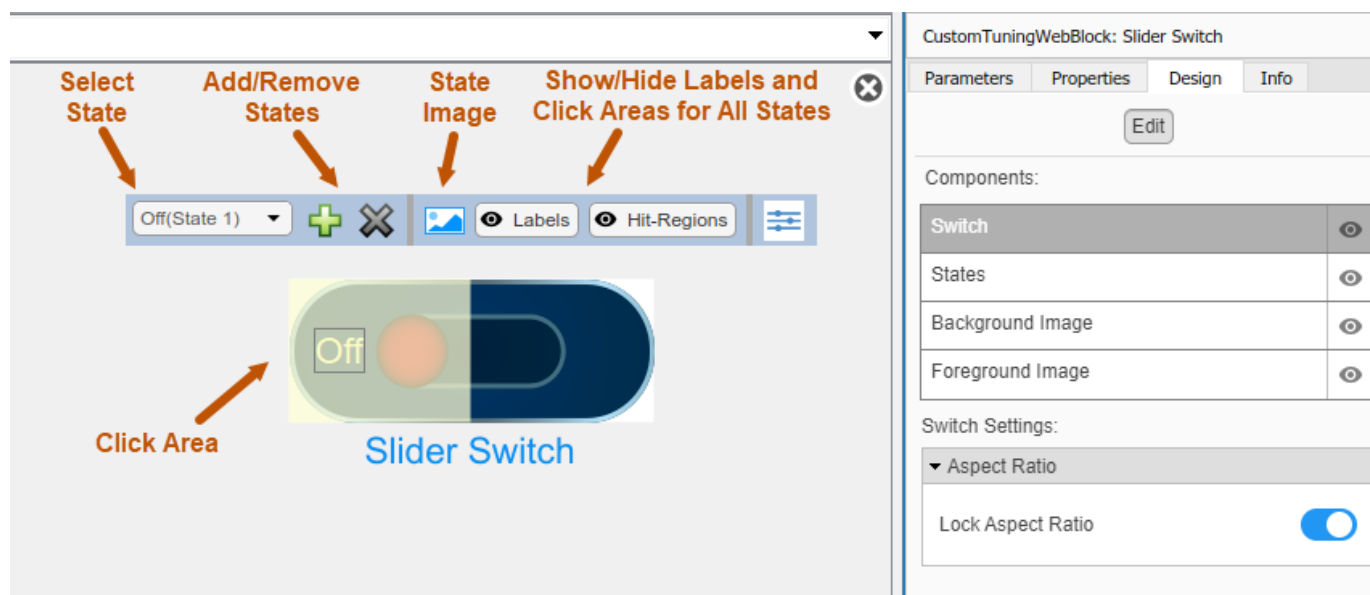

When you finish designing the switch, click **Exit** in the upper-right of the canvas to exit design mode.

Connect Dashboard Blocks

Dashboard blocks do not use ports to connect to model elements. To connect dashboard blocks to variables and block parameters, use connect mode. Connect mode facilitates the process of connecting dashboard blocks in your model, especially when you want to connect multiple blocks at once. To connect a single dashboard block, you can also use the **Connection** table in the block dialog box.

Tip You can modify dashboard block connections in your model during normal and accelerator mode simulations.

Note Dashboard blocks cannot connect to variables until you update the model diagram. To connect dashboard blocks to variables or modify variable values between opening your model and running a simulation, update the model diagram using **Ctrl+D**.

To enter connect mode, select the block. Then, on the block tab, click **Connect**. In connect mode, when you select one or more blocks, a list of parameters and variables available for connection appears. Select a variable or parameter from the list to connect to the selected dashboard block.

When the value of the selected variable or block parameter is nonscalar, use the text box at the bottom of the **Connection** table to specify the element you want to connect to the dashboard block. To connect to an element of a vector, matrix, or array, specify the element index, for example, 3 or (1, 3). To connect to an element in a bus or structure, specify the element in the context of the bus or structure hierarchy by using dots to indicate different levels in the hierarchy, and omit the top level. For example, specify a.b to connect to scalar element b of the structure or bus a nested inside the selected composite variable or parameter.

To connect another dashboard block, pause on another dashboard block and click the **Connect** button above it. Then, make a selection of signals and blocks in your model and choose a model element to connect.

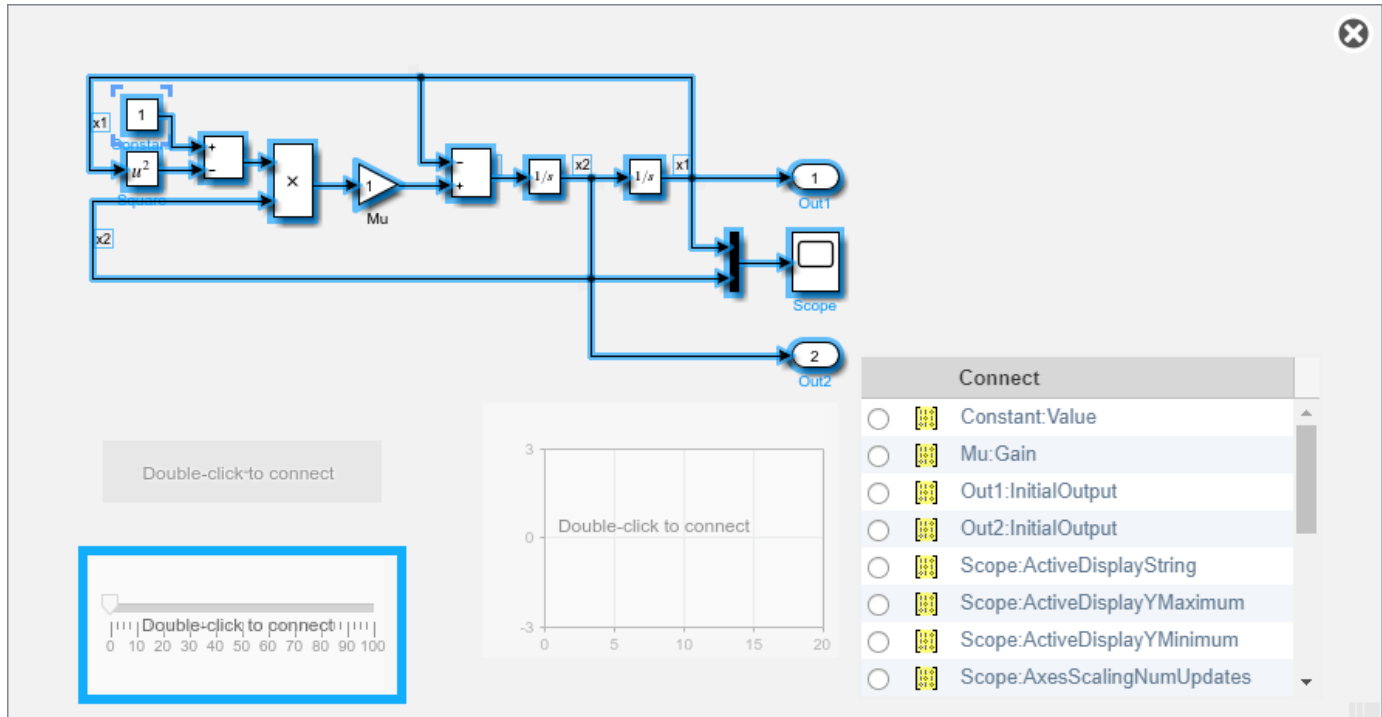

When you finish connecting the dashboard blocks in your model, on the block tab, click **Done Connecting**.

Tip You can hide the message shown on unconnected blocks using the `set_param` function with the `ShowInitialText` block parameter. The message also disappears when you connect the block.

Parameter Logging

Tunable parameters connected to dashboard blocks are logged to the Simulation Data Inspector, where you can view the parameter values along with logged signal data. You can access logged parameter data in the MATLAB workspace by exporting the parameter data from the Simulation Data Inspector by using the UI or the `Simulink.sdi.exportRun` function. For more information about exporting data using the Simulation Data Inspector UI, see “Export Data to the Workspace or a File”. The parameter data is stored in a `Simulink.SimulationData.Parameter` object, accessible as an element in the exported `Simulink.SimulationData.Dataset`.

Limitations

- Except for the Dashboard Scope block and the Display block, dashboard blocks can only connect to real scalar signals.
- The toolstrip does not support blocks that are inside a panel.
- You cannot use the **Connection** table in the block dialog to connect a dashboard block to a block that is commented out. When you connect a dashboard block to a commented block using connect

mode, the dashboard block does not display the connected value until the you uncomment the block.

- Dashboard blocks cannot connect to model elements inside referenced models.
- When you simulate a model hierarchy, dashboard blocks inside referenced models do not update.
- Dashboard blocks do not support rapid accelerator simulation.
- When you connect a dashboard block to a variable or parameter during simulation, the data for that variable or parameter is not logged to the Simulation Data Inspector. To log variable and parameter data to the Simulation Data Inspector, connect the dashboard block to the variable or parameter prior to simulation.
- When you simulate a model in external mode with the **Default parameter behavior** set to **Inlined**, dashboard blocks can appear to change parameter and variable values. However, the change does not propagate to the simulation. For example, Gain blocks display changes made to the **Gain** parameter using the dashboard blocks, but the **Gain** value used in the simulation does not change.

Parameters

Connection — Select a variable or block parameter to connect

variable and parameter connection options

Select the variable or block parameter to control using the **Connection** table. To connect the block to a signal:

- 1 Make a selection in the model that includes one or more blocks.
- 2 Select the variable or parameter you want to connect.

When the value of the selected variable or block parameter is nonscalar, use the text box at the bottom of the **Connection** table to specify the element you want to connect to the dashboard block. To connect to an element of a vector, matrix, or array, specify the element index, for example, 3 or (1, 3). To connect to an element in a bus or structure, specify the element in the context of the bus or structure hierarchy by using dots to indicate different levels in the hierarchy, and omit the top level. For example, specify a.b to connect to scalar element b of the structure or bus a nested inside the selected composite variable or parameter.

- 3 Click **Apply**.

To facilitate understanding and debugging your model, you can connect Dashboard blocks to variables and parameters in your model during simulation.

Note To see workspace variables in the connection table, update the model diagram using **Ctrl+D**.

Programmatic Use

To programmatically connect a dashboard block to a tunable parameter or a variable, use a `Simulink.HMI.ParamSourceInfo` object. The `Simulink.HMI.ParamSourceInfo` object contains four properties. Some of the properties apply to connecting dashboard blocks to parameters, and some apply to connecting dashboard blocks to variables. Not all fields have a value for a connection because a given dashboard block connects to either a parameter or a variable.

Block Parameter: Binding

Type: Simulink.HMI.ParamSourceInfo

Default: []

States — Block state labels and values

scalar and character vector

Each state pairs a **State Value** with a **State Label**. When the block is in a given state, it assigns the **State Value** for that state to the connected variable or parameter. You can use the **State Label** to display the value assigned to the connected variable or parameter on the block or to provide a descriptive text label. Using the **Design** tab in the Property Inspector, you can choose to show or hide the specified **State Label** in the block design.

By default, the switch has two states:

- In the Off state, the block assigns the connected variable or parameter a value of 0.
- In the On state, the block assigns the connected variable or parameter a value of 1.

You can use a customizable switch block to design a block with any number of states. Click the + button to add a state.

Tips

You can also configure the states for the block in design mode, by using the toolbar above the block or the **Design** tab in the Property Inspector.

Label — Block label position

Top (default) | Bottom | Hide

Position of the block label. When the block is connected to an element in the model, the label is the name of the connected element.

Programmatic Use

Block Parameter: LabelPosition

Type: character vector

Values: 'Top' | 'Bottom' | 'Hide'

Default: 'Top'

Block Characteristics

| | |
|---------------------------------|----------------------------------|
| Data Types | double half integer single |
| Direct Feedthrough | no |
| Multidimensional Signals | no |
| Variable-Size Signals | no |
| Zero-Crossing Detection | no |

Tips

- When you want to design a circular switch that distributes the state labels and the click areas that cause state transitions on an arc, consider using the Rotary Switch block.

- To design a control that applies values to a connected variable or parameter from a continuous range, use the Knob, Horizontal Slider, or Vertical Slider blocks.

Extended Capabilities

C/C++ Code Generation

Generate C and C++ code using Simulink® Coder™.

Dashboard blocks are ignored for code generation.

See Also

Rocker Switch | Toggle Switch

Introduced in R2021b

Slider Switch

Toggle parameter between two values

Library: Simulink / Dashboard



Description

The Slider Switch block toggles the value of the connected block parameter between two values during simulation. For example, you can connect the Slider Switch block to a Switch block in your model and change its state during simulation. Use the Slider Switch block with other Dashboard blocks to create an interactive dashboard for your model.

Double-clicking the Slider Switch block does not open its dialog box during simulation and when the block is selected. To edit the block's parameters, you can use the **Property Inspector**, or you can right-click the block and select **Block Parameters** from the context menu.

Connect Dashboard Blocks

Dashboard blocks do not use ports to connect to model elements. To connect dashboard blocks to variables and block parameters, use connect mode. Connect mode facilitates the process of connecting dashboard blocks in your model, especially when you want to connect multiple blocks at once. To connect a single dashboard block, you can also use the **Connection** table in the block dialog box.

Tip You can modify dashboard block connections in your model during normal and accelerator mode simulations.

Note Dashboard blocks cannot connect to variables until you update the model diagram. To connect dashboard blocks to variables or modify variable values between opening your model and running a simulation, update the model diagram using **Ctrl+D**.

To enter connect mode, select the block. Then, on the block tab, click **Connect**. In connect mode, when you select one or more blocks, a list of parameters and variables available for connection appears. Select a variable or parameter from the list to connect to the selected dashboard block.

When the value of the selected variable or block parameter is nonscalar, use the text box at the bottom of the **Connection** table to specify the element you want to connect to the dashboard block. To connect to an element of a vector, matrix, or array, specify the element index, for example, 3 or (1, 3). To connect to an element in a bus or structure, specify the element in the context of the bus or structure hierarchy by using dots to indicate different levels in the hierarchy, and omit the top level. For example, specify a.b to connect to scalar element b of the structure or bus a nested inside the selected composite variable or parameter.

To connect another dashboard block, pause on another dashboard block and click the **Connect** button above it. Then, make a selection of signals and blocks in your model and choose a model element to connect.

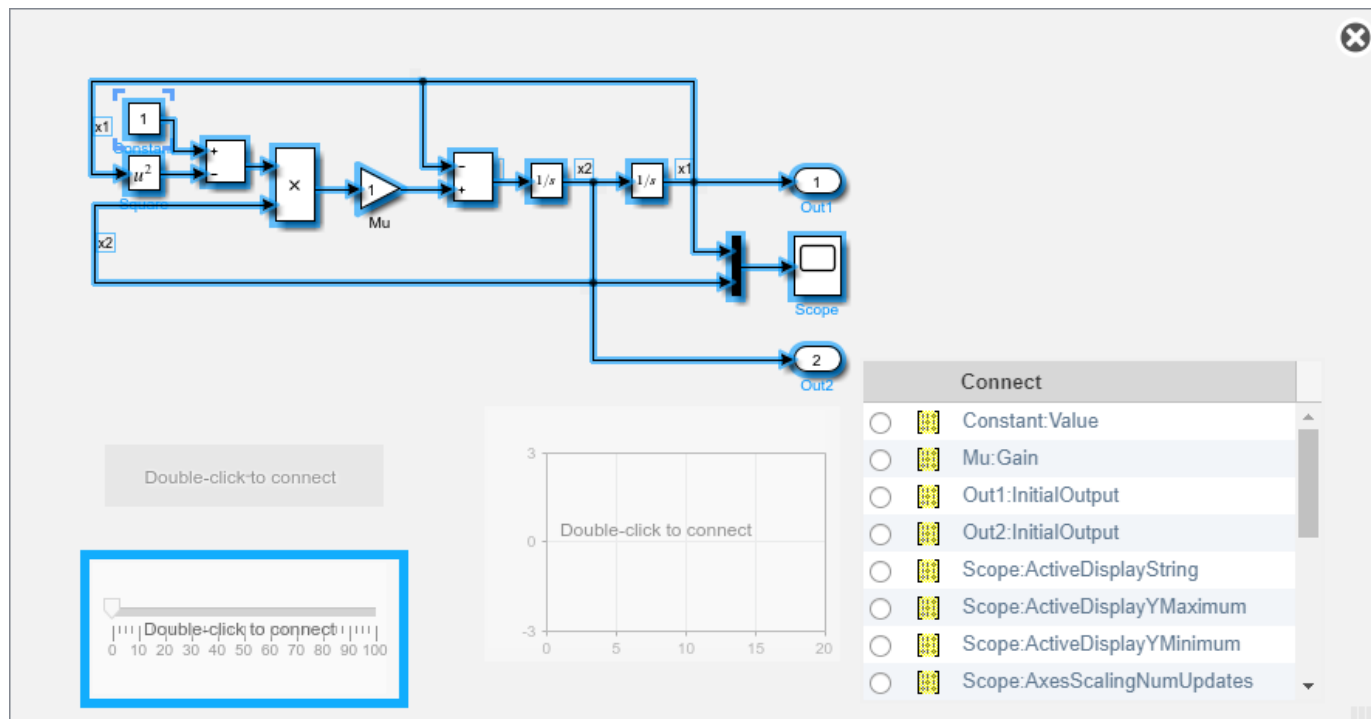

When you finish connecting the dashboard blocks in your model, on the block tab, click **Done Connecting**.

Tip You can hide the message shown on unconnected blocks using the `set_param` function with the `ShowInitialText` block parameter. The message also disappears when you connect the block.

Parameter Logging

Tunable parameters connected to dashboard blocks are logged to the Simulation Data Inspector, where you can view the parameter values along with logged signal data. You can access logged parameter data in the MATLAB workspace by exporting the parameter data from the Simulation Data Inspector by using the UI or the `Simulink.sdi.exportRun` function. For more information about exporting data using the Simulation Data Inspector UI, see "Export Data to the Workspace or a File". The parameter data is stored in a `Simulink.SimulationData.Parameter` object, accessible as an element in the exported `Simulink.SimulationData.Dataset`.

Limitations

- Except for the Dashboard Scope block and the Display block, dashboard blocks can only connect to real scalar signals.
- The toolstrip does not support blocks that are inside a panel.
- You cannot use the **Connection** table in the block dialog to connect a dashboard block to a block that is commented out. When you connect a dashboard block to a commented block using connect

mode, the dashboard block does not display the connected value until the you uncomment the block.

- Dashboard blocks cannot connect to model elements inside referenced models.
- When you simulate a model hierarchy, dashboard blocks inside referenced models do not update.
- Dashboard blocks do not support rapid accelerator simulation.
- When you connect a dashboard block to a variable or parameter during simulation, the data for that variable or parameter is not logged to the Simulation Data Inspector. To log variable and parameter data to the Simulation Data Inspector, connect the dashboard block to the variable or parameter prior to simulation.
- When you simulate a model in external mode with the **Default parameter behavior** set to **Inlined**, dashboard blocks can appear to change parameter and variable values. However, the change does not propagate to the simulation. For example, Gain blocks display changes made to the **Gain** parameter using the dashboard blocks, but the **Gain** value used in the simulation does not change.

Parameters

Connection — Select a variable or block parameter to connect

variable and parameter connection options

Select the variable or block parameter to control using the **Connection** table. To connect the block to a signal:

- 1 Make a selection in the model that includes one or more blocks.
- 2 Select the variable or parameter you want to connect.

When the value of the selected variable or block parameter is nonscalar, use the text box at the bottom of the **Connection** table to specify the element you want to connect to the dashboard block. To connect to an element of a vector, matrix, or array, specify the element index, for example, 3 or (1, 3). To connect to an element in a bus or structure, specify the element in the context of the bus or structure hierarchy by using dots to indicate different levels in the hierarchy, and omit the top level. For example, specify a.b to connect to scalar element b of the structure or bus a nested inside the selected composite variable or parameter.

- 3 Click **Apply**.

To facilitate understanding and debugging your model, you can connect Dashboard blocks to variables and parameters in your model during simulation.

Note To see workspace variables in the connection table, update the model diagram using **Ctrl+D**.

Programmatic Use

To programmatically connect a dashboard block to a tunable parameter or a variable, use a `Simulink.HMI.ParamSourceInfo` object. The `Simulink.HMI.ParamSourceInfo` object contains four properties. Some of the properties apply to connecting dashboard blocks to parameters, and some apply to connecting dashboard blocks to variables. Not all fields have a value for a connection because a given dashboard block connects to either a parameter or a variable.

Block Parameter: Binding

Type: Simulink.HMI.ParamSourceInfo

Default: []

States — Pair values and labels

scalar and character vector

Pairs of values to assign to the connected variable or parameter and text to display on the block. Switches have two states — **Left** and **Right** — one corresponding to each switch position. Each state contains a **Value** and a **Label**.

- **Value** — Value to assign to the connected variable or parameter when the switch is in the corresponding position.
- **Label** — Text to display on the block for the corresponding position.

This table describes the default configuration for the block.

States

| Position | State Value | State Label |
|--------------|-------------|-------------|
| Left | 0 | on |
| Right | 1 | off |

Programmatic Use

To configure the **States** for the block programmatically, specify the value of the **States** parameter as a structure array containing two elements with fields:

- **Value** — Scalar double value for the state.
- **Label** — String or character array to use as the label for the switch position.

```
leftState.Value = 0;
leftState.Label = 'Off';
rightState.Value = 1;
rightState.Label = 'On';
switchStates = [leftState rightState];
```

Block Parameter: States

Type: two element array of structures

Label — Block label position

Top (default) | Bottom | Hide

Position of the block label. When the block is connected to an element in the model, the label is the name of the connected element.

Programmatic Use

Block Parameter: LabelPosition

Type: character vector

Values: 'Top' | 'Bottom' | 'Hide'

Default: 'Top'

Block Characteristics

| | |
|---------------------------------|----------------------------------|
| Data Types | double half integer single |
| Direct Feedthrough | no |
| Multidimensional Signals | no |
| Variable-Size Signals | no |
| Zero-Crossing Detection | no |

Extended Capabilities

C/C++ Code Generation

Generate C and C++ code using Simulink® Coder™.

Dashboard blocks are ignored for code generation.

See Also

Rocker Switch | Toggle Switch | Rotary Switch

Topics

“Tune and Visualize Your Model with Dashboard Blocks”

“Decide How to Visualize Simulation Data”

Introduced in R2015a

Sqrt

Calculate square root, signed square root, or reciprocal of square root

Library: Simulink / Math Operations
HDL Coder / HDL Floating Point Operations
HDL Coder / Math Operations



Description

The Sqrt block calculates the square root, signed square root, or reciprocal of square root on the input signal. Select one of the following functions from the **Function** parameter list.

| Function | Description | Mathematical Expression | MATLAB Equivalent |
|------------|---|------------------------------|-------------------|
| sqrt | Square root of the input | $u^{0.5}$ | sqrt |
| signedSqrt | Square root of the absolute value of the input, multiplied by the sign of the input | $\text{sign}(u) * u ^{0.5}$ | — |
| rSqrt | Reciprocal of the square root of the input | $u^{-0.5}$ | — |

The block icon changes to match the function.

Ports

Input

Port_1 — Input signal

scalar | vector | matrix

Input signal to the block to calculate the square root, signed square root, or reciprocal of square root. The sqrt function accepts real or complex inputs, except for complex fixed-point signals. signedSqrt and rSqrt do not accept complex inputs. The input signal must be a floating point number.

This table summarizes the support for complex types and negative values for floating point, integer, and fixed-point data types for sqrt, rSqrt, and signedSqrt functions.

| Function | Data Type | Complex | | Negative Values |
|----------|-------------------------|---------|--------|-----------------|
| | | Input | Output | |
| sqrt | Floating point | Yes | Yes | Yes |
| | Integer and fixed-point | No | No | No |

| Function | Data Type | Complex | | Negative Values |
|------------|-------------------------|---------|--------|-----------------|
| | | Input | Output | |
| rSqrt | Floating point | No | No | Yes |
| | Integer and fixed-point | No | No | No |
| signedSqrt | Floating point | No | Yes | Yes |
| | Integer and fixed-point | No | No | No |

If the input is negative, set the **Output signal** to complex for all functions except signedSqrt.

Data Types: single | double | half | int8 | int16 | int32 | int64 | uint8 | uint16 | uint32 | uint64 | fixed point

Output

Port_1 — Output signal

scalar | vector | matrix

Output signal that is the square root, signed square root, or reciprocal of square root of the input signal. When the input is an integer or fixed-point type, the output must be floating point.

Data Types: single | double | half | int8 | int16 | int32 | int64 | uint8 | uint16 | uint32 | uint64 | fixed point



Parameters

Main

Function — Function the block performs

sqrt (default) | signedSqrt | rSqrt

Specify the mathematical function that the block calculates. The block icon changes to match the function you select.

| Function | Block Icon |
|------------|---|
| sqrt |  |
| signedSqrt |  |
| rSqrt |  |

Dependency

When this parameter is set to signedSqrt, the **Intermediate results data type** parameter is disabled.

Programmatic Use**Block Parameter:** Operator**Type:** character vector**Values:** 'sqrt' | 'signedSqrt' | 'rSqrt'**Default:** 'sqrt'**Output signal type — Output signal type**

auto (default) | real | complex

Specify the output signal type of the block.

| Function | Input Signal Type | Output Signal Type | | |
|------------|-------------------|--|--|---------|
| | | Auto | Real | Complex |
| sqrt | real | real for nonnegative inputs NaN for negative inputs | real for nonnegative inputs NaN for negative inputs | complex |
| | complex | complex | error | complex |
| signedSqrt | real | real | real | complex |
| | complex | error | error | error |
| rSqrt | real | real | real | error |
| | complex | error | error | error |

Programmatic Use**Block Parameter:** OutputSignalType**Type:** character vector**Values:** 'auto' | 'real' | 'complex'**Default:** 'auto'**Sample time — Specify sample time as a value other than -1**

-1 (default) | scalar | vector

Specify the sample time as a value other than -1. For more information, see “Specify Sample Time”.

Dependencies

This parameter is not visible unless it is explicitly set to a value other than -1. To learn more, see “Blocks for Which Sample Time Is Not Recommended”.

Programmatic Use**Block Parameter:** SampleTime**Type:** character vector**Values:** scalar or vector**Default:** '-1'**Algorithm****Method — Method to compute reciprocal of square root**

Exact (default) | Newton-Raphson

Specify the method for computing the reciprocal of a square root. This parameter is only valid for the rSqrt function.

| Method | Data Types Supported | When to Use This Method |
|----------------|---|--|
| Exact | Floating point | You do not want an approximation. Note The input or output must be floating point. |
| Newton-Raphson | Floating-point, fixed-point, and built-in integer types | You want a fast, approximate calculation. |

The Exact method provides results that are consistent with MATLAB computations.

Note The algorithms for `sqrt` and `signedSqrt` are always of Exact type, no matter what selection appears on the block dialog box.

Programmatic Use

Block Parameter: AlgorithmType

Type: character vector

Values: 'Exact' | 'Newton-Raphson'

Default: 'Exact'

Number of iterations — Number of iterations used for Newton Raphson algorithm

3 (default) | integer

Specify the number of iterations to perform the Newton-Raphson algorithm. This parameter is valid with the `rSqrt` function and the Newton-Raphson value for **Method**.

Note If you enter 0, the block output is the initial guess of the Newton-Raphson algorithm.

Programmatic Use

Block Parameter: Iterations

Type: character vector

Values: integer

Default: '3'

Data Types

Click the **Show data type assistant** button  to display the **Data Type Assistant**, which helps you set the data type attributes. For more information, see “Specify Data Types Using Data Type Assistant”.

Intermediate results data type — Data type of intermediate results

Inherit: Inherit via internal rule (default) | Inherit: Inherit from input | Inherit: Inherit from output | double | single | int8 | uint8 | int16 | uint16 | int32 | uint32 | int64 | uint64 | fixdt(1,16,,0) | fixdt(1,16,2^0,0) | <data type expression>

Specify the data type for intermediate results when you set **Function** to `sqrt` or `rSqrt` on the **Main** pane.

The type can be inherited, specified directly, or expressed as a data type object such as `Simulink.NumericType`.

Note To avoid overflow, the intermediate data type must be larger than or equal to a data type that can contain the square of the output data type.

Follow these guidelines on setting an intermediate data type explicitly for the square root function, `sqrt`:

| Input and Output Data Types | Intermediate Data Type |
|---|------------------------|
| Input or output is double. | Use double. |
| Input or output is single, and any non-single data type is <i>not</i> double. | Use single or double. |
| Input and output are fixed point. | Use fixed point. |

Follow these guidelines on setting an intermediate data type explicitly for the reciprocal square root function, `rSqrt`:

| Input and Output Data Types | Intermediate Data Type |
|---|------------------------|
| Input is double and output is not single. | Use double. |
| Input is not single and output is double. | Use double. |
| Input and output are fixed point. | Use fixed point. |

Caution Do not set **Intermediate results data type** to `Inherit:Inherit` from output when:

- You select Newton-Raphson to compute the reciprocal of a square root.
- The input data type is floating point.
- The output data type is fixed point.

Under these conditions, selecting `Inherit:Inherit` from output yields suboptimal performance and produces an error.

To avoid this error, convert the input signal from a floating-point to fixed-point data type. For example, insert a Data Type Conversion block in front of the `Sqrt` block to perform the conversion.

Dependencies

This parameter is disabled when the **Function** parameter is set to `signedSqrt`.

Programmatic Use

Block Parameter: `IntermediateResultsDataTypeStr`

Type: character vector

Values: `'Inherit: Inherit via internal rule' | 'Inherit: Inherit from input' | 'Inherit: Inherit from output' | 'double' | 'single', 'int8', 'uint8', 'int16', 'uint16', 'int32', 'uint32', 'int64', 'uint64', 'fixdt(1,16,0), fixdt(1,16,2^0,0). '<data type expression>'`

Default: `'Inherit: Inherit via internal rule'`

Output — Output data type

Inherit: Same as first input (default) | Inherit: Inherit via internal rule |
 Inherit: Inherit via back propagation | double | single | half | int8 | int32 | uint32 |
 int64 | uint64 | fixdt(1,16,2^0,0) | <data type expression> | ...

Specify the output data type. The type can be inherited, specified directly, or expressed as a data type object such as `Simulink.NumericType`.

Dependencies

When input is a floating-point data type smaller than single precision, the `Inherit: Inherit via internal rule` output data type depends on the setting of the “Inherit floating-point output type smaller than single precision” configuration parameter. Data types are smaller than single precision when the number of bits needed to encode the data type is less than the 32 bits needed to encode the single-precision data type. For example, `half` and `int16` are smaller than single precision.

Programmatic Use

Block Parameter: `OutDataTypeStr`

Type: character vector

Values: 'Inherit: Inherit via internal rule' | 'Inherit: Inherit via back propagation' | 'Inherit: Same as first input' | 'double' | 'single' | 'half' | 'int8' | 'uint8' | 'int16' | 'uint16' | 'int32' | 'uint32' | 'int64' | 'uint64' | 'fixdt(1,16,0)' | 'fixdt(1,16,2^0,0)' | 'fixdt(1,16,2^0,0)' | '<data type expression>'

Default: 'Inherit: Same as first input'

Minimum — Minimum output value for range checking

[] (default) | scalar

Specify the lower value of the output range that Simulink checks as a finite, real, double, scalar value.

Note If you specify a bus object as the data type for this block, do not set the minimum value for bus data on the block. Simulink ignores this setting. Instead, set the minimum values for bus elements of the bus object specified as the data type. For information on the `Minimum` parameter for a bus element, see `Simulink.BusElement`.

Simulink uses the minimum to perform:

- Parameter range checking (see “Specify Minimum and Maximum Values for Block Parameters”) for some blocks.
- Simulation range checking (see “Specify Signal Ranges” and “Enable Simulation Range Checking”).
- Automatic scaling of fixed-point data types.
- Optimization of the code that you generate from the model. This optimization can remove algorithmic code and affect the results of some simulation modes such as SIL or external mode. For more information, see “Optimize using the specified minimum and maximum values” (Embedded Coder).

Note `Output minimum` does not saturate or clip the actual output signal. Use the `Saturation` block instead.

Programmatic Use**Block Parameter:** OutMin**Type:** character vector**Values:** scalar**Default:** '[]'**Maximum — Maximum output value for range checking**

[] (default) | scalar

Specify the upper value of the output range that Simulink checks as a finite, real, double, scalar value.

Note If you specify a bus object as the data type for this block, do not set the maximum value for bus data on the block. Simulink ignores this setting. Instead, set the maximum values for bus elements of the bus object specified as the data type. For information on the Maximum parameter for a bus element, see `Simulink.BusElement`.

Simulink uses the maximum value to perform:

- Parameter range checking (see “Specify Minimum and Maximum Values for Block Parameters”) for some blocks.
- Simulation range checking (see “Specify Signal Ranges” and “Enable Simulation Range Checking”).
- Automatic scaling of fixed-point data types.
- Optimization of the code that you generate from the model. This optimization can remove algorithmic code and affect the results of some simulation modes such as SIL or external mode. For more information, see “Optimize using the specified minimum and maximum values” (Embedded Coder).

Note **Output maximum** does not saturate or clip the actual output signal. Use the Saturation block instead.

Programmatic Use**Block Parameter:** OutMax**Type:** character vector**Values:** scalar**Default:** '[]'**Integer rounding mode — Rounding mode for fixed-point operations**

Floor (default) | Ceiling | Convergent | Nearest | Round | Simplest | Zero

Specify the rounding mode for fixed-point operations. For more information, see “Rounding” (Fixed-Point Designer).

Programmatic Use**Block Parameter:** RndMeth**Type:** character vector**Values:** 'Ceiling' | 'Convergent' | 'Floor' | 'Nearest' | 'Round' | 'Simplest' | 'Zero'

Default: 'Floor'

Lock output data type setting against changes by the fixed-point tools – Prevent fixed-point tools from overriding data types

off (default) | on

Select to lock the output data type setting of this block against changes by the Fixed-Point Tool and the Fixed-Point Advisor. For more information, see “Use Lock Output Data Type Setting” (Fixed-Point Designer).

Programmatic Use

Block Parameter: LockScale

Type: character vector

Values: 'off' | 'on'

Default: 'off'

Saturate on integer overflow – Choose the behavior when integer overflow occurs

off (default) | on

| Action | Reasons for Taking This Action | What Happens for Overflows | Example |
|-------------------------------|---|---|---|
| Select this check box. | Your model has possible overflow, and you want explicit saturation protection in the generated code. | Overflows saturate to either the minimum or maximum value that the data type can represent. | The maximum value that the <code>int8</code> (signed, 8-bit integer) data type can represent is 127. Any block operation result greater than this maximum value causes overflow of the 8-bit integer. With the check box selected, the block output saturates at 127. Similarly, the block output saturates at a minimum output value of -128. |
| Do not select this check box. | You want to optimize efficiency of your generated code. You want to avoid overspecifying how a block handles out-of-range signals. For more information, see “Troubleshoot Signal Range Errors”. | Overflows wrap to the appropriate value that is representable by the data type. | The maximum value that the <code>int8</code> (signed, 8-bit integer) data type can represent is 127. Any block operation result greater than this maximum value causes overflow of the 8-bit integer. With the check box cleared, the software interprets the overflow-causing value as <code>int8</code> , which can produce an unintended result. For example, a block result of 130 (binary 1000 0010) expressed as <code>int8</code> , is -126. |

When you select this check box, saturation applies to every internal operation on the block, not just the output or result. Usually, the code generation process can detect when overflow is not possible. In this case, the code generator does not produce saturation code.

Programmatic Use**Block Parameter:** DoSatur**Type:** character vector**Value:** 'off' | 'on'**Default:** 'off'**Block Characteristics**

| | |
|---------------------------------|--|
| Data Types | double fixed point half integer single |
| Direct Feedthrough | yes |
| Multidimensional Signals | yes |
| Variable-Size Signals | yes |
| Zero-Crossing Detection | no |

Extended Capabilities**C/C++ Code Generation**

Generate C and C++ code using Simulink® Coder™.

HDL Code Generation

Generate Verilog and VHDL code for FPGA and ASIC designs using HDL Coder™.

HDL Coder provides additional configuration options that affect HDL implementation and synthesized logic.

Sqrt Function Modes

For the Sqrt block with **Function** set to `sqrt`, the code generator supports various architectures and data types.

The `sqrtfunction` architecture supports code generation for fixed-point types and floating-point types. When you use floating-point types, set “Floating Point IP Library” (HDL Coder) to **Native Floating Point**. You can specify the **LatencyStrategy** and **CustomLatency** HDL properties to choose from a range of frequency values when targeting your design on the hardware platform.

Use the **UseMultiplier** HDL block property in combination with the **LatencyStrategy** and **CustomLatency** properties to specify whether to compute the square root by using a pipelined shift and add or multiplication algorithm

Native Floating Point Settings for Different Modes

For this architecture, you can specify the **HandleDenormals** and **LatencyStrategy** settings from the **Native Floating Point** tab in the HDL Block Properties dialog box.

| Architecture | Fixed-Point | Native Floating-Point | HandleDenormals | LatencyStrategy |
|---------------------------|-------------|-----------------------|-----------------|-----------------|
| <code>sqrtfunction</code> | ✓ | ✓ | ✓ | ✓ |
| <code>sqrtnewton</code> | ✓ | — | — | — |

| Architecture | Fixed-Point | Native Floating-Point | HandleDenormals | LatencyStrategy |
|-----------------------|-------------|-----------------------|-----------------|-----------------|
| sqrtnewtonsingle | ✓ | — | — | — |
| recipsqrtnewton | ✓ | — | — | — |
| recipsqrtnewtonsingle | ✓ | — | — | — |

HDL Architecture

This block has multi-cycle implementations that introduce additional latency in the generated code. To see the added latency, view the generated model or validation model. See “Generated Model and Validation Model” (HDL Coder).

| Architecture | Parameter | Additional cycles of latency | Description |
|------------------------|---|--|---|
| SqrtFunction (default) | <ul style="list-style-type: none"> UseMultiplier LatencyStrategy CustomLatency | Depends on parameter choices, output word length, and input and output fraction lengths. | <p>To specify this architecture, set Function to <code>sqrt</code> or <code>rSqrt</code>.</p> <p>Compute the square root by using a pipelined shift/addition algorithm or multiplication-based algorithm.</p> <p>The SqrtFunction architecture has a maximum latency that is determined by the output word length, and input and output fraction lengths, for fixed-point data. For example, the maximum latency is 11 for output word length of 17.</p> <p>To see the latency calculation, at the MATLAB command prompt, enter:</p> <pre>HDLMathLib</pre> <p>Improve design frequency and reduce resource utilization by setting the UseMultiplier to <code>off</code> and LatencyStrategy to <code>inherit</code>.</p> |

| Architecture | Parameter | Additional cycles of latency | Description |
|---------------------------|------------|------------------------------|---|
| SqrtNewton | Iterations | Iterations + 3 | <p>To specify this architecture, set Function to sqrt.</p> <p>Use the iterative Newton method. Select this option to optimize area.</p> <p>The default value for Iterations is 3.</p> <p>The recommended value for Iterations is from 2 through 10. If Iterations is outside the recommended range, HDL Coder generates a message.</p> |
| SqrtNewtonSingleRate | Iterations | (Iterations * 4) + 6 | <p>To specify this architecture, set Function to sqrt.</p> <p>Use the single rate pipelined Newton method. Select this option to optimize speed, or if you want a single rate implementation.</p> <p>The default value for Iterations is 3.</p> <p>The recommended value for Iterations is from 2 through 10. If Iterations is outside the recommended range, the coder generates a message.</p> |
| RecipSqrtNewton | Iterations | Iterations + 2 | <p>To specify this architecture, set Function to rSqrt.</p> <p>Use the iterative Newton method. Select this option to optimize area.</p> |
| RecipSqrtNewtonSingleRate | Iterations | (Iterations * 4) + 5 | <p>To specify this architecture, set Function to rSqrt.</p> <p>Use the single rate pipelined Newton method. Select this option to optimize speed, or if you want a single rate implementation.</p> |

The Newton-Raphson iterative method:

$$x_{i+1} = x_i - \frac{f(x_i)}{f'(x_i)} = x_i(1.5 - 0.5ax_i^2)$$

ReciprocalRsqrtBasedNewton and ReciprocalRsqrtBasedNewtonSingleRate implement the Newton-Raphson method with:

$$f(x) = \frac{1}{x^2} - 1$$

HDL Block Properties

| General | |
|----------------------------------|--|
| ConstrainedOutputPipeline | Number of registers to place at the outputs by moving existing delays within your design. Distributed pipelining does not redistribute these registers. The default is 0. For more details, see “ConstrainedOutputPipeline” (HDL Coder). |
| Iterations | Number of iterations for SqrtNewton or SqrtNewtonSingleRate implementation. |
| InputPipeline | Number of input pipeline stages to insert in the generated code. Distributed pipelining and constrained output pipelining can move these registers. The default is 0. For more details, see “InputPipeline” (HDL Coder). |
| OutputPipeline | Number of output pipeline stages to insert in the generated code. Distributed pipelining and constrained output pipelining can move these registers. The default is 0. For more details, see “OutputPipeline” (HDL Coder). |
| UseMultiplier | Select algorithm for SqrtFunction implementation. By default, this property is set to off, and the block computes square root by using the shift-add algorithm. When the property is set to on, the square root is computed by using multipliers. Increase design frequency and reduce resource utilization by setting the UseMultiplier to off and LatencyStrategy to inherit . |
| LatencyStrategy | Specify whether to map the blocks in your design to MAX, MIN, CUSTOM, or ZERO latency for fixed-point and floating-point types. The default is MAX. The block settings for floating-point types overrides the model-level settings. For fixed-point types, the block-level setting determines the latency strategy. See also “LatencyStrategy” (HDL Coder) . Increase design frequency and reduce resource utilization by setting the UseMultiplier to off and LatencyStrategy to inherit . |
| CustomLatency | When LatencyStrategy is set to CUSTOM and if you use fixed-point types, use this property to specify a custom latency value between ZERO and MAX for fixed-point types. For floating-point types, this value becomes the custom latency of the operator. See also “NFPCustomLatency” (HDL Coder). |
| Native Floating Point | |
| HandleDenormals | Specify whether you want HDL Coder to insert additional logic to handle denormal numbers in your design. Denormal numbers are numbers that have magnitudes less than the smallest floating-point number that can be represented without leading zeros in the mantissa. The default is inherit. See also “HandleDenormals” (HDL Coder). |

Restrictions

- Input must be an unsigned scalar value.
- Output is a fixed-point scalar value.

PLC Code Generation

Generate Structured Text code using Simulink® PLC Coder™.

Fixed-Point Conversion

Design and simulate fixed-point systems using Fixed-Point Designer™.

See Also

Math Function | Trigonometric Function

Introduced in R2010a

Squeeze

Remove singleton dimensions from multidimensional signal

Library: Simulink / Math Operations



Description

The Squeeze block removes singleton dimensions from its multidimensional input signal. A singleton dimension is any dimension whose size is one. The Squeeze block operates only on signals whose number of dimensions is greater than two. Scalar, vector, and matrix signals pass through the Squeeze block unchanged.

Ports

Input

Port_1 — Multidimensional input signal

multidimensional signal

Input signal that has any singleton dimensions removed in the output.

Data Types: half | single | double | int8 | int16 | int32 | int64 | uint8 | uint16 | uint32 | uint64 | Boolean | fixed point | enumerated | bus

Output

Port_1 — Output signal with no singleton dimensions

multidimensional signal

Output signal with no singleton dimensions. For example, a multidimensional array of size 3-by-1-by-2 changes into a 3-by-2 signal. If there are no singleton dimensions in the input, then the input signal is passed through unchanged to the output.

Data Types: half | single | double | int8 | int16 | int32 | int64 | uint8 | uint16 | uint32 | uint64 | Boolean | fixed point | enumerated | bus

Block Characteristics

| | |
|---------------------------------|---|
| Data Types | Boolean double enumerated fixed point half integer single |
| Direct Feedthrough | no |
| Multidimensional Signals | yes |
| Variable-Size Signals | no |
| Zero-Crossing Detection | no |

Extended Capabilities

C/C++ Code Generation

Generate C and C++ code using Simulink® Coder™.

PLC Code Generation

Generate Structured Text code using Simulink® PLC Coder™.

Fixed-Point Conversion

Design and simulate fixed-point systems using Fixed-Point Designer™.

See Also

Reshape

Introduced in R2007b

State Reader

Read a block state

Library: Simulink / Signal Routing



Description

The State Reader block reads the current state of a supported state owner block.

State Reader blocks can read state from these state owner blocks:

- Discrete State-Space
- Discrete-Time Integrator
- Delay
- Unit Delay
- Discrete Transfer Fcn
- Discrete Filter
- Discrete FIR Filter
- Integrator
- Second-Order Integrator
- Output of conditional subsystem blocks such as Enabled Subsystem, Triggered Subsystem, and Function-Call Subsystem
- S-Function with multiple discrete states

To configure an S-Function block as a state owner block, each data type work vector must be declared as a discrete state vector using `ssSetDWorkUsedAsDState` and named using `ssSetDWorkName` or `ssSetDWorkRTWIdentifier` in `mdlInitializeSizes`.

Tip You can determine whether a block is a supported state owner block by the value of the block's `IsStateOwnerBlock` parameter. The expression

```
get_param(blk, 'IsStateOwnerBlock')
```

where `blk` is a block name or handle, returns 'on' if the block is a supported state owner block and 'off' otherwise.

To add a State Reader or State Writer block to your model, right-click on a state owner block and drag to an empty portion of the Simulink canvas. When you release, a menu will appear. Select **Create State Reader Block** or **Create State Writer Block**.

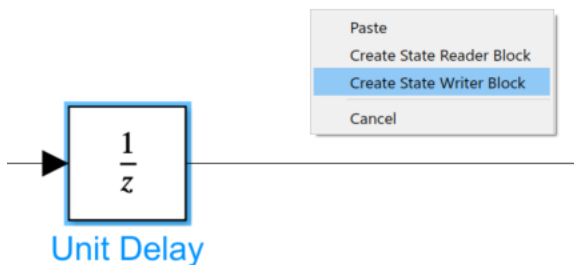

After you create a State Reader or State Writer block, a  badge appears above the state owner block, and the name of the state owner block appears next to the State Reader or State Writer block.

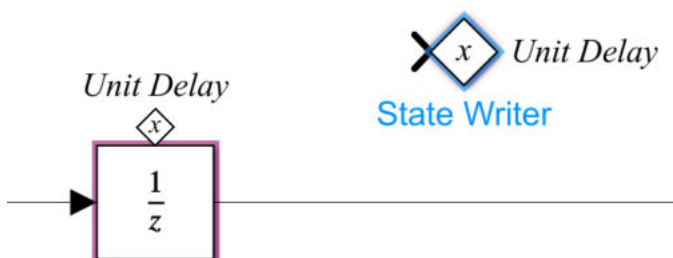

A State Reader or State Writer block cannot remain in the same system as its state owner block. After you create a State Reader or State Writer block, cut and paste it to move it to the desired location within the model hierarchy.

Alternatively, you can add a State Reader or State Writer block to your model from the Simulink Library Browser, then set the **State owner block** parameter from the block parameters dialog.

Note When you create a library block with a State Reader or State Writer block, you must also include the corresponding state owner block in the library block.

You can select a State Reader or State Writer block or a corresponding state owner block to highlight blocks related to it. To show a related block in an open diagram or new tab, pause on the ellipsis that appears after selection. Then, select **Related Blocks**  from the action bar. When multiple blocks correspond to the selected block, a list of related blocks opens. You can filter the list of related blocks by entering a search term in the text box. After you select a related block from the list, window focus goes to the open diagram or new tab that shows the related block.

Ports

Output

Out — State value

scalar | vector

State value read from a state owner block.

The dimension of the output is the dimension of the full state vector. Refer to the **Initial conditions** parameter for specific blocks. For example, for a Delay block with a **Delay length** of N, the State Reader block returns a state vector of length [1×N].

Data Types: `single` | `double` | `half` | `int8` | `int16` | `int32` | `int64` | `uint8` | `uint16` | `uint32` | `uint64` | `fixed point`

Parameters

State owner block — Name of state owner block

`none` (default)

Name of state owner block whose state this block is reading. To change the state owner block, select a block from the **State Owner Selector Tree**.

Note If the name of a state owner block contains a slash (/), the slash appears as two slashes (//) in the State Reader block parameters dialog. This notation distinguishes the slash in the block name itself from slashes that separate names at different levels of the model hierarchy.

Programmatic Use

Block Parameter: `StateOwnerBlock`

Type: character vector

Value: `' '` | `'<model path/block name>'`

Default: `' '`

Block Characteristics

| | |
|---------------------------------|---|
| Data Types | <code>Boolean</code> <code>bus</code> <code>double</code> <code>enumerated</code> <code>fixed point</code> <code>half</code> <code>integer</code> <code>single</code> |
| Direct Feedthrough | <code>no</code> |
| Multidimensional Signals | <code>yes</code> |
| Variable-Size Signals | <code>no</code> |
| Zero-Crossing Detection | <code>no</code> |

Extended Capabilities

C/C++ Code Generation

Generate C and C++ code using Simulink® Coder™.

Fixed-Point Conversion

Design and simulate fixed-point systems using Fixed-Point Designer™.

See Also

[Initialize Function](#) | [Reset Function](#) | [Terminate Function](#) | [Event Listener](#) | [State Writer](#)

Topics

“Using Initialize, Reset, and Terminate Functions”

“Create Test Harness to Generate Function Calls”

State Writer

Write to a block state

Library: Simulink / Signal Routing



Description

The State Writer block sets the state of a supported state owner block.

State Writer blocks can write state to these state owner blocks:

- Discrete State-Space
- Discrete-Time Integrator
- Delay
- Unit Delay
- Discrete Transfer Fcn
- Discrete Filter
- Discrete FIR Filter
- Integrator
- Second-Order Integrator
- Output of conditional subsystem blocks such as Enabled Subsystem, Triggered Subsystem, and Function-Call Subsystem
- S-Function with multiple discrete states

To configure an S-Function block as a state owner block, each data type work vector must be declared as a discrete state vector using `ssSetDWorkUsedAsDState` and named using `ssSetDWorkName` or `ssSetDWorkRTWIdentifier` in `mdlInitializeSizes`.

Tip You can determine whether a block is a supported state owner block by the value of the block's `IsStateOwnerBlock` parameter. The expression

```
get_param(blk, 'IsStateOwnerBlock')
```

where `blk` is a block name or handle, returns 'on' if the block is a supported state owner block and 'off' otherwise.

To add a State Reader or State Writer block to your model, right-click on a state owner block and drag to an empty portion of the Simulink canvas. When you release, a menu will appear. Select **Create State Reader Block** or **Create State Writer Block**.

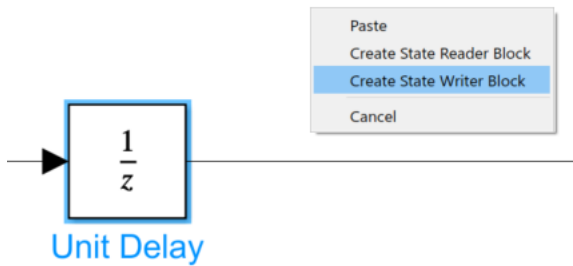

After you create a State Reader or State Writer block, a  badge appears above the state owner block, and the name of the state owner block appears next to the State Reader or State Writer block.

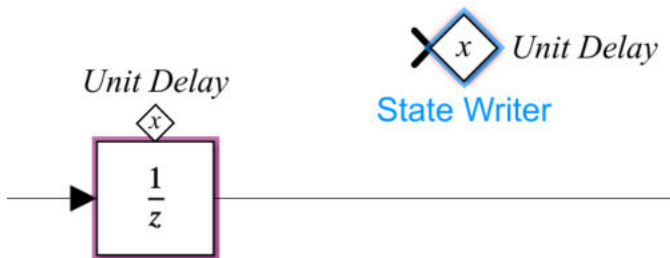

A State Reader or State Writer block cannot remain in the same system as its state owner block. After you create a State Reader or State Writer block, cut and paste it to move it to the desired location within the model hierarchy.

Alternatively, you can add a State Reader or State Writer block to your model from the Simulink Library Browser, then set the **State owner block** parameter from the block parameters dialog.

Note When you create a library block with a State Reader or State Writer block, you must also include the corresponding state owner block in the library block.

You can select a State Reader or State Writer block or a corresponding state owner block to highlight blocks related to it. To show a related block in an open diagram or new tab, pause on the ellipsis that appears after selection. Then, select **Related Blocks**  from the action bar. When multiple blocks correspond to the selected block, a list of related blocks opens. You can filter the list of related blocks by entering a search term in the text box. After you select a related block from the list, window focus goes to the open diagram or new tab that shows the related block.

Ports

Input

In — State value

scalar | vector

State value written to a state owner block.

When writing to a state owner block with an input scalar, the scalar value is expanded to match the dimension of the state. All elements of the state are set to the same value.

Data Types: `single` | `double` | `half` | `int8` | `int16` | `int32` | `int64` | `uint8` | `uint16` | `uint32` | `uint64` | `fixed point`

Parameters

State owner block — Name of state owner block

`none` (default)

Name of state owner block whose state this block is writing. To change the state owner block, select a block from the **State Owner Selector Tree**.

Note If the name of a state owner block contains a slash (/), the slash appears as two slashes (//) in the State Writer block parameters dialog. This notation distinguishes the slash in the block name itself from slashes that separate names at different levels of the model hierarchy.

Programmatic Use

Block Parameter: `StateOwnerBlock`

Type: character vector

Value: `' | '<model path/block name>'`

Default: `''`

Block Characteristics

| | |
|---------------------------------|---|
| Data Types | <code>Boolean</code> <code>bus</code> <code>double</code> <code>enumerated</code> <code>fixed point</code> <code>half</code> <code>integer</code> <code>single</code> |
| Direct Feedthrough | <code>no</code> |
| Multidimensional Signals | <code>yes</code> |
| Variable-Size Signals | <code>no</code> |
| Zero-Crossing Detection | <code>no</code> |

Extended Capabilities

C/C++ Code Generation

Generate C and C++ code using Simulink® Coder™.

Fixed-Point Conversion

Design and simulate fixed-point systems using Fixed-Point Designer™.

See Also

[Initialize Function](#) | [Reset Function](#) | [Terminate Function](#) | [Event Listener](#) | [State Reader](#)

Topics

“Using Initialize, Reset, and Terminate Functions”

“Create Test Harness to Generate Function Calls”

State-Space

Implement linear state-space system

Library: Simulink / Continuous

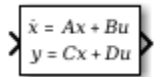

Description

The State-Space block implements a system whose behavior you define as

$$\dot{x} = Ax + Bu$$

$$y = Cx + Du$$

$$x|_{t=t_0} = x_0,$$

where x is the state vector, u is the input vector, y is the output vector, and x_0 is the initial condition of the state vector. The A , B , C , and D matrices can be specified as either sparse matrices or dense matrices. The matrix coefficients must have these characteristics:

- A must be an n -by- n matrix, where n is the number of states.
- B must be an n -by- m matrix, where m is the number of inputs.
- C must be an r -by- n matrix, where r is the number of outputs.
- D must be an r -by- m matrix.

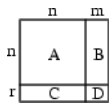

In general, the block has one input port and one output port. The number of rows in C or D matrix is the same as the width of the output port. The number of columns in the B or D matrix are the same as the width of the input port. If you want to model an autonomous linear system with no inputs, set the B and D matrices to empty. In this case, the block acts as a source block with no input port and one output port, and implements the following system:

$$\dot{x} = Ax$$

$$y = Cx$$

$$x|_{t=t_0} = x_0.$$

Simulink software converts a matrix containing zeros to a sparse matrix for efficient multiplication.

Ports

Input

Port_1 — Input signal

scalar | vector

Real-valued input vector of type `double`, where the width equals the number of columns in the **B** and **D** matrices. For more information, see “Description” on page 1-1722.

Data Types: `double`

Output

Port_1 – Output vector

scalar | vector

Real-valued output vector of data type `double`, with width equal to the number of rows in the **C** and **D** matrices. For more information, see “Description” on page 1-1722.

Data Types: `double`

Parameters

A – Matrix coefficient, A

1 (default) | scalar | vector | matrix | sparse matrix

Specify the matrix coefficient **A**, as a real-valued n -by- n matrix, where n is the number of states. For more information on the matrix coefficients, see “Description” on page 1-1722.

Programmatic Use

Block Parameter: A

Type: character vector, string

Values: scalar | vector | matrix | sparse matrix

Default: '1'

B – Matrix coefficient, B

1 (default) | scalar | vector | matrix | sparse matrix

Specify the matrix coefficient **B**, as a real-valued n -by- m matrix, where n is the number of states and m is the number of inputs. For more information on the matrix coefficients, see “Description” on page 1-1722.

Programmatic Use

Block Parameter: B

Type: character vector, string

Values: scalar | vector | matrix | sparse matrix

Default: '1'

C – Matrix coefficient, C

1 (default) | scalar | vector | matrix | sparse matrix

Specify the matrix coefficient **C** as a real-valued r -by- n matrix, where r is the number of outputs and n is the number of states. For more information on the matrix coefficients, see “Description” on page 1-1722.

Programmatic Use

Block Parameter: C

Type: character vector, string

Values: scalar | vector | matrix | sparse matrix

Default: '1'

D — Matrix coefficient, D

1 (default) | scalar | vector | matrix | sparse matrix

Specify the matrix coefficient **D** as a real-valued r -by- m matrix, where r is the number of outputs and m is the number of inputs. For more information on the matrix coefficients, see “Description” on page 1-1722.

Programmatic Use**Block Parameter:** D**Type:** character vector, string**Values:** scalar | vector | matrix | sparse matrix**Default:** '1'**Initial conditions — Initial state vector**

0 (default) | scalar | vector

Specify the initial state vector.

Limitations

The initial conditions of this block cannot be `inf` or `NaN`.

Programmatic Use**Block Parameter:** X0**Type:** character vector, string**Values:** scalar | vector**Default:** '0'**Parameter tunability — Choose tunable representation of block parameters**

Auto (default) | Optimized | Unconstrained

Tunability level of the state-space matrices (A,B,C, and D) for accelerated simulation modes and deployed simulations using the Simulink Compiler™. When set to `Auto`, Simulink chooses the appropriate parameter tunability level.

For sparse matrix coefficients, set the parameter to `Optimized` to allow tunability of non-zero elements while keeping the pattern and number of non-zero elements constant. Set this parameter to `Unconstrained` to allow all elements to be tunable, so long as the number of non-zero elements is kept constant, that is, you can change the pattern of the sparse matrix.

For dense matrix coefficients, select `Optimized` to allow tunability of all matrix elements, provided the number of non-zero elements initially specified in the matrix is kept constant. Set this parameter to `Unconstrained` to allow full tunability of all matrix elements.

Note To tune the **D** matrix of the block when $D = 0$, you must enable the **Allow non-zero values for D matrix initially specified as zero** parameter.

Programmatic Use**Block Parameter:** ParameterTunability**Type:** character vector | string**Values:** 'Auto' | 'Optimized' | 'Unconstrained'**Default:** 'Auto'

Allow non-zero values for D matrix initially specified as zero — Allow tunability of D matrix when D = 0

off (default) | on

Enable this parameter to support tunability of **D** even when $D = 0$.

Note Enabling this parameter enables direct feedthrough for the State-Space block.

Programmatic Use**Block Parameter:** AllowTunableDMatrix**Type:** character vector | string**Values:** 'off' | 'on'**Default:** 'off'**Absolute tolerance — Absolute tolerance for computing block states**

auto (default) | scalar | vector

Absolute tolerance for computing block states, specified as a positive, real-valued, scalar or vector. To inherit the absolute tolerance from the Configuration Parameters, specify `auto` or `-1`.

- If you enter a real scalar, then that value overrides the absolute tolerance in the Configuration Parameters dialog box for computing all block states.
- If you enter a real vector, then the dimension of that vector must match the dimension of the continuous states in the block. These values override the absolute tolerance in the Configuration Parameters dialog box.
- If you enter `auto` or `-1`, then Simulink uses the absolute tolerance value in the Configuration Parameters dialog box (see “Solver Pane”) to compute block states.

Programmatic Use**Block Parameter:** AbsoluteTolerance**Type:** character vector, string**Values:** 'auto' | '-1' | any positive real-valued scalar or vector**Default:** 'auto'**State Name (e.g., 'position') — Assign unique name to each state**

' ' (default) | 'position' | {'a', 'b', 'c'} | a | ...

Assign a unique name to each state. If this field is blank (' '), no name assignment occurs.

- To assign a name to a single state, enter the name between quotes, for example, 'position'.
- To assign names to multiple states, enter a comma-delimited list surrounded by braces, for example, {'a', 'b', 'c'}. Each name must be unique.
- To assign state names with a variable in the MATLAB workspace, enter the variable without quotes. A variable can be a character vector, string, cell array, or structure.

Limitations

- The state names apply only to the selected block.
- The number of states must divide evenly among the number of state names.
- You can specify fewer names than states, but you cannot specify more names than states.

For example, you can specify two names in a system with four states. The first name applies to the first two states and the second name to the last two states.

Programmatic Use

Block Parameter: ContinuousStateAttributes

Type: character vector, string

Values: ' ' | user-defined

Default: ' '

Block Characteristics

| | |
|---------------------------------|--------|
| Data Types | double |
| Direct Feedthrough | yes |
| Multidimensional Signals | no |
| Variable-Size Signals | no |
| Zero-Crossing Detection | no |

Extended Capabilities

C/C++ Code Generation

Generate C and C++ code using Simulink® Coder™.

Not recommended for production-quality code. Relates to resource limits and restrictions on speed and memory often found in embedded systems. The code generated can contain dynamic allocation and freeing of memory, recursion, additional memory overhead, and widely-varying execution times. While the code is functionally valid and generally acceptable in resource-rich environments, smaller embedded targets often cannot support such code.

In general, consider using the Simulink Model Discretizer to map continuous blocks into discrete equivalents that support production code generation. To start the Model Discretizer, in the Simulink Editor, on the **Apps** tab, under **Apps**, under **Control Systems**, click **Model Discretizer**. One exception is the Second-Order Integrator block because, for this block, the Model Discretizer produces an approximate discretization.

See Also

Discrete State-Space | Transfer Fcn

Topics

“State”

Introduced before R2006a

Step

Generate step function

Library: Simulink / Sources



Description

The Step block provides a step between two definable levels at a specified time. If the simulation time is less than the **Step time** parameter value, the block's output is the **Initial value** parameter value. For simulation time greater than or equal to the **Step time**, the output is the **Final value** parameter value.

The numeric block parameters must be of the same dimensions after scalar expansion. If the **Interpret vector parameters as 1-D** option is off, the block outputs a signal of the same dimensions and dimensionality as the parameters. If the **Interpret vector parameters as 1-D** option is on and the numeric parameters are row or column vectors (that is, single-row or column 2-D arrays), the block outputs a vector (1-D array) signal. Otherwise, the block outputs a signal of the same dimensionality and dimensions as the parameters.

Ports

Output

Port_1 — Output step signal

scalar | vector

Output step function signal defined by the parameters **Step time**, **Initial value**, and **Final value**.

Data Types: double | single

Parameters

Step time — Time when step occurs

1 (default) | scalar

Specify the time, in seconds, when the output jumps from the **Initial value** parameter to the **Final value** parameter.

Programmatic Use

Block Parameter: Time

Type: character vector

Values: '1' | real- or complex-valued scalar, vector, or matrix

Default: '1'

Initial value — Output value before step

0 (default) | scalar

Specify the block output until the simulation time reaches the **Step time** parameter.

Programmatic Use**Block Parameter:** Before**Type:** character vector**Values:** '1' | real- or complex-valued scalar, vector, or matrix**Default:** '0'**Final value — Output value after step**

1 (default) | scalar

Specify the block output when the simulation time reaches and exceeds the **Step time** parameter.

Programmatic Use**Block Parameter:** After**Type:** character vector**Values:** '1' | real- or complex-valued scalar, vector, or matrix**Default:** '1'**Sample time — Sample rate**

0 (default) | scalar

Specify the sample rate of step. See “Specify Sample Time” for more information.

Programmatic Use**Block Parameter:** SampleTime**Type:** character vector**Values:** scalar**Default:** '0'**Interpret vector parameters as 1-D — Treat vectors as 1-D**

on (default) | off

Select this check box to output a vector of length N if the **Constant value** parameter evaluates to an N-element row or column vector.

- When you select this check box, the block outputs a vector of length N if the **Constant value** parameter evaluates to an N-element row or column vector. For example, the block outputs a matrix of dimension 1-by-N or N-by-1.
- When you clear this check box, the block does not output a vector of length N if the **Constant value** parameter evaluates to an N-element row or column vector.

Programmatic Use**Block Parameter:** VectorParams1D**Type:** character vector**Values:** 'on' | 'off'**Default:** 'on'**Enable zero-crossing detection — Enable zero-crossing detection**

on (default) | Boolean

Select to enable zero-crossing detection. For more information, see “Zero-Crossing Detection” in the Simulink documentation.

Programmatic Use**Block Parameter:** ZeroCross**Type:** character vector, string**Values:** 'off' | 'on'**Default:** 'on'**Output data type — Output data type**

double (default) | Inherit: Inherit via back propagation | single | <data type expression>

Output data type. The type can be inherited, specified directly, or expressed as a data type object such as `Simulink.NumericType`.

When you select `Inherit: Inherit via back propagation`, the block uses the data type of the driving block.

Click the **Show data type assistant** button  to display the **Data Type Assistant**, which helps you set the data type attributes. See “Specify Data Types Using Data Type Assistant” in the *Simulink User's Guide* for more information.

Programmatic Use**Block Parameter:** OutDataTypeStr**Type:** character vector**Values:** 'Inherit: Inherit via internal rule' | 'double' | 'single' | <data type expression>**Default:** 'double'**Data type override — Specify data type override mode for this signal**

Inherit | Off

Select the data type override mode for this signal.

- When you select `Inherit`, Simulink inherits the data type override setting from its context, that is, from the block, `Simulink.Signal` object or Stateflow chart in Simulink that is using the signal.
- When you select `Off`, Simulink ignores the data type override setting of its context.

For more information, see “Specify Data Types Using Data Type Assistant” in the Simulink documentation.

Dependencies

To enable this parameter, click the **Show data type assistant** button, and set the **Mode** to `Built in`.

Tips

The ability to turn off data type override for an individual data type provides greater control over the data types in your model when you apply data type override. For example, you can use this option to ensure that data types meet the requirements of downstream blocks regardless of the data type override setting.

Block Characteristics

| | |
|---------------------------------|--------|
| Data Types | double |
| Direct Feedthrough | no |
| Multidimensional Signals | no |
| Variable-Size Signals | no |
| Zero-Crossing Detection | yes |

Extended Capabilities

C/C++ Code Generation

Generate C and C++ code using Simulink® Coder™.

Not recommended for production code.

See Also

Ramp | Repeating Sequence Stair | Signal Editor

Topics

“Signal Basics”

Introduced before R2006a

Stop Simulation

Stop simulation when input is nonzero

Library: Simulink / Sinks
HDL Coder / Sinks



Description

The Stop Simulation block stops the simulation when the input is nonzero. The simulation completes the current time step before terminating. If the block input is a vector, any nonzero vector element causes the simulation to stop.

When you use the Stop Simulation block in a For Iterator subsystem, the stop action occurs after execution of *all* iterations in the subsystem during a time step. The stop action does not interrupt execution until the start of the next time step.

You cannot use the Stop Simulation block to pause the simulation. To create a block that pauses the simulation, see “Pause Simulation Using Assertion Blocks”.

Ports

Input

Port_1 — Input signal

scalar | vector | matrix

Stop simulation when input signal is nonzero. This port accepts real signals of `double` or `Boolean` data types.

Data Types: `double` | `Boolean`

Block Characteristics

| | |
|---------------------------------|------------------|
| Data Types | Boolean double |
| Direct Feedthrough | no |
| Multidimensional Signals | no |
| Variable-Size Signals | no |
| Zero-Crossing Detection | no |

Extended Capabilities

C/C++ Code Generation

Generate C and C++ code using Simulink® Coder™.

Not recommended for production code. Relates to resource limits and restrictions on speed and memory often found in embedded systems. Generated code can contain dynamic allocation and freeing of memory, recursion, additional memory overhead, and widely varying execution times. While the code is functionally valid and acceptable in resource-rich environments, smaller embedded targets often cannot support such code. Usually, blocks evolve toward being suitable for production code. Thus, blocks suitable for production code remain suitable.

Generated code stops executing when the stop condition is true.

HDL Code Generation

Generate Verilog and VHDL code for FPGA and ASIC designs using HDL Coder™.

This block can be used to stop simulation when used with subsystems that generates code, but is not included in the hardware implementation.

PLC Code Generation

Generate Structured Text code using Simulink® PLC Coder™.

See Also

Topics

“Simulate a Model Interactively”

Introduced before R2006a

String Compare

Compare two input strings

Library: Simulink / String

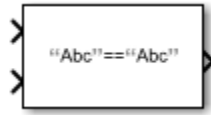

Description

String Compare compares two strings. To see if two strings are identical, use this block. You can specify if the match is case sensitive and how much of the string to compare.

Ports

Input

Port_1 — First string to compare

scalar

First string to compare, specified as a scalar.

Data Types: `string`

Port_2 — Second string to compare

scalar

Second string to compare, specified as a scalar.

Data Types: `string`

Output

Port_1 — True or false result

scalar

True or false result, specified as a scalar:

- 1 — Match.
- 0 — No match.

Data Types: `Boolean`

Parameters

Case sensitive — Case sensitivity for string comparison

on (default) | off

Case sensitivity for string comparison:

on

Consider string case when comparing strings.

 off

Do not consider string case when comparing strings.

Compare Option — Amount of characters to compare

Entire string (default) | First N characters

Amount of string to compare:

- Entire string — Compare both entire strings.
- First N characters — Compare the first *N* characters of both strings.

DependenciesSetting this parameter to First N characters enables the **Number of characters** parameter.**Number of characters — Number of characters to compare**

1 (default) | scalar

Number of characters to compare

DependenciesThis parameter is enabled when the **Compare Option** parameter is set to First N characters.

Data Types: double

Block Characteristics

| | |
|---------------------------------|------------------|
| Data Types | Boolean string |
| Direct Feedthrough | yes |
| Multidimensional Signals | no |
| Variable-Size Signals | no |
| Zero-Crossing Detection | no |

Extended Capabilities**C/C++ Code Generation**

Generate C and C++ code using Simulink® Coder™.

See Also

ASCII to String | Compose String | Scan String | String Concatenate | String Constant | String Find | String Length | String to Double | String to Single | String to Enum | String to ASCII | Substring | To String

Topics

"Parse NMEA GPS Text Message"

“Simulink Strings”

Introduced in R2018a

String Concatenate

Concatenate input strings to form one output string

Library: Simulink / String

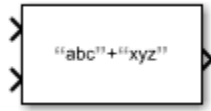

Description

The String Concatenate block concatenates multiple input strings, in order of their input, to form one output string. Use this block if you want to combine multiple strings into a single string.

Ports

Input

Port_1 — First input string

scalar

First input string, specified as a scalar.

Data Types: `string`

Port_2 — Second input string

scalar

Second input string, specified as a scalar.

Data Types: `string`

Output

Port_1 — Concatenated string

scalar

Concatenated string, specified as a scalar.

Data Types: `string`

Parameters

Number of Inputs — Number of input strings

scalar

Number of input strings to concatenate, specified as a scalar. You can specify from 2 to 512 input ports.

Output data type — Output data type

`string` (default) | `<data type expression>` | `scalar`

Output data type, specified using the string data type to specify a string with no maximum length.

To specify a string data type with a maximum length, specify `stringtype(N)`. For example, `stringtype(128)` creates a string data type with a maximum length of 128 characters.

Click the **Show data type assistant** button  to display the **Data Type Assistant**, which helps you set the data type attributes. See “Specify Data Types Using Data Type Assistant” in the *Simulink User's Guide* for more information.

Mode — Category of data

`stringtype(128)` (default) | `scalar`

Use the `stringtype` function, for example, `stringtype(128)`.

Dependency

Clicking the **Show data type assistant** button enables this parameter.

Block Characteristics

| | |
|---------------------------------|--------|
| Data Types | string |
| Direct Feedthrough | yes |
| Multidimensional Signals | no |
| Variable-Size Signals | no |
| Zero-Crossing Detection | no |

Extended Capabilities

C/C++ Code Generation

Generate C and C++ code using Simulink® Coder™.

See Also

[ASCII to String](#) | [Compose String](#) | [Scan String](#) | [String Compare](#) | [String Constant](#) | [String Find](#) | [String Length](#) | [String to Single](#) | [String to Double](#) | [String to Enum](#) | [String to ASCII](#) | [Substring](#) | [To String](#)

Topics

“Simulink Strings”

Introduced in R2018a

String Constant

Output specified string

Library: Simulink / String



Description

The String Constant block outputs a string specified by the **String** parameter. Use this block when you want a constant whose type is string.

Ports

Output

Port_1 – Output string

scalar

Output string, specified as a scalar.

Data Types: `string`

Parameters

String – Input string

"Hello!" (default) | scalar

Input string, specified as a scalar.

Output data type – Output data type

`string` (default) | `<data type expression>` | scalar

Output data type, specified using the string data type to specify a string with no maximum length.

To specify a string data type with a maximum length, specify `stringtype(N)`. For example, `stringtype(31)` creates a string data type with a maximum length of 31 characters.

Click the **Show data type assistant** button  to display the **Data Type Assistant**, which helps you set the data type attributes. See “Specify Data Types Using Data Type Assistant” in the *Simulink User's Guide* for more information.

Block Characteristics

| | |
|---------------------------|--------|
| Data Types | string |
| Direct Feedthrough | no |

| | |
|---------------------------------|----|
| Multidimensional Signals | no |
| Variable-Size Signals | no |
| Zero-Crossing Detection | no |

Extended Capabilities

C/C++ Code Generation

Generate C and C++ code using Simulink® Coder™.

See Also

ASCII to String | Compose String | Scan String | String Compare | String Concatenate | String Find | String Length | String to Double | String to Enum | String to Single | String to ASCII | Substring | To String

Topics

“Convert String to ASCII and Back to String”
“Simulink Strings”

Introduced in R2018a

String Contains, String Starts With, String Ends With

Determine if string contains, starts with, or ends with pattern

Library: Simulink / String

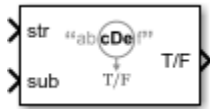

Description

The String Contains, String Starts With, and String Ends With blocks determine if a string (**str**) contains, starts with, or ends with a pattern (**sub**).

The String Contains, String Starts With, and String Ends With blocks are identical. When **Function** is set to Contains, the block determines if the string contains a specified pattern. When **Function** is set to Starts with, the block determines if the string starts with a specified pattern. When **Function** is set to Ends with, the block determines if the string ends with a specified pattern.

Ports

Input

str — String to search

scalar

String to search for the pattern in, specified as a scalar.

Data Types: `string`

sub — String pattern to search for

scalar

String pattern to search for in string, specified as a scalar.

Data Types: `string`

Output

T/F — String pattern detected

1 | 0

Whether the string pattern was detected, returned as detected (1) or not detected (0).

Data Types: `Boolean`

Parameters

Case sensitive — Case sensitivity

on (default) | off

Case sensitivity for the pattern detection:

on

Consider string case when searching for the pattern.

off

Do not consider string case when searching for the pattern.

Programmatic Use

Block Parameter: CaseSensitive

Type: character vector

Values: 'on' | 'off'

Default: 'on'

Function — Pattern search function

Contains | Starts with | Ends with

Pattern search function, specified as:

- Contains

Search for the pattern anywhere in the string. This is the default for the String Contains block.

- Starts with

Search for the pattern only at the beginning of the string. This is the default for the String Starts With block.

- Ends with

Search for the pattern only at the end of the string. This is the default for the String Ends With block.

Programmatic Use

Block Parameter: Function

Type: character vector

Values: 'Contains' | 'Starts with' | 'Ends with'

Default: 'Contains' for String Contains block, 'Starts with' for String Starts With block, 'Ends with' for String Ends With block

Block Characteristics

| | |
|---------------------------------|------------------|
| Data Types | Boolean string |
| Direct Feedthrough | yes |
| Multidimensional Signals | no |
| Variable-Size Signals | no |
| Zero-Crossing Detection | no |

Extended Capabilities

C/C++ Code Generation

Generate C and C++ code using Simulink® Coder™.

See Also

[ASCII to String](#) | [Compose String](#) | [Scan String](#) | [String Concatenate](#) | [String Count](#) | [String Contains](#) | [String Find](#) | [String Length](#) | [String to Double](#) | [String to Single](#) | [String to Enum](#) | [String to ASCII](#) | [Substring](#) | [To String](#)

Topics

“Simulink Strings”

Introduced in R2020a

String Count

Count occurrences of pattern in string

Library: Simulink / String

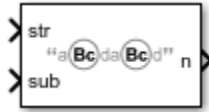

Description

The String Count block counts the occurrences of the pattern (**sub**) in a string (**str**). If the input at **sub** matches part or all of the input at **str**, the block counts the occurrence as 1.

Ports

Input

str — String to search

scalar

String to search for the pattern in, specified as a scalar.

Data Types: `string`

sub — String pattern to search for

scalar

String pattern to search for in string, specified as a scalar.

Data Types: `string`

Output

n — Number of times pattern was found in string

scalar

Number of times the string pattern was found in the string, `str`, returned as a scalar.

Data Types: `int8` | `uint8` | `int16` | `uint16` | `int32` | `uint32`

Parameters

Case sensitive — Case sensitivity

`on` (default) | `off`

Case sensitivity for the string count:

`on`

Consider string case when counting found strings.

off

Do not consider string case when counting found strings.

Programmatic Use

Block Parameter: CaseSensitive

Type: character vector

Values: 'on' | 'off'

Default: 'on'

Output data type – Output data type

Inherit: `Inherit via internal rule (default)` | `Inherit via back propagation` | `int8` | `uint8` | `int16` | `uint16` | `int32` | `uint32` | `<data type expression>`

Output data type. The type can be inherited, specified directly, or expressed as a data type object such as `Simulink.NumericType`.

When you select an inherited option, the block exhibits these behaviors:

- `Inherit: Inherit via internal rule` — Simulink chooses a data type to balance numerical accuracy, performance, and generated code size, while taking into account the properties of the embedded target hardware.
- `Inherit: Inherit via back propagation` — Use data type of the driving block.

Click the Show data type assistant button  to display the **Data Type Assistant**, which helps you set the data type attributes. See “Specify Data Types Using Data Type Assistant” in the *Simulink User's Guide* for more information.

Programmatic Use

Block Parameter: OutDataTypeStr

Type: character vector

Values: 'Inherit: Inherit via internal rule' | 'Inherit: Inherit via back propagation' | 'int8' | 'uint8' | 'int16' | 'uint16' | 'int32' | 'uint32' | '<data type expression>'

Default: 'Inherit: Inherit via internal rule'

Block Characteristics

| | |
|---------------------------------|------------------|
| Data Types | integer string |
| Direct Feedthrough | yes |
| Multidimensional Signals | no |
| Variable-Size Signals | no |
| Zero-Crossing Detection | no |

Extended Capabilities

C/C++ Code Generation

Generate C and C++ code using Simulink® Coder™.

See Also

[ASCII to String](#) | [Compose String](#) | [Scan String](#) | [String Concatenate](#) | [String Constant](#) | [String Contains](#) | [String Find](#) | [String Length](#) | [String to Double](#) | [String to Single](#) | [String to Enum](#) | [String to ASCII](#) | [Substring](#) | [To String](#)

Topics

“Simulink Strings”

Introduced in R2020a

String Find

Return index of first occurrence of pattern string

Library: Simulink / String

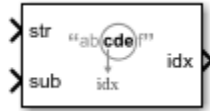

Description

The String Find block returns the index of the first occurrence of the pattern string **sub** in the text string **str**.

Ports

Input

str — String in which to find pattern

scalar

String in which to find pattern (**sub**), specified as a scalar.

Data Types: `string`

sub — Pattern

scalar

Pattern to be found in string (**str**), specified as a scalar.

Data Types: `string`

Output

idx — Position index of found pattern

scalar

Position index of the found pattern, specified as a positive integer scalar.

- If the block does not find the pattern, it returns -1.
- If the **sub** parameter is empty (""), the block returns 1, indicating that it matched the beginning of the searched string.

Data Types: `int8` | `int16` | `int32`

Parameters

Output data type — Output data type

Inherit: `Inherit via internal rule (default)` | Inherit: `Inherit via back propagation` | `int8` | `int16` | `int32` | `<data type expression>`

Output data type. The type can be inherited, specified directly, or expressed as a data type object such as `Simulink.NumericType`.

When you select an inherited option, the block exhibits these behaviors:

- **Inherit: Inherit via internal rule** — Simulink chooses a data type to balance numerical accuracy, performance, and generated code size, while taking into account the properties of the embedded target hardware.
- **Inherit: Inherit via back propagation** — Use data type of the driving block.

Click the **Show data type assistant** button  to display the **Data Type Assistant**, which helps you set the data type attributes. See “Specify Data Types Using Data Type Assistant” in the *Simulink User's Guide* for more information.

Programmatic Use

Block Parameter: `OutDataTypeStr`

Type: character vector

Values: `'Inherit: Inherit via internal rule' | 'Inherit: Inherit via back propagation' | 'int8' | 'int16' | 'int32' | '<data type expression>'`

Default: `'Inherit: Inherit via internal rule'`

Block Characteristics

| | |
|---------------------------------|-------------------------------|
| Data Types | <code>integer string</code> |
| Direct Feedthrough | <code>yes</code> |
| Multidimensional Signals | <code>no</code> |
| Variable-Size Signals | <code>no</code> |
| Zero-Crossing Detection | <code>no</code> |

Extended Capabilities

C/C++ Code Generation

Generate C and C++ code using Simulink® Coder™.

See Also

[Compose String](#) | [Scan String](#) | [String Compare](#) | [String Concatenate](#) | [String Constant](#) | [String Find](#) | [String Length](#) | [String to Double](#) | [String to Single](#) | [String to Enum](#) | [String to ASCII](#) | [Substring](#) | [ToString](#)

Topics

“Find Patterns in Strings”

“Simulink Strings”

Introduced in R2018a

String Length

Output number of characters in input string

Library: Simulink / String



Description

The String Length block outputs the number of characters in the input string. For example, you can use the String Length block to move focus of attention to a particular location in a string.

Ports

Input

Port_1 — Input string

scalar

Input string, specified as a scalar.

Data Types: `string`

Output

Port_1 — Number of characters

scalar

Number of characters in the input string, specified as a scalar.

Data Types: `int8` | `uint8` | `int16` | `uint16` | `int32` | `uint32`

Parameters

Output data type — Output data type

Inherit: `Inherit via internal rule (default)` | `Inherit via back propagation` | `int8` | `uint8` | `int16` | `uint16` | `int32` | `uint32` | `<data type expression>`

Output data type. The type can be inherited, specified directly, or expressed as a data type object such as `Simulink.NumericType`.

When you select an inherited option, the block exhibits these behaviors:

- `Inherit: Inherit via internal rule` — Simulink chooses a data type to balance numerical accuracy, performance, and generated code size, while taking into account the properties of the embedded target hardware.
- `Inherit: Inherit via back propagation` — Use data type of the driving block.

Click the **Show data type assistant** button  to display the **Data Type Assistant**, which helps you set the data type attributes. See “Specify Data Types Using Data Type Assistant” in the *Simulink User's Guide* for more information.

Programmatic Use

Block Parameter: OutDataTypeStr

Type: character vector

Values: 'Inherit: Inherit via internal rule' | 'Inherit: Inherit via back propagation' | 'int8' | 'uint8' | 'int16' | 'uint16' | 'int32' | 'uint32' | '<data type expression>'

Default: 'Inherit: Inherit via internal rule'

Block Characteristics

| | |
|---------------------------------|------------------|
| Data Types | integer string |
| Direct Feedthrough | yes |
| Multidimensional Signals | no |
| Variable-Size Signals | no |
| Zero-Crossing Detection | no |

Extended Capabilities

C/C++ Code Generation

Generate C and C++ code using Simulink® Coder™.

See Also

Compose String | Scan String | String Compare | String Concatenate | String Constant | String Find | String to Double | String to Enum | String to Single | String to ASCII | Substring | To String

Topics

“Get Text Following a Keyword”
 “Simulink Strings”

Introduced in R2018a

String to ASCII

Convert string signal to uint8 vector

Library: Simulink / String

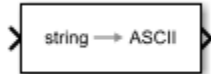

Description

The String To ASCII block converts a string signal to a uint8 vector. The block converts each character in the string to its corresponding ASCII value. For example, the block converts the input string "Hello" to [72 101 108 108 111].

Ports

Input

Port_1 — Input string signal

scalar

Input string signal, specified as a scalar.

Data Types: string

Output

Port_1 — Converted uint8 vector signal

vector

Converted uint8 vector signal of ASCII characters from input string signal, specified as a vector. The block converts each element in the string into its ASCII character equivalent and outputs the ASCII equivalents as a vector. If there are fewer characters than the maximum length, the block fills the remaining space with zeros at simulation. At code generation, the block fills the remaining space with null characters.

Data Types: uint8

Parameters

Output vector size — Size of output vector

31 (default) | scalar

Size of output string vector, specified as a scalar.

Block Characteristics

| | |
|---------------------------|------------------|
| Data Types | integer string |
| Direct Feedthrough | yes |

| | |
|---------------------------------|----|
| Multidimensional Signals | no |
| Variable-Size Signals | no |
| Zero-Crossing Detection | no |

Extended Capabilities

C/C++ Code Generation

Generate C and C++ code using Simulink® Coder™.

See Also

ASCII to String | Compose String | Scan String | String Compare | String Concatenate | String Constant | String Find | String Length | String to Double | String to Single | String to Enum | Substring | To String

Topics

“Convert String to ASCII and Back to String”
“Simulink Strings”

Introduced in R2018a

String to Double

Convert string signal to double signal

Library: Simulink / String

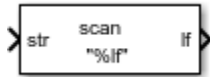

Description

Scan String scans an input string and converts it to signals per the format specified by the **Format** parameter. The block converts values to their decimal (base 10) representation and outputs the results as numeric or string signals. For example, if the **Format** parameter is set to "%s is %f.", the block outputs two parts, a string signal and a single signal. If the input is the string "Pi is 3.14", the two outputs are "Pi" and "3.14".

The Scan String, String to Double, and String to Single blocks are identical blocks. When configured for String to Double, the block converts the input string signal to a double numerical output. When configured for String to Single, the block converts the input string signal to a single numerical output.

For code generation, configure models that contain this block for non-finite number support by selecting the **Configuration Parameters > Code Generation > Interface > Support non-finite numbers** check box.

Ports

Input

Port_1 — Input string

scalar

Input string, specified as a scalar.

Data Types: `string`

Output

d — Output data whose format matches %d format

scalar

Output data whose format matches specified format, defined as a scalar. Total maximum number of outputs is 128.

If the block cannot match an input string to a format operator specified in **Format**, it returns a warning and outputs an appropriate value (0 or "") for each unmatched format operator.

Data Types: `single` | `double` | `int8` | `int16` | `int32` | `uint8` | `uint16` | `uint32` | `Boolean` | `fixed point` | `enumerated` | `bus`

f — Output data whose format matches %f format

scalar

Output data whose format matches the %f format, specified as a scalar. Total maximum number of outputs is 128.

Data Types: single | double | int8 | int16 | int32 | uint8 | uint16 | uint32 | Boolean | fixed point | enumerated | bus

Port_N — Output data whose format matches N format

scalar

Output data whose format matches *N* format, specified as a scalar. Total maximum number of outputs is 128.

Data Types: single | double | int8 | int16 | int32 | uint8 | uint16 | uint32 | Boolean | fixed point | enumerated | bus

Parameters

Format — Format operator for input

"%lf" (default) | scalar

Format operator for input, specified as a scalar. If the block cannot match the input string with the specified format, it returns 0. The return of 0 differs from the `sscanf` function return, which is an empty matrix if the function cannot match the input with the specified format.

- For the String to Double block, this parameter has a default value of %lf.
- For the String to Single block, this parameter has a default value of %f.

For more information about acceptable format operators, see the Algorithms section.

Block Characteristics

| | |
|---------------------------------|------------------------------------|
| Data Types | double integer single string |
| Direct Feedthrough | yes |
| Multidimensional Signals | no |
| Variable-Size Signals | no |
| Zero-Crossing Detection | no |

Algorithms

The Scan String block uses this format specifier prototype:

%[width][length]specifier

Numeric Fields

This table lists available conversion specifiers to convert text to numeric outputs. The block converts values to their decimal (base 10) representation.

| Output Port Data Type | Conversion Specifier | Description |
|-----------------------|----------------------|---|
| Integer, signed | %d | Base 10 |
| Integer, unsigned | %u | Base 10 |
| Floating-point number | %f, %e, or %g | Floating-point values. Input fields can contain NaN (case sensitive). Input fields that represents floating-point numbers can include leading + or - symbols and exponential notation using e or E. The conversion specifiers %f, %e, and %g all treat input fields the same way. |

Character Fields

This table lists available conversion specifiers to convert text so that the output is a character array.

| Character Field Type | Conversion Specifier | Description |
|----------------------|----------------------|---|
| String scalar | %s | Read the text until the block encounters whitespace. |
| | %c | Read any single character, including whitespace. To read multiple characters at a time, specify field width. For example, %10c reads 10 characters at a time. |
| Pattern-matching | %[...] | Read only characters in the brackets up to the first nonmatching character or whitespace. Example: %[mus] reads 'summer' as 'summ'. |
| | %[^...] | Read any characters not in the brackets up to the first matching character or whitespace. Example: %[^m] reads 'summer' as 'su'. |

Optional Operators

- **Field Width** — To specify the maximum number of digits or text characters to read at a time, insert a number after the percent character. For example, %10s reads up to 10 characters at a time, including whitespace. %4f reads up to four digits at a time, including the decimal point.
- **Literal Text to Ignore** — This block must match the specified text immediately before or after the conversion specifier.

Example: Hell%s reads "Hello!" as "o!".

Length Specifiers

The Scan String block supports the h and l length subspecifiers. These specifiers can change according to the **Configuration Parameters > Hardware Implementation > Number of bits** settings.

| Length | i | u | f e g | s c |
|---------------------|-------|----------------|--------|--------|
| No length specifier | int | unsigned int | single | string |
| h | short | unsigned short | — | — |
| l | long | unsigned long | double | — |

Notes for Specifiers that Specify Integer Data Types (d, u)

- Target int, long, short type sizes are controlled by settings in the **Configuration Parameters > Hardware Implementation** pane. For example, if the target int is 32 bits and the specifier is %u, then the expected input type will be uint32. For this example, the Scan String block requires that the output type be exactly int32. It cannot be any other data type.

Extended Capabilities

C/C++ Code Generation

Generate C and C++ code using Simulink® Coder™.

See Also

sscanf | ASCII to String | Compose String | Scan String | String Compare | String Concatenate | String Constant | String Find | String Length | String to Enum | String to ASCII | String to Single | Substring | To String

Topics

“Display and Extract Coordinate Data”
 “Simulink Strings”

Introduced in R2018a

String to Enum

Input string signal to enumerated signal

Library: Simulink / String

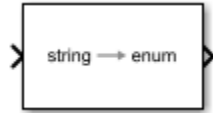

Description

The String To Enum block converts the input string signal to an enumerated signal. To use this block, create an enumeration class in the current folder and use that class name in the **Output data type** parameter.

Ports

Input

Port_1 — Input string signal

scalar

Input string signal, specified as a scalar.

Data Types: string

Output

Output 1 — Enumerated number

scalar

Enumerated number associated with the input string, specified as a scalar.

Data Types: enumerated

Parameters

Output data type — Output data type

SlDemoSign (default) | <data type expression>

Use a data type object, for example, Simulink.IntEnumType.

Click the **Show data type assistant** button  to display the **Data Type Assistant**, which helps you set the data type attributes. See “Specify Data Types Using Data Type Assistant” in the *Simulink User's Guide* for more information.

Mode — Category of data

Enumerated (default) | <data type expression>

Use a data type object, for example, Simulink.IntEnumType.

- Enumerated — Enumerated data class object.
- `<data type expression>` — Expressions that evaluate to data types. Selecting `Expression` enables a second menu/text box to the right, where you can enter the expression.

Dependency

Clicking the **Show data type assistant** button enables this parameter.

Block Characteristics

| | |
|---------------------------------|---------------------|
| Data Types | enumerated string |
| Direct Feedthrough | yes |
| Multidimensional Signals | no |
| Variable-Size Signals | no |
| Zero-Crossing Detection | no |

Extended Capabilities

C/C++ Code Generation

Generate C and C++ code using Simulink® Coder™.

See Also

[ASCII to String](#) | [Compose String](#) | [Scan String](#) | [String Compare](#) | [String Concatenate](#) | [String Constant](#) | [String Find](#) | [String Length](#) | [String to Single](#) | [String to Double](#) | [String To ASCII](#) | [Substring](#) | [To String](#)

Topics

“Convert String to Enumerated Data Type”
 “Simulink Strings”

Introduced in R2018a

String to Single

Convert string signal to single signal

Library: Simulink / String

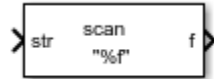

Description

Scan String scans an input string and converts it to signals per the format specified by the **Format** parameter. The block converts values to their decimal (base 10) representation and outputs the results as numeric or string signals. For example, if the **Format** parameter is set to "%s is %f.", the block outputs two parts, a string signal and a single signal. If the input is the string "Pi is 3.14", the two outputs are "Pi" and "3.14".

The Scan String, String to Double, and String to Single blocks are identical blocks. When configured for String to Double, the block converts the input string signal to a double numerical output. When configured for String to Single, the block converts the input string signal to a single numerical output.

For code generation, configure models that contain this block for non-finite number support by selecting the **Configuration Parameters > Code Generation > Interface > Support non-finite numbers** check box.

Ports

Input

Port_1 — Input string

scalar

Input string, specified as a scalar.

Data Types: `string`

Output

d — Output data whose format matches %d format

scalar

Output data whose format matches specified format, defined as a scalar. Total maximum number of outputs is 128.

If the block cannot match an input string to a format operator specified in **Format**, it returns a warning and outputs an appropriate value (0 or "") for each unmatched format operator.

Data Types: `single` | `double` | `int8` | `int16` | `int32` | `uint8` | `uint16` | `uint32` | `Boolean` | `fixed point` | `enumerated` | `bus`

f — Output data whose format matches %f format

scalar

Output data whose format matches the %f format, specified as a scalar. Total maximum number of outputs is 128.

Data Types: single | double | int8 | int16 | int32 | uint8 | uint16 | uint32 | Boolean | fixed point | enumerated | bus

Port_N — Output data whose format matches N format

scalar

Output data whose format matches *N* format, specified as a scalar. Total maximum number of outputs is 128.

Data Types: single | double | int8 | int16 | int32 | uint8 | uint16 | uint32 | Boolean | fixed point | enumerated | bus

Parameters

Format — Format operator for input

"%f" (default) | scalar

Format operator for input, specified as a scalar. If the block cannot match the input string with the specified format, it returns 0. The return of 0 differs from the `sscanf` function return, which is an empty matrix if the function cannot match the input with the specified format.

- For the String to Double block, this parameter has a default value of %lf.
- For the String to Single block, this parameter has a default value of %f.

For more information about acceptable format operators, see the Algorithms section.

Block Characteristics

| | |
|---------------------------------|------------------------------------|
| Data Types | double integer single string |
| Direct Feedthrough | yes |
| Multidimensional Signals | no |
| Variable-Size Signals | no |
| Zero-Crossing Detection | no |

Algorithms

The Scan String block uses this format specifier prototype:

%[width][length]specifier

Numeric Fields

This table lists available conversion specifiers to convert text to numeric outputs. The block converts values to their decimal (base 10) representation.

| Output Port Data Type | Conversion Specifier | Description |
|-----------------------|----------------------|---|
| Integer, signed | %d | Base 10 |
| Integer, unsigned | %u | Base 10 |
| Floating-point number | %f, %e, or %g | Floating-point values. Input fields can contain NaN (case sensitive). Input fields that represents floating-point numbers can include leading + or - symbols and exponential notation using e or E. The conversion specifiers %f, %e, and %g all treat input fields the same way. |

Character Fields

This table lists available conversion specifiers to convert text so that the output is a character array.

| Character Field Type | Conversion Specifier | Description |
|----------------------|----------------------|---|
| String scalar | %s | Read the text until the block encounters whitespace. |
| | %c | Read any single character, including whitespace. To read multiple characters at a time, specify field width. For example, %10c reads 10 characters at a time. |
| Pattern-matching | %[...] | Read only characters in the brackets up to the first nonmatching character or whitespace. Example: %[mus] reads 'summer' as 'summ'. |
| | %[^...] | Read any characters not in the brackets up to the first matching character or whitespace. Example: %[^m] reads 'summer' as 'su'. |

Optional Operators

- **Field Width** — To specify the maximum number of digits or text characters to read at a time, insert a number after the percent character. For example, %10s reads up to 10 characters at a time, including whitespace. %4f reads up to four digits at a time, including the decimal point.
- **Literal Text to Ignore** — This block must match the specified text immediately before or after the conversion specifier.

Example: Hell%s reads "Hello!" as "o!".

Length Specifiers

The Scan String block supports the h and l length subspecifiers. These specifiers can change according to the **Configuration Parameters > Hardware Implementation > Number of bits** settings.

| Length | i | u | f e g | s c |
|---------------------|-------|----------------|--------|--------|
| No length specifier | int | unsigned int | single | string |
| h | short | unsigned short | — | — |
| l | long | unsigned long | double | — |

Notes for Specifiers that Specify Integer Data Types (d, u)

- Target int, long, short type sizes are controlled by settings in the **Configuration Parameters > Hardware Implementation** pane. For example, if the target int is 32 bits and the specifier is %u, then the expected input type will be uint32. For this example, the Scan String block requires that the output type be exactly int32. It cannot be any other data type.

Extended Capabilities

C/C++ Code Generation

Generate C and C++ code using Simulink® Coder™.

See Also

sscanf | ASCII to String | Compose String | Scan String | String Compare | String Concatenate | String Constant | String Find | String Length | String to ASCII | String to Double | String to Enum | Substring | To String

Topics

“Display and Extract Coordinate Data”
 “Simulink Strings”

Introduced in R2018a

Substring

Extract substring from input string signal

Library: Simulink / String



Description

The Substring block extracts a substring from the input string signal. The block extracts the substring starting from the letter corresponding to **idx** and includes a **len** number of characters starting at **idx**. For example, if the input string is "hello 123", input **idx** is 1, and input **len** is 5, the output is "hello". The block extracts a substring starting at 1 and the next 4 characters for a total of 5 characters (hello).

Ports

Input

str — Input string signal

scalar

Input string signal, specified as a string.

Data Types: `string`

idx — Start of string to extract

scalar

Start of string to extract, specified as a positive scalar integer.

Data Types: `int8` | `int16` | `int32` | `uint8` | `uint16` | `uint32`

len — Length of string to extract

scalar

Length of string to extract, specified as a scalar. If **len** causes the substring to extend beyond the end of the string, the output signal contains fewer than **len** characters.

Data Types: `uint8` | `uint16` | `uint32`

Output

sub — Extracted string

scalar

Extracted string, specified as a scalar.

Data Types: `string`

Parameters

Inherit maximum length from input — Use same maximum length as input string

on (default) | off

Use same maximum length as the input string source block.

on

Use same maximum length. The substring includes the characters starting from the character at **idx** to the end of the string.

off

Do not use same maximum length.

Dependencies

Selecting this check box enables the **Output data type** parameter.

Output data type — Output data type

string (default) | <data type expression> | scalar

Output data type, specified using the string data type to specify a string with no maximum length.

To specify a string data type with a maximum length, specify `stringtype(N)`. For example, `stringtype(31)` creates a string data type with a maximum length of 31 characters.

Click the **Show data type assistant** button  to display the **Data Type Assistant**, which helps you set the data type attributes. See “Specify Data Types Using Data Type Assistant” in the *Simulink User's Guide* for more information.

Dependencies

To enable this parameter, select **Inherit maximum length from input**.

Output string from 'idx' to end — Extract string from idx to end

off (default) | on

Extract string from `idx` to end of input string.

on

Extract string from `idx` to end of input string.

off

Do not extract string from `idx` to end of input string.

Dependencies

Selecting this parameter removes the third input port.

Block Characteristics

| | |
|---------------------------------|------------------|
| Data Types | integer string |
| Direct Feedthrough | yes |
| Multidimensional Signals | no |
| Variable-Size Signals | no |
| Zero-Crossing Detection | no |

Extended Capabilities

C/C++ Code Generation

Generate C and C++ code using Simulink® Coder™.

See Also

[ASCII to String](#) | [Compose String](#) | [Scan String](#) | [String Compare](#) | [String Concatenate](#) | [String Constant](#) | [String Find](#) | [String Length](#) | [String to Double](#) | [String to Single](#) | [String to Enum](#) | [String to ASCII](#) | [To String](#)

Topics

[“Extract a String”](#)
[“Simulink Strings”](#)

Introduced in R2018a

Subsystem, Atomic Subsystem, CodeReuse Subsystem

Group blocks to create model hierarchy

Library: Simulink / Ports & Subsystems



Description

A Subsystem block contains a subset of blocks within a model or system. The Subsystem block can represent a virtual subsystem or a nonvirtual subsystem.

- Nonvirtual subsystem - Control when the contents of the subsystem are evaluated as a single unit (atomic execution). Create conditionally executed subsystems that run only when an event occurs on a triggering, function-call, action, or enabling input (see “Conditionally Executed Subsystems and Models”).
- Virtual subsystem - Subsystem is neither conditionally nor atomically executed. Virtual subsystems do not have checksums. To determine if a subsystem is virtual, use the `get_param` function for the Boolean block parameter `IsSubsystemVirtual`.

An atomic subsystem is a Subsystem block with the block parameter **Treat as atomic unit** selected.

A code reuse subsystem is a Subsystem block with the parameter **Treat as atomic unit** selected and the parameter **Function packaging** set to `Reusable` function, specifying the function code generation format for the subsystem.

To create a subsystem, do one of the following:

- Copy a Subsystem block from the Ports & Subsystems library into your model. Then add blocks to the subsystem by opening the Subsystem block and copying blocks into it.
- Select all blocks and lines that make up the subsystem, and then in the **Multiple** tab, click **Create Subsystem**. Simulink replaces the blocks with a Subsystem block, along with the necessary Inport and Outport blocks to reflect signals entering and leaving the subsystem.

The number of input ports drawn on the Subsystem block icon corresponds to the number of Inport blocks in the subsystem. Similarly, the number of output ports drawn on the block corresponds to the number of Outport blocks in the subsystem.

The Subsystem block supports signal label propagation through subsystem Inport and Outport blocks.

Note A referenced subsystem is a subsystem stored in a separate file that is referenced using a Subsystem Reference block. To reuse that subsystem, add multiple Subsystem Reference blocks that reference that same subsystem file. A referenced subsystem behaves identically to a regular subsystem during run-time.

Ports

Input

In — Signal input to a subsystem

scalar | vector | matrix

Placing an Inport block in a subsystem adds an external input port to the Subsystem block. The port label matches the name of the Inport block.

Use Inport blocks to get signals from the local environment.

Data Types: half | single | double | int8 | int16 | int32 | int64 | uint8 | uint16 | uint32 | uint64 | Boolean | fixed point | enumerated | bus

Output

Out — Signal output from a subsystem

scalar | vector | matrix

Placing an Outport block in a subsystem adds an output port from the Subsystem block. The port label on the Subsystem block is the name of the Outport block.

Use Outport blocks to send signals to the local environment.

Data Types: half | single | double | int8 | int16 | int32 | int64 | uint8 | uint16 | uint32 | uint64 | Boolean | fixed point | enumerated | bus

Parameters

Parameters on the Code Generation tab require a Simulink Coder or Embedded Coder license.

Main

Show port labels — Display options for port labels

FromPortIcon (default) | FromPortBlockName | SignalName

Select how to display port labels on the Subsystem block icon.

none

Do not display port labels.

FromPortIcon

If the corresponding port icon displays a signal name, display the signal name on the Subsystem block. Otherwise, display the port block name or the port number if the block name is a default name.

FromPortBlockName

Display the name of the corresponding port block on the Subsystem block.

SignalName

If the signal connected to the port is named, display the name of the signal on the Subsystem block. Otherwise, display the name of the corresponding port block.

For port label editing on Subsystem blocks, see “Edit Port Labels on Subsystems”.

Programmatic Use**Parameter:** ShowPortLabels**Type:** character vector**Value:** 'FromPortIcon' | 'FromPortBlockName' | 'SignalName'**Default:** 'FromPortIcon'**Read/Write permissions — Levels of access to contents of subsystem**

ReadWrite (default) | ReadOnly | NoReadOrWrite

Control user access to the contents of the subsystem.

ReadWrite

Enable opening and modification of subsystem contents.

ReadOnly

Enable opening but not modification of the subsystem. If the subsystem resides in a block library, you can create and open links to the subsystem and can make and modify local copies of the subsystem but cannot change the permissions or modify the contents of the original library instance.

NoReadOrWrite

Disable opening or modification of subsystem. If the subsystem resides in a library, you can create links to the subsystem in a model but cannot open, modify, change permissions, or create local copies of the subsystem.

Note You do not receive a response if you attempt to view the contents of a subsystem whose **Read/Write permissions** parameter is set to **NoReadOrWrite**. For example, when double-clicking such a subsystem, Simulink does not open the subsystem and does not display any messages.

Programmatic Use**Parameter:** Permissions**Type:** character vector**Value:** 'ReadWrite' | 'ReadOnly' | 'NoReadOrWrite'**Default:** 'ReadWrite'**Name of error callback function — Name of function to be called if error occurs**

'' (default) | function name

Enter name of a function to be called if an error occurs while Simulink is executing the subsystem.

Simulink passes two arguments to the function: the handle of the subsystem and a character vector that specifies the error type. If no function is specified, Simulink displays a generic error message if executing the subsystem causes an error.

Programmatic Use**Parameter:** ErrorFcn**Type:** character vector**Value:** '' | '<function name>'**Default:** ''**Permit hierarchical resolution — Resolution for workspace variable names**

All (default) | ExplicitOnly | None

Select whether to resolve names of workspace variables referenced by this subsystem.

For more information, see “Symbol Resolution” and “Symbol Resolution Process”.

All

Resolve all names of workspace variables used by this subsystem, including those used to specify block parameter values and Simulink data objects (for example, `Simulink.Signal` objects).

ExplicitOnly

Resolve only names of workspace variables used to specify block parameter values, data store memory (where no block exists), signals, and states marked as “must resolve”.

None

Do not resolve any workspace variable names.

Programmatic Use

Parameter: `PermitHierarchicalResolution`

Type: character vector

Value: 'All' | 'ExplicitOnly' | 'None'

Default: 'All'

Treat as atomic unit — Option to execute subsystem as one unit

off (default) | on

Causes Simulink to treat the subsystem as a unit when determining the execution order of block methods.

off

Treat all blocks in the subsystem as being at the same level in the model hierarchy as the subsystem when determining block method execution order. This can cause execution of methods of blocks in the subsystem to be interleaved with execution of methods of blocks outside the subsystem.

on

Treat the subsystem as a unit when determining the execution order of block methods. For example, when it needs to compute the output of the subsystem, Simulink invokes the output methods of all the blocks in the subsystem before invoking the output methods of other blocks at the same level as the Subsystem block.

Programmatic Use

Parameter: `TreatAsAtomicUnit`

Type: character vector

Value: 'off' | 'on'

Default: 'off'

Minimize algebraic loop occurrences — Option to eliminate artificial algebraic loops

off (default) | on

Try to eliminate any artificial algebraic loops that include the atomic subsystem

off

Do not try to eliminate any artificial algebraic loops that include the atomic subsystem.

on

Try to eliminate any artificial algebraic loops that include the atomic subsystem.

Dependencies

To enable this parameter, select the **Treat as atomic unit** parameter.

Programmatic Use

Parameter: MinAlgLoopOccurrences

Type: character vector

Value: 'off' | 'on'

Default: 'off'

Schedule As — Type of scheduling

Sample Time (default) | Periodic Partition | Aperiodic Partition

Specify how to schedule the subsystem.

Sample time

Specify whether all blocks in this subsystem must run at the same rate or can run at different rates.

Periodic Partition

Schedule the subsystem as a periodic partition. Specify a partition name and a sample time corresponding to the rate at which the partition runs.

Aperiodic Partition

Schedule the subsystem as an aperiodic partition. Specify a partition name.

Dependencies

To enable this parameter, select the **Treat as atomic unit** parameter.

Programmatic Use

Parameter: ScheduleAs

Type: character vector

Value: 'SampleTime' | 'PeriodicPartition' | 'AperiodicPartition'

Default: 'SampleTime'

Partition Name — Name of partition

character vector

Specify name of the partition for the subsystem.

Dependencies

To enable this parameter, select the **Treat as atomic unit** parameter, and set **Schedule As** to Periodic Partition or Aperiodic Partition.

Programmatic Use

Parameter: PartitionName

Type: character vector

Value: ''

Default: ''

Sample time — Time interval

-1 (default) | [Ts 0]

Specify whether all blocks in this subsystem must run at the same rate or can run at different rates.

- If the blocks in the subsystem can run at different rates, specify the subsystem sample time as inherited (-1).
- If all blocks must run at the same rate, specify the sample time corresponding to this rate as the value of the **Sample time** parameter.
- If any of the blocks in the subsystem specify a different sample time (other than -1 or `inf`), Simulink displays an error message when you update or simulate the model. For example, suppose all the blocks in the subsystem must run 5 times a second. To ensure this, specify the sample time of the subsystem as 0.2. In this example, if any of the blocks in the subsystem specify a sample time other than 0.2, -1, or `inf`, Simulink displays an error when you update or simulate the model.

-1

Specify inherited sample time. Use this sample time if the blocks in the subsystem can run at different rates.

[Ts 0]

Specify periodic sample time.

Dependencies

To enable this parameter, select the **Treat as atomic unit** parameter.

Programmatic Use

Parameter: SystemSampleTime

Type: character vector

Value: '-1' | '[Ts 0]'

Default: '-1'

Variant control — Variant control (condition) expression

Variant (default) | logical expression

Specify variant control (condition) expression that executes a variant Simulink Function block when the expression evaluates to `true`.

For more information, see `Simulink.Variant`.

Variant

Default name for a logical (Boolean) expression.

logical expression

A logical (Boolean) expression or a `Simulink.Variant` object representing a logical expression.

The function is activated when the expression evaluates to `true`.

If you want to generate code for your model, define the variables in the expression as `Simulink.Parameter` objects.

Dependencies

Enable this parameter by adding a Subsystem block inside a Variant Subsystem block.

Programmatic Use

Block parameter: VariantControl

Type: character vector

Value: 'Variant' | '<logical expression>'

Default: 'Variant'

Treat as grouped when propagating variant conditions — Option to treat subsystem as unit when propagating variant conditions

on (default) | off

Causes Simulink to treat the subsystem as a unit when propagating variant conditions from Variant Source blocks or to Variant Sink blocks.

on

Simulink treats the subsystem as a unit when propagating variant conditions from Variant Source blocks or to Variant Sink blocks. For example, when Simulink computes the variant condition of the subsystem, it propagates that condition to all the blocks in the subsystem.

off

Simulink treats all blocks in the subsystem as being at the same level in the model hierarchy as the subsystem itself when determining their variant condition.

Programmatic Use

Parameter: TreatAsGroupedWhenPropagatingVariantConditions

Type: character vector

Value: 'on' | 'off'

Default: 'on'

Code Generation

Function packaging — Code format

Auto (default) | Inline | Nonreusable function | Reusable function

Select the code format to be generated for an atomic (nonvirtual) subsystem.

Auto

Simulink Coder and Embedded Coder choose the optimal format for you based on the type and number of instances of the subsystem that exist in the model.

Inline

Simulink Coder and Embedded Coder inline the subsystem unconditionally.

Nonreusable function

If **Filename options** is set to Auto, Simulink Coder and Embedded Coder package separate functions in the model file. If **File name options** is set to Use subsystem name, Use function name, or User specified using different file names, Simulink Coder and Embedded Coder package separate functions in separate files.

Subsystems with this setting generate functions that might have arguments depending on the “Function interface” on page 1-0 parameter setting. You can name the generated function and file using parameters “Function name” on page 1-0 and “File name (no extension)” on page 1-0. These functions are not reentrant.

Reusable function

Simulink Coder and Embedded Coder generate a function with arguments that allows reuse of subsystem code when a model includes multiple instances of the subsystem.

This option also generates a function with arguments that allows subsystem code to be reused in the generated code of a model reference hierarchy that includes multiple instances of a subsystem across referenced models. In this case, the subsystem must be in a library.

For more information, see:

- “Control Generation of Functions for Subsystems” (Simulink Coder)
- “Generate Code and Executables for Individual Subsystems” (Simulink Coder)
- “Generate Inlined Subsystem Code” (Simulink Coder)
- “Generate Subsystem Code as Separate Function and Files” (Simulink Coder)
- “Generate Reusable Code from Library Subsystems Shared Across Models” (Simulink Coder)

Tips

- When you want multiple instances of a subsystem to be represented as one reusable function, you can designate each one of them as `Auto` or as `Reusable` function. It is best to use one or the other, as using both creates two reusable functions, one for each designation. The outcomes of these choices differ only when reuse is not possible. Selecting `Auto` does not allow control of the function or file name for the subsystem code.
- The `Reusable` function and `Auto` options both try to determine if multiple instances of a subsystem exist and if the code can be reused. The difference between the options' behavior is that when reuse is not possible:
 - `Auto` yields inlined code, or if circumstances prohibit inlining, separate functions for each subsystem instance.
 - `Reusable` function yields a separate function with arguments for each subsystem instance in the model.
- If you select `Reusable` function while your generated code is under source control, set **File name options** to `Use subsystem name`, `Use function name`, or `User specified`. Otherwise, the names of your code files change whenever you modify your model, which prevents source control on your files.
- If you select an option other than `Auto` or `Inline` and the model configuration parameter **States**, the code generator produces separate output and update methods. The code generator does not take into account the **Combine output and update methods for code generation and simulation** specification.

Dependencies

- This parameter requires Simulink Coder for code generation.
- To enable this parameter, select **Treat as atomic unit**.

Programmatic Use

Parameter: `RTWSystemCode`

Type: character vector

Value: `'Auto'` | `'Inline'` | `'Nonreusable function'` | `'Reusable function'`

Default: `'Auto'`

Function name options — How to name generated function

`Auto` (default) | `Use subsystem name` | `User specified`

Select how Simulink Coder names the function it generates for the subsystem.

If you have an Embedded Coder license, you can control function names with options on the Configuration Parameter **Code Generation > Identifiers** pane.

Auto

Assign a unique function name using the default naming convention, `model_subsystem()`, where `model` is the name of the model and `subsystem` is the name of the subsystem (or that of an identical one when code is being reused).

If you select `Reusable` function for the **Function packaging** parameter and there are multiple instances of the reusable subsystem in a model reference hierarchy, in order to generate reusable code for the subsystem, **Function name options** must be set to `Auto`.

Use subsystem name

Use the subsystem name as the function name. By default, the function name uses the naming convention `model_subsystem`.

Note When a subsystem is in a library block and the subsystem parameter “Function packaging” on page 1-0 is set to `Reusable` function, if you set the `Use subsystem name` option, the code generator uses the name of the library block for the subsystem function name and file name.

User specified

Enable the **Function name** field. Enter any legal C or C++ function name, which must be unique.

For more information, see “Control Generation of Functions for Subsystems” (Simulink Coder).

Dependencies

- This parameter requires a Simulink Coder license.
- To enable this parameter, set **Function packaging** to `Nonreusable` function or `Reusable` function.

Programmatic Use

Parameter: RTWFcnNameOpts

Type: character vector

Value: 'Auto' | 'Use subsystem name' | 'User specified'

Default: 'Auto'

Function name — Name of function for subsystem code

' ' (default) | function name

Specify a unique, valid C or C++ function name for subsystem code.

Use this parameter if you want to give the function a specific name instead of allowing the Simulink Coder code generator to assign its own autogenerated name or use the subsystem name. For more information, see “Control Generation of Functions for Subsystems” (Simulink Coder).

Dependencies

- This parameter requires a Simulink Coder license.
- To enable this parameter, set the **Function name options** parameter to `User specified`.

Programmatic Use**Parameter:** RTWFcnName**Type:** character vector**Value:** '' | '<function name>'**Default:** ''**File name options — How to name generated file**

Auto (default) | Use subsystem name | Use function name | User specified

Select how Simulink Coder names the separate file for the function it generates for the subsystem.

Auto

Depending on the configuration of the subsystem and how many instances are in the model, Auto yields different results:

- If the code generator does *not* generate a separate file for the subsystem, the subsystem code is generated within the code module generated from the subsystem parent system. If the subsystem parent is the model itself, the subsystem code is generated within *model.c* or *model.cpp*.
- If you select `Reusable function` for the **Function packaging** parameter and your generated code is under source control, consider specifying a **File name options** value other than Auto. This prevents the generated file name from changing due to unrelated model modifications, which is problematic for using source control to manage configurations.
- If you select `Reusable function` for the **Function packaging** parameter and there are multiple instances of the reusable subsystem in a model reference hierarchy, in order to generate reusable code for the subsystem, **File name options** must be set to Auto.

Use subsystem name

The code generator generates a separate file, using the subsystem (or library block) name as the file name.

Note When **File name options** is set to `Use subsystem name`, the subsystem file name is mangled if the model contains Model blocks, or if a model reference target is being generated for the model. In these situations, the file name for the subsystem consists of the subsystem name prefixed by the model name.

Use function name

The code generator uses the function name specified by **Function name options** as the file name.

User specified

This option enables the **File name (no extension)** text entry field. The code generator uses the name you enter as the file name. Enter any file name, but do not include the `.c` or `.cpp` (or any other) extension. This file name need not be unique.

Note While a subsystem source file name need not be unique, you must avoid giving nonunique names that result in cyclic dependencies (for example, `sys_a.h` includes `sys_b.h`, `sys_b.h` includes `sys_c.h`, and `sys_c.h` includes `sys_a.h`).

Dependencies

- This parameter requires a Simulink Coder license.
- To enable this parameter, set **Function packaging** to `Nonreusable function` or `Reusable function`.

Programmatic Use**Parameter:** RTWFileNameOpts**Type:** character vector**Value:** 'Auto' | 'Use subsystem name' | 'Use function name' | 'User specified'**Default:** 'Auto'**File name (no extension) – Name of generated file**

'' (default) | file name

The file name that you specify does not have to be unique. However, avoid giving non-unique names that result in cyclic dependencies (for example, `sys_a.h` includes `sys_b.h`, `sys_b.h` includes `sys_c.h`, and `sys_c.h` includes `sys_a.h`).

For more information, see “Control Generation of Functions for Subsystems” (Simulink Coder).

Dependencies

- This parameter requires a Simulink Coder license.
- To enable this parameter, set **File name options** to `User specified`.

Programmatic Use**Parameter:** RTWFileName**Type:** character vector**Value:** '' | '<file name>'**Default:** ''**Function interface – Select to use arguments with generate function**

`void_void` (default) | `Allow arguments (Optimized)` | `Allow arguments (Match graphical interface)`

Select to use arguments with generated function.

void_void

Generate a function without arguments and pass data as global variables. For example:

```
void subsystem_function(void)
```

Allow arguments (Optimized)

Generate a function that uses arguments instead of passing data as global variables. This specification reduces global RAM. It might reduce code size and improve execution speed and enable the code generator to apply additional optimizations. For example:

```
void subsystem_function(real_T rtu_In1, real_T rtu_In2,
                        real_T *rtu_Out1)
```

In some cases, when generating optimized code, the code generator might not generate a function that has arguments.

Allow arguments (Match graphical interface)

Generate a function interface that uses arguments that match the Subsystem graphical block interface. The generated function interface is predictable and does not change. A predictable

interface can be useful for debugging and testing your code and integrating with external applications. For example, if a model has two Inports and two Outports, then the generated function interface is:

```
void subsystem_function(real_T rtu_In1, real_T rtu_In2,
                      real_T *rty_Out1, real_T *rty_Out2)
```

For more information, see:

- “Reduce Global Variables in Nonreusable Subsystem Functions” (Embedded Coder)
- “Generate Predictable Function Interface to Match Graphical Block Interface” (Embedded Coder)
- “Generate Modular Function Code for Nonvirtual Subsystems” (Embedded Coder)

Dependencies

- This parameter requires Embedded Coder and an ERT-based system target file.
- To enable this parameter, set **Function packaging** to `Nonreusable function`.

Programmatic Use

Parameter: `FunctionInterfaceSpec`

Type: character vector

Value: `'void_void'` | `'Allow arguments (Optimized)'` | `'Allow arguments (Match graphical interface)'`

Default: `'void_void'`

Function with separate data — Control code generation for subsystem

`off` (default) | `on`

Generate subsystem function code in which the internal data for an atomic subsystem is separated from its parent model and is owned by the subsystem.

`off`

Do not generate subsystem function code in which the internal data for an atomic subsystem is separated from its parent model and is owned by the subsystem.

`on`

Generate subsystem function code in which the internal data for an atomic subsystem is separated from its parent model and is owned by the subsystem. The subsystem data structure is declared independently from the parent model data structures. A subsystem with separate data has its own block I/O and `DWork` data structure. As a result, the generated code for the subsystem is easier to trace and test. The data separation also tends to reduce the maximum size of global data structures throughout the model, because they are split into multiple data structures.

For details on how to generate modular function code for an atomic subsystem, see “Generate Modular Function Code for Nonvirtual Subsystems” (Embedded Coder).

For details on how to apply memory sections to atomic subsystems, see “Override Default Memory Placement for Subsystem Functions and Data” (Embedded Coder).

Dependencies

- This parameter requires a license for Embedded Coder and an ERT-based system target file.
- To enable this parameter, set **Function packaging** to `Nonreusable function`.

Programmatic Use**Parameter:** FunctionWithSeparateData**Type:** character vector**Value:** 'off' | 'on'**Default:** 'off'**Memory section for initialize/terminate functions — Select how to apply memory sections**`Inherit from model (default) | Default | The memory section of interest`

Select how Embedded Coder applies memory sections to the subsystem initialization and termination functions.

`Inherit from model`

Apply the root model memory sections to the subsystem function code

`Default`

Do not apply memory sections to the subsystem system code, overriding any model-level specification

`The memory section of interest`

Apply one of the model memory sections to the subsystem

Tips

- The possible values vary depending on what (if any) package of memory sections you have set for the model configuration. See “Control Data and Function Placement in Memory by Inserting Pragmas” (Embedded Coder) and “Model Configuration Parameters: Code Generation” (Simulink Coder).
- If you have not configured the model with a package, `Inherit from model` is the only value that appears. Otherwise, the list includes `Default` and all memory sections the model package contains.
- These options can be useful for overriding the model memory section settings for the given subsystem. For details on how to apply memory sections to atomic subsystems, see “Override Default Memory Placement for Subsystem Functions and Data” (Embedded Coder).

Dependencies

- This parameter requires a license for Embedded Coder software and an ERT-based system target file.
- To enable this parameter, set **Function packaging** to `Nonreusable function` or `Reusable function`.

Programmatic Use**Parameter:** RTWMemSecFuncInitTerm**Type:** character vector**Value:** 'Inherit from model' | 'Default' | 'The memory section of interest'**Default:** 'Inherit from model'**Memory section for execution functions — Select how to apply memory sections**`Inherit from model (default) | Default | The memory section of interest`

Select how Embedded Coder applies memory sections to the subsystem execution functions.

Inherit from model

Apply the root model memory sections to the subsystem function code

Default

Do not apply memory sections to the subsystem system code, overriding any model-level specification

The memory section of interest

Apply one of the model memory sections to the subsystem

Tips

- The possible values vary depending on what (if any) package of memory sections you have set for the model configuration. See “Control Data and Function Placement in Memory by Inserting Pragmas” (Embedded Coder) and “Model Configuration Parameters: Code Generation” (Simulink Coder).
- If you have not configured the model with a package, `Inherit from model` is the only value that appears. Otherwise, the list includes `Default` and all memory sections the model package contains.
- These options can be useful for overriding the model memory section settings for the given subsystem. For details on how to apply memory sections to atomic subsystems, see “Override Default Memory Placement for Subsystem Functions and Data” (Embedded Coder).

Dependencies

- This parameter requires a license for Embedded Coder software and an ERT-based system target file.
- To enable this parameter, set **Function packaging** to `Nonreusable function` or `Reusable function`.

Programmatic Use

Parameter: `RTWMemSecFuncExecute`

Type: character vector

Value: `'Inherit from model' | 'Default' | 'The memory section of interest'`

Default: `'Inherit from model'`

Memory section for constants — Select how to apply memory sections

`Inherit from model` (default) | `Default` | `The memory section of interest`

Select how Embedded Coder applies memory sections to the subsystem constants.

Inherit from model

Apply the root model memory sections to the subsystem data

Default

Not apply memory sections to the subsystem data, overriding any model-level specification

The memory section of interest

Apply one of the model memory sections to the subsystem

Tips

- The memory section that you specify applies to the corresponding global data structures in the generated code. For basic information about the global data structures generated for atomic subsystems, see “Standard Data Structures” (Simulink Coder).

- The possible values vary depending on what (if any) package of memory sections you have set for the model configuration. See “Control Data and Function Placement in Memory by Inserting Pragmas” (Embedded Coder).
- If you have not configured the model with a package, `Inherit from model` is the only value that appears. Otherwise, the list includes `Default` and all memory sections the model package contains.
- These options can be useful for overriding the model memory section settings for the given subsystem. For details on how to apply memory sections to atomic subsystems, see “Override Default Memory Placement for Subsystem Functions and Data” (Embedded Coder).

Dependencies

- This parameter requires a license for Embedded Coder and an ERT-based system target file.
- To enable this parameter, set **Function packaging** to `Nonreusable function` and select the **Function with separate data** parameter.

Programmatic Use

Parameter: `RTWMemSecDataConstants`

Type: character vector

Value: `'Inherit from model' | 'Default' | 'The memory section of interest'`

Default: `'Inherit from model'`

Memory section for internal data — Select how to apply memory sections

`Inherit from model` (default) | `Default` | `The memory section of interest`

Select how Embedded Coder applies memory sections to the subsystem internal data.

`Inherit from model`

Apply the root model memory sections to the subsystem data

`Default`

Not apply memory sections to the subsystem data, overriding any model-level specification

`The memory section of interest`

Apply one of the model memory sections to the subsystem

Tips

- The memory section that you specify applies to the corresponding global data structures in the generated code. For basic information about the global data structures generated for atomic subsystems, see “Standard Data Structures” (Simulink Coder).
- The possible values vary depending on what (if any) package of memory sections you have set for the model configuration. See “Control Data and Function Placement in Memory by Inserting Pragmas” (Embedded Coder).
- If you have not configured the model with a package, `Inherit from model` is the only value that appears. Otherwise, the list includes `Default` and all memory sections the model package contains.
- These options can be useful for overriding the model memory section settings for the given subsystem. For details on how to apply memory sections to atomic subsystems, see “Override Default Memory Placement for Subsystem Functions and Data” (Embedded Coder).

Dependencies

- This parameter requires a license for Embedded Coder and an ERT-based system target file.
- To enable this parameter, set **Function packaging** to `Nonreusable` function and select the **Function with separate data** parameter.

Programmatic Use**Parameter:** `RTWMemSecDataInternal`**Type:** character vector**Value:** `'Inherit from model' | 'Default' | 'The memory section of interest'`**Default:** `'Inherit from model'`**Memory section for parameters — Select how to apply memory sections**`Inherit from model (default) | Default | The memory section of interest`

Select how Embedded Coder applies memory sections to the subsystem parameters.

`Inherit from model`

Apply the root model memory sections to the subsystem function code

`Default`

Not apply memory sections to the subsystem system code, overriding any model-level specification

`The memory section of interest`

Apply one of the model memory sections to the subsystem

Tips

- The memory section that you specify applies to the corresponding global data structure in the generated code. For basic information about the global data structures generated for atomic subsystems, see “Standard Data Structures” (Simulink Coder).
- The possible values vary depending on what (if any) package of memory sections you have set for the model configuration. See “Control Data and Function Placement in Memory by Inserting Pragmas” (Embedded Coder).
- If you have not configured the model with a package, `Inherit from model` is the only value that appears. Otherwise, the list includes `Default` and all memory sections the model package contains.
- These options can be useful for overriding the model memory section settings for the given subsystem. For details on how to apply memory sections to atomic subsystems, see “Override Default Memory Placement for Subsystem Functions and Data” (Embedded Coder).

Dependencies

- This parameter requires a license for Embedded Coder and an ERT-based system target file.
- To enable this parameter, set **Function packaging** to `Nonreusable` function and select the **Function with separate data** parameter.

Programmatic Use**Parameter:** `RTWMemSecDataParameters`**Type:** character vector**Value:** `'Inherit from model' | 'Default' | 'The memory section of interest'`**Default:** `'Inherit from model'`

Subsystem Reference

Subsystem file name — File name for referenced subsystem

string | character vector

Dependencies

To access this parameter, click the **Convert** button.

For more information on how to convert a subsystem to a referenced subsystem, see “Convert an Existing Subsystem to a Referenced Subsystem”.

Block Characteristics

| | |
|---------------------------------|---|
| Data Types | Boolean ^a bus ^a double ^a enumerated ^a fixed point ^a half ^a integer ^a single ^a string ^a |
| Direct Feedthrough | no |
| Multidimensional Signals | limited ^a |
| Variable-Size Signals | limited ^a |
| Zero-Crossing Detection | no |

a. Actual data type or capability support depends on block implementation.

Extended Capabilities

C/C++ Code Generation

Generate C and C++ code using Simulink® Coder™.

Actual data type or capability support depends on block implementation.

HDL Code Generation

Generate Verilog and VHDL code for FPGA and ASIC designs using HDL Coder™.

HDL Coder provides additional configuration options that affect HDL implementation and synthesized logic.

HDL Architecture

| Architecture | Description |
|------------------|--|
| Module (default) | Generate code for the subsystem and the blocks within the subsystem. |
| BlackBox | Generate a black box interface. The generated HDL code includes only the input/output port definitions for the subsystem. Therefore, you can use a subsystem in your model to generate an interface to existing, manually written HDL code. The black-box interface generation for subsystems is similar to the Model block interface generation without the clock signals. |
| No HDL | Remove the subsystem from the generated code. You can use the subsystem in simulation, however, treat it as a “no-op” in the HDL code. |

Black Box Interface Customization

For the BlackBox architecture, you can customize port names and set attributes of the external component interface. See “Customize Black Box or HDL Cosimulation Interface” (HDL Coder).

HDL Block Properties

| General | |
|----------------------------------|--|
| AdaptivePipelining | Automatic pipeline insertion based on the synthesis tool, target frequency, and multiplier word-lengths. The default is <code>inherit</code> . See also “AdaptivePipelining” (HDL Coder). |
| BalanceDelays | Detects introduction of new delays along one path and inserts matching delays on the other paths. The default is <code>inherit</code> . See also “BalanceDelays” (HDL Coder). |
| ClockRatePipelining | Insert pipeline registers at a faster clock rate instead of the slower data rate. The default is <code>inherit</code> . See also “ClockRatePipelining” (HDL Coder). |
| ConstrainedOutputPipeline | Number of registers to place at the outputs by moving existing delays within your design. Distributed pipelining does not redistribute these registers. The default is 0. For more details, see “ConstrainedOutputPipeline” (HDL Coder). |
| DistributedPipelining | Pipeline register distribution, or register retiming. The default is <code>off</code> . See also “DistributedPipelining” (HDL Coder). |
| DSPStyle | Synthesis attributes for multiplier mapping. The default is <code>none</code> . See also “DSPStyle” (HDL Coder). |
| FlattenHierarchy | Remove subsystem hierarchy from generated HDL code. The default is <code>inherit</code> . See also “FlattenHierarchy” (HDL Coder). |
| InputPipeline | Number of input pipeline stages to insert in the generated code. Distributed pipelining and constrained output pipelining can move these registers. The default is 0. For more details, see “InputPipeline” (HDL Coder). |
| OutputPipeline | Number of output pipeline stages to insert in the generated code. Distributed pipelining and constrained output pipelining can move these registers. The default is 0. For more details, see “OutputPipeline” (HDL Coder). |
| SharingFactor | Number of functionally equivalent resources to map to a single shared resource. The default is 0. See also “Resource Sharing” (HDL Coder). |
| StreamingFactor | Number of parallel data paths, or vectors, that are time multiplexed to transform into serial, scalar data paths. The default is 0, which implements fully parallel data paths. See also “Streaming” (HDL Coder). |

If this block is not the DUT, the block property settings in the **Target Specification** tab are ignored. In the HDL Workflow Advisor, if you use the **IP Core Generation** workflow, these target specification block property values are saved with the model. If you specify these target specification block property values using `hdlset_param`, when you open HDL Workflow Advisor, the fields are populated with the corresponding values.

| Target Specification | |
|-------------------------------------|--|
| AdditionalTargetInterfaces | <p>Additional target interfaces, specified as a character vector.</p> <p>To save this block property on the model, in the Set Target Interface task of the IP Core Generation workflow, corresponding to the DUT ports that you want to add more interfaces, select Add more.... You can then add more interfaces in the Add New Target Interfaces dialog box. Specify the type of interface, number of additional interfaces, and a unique name for each additional interface.</p> <p>Values: ' ' (default) cell array of character vectors</p> <p>Example: '{{'AXI4-Stream', 'InterfaceID', 'AXI4-Stream1'}}'</p> |
| ProcessorFPGASynchronization | <p>Processor/FPGA synchronization mode, specified as a character vector.</p> <p>To save this block property on the model, specify the Processor/FPGA Synchronization in the Set Target Interface task of the IP Core Generation workflow.</p> <p>Values: Free running (default) Coprocessing - blocking</p> <p>Example: 'Free running'</p> |
| TestPointMapping | <p>To save this block property on the model, specify the mapping of test point ports to target platform interfaces in the Set Target Interface task of the IP Core Generation workflow.</p> <p>Values: ' ' (default) cell array of character vectors</p> <p>Example: '{{'TestPoint', 'AXI4-Lite', 'x"108"'}}'</p> |
| TunableParameterMapping | <p>To save this block property on the model, specify the mapping of tunable parameter ports to target platform interfaces in the Set Target Interface task of the IP Core Generation workflow.</p> <p>Values: ' ' (default) cell array of character vectors</p> <p>Example: '{{'myParam', 'AXI4-Lite', 'x"108"'}}'</p> |
| AXI4RegisterReadback | <p>To save this block property on the model, specify whether you want to enable readback on AXI4 subordinate write registers in the Generate RTL Code and IP Core task of the IP Core Generation workflow. To learn more, see "Model Design for AXI4 Slave Interface Generation" (HDL Coder).</p> <p>Values: 'off' (default) 'on'</p> |
| AXI4SlaveIDWidth | <p>To save this block property on the model, specify the number of AXI manager interfaces that you want to connect the DUT IP core to by using the AXI4 Slave ID Width setting in the Generate RTL Code and IP Core task of the IP Core Generation workflow. To learn more, see "Define Multiple AXI Master Interfaces in Reference Designs to access DUT AXI4 Slave Interface" (HDL Coder).</p> <p>Values: 'off' (default) 'on'</p> |

| Target Specification | |
|---|---|
| AXI4SlavePortToPipelineRegisterRatio | <p>To save this block property on the model, specify the number of AXI4 subordinate ports for which you want a pipeline register to be inserted by using the AXI4 Slave port to pipeline register ratio setting in the Generate RTL Code and IP Core task of the IP Core Generation workflow. To learn more, see “Model Design for AXI4 Slave Interface Generation” (HDL Coder).</p> <p>Values: 'off' (default) 'on'</p> |
| GenerateDefaultAXI4Slave | <p>To save this block property on the model, specify whether you want to disable generation of default AXI4 subordinate interfaces in the Generate RTL Code and IP Core task of the IP Core Generation workflow.</p> <p>Values: 'on' (default) 'off'</p> |
| IPCoreAdditionalFiles | <p>Verilog or VHDL files for black boxes in your design. Specify the full path to each file, and separate file names with a semicolon (;).</p> <p>You can set this property in the HDL Workflow Advisor, in the Additional source files field.</p> <p>Values: '' (default) character vector</p> <p>Example: 'C:\myprojfiles \led_blinking_file1.vhd;C:\myprojfiles \led_blinking_file2.vhd;'</p> |
| IPCoreName | <p>IP core name, specified as a character vector.</p> <p>You can set this property in the HDL Workflow Advisor, in the IP core name field. If this property is set to the default value, the HDL Workflow Advisor constructs the IP core name based on the name of the DUT.</p> <p>Values: '' (default) character vector</p> <p>Example: 'my_model_name'</p> |
| IPCoreVersion | <p>IP core version number, specified as a character vector.</p> <p>You can set this property in the HDL Workflow Advisor, in the IP core version field. If this property is set to the default value, the HDL Workflow Advisor sets the IP core version.</p> <p>Values: '' (default) character vector</p> <p>Example: '1.3'</p> |

| Target Specification | |
|---------------------------------|--|
| IPDataCaptureBuffer Size | <p>FPGA Data Capture buffer size, specified as a character vector. Use FPGA Data Capture to observe signals in a design when running on an FPGA.</p> <p>The buffer size uses values that are $128 \cdot 2^n$, where n is an integer. By default, the buffer size is 128 ($n=0$). The maximum value of n is 13, which means that the maximum value for buffer size is 1048576 ($=128 \cdot 2^{13}$).</p> <p>Values: ' ' (default) character vector</p> <p>Example: '1.3'</p> |

Restrictions

If your DUT is a masked subsystem, you can generate code only if it is at the top level of the model.

For more information, see:

- “External Component Interfaces” (HDL Coder)
- “Generate Black Box Interface for Subsystem” (HDL Coder)

PLC Code Generation

Generate Structured Text code using Simulink® PLC Coder™.

Fixed-Point Conversion

Design and simulate fixed-point systems using Fixed-Point Designer™.

Actual data type or capability support depends on block implementation.

See Also

Enabled Subsystem | Enabled and Triggered Subsystem | Triggered Subsystem | Function-Call Subsystem

Topics

“Create Subsystems”
 “Preview Content of Model Components”
 “Using Function-Call Subsystems”
 “Export-Function Models Overview”

Introduced in R2007a

Add, Subtract, Sum of Elements, Sum

Add or subtract inputs

Library: Simulink / Math Operations
HDL Coder / HDL Floating Point Operations
HDL Coder / Math Operations



Description

The Sum block performs addition or subtraction on its inputs. The Add, Subtract, Sum of Elements, and Sum blocks are identical blocks. This block can add or subtract scalar, vector, or matrix inputs. It can also collapse the elements of a signal and perform a summation.

You specify the operations of the block with the **List of signs** parameter with plus (+), minus (-), and spacer (|).

- The number of + and - characters equals the number of inputs. For example, +-+ requires three inputs. The block subtracts the second (middle) input from the first (top) input, and then adds the third (bottom) input.
- A spacer character creates extra space between ports on the block icon.
- If performing only addition, you can use a numerical value equal to the number of inputs.
- If only there is only one input port, a single + or - adds or subtracts the elements over all dimensions or in the specified dimension.

The Sum block first converts the input data type to its accumulator data type, then performs the specified operations. The block converts the result to its output data type using the specified rounding and overflow modes.

Calculation of Block Output

Output calculation for the Sum block depends on the number of block inputs and the sign of input ports:

| If the Sum block has... | And... | The formula for output calculation is... | Where... |
|-------------------------|----------------------------|---|---|
| One input port | The input port sign is + | $y = e[0] + e[1] + e[2] \dots + e[m]$ | $e[i]$ is the i^{th} element of input u |
| | The input port sign is - | $y = 0.0 - e[0] - e[1] - e[2] \dots - e[m]$ | |
| Two or more input ports | All input port signs are - | $y = 0.0 - u[0] - u[1] - u[2] \dots - u[n]$ | $u[i]$ is the input to the i^{th} input port |

| If the Sum block has... | And... | The formula for output calculation is... | Where... |
|-------------------------|--|--|----------|
| | The k^{th} input port is the first port where the sign is + | $y = u[k] - u[0] - u[1] - u[2] - u[k-1] (+/-) u[k+1] \dots (+/-) u[n]$ | |

Ports

Inputs

The inputs can be of different data types, unless you select the **Require all inputs to have the same data type** parameter.

Port_1 — First input operand signal

scalar | vector | matrix

Input signal to the addition or subtraction operation. If there is only one input signal, then addition or subtraction is performed on the elements over all dimensions or the specified dimension.

Data Types: half | single | double | int8 | int16 | int32 | int64 | uint8 | uint16 | uint32 | uint64 | Boolean | fixed point

Port_n — nth input operand signal

scalar | vector | matrix

nth input signal to the operations. The number of inputs matches the number of signs in the **List of signs** parameter. The block applies the operations to the inputs in the order listed. You can also use a numerical value equal to the number of input ports as the **List of signs** parameter. The block creates the input ports and applies addition to all inputs. For example, if you assign 5 for the **List of signs** parameter, the block creates 5 input ports and adds them together to produce the output.

All nonscalar inputs must have the same dimensions. Scalar inputs are expanded to have the same dimensions as other inputs.

Data Types: half | single | double | int8 | int16 | int32 | int64 | uint8 | uint16 | uint32 | uint64 | Boolean | fixed point

Output

Port_1 — Output signal

scalar | vector | matrix

Output signal resulting from addition and/or subtraction operations. The output signal has the same dimension as the input signals.

Data Types: half | single | double | int8 | int16 | int32 | int64 | uint8 | uint16 | uint32 | uint64 | Boolean | fixed point

Parameters

Main

Icon shape — Block icon shape

`rectangular` (default) | `round`

Designate the icon shape of the block as rectangular or round.

For a rectangular block, the first input port is the top port. For a round Sum block, the first input port is the port closest to the 12 o'clock position going in a counterclockwise direction around the block. Similarly, other input ports appear in counterclockwise order around the block.

Programmatic Use

Block Parameter: IconShape

Type: character vector

Values: 'rectangular' | 'round'

Default: 'round'

List of signs — Operations performed on inputs

`++` (default) | `+` | `-` | `|` | `integer`

Enter addition and subtraction operations performed on the inputs. An input port is created for each operation. A spacer (|) creates extra space between the input ports on the block icon. Addition is the default operation. If you only want to add the inputs, enter the number of input ports. The operations are performed in the order listed.

When you enter only one element, the block enables the **Sum over** parameter. For a single vector input, `+` or `-` adds or subtracts the elements over all dimensions or in the specified dimension.

Tips

You can manipulate the positions of the input ports on the block by inserting spacers (|) between the signs in the **List of signs** parameter. For example, `“++| - -”` creates an extra space between the second and third input ports.

Programmatic Use

Block Parameter: Inputs

Type: character vector

Values: '+' | '-' | '|' | integer

Default: '++'

Sum over — Dimensions for operations on a single vector input

`All dimensions` (default) | `Specified dimension`

Select the dimension over which the block performs the sum-over operation.

For **All dimensions**, all input elements are summed. When you select configuration parameter **Use algorithms optimized for row-major array layout**, Simulink enables row-major algorithms for simulation. To generate row-major code, set configuration parameter **Array layout** (Simulink Coder) to Row-major in addition to selecting **Use algorithms optimized for row-major array layout**. The column-major and row-major algorithms differ only in the summation order. In some cases, due to different operation order on the same data set, you might experience minor numeric differences in the outputs of column-major and row-major algorithms.

When you select **Specified dimensions**, another parameter **Dimension** appears. Choose the specific dimension for summing the vector input.

Dependency

Enabled when you list only one sign in the **List of signs** parameter.

Programmatic Use

Block Parameter: CollapseMode

Type: character vector

Values: 'All dimensions' | 'Specified dimension'

Default: 'All dimensions'

Dimension — Dimension for summation on vector input

1 (default) | integer

When you choose **Specified dimension** for the **Sum over** parameter, specify the dimension over which to perform the operation.

The block follows the same summation rules as the MATLAB `sum` function.

Suppose that you have a 2-by-3 matrix U .

- Setting **Dimension** to 1 results in the output Y being computed as:

$$Y = \sum_{i=1}^2 U(i, j)$$

- Setting **Dimension** to 2 results in the output Y being computed as:

$$Y = \sum_{j=1}^3 U(i, j)$$

If the specified dimension is greater than the dimension of the input, an error message appears.

Dependency

Enabled when you choose Specified dimension for the **Sum over** parameter.

Programmatic Use

Block Parameter: CollapseDim

Type: character vector

Value: integer

Default: '1'

Sample time — Specify sample time as a value other than -1

-1 (default) | scalar | vector

Specify the sample time as a value other than -1. For more information, see “Specify Sample Time”.

Dependencies

This parameter is not visible unless it is explicitly set to a value other than -1. To learn more, see “Blocks for Which Sample Time Is Not Recommended”.

Programmatic Use

Block Parameter: SampleTime

Type: character vector

Values: scalar or vector

Default: '- 1'

Signal Attributes

Click the **Show data type assistant** button  to display the **Data Type Assistant**, which helps you set the data type attributes. For more information, see “Specify Data Types Using Data Type Assistant”.

Require all inputs to have the same data type – Require that all inputs have the same data type

off (default) | on

Specify if input signals must all have the same data type. If you enable this parameter, then an error occurs during simulation if the input signal types are different.

Programmatic Use

Block Parameter: InputSameDT

Type: character vector

Values: 'off' | 'on'

Default: 'off'

Accumulator data type – Data type of the accumulator

Inherit: Inherit via internal rule (default) | Inherit: Same as first input | double | single | half | int8 | uint8 | int16 | uint16 | int32 | uint32 | int64 | uint64 | fixdt(1,16) | fixdt(1,16,0) | fixdt(1,16,2^0,0) | <data type expression>

Choose the data type of the accumulator. The type can be inherited, specified directly, or expressed as a data type object such as `Simulink.NumericType`. When you choose `Inherit: Inherit via internal rule`, Simulink chooses a data type to balance numerical accuracy, performance, and generated code size, while taking into account the properties of the embedded target hardware.

Programmatic Use

Block Parameter: AccumDataTypeStr

Type: character vector

Values: 'Inherit: Inherit via internal rule' | 'Inherit: Same as first input' | 'double' | 'single' | 'half' | 'int8' | 'uint8' | 'int16' | 'uint16' | 'int32' | 'uint32' | 'int64' | 'uint64' | 'fixdt(1,16)' | 'fixdt(1,16,0)' | 'fixdt(1,16,2^0,0)' | '<data type expression>'

Default: 'Inherit: Inherit via internal rule'

Output minimum – Minimum output value for range checking

[] (default) | scalar

Lower value of the output range that Simulink checks.

Simulink uses the minimum to perform:

- Parameter range checking (see “Specify Minimum and Maximum Values for Block Parameters”) for some blocks.
- Simulation range checking (see “Specify Signal Ranges” and “Enable Simulation Range Checking”).
- Automatic scaling of fixed-point data types.

- Optimization of the code that you generate from the model. This optimization can remove algorithmic code and affect the results of some simulation modes such as SIL or external mode. For more information, see “Optimize using the specified minimum and maximum values” (Embedded Coder).

Note Output minimum does not saturate or clip the actual output signal. Use the Saturation block instead.

Programmatic Use

Block Parameter: OutMin

Type: character vector

Values: ' [] ' | scalar

Default: ' [] '

Output maximum — Maximum output value for range checking

[] (default) | scalar

Upper value of the output range that Simulink checks.

Simulink uses the maximum value to perform:

- Parameter range checking (see “Specify Minimum and Maximum Values for Block Parameters”) for some blocks.
- Simulation range checking (see “Specify Signal Ranges” and “Enable Simulation Range Checking”).
- Automatic scaling of fixed-point data types.
- Optimization of the code that you generate from the model. This optimization can remove algorithmic code and affect the results of some simulation modes such as SIL or external mode. For more information, see “Optimize using the specified minimum and maximum values” (Embedded Coder).

Note Output maximum does not saturate or clip the actual output signal. Use the Saturation block instead.

Programmatic Use

Block Parameter: OutMax

Type: character vector

Values: ' [] ' | scalar

Default: ' [] '

Output data type — Specify the output data type

Inherit: Inherit via internal rule (default) | Inherit: Keep MSB | Inherit: Keep LSB | Inherit: Inherit via back propagation | Inherit: Same as first input | Inherit: Same as accumulator | double | single | half | int8 | uint8 | int16 | uint16 | int32 | uint32 | int64 | uint64 | fixdt(1,16) | fixdt(1,16,0) | fixdt(1,16,2^0,0) | <data type expression>

Choose the data type for the output. The type can be inherited, specified directly, or expressed as a data type object such as `Simulink.NumericType`.

When you select an inherited option, the block behaves as follows:

- **Inherit: Inherit via internal rule**—Simulink chooses a data type to balance numerical accuracy, performance, and generated code size, while taking into account the properties of the embedded target hardware.

Note The accumulator internal rule favors greater numerical accuracy, possibly at the cost of less efficient generated code. To get the same accuracy for the output, set the output data type to **Inherit: Inherit same as accumulator**.

Note When input is a floating-point data type smaller than single precision, the **Inherit: Inherit via internal rule** output data type depends on the setting of the “Inherit floating-point output type smaller than single precision” configuration parameter. Data types are smaller than single precision when the number of bits needed to encode the data type is less than the 32 bits needed to encode the single-precision data type. For example, `half` and `int16` are smaller than single precision.

- **Inherit: Keep MSB**— Simulink chooses a data type that maintains the full range of the operation, then reduces the precision of the output to a size appropriate for the embedded target hardware.

Tip For more efficient generated code, set the **Accumulator data type** to **Inherit: Inherit via internal rule**, and deselect the **Saturate on integer overflow** parameter.

This rule never produces overflows.

- **Inherit: Keep LSB**— Simulink chooses a data type that maintains the precision of the operation, but reduces the range if the full type does not fit on the embedded target hardware.

Tip For more efficient generated code, set the **Accumulator data type** to **Inherit: Inherit via internal rule**, and deselect the **Saturate on integer overflow** parameter.

This rule can produce overflows.

If you change the embedded target settings, the data type selected by these internal rules might change. It is not always possible for the software to optimize code efficiency and numerical accuracy at the same time. If the rules do not meet your specific needs for numerical accuracy or performance, use one of the following options:

- Specify the output data type explicitly.
- Use the simple choice of **Inherit: Same as first input**.
- Explicitly specify a default data type such as `fixdt(1,32,16)` and then use the Fixed-Point Tool to propose data types for your model. For more information, see `fxptdlg`.
- To specify your own inheritance rule, use **Inherit: Inherit via back propagation** and then use a Data Type Propagation block. Examples of how to use this block are available in the Signal Attributes library Data Type Propagation Examples block.
- **Inherit: Inherit via back propagation** — Use data type of the driving block.
- **Inherit: Same as first input** — Use data type of the first input signal.

- **Inherit:** Inherit same as accumulator— Use data type of the accumulator.

Programmatic Use**Block Parameter:** OutDataTypeStr**Type:** character vector

Values: 'Inherit: Inherit via internal rule'|'Inherit: Keep MSB'|'Inherit: Keep LSB'|'Inherit: Inherit via back propagation'|'Inherit: Same as first input'|'Inherit: Same as accumulator'|'double'|'single'|'half'|'int8'|'uint8'|'int16'|'uint16', 'int32'|'uint32'|'int64'|'uint64'|'fixdt(1,16)'|'fixdt(1,16,0)'|'fixdt(1,16,2^0,0)'|'<data type expression>'

Default: 'Inherit: Inherit via internal rule'**Lock data type settings against changes by the fixed-point tools — Prevent fixed-point tools from overriding data types**

off (default) | on

Select to lock data type settings of this block against changes by the Fixed-Point Tool and the Fixed-Point Advisor. For more information, see “Lock the Output Data Type Setting” (Fixed-Point Designer).

Programmatic Use**Block Parameter:** LockScale**Values:** 'off' | 'on'**Default:** 'off'**Integer rounding mode — Rounding mode for fixed-point operations**

Floor (default) | Ceiling | Convergent | Nearest | Round | Simplest | Zero

Specify the rounding mode for fixed-point operations. For more information, see “Rounding” (Fixed-Point Designer).

Block parameters always round to the nearest representable value. To control the rounding of a block parameter, enter an expression using a MATLAB rounding function into the mask field.

Programmatic Use**Block Parameter:** RndMeth**Type:** character vector

Values: 'Ceiling' | 'Convergent' | 'Floor' | 'Nearest' | 'Round' | 'Simplest' | 'Zero'

Default: 'Floor'**Saturate on integer overflow — Method of overflow action**

off (default) | on

Specify whether overflows saturate or wrap.

| Action | Rationale | Impact on Overflows | Example |
|-------------------------------------|--|---|---|
| Select this check box (on). | Your model has possible overflow, and you want explicit saturation protection in the generated code. | Overflows saturate to either the minimum or maximum value that the data type can represent. | The maximum value that the <code>int8</code> (signed, 8-bit integer) data type can represent is 127. Any block operation result greater than this maximum value causes overflow of the 8-bit integer. With the check box selected, the block output saturates at 127. Similarly, the block output saturates at a minimum output value of -128. |
| Do not select this check box (off). | <p>You want to optimize efficiency of your generated code.</p> <p>You want to avoid overspecifying how a block handles out-of-range signals. For more information, see "Troubleshoot Signal Range Errors".</p> | Overflows wrap to the appropriate value that is representable by the data type. | The maximum value that the <code>int8</code> (signed, 8-bit integer) data type can represent is 127. Any block operation result greater than this maximum value causes overflow of the 8-bit integer. With the check box cleared, the software interprets the overflow-causing value as <code>int8</code> , which can produce an unintended result. For example, a block result of 130 (binary 1000 0010) expressed as <code>int8</code> , is -126. |

When you select this check box, saturation applies to every internal operation on the block, not just the output, or result. Usually, the code generation process can detect when overflow is not possible. In this case, the code generator does not produce saturation code.

Programmatic Use

Block Parameter: SaturateOnIntegerOverflow

Type: character vector

Values: 'off' | 'on'

Default: 'off'

Block Characteristics

| | |
|---------------------------------|--|
| Data Types | Boolean double fixed point half integer single |
| Direct Feedthrough | yes |
| Multidimensional Signals | yes |
| Variable-Size Signals | yes |
| Zero-Crossing Detection | no |

Extended Capabilities

C/C++ Code Generation

Generate C and C++ code using Simulink® Coder™.

HDL Code Generation

Generate Verilog and VHDL code for FPGA and ASIC designs using HDL Coder™.

HDL Coder provides additional configuration options that affect HDL implementation and synthesized logic.

HDL Architecture of Sum, Add, and Subtract Blocks

The default **Linear** architecture generates a chain of N operations (adders) for N inputs.

HDL Architecture of Sum of Elements Block

For the Sum of Elements block, HDL Coder supports **Tree** and **Cascade** architectures for Sum of Elements blocks that have a single vector input with multiple elements.

This block has multi-cycle implementations that introduce additional latency in the generated code. To see the added latency, view the generated model or validation model. See “Generated Model and Validation Model” (HDL Coder).

| Architecture | Additional cycles of latency | Description |
|--------------|---|--|
| Linear | 0 | Generates a linear chain of adders to compute the sum of products. For multiple inputs that have different bit widths, the Linear architecture optimizes the resource utilization by implementing adders in multiple stages with pipelines in between the stages. The output of each stage is calculated based on the width of the inputs to that stage. |
| Tree | 0 | Generates a tree structure of adders to compute the sum of products. |
| Cascade | 1, when block has a single vector input port. | This implementation optimizes latency * area and is faster than the Tree implementation. It computes partial sums and cascades adders. See “Cascade Architecture Best Practices” (HDL Coder). |

HDL Block Properties

Note To use the **LatencyStrategy** setting in the **Native Floating Point** tab of the HDL Block Properties dialog box, specify **Linear** or **Tree** as the HDL Architecture.

| General | |
|----------------------------------|--|
| ConstrainedOutputPipeline | Number of registers to place at the outputs by moving existing delays within your design. Distributed pipelining does not redistribute these registers. The default is 0. For more details, see “ConstrainedOutputPipeline” (HDL Coder). |
| InputPipeline | Number of input pipeline stages to insert in the generated code. Distributed pipelining and constrained output pipelining can move these registers. The default is 0. For more details, see “InputPipeline” (HDL Coder). |
| OutputPipeline | Number of output pipeline stages to insert in the generated code. Distributed pipelining and constrained output pipelining can move these registers. The default is 0. For more details, see “OutputPipeline” (HDL Coder). |

Note The Sum of Elements block does not support HDL code generation with double data types in the Native Floating Point mode.

| Native Floating Point | |
|-------------------------|--|
| LatencyStrategy | Specify whether to map the blocks in your design to <code>inherit</code> , <code>Max</code> , <code>Min</code> , <code>Zero</code> , or <code>Custom</code> for the floating-point operator. The default is <code>inherit</code> . See also “LatencyStrategy” (HDL Coder). |
| NFPCustomLatency | To specify a value, set LatencyStrategy to <code>Custom</code> . HDL Coder adds latency equal to the value that you specify for the NFPCustomLatency setting. See also “NFPCustomLatency” (HDL Coder). |

Complex Data Support

The default `Linear` implementation supports complex data.

The `Tree` implementation supports complex data with + for the **List of signs** block parameter. With native floating point support, the `Tree` implementation supports complex data with both + and - for **List of signs**.

PLC Code Generation

Generate Structured Text code using Simulink® PLC Coder™.

Fixed-Point Conversion

Design and simulate fixed-point systems using Fixed-Point Designer™.

See Also

Gain | Divide | Bias

Topics

“Control Data Types of Signals”

Introduced before R2006a

Switch

Combine multiple signals into single signal

Library: Simulink / Commonly Used Blocks
 Simulink / Signal Routing
 HDL Coder / Commonly Used Blocks
 HDL Coder / Signal Routing

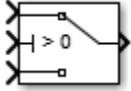

Description

The Switch block passes through the first input or the third input signal based on the value of the second input. The first and third inputs are data input. The second input is a control input. Specify the condition under which the block passes the first input by using the **Criteria for passing first input** and **Threshold** parameters.

Bus Support

The Switch block is a bus-capable block. The data inputs can be virtual or nonvirtual bus signals subject to the following restrictions:

- All the buses must be equivalent (same hierarchy with identical names and attributes for all elements).
- All signals in a nonvirtual bus input to a Switch block must have the same sample time. The requirement holds even if the elements of the associated bus object specify inherited sample times.

You can use a Rate Transition block to change the sample time of an individual signal, or of all signals in a bus. See “Modify Sample Times for Nonvirtual Buses” and Bus-Capable Blocks for more information.

You can use an array of buses as an input signal to a Switch block. For details about defining and using an array of buses, see “Group Nonvirtual Buses in Arrays of Buses”. When using an array of buses, set the **Threshold** parameter to a scalar value.

Limitations

- If the data inputs to the Switch block are buses, the element names of both buses must be the same. Using the same element names ensures that the output bus has the same element names no matter which input bus the block selects. To ensure that your model meets this requirement, use a bus object to define the buses and set the **Element name mismatch** diagnostic to error. See “Model Configuration Parameters: Connectivity Diagnostics” for more information.

Ports

Input

Port_1 — First data input signal

scalar | vector

First of two data inputs. The block propagates either the first or second data input to the output. The block selects which input to pass based on the control input. Specify the condition for the control input to pass the first input using the **Criteria for passing first input** and **Threshold** parameters.

Data Types: single | double | half | int8 | int16 | int32 | int64 | uint8 | uint16 | uint32 | uint64 | Boolean | fixed point | enumerated | bus

Port_2 — Control input signal

scalar | vector

Control signal the block uses to determine whether to pass the first or second data input to the output. If the control input meets the condition set in the **Criteria for passing first input** parameter, then the block passes the first data input. Otherwise, the block passes the second data input.

Data Types: single | double | half | int8 | int16 | int32 | int64 | uint8 | uint16 | uint32 | uint64 | Boolean | fixed point | enumerated | bus

Port_3 — Second data input signal

scalar | vector

Second of two data inputs. The block propagates either the first or second data input to the output. The block selects which input to pass based on the control input. Specify the condition for the control input to pass the first or second input using the **Criteria for passing first input** and **Threshold** parameters.

Data Types: single | double | half | int8 | int16 | int32 | int64 | uint8 | uint16 | uint32 | uint64 | Boolean | fixed point | enumerated | bus

Output

Port_1 — Output signal

scalar | vector

Output signal propagated from either the first or second input signal, based on the control signal value.

Data Types: single | double | half | int8 | int16 | int32 | int64 | uint8 | uint16 | uint32 | uint64 | Boolean | fixed point | enumerated | bus

Parameters

Main

Criteria for passing first input — Selection criteria to pass first data input

u2 >= Threshold (default) | u2 > Threshold | u2 ~= 0

Select the condition under which the block passes the first data input. If the control input meets the condition set in the **Criteria for passing first input** parameter, the block passes the first input. Otherwise, the block passes the second data input signal from input `Port_3`.

`u2 >= Threshold`

Checks whether the control input is greater than or equal to the threshold value.

`u2 > Threshold`

Checks whether the control input is greater than the threshold value.

`u2 ~=0`

Checks whether the control input is nonzero.

Note The Switch block does not support `u2 ~=0` mode for enumerated data types.

Tip

When the control input is a Boolean signal, use one of these combinations of condition and threshold value:

- `u2 >= Threshold`, where the threshold value equals 1
- `u2 > Threshold`, where the threshold value equals 0
- `u2 ~=0`

Otherwise, the Switch block ignores threshold values and uses the Boolean value for signal routing. For a value of 1, the block passes the first input, and for a value of 0, the block passes the third input. A warning message that describes this behavior also appears in the MATLAB Command Window.

Programmatic Use

Block Parameter: Criteria

Type: character vector

Value: 'u2 >= Threshold' | 'u2 > Threshold' | 'u2 ~=0'

Default: 'u2 >= Threshold'

Threshold — Threshold used in criteria

0 (default) | scalar

Assign the threshold used in the **Criteria for passing first input** that determines which input the block passes to the output. **Threshold** must be greater than **Output minimum** and less than **Output maximum**.

To specify a nonscalar threshold, use brackets. For example, the following entries are valid:

- [1 4 8 12]
- [MyColors.Red, MyColors.Blue]

Dependencies

Setting **Criteria for passing first input** to `u2 ~=0` disables this parameter.

Programmatic Use

Block Parameter: Threshold

Type: character vector

Value: 'off' | 'on'

Default: 'off'

Enable zero-crossing detection — Enable zero-crossing detection

on (default) | Boolean

Select to enable zero-crossing detection. For more information, see “Zero-Crossing Detection” in the Simulink documentation.

Programmatic Use

Block Parameter: ZeroCross

Type: character vector, string

Values: 'off' | 'on'

Default: 'on'

Signal Attributes

Click the **Show data type assistant** button  to display the **Data Type Assistant**, which helps you set the data type attributes. For more information, see “Specify Data Types Using Data Type Assistant”.

Require all data port inputs to have the same data type — Require data ports to have the same data type

off (default) | on

Require all data inputs to have the same data type.

Programmatic Use

Block Parameter: InputSameDT

Type: character vector

Value:

Default: '0'

Output minimum — Minimum output value for range checking

[] (default) | scalar

Lower value of the output range that Simulink checks.

Simulink uses the minimum to perform:

- Parameter range checking (see “Specify Minimum and Maximum Values for Block Parameters”) for some blocks.
- Simulation range checking (see “Specify Signal Ranges” and “Enable Simulation Range Checking”).
- Automatic scaling of fixed-point data types.
- Optimization of the code that you generate from the model. This optimization can remove algorithmic code and affect the results of some simulation modes such as SIL or external mode. For more information, see “Optimize using the specified minimum and maximum values” (Embedded Coder).

Note Output minimum does not saturate or clip the actual output signal. Use the Saturation block instead.

Programmatic Use**Block Parameter:** OutMin**Type:** character vector**Values:** ' [] ' | scalar**Default:** ' [] '**Output maximum — Maximum output value for range checking**

[] (default) | scalar

Upper value of the output range that Simulink checks.

Simulink uses the maximum value to perform:

- Parameter range checking (see “Specify Minimum and Maximum Values for Block Parameters”) for some blocks.
- Simulation range checking (see “Specify Signal Ranges” and “Enable Simulation Range Checking”).
- Automatic scaling of fixed-point data types.
- Optimization of the code that you generate from the model. This optimization can remove algorithmic code and affect the results of some simulation modes such as SIL or external mode. For more information, see “Optimize using the specified minimum and maximum values” (Embedded Coder).

Note **Output maximum** does not saturate or clip the actual output signal. Use the Saturation block instead.

Programmatic Use**Block Parameter:** OutMax**Type:** character vector**Values:** ' [] ' | scalar**Default:** ' [] '**Output data type — Output data type**

Inherit: Inherit via internal rule (default) | Inherit: Inherit via back propagation | Inherit: Same as first input | double | single | half | int8 | uint8 | int16 | uint16 | int32 | uint32 | int64 | uint64 | fixdt(1,16) | fixdt(1,16,0) | fixdt(1,16,2^0,0) | string | Enum: <class name> | <data type expression>

Specify the output data type.

Inherit: Inherit via internal rule

Uses the following rules to determine the output data type.

| Data Type of First Input Port | Output Data Type |
|---|-------------------------------------|
| Has a larger positive range than the third input port | Inherited from the first input port |
| Has the same positive range as the third input port | Inherited from the third input port |

| Data Type of First Input Port | Output Data Type |
|--|------------------------|
| Has a smaller positive range than the third input port | |
| Is a Boolean value and third input port is uint8 | |
| Is uint8 and third input port is a Boolean value | |
| Is a Boolean value and other is int8 | Set to a Boolean value |
| Is uint8 and other is a Boolean value | |

| Data Types of Two Input Ports | Output Data Type |
|--|---|
| Has one input type as a Boolean value and another as uint8 | Set to data type of the third data port |
| Has one input as a Boolean value and another as int8 | Set to a Boolean value |

Inherit: Inherit via back propagation

Uses data type of the driving block.

Inherit: Inherit same as first input

Uses data type of the first data input port.

double

Specifies output data type is double.

single

Specifies output data type is single.

half

Specifies output data type is half.

int8

Specifies output data type is int8.

uint8

Specifies output data type is uint8.

int16

Specifies output data type is int16.

uint16

Specifies output data type is uint16.

int32

Specifies output data type is int32.

uint32

Specifies output data type is uint32.

int64

Specifies output data type is int64.

uint64

Specifies output data type is uint64.

fixdt(1,16,0)

Specifies output data type is fixed point fixdt(1,16,0).

fixdt(1,16,2^0,0)

Specifies output data type is fixed point fixdt(1,16,2^0,0).

Enum: <class name>

Uses an enumerated data type, for example, Enum: BasicColors.

string

Specifies output data type is string.

<data type expression>

Uses a data type object, for example, Simulink.NumericType.

Tip

When the output is of enumerated type, both data inputs should use the same enumerated type as the output.

Programmatic Use

Block Parameter: OutDataTypeStr

Type: character vector

Values: 'Inherit: Inherit via internal rule' | 'Inherit: Inherit via back propagation' | 'Inherit: Same as first input' | 'double' | 'single' | 'half' | 'int8' | 'uint8' | 'int16' | 'uint16', 'int32' | 'uint32' | 'int64' | 'uint64' | 'fixdt(1,16)' | 'fixdt(1,16,0)' | 'fixdt(1,16,2^0,0)' | Enum: <class name> | 'string' | '<data type expression>'

Default: 'Inherit: Inherit via internal rule'

Lock data type settings against changes by the fixed-point tools – Prevent fixed-point tools from overriding data types

off (default) | on

Select this parameter to prevent the fixed-point tools from overriding the data types you specify on this block. For more information, see “Lock the Output Data Type Setting” (Fixed-Point Designer).

Programmatic Use

Block Parameter: LockScale

Type: character vector

Values: 'off' | 'on'

Default: 'off'

Integer rounding mode – Specify the rounding mode for fixed-point operations

Floor (default) | Ceiling | Convergent | Nearest | Round | Simplest | Zero

Choose one of these rounding modes.

Ceiling

Rounds both positive and negative numbers toward positive infinity. Equivalent to the MATLAB ceil function.

Convergent

Rounds number to the nearest representable value. If a tie occurs, rounds to the nearest even integer. Equivalent to the Fixed-Point Designer `convergent` function.

Floor

Rounds both positive and negative numbers toward negative infinity. Equivalent to the MATLAB `floor` function.

Nearest

Rounds number to the nearest representable value. If a tie occurs, rounds toward positive infinity. Equivalent to the Fixed-Point Designer `nearest` function.

Round

Rounds number to the nearest representable value. If a tie occurs, rounds positive numbers toward positive infinity and rounds negative numbers toward negative infinity. Equivalent to the Fixed-Point Designer `round` function.

Simplest

Automatically chooses between round toward floor and round toward zero to generate rounding code that is as efficient as possible.

Zero

Rounds number toward zero. Equivalent to the MATLAB `fix` function.

Programmatic Use

Block Parameter: `RndMeth`

Type: character vector

Values: `'Ceiling'` | `'Convergent'` | `'Floor'` | `'Nearest'` | `'Round'` | `'Simplest'` | `'Zero'`

Default: `'Floor'`

See Also

For more information, see “Rounding” (Fixed-Point Designer).

Saturate on integer overflow — Method of overflow action

`off` (default) | `on`

Specify whether overflows saturate or wrap.

- `off` — Overflows wrap to the appropriate value that the data type can represent.

For example, the number 130 does not fit in a signed 8-bit integer and wraps to -126.

- `on` — Overflows saturate to either the minimum or maximum value that the data type can represent.

For example, an overflow associated with a signed 8-bit integer can saturate to -128 or 127.

Tip

- Consider selecting this check box when your model has a possible overflow and you want explicit saturation protection in the generated code.
- Consider clearing this check box when you want to optimize efficiency of your generated code.

Clearing this check box also helps you to avoid overspecifying how a block handles out-of-range signals. For more information, see “Troubleshoot Signal Range Errors”.

- When you select this check box, saturation applies to every internal operation on the block, not just the output or result.
- In general, the code generation process can detect when overflow is not possible. In this case, the code generator does not produce saturation code.

Programmatic Use

Block Parameter: SaturateOnIntegerOverflow

Type: character vector

Values: 'off' | 'on'

Default: 'off'

Allow different data input sizes — Allow different data input sizes

off (default) | on

Select this check box to allow input signals with different sizes. The block propagates the input signal size to the output signal. If the two data inputs are variable-size signals, the maximum size of the signals can be equal or different.

Programmatic Use

Block Parameter: AllowDiffInputSizes

Type: character vector

Value: 'on' | 'off'

Default: 'off'

Block Characteristics

| | |
|---------------------------------|--|
| Data Types | Boolean bus double enumerated fixed point half integer single string |
| Direct Feedthrough | yes |
| Multidimensional Signals | yes |
| Variable-Size Signals | yes |
| Zero-Crossing Detection | yes |

Extended Capabilities

C/C++ Code Generation

Generate C and C++ code using Simulink® Coder™.

Generated code relies on memcpy or memset functions (string.h) under certain conditions.

HDL Code Generation

Generate Verilog and VHDL code for FPGA and ASIC designs using HDL Coder™.

HDL Coder provides additional configuration options that affect HDL implementation and synthesized logic.

HDL Architecture

This block has a single, default HDL architecture.

HDL Block Properties

| | |
|----------------------------------|--|
| ConstrainedOutputPipeline | Number of registers to place at the outputs by moving existing delays within your design. Distributed pipelining does not redistribute these registers. The default is 0. For more details, see "ConstrainedOutputPipeline" (HDL Coder). |
| InputPipeline | Number of input pipeline stages to insert in the generated code. Distributed pipelining and constrained output pipelining can move these registers. The default is 0. For more details, see "InputPipeline" (HDL Coder). |
| OutputPipeline | Number of output pipeline stages to insert in the generated code. Distributed pipelining and constrained output pipelining can move these registers. The default is 0. For more details, see "OutputPipeline" (HDL Coder). |

Complex Data Support

This block supports code generation for complex signals.

PLC Code Generation

Generate Structured Text code using Simulink® PLC Coder™.

Fixed-Point Conversion

Design and simulate fixed-point systems using Fixed-Point Designer™.

See Also

[Multiport Switch](#) | [Manual Switch](#)

Introduced before R2006a

Switch Case

Select subsystem execution using logic similar to `switch` statement

Library: Simulink / Ports & Subsystems

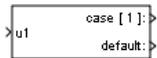

Description

The Switch Case block with Switch Case Action Subsystem blocks containing Action Port blocks, implements switch logic to control subsystem execution.

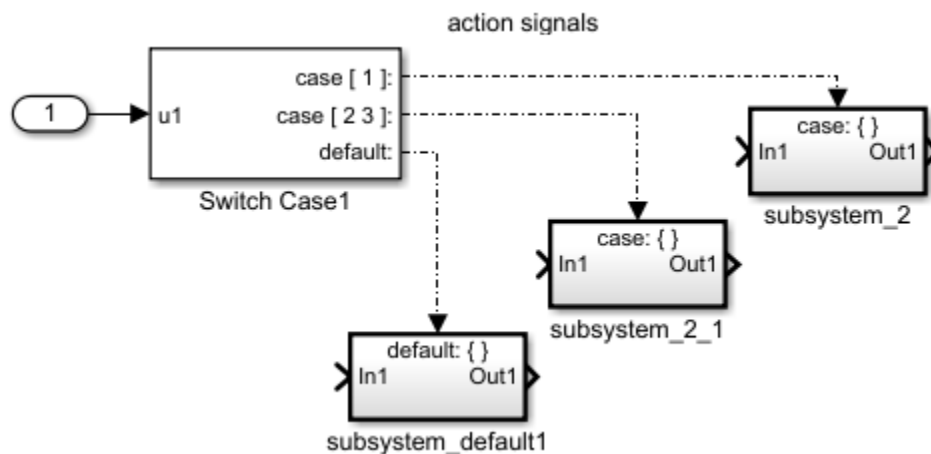

A Switch Case block has a single input. To select a case, define the input value using the **Case conditions** parameter. The cases are evaluated top down starting with the first case.

Each case is associated with an output port that is attached to a Switch Case Action Subsystem block. When a case is selected, the associated output port sends an action signal to execute the subsystem.

A `default` case is selected after all of the other case conditions evaluate to false. Providing a `default` case is optional, even if the other case conditions do not exhaust every possible input value.

Cases for the Switch Case block contain an implied break after a Switch Case Action Subsystem block is executed. Therefore, there is no fall through behavior for the Simulink Switch Case block as found in standard C `switch` statements.

Ports

Input

u1 (logical operator) – Value for case selection

scalar

Input to the port labeled **u1** of a Switch Case block can be:

- A scalar value with a built-in data type that Simulink supports. However, the Switch Case block does not support Boolean or fixed-point data types, and it truncates numeric inputs to 32-bit signed integers.
- A scalar value of any enumerated data type.

Data Types: `single` | `double` | `int8` | `int16` | `int32` | `uint8` | `uint16` | `uint32` | `enumerated`

Output

case — Action signal for a Switch Case Action Subsystem block

scalar

Output from the **Case** and **default** ports are action signals connected to Switch Case Action Subsystem blocks.

Parameters

Case conditions — Specify case values

{1} (default) | list of cases

Specify the cases values using MATLAB cell notation.

{1}

Specify the output port labeled `case[1]` outputs an action signal when the input port value is 1.

list of ports with case assignments

Specify multiple cases and ports using MATLAB cell notation. For example, entering `{1, [7,9,4]}` specifies that output port `case[1]` is run when the input value is 1, and output port `case [7 9 4]` is run when the input value is 7, 9, or 4.

You can use colon notation to specify a range of integer case conditions. For example, entering `{[1:5]}` specifies that output port **case[1 2 3 4 5]** is run when the input value is 1, 2, 3, 4, or 5.

Depending on block size, cases from a long list of case conditions are displayed in shortened form on the face of the Switch Case block, using a terminating ellipsis (...).

You can use the name of an enumerated type to specify case conditions that include a case for every value in that enumerated type.

Programmatic Use

Block Parameter: `CaseConditions`

Type: character vector

Values: '{1}' | '<list of cases>'

Default: '{1}'

Show default case — Control display of default output port

on (default) | off

Control display of default output port.

on

Display default output port as the last case on the Switch Case block. This allows you to specify a default case that executes when the input value does not match any of the other case values.

off

Hide default output port.

Programmatic Use

Block Parameter: ShowDefaultCase

Type: character vector

Values: 'on' | 'off'

Default: 'on'

Enable zero-crossing detection — Control zero-crossing detection

on (default) | off

Control zero-crossing detection.

on

Detect zero crossings.

off

Do not detect zero crossings.

Programmatic Use

Block Parameter: ZeroCross

Type: character vector

Values: 'on' | 'off'

Default: 'on'

Block Characteristics

| | |
|---------------------------------|--|
| Data Types | double enumerated integer single |
| Direct Feedthrough | yes |
| Multidimensional Signals | no |
| Variable-Size Signals | no |
| Zero-Crossing Detection | yes |

Extended Capabilities

C/C++ Code Generation

Generate C and C++ code using Simulink® Coder™.

See Also

Blocks

Subsystem | Action Port | Switch Case Action Subsystem

Topics

Select Subsystem Execution

Introduced before R2006a

Switch Case Action Subsystem

Subsystem whose execution is enabled by Switch Case block

Library: Simulink / Ports & Subsystems

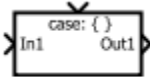

Description

The Switch Case Action Subsystem block is a Subsystem block preconfigured as a starting point for creating a subsystem whose execution is controlled by a Switch Case block. The input port to a Switch Case block selects a case defined using the **Case conditions** parameter. Depending on input value and case selected, an action signal is sent to execute a Switch Case Action Subsystem block. Execution of the subsystem is controlled by an Action Port block placed inside the subsystem.

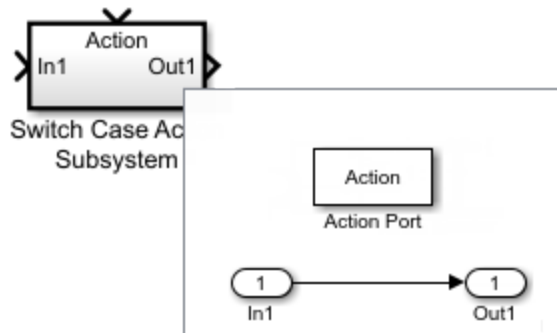

Simulink ignores a priority set on an Switch Case Action Subsystem block. Instead, set the priority on the Switch Case block that initiates execution of the subsystem.

All blocks in a Switch Case Action Subsystem block must run at the same rate as the driving Switch Case block. You can achieve this requirement by setting each block sample time parameter to be either inherited (-1) or the same value as the Switch Case block sample time.

Merge signals from Switch Case Subsystem blocks

This example shows how to create a one signal from multiple subsystem output signals. The Switch Case block selects the execution of one If Action Subsystem block from a set of subsystems. Regardless of which subsystem the Switch Case block selects, you can create a one resulting signal with a Merge block. To open the model, see [ex_switch_case_block](#).

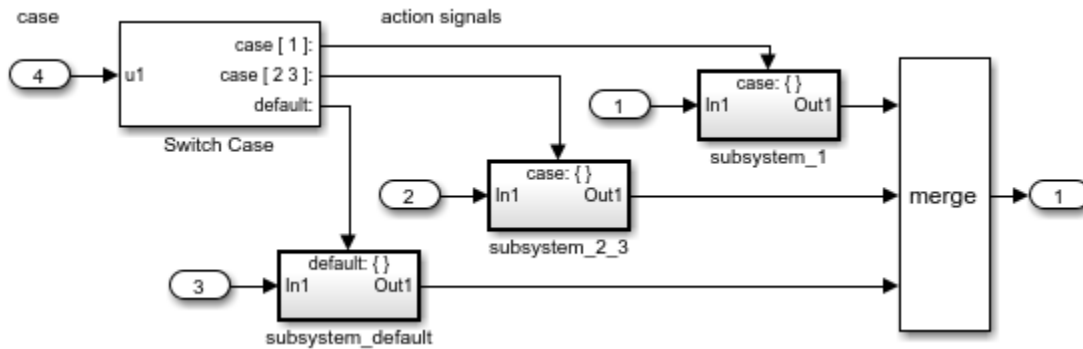

Ports

Input

In1 — Signal input to a subsystem block

scalar | vector | matrix

Placing an Inport block in a subsystem block adds an external input port to the block. The port label matches the name of the Inport block.

Use Inport blocks to get signals from the local environment.

Data Types: half | single | double | int8 | int16 | int32 | int64 | uint8 | uint16 | uint32 | uint64 | Boolean | fixed point | enumerated | bus

Action — Control signal input to a subsystem block

scalar | vector | matrix

Placing an Action Port block in a subsystem block adds an external input port to the block and changes the block to a Switch Case Action Subsystem block.

Dot-dash lines from a Switch Case block to an Switch Case Action Subsystem block represent *action* signals. An action signal is a control signal connected to the action port of an Switch Case Action Subsystem block. A message on the action signal initiates execution of the subsystem.

Data Types: action

Output

Out1 — Signal output from a subsystem

scalar | vector | matrix

Placing an Outport block in a subsystem block adds an output port from the block. The port label on the subsystem block is the name of the Outport block.

Use Outport blocks to send signals to the local environment.

Data Types: half | single | double | int8 | int16 | int32 | int64 | uint8 | uint16 | uint32 | uint64 | Boolean | fixed point | enumerated | bus

Block Characteristics

| | |
|---------------------------------|---|
| Data Types | Boolean ^a bus ^a double ^a enumerated ^a fixed point ^a half ^a integer ^a single ^a string ^a |
| Direct Feedthrough | no |
| Multidimensional Signals | limited ^a |
| Variable-Size Signals | limited ^a |
| Zero-Crossing Detection | no |

a. Actual data type or capability support depends on block implementation.

Extended Capabilities

C/C++ Code Generation

Generate C and C++ code using Simulink® Coder™.

Actual data type or capability support depends on block implementation.

Fixed-Point Conversion

Design and simulate fixed-point systems using Fixed-Point Designer™.

Actual data type support depends on block implementation.

See Also

Blocks

Action Port | Switch Case | Subsystem

Topics

Select Subsystem Execution

Introduced before R2006a

Tapped Delay

Delay scalar signal multiple sample periods and output all delayed versions

Library: Simulink / Discrete
HDL Coder / Discrete



Description

The Tapped Delay block delays an input by the specified number of sample periods and provides an output signal for each delay. For example, when you specify 4 for **Number of delays** and **Order output starting with** is `Oldest`, the block provides four outputs — the first delayed by four sample periods, the second delayed by three, and so on. Use this block to discretize a signal in time or resample a signal at a different rate.

The block accepts one scalar input and generates an output vector that contains data for each incremental delay. Specify the order of the delayed signals in the output vector with the **Order output vector starting with** parameter:

- `Oldest` orders the output vector starting with the oldest delay version and ending with the newest delay version.
- `Newest` orders the output vector starting with the newest delay version and ending with the oldest delay version.

Specify the output vector for the first sampling period with the **Initial condition** parameter. Careful selection of this parameter can mitigate unwanted output behavior.

Specify the time between samples with the **Sample time** parameter. Specify the number of delays with the **Number of delays** parameter. A value of -1 instructs the block to inherit the number of delays by backpropagation. Each delay is equivalent to the z^{-1} discrete-time operator, which the Unit Delay block represents.

Ports

Input

Port_1 — Input signal

scalar

Input signal to delay.

Data Types: `single` | `double` | `int8` | `int16` | `int32` | `int64` | `uint8` | `uint16` | `uint32` | `uint64` | `Boolean` | `fixed point`

Output

Port_1 — Delayed versions of input signal

scalar | vector

All versions of the delayed input signal. Use the **Order output vector starting with** parameter to specify the order of delayed signals in the output vector.

Data Types: single | double | int8 | int16 | int32 | int64 | uint8 | uint16 | uint32 | uint64 | Boolean | fixed point

Parameters

Initial condition — Initial output

0.0 (default) | scalar

Specify the initial output of the simulation. The **Initial condition** parameter is converted from a double to the input data type offline using round-to-nearest and saturation.

Limitations

The initial condition of this block cannot be `inf` or `NaN`.

Programmatic Use

Block Parameter: `vinit`

Type: character vector

Values: scalar

Default: `'0.0'`

Sample time — Time between samples

-1 (default) | scalar | vector

Specify the time interval between samples. To inherit the sample time, set this parameter to -1. For more information, see “Specify Sample Time”.

Programmatic Use

Block Parameter: `samptime`

Type: character vector

Values: scalar | vector

Default: `'-1'`

Number of delays — Number of discrete-time operators

4 (default) | positive scalar | -1 (for inherited)

Specify the number of discrete-time operators as a positive scalar, or -1 for inherited.

Programmatic Use

Block Parameter: `NumDelays`

Type: character vector

Values: positive scalar | -1 (inherited)

Default: `'4'`

Order output vector starting with — Order of output

Oldest (default) | Newest

Specify whether to output the oldest delay version first, or the newest delay version first.

Programmatic Use**Block Parameter:** DelayOrder**Type:** character vector**Values:** 'Oldest' | 'Newest'**Default:** 'Oldest'**Include current input in output vector — Include current input in output vector**

off (default) | on

Select this check box to include the current input in the output vector.

Programmatic Use**Block Parameter:** includeCurrent**Type:** character vector**Values:** 'off' | 'on'**Default:** 'off'**Block Characteristics**

| | |
|---------------------------------|---|
| Data Types | Boolean double fixed point integer single |
| Direct Feedthrough | no |
| Multidimensional Signals | no |
| Variable-Size Signals | no |
| Zero-Crossing Detection | no |

Extended Capabilities**C/C++ Code Generation**

Generate C and C++ code using Simulink® Coder™.

HDL Code Generation

Generate Verilog and VHDL code for FPGA and ASIC designs using HDL Coder™.

HDL Coder provides additional configuration options that affect HDL implementation and synthesized logic.

HDL Architecture

This block has a single, default HDL architecture.

HDL Block Properties

| | |
|----------------------------------|--|
| ConstrainedOutputPipeline | Number of registers to place at the outputs by moving existing delays within your design. Distributed pipelining does not redistribute these registers. The default is 0. For more details, see “ConstrainedOutputPipeline” (HDL Coder). |
|----------------------------------|--|

| | |
|-----------------------|--|
| InputPipeline | Number of input pipeline stages to insert in the generated code. Distributed pipelining and constrained output pipelining can move these registers. The default is 0. For more details, see “InputPipeline” (HDL Coder). |
| OutputPipeline | Number of output pipeline stages to insert in the generated code. Distributed pipelining and constrained output pipelining can move these registers. The default is 0. For more details, see “OutputPipeline” (HDL Coder). |
| ResetType | Suppress reset logic generation. The default is default, which generates reset logic. See also “ResetType” (HDL Coder). |

Complex Data Support

This block supports code generation for complex signals.

PLC Code Generation

Generate Structured Text code using Simulink® PLC Coder™.

Fixed-Point Conversion

Design and simulate fixed-point systems using Fixed-Point Designer™.

See Also

Delay | Resettable Delay | Unit Delay | Variable Integer Delay

Topics

“Specify Sample Time”

Introduced before R2006a

Terminate Function

Execute subsystem on model terminate event

Library: Simulink / User-Defined Functions

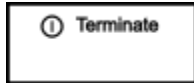

Description

The Terminate Function block is a pre-configured Subsystem block that executes on a model terminate event. By default, the Terminate Function block includes an Event Listener block with **Event** set to Terminate, a Terminator block, and a State Reader block.

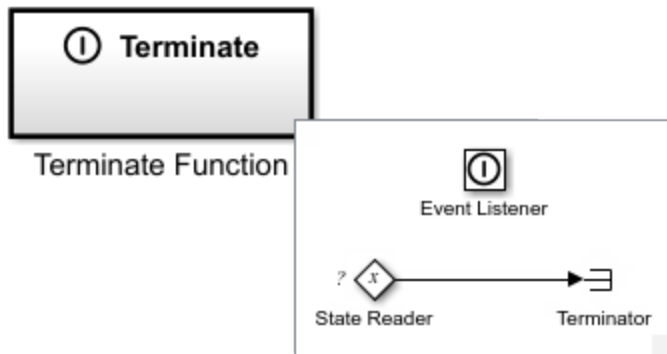

Replace the Terminator block with blocks to save the state value from the State Reader block.

Conditionally executed subsystem blocks with output ports are fully supported within Terminate Function blocks.

For a list of unsupported blocks and features, see “Initialize, Reset, and Terminate Function Limitations”.

The input and output ports of a component containing Initialize Function and Terminate Function blocks must connect to input and output port blocks.

The code generated from this block is part of the `model_terminate` function that is called once at the end of model execution.

You can select an Initialize Function, Reset Function, or Terminate Function block or a corresponding state owner block to highlight blocks related to it. To show a related block in an open diagram or new

tab, pause on the ellipsis that appears after selection. Then, select **Related Blocks**  from the action bar. When multiple blocks correspond to the selected block, a list of related blocks opens. You can filter the list of related blocks by entering a search term in the text box. After you select a related block from the list, window focus goes to the open diagram or new tab that shows the related block.

Block Characteristics

| | |
|---------------------------------|---|
| Data Types | Boolean ^a bus ^a double ^a enumerated ^a fixed point ^a half ^a integer ^a single ^a string ^a |
| Direct Feedthrough | no |
| Multidimensional Signals | limited ^a |
| Variable-Size Signals | no |
| Zero-Crossing Detection | no |

a. Actual data type or capability support depends on block implementation.

Extended Capabilities

C/C++ Code Generation

Generate C and C++ code using Simulink® Coder™.

Actual code generation support depends on block implementation.

Fixed-Point Conversion

Design and simulate fixed-point systems using Fixed-Point Designer™.

Actual data type support depends on block implementation.

See Also

Initialize Function | Reset Function | Event Listener | State Reader | State Writer

Topics

“Using Initialize, Reset, and Terminate Functions”

“Create Test Harness to Generate Function Calls”

“Generate Code That Responds to Initialize, Reset, and Terminate Events” (Simulink Coder)

Terminator

Terminate unconnected output port

Library: Simulink / Commonly Used Blocks
 Simulink / Sinks
 HDL Coder / Sinks



Description

Use the Terminator block to cap blocks whose output ports do not connect to other blocks. If you run a simulation with blocks having unconnected output ports, Simulink issues warning messages. Using Terminator blocks to cap those blocks helps prevent warning messages.

Ports

Input

Port_1 — Input signal

scalar | vector | matrix | n-D array | bus

Use this port to direct signals from output ports that are otherwise unconnected during a simulation. The port accepts real or complex signals of all data types.

Data Types: single | double | half | int8 | int16 | int32 | int64 | uint8 | uint16 | uint32 | uint64 | string | Boolean | fixed point | enumerated | bus

Block Characteristics

| | |
|---------------------------------|--|
| Data Types | Boolean bus double enumerated fixed point half integer single string |
| Direct Feedthrough | no |
| Multidimensional Signals | yes |
| Variable-Size Signals | no |
| Zero-Crossing Detection | no |

Extended Capabilities

C/C++ Code Generation

Generate C and C++ code using Simulink® Coder™.

HDL Code Generation

Generate Verilog and VHDL code for FPGA and ASIC designs using HDL Coder™.

This block can be used to terminate simulation when used with subsystems that generate HDL code, but is not included in the hardware implementation

PLC Code Generation

Generate Structured Text code using Simulink® PLC Coder™.

Fixed-Point Conversion

Design and simulate fixed-point systems using Fixed-Point Designer™.

See Also

Ground | “Unconnected block output ports”

Topics

“Model Configuration Parameters: Connectivity Diagnostics”

“Systematic Diagnosis of Errors and Warnings”

Introduced before R2006a

Timed-Based Linearization

Generate linear models in base workspace at specific times

Library: Simulink / Model-Wide Utilities



Description

This block calls `linmod` or `dlinmod` to create a linear model for the system when the simulation clock reaches the time specified by the **Linearization time** parameter. No trimming is performed. The linear model is stored in the base workspace as a structure, along with information about the operating point at which the snapshot was taken. Multiple snapshots are appended to form an array of structures.

The block sets the following model parameters to the indicated values:

- `BufferReuse` = 'off'
- `RTWInlineParameters` = 'on'
- `BlockReductionOpt` = 'off'

The name of the structure used to save the snapshots is the name of the model appended by `_Timed_Based_Linearization`, for example, `vdp_Timed_Based_Linearization`. The structure has the following fields:

| Field | Description |
|-------------------------|--|
| <code>a</code> | The A matrix of the linearization |
| <code>b</code> | The B matrix of the linearization |
| <code>c</code> | The C matrix of the linearization |
| <code>d</code> | The D matrix of the linearization |
| <code>StateName</code> | Names of the model's states |
| <code>OutputName</code> | Names of the model's output ports |
| <code>InputName</code> | Names of the model's input ports |
| <code>OperPoint</code> | A structure that specifies the operating point of the linearization. The structure specifies the operating point time (<code>OperPoint.t</code>). The states (<code>OperPoint.x</code>) and inputs (<code>OperPoint.u</code>) fields are not used. |
| <code>Ts</code> | The sample time of the linearization for a discrete linearization |

Tip To generate models conditionally, use the Trigger-Based Linearization block.

Parameters

Linearization time — Time at which to generate a linear model

1 (default) | scalar | vector

Time at which you want the block to generate a linear model. Enter a vector of times if you want the block to generate linear models at more than one time step.

Programmatic Use

Block Parameter: LinearizationTime

Type: character vector

Values: scalar | vector

Default: '1'

Sample time (of linearized model) — Sample time

0 (default) | scalar | vector

Specify a sample time for the linear model. To create a continuous-time model using `linmod`, specify a sample time of 0. Otherwise, to create a discrete-time model using `dlinmod`, specify a positive sample time (see “Discrete-Time System Linearization” on page 2-52).

Programmatic Use

Block Parameter: SampleTime

Type: character vector

Values: scalar | vector

Default: '0'

Block Characteristics

| | |
|---------------------------------|----|
| Data Types | |
| Direct Feedthrough | no |
| Multidimensional Signals | no |
| Variable-Size Signals | no |
| Zero-Crossing Detection | no |

See Also

Trigger-Based Linearization | `dlinmod` | `linmod`

Topics

“Discrete-Time System Linearization” on page 2-52

Introduced in R2010a

To File

Write data to file

Library: Simulink / Sinks
HDL Coder / Sinks



Description

The To File block writes input signal data into a MAT-file. The block writes to the output file incrementally, with minimal memory overhead during simulation. If the output file exists when the simulation starts, the block overwrites the file. The file automatically closes when you pause the simulation or the simulation completes. If simulation terminates abnormally, the To File block saves the data it has logged up until the point of the abnormal termination.

The To File block icon shows the name of the output file.

Control Amount of Data Saved

If you specify data logging intervals with the **Configuration Parameters > Data Import/Export > Logging intervals** parameter, the To File block logs only data inside of the intervals. For example, the block logs no data if the intervals are empty ([]). The block stores the logged data in the file associated with the block instead of in the variable that you specify for the **Single simulation output** parameter.

For variable-step solvers, to control the amount of data available to the To File block, use the **Configuration Parameters > Data Import/Export > Additional parameters > Output options** parameter. For example, to write data at identical time points over multiple simulations, select the **Produce specified output only** option.

Block parameters also control the amount of data saved. See “Decimation” on page 1-0 and “Sample time” on page 1-0 .

Pause Simulation

After pausing a simulation, do not alter any file that a To File block logs into. For example, do not save such a file with the MATLAB `save` command. Altering the file can cause an error when you resume the simulation. If you want to alter the file after pausing, copy the file and work with the copy of the file.

If you pause using the Simulation Stepper, the To File block captures the simulation data up to the point of the pause. When you step back, the To File data file no longer contains any simulation data past the new reduced time of the last output.

Limitations

When a To File block is in a referenced model, that model must be a single-instance model. Only one instance of such a model can exist in a model hierarchy. See “Model Reuse” for more information.

Ports

Input

Port_1 — Input signal

scalar | vector | matrix | N-D array

Signal to store in file. Each sample consists of a timestamp and an associated data value. The data can be in array format or MATLAB `timeseries` format. The To File block accepts real or complex signal data of any data type that Simulink software supports, except fixed-point data with a word length greater than 32 bits.

Data Types: `single` | `double` | `int8` | `int16` | `int32` | `int64` | `uint8` | `uint16` | `uint32` | `uint64` | `Boolean` | `fixed point` | `enumerated` | `bus`

Parameters

File name — Path or file name

`untitled.mat` (default) | MAT-file path or name

Specify the path or file name of the MAT-file in which to store the output. On UNIX systems, the path name can start with a tilde (~) character signifying your home folder. If you specify a file name without path information, Simulink software stores the file in the MATLAB working folder. (To determine the working folder, at the MATLAB command line, enter `pwd`.) If the file exists, Simulink software overwrites it.

Programmatic Use

Block Parameter: `FileName`

Type: character vector

Values: MAT-file path or name

Default: `'untitled.mat'`

Variable name — Matrix name

`ans` (default) | character vector

Specify the name of the matrix contained in the file.

Programmatic Use

Block Parameter: `MatrixName`

Type: character vector

Values: character vector

Default: `'ans'`

Save format — Data format

`Timeseries` (default) | `Array`

Specify the data format that the To File block uses for writing data.

Use the `Array` format only for vector, double, noncomplex signals.

For the `Timeseries` format, the To File block:

- Writes data in a MATLAB `timeseries` object.
- Supports writing multidimensional, real, or complex output values.

- Supports writing output values that have any built-in data type, including Boolean, enumerated (enum), and fixed-point data with a word length of up to 32 bits.
- For virtual and nonvirtual bus input signals, creates a MATLAB structure that matches the bus hierarchy. Each leaf of the structure is a MATLAB timeseries object.

For the Array format, the To File block:

- Writes data into a matrix containing two or more rows. The matrix has the following form:

$$\begin{bmatrix} t_1 & t_2 & \dots & t_{final} \\ u1_1 & u1_2 & \dots & u1_{final} \\ \dots & & & \\ un_1 & un_2 & \dots & un_{final} \end{bmatrix}$$

Simulink software writes one column to the matrix for each data sample. The first element of the column contains the timestamp. The remainder of the column contains data for the corresponding output values.

- Supports writing data that is one-dimensional, double, and noncomplex.

The From File block can use data written by a To File block in any format (Timeseries or Array) without any modifications to the data or other special provisions.

The From Workspace block can read data that is in the Array format and is the transposition of the data written by the To File block. To provide the required format, use MATLAB commands to load and transpose the data from the MAT-file.

The following table shows how simulation mode support depends on the **Save format** value.

| Simulation Mode | Timeseries | Array |
|-----------------------------|---------------|--|
| Normal | Supported | Supported |
| Accelerator | Supported | Supported |
| Rapid Accelerator | Supported | Supported |
| Software-in-the-loop (SIL) | Not supported | Supported if MAT-file logging is enabled |
| Processor-in-the-loop (PIL) | Not supported | Supported if MAT-file logging is available and enabled |
| External | Not supported | Supported if MAT-file logging is enabled |
| RSim target | Supported | Supported if MAT-file logging is enabled |

Programmatic Use

Block Parameter: SaveFormat

Type: character vector

Values: 'Timeseries' | 'Array'

Default: 'Timeseries'

Decimation — Decimation factor that determines when data writes

1 (default) | scalar | vector

Specify the decimation factor, n , that writes data at every n th time that the block executes. The default value has this block writing data at every time step.

Programmatic Use

Block Parameter: Decimation

Type: character vector

Values: scalar | vector

Default: '1'

Sample time — Sample period and offset

-1 (default) | scalar | vector

Specifies the sample period and offset at which to collect data points. This parameter is useful when you are using a variable-step solver where the interval between time steps is not constant. The default value causes the block to inherit the sample time from the driving block. See “Specify Sample Time”.

Programmatic Use

Block Parameter: SampleTime

Type: character vector

Values: scalar | vector

Default: '-1'

Block Characteristics

| | |
|---------------------------------|---|
| Data Types | Boolean bus double enumerated fixed point ^a integer single |
| Direct Feedthrough | no |
| Multidimensional Signals | yes |
| Variable-Size Signals | no |
| Zero-Crossing Detection | no |

a. Supports up to 32-bit fixed-point data types.

Tips

- If MATLAB encounters memory issues when you log many signals in a long simulation that has many time steps, consider logging to persistent storage. When you log to persistent storage, the Dataset format logging data is stored in a MAT-file. Compared to logging to persistent storage, connecting a To File block to signals:
 - Is a per-signal approach that can clutter a model with several To File blocks attached to individual signals.
 - Creates a separate MAT-file for each To File block, compared to the one MAT-file that logging to persistent storage uses.

For details, see “Log Data to Persistent Storage”.

- To avoid the overhead of compressing data in real time, the To File block writes an uncompressed Version 7.3 MAT-file. To compress the data within the MAT-file, load and save the file in MATLAB.

The resaved file is smaller than the original MAT-file that the To File block created, because the **Save** command compresses the data in the MAT-file.

Extended Capabilities

C/C++ Code Generation

Generate C and C++ code using Simulink® Coder™.

Not recommended for production code. Relates to resource limits and restrictions on speed and memory often found in embedded systems. Generated code can contain dynamic allocation and freeing of memory, recursion, additional memory overhead, and widely-varying execution times. While the code is functionally valid and generally acceptable in resource-rich environments, smaller embedded targets often cannot support such code. Usually, blocks evolve toward being suitable for production code. Thus, blocks suitable for production code remain suitable.

Code generation for RSim target provides identical support as Simulink; all other code generation targets support only double, one-dimensional, real signals in array with time format.

To generate code for a To File block, on the **Code Generation > Interface** pane, select the configuration parameter “MAT-file logging” (Simulink Coder).

HDL Code Generation

Generate Verilog and VHDL code for FPGA and ASIC designs using HDL Coder™.

This block can be used for writing simulation results to a file when used with subsystems that generate HDL code, but is not included in the hardware implementation

PLC Code Generation

Generate Structured Text code using Simulink® PLC Coder™.

Fixed-Point Conversion

Design and simulate fixed-point systems using Fixed-Point Designer™.

Supports up to 32-bit fixed-point data types.

See Also

[From File | Record | To Workspace | From Workspace](#)

Topics

“Save Run-Time Data from Simulation”
“Convert Logged Data to Dataset Format”
“Specify Signal Values to Log”

Introduced before R2006a

To Workspace

Write data to workspace

Library: Simulink / Sinks
HDL Coder / Sinks

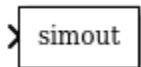

Description

The To Workspace block writes input signal data to a workspace. During simulation, the block writes data to an internal buffer. When you pause the simulation or the simulation completes, that data is written to the workspace. Data is not available until the simulation pauses or stops.

The To Workspace block typically writes data to the MATLAB base workspace. For a `sim` command in a MATLAB function, the To Workspace block sends data to the workspace of the calling function, not to the MATLAB base workspace. To send the logged data to the base workspace, use an `assignin` command in the function.

```
function myfunc
    a = sim('mTest','SimulationMode','normal');
    b = a.get('simout')
    assignin('base','b',b);
end
```

The To Workspace block icon shows the name of the variable to which the data is written.

Control Amount of Data Saved

If you specify data logging intervals with the **Configuration Parameters > Data Import/Export > Logging intervals** parameter, the To Workspace block does not log data outside of the intervals. For example, the block logs no data if the intervals are empty (`[]`). The block stores the logged data in the variable that you specify for the **Single simulation output** parameter.

For variable-step solvers, to control the amount of data available to the To Workspace block, use the **Configuration Parameters > Data Import/Export > Additional parameters > Output options** parameter. For example, to write data at identical time points over multiple simulations, select the `Produce specified output only` option.

Block parameters also control the amount of data saved. See “Limit data points to last” on page 1-0 , “Decimation” on page 1-0 , and “Sample time” on page 1-0 .

Log to MAT-File

When you enable the **MAT-file logging** parameter in **Configuration Parameters**, the To Workspace block logs its data to a MAT-file. For information about this parameter, see “MAT-file logging” (Simulink Coder).

Ports

Input

Port_1 — Input signal

scalar | vector | matrix | N-D array

Workspace data created from input signal. The To Workspace block can save real or complex inputs of any data type that Simulink supports, including fixed-point and enumerated data types, and bus objects.

By default, the To Workspace block treats input signals as sample-based. To have the To Workspace block treat input signals as frame-based, set:

- 1 **Save format** to either Array or Structure
- 2 **Save 2-D signals as** to 2-D array (concatenate along first dimension)

Data Types: single | double | int8 | int16 | int32 | int64 | uint8 | uint16 | uint32 | uint64 | Boolean | fixed point | enumerated | bus

Parameters

Variable name — Name of variable for saved data

simout (default) | character vector

Specify the name of the variable for the saved data.

Programmatic Use

Block Parameter: VariableName

Type: character vector

Values: character vector

Default: 'simout'

Limit data points to last — Maximum number of input samples to save

inf (default) | scalar | vector

Specify the maximum number of input samples to save. If the simulation generates more data points than the specified maximum, the simulation saves only the most recently generated samples. The default value causes the block to write all data.

Programmatic Use

Block Parameter: MaxDataPoints

Type: character vector

Values: scalar | vector

Default: 'inf'

Decimation — Decimation factor that determines when data writes

1 (default) | scalar | vector

Specify the decimation factor, n , which writes data at every n th time that the block executes. The default value causes the block to write data at every time step.

Programmatic Use

Block Parameter: Decimation

Type: character vector

Values: scalar | vector

Default: '1'

Save format — Format for saving simulation output

Timeseries (default) | Structure With Time | Structure | Array

Specify the format for saving simulation output to the workspace.

The default `Timeseries` format saves nonbus signals as a MATLAB `timeseries` object and bus signals as a structure of MATLAB `timeseries` objects.

The `Array` format saves the input as an N -dimensional array where N is one more than the number of dimensions of the input signal. For example, if the input signal is a vector, the resulting workspace array is two-dimensional. If the input signal is a matrix, then the array is three-dimensional. How Simulink stores samples in the array depends on whether the input signal is a scalar, vector, or matrix.

- If the input signal is a scalar or a vector, each input sample is output as a row of the array. Suppose that the name of the output array is `simout`. Then, `simout(1, :)` corresponds to the first sample, `simout(2, :)` corresponds to the second sample, and so on.
- If the input signal is a matrix, time corresponds to the third dimension. Suppose again that `simout` is the name of the resulting workspace array. Then, `simout(:, :, 1)` is the input signal value at the first sample point, `simout(:, :, 2)` is the input signal value at the second sample point, and so on.

The `Structure` format consists of a structure with three fields:

- `time` — Empty field for this format.
- `signals` — Structure with three fields: `values`, `dimensions`, and `label`. The `values` field contains the array of signal values. The `dimensions` field specifies the dimensions of the corresponding signals. The `label` field contains the label of the input line.
- `blockName` — Name of the To Workspace block.

The `Structure With Time` format is the same as `Structure`, except that the `time` field contains a vector of simulation time hits.

If you select `Array` or `Structure`, the **Save 2-D signals as** parameter appears.

To read the To Workspace block output directly with a From Workspace block, use either the `Timeseries` or `Structure with Time` format. The From Workspace block can read sample-based data from a To Workspace block that was saved in a previous simulation. For details, see “Comparison of Signal Loading Techniques”.

The following table shows how simulation mode support depends on the **Save format** value.

| Simulation Mode | Timeseries | Array, Structure, or Structure With Time |
|-----------------|------------|--|
| Normal | Supported | Supported |
| Accelerator | Supported | Supported only in top model, not referenced models |

| Simulation Mode | Timeseries | Array, Structure, or Structure With Time |
|-----------------------------|---------------|--|
| Rapid Accelerator | Not supported | Supported only in top model, not referenced models |
| Software-in-the-loop (SIL) | Not supported | If MAT-file logging is enabled, supported only in top model, not referenced models |
| Processor-in-the-loop (PIL) | Not supported | If MAT-file logging is available and enabled, supported only in top model, not referenced models |
| External | Not supported | Supported only in top model, not referenced models |
| Simulink Coder Targets | Not supported | If MAT-file logging is enabled, supported only in top model, not referenced models |

Programmatic Use**Block Parameter:** SaveFormat**Type:** character vector**Values:** 'Timeseries' | 'Structure with Time' | 'Structure' | 'Array'**Default:** 'Timeseries'**Save 2-D signal as — Format for saving 2-D signals**

3-D array (concatenate along third dimension) (default) | 2-D array (concatenate along first dimension)

Specify one of these formats for saving 2-D signals to the workspace:

- 3-D array (concatenate along third dimension) (Default)

This setting is well-suited for sample-based signals. Data is concatenated along the third dimension. For example, 2-by-4 matrix input for 10 samples is stored as a 2-by-4-by-10 array.

- 2-D array (concatenate along first dimension)

This setting is well-suited for frame-based signals. Data is concatenated along the first dimension. For example, 2-by-4 matrix input for 10 samples is stored as a 20-by-4 array.

When the **Save format** is set to Array or Structure, the dimensions of the output depend on the input dimensions and the setting of the **Save 2-D signals as** parameter. The following table summarizes the output dimensions under various conditions. In the table, *K* represents the value of the **Limit data points to last** parameter.

| Input Signal Dimensions | Save 2-D Signals As ... | Signal to Workspace Output Dimension |
|--------------------------------------|---|---|
| M -by- N matrix | 2-D array (concatenate along first dimension) | K -by- N matrix. If you set the Limit data points to last parameter to <code>inf</code> , K represents the total number of samples acquired in each column by the end of simulation. This setting is equivalent to multiplying the input frame size (M) by the total number of M -by- N inputs acquired by the block. |
| M -by- N matrix | 3-D array (concatenate along third dimension) | M -by- N -by- K array. If you set the Limit data points to last parameter to <code>inf</code> , K represents the total number of M -by- N inputs acquired by the end of the simulation. |
| Length- N unoriented vector | Any setting | K -by- N matrix |
| N -dimensional array where $N > 2$ | Any setting | Array with $N + 1$ dimensions, where the size of the last dimension is equal to K . If you set the Limit data points to last parameter to <code>inf</code> , K represents the total number of M -by- N inputs acquired by the end of simulation |

Dependencies

To enable the **Save 2-D signals as** parameter, set the **Save format** to Array or Structure.

Programmatic Use

Block Parameter: Save2DSignal

Type: character vector

Values: '2-D array (concatenate along first dimension)' | '3-D array (concatenate along third dimension)'

Default: '3-D array (concatenate along third dimension)'

Log fixed-point data as a fi object — Log fixed-point data as a fi object or double
off (default) | on

By default, the To Workspace block logs fixed-point data to the MATLAB workspace as a Fixed-Point Designer `fi` object. If you clear this parameter, Simulink software logs fixed-point data to the workspace as double.

Programmatic Use

Block Parameter: FixptAsFi

Type: character vector

Values: 'off' | 'on'

Default: 'off'

Sample time — Sample period and offset

-1 (default) | scalar | vector

Specifies the sample period and offset at which to collect data points. This parameter is useful when you are using a variable-step solver where the interval between time steps is not constant. The default value causes the block to inherit the sample time from the driving block. See “Specify Sample Time”.

Programmatic Use

Block Parameter: SampleTime

Type: character vector

Values: scalar | vector

Default: '-1'

Block Characteristics

| | |
|---------------------------------|--|
| Data Types | Boolean bus double enumerated fixed point integer single |
| Direct Feedthrough | no |
| Multidimensional Signals | yes |
| Variable-Size Signals | yes |
| Zero-Crossing Detection | no |

Tips

To make post-processing easier, you can convert data saved by this block to **Dataset** format. This conversion is useful when post processing this data with other logged data that can use **Dataset** format (for example, logged states). See “Convert Logged Data to Dataset Format”.

Extended Capabilities

HDL Code Generation

Generate Verilog and VHDL code for FPGA and ASIC designs using HDL Coder™.

This block can be used for simulation visibility in subsystems that generate HDL code, but is not included in the hardware implementation.

PLC Code Generation

Generate Structured Text code using Simulink® PLC Coder™.

Fixed-Point Conversion

Design and simulate fixed-point systems using Fixed-Point Designer™.

See Also

From Workspace | Record | To File | From File

Topics

“Export Simulation Data”

“Specify Signal Values to Log”

“Convert Logged Data to Dataset Format”

Introduced before R2006a

Toggle Switch

Change parameter or variable value using switch with customizable appearance

Library: Simulink / Dashboard / Customizable Blocks



Description

Use the Toggle Switch block to change the value of the connected variable or parameter before or during simulation. When you use the Toggle Switch block in the Customizable Blocks library, you can customize the appearance of the block to look like a real switch in your system and configure any number of states to customize the behavior. For example, you could design a three-way toggle switch or a switch that represents a gear shift. Use the Toggle Switch block with other dashboard blocks to create an interactive dashboard for your model.

Double-clicking the Toggle Switch block does not open its dialog box during simulation or when the block is selected. To edit the block parameters, you can use the Property Inspector or open the block dialog box by:

- Double-clicking the block when the block is not selected and the model is not simulating.
- Right-clicking the block and selecting **Block Parameters** from the context menu.

Customize Toggle Switch Blocks

When you add a Toggle Switch block to your model, the block is preconfigured with a default design. You can use the block with the default design or customize the appearance of the block. When you design a switch using the Toggle Switch block, you can add any number of states to the block. For each state, you can:

- Add an image that defines the appearance of the block in that state.
- Specify the value for the block to assign to the connected variable or parameter.
- Specify the label text, color, and position for the state and whether the label is visible on the block design.
- Configure the size and position of the click area for the state. When you click the click area for a state, the block transitions to that state.

You can also design the block background and foreground, which apply for all states. To configure the foreground for the block, upload a foreground image. To configure the background for the block, you can upload a background image or use a solid background color.

To customize the appearance of the block, use design mode. You can enter design mode in one of three ways after selecting the block:

- On the **Button** tab, under **Design**, click **Edit**.
- In the **Property Inspector**, on the **Design** tab, click **Edit Design**.
- Pause on the ellipsis that appears above the block and click the **Edit Custom Block** button.

Design mode gives you access to block parameters and settings that allow you to customize the appearance of the block. You can use the toolbar above the block to configure the image, the icon, and the label color and opacity for each state. For more customization options, use the **Design** tab in the Property Inspector.

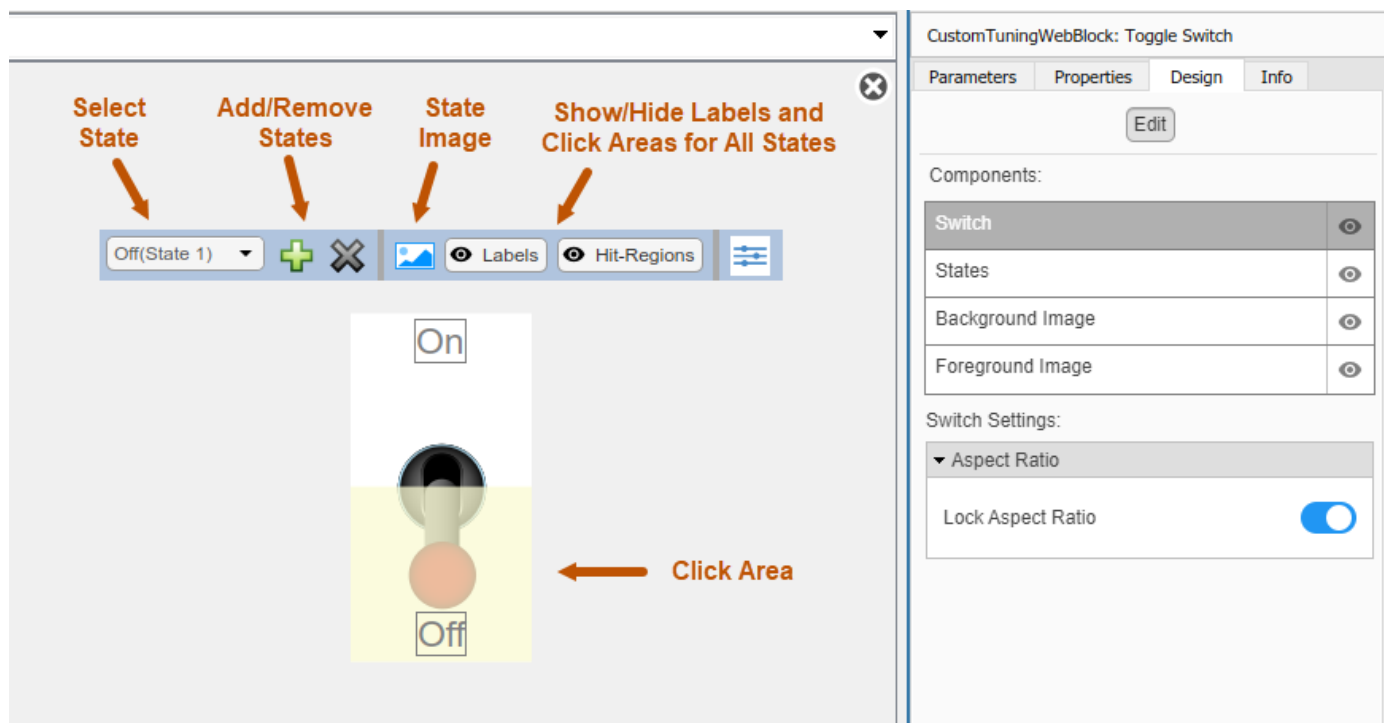

When you finish designing the switch, click **Exit** in the upper-right of the canvas to exit design mode.

Connect Dashboard Blocks

Dashboard blocks do not use ports to connect to model elements. To connect dashboard blocks to variables and block parameters, use connect mode. Connect mode facilitates the process of connecting dashboard blocks in your model, especially when you want to connect multiple blocks at once. To connect a single dashboard block, you can also use the **Connection** table in the block dialog box.

Tip You can modify dashboard block connections in your model during normal and accelerator mode simulations.

Note Dashboard blocks cannot connect to variables until you update the model diagram. To connect dashboard blocks to variables or modify variable values between opening your model and running a simulation, update the model diagram using **Ctrl+D**.

To enter connect mode, select the block. Then, on the block tab, click **Connect**. In connect mode, when you select one or more blocks, a list of parameters and variables available for connection appears. Select a variable or parameter from the list to connect to the selected dashboard block.

When the value of the selected variable or block parameter is nonscalar, use the text box at the bottom of the **Connection** table to specify the element you want to connect to the dashboard block. To connect to an element of a vector, matrix, or array, specify the element index, for example, 3 or (1, 3). To connect to an element in a bus or structure, specify the element in the context of the bus or structure hierarchy by using dots to indicate different levels in the hierarchy, and omit the top level. For example, specify a.b to connect to scalar element b of the structure or bus a nested inside the selected composite variable or parameter.

To connect another dashboard block, pause on another dashboard block and click the **Connect** button above it. Then, make a selection of signals and blocks in your model and choose a model element to connect.

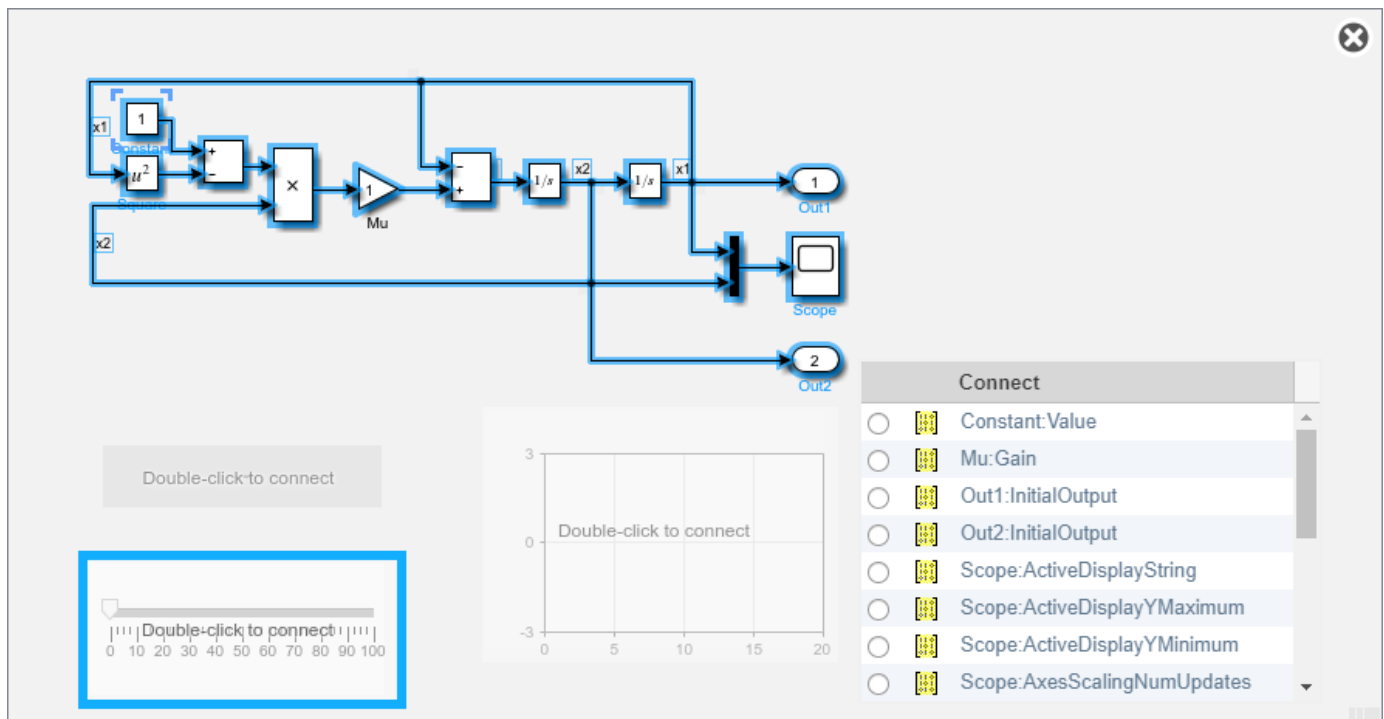

When you finish connecting the dashboard blocks in your model, on the block tab, click **Done Connecting**.

Tip You can hide the message shown on unconnected blocks using the `set_param` function with the `ShowInitialText` block parameter. The message also disappears when you connect the block.

Parameter Logging

Tunable parameters connected to dashboard blocks are logged to the Simulation Data Inspector, where you can view the parameter values along with logged signal data. You can access logged parameter data in the MATLAB workspace by exporting the parameter data from the Simulation Data Inspector by using the UI or the `Simulink.sdi.exportRun` function. For more information about exporting data using the Simulation Data Inspector UI, see “Export Data to the Workspace or a File”. The parameter data is stored in a `Simulink.SimulationData.Parameter` object, accessible as an element in the exported `Simulink.SimulationData.Dataset`.

Limitations

- Except for the Dashboard Scope block and the Display block, dashboard blocks can only connect to real scalar signals.
- The toolstrip does not support blocks that are inside a panel.
- You cannot use the **Connection** table in the block dialog to connect a dashboard block to a block that is commented out. When you connect a dashboard block to a commented block using connect mode, the dashboard block does not display the connected value until the you uncomment the block.
- Dashboard blocks cannot connect to model elements inside referenced models.
- When you simulate a model hierarchy, dashboard blocks inside referenced models do not update.
- Dashboard blocks do not support rapid accelerator simulation.
- When you connect a dashboard block to a variable or parameter during simulation, the data for that variable or parameter is not logged to the Simulation Data Inspector. To log variable and parameter data to the Simulation Data Inspector, connect the dashboard block to the variable or parameter prior to simulation.
- When you simulate a model in external mode with the **Default parameter behavior** set to **Inlined**, dashboard blocks can appear to change parameter and variable values. However, the change does not propagate to the simulation. For example, Gain blocks display changes made to the **Gain** parameter using the dashboard blocks, but the **Gain** value used in the simulation does not change.

Parameters

Connection — Select a variable or block parameter to connect

variable and parameter connection options

Select the variable or block parameter to control using the **Connection** table. To connect the block to a signal:

- 1 Make a selection in the model that includes one or more blocks.
- 2 Select the variable or parameter you want to connect.

When the value of the selected variable or block parameter is nonscalar, use the text box at the bottom of the **Connection** table to specify the element you want to connect to the dashboard block. To connect to an element of a vector, matrix, or array, specify the element index, for example, 3 or (1, 3). To connect to an element in a bus or structure, specify the element in the context of the bus or structure hierarchy by using dots to indicate different levels in the hierarchy, and omit the top level. For example, specify `a.b` to connect to scalar element `b` of the structure or bus `a` nested inside the selected composite variable or parameter.

3 Click **Apply**.

To facilitate understanding and debugging your model, you can connect Dashboard blocks to variables and parameters in your model during simulation.

Note To see workspace variables in the connection table, update the model diagram using **Ctrl+D**.

Programmatic Use

To programmatically connect a dashboard block to a tunable parameter or a variable, use a `Simulink.HMI.ParamSourceInfo` object. The `Simulink.HMI.ParamSourceInfo` object contains four properties. Some of the properties apply to connecting dashboard blocks to parameters, and some apply to connecting dashboard blocks to variables. Not all fields have a value for a connection because a given dashboard block connects to either a parameter or a variable.

Block Parameter: Binding

Type: `Simulink.HMI.ParamSourceInfo`

Default: `[]`

States — Block state labels and values

scalar and character vector

Each state pairs a **State Value** with a **State Label**. When the block is in a given state, it assigns the **State Value** for that state to the connected variable or parameter. You can use the **State Label** to display the value assigned to the connected variable or parameter on the block or to provide a descriptive text label. Using the **Design** tab in the Property Inspector, you can choose to show or hide the specified **State Label** in the block design.

By default, the switch has two states:

- In the **Off** state, the block assigns the connected variable or parameter a value of 0.
- In the **On** state, the block assigns the connected variable or parameter a value of 1.

You can use a customizable switch block to design a block with any number of states. Click the **+** button to add a state.

Tips

You can also configure the states for the block in design mode, by using the toolbar above the block or the **Design** tab in the Property Inspector.

Label — Block label position

Top (default) | Bottom | Hide

Position of the block label. When the block is connected to an element in the model, the label is the name of the connected element.

Programmatic Use

Block Parameter: `LabelPosition`

Type: character vector

Values: 'Top' | 'Bottom' | 'Hide'

Default: 'Top'

Lock Aspect Ratio — Whether to maintain block aspect ratio

on (default) | off

Whether to maintain the block aspect ratio when resizing the block and when you specify a new background image.

Block Characteristics

| | |
|---------------------------------|----------------------------------|
| Data Types | double half integer single |
| Direct Feedthrough | no |
| Multidimensional Signals | no |
| Variable-Size Signals | no |
| Zero-Crossing Detection | no |

Tips

- When you want to design a circular switch that distributes the state labels and the click areas that cause state transitions on an arc, consider using the Rotary Switch block.
- To design a control that applies values to a connected variable or parameter from a continuous range, use the Knob, Horizontal Slider, or Vertical Slider blocks.

Extended Capabilities

C/C++ Code Generation

Generate C and C++ code using Simulink® Coder™.

Dashboard blocks are ignored for code generation.

See Also

Rocker Switch | Slider Switch

Introduced in R2021b

Toggle Switch

Toggle parameter between two values

Library: Simulink / Dashboard



Description

The Toggle Switch block toggles the value of the connected block parameter between two values during simulation. For example, you can connect the Toggle Switch block to a Switch block in your model and change its state during simulation. Use the Toggle Switch block with other Dashboard blocks to create an interactive dashboard for your model.

Double-clicking the Toggle Switch block does not open its dialog box during simulation and when the block is selected. To edit the block's parameters, you can use the **Property Inspector**, or you can right-click the block and select **Block Parameters** from the context menu.

Connect Dashboard Blocks

Dashboard blocks do not use ports to connect to model elements. To connect dashboard blocks to variables and block parameters, use connect mode. Connect mode facilitates the process of connecting dashboard blocks in your model, especially when you want to connect multiple blocks at once. To connect a single dashboard block, you can also use the **Connection** table in the block dialog box.

Tip You can modify dashboard block connections in your model during normal and accelerator mode simulations.

Note Dashboard blocks cannot connect to variables until you update the model diagram. To connect dashboard blocks to variables or modify variable values between opening your model and running a simulation, update the model diagram using **Ctrl+D**.

To enter connect mode, select the block. Then, on the block tab, click **Connect**. In connect mode, when you select one or more blocks, a list of parameters and variables available for connection appears. Select a variable or parameter from the list to connect to the selected dashboard block.

When the value of the selected variable or block parameter is nonscalar, use the text box at the bottom of the **Connection** table to specify the element you want to connect to the dashboard block. To connect to an element of a vector, matrix, or array, specify the element index, for example, 3 or (1, 3). To connect to an element in a bus or structure, specify the element in the context of the bus or structure hierarchy by using dots to indicate different levels in the hierarchy, and omit the top level. For example, specify a.b to connect to scalar element b of the structure or bus a nested inside the selected composite variable or parameter.

To connect another dashboard block, pause on another dashboard block and click the **Connect** button above it. Then, make a selection of signals and blocks in your model and choose a model element to connect.

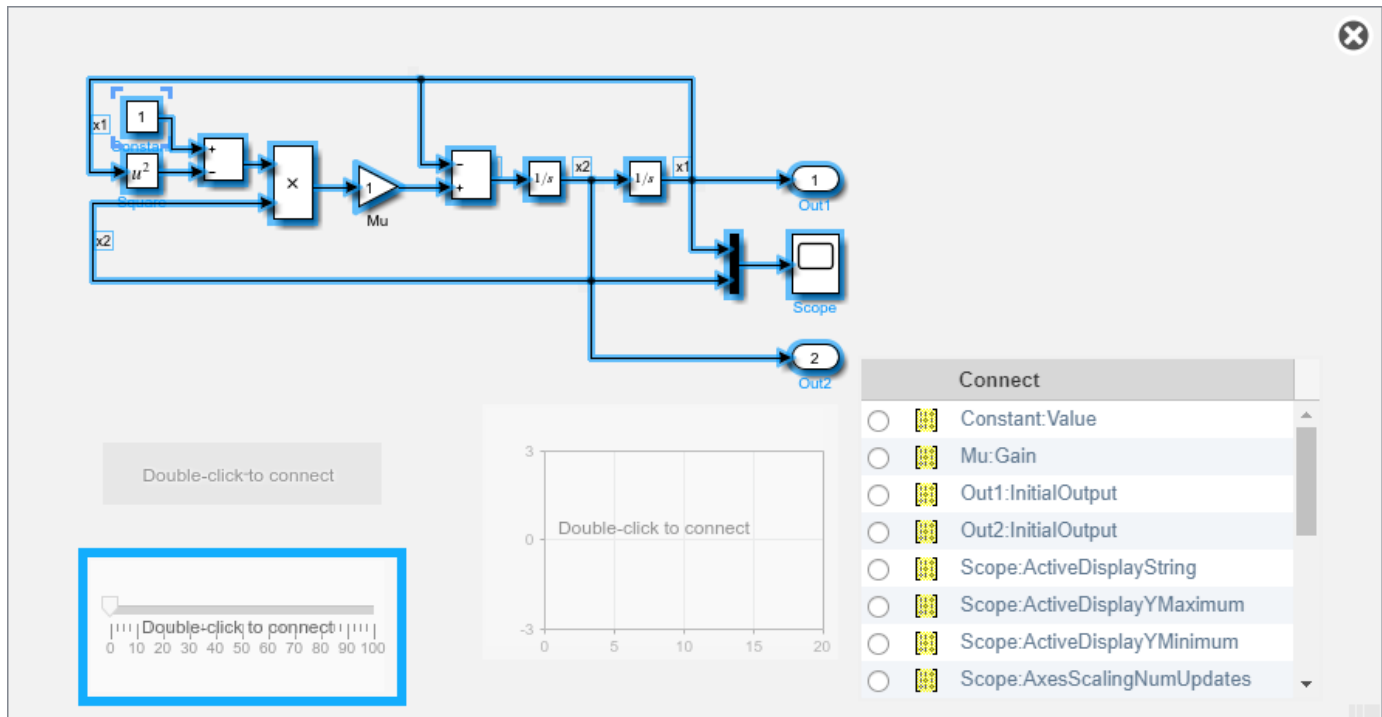

When you finish connecting the dashboard blocks in your model, on the block tab, click **Done Connecting**.

Tip You can hide the message shown on unconnected blocks using the `set_param` function with the `ShowInitialText` block parameter. The message also disappears when you connect the block.

Parameter Logging

Tunable parameters connected to dashboard blocks are logged to the Simulation Data Inspector, where you can view the parameter values along with logged signal data. You can access logged parameter data in the MATLAB workspace by exporting the parameter data from the Simulation Data Inspector by using the UI or the `Simulink.sdi.exportRun` function. For more information about exporting data using the Simulation Data Inspector UI, see “Export Data to the Workspace or a File”. The parameter data is stored in a `Simulink.SimulationData.Parameter` object, accessible as an element in the exported `Simulink.SimulationData.Dataset`.

Limitations

- Except for the Dashboard Scope block and the Display block, dashboard blocks can only connect to real scalar signals.
- The toolstrip does not support blocks that are inside a panel.
- You cannot use the **Connection** table in the block dialog to connect a dashboard block to a block that is commented out. When you connect a dashboard block to a commented block using connect

mode, the dashboard block does not display the connected value until the you uncomment the block.

- Dashboard blocks cannot connect to model elements inside referenced models.
- When you simulate a model hierarchy, dashboard blocks inside referenced models do not update.
- Dashboard blocks do not support rapid accelerator simulation.
- When you connect a dashboard block to a variable or parameter during simulation, the data for that variable or parameter is not logged to the Simulation Data Inspector. To log variable and parameter data to the Simulation Data Inspector, connect the dashboard block to the variable or parameter prior to simulation.
- When you simulate a model in external mode with the **Default parameter behavior** set to **Inlined**, dashboard blocks can appear to change parameter and variable values. However, the change does not propagate to the simulation. For example, Gain blocks display changes made to the **Gain** parameter using the dashboard blocks, but the **Gain** value used in the simulation does not change.

Parameters

Connection — Select a variable or block parameter to connect

variable and parameter connection options

Select the variable or block parameter to control using the **Connection** table. To connect the block to a signal:

- 1 Make a selection in the model that includes one or more blocks.
- 2 Select the variable or parameter you want to connect.

When the value of the selected variable or block parameter is nonscalar, use the text box at the bottom of the **Connection** table to specify the element you want to connect to the dashboard block. To connect to an element of a vector, matrix, or array, specify the element index, for example, 3 or (1, 3). To connect to an element in a bus or structure, specify the element in the context of the bus or structure hierarchy by using dots to indicate different levels in the hierarchy, and omit the top level. For example, specify a.b to connect to scalar element b of the structure or bus a nested inside the selected composite variable or parameter.

- 3 Click **Apply**.

To facilitate understanding and debugging your model, you can connect Dashboard blocks to variables and parameters in your model during simulation.

Note To see workspace variables in the connection table, update the model diagram using **Ctrl+D**.

Programmatic Use

To programmatically connect a dashboard block to a tunable parameter or a variable, use a `Simulink.HMI.ParamSourceInfo` object. The `Simulink.HMI.ParamSourceInfo` object contains four properties. Some of the properties apply to connecting dashboard blocks to parameters, and some apply to connecting dashboard blocks to variables. Not all fields have a value for a connection because a given dashboard block connects to either a parameter or a variable.

Block Parameter: Binding

Type: Simulink.HMI.ParamSourceInfo

Default: []

States — Pair values and labels

scalar and character vector

Pairs of values to assign to the connected variable or parameter and text to display on the block. Switches have two states — **Top** and **Bottom** — one corresponding to each switch position. Each state contains a **Value** and a **Label**.

- **Value** — Value to assign to the connected variable or parameter when the switch is in the corresponding position.
- **Label** — Text to display on the block for the corresponding position.

This table describes the default configuration for the block.

States

| Position | State Value | State Label |
|----------|-------------|-------------|
| Top | 0 | on |
| Bottom | 1 | off |

Programmatic Use

To configure the **States** for the block programmatically, specify the value of the **States** parameter as a structure array containing two elements with fields:

- **Value** — Scalar double value for the state.
- **Label** — String or character array to use as the label for the switch position.

```
topState.Value = 0;
topState.Label = 'Off';
bottomState.Value = 1;
bottomState.Label = 'On';
switchStates = [topState bottomState];
```

Block Parameter: States

Type: two element array of structures

Label — Block label position

Top (default) | Bottom | Hide

Position of the block label. When the block is connected to an element in the model, the label is the name of the connected element.

Programmatic Use

Block Parameter: LabelPosition

Type: character vector

Values: 'Top' | 'Bottom' | 'Hide'

Default: 'Top'

Block Characteristics

| | |
|---------------------------------|----------------------------------|
| Data Types | double half integer single |
| Direct Feedthrough | no |
| Multidimensional Signals | no |
| Variable-Size Signals | no |
| Zero-Crossing Detection | no |

Extended Capabilities

C/C++ Code Generation

Generate C and C++ code using Simulink® Coder™.

Dashboard blocks are ignored for code generation.

See Also

Rocker Switch | Slider Switch | Rotary Switch

Topics

“Tune and Visualize Your Model with Dashboard Blocks”

“Decide How to Visualize Simulation Data”

Introduced in R2015a

To String

Convert input signal to string signal

Library: Simulink / String

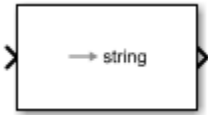

Description

The To String block creates a string signal from an input signal. For example, consider using this signal to convert a logical value 1 or 0 to its string equivalent "false" or "true".

When a MinGW compiler compiles code generated from the block, running the compiled code may produce nonstandard results for floating-point inputs. For example, a numeric input of 501.987 returns the string "5.019870e+002" instead of the expected string "5.019870e+02".

Ports

Input

Port_1 — Input signal

scalar

Input signal, specified as a scalar.

Data Types: single | double | int8 | int16 | int32 | int64 | uint8 | uint16 | uint32 | uint64 | Boolean | fixed point | enumerated

Output

Port_1 — Output string

scalar

Output string, specified as a scalar. This block returns the output as a string, surrounded by double quotes.

- If the input is a Boolean, the output is a logical value (1 or 0) and the block returns its textual equivalent (true or false).
- If the input is a numeric data type, such as an integer, single, double, or fixed point, the block returns the number as a string. For example, an input of 1 converts to "1" and an input of 0 converts to "0".

Note The output string might not contain all the digits of the numeric value from the input port.

Data Types: string

Block Characteristics

| | |
|---------------------------------|---|
| Data Types | Boolean double enumerated fixed point integer single string |
| Direct Feedthrough | yes |
| Multidimensional Signals | no |
| Variable-Size Signals | no |
| Zero-Crossing Detection | no |

Extended Capabilities

C/C++ Code Generation

Generate C and C++ code using Simulink® Coder™.

Fixed-Point Conversion

Design and simulate fixed-point systems using Fixed-Point Designer™.

See Also

ASCII to String | Compose String | Scan String | String Compare | String Concatenate | String Constant | String Find | String Length | String to Double | String to Single | String To Enum | String To ASCII | Substring

Topics

“Get Text Following a Keyword”

“Simulink Strings”

Introduced in R2018a

Transfer Fcn

Model linear system by transfer function

Library: Simulink / Continuous

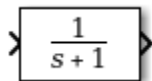

Description

The Transfer Fcn block models a linear system by a transfer function of the Laplace-domain variable s . The block can model single-input single-output (SISO) and single-input multiple-output (SIMO) systems.

Conditions for Using This Block

The Transfer Fcn block assumes the following conditions:

- The transfer function has the form

$$H(s) = \frac{y(s)}{u(s)} = \frac{num(s)}{den(s)} = \frac{num(1)s^{nn-1} + num(2)s^{nn-2} + \dots + num(nn)}{den(1)s^{nd-1} + den(2)s^{nd-2} + \dots + den(nd)},$$

where u and y are the system input and outputs, respectively, nn and nd are the number of numerator and denominator coefficients, respectively. $num(s)$ and $den(s)$ contain the coefficients of the numerator and denominator in descending powers of s .

- The order of the denominator must be greater than or equal to the order of the numerator.
- For a multiple-output system, all transfer functions have the same denominator and all numerators have the same order.

Modeling a Single-Output System

For a single-output system, the input and output of the block are scalar time-domain signals. To model this system:

- 1 Enter a vector for the numerator coefficients of the transfer function in the **Numerator coefficients** field.
- 2 Enter a vector for the denominator coefficients of the transfer function in the **Denominator coefficients** field.

Modeling a Multiple-Output System

For a multiple-output system, the block input is a scalar and the output is a vector, where each element is an output of the system. To model this system:

- 1 Enter a matrix in the **Numerator coefficients** field.

Each *row* of this matrix contains the numerator coefficients of a transfer function that determines one of the block outputs.

- 2 Enter a vector of the denominator coefficients common to all transfer functions of the system in the **Denominator coefficients** field.

Specifying Initial Conditions

A transfer function describes the relationship between input and output in Laplace (frequency) domain. Specifically, it is defined as the Laplace transform of the response (output) of a system with zero initial conditions to an impulse input.

Operations like multiplication and division of transfer functions rely on zero initial state. For example, you can decompose a single complicated transfer function into a series of simpler transfer functions. Apply them sequentially to get a response equivalent to that of the original transfer function. This will not be correct if one of the transfer functions assumes a non-zero initial state. Furthermore, a transfer function has infinitely many time domain realizations, most of whose states do not have any physical meaning.

For these reasons, Simulink presets the initial conditions of the Transfer Fcn block to zero. To specify initial conditions for a given transfer function, convert the transfer function to its controllable, canonical state-space realization using `tf2ss`. Then, use the State-Space block. The `tf2ss` utility provides the A, B, C, and D matrices for the system.

For more information, type `help tf2ss` or see the Control System Toolbox™ documentation.

Transfer Function Display on the Block

The Transfer Fcn block displays the transfer function depending on how you specify the numerator and denominator parameters.

- If you specify each parameter as an expression or a vector, the block shows the transfer function with the specified coefficients and powers of s . If you specify a variable in parentheses, the block evaluates the variable.

For example, if you specify **Numerator coefficients** as `[3, 2, 1]` and **Denominator coefficients** as `(den)`, where `den` is `[7, 5, 3, 1]`, the block looks like this:

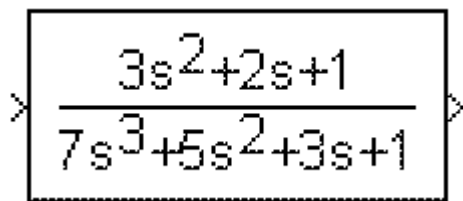

$$\frac{3s^2 + 2s + 1}{7s^3 + 5s^2 + 3s + 1}$$

- If you specify each parameter as a variable, the block shows the variable name followed by (s) .

For example, if you specify **Numerator coefficients** as `num` and **Denominator coefficients** as `den`, the block looks like this:

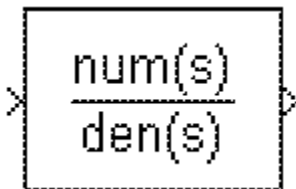

$$\frac{\text{num}(s)}{\text{den}(s)}$$

Ports

Input

Port_1 — Input signal

scalar

Input signal, specified as a scalar with data type double.

Data Types: double

Output

Port_1 — Output signal

scalar | vector

Output signal, provided as a scalar or vector with data type double.

- For a single-output system, the input and output of the block are scalar time-domain signals.
- For a multiple-output system, the input is a scalar, and the output is a vector, where each element is an output of the system.

Data Types: double

Parameters

Numerator coefficients — Vector or matrix of numerator coefficients

[1] (default) | vector | matrix

Define the numerator coefficients of the transfer function.

- For a single-output system, enter a vector for the numerator coefficients of the transfer function.
- For a multiple-output system, enter a matrix. Each row of this matrix contains the numerator coefficients of a transfer function that determines one of the block outputs.

Programmatic Use

Block Parameter: Numerator

Type: character vector, string

Values: vector | matrix

Default: ' [1] '

Denominator coefficients — Row vector of denominator coefficients

[1 1] (default) | vector

Define the row vector of denominator coefficients.

- For a single-output system, enter a vector for the denominator coefficients of the transfer function.
- For a multiple-output system, enter a vector containing the denominator coefficients common to all transfer functions of the system.

Programmatic Use

Block Parameter: Denominator

Type: character vector | string

Values: vector
Default: '[1 1]'

Parameter tunability — Tunable representation of block parameters in code

Auto (default) | Optimized | Unconstrained

Tunability level of the numerator and denominator coefficients for Accelerated simulation modes and deployed simulations using Simulink Compiler. Set this parameter to Auto to allow Simulink to choose the appropriate level of parameter tunability.

Set this parameter to Optimized to generate a representation of numerator and denominator coefficients in generated code for accelerated and deployed simulations that is optimized for better simulation performance.

Set this parameter to Unconstrained to generate a fully tunable (between simulations) representation of the numerator and denominator coefficients in the generated code for accelerated and deployed simulations. To let Simulink determine the appropriate tunability level, select Auto .

Programmatic Use

Block Parameter: ParameterTunability

Type: character vector, string

Values: 'Auto' | 'Optimized' | 'Unconstrained'

Default: 'Auto'

Absolute tolerance — Absolute tolerance for computing block states

auto (default) | scalar | vector

Absolute tolerance for computing block states, specified as a positive, real-valued, scalar or vector. To inherit the absolute tolerance from the Configuration Parameters, specify auto or -1.

- If you enter a real scalar, then that value overrides the absolute tolerance in the Configuration Parameters dialog box for computing all block states.
- If you enter a real vector, then the dimension of that vector must match the dimension of the continuous states in the block. These values override the absolute tolerance in the Configuration Parameters dialog box.
- If you enter auto or -1, then Simulink uses the absolute tolerance value in the Configuration Parameters dialog box (see “Solver Pane”) to compute block states.

Programmatic Use

Block Parameter: AbsoluteTolerance

Type: character vector, string

Values: 'auto' | '-1' | any positive real-valued scalar or vector

Default: 'auto'

State Name (e.g., 'position') — Assign unique name to each state

' ' (default) | 'position' | {'a', 'b', 'c'} | a | ...

Assign a unique name to each state. If this field is blank (' '), no name assignment occurs.

- To assign a name to a single state, enter the name between quotes, for example, 'position'.
- To assign names to multiple states, enter a comma-delimited list surrounded by braces, for example, {'a', 'b', 'c'}. Each name must be unique.
- To assign state names with a variable in the MATLAB workspace, enter the variable without quotes. A variable can be a character vector, string, cell array, or structure.

Limitations

- The state names apply only to the selected block.
- The number of states must divide evenly among the number of state names.
- You can specify fewer names than states, but you cannot specify more names than states.

For example, you can specify two names in a system with four states. The first name applies to the first two states and the second name to the last two states.

Programmatic Use

Block Parameter: ContinuousStateAttributes

Type: character vector, string

Values: ' ' | user-defined

Default: ' '

Block Characteristics

| | |
|---------------------------------|--------|
| Data Types | double |
| Direct Feedthrough | yes |
| Multidimensional Signals | no |
| Variable-Size Signals | no |
| Zero-Crossing Detection | no |

Extended Capabilities**C/C++ Code Generation**

Generate C and C++ code using Simulink® Coder™.

Not recommended for production-quality code. Relates to resource limits and restrictions on speed and memory often found in embedded systems. The code generated can contain dynamic allocation and freeing of memory, recursion, additional memory overhead, and widely-varying execution times. While the code is functionally valid and generally acceptable in resource-rich environments, smaller embedded targets often cannot support such code.

In general, consider using the Simulink Model Discretizer to map continuous blocks into discrete equivalents that support production code generation. To start the Model Discretizer, in the Simulink Editor, on the **Apps** tab, under **Apps**, under **Control Systems**, click **Model Discretizer**. One exception is the Second-Order Integrator block because, for this block, the Model Discretizer produces an approximate discretization.

See Also

Discrete Transfer Fcn | State-Space

Topics

“State”

Introduced before R2006a

Transfer Fcn Direct Form II

Implement Direct Form II realization of transfer function

Library: Simulink / Additional Math & Discrete / Additional Discrete

$$\frac{0.2+0.3z^{-1}+0.2z^{-2}}{1-0.9z^{-1}+0.6z^{-2}}$$

Description

The Transfer Fcn Direct Form II block implements a Direct Form II realization of the transfer function that the **Numerator coefficients** and **Denominator coefficients excluding lead** parameters specify. The block supports only single input-single output (SISO) transfer functions.

The block automatically selects the data types and scalings of the output, the coefficients, and any temporary variables.

Ports

Input

Port_1 — Input signal

scalar | vector

Input signal, specified as a scalar or vector.

Data Types: single | double | int8 | int16 | int32 | int64 | uint8 | uint16 | uint32 | uint64 | fixed point

Output

Port_1 — Output signal

scalar | vector

Output signal, specified as a scalar or vector.

Data Types: single | double | int8 | int16 | int32 | int64 | uint8 | uint16 | uint32 | uint64 | fixed point

Parameters

Numerator coefficients — Numerator coefficients

[0.2 0.3 0.2] (default) | vector

Specify the numerator coefficients as a vector.

Programmatic Use

Block Parameter: NumCoefVec

Type: character vector

Values: vector

Default: '[0.2 0.3 0.2]'

Denominator coefficients excluding lead — Denominator coefficient

[-0.9 0.6] (default) | vector

Specify the denominator coefficients, excluding the leading coefficient, which must be 1.0.

Programmatic Use**Block Parameter:** DenCoeffVec**Type:** character vector**Values:** vector**Default:** '[-0.9 0.6]'**Initial condition — Initial condition**

0.0 (default) | scalar

Specify the initial condition as a scalar.

Programmatic Use**Block Parameter:** vinit**Type:** character vector**Values:** scalar**Default:** '0.0'**Integer rounding mode — Rounding mode for fixed-point operations**

Floor (default) | Ceiling | Convergent | Nearest | Round | Simplest | Zero

Specify the rounding mode for fixed-point operations. For more information, see “Rounding” (Fixed-Point Designer).

Programmatic Use**Block Parameter:** RndMeth**Type:** character vector**Values:** 'Ceiling' | 'Convergent' | 'Floor' | 'Nearest' | 'Round' | 'Simplest' | 'Zero'**Default:** 'Floor'**Saturate to max or min when overflows occur — Method of overflow action**

off (default) | on

When you select this check box, overflows saturate to the maximum or minimum value that the data type can represent. Otherwise, overflows wrap.

When you select this check box, saturation applies to every internal operation on the block, not just the output or result. In general, the code generation process can detect when overflow is not possible. In this case, the code generator does not produce saturation code.

Programmatic Use**Block Parameter:** DoSatur**Type:** character vector**Values:** 'off' | 'on'**Default:** 'off'**Block Characteristics**

| | |
|-------------------|---|
| Data Types | double fixed point integer single |
|-------------------|---|

| | |
|---------------------------------|----|
| Direct Feedthrough | no |
| Multidimensional Signals | no |
| Variable-Size Signals | no |
| Zero-Crossing Detection | no |

Extended Capabilities

C/C++ Code Generation

Generate C and C++ code using Simulink® Coder™.

The code generator does not explicitly group primitive blocks that constitute a nonatomic masked subsystem block in the generated code. This flexibility allows for more efficient code generation. In certain cases, you can achieve grouping by configuring the masked subsystem block to execute as an atomic unit by selecting the **Treat as atomic unit** option.

PLC Code Generation

Generate Structured Text code using Simulink® PLC Coder™.

Fixed-Point Conversion

Design and simulate fixed-point systems using Fixed-Point Designer™.

See Also

Transfer Fcn Direct Form II Time Varying | Discrete Transfer Fcn

Topics

“Fixed-Point Numbers”

Introduced before R2006a

Transfer Fcn Direct Form II Time Varying

Implement time varying Direct Form II realization of transfer function

Library: Simulink / Additional Math & Discrete / Additional Discrete

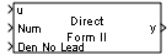

Description

The Transfer Fcn Direct Form II Time Varying block implements a Direct Form II realization of the specified transfer function. The block supports only single input-single output (SISO) transfer functions.

The input signal labeled **Den No Lead** contains the denominator coefficients of the transfer function. The full denominator has a leading coefficient of one, but it is excluded from the input signal. For example, to use a denominator of $[1 \ -1.7 \ 0.72]$, specify a signal with the value $[-1.7 \ 0.72]$. The input signal labeled **Num** contains the numerator coefficients. The data types of the numerator and denominator coefficients can be different, but the length of the numerator vector and the full denominator vector must be the same. Pad the numerator vector with zeros, if needed.

The block automatically selects the data types and scalings of the output, the coefficients, and any temporary variables.

Ports

Input

u — Input signal

scalar | vector

Input signal, specified as a scalar or vector.

Data Types: single | double | int8 | int16 | int32 | int64 | uint8 | uint16 | uint32 | uint64 | Boolean | fixed point

Num — Numerator coefficients

scalar | vector

Numerator coefficients of the transfer function, specified as a scalar or vector.

Dependencies

The data types of the numerator and denominator coefficients can be different, but the length of the numerator vector and the full denominator vector must be the same. Pad the numerator vector with zeros, if needed.

Data Types: single | double | int8 | int16 | int32 | int64 | uint8 | uint16 | uint32 | uint64 | Boolean | fixed point

Den No Lead — Denominator coefficients

scalar | vector

Denominator coefficients of the transfer function, specified as a scalar or vector, without the leading coefficient of one. The full denominator has a leading coefficient of one, but it is excluded from the input signal.

Example: For a denominator coefficient of `[1 -1.7 0.72]`, specify a signal with value `[-1.7 0.72]`.

Dependencies

The data types of the numerator and denominator coefficients can be different, but the length of the numerator vector and the full denominator vector must be the same.

Data Types: `single` | `double` | `int8` | `int16` | `int32` | `int64` | `uint8` | `uint16` | `uint32` | `uint64` | `Boolean` | `fixed point`

Output

y — Output signal

`scalar` | `vector`

Output signal, specified as a scalar or vector.

The block automatically selects the data types and scalings of the output and any temporary variables.

Data Types: `single` | `double` | `int8` | `int16` | `int32` | `int64` | `uint8` | `uint16` | `uint32` | `uint64` | `Boolean` | `fixed point` | `enumerated` | `bus`

Parameters

Initial condition — Initial condition

`0.0` (default) | `scalar`

Specify the initial condition as a scalar.

Programmatic Use

Block Parameter: `vinit`

Type: `character vector`

Values: `scalar`

Default: `'0.0'`

Integer rounding mode — Rounding mode for fixed-point operations

`Floor` (default) | `Ceiling` | `Convergent` | `Nearest` | `Round` | `Simplest` | `Zero`

Specify the rounding mode for fixed-point operations. For more information, see “Rounding” (Fixed-Point Designer).

Programmatic Use

Block Parameter: `RndMeth`

Type: `character vector`

Values: `'Ceiling'` | `'Convergent'` | `'Floor'` | `'Nearest'` | `'Round'` | `'Simplest'` | `'Zero'`

Default: `'Floor'`

Saturate to max or min when overflows occur — Method of overflow action

`off` (default) | `on`

When you select this check box, overflows saturate to the maximum or minimum value that the data type can represent. Otherwise, overflows wrap.

When you select this check box, saturation applies to every internal operation on the block, not just the output or result. In general, the code generation process can detect when overflow is not possible. In this case, the code generator does not produce saturation code.

Programmatic Use

Block Parameter: DoSatur

Type: character vector

Values: 'off' | 'on'

Default: 'off'

Block Characteristics

| | |
|---------------------------------|--|
| Data Types | Boolean ^a double fixed point integer single |
| Direct Feedthrough | no |
| Multidimensional Signals | no |
| Variable-Size Signals | no |
| Zero-Crossing Detection | no |

a. This block is not recommended for use with Boolean signals.

Extended Capabilities

C/C++ Code Generation

Generate C and C++ code using Simulink® Coder™.

The code generator does not explicitly group primitive blocks that constitute a nonatomic masked subsystem block in the generated code. This flexibility allows for more efficient code generation. In certain cases, you can achieve grouping by configuring the masked subsystem block to execute as an atomic unit by selecting the **Treat as atomic unit** option.

PLC Code Generation

Generate Structured Text code using Simulink® PLC Coder™.

Fixed-Point Conversion

Design and simulate fixed-point systems using Fixed-Point Designer™.

See Also

Transfer Fcn Direct Form II | Discrete Transfer Fcn

Topics

“Fixed-Point Numbers”

Introduced before R2006a

Transfer Fcn First Order

Implement discrete-time first order transfer function

Library: Simulink / Discrete

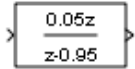

Description

The Transfer Fcn First Order block implements a discrete-time first order transfer function of the input. The transfer function has a unity DC gain.

Ports

Input

Port_1 – Input signal

scalar | vector

Input signal to the first order transfer function algorithm.

Data Types: single | double | int8 | int16 | int32 | int64 | uint8 | uint16 | uint32 | uint64 | Boolean | fixed point

Output

Port_1 – Transfer function output signal

scalar | vector

Output signal that is the discrete-time first order transfer function of the input with a unity DC gain.

Data Types: single | double | int8 | int16 | int32 | int64 | uint8 | uint16 | uint32 | uint64 | Boolean | fixed point

Parameters

Pole (in Z plane) – Pole

0.95 (default) | scalar

Specify the pole.

Programmatic Use

Block Parameter: PoleZ

Type: character vector

Value: real scalar

Default: '0.95'

Initial condition for previous output – Initial condition for previous output

0.0 (default) | scalar

Specify the initial condition for the previous output.

Programmatic Use

Block Parameter: ICPrevOutput

Type: character vector

Value: real scalar

Default: '0.0'

Integer rounding mode — Rounding mode for fixed-point operations

Floor (default) | Ceiling | Convergent | Nearest | Round | Simplest | Zero

Specify the rounding mode for fixed-point operations. For more information, see “Rounding” (Fixed-Point Designer).

Block parameters always round to the nearest representable value. To control the rounding of a block parameter, enter an expression using a MATLAB rounding function into the mask field.

Programmatic Use

Block Parameter: RndMeth

Type: character vector

Values: 'Ceiling' | 'Convergent' | 'Floor' | 'Nearest' | 'Round' | 'Simplest' | 'Zero'

Default: 'Floor'

Saturate to max or min when overflows occur — Method of overflow action

off (default) | on

When you select this check box, overflows saturate to the maximum or minimum value that the data type can represent. Otherwise, overflows wrap.

When you select this check box, saturation applies to every internal operation on the block, not just the output or result. In general, the code generation process can detect when overflow is not possible. In this case, the code generator does not produce saturation code.

Programmatic Use

Block Parameter: DoSatur

Type: character vector

Values: 'off' | 'on'

Default: 'off'

Block Characteristics

| | |
|---------------------------------|---|
| Data Types | double fixed point integer single |
| Direct Feedthrough | no |
| Multidimensional Signals | no |
| Variable-Size Signals | yes |
| Zero-Crossing Detection | no |

Extended Capabilities

C/C++ Code Generation

Generate C and C++ code using Simulink® Coder™.

PLC Code Generation

Generate Structured Text code using Simulink® PLC Coder™.

Fixed-Point Conversion

Design and simulate fixed-point systems using Fixed-Point Designer™.

See Also

Transfer Fcn Lead or Lag | Transfer Fcn

Introduced before R2006a

Transfer Fcn Lead or Lag

Implement discrete-time lead or lag compensator

Library: Simulink / Discrete

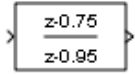

Description

The Transfer Fcn Lead or Lag block implements a discrete-time lead or lag compensator of the input. The instantaneous gain of the compensator is 1, and the DC gain is equal to $(1-z)/(1-p)$, where z is the zero and p is the pole of the compensator.

The block implements a lead compensator when $0 < z < p < 1$, and implements a lag compensator when $0 < p < z < 1$.

Ports

Input

Port_1 – Input signal

scalar | vector

Input signal that the block applies the discrete-time lead or lag compensation to.

Data Types: single | double | int8 | int16 | int32 | int64 | uint8 | uint16 | uint32 | uint64 | fixed point

Output

Port_1 – Output signal

scalar | vector

Output signal that is discrete-time lead or lag compensation of the input sign.

Data Types: single | double | int8 | int16 | int32 | int64 | uint8 | uint16 | uint32 | uint64 | fixed point

Parameters

Pole of compensator (in Z plane) – Pole

0.95 (default) | scalar

Specify the pole of the compensator.

Programmatic Use

Block Parameter: PoleZ

Type: character vector

Value: real scalar

Default: '0.95'

Zero of compensator (in Z plane) — Zero of compensator

0.75 (default) | scalar

Specify the zero of compensator in the Z plane.

Programmatic Use

Block Parameter: ZeroZ

Type: character vector

Value: real scalar

Default: '0.75'

Initial condition for previous input — Initial condition for previous input

0.0 (default) | scalar

Specify the initial condition for the previous input.

Programmatic Use

Block Parameter: ICPrevInput

Type: character vector

Value: real scalar

Default: '0.0'

Initial condition for previous output — Initial condition for previous output

0.0 (default) | scalar

Specify the initial condition for the previous output.

Programmatic Use

Block Parameter: ICPrevOutput

Type: character vector

Value: real scalar

Default: '0.0'

Integer rounding mode — Rounding mode for fixed-point operations

Floor (default) | Ceiling | Convergent | Nearest | Round | Simplest | Zero

Specify the rounding mode for fixed-point operations. For more information, see “Rounding” (Fixed-Point Designer).

Block parameters always round to the nearest representable value. To control the rounding of a block parameter, enter an expression using a MATLAB rounding function into the mask field.

Programmatic Use

Block Parameter: RndMeth

Type: character vector

Values: 'Ceiling' | 'Convergent' | 'Floor' | 'Nearest' | 'Round' | 'Simplest' | 'Zero'

Default: 'Floor'

Saturate to max or min when overflows occur — Method of overflow action

off (default) | on

When you select this check box, overflows saturate to the maximum or minimum value that the data type can represent. Otherwise, overflows wrap.

When you select this check box, saturation applies to every internal operation on the block, not just the output or result. In general, the code generation process can detect when overflow is not possible. In this case, the code generator does not produce saturation code.

Programmatic Use

Block Parameter: DoSatur

Type: character vector

Values: 'off' | 'on'

Default: 'off'

Block Characteristics

| | |
|---------------------------------|--|
| Data Types | Boolean ^a double fixed point integer single |
| Direct Feedthrough | no |
| Multidimensional Signals | no |
| Variable-Size Signals | yes |
| Zero-Crossing Detection | no |

a. This block is not recommended for use with Boolean signals.

Extended Capabilities

C/C++ Code Generation

Generate C and C++ code using Simulink® Coder™.

PLC Code Generation

Generate Structured Text code using Simulink® PLC Coder™.

Fixed-Point Conversion

Design and simulate fixed-point systems using Fixed-Point Designer™.

See Also

Transfer Fcn First Order | Transfer Fcn

Introduced before R2006a

Transfer Fcn Real Zero

Implement discrete-time transfer function that has real zero and no pole

Library: Simulink / Discrete

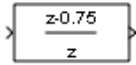

Description

The Transfer Fcn Real Zero block implements a discrete-time transfer function that has a real zero and effectively no pole.

Ports

Input

Port_1 — Input signal

scalar | vector

Input signal to the discrete-time transfer function algorithm.

Data Types: single | double | int8 | int16 | int32 | int64 | uint8 | uint16 | uint32 | uint64 | fixed point

Output

Port_1 — Output signal

scalar | vector

Output signal that is the discrete-time transfer function with a real zero and effectively no pole of the input signal.

Data Types: single | double | int8 | int16 | int32 | int64 | uint8 | uint16 | uint32 | uint64 | fixed point

Parameters

Zero (in Z plane) — Zero

0.75 (default) | scalar

Specify the zero in the Z plane.

Programmatic Use

Block Parameter: ZeroZ

Type: character vector

Value: real scalar

Default: '0.75'

Initial condition for previous input — Initial condition for previous input

0.0 (default) | scalar

Specify the initial condition for the previous input.

Programmatic Use**Block Parameter:** ICPrevInput**Type:** character vector**Value:** real scalar**Default:** '0.0'**Input processing — Specify sample- or frame-based processing**

Elements as channels (sample based) (default) | Columns as channels (frame based)

Specify whether the block performs sample- or frame-based processing:

- Columns as channels (frame based) — Treat each column of the input as a separate channel (frame-based processing).

Note Frame-based processing requires a DSP System Toolbox license.

For more information, see “Sample- and Frame-Based Concepts” (DSP System Toolbox).

- Elements as channels (sample based) — Treat each element of the input as a separate channel (sample-based processing).

Use **Input processing** to specify whether the block performs sample- or frame-based processing. For more information about these two processing modes, see “Sample- and Frame-Based Concepts” (DSP System Toolbox).

Programmatic Use**Block Parameter:** InputProcessing**Type:** character vector**Values:** 'Columns as channels (frame based)' | 'Elements as channels (sample based)'**Default:** 'Elements as channels (sample based)'**Integer rounding mode — Rounding mode for fixed-point operations**

Floor (default) | Ceiling | Convergent | Nearest | Round | Simplest | Zero

Specify the rounding mode for fixed-point operations. For more information, see “Rounding” (Fixed-Point Designer).

Block parameters always round to the nearest representable value. To control the rounding of a block parameter, enter an expression using a MATLAB rounding function into the mask field.

Programmatic Use**Block Parameter:** RndMeth**Type:** character vector**Values:** 'Ceiling' | 'Convergent' | 'Floor' | 'Nearest' | 'Round' | 'Simplest' | 'Zero'**Default:** 'Floor'**Saturate to max or min when overflows occur — Method of overflow action**

off (default) | on

When you select this check box, overflows saturate to the maximum or minimum value that the data type can represent. Otherwise, overflows wrap.

When you select this check box, saturation applies to every internal operation on the block, not just the output or result. In general, the code generation process can detect when overflow is not possible. In this case, the code generator does not produce saturation code.

Programmatic Use**Block Parameter:** DoSatur**Type:** character vector**Values:** 'off' | 'on'**Default:** 'off'**Block Characteristics**

| | |
|---------------------------------|--|
| Data Types | Boolean ^a double fixed point integer single |
| Direct Feedthrough | no |
| Multidimensional Signals | no |
| Variable-Size Signals | yes |
| Zero-Crossing Detection | no |

a. This block is not recommended for use with Boolean signals.

Extended Capabilities**C/C++ Code Generation**

Generate C and C++ code using Simulink® Coder™.

PLC Code Generation

Generate Structured Text code using Simulink® PLC Coder™.

Fixed-Point Conversion

Design and simulate fixed-point systems using Fixed-Point Designer™.

See Also

Transfer Fcn | Transfer Fcn Lead or Lag

Introduced before R2006a

Transport Delay

Delay input by given amount of time

Library: Simulink / Continuous



Description

The Transport Delay block delays the input by a specified amount of time. You can use this block to simulate a time delay. The input to this block should be a continuous signal.

At the start of simulation, the block outputs the **Initial output** parameter until the simulation time exceeds the **Time delay** parameter. Then, the block begins generating the delayed input. During simulation, the block stores input points and simulation times in a buffer. You specify this size with the **Initial buffer size** parameter.

When you want output at a time that does not correspond to times of the stored input values, the block interpolates linearly between points. When the delay is smaller than the step size, the block extrapolates from the last output point, which can produce inaccurate results. Because the block does not have direct feedthrough, it cannot use the current input to calculate an output value. For example, consider a fixed-step simulation with a step size of 1 and the current time at $t = 5$. If the delay is 0.5, the block must generate a point at $t = 4.5$. Because the most recent stored time value is at $t = 4$, the block performs forward extrapolation.

The Transport Delay block does not interpolate discrete signals. Instead, the block returns the discrete value at the required time.

This block differs from the Unit Delay block, which delays and holds the output on sample hits only.

Tip Avoid using `linmod` to linearize a model that contains a Transport Delay block. For more information, see “Linearizing Models”.

Ports

Input

Port_1 — Input signal

scalar | vector | matrix

Input signal to delay, specified as a scalar, vector, or matrix.

Data Types: `double`

Output

Port_1 — Delayed signal

scalar | vector | matrix

Input signal, delayed by specified amount of time. Output has the same dimensions and data type as the input signal.

Data Types: `double`

Parameters

Time delay — Time delay

1 (default) | `scalar` | `vector` | `matrix`

Specify the amount of simulation time to delay the input signal before propagation to the output as a nonnegative scalar, vector, or matrix.

Programmatic Use:

Block Parameter: `DelayTime`

Type: character vector, string

Values: nonnegative scalar, vector, or matrix

Default: '1'

Initial output — Initial output value

0 (default) | `scalar` | `vector` | `matrix`

Specify the output that the block generates until the simulation time first exceeds the time delay input as a scalar, vector, or matrix.

Limitations

The initial output of this block cannot be `inf` or `NaN`.

A Run-to-run tunable parameter cannot be changed during a simulation run time. However, changing it before a simulation begins does not cause Accelerator or Rapid Accelerator to regenerate code.

Programmatic Use

Block Parameter: `InitialOutput`

Type: character vector, string

Values: `scalar` | `vector` | `matrix`

Default: '0'

Initial buffer size — Initial memory allocation

1024 (default) | `positive integer scalar`

Define the initial memory allocation for the number of input points to store.

- If the number of input points exceeds the initial buffer size, the block allocates additional memory.
- After simulation ends, a message shows the total buffer size needed.

Tips

- Because allocating memory slows down simulation, choose this value carefully if simulation speed is an issue.
- For long time delays, this block can use a large amount of memory, particularly for dimensionalized input.

Programmatic Use**Block Parameter:** BufferSize**Type:** character vector, string**Value:** positive integer scalar**Default:** '1024'**Use fixed buffer size — Use fixed-size buffer**

off (default) | on

Select this check box to use a fixed-size buffer to save input data from previous time steps.

The **Initial buffer size** parameter specifies the size of the buffer. If the buffer is full, new data replaces data already in the buffer. Simulink software uses linear extrapolation to estimate output values that are not in the buffer.

Note If you have a Simulink Coder license, ERT or GRT code generation uses a fixed-size buffer even if you do not select this check box.

Tips

- If the input data is linear, selecting this check box can save memory.
- If the input data is nonlinear, do not select this check box. Doing so can yield inaccurate results.

Programmatic Use**Block Parameter:** FixedBuffer**Type:** character vector, string**Value:** 'off' | 'on'**Default:** 'off'**Direct feedthrough of input during linearization — Enable direct feedthrough**

off (default) | on

Cause the block to output its input during linearization and trim, which sets the block mode to direct feedthrough.

Tips

- Selecting this check box can cause a change in the ordering of states in the model when you use the functions `linmod`, `dlinmod`, or `trim`. To extract this new state ordering:
 - 1 Compile the model using the following command, where `model` is the name of the Simulink model.

```
[sizes, x0, x_str] = model([],[],[],'lincompile');
```
 - 2 Terminate the compilation with the following command.

```
model([],[],[],'term');
```
- The output argument `x_str`, which is a cell array of the states in the Simulink model, contains the new state ordering. When you pass a vector of states as input to the `linmod`, `dlinmod`, or `trim` functions, the state vector must use this new state ordering.

Programmatic Use**Block Parameter:** TransDelayFeedthrough

Type: character vector, string

Value: 'off' | 'on'

Default: 'off'

Pade order (for linearization) – Order of Pade approximation

0 (default) | scalar | vector | matrix

Set the order of the Pade approximation for linearization routines as a scalar, vector, or matrix of nonnegative integers.

- The default value is 0, which results in a unity gain with no dynamic states.
- Setting the order to a positive integer n adds n states to your model, but results in a more accurate linear model of the transport delay.

Programmatic Use

Block Parameter: PadeOrder

Type: character vector, string

Values: scalar | vector | matrix

Default: '0'

Block Characteristics

| | |
|---------------------------------|--------|
| Data Types | double |
| Direct Feedthrough | yes |
| Multidimensional Signals | no |
| Variable-Size Signals | no |
| Zero-Crossing Detection | no |

Extended Capabilities

C/C++ Code Generation

Generate C and C++ code using Simulink® Coder™.

Not recommended for production-quality code. Relates to resource limits and restrictions on speed and memory often found in embedded systems. The code generated can contain dynamic allocation and freeing of memory, recursion, additional memory overhead, and widely-varying execution times. While the code is functionally valid and generally acceptable in resource-rich environments, smaller embedded targets often cannot support such code.

In general, consider using the Simulink Model Discretizer to map continuous blocks into discrete equivalents that support production code generation. To start the Model Discretizer, in the Simulink Editor, on the **Apps** tab, under **Apps**, under **Control Systems**, click **Model Discretizer**. One exception is the Second-Order Integrator block because, for this block, the Model Discretizer produces an approximate discretization.

See Also

Unit Delay | Variable Time Delay

Topics

“Model Discretizer”

Introduced before R2006a

Transpose

Compute transpose of matrix

Library: Simulink / Matrix Operations

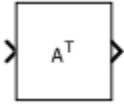

Description

The Transpose block computes the transpose of an M -by- N matrix.

Ports

Input

Port_1 — Matrix

M -by- N matrix

Matrix, specified as an M -by- N matrix.

Data Types: `single` | `double` | `half` | `int8` | `int16` | `int32` | `int64` | `uint8` | `uint16` | `uint32` | `uint64` | `fixed point`

Output

Port_1 — Transposed matrix

N -by- M matrix

Transposed matrix, returned as an N -by- M matrix.

Data Types: `single` | `double` | `half` | `int8` | `int16` | `int32` | `int64` | `uint8` | `uint16` | `uint32` | `uint64` | `fixed point`

Block Characteristics

| | |
|---------------------------------|--|
| Data Types | Boolean double fixed point half integer single |
| Direct Feedthrough | yes |
| Multidimensional Signals | yes |
| Variable-Size Signals | yes |
| Zero-Crossing Detection | no |

Extended Capabilities

C/C++ Code Generation

Generate C and C++ code using Simulink® Coder™.

See Also

Cross Product | Hermitian Transpose | Identity Matrix | IsSymmetric | IsTriangular | Matrix Square

Topics

“Compatible Array Sizes for Basic Operations”
MATLAB Matrix Operations

Introduced in R2021b

Trigger

Add trigger or function port to subsystem or model

Library: Simulink / Ports & Subsystems
HDL Coder / Ports & Subsystems



Description

The Trigger block adds an external signal to control the execution of a subsystem or a model. To enable this functionality, add this block to a Subsystem block or at the root level of a model that is referenced in a Model block.

Then, configure the Trigger block to execute a subsystem or model:

- Once at each time step, when the value of the control signal changes in a way that you specify.
- Multiple times during a time step, when the control signal is a function-call event from a Stateflow chart, Function-Call Generator block, or S-Function block.

Ports

Output

Port_1 — Value that describes control signal

scalar | vector

Value that identifies a control signal, returned as a scalar or vector. For each element of the input signal, the value at a given time step is:

- 1 for a signal that causes a rising trigger
- -1 for a signal that causes a falling trigger
- 2 for a function-call event
- 0 in all other cases

Dependencies

To enable this port, select **Show output port**.

Data Types: double | int8

Parameters

Main

Trigger type — Select the type control signal

rising (default) | falling | either | function-call

Select the type of control signal that executes a subsystem or model.

rising

Trigger execution of subsystem or model when the control signal rises from a negative or zero value to a positive value. If the initial value is negative, a rising signal to zero triggers execution.

falling

Trigger execution of subsystem or model when the control signal falls from a positive or a zero value to a negative value. If the initial value is positive, a falling signal to zero triggers execution.

either

Trigger execution of subsystem or model when the control signal is either rising or falling.

function-call

Execute subsystem or model when the control signal receives a function-call event from a Stateflow chart, Function-Call Generator block, S-Function block, or Hit Crossing block.

Programmatic Use

Block Parameter: TriggerType

Type: character vector

Values: 'rising' | 'falling' | 'either' | 'function-call'

Default: 'rising'

Treat as Simulink function — Create Simulink Function block

off (default) | on

Select this parameter to create a Simulink Function block by configuring a Subsystem block that is callable with arguments from a function caller. The Trigger block must reside within the subsystem. You can edit the function prototype that displays on the block face to specify input and output arguments for the block.

Clear this parameter to remove the configuration.

Dependency

To display and enable this parameter, select `function-call` from the **Trigger type** list.

Programmatic Use

Block Parameter: IsSimulinkFunction

Type: character vector

Values: 'off' | 'on'

Default: 'off'

Function name — Specify function name for Simulink Function block

f (default) | function name

Specify the function name for a Simulink Function block. Alternatively, you can specify the name by editing the function prototype on the face of the block.

f

Default name for a Simulink Function block.

function name

Function name that displays on the face of a Simulink Function block.

Dependency

To display and enable this parameter, select `function-call` from the **Trigger type** list and select the **Treat as a Simulink Function** check box.

Programmatic Use

Block Parameter: `FunctionName`

Type: character vector

Values: `'f' | '<function name>'`

Default: `'f'`

Enable variant condition – Controls activating the variant control (condition)

`on (default) | off`

Control activating the variant control (condition) defined with the **Variant Control** parameter.

Select this parameter to activate variant control of the subsystem. Selecting this parameter:

- Enables the **Variant control** parameter.
- Displays a variant badge  on the face of the block indicating that variant conditions are enabled.

Clear this parameter to deactivate variant control of the subsystem.

Dependency

To display and enable this parameter, select `function-call` from the **Trigger type** list and select the **Treat as Simulink function** check box.

Programmatic Use

Block Parameter: `Variant`

Type: character vector

Values: `'off' | 'on'`

Default: `'on'`

Variant control – Specify variant control (condition) expression

`(inherit) (default) | logical expression`

Specify variant control (condition) expression that executes a variant Simulink Function block when the expression evaluates to `true`.

`(inherit)`

Default value for variant control. Inherits the variant condition from the corresponding Function Caller blocks in the model. When **Variant Control** is set as `(inherit)` the value for **Generate preprocessor conditionals** is inherited automatically from the Function Caller block in the model.

`logical expression`

A logical (Boolean) expression or a `Simulink.Variant` object representing a logical expression.

The function is activated when the expression evaluates to `true`.

If you want to generate code for your model, define the variables in the expression as `Simulink.Parameter` objects.

Dependency

To display and enable this parameter, select function-call from the **Trigger type** list, select the **Treat as a Simulink Function** check box, then select the **Enable variant condition** check box.

Programmatic Use

Block Parameter: VariantControl

Type: character vector

Values: '(inherit)' | <logical expression> | Simulink.Variant object

Default: '(inherit)'

Generate preprocessor conditionals – Control enclosing variant choices

off (default) | on

Control enclosing variant choices within C preprocessor conditional statements.

Select this parameter to enclose variant choices within C preprocessor conditional statements (#if) when generating code for an ERT target.

Dependency

To display and enable this parameter, select the **Enable variant condition** check box.

Programmatic Use

Block Parameter: GeneratePreprocessorConditionals

Type: character vector

Values: 'off' | 'on'

Default: 'off'

Function visibility – Select scope visibility of function

scoped (default) | global

Select scope of Simulink Function block within subsystem or model.

scoped

Limit accessibility of function to:

- Hierarchic level containing the Simulink Function block and levels below.
- One hierarchical level above with qualification.

global

Function accessible from any part of the model hierarchy.

Dependency

To display and enable this parameter, select function-call from the **Trigger type** list, then select the **Treat as a Simulink Function** check box..

Programmatic Use

Block Parameter: FunctionVisibility

Type: character vector

Values: 'scoped' | 'global'

Default: 'scoped'

States when enabling – Select how to set block state values

held (default) | reset | inherit

Select how to set block state values when the subsystem or model is disabled.

held

Leave the block states at their current values.

reset

Reset the block state values.

inherit

Use the **held** or **reset** setting from the parent subsystem initiating the function-call. If the parent of the initiator is the model root, the inherited setting is **held**. If the trigger has multiple initiators, set the parents of all initiators to either **held** or **reset**.

Dependencies

To enable this parameter, select **function-call** from the **Trigger Type** list.

This parameter setting applies only if the model explicitly enables and disables the function-call subsystem. For example:

- The function-call subsystem resides in an enabled subsystem. In this case, the model enables and disables the function-call subsystem along with the parent subsystem.
- The function-call initiator that controls the function-call subsystem resides in an enabled subsystem. In this case, the model enables and disables the function-call subsystem along with the enabled subsystem containing the function-call initiator.
- The function-call initiator is a Stateflow event bound to a particular state. See “Control Function-Call Subsystems by Using bind Actions” (Stateflow).
- The function-call initiator is an S-function that explicitly enables and disables the function-call subsystem. See `ssEnableSystemWithTid` for an example.

Programmatic Use

Block Parameter: `StatesWhenEnabling`

Type: character vector

Values: `'held' | 'reset' | 'inherit'`

Default: `'held'`

Propagate sizes of variable-size signals — Select when to propagate variable-size signals

During execution (default) | Only when enabling

Select when to propagate variable-size signals.

During execution

Propagate variable-size signals at each time step.

Only when enabling

Propagate variable-size signals when executing a Subsystem block or Model block containing an Enable port, Trigger port with **Trigger type** set to **function-call**, or Action Port block. When you select this option, sample time must be periodic.

Dependencies

To display and enable this parameter for a Trigger port block, select **Function-call** from the **Trigger type** list.

Programmatic Use**Block Parameter:** PropagateVarSize**Type:** character vector**Values:** 'During execution' | 'Only when enabling'**Default:** 'During execution'**Show output port — Control display of output port**

off (default) | on

Control display of an output port for a signal that identifies the trigger signal or function-call event signal.

Select this parameter to display the output port and determine which signal caused the trigger signal or function-call event. The width of the output port signal is the width of the control signal. The signal value is:

- 1 for a signal that causes a rising trigger
- -1 for a signal that causes a falling trigger
- 2 for a function-call event
- 0 in all other cases

Clear this parameter to remove the output port.

Programmatic Use**Block Parameter:** ShowOutputPort**Type:** character vector**Values:** 'off' | 'on'**Default:** 'off'**Output data type — Select output port data type**

auto (default) | double | int8

Select the output port data type for the signal that identifies the trigger signal or function-call event signal.

auto

Data type is the same as the port connected to the output.

double

Double value.

int8

Integer value

Dependency

To enable this parameter, select the **Show output port** check box.

The Trigger block ignores the **Data type override** setting for the Fixed-Point Tool.

Programmatic Use**Block Parameter:** OutputDataType**Type:** character vector**Values:** 'auto' | 'double' | 'int8'

Default: 'auto'

Sample time type – Select calling rate

triggered (default) | periodic

Select the calling rate for a subsystem or model.

triggered

Apply to applications that do not have a periodic function-call frequency. A function-call initiator can execute a triggered (aperiodic) function-call subsystem one or more times per time step and can provide a series of aperiodic function-call events.

periodic

A function-call initiator can execute a periodic function-call system only once per time step and must provide a series of periodic function-call events.. A Stateflow chart is an example of a function-call initiator.

Dependency

To enable this parameter, select Function-call from the **Trigger type** list.

Programmatic Use

Block Parameter: SampleTimeType

Type: character vector

Values: 'triggered' | 'periodic'

Default: 'triggered'

Sample time – Specify time interval

-1 (default) | Ts | [Ts, To]

Specify the time interval between function calls to a subsystem or model containing this Trigger port block. If the actual calling rate for the subsystem or model differs from the time interval this parameter specifies, Simulink displays an error.

-1

Inherit time interval from the control signal.

Ts

Scalar where Ts is the time interval.

[Ts, To]

Vector where Ts is the time interval and To is the initial time offset.

Dependencies

To enable this parameter, select function-call from the **Trigger type** list and periodic from the **Sample time type** list.

Programmatic Use

Block Parameter: SampleTime

Type: character vector

Values: '-1' | 'Ts' | '[Ts, To]'

Default: '-1'

Enable zero-crossing detection – Control zero-crossing detection

on (default) | off

Select this parameter to detect zero crossings.

Dependencies

To enable this parameter, select rising, falling, or either from the **Trigger type** list.

Programmatic Use

Block Parameter: ZeroCross

Type: character vector

Values: 'on' | 'off'

Default: 'on'

Initial trigger signal state — Select the initial state of the trigger signal

compatibility (no trigger on first evaluation) (default) | zero | positive | negative

Select the initial state of the trigger control signal.

compatibility (no trigger on first evaluation)

No trigger at the first evaluation of trigger signal. If you choose this option and the Trigger block is in a subsystem where the states are reset, the block does not reset.

zero

Zero. Helps to evaluate a rising or falling trigger signal at the first time step.

positive

Positive value. Helps to evaluate a falling trigger signal at the first time step.

negative

Negative value. Helps to evaluate a rising trigger signal at the first time step.

Dependency

To display and activate this parameter, select rising, falling, or either from the **Trigger type** list.

Programmatic Use

Block Parameter: InitialTriggerSignalState

Type: character vector

Values: 'compatibility (no trigger on first evaluation)' | 'zero' | 'positive' | 'negative'

Default: 'compatibility (no trigger on first evaluation)'

Signal Attributes

Port dimensions — Specify dimensions for the trigger signal

1 (default) | [n] | [m n]

Specify dimensions for the trigger signal attached externally a Model block and passed to the inside of the block.

1

Scalar signal.

[n]

Vector signal of width n.

[m n]

Matrix signal having m rows and n columns.

Dependency

To display and enable this parameter for a Trigger port block at the root-level of a model, select rising, falling, or either from the **Trigger type** list.

Programmatic Use

Block Parameter: PortDimensions

Type: character vector

Values: '1' | '[n]' | '[m n]'

Default: '1'

Trigger signal sample time — Specify time interval

-1 (default) | Ts | [Ts, To]

Specify time interval between block method executions for the block driving the trigger signal.

-1

Inherit time interval.

Ts

Scalar where Ts is the time interval.

[Ts, To]

Vector where Ts is the time interval and To is the initial time offset.

Dependency

To display and enable this parameter for a Trigger port block at the root-level of a model, select rising, falling, or either from the **Trigger type** list.

Programmatic Use

Block Parameter: TriggerSignalSampleTime

Type: character vector

Values: '-1' | 'Ts' | '[Ts, To]'

Default: '-1'

Minimum — Specify minimum output value for the trigger signal

[] (default) | real scalar

Specify minimum value for the trigger signal attached externally to a Model block and passed to the inside of the block.

Simulink uses this value to perform:

- Simulation range checking. See “Specify Signal Ranges”.
- Automatic scaling of fixed-point data types.
- Optimization of generated code. This optimization can remove algorithmic code and affect the results of some simulation modes such as SIL or external mode. See “Optimize using the specified minimum and maximum values” (Embedded Coder).

[]

Unspecified minimum value.

real scalar

Real scalar value.

Dependency

To display and enable this parameter for a Trigger port block at the root-level of a model, select rising, falling, or either from the **Trigger type** list.

Programmatic Use

Block Parameter: OutMin

Type: character vector

Values: '[]' | '<real scalar>'

Default: '[]'

Maximum — Specify maximum output value for the trigger signal

[] (default) | real scalar

Specify maximum value for the trigger signal attached externally to a Model block and passed to the inside of the block.

Simulink uses this value to perform:

- Simulation range checking. See “Specify Signal Ranges”.
- Automatic scaling of fixed-point data types.
- Optimization of generated code. This optimization can remove algorithmic code and affect the results of some simulation modes such as SIL or external mode. See “Optimize using the specified minimum and maximum values” (Embedded Coder).

[]

Unspecified maximum value.

real scalar

Real scalar value.

Dependency

To display and enable this parameter for a Trigger port block at the root-level of a model, select rising, falling, or either from the **Trigger type** list.

Programmatic Use

Block Parameter: OutMax

Type: character vector

Values: '[]' | '<real scalar>'

Default: '[]'

Data type — Select output data type for the trigger signal

double (default) | single | int8 | uint8 | int16 | uint16 | int32 | uint32 | int64 | uint64 | boolean | fixdt(1,16) | fixdt(1,16,0) | fixdt(1,16,2^,0) | <data type expression>

Select data type for the trigger signal attached externally to a Model block and passed to the inside of the block.

double

Double-precision floating point.

`single`

Single-precision floating point.

`int8`

Signed 8-bit integer.

`uint8`

Unsigned 8-bit integer.

`int16`

Signed 16-bit integer.

`uint16`

Unsigned 16-bit integer.

`int32`

Signed 32-bit integer.

`uint32`

Unsigned 32-bit integer.

`int64`

Signed 64-bit integer.

`uint64`

Unsigned 64-bit integer.

`boolean`

Boolean with a value of `true` or `false`.

`fixdt(1,16)`

Signed 16-bit fixed point number with binary point undefined.

`fixdt(1,16,0)`

Signed 16-bit fixed point number with binary point set to zero.

`fixdt(1,16,2^0,0)`

Signed 16-bit fixed point number with slope set to 2^0 and bias set to 0.

`<data type expression>`

Data type object, for example `Simulink.NumericType`. You cannot enter the name of a `Simulink.Bus` object as a data type expression.

Dependency

To display and enable this parameter for a Trigger port block at the root-level of a model, select rising, falling, or either from the **Trigger type** list.

Programmatic Use

Block Parameter: `OutDataTypeStr`

Type: character vector

Values: `'double' | 'single' | 'int8' | 'uint8' | 'int16' | 'uint16' | 'int32' | 'uint32' | 'int64' | 'uint64' | 'boolean' | 'fixdt(1,16)' | 'fixdt(1,16,0)' | 'fixdt(1,16,2^0,0)' | '<data type expression>'`

Default: `'double'`

Mode — Select data type category

Built in (default) | Fixed point | Expression

Select data type category and display drop-down lists to help you define the data type.

Built in

Display drop-down lists for data type and **Data type override**.

Fixed point

Display drop-down lists for **Signedness**, **Scaling**, and **Data type override**.

Expression

Display text box for entering an expression.

Dependency

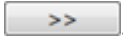
To enable this parameter, select the Show data type assistant button .

Programmatic Use

No equivalent command-line parameter.

Interpolate data — Control how missing workspace data is estimated

on (default) | off

Control how missing workspace data is estimated when loading data from the MATLAB workspace.

Select this parameter to linearly interpolate output at time steps for which no corresponding workspace data exists.

Clear this parameter to set the output at such time steps equal to the output at the most recent time step for which data exists.

Dependency

To display and enable this parameter for a Trigger port block at the root-level of a model, select rising, falling, or either from the **Trigger type** list.

Programmatic Use

Block Parameter: Interpolate

Type: character vector

Values: 'on' | 'off'

Default: 'on'

Block Characteristics

| | |
|---------------------------------|--|
| Data Types | Boolean double enumerated fixed point integer single |
| Direct Feedthrough | no |
| Multidimensional Signals | yes |
| Variable-Size Signals | no |
| Zero-Crossing Detection | yes |

Extended Capabilities

C/C++ Code Generation

Generate C and C++ code using Simulink® Coder™.

HDL Code Generation

Generate Verilog and VHDL code for FPGA and ASIC designs using HDL Coder™.

HDL Coder provides additional configuration options that affect HDL implementation and synthesized logic. See also “HDL Code Generation” on page 1-1893.

HDL Architecture

This block has a single, default HDL architecture.

PLC Code Generation

Generate Structured Text code using Simulink® PLC Coder™.

Fixed-Point Conversion

Design and simulate fixed-point systems using Fixed-Point Designer™.

See Also

Subsystem | Triggered Subsystem | Enabled and Triggered Subsystem | Function-Call Subsystem

Topics

“Conditionally Executed Subsystems Overview”

“Using Triggered Subsystems”

“Using Enabled and Triggered Subsystems”

“Using Function-Call Subsystems”

“Export-Function Models Overview”

Introduced before R2006a

Trigger-Based Linearization

Generate linear models in base workspace when triggered

Library: Simulink / Model-Wide Utilities



Description

When triggered, this block calls `linmod` or `dlinmod` to create a linear model for the system at the current operating point. No trimming is performed. The linear model is stored in the base workspace as a structure, along with information about the operating point at which the snapshot was taken. Multiple snapshots are appended to form an array of structures.

The block sets the following model parameters to the indicated values:

- `BufferReuse` = 'off'
- `RTWInlineParameters` = 'on'
- `BlockReductionOpt` = 'off'

The name of the structure used to save the snapshots is the name of the model appended by `_Trigger_Based_Linearization`, for example, `vdp_Trigger_Based_Linearization`. The structure has the following fields:

| Field | Description |
|-------------------------|---|
| <code>a</code> | The A matrix of the linearization |
| <code>b</code> | The B matrix of the linearization |
| <code>c</code> | The C matrix of the linearization |
| <code>d</code> | The D matrix of the linearization |
| <code>StateName</code> | Names of the model's states |
| <code>OutputName</code> | Names of the model's output ports |
| <code>InputName</code> | Names of the model's input ports |
| <code>OperPoint</code> | A structure that specifies the operating point of the linearization. The structure specifies the value of the model's states (<code>OperPoint.x</code>) and inputs (<code>OperPoint.u</code>) at the operating point time (<code>OperPoint.t</code>). |
| <code>Ts</code> | The sample time of the linearization for a discrete linearization |

Tip Use the Timed-Based Linearization block to generate linear models at predetermined times.

Ports

Input

Port_1 — Input signal

scalar

Input trigger signal, specified as a scalar. Specify the type of event that triggers generation of a linear model using the **Trigger type** parameter.

Data Types: `single` | `double` | `int8` | `int16` | `int32` | `int64` | `uint8` | `uint16` | `uint32` | `uint64` | `fixed point`

Parameters

Trigger type — Signal type that triggers generation of a linear model

`rising` | `falling` | `either` | `function-call`

Type of event on the trigger input signal that triggers generation of a linear model. You can select:

- `rising` — Trigger execution of subsystem or model when the trigger signal rises from a negative or zero value to a positive value. If the initial value is negative, a rising signal to zero triggers execution.
- `falling` — Trigger execution of subsystem or model when the trigger signal falls from a positive or a zero value to a negative value. If the initial value is positive, a falling signal to zero triggers execution.
- `either` — Trigger execution of subsystem or model when the trigger signal is either rising or falling.
- `function-call` — Trigger execution of subsystem or model when the trigger signal is a function-call event from a Stateflow chart, Function-Call Generator block, S-Function block, or Hit Crossing block.

Programmatic Use

Block Parameter: `TriggerType`

Type: character vector

Values: `'rising'` | `'falling'` | `'either'` | `'function-call'`

Default: `'rising'`

Sample time (of linearized model) — Sample time

`0` (default) | scalar | vector

Specify a sample time for the linear model. To create a continuous-time model using `linmod`, specify a sample time of `0`. Otherwise, to create a discrete-time model using `dlinmod`, specify a positive sample time (see “Discrete-Time System Linearization” on page 2-52).

Programmatic Use

Block Parameter: `SampleTime`

Type: character vector

Values: scalar | vector

Default: `'0'`

Block Characteristics

| | |
|---------------------------------|---|
| Data Types | Boolean double fixed point integer single |
| Direct Feedthrough | no |
| Multidimensional Signals | no |
| Variable-Size Signals | no |
| Zero-Crossing Detection | no |

Extended Capabilities

Fixed-Point Conversion

Design and simulate fixed-point systems using Fixed-Point Designer™.

See Also

Timed-Based Linearization | `linmod` | `dlinmod`

Topics

“Discrete-Time System Linearization” on page 2-52

Introduced before R2006a

Triggered Subsystem

Subsystem whose execution is triggered by external input

Library: Simulink / Ports & Subsystems
HDL Coder / Ports & Subsystems

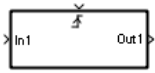

Description

The Triggered Subsystem block is a Subsystem block preconfigured as a starting point for creating a subsystem that executes each time the control signal has a trigger value.

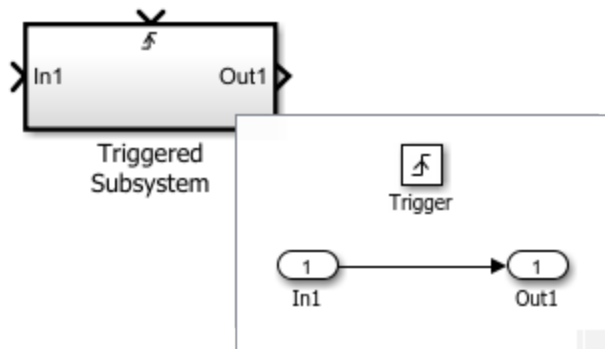

Use Triggered Subsystem blocks to model:

- A task that runs with the detection of a trigger value.
- An interrupt from I/O hardware.
- A processor request to handle an exception or error.

Ports

Input

In — Signal input to a subsystem block

scalar | vector | matrix

Placing an Inport block in a subsystem block adds an external input port to the block. The port label matches the name of the Inport block.

Use Inport blocks to get signals from the local environment.

Data Types: half | single | double | int8 | int16 | int32 | int64 | uint8 | uint16 | uint32 | uint64 | Boolean | fixed point | enumerated | bus

Trigger — Control signal input to a subsystem block

scalar

Placing a Trigger block in a subsystem block adds an external input port to the block.

Data Types: `single` | `double` | `int8` | `int16` | `int32` | `int64` | `uint8` | `uint16` | `uint32` | `uint64` | `fixed point`

Output

Out — Signal output from a subsystem

`scalar` | `vector` | `matrix`

Placing an Outport block in a subsystem block adds an output port from the block. The port label on the subsystem block is the name of the Outport block.

Use Outport blocks to send signals to the local environment.

Data Types: `half` | `single` | `double` | `int8` | `int16` | `int32` | `int64` | `uint8` | `uint16` | `uint32` | `uint64` | `Boolean` | `fixed point` | `enumerated` | `bus`

Block Characteristics

| | |
|---------------------------------|---|
| Data Types | <code>Boolean^a</code> <code>bus^a</code> <code>double^a</code> <code>enumerated^a</code> <code>fixed point^a</code> <code>half^a</code> <code>integer^a</code> <code>single^a</code> <code>string^a</code> |
| Direct Feedthrough | no |
| Multidimensional Signals | limited ^a |
| Variable-Size Signals | limited ^a |
| Zero-Crossing Detection | no |

a. Actual data type or capability support depends on block implementation.

Extended Capabilities

C/C++ Code Generation

Generate C and C++ code using Simulink® Coder™.

Actual code generation support depends on block implementation.

HDL Code Generation

Generate Verilog and VHDL code for FPGA and ASIC designs using HDL Coder™.

HDL Coder provides additional configuration options that affect HDL implementation and synthesized logic. For information about best practices, restrictions, and how you can use the trigger signal as a clock with the `TriggerAsClock` property, see “Using Triggered Subsystems for HDL Code Generation” (HDL Coder).

HDL Architecture

| Architecture | Description |
|------------------|--|
| Module (default) | Generate code for the subsystem and the blocks within the subsystem. |

| Architecture | Description |
|--------------|---|
| BlackBox | <p>Generate a black box interface. The generated HDL code includes only the input/output port definitions for the subsystem. Therefore, you can use a subsystem in your model to generate an interface to existing, manually written HDL code.</p> <p>The black-box interface generation for subsystems is similar to the Model block interface generation without the clock signals.</p> |
| No HDL | Remove the subsystem from the generated code. You can use the subsystem in simulation, however, treat it as a “no-op” in the HDL code. |

Black Box Interface Customization

For the BlackBox architecture, you can customize port names and set attributes of the external component interface. See “Customize Black Box or HDL Cosimulation Interface” (HDL Coder).

HDL Block Properties

| General | |
|----------------------------------|--|
| AdaptivePipelining | Automatic pipeline insertion based on the synthesis tool, target frequency, and multiplier word-lengths. The default is <code>inherit</code> . See also “AdaptivePipelining” (HDL Coder). |
| BalanceDelays | Detects introduction of new delays along one path and inserts matching delays on the other paths. The default is <code>inherit</code> . See also “BalanceDelays” (HDL Coder). |
| ClockRatePipelining | Insert pipeline registers at a faster clock rate instead of the slower data rate. The default is <code>inherit</code> . See also “ClockRatePipelining” (HDL Coder). |
| ConstrainedOutputPipeline | Number of registers to place at the outputs by moving existing delays within your design. Distributed pipelining does not redistribute these registers. The default is <code>0</code> . For more details, see “ConstrainedOutputPipeline” (HDL Coder). |
| DistributedPipelining | Pipeline register distribution, or register retiming. The default is <code>off</code> . See also “DistributedPipelining” (HDL Coder). |
| DSPStyle | Synthesis attributes for multiplier mapping. The default is <code>none</code> . See also “DSPStyle” (HDL Coder). |
| FlattenHierarchy | Remove subsystem hierarchy from generated HDL code. The default is <code>inherit</code> . See also “FlattenHierarchy” (HDL Coder). |
| InputPipeline | Number of input pipeline stages to insert in the generated code. Distributed pipelining and constrained output pipelining can move these registers. The default is <code>0</code> . For more details, see “InputPipeline” (HDL Coder). |
| OutputPipeline | Number of output pipeline stages to insert in the generated code. Distributed pipelining and constrained output pipelining can move these registers. The default is <code>0</code> . For more details, see “OutputPipeline” (HDL Coder). |
| SharingFactor | Number of functionally equivalent resources to map to a single shared resource. The default is <code>0</code> . See also “Resource Sharing” (HDL Coder). |

| General | |
|------------------------|---|
| StreamingFactor | Number of parallel data paths, or vectors, that are time multiplexed to transform into serial, scalar data paths. The default is 0, which implements fully parallel data paths. See also "Streaming" (HDL Coder). |

Target Specification

This block cannot be the DUT, so the block property settings in the **Target Specification** tab are ignored.

Fixed-Point Conversion

Design and simulate fixed-point systems using Fixed-Point Designer™.

Actual data type support depends on block implementation.

See Also

Blocks

Enabled Subsystem | Enabled and Triggered Subsystem | Function-Call Subsystem | Subsystem | Trigger

Topics

"Conditionally Executed Subsystems Overview"

"Using Enabled Subsystems"

"Using Triggered Subsystems"

"Using Enabled and Triggered Subsystems"

"Using Function-Call Subsystems"

Introduced before R2006a

Trigonometric Function

Specified trigonometric function on input

Library: Simulink / Math Operations
HDL Coder / Math Operations



Description

The Trigonometric Function block performs common trigonometric functions and outputs the result in rad or rev.

Supported Functions

You can select one of these functions from the **Function** parameter list.

| Function | Description | Mathematical Expression | MATLAB Equivalent |
|----------|--|-------------------------|-------------------|
| sin | Sine of the input | $\sin(u)$ | sin |
| cos | Cosine of the input | $\cos(u)$ | cos |
| tan | Tangent of the input | $\tan(u)$ | tan |
| asin | Inverse sine of the input | $\text{asin}(u)$ | asin |
| acos | Inverse cosine of the input | $\text{acos}(u)$ | acos |
| atan | Inverse tangent of the input | $\text{atan}(u)$ | atan |
| atan2 | Four-quadrant inverse tangent of the input | $\text{atan2}(u)$ | atan2 |
| sinh | Hyperbolic sine of the input | $\sinh(u)$ | sinh |
| cosh | Hyperbolic cosine of the input | $\cosh(u)$ | cosh |
| tanh | Hyperbolic tangent of the input | $\tanh(u)$ | tanh |
| asinh | Inverse hyperbolic sine of the input | $\text{asinh}(u)$ | asinh |
| acosh | Inverse hyperbolic cosine of the input | $\text{acosh}(u)$ | acosh |
| atanh | Inverse hyperbolic tangent of the input | $\text{atanh}(u)$ | atanh |

| Function | Description | Mathematical Expression | MATLAB Equivalent |
|------------|--|-------------------------|-------------------|
| sincos | Sine of the input; cosine of the input | — | — |
| cos + jsin | Complex exponential of the input | — | — |

CORDIC Approximation Method

CORDIC is an acronym for COordinate Rotation DIGital Computer. The Givens rotation-based CORDIC algorithm is one of the most hardware-efficient algorithms available because it requires only iterative shift-add operations. For more information, see “More About” on page 1-1905. The block input has further requirements.

For more information on when you set **Function** to `sin`, `cos`, `sincos`, or `cos + jsin` and set the **Approximation method** to CORDIC, see “Port_1” on page 1-0 .

This table summarizes what happens for an invalid input.

| Block Usage | Effect of Invalid Input |
|------------------|--|
| Simulation modes | An error appears. |
| Generated code | Undefined behavior occurs. Avoid relying on undefined behavior for generated code. |

Lookup Approximation Method

For more information on when you set **Function** to `sin`, `cos`, `sincos`, or `cos + jsin` and set the **Approximation method** to Lookup, see “Port_1” on page 1-0 .

Ports

Input

Port_1 — Input signal

scalar | vector | matrix

Input specified as a scalar, vector, or matrix. The block accepts input signals of the following data types:

| Functions | Input Data Types |
|--|---|
| <ul style="list-style-type: none"> • <code>sin</code> • <code>cos</code> • <code>sincos</code> • <code>cos + jsin</code> • <code>atan2</code> | <ul style="list-style-type: none"> • Floating point • Fixed point (only when Approximation method is CORDIC) |

| Functions | Input Data Types |
|--|--|
| <ul style="list-style-type: none"> • tan • asin • acos • atan • sinh • cosh • tanh • asinh • acosh • atanh | <ul style="list-style-type: none"> • Floating point |

CORDIC approximation fixed-point type propagations:

| Input Data Type | Function | Output Data Type |
|---------------------------------|----------------------------------|---|
| Fixed point, signed or unsigned | sin, cos, sincos, and cos + jsin | fixdt(1, WL, WL - 2) where WL is the input word length This fixed-point type provides the best precision for the CORDIC algorithm. |
| Fixed point, signed | atan2 | fixdt(1, WL, WL - 3) |
| Fixed point, unsigned | atan2 | fixdt(1, WL, WL - 2) |

Lookup approximation fixed-point type propagations:

| Input Data Type | Function | Output Data Type |
|-----------------------|-------------------------------------|----------------------|
| Fixed point, signed | sin, cos, sincos, cos + jsin, atan2 | fixdt(1, WL, FL) |
| Fixed point, unsigned | sin, cos, sincos, cos + jsin, atan2 | fixdt(1, WL - 1, FL) |

Dependencies

- When you set **Function** to atan2, the block shows two input ports. The first input (**Port_1**) is the y-axis or imaginary part of the function argument. The second input (**Port_2**) is the x-axis or real part of the function argument.
- You can use floating-point input signals when you set **Approximation method** to None, CORDIC, or Lookup. However, the block output data type depends on which of these approximation method options you choose.

| Input Data Type | Approximation Method | Output Data Type |
|-----------------|----------------------|---|
| Floating point | None | Depends on your selection for Output signal type . Options are auto (same data type as input), real, or complex. |

| Input Data Type | Approximation Method | Output Data Type |
|-----------------|----------------------|---|
| Floating point | CORDIC | Same as input. Output signal type is not available when you use the CORDIC approximation method to compute the block output. |
| Floating point | Lookup | Same as input. Output signal type is not available when you use the Lookup approximation method to compute the block output. |

For CORDIC and Lookup approximations:

- Input must be real for the `sin`, `cos`, `sincos`, `cos + jsin`, and `atan2` functions.
- Output is real for the `sin`, `cos`, `sincos`, and `atan2` functions.
- Output is complex for the `cos + jsin` function.

Limitations

- You can use fixed-point input signals only when **Approximation method** is set to CORDIC or Lookup. The CORDIC and Lookup approximations are available for the `sin`, `cos`, `sincos`, `cos + jsin`, and `atan2` functions.
- Complex input signals are supported for all functions in this block except `atan2`.
- When you set **Approximation method** to Lookup, the number of data points are limited by:
 - $smallEnoughNumDataPoints = 2^{(inputFractionLen-2)+1}$
 - $bigEnoughFractionLen = \log_2(numberOfDataPoints - 1)+2$

where:

- *smallEnoughNumDataPoints* is the maximum number of data points represented by specified input fraction length, *inputFractionLen*.
- *bigEnoughFractionLen* is the minimum fraction length needed to represent specified number of data points, *numberOfDataPoints*.
- When you set **Function** to `sin`, `cos`, `sincos`, or `cos + jsin` and set the **Approximation method** to CORDIC, the block has these limitations:
 - When you use signed fixed-point types, the input angle must fall within the range $[-2\pi, 2\pi)$ rad.
 - When you use unsigned fixed-point types, the input angle must fall within the range $[0, 2\pi)$ rad.

When you set **Function** to `atan2` and the **Approximation method** to CORDIC, the block has these limitations:

- Inputs must be the same size, or at least one value must be a scalar value.
- Both inputs must have the same data type.
- When you use signed fixed-point types, the word length must be 126 or less.
- When you use unsigned fixed-point types, the word length must be 125 or less.
- When you set **Function** to `sin`, `cos`, `sincos`, or `cos + jsin` and set the **Approximation method** to Lookup, the block has these limitations.

- When you use signed fixed-point types, the input angle must fall within the range $[-2\pi, 2\pi]$ rad.
- When you use unsigned fixed-point types, the input angle must fall within the range $[0, 2\pi)$ rad.
- When you set **Function** to atan2 and the **Approximation method** to Lookup, the block has these limitations:
 - Inputs must be the same size, or at least one value must be a scalar value.
 - Both inputs must have the same data type.

Data Types: half | single | double | int8 | int16 | int32 | int64 | uint8 | uint16 | uint32 | uint64 | fixed point

Port_2 — x-axis or real part of the function argument for atan2

scalar | vector | matrix

Input the x-axis or real part of the function argument for atan2. When you set **Function** to atan2, the block shows two input ports. The first input (**Port_1**) is the y-axis or imaginary part of the function argument. The second input (**Port_2**) is the x-axis or real part of the function argument. (See “Port Location After Rotating or Flipping” for a description of the port order for various block orientations.)

Dependencies

To enable this port, set **Function** to atan2.

Limitations

- Fixed-point input signals are supported only when you set **Approximation method** to CORDIC or Lookup.

Data Types: half | single | double | int8 | int16 | int32 | int64 | uint8 | uint16 | uint32 | uint64 | fixed point

Output

Port_1 — Specified trigonometric function of input

scalar | vector | matrix

Result of applying the specified trigonometric function to one or more inputs in rad. Each function supports:

- Scalar operations
- Element-wise vector and matrix operations

Data Types: half | single | double | int8 | int16 | int32 | int64 | uint8 | uint16 | uint32 | uint64 | fixed point

sin — Sine of input signal

scalar | vector | matrix

Sine of the input signal, in rad and rev.

Dependencies

To enable this port, set **Function** to sincos.

Limitations

Fixed-point input signals are supported only when you set **Approximation method** to CORDIC or Lookup.

Data Types: half | single | double | int8 | int16 | int32 | int64 | uint8 | uint16 | uint32 | uint64 | fixed point

cos — Cosine of input signal

scalar | vector | matrix

Cosine of the input signal, in rad and rev.

Dependencies

To enable this port, set **Function** to sincos.

Limitations

Fixed-point input signals are supported only when you set **Approximation method** to CORDIC or Lookup.

Data Types: half | single | double | int8 | int16 | int32 | int64 | uint8 | uint16 | uint32 | uint64 | fixed point

Parameters**Function — Trigonometric function**

sin (default) | cos | tan | asin | acos | atan | atan2 | sinh | cosh | tanh | asinh | acosh | atanh | sincos | cos + jsin

Specify the trigonometric function. The name of the function on the block icon changes to match your selection.

For more information on when you set **Function** to sin, cos, sincos, or cos + jsin and set the **Approximation method** to CORDIC, see “Limitations” on page 1-0 .

Programmatic Use

Block Parameter: Operator

Type: character vector

Values: 'sin' | 'cos' | 'tan' | 'asin' | 'acos' | 'atan' | 'atan2' | 'sinh' | 'cosh' | 'tanh' | 'asinh' | 'acosh' | 'atanh' | 'sincos' | 'cos + jsin'

Default: 'sin'

Approximation method — CORDIC, Lookup, or none

None (default) | CORDIC | Lookup

Specify the type of approximation for computing output.

| Approximation Method | Data Types Supported | When to Use This Method |
|----------------------|--------------------------------|--|
| None (default) | Floating point | You want to use the default Taylor series algorithm. |
| CORDIC | Floating point and fixed point | You want a fast, approximate iterative calculation. |

| Approximation Method | Data Types Supported | When to Use This Method |
|----------------------|--|---|
| Lookup | Floating point and fixed point (double and single) | You want a fast, approximate lookup table implementation. |

For more information on when you set **Function** to `sin`, `cos`, `sincos`, or `cos + jsin` and set the **Approximation method** to CORDIC, see “Limitations” on page 1-0 .

Dependencies

To enable this parameter, set **Function** to `sin`, `cos`, `sincos`, `cos + jsin`, or `atan2`.

To use fixed-point input signals, you must set **Approximation method** to CORDIC or Lookup.

Programmatic Use

Block Parameter: ApproximationMethod

Type: character vector

Values: 'None' | 'CORDIC' | 'Lookup'

Default: 'None'

Number of iterations – Number of iterations for CORDIC algorithm

11 (default) | positive integer, less than or equal to word length of fixed-point input

Specify the number of iterations to perform the CORDIC algorithm. The default value is 11.

- When the block input uses a floating-point data type, the number of iterations can be a positive integer.
- When the block input is a fixed-point data type, the number of iterations cannot exceed the word length.

For example, if the block input is `fixdt(1,16,15)`, the word length is 16. In this case, the number of iterations cannot exceed 16.

Dependencies

To enable this parameter, you must set the **Function** and **Approximation method** parameters as follows:

- Set **Function** to `sin`, `cos`, `sincos`, `cos + jsin`, or `atan2`.
- Set **Approximation method** to CORDIC.

Programmatic Use

Block Parameter: NumberOfIterations

Type: character vector

Values: positive integer, less than or equal to word length of fixed-point input

Default: '11'

Angle unit – Angle unit

radian (default) | revolution

Specify the angle unit for lookup method as radian or revolution.

Dependencies

To enable this parameter:

- Set **Function** to sin, cos, sincos, cos + jsin, or atan2.
- Set **Approximation method** to Lookup.

Programmatic Use**Block Parameter:** AngleUnit**Type:** character vector**Values:** 'radian' | 'revolution'**Default:** 'radian'**Number of data points — Number of data points for lookup table**

16 (default) | scalar

Specify the number of data points for lookup table as a scalar real number.

Dependencies

To enable this parameter:

- Set **Function** to sin, cos, sincos, cos + jsin, or atan2.
- Set **Approximation method** to Lookup.

Programmatic Use**Block Parameter:** NumberOfDataPoints**Type:** character vector**Values:** scalar**Default:** '16'**Output signal type — Complexity of output signal**

auto (default) | real | complex

Specify the output signal type of the Trigonometric Function block as auto, real, or complex.

| Function | Input Signal Type | Output Signal Type | | |
|---|-------------------|--------------------|-------|---------|
| | | Auto | Real | Complex |
| Any selection for the Function parameter | real | real | real | complex |
| | complex | complex | error | complex |

DependenciesSetting **Approximation method** to CORDIC disables this parameter.

Note When **Function** is atan2, complex input signals are not supported for simulation or code generation.

Programmatic Use**Block Parameter:** OutputSignalType**Type:** character vector**Values:** 'auto' | 'real' | 'complex'**Default:** 'auto'

Remove protection against out-of-range input — Remove protection against out-of-range input

off (default) | on

For `acos` and `asin`, select this check box to remove the protection against out-of-range inputs, which reduces redundancy.

- When you clear this check box, the protection is enabled. The block saturates out-of-range inputs to 1 or -1 before any operation is performed. Generated code contains code to check for out-of-range input.
- When you select this check box, the protection is removed. The block performs all operations on the input value without any changes. Generated code does not contain code to check for the out-of-range input.

Enabling this check box can eliminate redundancy if the input is already in range.

Dependencies

Setting **Function** to `acos` and `asin` enables this parameter.

Programmatic Use

Block Parameter: `RemoveProtectionAgainstOutOfRangeInput`

Type: character vector

Values: 'off' | 'on'

Default: 'off'

Sample time — Specify sample time as a value other than -1

-1 (default) | scalar | vector

Specify the sample time as a value other than -1. For more information, see “Specify Sample Time”.

Dependencies

This parameter is not visible unless it is explicitly set to a value other than -1. To learn more, see “Blocks for Which Sample Time Is Not Recommended”.

Programmatic Use

Block Parameter: `SampleTime`

Type: character vector

Values: scalar or vector

Default: '-1'

Block Characteristics

| | |
|---------------------------------|--|
| Data Types | double fixed point ^a half integer ^a single |
| Direct Feedthrough | yes |
| Multidimensional Signals | yes |
| Variable-Size Signals | yes |
| Zero-Crossing Detection | no |

a. This block supports fixed-point and base integer data types for 'Approximation method' CORDIC.

More About

CORDIC

CORDIC is an acronym for COordinate Rotation DIgital Computer. The Givens rotation-based CORDIC algorithm is one of the most hardware-efficient algorithms available because it requires only iterative shift-add operations (see References). The CORDIC algorithm eliminates the need for explicit multipliers. Using CORDIC, you can calculate various functions such as sine, cosine, arc sine, arc cosine, arc tangent, and vector magnitude. You can also use this algorithm for divide, square root, hyperbolic, and logarithmic functions.

Increasing the number of CORDIC iterations can produce more accurate results, but doing so increases the expense of the computation and adds latency.

References

- [1] Volder, Jack E., "The CORDIC Trigonometric Computing Technique." *IRE Transactions on Electronic Computers* EC-8 (1959); 330-334.
- [2] Andraka, Ray "A Survey of CORDIC Algorithm for FPGA Based Computers." *Proceedings of the 1998 ACM/SIGDA Sixth International Symposium on Field Programmable Gate Arrays*. Feb. 22-24 (1998): 191-200.
- [3] Walther, J.S., "A Unified Algorithm for Elementary Functions," *Proceedings of the Spring Joint Computer Conference*, May 18-20, 1971: 379-386.
- [4] Schelin, Charles W., "Calculator Function Approximation," *The American Mathematical Monthly* 90, no. 5 (1983): 317-325.

Extended Capabilities

C/C++ Code Generation

Generate C and C++ code using Simulink® Coder™.

Not all compilers support the `asinh`, `acosh`, and `atanh` functions. If you use a compiler that does not support those functions, a warning appears and the generated code fails to link.

HDL Code Generation

Generate Verilog and VHDL code for FPGA and ASIC designs using HDL Coder™.

HDL Coder provides additional configuration options that affect HDL implementation and synthesized logic.

HDL Architecture

You can generate HDL code for all functions of the block with floating-point data types and architecture set to `Trigonometric` in native floating-point mode. The native floating-point mode does not support `double` data types for the block.

This block has multi-cycle implementations that introduce additional latency in the generated code. To see the added latency, view the generated model or validation model. See "Generated Model and Validation Model" (HDL Coder).

The Trigonometric Function block supports HDL code generation for these functions in this table with CORDIC approximation method and Cordic HDL architecture for fixed-point data types.

- `sin`
- `cos`
- `sincos`
- `cos+jsin`
- `atan2`

The latency calculation depends on the word length and **LatencyStrategy** settings. To learn more, open the HDLMathLib library.

HDLMathLib

HDL Block Properties

| General | |
|----------------------------------|---|
| ConstrainedOutputPipeline | Number of registers to place at the outputs by moving existing delays within your design. Distributed pipelining does not redistribute these registers. The default is 0. For more details, see “ConstrainedOutputPipeline” (HDL Coder). |
| InputPipeline | Number of input pipeline stages to insert in the generated code. Distributed pipelining and constrained output pipelining can move these registers. The default is 0. For more details, see “InputPipeline” (HDL Coder). |
| OutputPipeline | Number of output pipeline stages to insert in the generated code. Distributed pipelining and constrained output pipelining can move these registers. The default is 0. For more details, see “OutputPipeline” (HDL Coder). |
| LatencyStrategy | To enable this property for fixed-point types, set Function as <code>sin</code> , <code>cos</code> , <code>sincos</code> , <code>cos+jsin</code> , or <code>atan2</code> and Approximation method as CORDIC. Specify whether to map the blocks in your design to MAX, CUSTOM, or ZERO latency for fixed-point and floating-point types. The default is MAX. See also “LatencyStrategy” (HDL Coder). |
| CustomLatency | To enable this property for fixed-point types, set Function as <code>sin</code> , <code>cos</code> , <code>sincos</code> , <code>cos+jsin</code> , or <code>atan2</code> and Approximation method as CORDIC. When LatencyStrategy is set to CUSTOM, use this property to specify a custom latency value between ZERO and MAX for fixed-point types. See also “LatencyStrategy” (HDL Coder). |
| Native Floating Point | |
| InputRangeReduction | Use this property for the <code>sin</code> , <code>cos</code> , <code>tan</code> , <code>sincos</code> , and <code>cos+jsin</code> functions. If your input range is unbounded, enable this property for HDL Coder to insert additional logic to reduce the range of inputs to $[-\pi, \pi]$. See also “InputRangeReduction” (HDL Coder). |

| Native Floating Point | |
|-------------------------|--|
| HandleDenormals | Specify whether you want HDL Coder to insert additional logic to handle denormal numbers in your design. Denormal numbers are numbers that have magnitudes less than the smallest floating-point number that can be represented without leading zeros in the mantissa. The default is <code>inherit</code> . See also “HandleDenormals” (HDL Coder). |
| LatencyStrategy | Specify whether to map the blocks in your design to <code>inherit</code> , <code>Max</code> , <code>Min</code> , or <code>Zero</code> for the floating-point operator. The default is <code>inherit</code> . See also “LatencyStrategy” (HDL Coder). |
| MultiplyStrategy | Use this property for the <code>sin</code> , <code>cos</code> , <code>tan</code> , <code>sincos</code> , and <code>cos+jsin</code> functions. The default is <code>inherit</code> . Specify whether you want to use <code>FullMultiplier</code> or <code>PartMultiplierPartAddShift</code> . See also “MantissaMultiplyStrategy” (HDL Coder). |

To see the latency calculation for fixed-point types with the block, at the MATLAB command prompt, enter:

```
HDLMathLib
```

Restrictions

- For the `sin` and `cos` functions, only signed fixed-point data types are supported for CORDIC approximations.
- For functions that have the CORDIC mode such as `sin`, `cos`, `sincos`, `atan2`, and `cos+jsin`, fixed-point data types greater than 127 bits are not supported for HDL code generation.
- HDL Coder displays an error when you select these settings for a Trigonometric Function block inside a feedback loop:
 - HDL architecture as `SinCosCordic`
 - **UsePipelinedKernel** as `On`

The error occurs because the block is in a feedback loop and the code generator is unable to insert additional latency. To avoid this error, add a delay of length equal to the **Number of iterations** + 3 adjacent to the block. The code generator then absorbs this delay to meet the additional latency of the Trigonometric Function block.

For example, this Trigonometric Function block has **Number of iterations** set to 30. A Delay of length 33 adjacent to the block meets the additional latency.

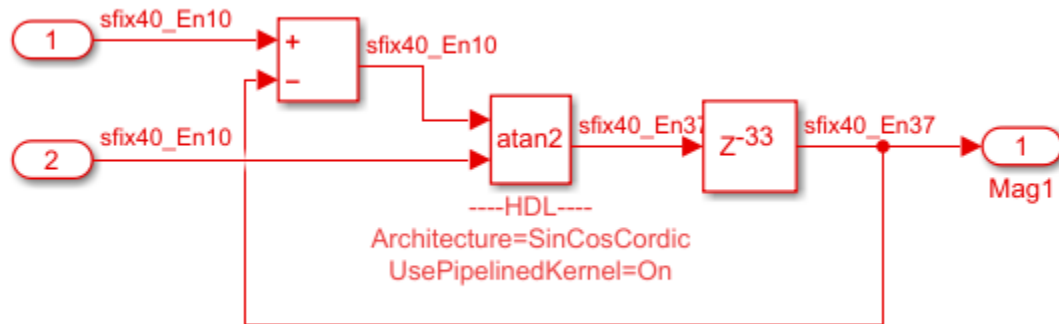

PLC Code Generation

Generate Structured Text code using Simulink® PLC Coder™.

Fixed-Point Conversion

Design and simulate fixed-point systems using Fixed-Point Designer™.

This block supports fixed-point and base integer data types when you set the **Function** to sin, cos, sincos, cos + jsin, or atan2 and set the **Approximation method** to CORDIC.

See Also

Blocks

Math Function | Sqrt | Sine, Cosine

Functions

cordicsin | cordiccos | cordicsincos

Introduced before R2006a

Unary Minus

Negate input

Library: Simulink / Math Operations
 HDL Coder / HDL Floating Point Operations
 HDL Coder / Math Operations



Description

The Unary Minus block negates the input.

Ports

Input

Port_1 — Signal to negate

scalar | vector | matrix | N-D array

Input signal, specified as a scalar, vector, matrix, or N-D array.

Data Types: half | single | double | int8 | int16 | int32 | int64 | fixed point

Output

Port_1 — Negation of input signal

scalar | vector | matrix | N-D array

Negation of the input signal. The output has the same data type and dimensions as the input.

Data Types: half | single | double | int8 | int16 | int32 | int64 | fixed point

Parameters

Saturate on integer overflow — Method of overflow action

off (default) | on

Select to have integer overflows saturate. Otherwise, overflows wrap.

When you select this check box, saturation applies to every internal operation on the block, not just the output, or result. In general, the code generation process can detect when overflow is not possible. In this case, the code generator does not produce saturation code.

For signed-integer data types, the unary minus of the most negative value is not representable by the data type. In this case, the **Saturate on integer overflow** check box controls the behavior of the block:

| Parameter Setting | Block Behavior | Examples |
|---|---|---|
| Saturate on integer overflow = on | Values saturate to the most positive value of the integer data type | <ul style="list-style-type: none"> For 8-bit signed integers, -128 maps to 127. For 16-bit signed integers, -32768 maps to 32767. For 32-bit signed integers, -2147483648 maps to 2147483647. |
| Saturate on integer overflow = off | Values wrap to the most negative value of the integer data type | <ul style="list-style-type: none"> For 8-bit signed integers, -128 remains -128. For 16-bit signed integers, -32768 remains -32768. For 32-bit signed integers, -2147483648 remains -2147483648. |

Programmatic Use

Block Parameter: SaturateOnIntegerOverflow

Type: character vector

Values: 'off' | 'on'

Default: 'off'

Sample time — Specify sample time as a value other than -1

-1 (default) | scalar | vector

Specify the sample time as a value other than -1. For more information, see “Specify Sample Time”.

Dependencies

This parameter is not visible unless it is explicitly set to a value other than -1. To learn more, see “Blocks for Which Sample Time Is Not Recommended”.

Programmatic Use

Block Parameter: SampleTime

Type: character vector

Values: scalar or vector

Default: '-1'

Block Characteristics

| | |
|---------------------------------|--|
| Data Types | double fixed point ^a half integer ^a single |
| Direct Feedthrough | yes |
| Multidimensional Signals | yes |
| Variable-Size Signals | no |
| Zero-Crossing Detection | no |

a. This block only supports signed fixed-point data types.

Extended Capabilities

C/C++ Code Generation

Generate C and C++ code using Simulink® Coder™.

HDL Code Generation

Generate Verilog and VHDL code for FPGA and ASIC designs using HDL Coder™.

HDL Coder provides additional configuration options that affect HDL implementation and synthesized logic.

HDL Architecture

This block has a single, default HDL architecture.

HDL Block Properties

| | |
|----------------------------------|--|
| ConstrainedOutputPipeline | Number of registers to place at the outputs by moving existing delays within your design. Distributed pipelining does not redistribute these registers. The default is 0. For more details, see “ConstrainedOutputPipeline” (HDL Coder). |
| InputPipeline | Number of input pipeline stages to insert in the generated code. Distributed pipelining and constrained output pipelining can move these registers. The default is 0. For more details, see “InputPipeline” (HDL Coder). |
| OutputPipeline | Number of output pipeline stages to insert in the generated code. Distributed pipelining and constrained output pipelining can move these registers. The default is 0. For more details, see “OutputPipeline” (HDL Coder). |

Complex Data Support

This block supports code generation for complex signals.

PLC Code Generation

Generate Structured Text code using Simulink® PLC Coder™.

Fixed-Point Conversion

Design and simulate fixed-point systems using Fixed-Point Designer™.

This block only supports signed fixed-point data types.

See Also

uminus

Topics

“Operator Precedence”

Introduced before R2006a

Uniform Random Number

Generate uniformly distributed random numbers

Library: Simulink / Sources

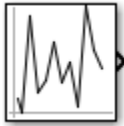

Description

The Uniform Random Number block generates uniformly distributed random numbers over an interval that you specify. To generate normally distributed random numbers, use the Random Number block. Both blocks use the Normal (Gaussian) random number generator ('v4': legacy MATLAB 4.0 generator of the `rng` function).

You can generate a repeatable sequence using any Uniform Random Number block with the same nonnegative seed and parameters. The seed resets to the specified value each time a simulation starts.

Avoid integrating a random signal, because solvers must integrate relatively smooth signals. Instead, use the Band-Limited White Noise block.

The numeric parameters of this block must have the same dimensions after scalar expansion. If you select the **Interpret vector parameters as 1-D** check box and the numeric parameters are row or column vectors after scalar expansion, the block outputs a 1-D signal. If you clear the **Interpret vector parameters as 1-D** check box, the block outputs a signal of the same dimensionality as the parameters.

Ports

Output

Port_1 — Random number output signal

scalar | vector

Output signal of generated uniformly distributed random numbers over the interval you specify.

Data Types: double

Parameters

Minimum — Minimum interval

0 (default) | scalar | vector | matrix | N-D array

Specify the minimum of the interval.

Programmatic Use

Block Parameter: Minimum

Type: character vector

Values: scalar

Default: '-1'

Maximum — Maximum interval

0 (default) | scalar | vector | matrix | N-D array

Specify the maximum of the interval.

Programmatic Use

Block Parameter: Maximum

Type: character vector

Values: scalar

Default: '1'

Seed — Random number seed

0 (default) | scalar | vector | matrix | N-D array

Specify the starting seed for the random number generator.

The seed must be 0 or a positive integer. Output is repeatable for a given seed.

Programmatic Use

Block Parameter: Seed

Type: character vector

Values: scalar

Default: '0'

Sample time — Sample time

0.1 (default) | scalar

Specify the time interval between samples. See “Specify Sample Time” for more information.

Programmatic Use

Block Parameter: SampleTime

Type: character vector

Values: scalar

Default: '0.1'

Interpret vector parameters as 1-D — Treat vectors as 1-D

on (default) | off

Select this check box to output a vector of length N if the **Constant value** parameter evaluates to an N-element row or column vector.

- When you select this check box, the block outputs a vector of length N if the **Constant value** parameter evaluates to an N-element row or column vector. For example, the block outputs a matrix of dimension 1-by-N or N-by-1.
- When you clear this check box, the block does not output a vector of length N if the **Constant value** parameter evaluates to an N-element row or column vector.

Programmatic Use

Block Parameter: VectorParams1D

Type: character vector

Values: 'on' | 'off'

Default: 'on'

Block Characteristics

| | |
|---------------------------------|--------|
| Data Types | double |
| Direct Feedthrough | no |
| Multidimensional Signals | yes |
| Variable-Size Signals | no |
| Zero-Crossing Detection | no |

Extended Capabilities

C/C++ Code Generation

Generate C and C++ code using Simulink® Coder™.

See Also

Random Number | Repeating Sequence | rng

Introduced before R2006a

Unit System Configuration

Restrict units to specified allowed unit systems

Library: Simulink / Ports & Subsystems



Description

The Unit System Configuration block specifies allowed and disallowed unit systems for the component. It restricts units systems for a subsystem or top model and all its children, unless you override it with another Unit System Configuration block in a child.

This block supports normal, accelerator, and rapid accelerator modes and fast restart.

Parameters

Disallowed unit systems — Disallowed unit systems

SI | English | SI (extended) | CGS

Displays a list of the disallowed unit systems. By default, the **Allow all unit systems** check box is selected, and all unit systems are allowed.

To designate a unit system as disallowed, select it in the **Allowed unit systems** column and click **<< Disallow**.

Dependencies

To enable changes to this parameter, you must first clear the **Allow all unit systems** check box.

Allowed unit systems — Allowed unit systems

SI | English | SI (extended) | CGS

Displays a list of the allowed unit systems. By default, the **Allow all unit systems** check box is selected, and all unit systems are allowed.

To designate a unit system as allowed, use the **Allow >>** and **<< Disallow** buttons to move unit systems between the **Disallowed unit systems** and **Allowed unit systems** columns.

Dependencies

To enable changes to this parameter, you must first clear the **Allow all unit systems** check box.

Programmatic Use

Block Parameter: UnitSystems

Type: cell array of character vectors

Values: cell array of the following character vectors: 'SI' | 'English' | 'SI (extended)' | 'CGS'

Default: {'SI', 'English', 'SI (extended)', 'CGS'}

Allow all unit systems — Allow all unit systems

on (default) | off

When you select this check box, all unit systems are allowed. To restrict the allowed unit systems to only the ones specified in the **Allowed unit systems** column, clear this check box.

Dependencies

Selecting the **Allow all unit systems** check box disables the **Disallowed unit systems** and **Allowed unit systems** parameters.

Programmatic Use

Block Parameter: AllowAllUnitSystems

Type: character vector

Values: 'on' | 'off'

Default: 'on'

Block Characteristics

| | |
|---------------------------------|--|
| Data Types | Boolean bus double enumerated fixed point integer single |
| Direct Feedthrough | no |
| Multidimensional Signals | yes |
| Variable-Size Signals | yes |
| Zero-Crossing Detection | no |

Extended Capabilities**C/C++ Code Generation**

Generate C and C++ code using Simulink® Coder™.

Fixed-Point Conversion

Design and simulate fixed-point systems using Fixed-Point Designer™.

See Also

Unit Conversion | Inport | Outport

Topics

“Update an Existing Model to Use Units”

“Units in Simulink”

“Unit Specification in Simulink Models”

“Restricting Unit Systems”

Introduced in R2016a

Unit Conversion

Convert units

Library: Simulink / Signal Attributes

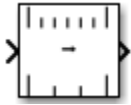

Description

The Unit Conversion block converts the unit of the input signal to the output signal. The block can perform the conversion if the units are separated by a scaling factor or offset, or are inverse units, for example:

- $y = a*U$
- $y = a*U+b$, where a is the scale and b is the offset
- $y = a/U$

This block supports normal, accelerator, and rapid accelerator modes and fast restart.

Ports

Input

Port_1 – Input signal

scalar | vector | matrix

Input signal for unit conversion, specified as a scalar, vector, or matrix.

Data Types: single | double | int8 | int16 | int32 | int64 | uint8 | uint16 | uint32 | uint64 | fixed point

Output

Port_1 – Output signal

scalar | vector | matrix

Output signal with converted units, specified as a scalar, vector, or matrix.

Data Types: single | double | int8 | int16 | int32 | int64 | uint8 | uint16 | uint32 | uint64 | fixed point

Parameters

Output data type – Output data type

Inherit: Inherit via internal rule (default) | Inherit: Inherit via back propagation

Specify the output data type.

- **Inherit: Inherit via internal rule** — Simulink chooses intermediate and output data types to balance numerical accuracy, performance, and generated code size, while accounting for the properties of the embedded target hardware. If you change the embedded target settings, the data type selected by the internal rule might change.
- **Inherit: Inherit via back propagation** — Output data type is inherited via back propagation. Internal rules determine the intermediate data types and Simulink casts the final results to the output data type.

Programmatic Use

Block Parameter: OutDataTypeStr

Type: character vector

Values: 'Inherit via internal rule' | 'Inherit via back propagation'

Default: 'Inherit via internal rule'

Block Characteristics

| | |
|---------------------------------|---|
| Data Types | double fixed point integer single |
| Direct Feedthrough | yes |
| Multidimensional Signals | yes |
| Variable-Size Signals | yes |
| Zero-Crossing Detection | no |

Extended Capabilities

C/C++ Code Generation

Generate C and C++ code using Simulink® Coder™.

Fixed-Point Conversion

Design and simulate fixed-point systems using Fixed-Point Designer™.

See Also

“Converting Units”

Topics

“Units in Simulink”

“Converting Units”

Introduced in R2016a

Unit Delay

Delay signal one sample period

Library: Simulink / Discrete
HDL Coder / Discrete



Description

The Unit Delay block holds and delays its input by the sample period you specify. When placed in an iterator subsystem, it holds and delays its input by one iteration. This block is equivalent to the z^{-1} discrete-time operator. The block accepts one input and generates one output. Each signal can be scalar or vector. If the input is a vector, the block holds and delays all elements of the vector by the same sample period.

You specify the block output for the first sampling period with the **Initial conditions** parameter. Careful selection of this parameter can minimize unwanted output behavior. You specify the time between samples with the **Sample time** parameter. A setting of -1 means the block inherits the **Sample time**.

Note The Unit Delay block errors out if you use it to create a transition between blocks operating at different sample rates. Use the Rate Transition block instead.

Comparison with Similar Blocks

The Memory, Unit Delay, and Zero-Order Hold blocks provide similar functionality but have different capabilities. Also, the purpose of each block is different.

This table shows recommended usage for each block.

| Block | Purpose of the Block | Reference Examples |
|-----------------------|--|--|
| Unit Delay | Implement a delay using a discrete sample time that you specify. The block accepts and outputs signals with a discrete sample time. | <ul style="list-style-type: none"> “Engine Timing Model with Closed Loop Control” on page 13-140 (Compression subsystem) |
| Memory on page 1-1086 | Implement a delay by one major integration time step. Ideally, the block accepts continuous (or fixed in minor time step) signals and outputs a signal that is fixed in minor time step. | <ul style="list-style-type: none"> “Building a Clutch Lock-Up Model” on page 13-144 (Friction Mode Logic/Lockup FSM subsystem) “Capture the Velocity of a Bouncing Ball with the Memory Block” on page 12-85 |

| Block | Purpose of the Block | Reference Examples |
|-----------------|--|--|
| Zero-Order Hold | Convert an input signal with a continuous sample time to an output signal with a discrete sample time. | <ul style="list-style-type: none"> • “Developing the Apollo Lunar Module Digital Autopilot” on page 13-203 • “Radar Tracking Using MATLAB Function Block” on page 13-227 |

Each block has the following capabilities.

| Capability | Memory | Unit Delay | Zero-Order Hold |
|------------------------------------|--|------------|--|
| Specification of initial condition | Yes | Yes | No, because the block output at time $t = 0$ must match the input value. |
| Specification of sample time | No, because the block can only inherit sample time from the driving block or the solver used for the entire model. | Yes | Yes |
| Support for frame-based signals | No | Yes | Yes |
| Support for state logging | No | Yes | No |

String Support

The Unit Delay block can accept and output string data type only if the block is configured for a delay length of 0 or 1 or for direct feedthrough.

Ports

Input

Port_1 — Input signal

scalar | vector

Input signal that the block delays by one sample period.

Data Types: half | single | double | int8 | int16 | int32 | int64 | uint8 | uint16 | uint32 | uint64 | string | Boolean | fixed point | enumerated | bus

Output

Port_1 — Output signal

scalar | vector

Output signal that is the input delayed by one sample period.

Data Types: half | single | double | int8 | int16 | int32 | int64 | uint8 | uint16 | uint32 | uint64 | string | Boolean | fixed point | enumerated | bus

Parameters

Main

Initial condition — First sample period output

0 (default) | scalar | vector

Specify the output of the simulation for the first sampling period, during which the output of the Unit Delay block is otherwise undefined.

Programmatic Use

Block Parameter: InitialCondition

Type: character vector

Value: scalar | vector

Default: '0'

Input processing — Specify sample- or frame-based processing

Elements as channels (sample based) (default) | Columns as channels (frame based)

Specify whether the block performs sample- or frame-based processing:

- Columns as channels (frame based) — Treat each column of the input as a separate channel (frame-based processing).

Note Frame-based processing requires a DSP System Toolbox license.

For more information, see “Sample- and Frame-Based Concepts” (DSP System Toolbox).

- Elements as channels (sample based) — Treat each element of the input as a separate channel (sample-based processing).

Use **Input processing** to specify whether the block performs sample- or frame-based processing. For more information about these two processing modes, see “Sample- and Frame-Based Concepts” (DSP System Toolbox).

Programmatic Use

Block Parameter: InputProcessing

Type: character vector

Values: 'Columns as channels (frame based)' | 'Elements as channels (sample based)'

Default: 'Elements as channels (sample based)'

Sample time (-1 for inherited) — Discrete interval between sample time hits

-1 (default) | scalar

Enter the discrete interval between sample time hits or specify -1 to inherit the sample time.

See also “Specify Sample Time”.

Programmatic Use

Block Parameter: SampleTime

Type: character vector

Value: real scalar

Default: '-1'

State Attributes

State name — Unique name for block state

' ' (default) | alphanumeric string

Use this parameter to assign a unique name to the block state. The default is ' '. When this field is blank, no name is assigned. When using this parameter, remember these considerations:

- A valid identifier starts with an alphabetic or underscore character, followed by alphanumeric or underscore characters.
- The state name applies only to the selected block.

This parameter enables **State name must resolve to Simulink signal object** when you click **Apply**.

For more information, see “C Code Generation Configuration for Model Interface Elements” (Simulink Coder).

Programmatic Use

Block Parameter: StateName

Type: character vector

Values: unique name

Default: ' '

State name must resolve to Simulink signal object — Require state names resolve to signal object

Off (default) | Boolean

Specify if requiring that state name resolve to Simulink signal objects or not. If selected, the software generates an error at run time if you specify a state name that does not match the name of a Simulink signal object.

Dependency

Enabled when you give the parameter **State name** a value and set the model configuration parameter **Signal resolution** to a value other than None.

Selecting this check box disables **Code generation storage class**.

Programmatic Use

Block Parameter: StateMustResolveToSignalObject

Type: character vector

Values: 'off' | 'on'

Default: 'off'

Block Characteristics

| | |
|---------------------------------|--|
| Data Types | Boolean bus double enumerated fixed point half integer single string |
| Direct Feedthrough | yes |
| Multidimensional Signals | yes |
| Variable-Size Signals | yes |

| | |
|--------------------------------|----|
| Zero-Crossing Detection | no |
|--------------------------------|----|

Extended Capabilities

C/C++ Code Generation

Generate C and C++ code using Simulink® Coder™.

Generated code relies on memcpy or memset functions (strong.h) under certain conditions.

HDL Code Generation

Generate Verilog and VHDL code for FPGA and ASIC designs using HDL Coder™.

HDL Coder provides additional configuration options that affect HDL implementation and synthesized logic.

HDL Architecture

This block has a single, default HDL architecture.

HDL Block Properties

| | |
|-----------------------|--|
| InputPipeline | Number of input pipeline stages to insert in the generated code. Distributed pipelining and constrained output pipelining can move these registers. The default is 0. For more details, see “InputPipeline” (HDL Coder). |
| OutputPipeline | Number of output pipeline stages to insert in the generated code. Distributed pipelining and constrained output pipelining can move these registers. The default is 0. For more details, see “OutputPipeline” (HDL Coder). |
| ResetType | Suppress reset logic generation. The default is default, which generates reset logic. See also “ResetType” (HDL Coder). |

Complex Data Support

This block supports code generation for complex signals.

PLC Code Generation

Generate Structured Text code using Simulink® PLC Coder™.

Fixed-Point Conversion

Design and simulate fixed-point systems using Fixed-Point Designer™.

See Also

Delay | Resettable Delay

Introduced before R2006a

Variable Integer Delay

Delay input signal by variable sample period

Library: Simulink / Discrete

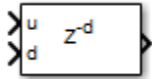

Description

The Variable Integer Delay block is a variant of the Delay block that has the source of the delay length set to Input port, by default.

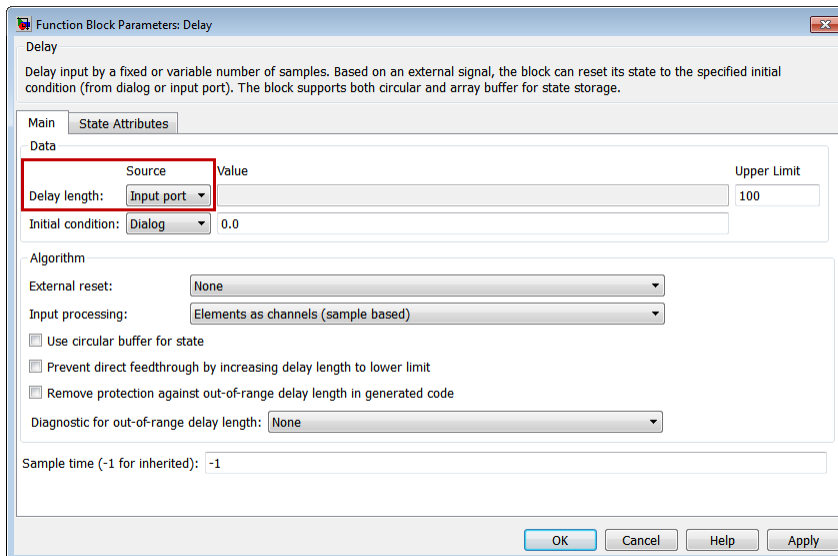

Ports

Input

u — Data input signal

scalar | vector

Input data signal delayed according to parameters settings.

Data Types: half | single | double | int8 | int16 | int32 | int64 | uint8 | uint16 | uint32 | uint64 | Boolean | fixed point | enumerated | bus

d — Delay length

scalar

Delay length specified as inherited from an input port. Enabled when you select the **Delay length: Source** parameter as Input port.

Data Types: half | single | double | int8 | int16 | int32 | int64 | uint8 | uint16 | uint32 | uint64 | fixed point

Enable — External enable signal

scalar

Enable signal that enables or disables execution of the block. To create this port, select the **Show enable port** parameter.

Data Types: single | double | int8 | int16 | int32 | int64 | uint8 | uint16 | uint32 | uint64 | Boolean | fixed point

External reset — External reset signal

scalar

External signal that resets execution of the block to the initial condition. To create this port, select the **External reset** parameter.

Data Types: single | double | int8 | int16 | int32 | int64 | uint8 | uint16 | uint32 | uint64 | Boolean | fixed point

x0 — Initial condition

scalar | vector

Initial condition specified as inherited from an input port. Enabled when you select the **Initial Condition: Source** parameter as Input port.

Data Types: half | single | double | int8 | int16 | int32 | int64 | uint8 | uint16 | uint32 | uint64 | fixed point

Output**Port_1 — Output signal**

scalar | vector

Output signal that is the input signal delayed by the length of time specified by the parameter **Delay length**. The initial value of the output signal depends on several conditions. See “Initial Block Output” on page 1-277.

Data Types: half | single | double | int8 | int16 | int32 | int64 | uint8 | uint16 | uint32 | uint64 | Boolean | fixed point | enumerated | bus

Parameters**Main****Delay length — Delay length**

Dialog (default) | Input port

Specify whether to enter the delay length directly on the dialog box (fixed delay) or to inherit the delay from an input port (variable delay).

- If you set **Source** to Dialog, enter the delay length in the edit field under **Value**.
- If you set **Source** to Input port, verify that an upstream signal supplies a delay length for the d input port. You can also specify its maximum value by specifying the parameter **Upper limit**.

Specify the scalar delay length as a real, non-negative integer. An out-of-range or non-integer value in the dialog box (fixed delay) returns an error. An out-of-range value from an input port (variable delay)

casts it into the range. A non-integer value from an input port (variable delay) truncates it to the integer.

Programmatic Use

Block Parameter: DelayLengthSource

Type: character vector

Values: 'Dialog' | 'Input port' |

Default: 'Dialog'

Block Parameter: DelayLength

Type: character vector

Values: scalar

Default: '2'

Block Parameter: DelayLengthUpperLimit

Type: character vector

Values: scalar

Default: '100'

Initial condition — Initial condition

Dialog (default) | Input port

Specify whether to enter the initial condition directly on the dialog box or to inherit the initial condition from an input port.

- If you set **Source** to Dialog, enter the initial condition in the edit field under **Value**.
- If you set **Source** to Input port, verify that an upstream signal supplies an initial condition for the x0 input port.

Simulink converts offline the data type of **Initial condition** to the data type of the input signal u using a round-to-nearest operation and saturation.

Note When **State name must resolve to Simulink signal object** is selected on the **State Attributes** pane, the block copies the initial value of the signal object to the **Initial condition** parameter. However, when the source for **Initial condition** is Input port, the block ignores the initial value of the signal object.

Programmatic Use

Block Parameter: InitialConditionSource

Type: character vector

Values: 'Dialog' | 'Input port' |

Default: 'Dialog'

Block Parameter: InitialCondition

Type: character vector

Values: scalar

Default: '0.0'

Input processing — Specify sample- or frame-based processing

Elements as channels (sample based) (default) | Columns as channels (frame based)

Specify whether the block performs sample- or frame-based processing:

- Columns as channels (frame based) — Treat each column of the input as a separate channel (frame-based processing).

Note Frame-based processing requires a DSP System Toolbox license.

For more information, see “Sample- and Frame-Based Concepts” (DSP System Toolbox).

- **Elements as channels (sample based)** — Treat each element of the input as a separate channel (sample-based processing).

Use **Input processing** to specify whether the block performs sample- or frame-based processing. For more information about these two processing modes, see “Sample- and Frame-Based Concepts” (DSP System Toolbox).

Programmatic Use

Block Parameter: InputProcessing

Type: character vector

Values: 'Columns as channels (frame based)' | 'Elements as channels (sample based)'

Default: 'Elements as channels (sample based)'

Use circular buffer for state — Circular buffer for storing state

off (default) | on

Select to use a circular buffer for storing the state in simulation and code generation. Otherwise, an array buffer stores the state.

Using a circular buffer can improve execution speed when the delay length is large. For an array buffer, the number of copy operations increases as the delay length goes up. For a circular buffer, the number of copy operations is constant for increasing delay length.

If one of the following conditions is true, an array buffer always stores the state because a circular buffer does not improve execution speed:

- For sample-based signals, the delay length is 1.
- For frame-based signals, the delay length is no larger than the frame size.

Programmatic Use

Block Parameter: UseCircularBuffer

Type: character vector

Values: 'off' | 'on'

Default: 'off'

Prevent direct feedthrough — Prevent direct feedthrough

off (default) | on

Select to increase the delay length from zero to the lower limit for the **Input processing** mode:

- For sample-based signals, increase the minimum delay length to 1.
- For frame-based signals, increase the minimum delay length to the frame length.

Selecting this check box prevents direct feedthrough from the input port, u , to the output port. However, this check box cannot prevent direct feedthrough from the initial condition port, x_0 , to the output port.

Dependency

To enable this parameter, set **Delay length: Source** to Input port.

Programmatic Use**Block Parameter:** PreventDirectFeedthrough**Type:** character vector**Values:** 'off' | 'on'**Default:** 'off'**Remove delay length check in generated code — Remove delay length out-of-range check**

off (default) | on

Select to remove code that checks for out-of-range delay length.

| Check Box | Result | When to Use |
|-----------|--|----------------------------------|
| Selected | Generated code does not include conditional statements to check for out-of-range delay length. | For code efficiency |
| Cleared | Generated code includes conditional statements to check for out-of-range delay length. | For safety-critical applications |

Dependency

To enable this parameter, set **Delay length: Source** to Input port.

Programmatic Use**Block Parameter:** RemoveDelayLengthCheckInGeneratedCode**Type:** character vector**Values:** 'off' | 'on'**Default:** 'off'**Diagnostic for delay length — Diagnostic checks for delay length**

None (default) | Warning | Error

Specify whether to produce a warning or error when the input d is less than the lower limit or greater than the **Delay length: Upper limit**. The lower limit depends on the setting for **Prevent direct feedthrough**.

- If the check box is cleared, the lower limit is zero.
- If the check box is selected, the lower limit is 1 for sample-based signals and frame length for frame-based signals.

Options for the diagnostic include:

- None — Simulink software takes no action.
- Warning — Simulink software displays a warning and continues the simulation.
- Error — Simulink software terminates the simulation and displays an error.

Dependency

To enable this parameter, set **Delay length: Source** to Input port.

Programmatic Use**Block Parameter:** DiagnosticForDelayLength**Type:** character vector**Values:** 'None' | 'Warning' | 'Error'**Default:** 'None'**Show enable port – Create enable port**

off (default) | on

Select to control execution of this block with an enable port. The block is considered enabled when the input to this port is nonzero, and is disabled when the input is 0. The value of the input is checked at the same time step as the block execution.

Programmatic Use**Block Parameter:** ShowEnablePort**Type:** character vector**Values:** 'off' | 'on'**Default:** 'off'**External reset – External state reset**

None (default) | Rising | Falling | Either | Level | Level hold

Specify the trigger event to use to reset the states to the initial conditions.

| Reset Mode | Behavior |
|------------|--|
| None | No reset |
| Rising | Reset on a rising edge |
| Falling | Reset on a falling edge |
| Either | Reset on either a rising or falling edge |
| Level | Reset in either of these cases: <ul style="list-style-type: none"> • When the reset signal is nonzero at the current time step • When the reset signal value changes from nonzero at the previous time step to zero at the current time step |
| Level hold | Reset when the reset signal is nonzero at the current time step |

Programmatic Use**Block Parameter:** ExternalReset**Type:** character vector**Values:** 'None' | 'Rising' | 'Falling' | 'Either' | 'Level' | 'Level hold'**Default:** 'None'**Sample time (-1 for inherited) – Discrete interval between sample time hits**

-1 (default) | scalar

Specify the time interval between samples. To inherit the sample time, set this parameter to -1. This block supports discrete sample time, but not continuous sample time.

Programmatic Use**Block Parameter:** SampleTime**Type:** character vector**Value:** real scalar**Default:** '-1'**State Attributes****State name — Unique name for block state**

' ' (default) | alphanumeric string

Use this parameter to assign a unique name to the block state. The default is ' '. When this field is blank, no name is assigned. When using this parameter, remember these considerations:

- A valid identifier starts with an alphabetic or underscore character, followed by alphanumeric or underscore characters.
- The state name applies only to the selected block.

This parameter enables **State name must resolve to Simulink signal object** when you click **Apply**.

For more information, see “C Code Generation Configuration for Model Interface Elements” (Simulink Coder).

Programmatic Use**Block Parameter:** StateName**Type:** character vector**Values:** unique name**Default:** ''**State name must resolve to Simulink signal object — Require state name resolve to a signal object**

off (default) | on

Select this check box to require that the state name resolves to a Simulink signal object.

Dependencies

To enable this parameter, specify a value for **State name**. This parameter appears only if you set the model configuration parameter **Signal resolution** to a value other than None.

Programmatic Use**Block Parameter:** StateMustResolveToSignalObject**Type:** character vector**Values:** 'off' | 'on'**Default:** 'off'**Block Characteristics**

| | |
|---------------------------|--|
| Data Types | Boolean bus double enumerated fixed point half integer single string |
| Direct Feedthrough | yes |

| | |
|---------------------------------|-----|
| Multidimensional Signals | yes |
| Variable-Size Signals | yes |
| Zero-Crossing Detection | no |

Extended Capabilities

C/C++ Code Generation

Generate C and C++ code using Simulink® Coder™.

Generated code relies on `memcpy` or `memset` functions (`string.h`) under certain conditions.

HDL Code Generation

Generate Verilog and VHDL code for FPGA and ASIC designs using HDL Coder™.

For information about HDL code generation, see “HDL Code Generation” on page 1-286 on the Delay page.

Fixed-Point Conversion

Design and simulate fixed-point systems using Fixed-Point Designer™.

See Also

Delay | Resettable Delay | Tapped Delay | Unit Delay

Topics

“Using Enabled Subsystems”

Introduced in R2012b

Variable Pulse Generator

Generate ideal, time varying pulse signal

Library: Simulink / Discontinuities



Description

Use the Variable Pulse Generator block to create ideal modulated pulse signals.

Generally speaking, the output pulse of the block is described by

$$y(t) = \begin{cases} 1 & t_k < t < t_k + pw \\ 0 & t_{k+1} < t < t_k + pw \end{cases}$$

where pw is the output pulse width.

For an implementation of Pulse Width Modulation, see PWM.

Ports

Input

D — Duty Cycle

scalar

Desired duty cycle of the pulse P , specified as scalar within the range $[0,1]$.

Data Types: double

P — Period

scalar

Time between rising edges of consecutive pulses of the output signal. A smaller value represents a higher frequency pulse.

Data Types: double

Output

Port 1 — Modulated pulse signal

scalar

Modulated output pulse signal corresponding to input duty cycle.

Data Types: double

Parameters

Allow zero pulse width — Allow zero magnitude of output signal

off (default) | on

Enable this parameter to allow the output pulse signal to support pulses of width 0.

Note Enabling this parameter causes the block to have direct feedthrough. This can cause algebraic loops in your model.

Data Types: Boolean

Run at fixed time intervals — Choose continuous or discrete-time behavior

continuous (default) | discrete

Select whether the block should operate in continuous or discrete sampling modes.

By default, the block uses `continuous` sampling mode as it improves simulation performance with variable step solvers.

Select `discrete` sampling mode if you need to:

- use a fixed-step solver
- generate code
- sample the block output

Sampling rate — Set pulse resolution

0.1 (default) | scalar

Specify the rate at which the block samples input duty cycle signal. This sampling rate becomes the resolution of the output pulse signal.

Dependencies

This parameter requires that **Sampling mode** is set to `discrete`

Block Characteristics

| | |
|---------------------------------|--------|
| Data Types | double |
| Direct Feedthrough | no |
| Multidimensional Signals | no |
| Variable-Size Signals | no |
| Zero-Crossing Detection | no |

Algorithms

Continuous Sampling Mode

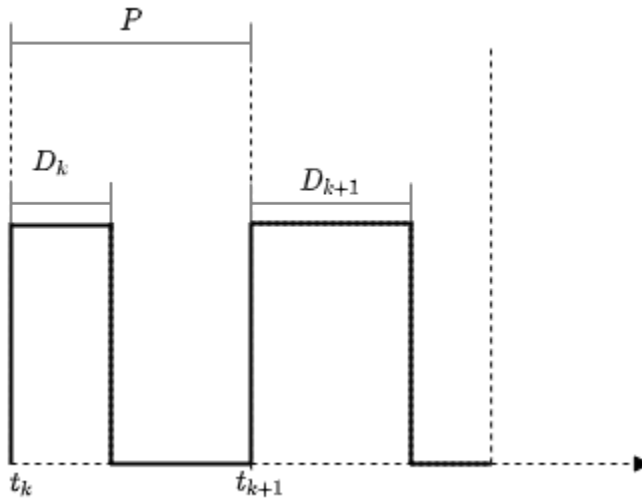

For a pulse starting at time t_k

$$y(t) = \begin{cases} 1 & t_k < t < t_k + pw \\ 0 & t_{k+1} < t < t_k + pw \end{cases}$$

where pw is the pulse width. For a given period P , pw is proportional to the duty cycle D

$$pw = D(t_k) * P(t_k)$$

Discrete Sampling Mode

In Discrete sampling mode, the input duty cycle signal is sampled at the rate specified by the **Sampling rate** parameter.

For a specified sampling rate t_s , the number of samples needed for a pulse of width pw can be expressed as follows

$$n_{pw} = \left\lceil \frac{D_k \cdot P_k}{T_S} \right\rceil \quad 0 < n_{pw} < n_P$$

$$n_P = \left\lceil \frac{P}{T_S} \right\rceil$$

where n_P is the number of samples needed to simulate a pulse of period P .

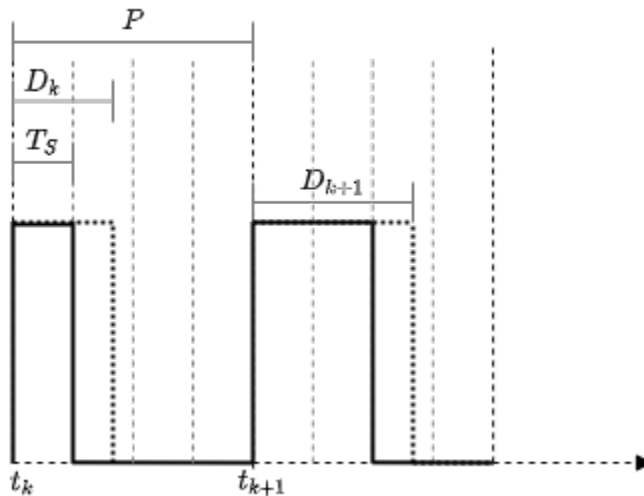

Consider a nominal pulse of period P with the sampling rate of the block set to be $t_s = 0.25 P$. The number of samples needed for one period of the pulse, $n_p = 4$. Thus, for the input duty cycle $D = 0.47$, the number of samples n_{pw} is floored to $\left\lfloor \frac{0.47P}{0.25} \right\rfloor = 1$. Therefore, the pulse is high for 1 of the 4 samples in the period.

Extended Capabilities

C/C++ Code Generation

Generate C and C++ code using Simulink® Coder™.

Not recommended for production-quality code. Relates to resource limits and restrictions on speed and memory often found in embedded systems. The code generated can contain dynamic allocation and freeing of memory, recursion, additional memory overhead, and widely-varying execution times. While the code is functionally valid and generally acceptable in resource-rich environments, smaller embedded targets often cannot support such code.

In general, consider using the Simulink Model Discretizer to map continuous blocks into discrete equivalents that support production code generation. To start the Model Discretizer, in the Simulink Editor, on the **Apps** tab, under **Apps**, under **Control Systems**, click **Model Discretizer**. One exception is the Second-Order Integrator block because, for this block, the Model Discretizer produces an approximate discretization.

See Also

PWM | Pulse Generator

Introduced in R2020b

Variable Time Delay

Delay input by variable amount of time

Library: Simulink / Continuous



Description

The Variable Transport Delay and Variable Time Delay blocks appear as two blocks in the Simulink block library. However, they are the same Simulink block with different settings for the **Select delay type** parameter. Use this parameter to specify the mode in which the block operates.

Variable Time Delay

In this mode, the block has a data input, a time delay input, and a data output. (See “Port Location After Rotating or Flipping” for a description of the port order for various block orientations.) The output at the current time step equals the value of its data input at a previous time step. This time step is the current simulation time minus a delay time specified by the time delay input.

$$y(t) = u(t - t_0) = u(t - \tau(t))$$

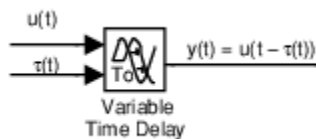

During the simulation, the block stores time and input value pairs in an internal buffer. At the start of simulation, the block outputs the value of the **Initial output** parameter until the simulation time exceeds the time delay input. Then, at each simulation step, the block outputs the signal at the time that corresponds to the current simulation time minus the delay time.

If you want the output at a time between input storing times and the solver is a continuous solver, the block interpolates linearly between points. If the time delay is smaller than the step size, the block extrapolates an output point from a previous point. For example, consider a fixed-step simulation with a step size of 1 and the current time at $t = 5$. If the delay is 0.5, the block must generate a point at $t = 4.5$, but the most recent stored time value is at $t = 4$. Thus, the block extrapolates the input at 4.5 from the input at 4 and uses the extrapolated value as its output at $t = 5$.

Extrapolating forward from the previous time step can produce a less accurate result than extrapolating back from the current time step. However, the block cannot use the current input to calculate its output value because the input port does not have direct feedthrough.

If the model specifies a discrete solver, the block does not interpolate between time steps. Instead, it returns the nearest stored value that precedes the required value.

Variable Transport Delay

In this mode, the block output at the current time step is equal to the value of its data (top, or left) input at an earlier time step equal to the current time minus a transport delay.

$$y(t) = u(t - t_d(t))$$

Simulink software finds the transport delay, $t_d(t)$, by solving the following equation:

$$\int_{-t_d(t)}^t \frac{1}{t_i(\tau)} d\tau = 1$$

This equation involves an instantaneous time delay, $t_i(t)$, given by the time delay (bottom, or right) input.

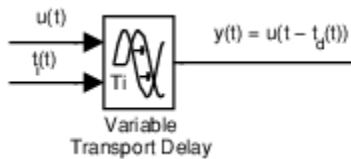

Suppose that you want to use this block to model the fluid flow through a pipe where the fluid speed varies with time. In this case, the time delay input to the block is

$$t_i(t) = \frac{L}{v_i(t)}$$

where L is the length of the pipe and $v_i(t)$ is the speed of the fluid.

Ports

Input

Port_1 – Input signal

scalar | vector | matrix

Input signal specified as a scalar, vector, or matrix.

Data Types: double

t_0 – Time delay input

scalar | vector | matrix

Time delay input specified as a scalar, vector, or matrix. When the block is in **Variable time delay** mode, this value specifies the time delay. For more information about that calculation, see “Variable Time Delay” on page 1-1936.

Dependencies

To enable this port, set **Select delay type** to **Variable time delay**.

Data Types: double

t_i – Instantaneous time delay input

scalar | vector | matrix

Instantaneous time delay input specified as a scalar, vector, or matrix. When the block is in **Variable transport delay** mode, this value is used to calculate the transport delay. For more information about that calculation, see “Variable Transport Delay” on page 1-1936.

Dependencies

To enable this port, set **Select delay type** to `Variable transport delay`.

Data Types: `double`

Output**Port_1 – Delayed signal**

`scalar` | `vector` | `matrix`

Output signal specified as a scalar, vector, or matrix.

Data Types: `double`

Parameters**Select delay type – Type of delay**

`Variable time delay` | `Variable transport delay`

Specify the type of delay as `Variable time delay` or `Variable transport delay`.

The default value of this parameter depends on the block implementation: `Variable time delay` for the Variable Time Delay block, and `Variable transport delay` for the Variable Transport Delay block.

Dependencies

- Setting this parameter to `Variable time delay` enables the **Handle zero delay** parameter.
- Setting this parameter to `Variable transport delay` enables the **Absolute tolerance** and **State Name** parameters.

Programmatic Use

Block Parameter: `VariableDelayType`

Type: character vector, string

Values: `'Variable transport delay'` | `'Variable time delay'`

Maximum delay – Maximum value of time delay input

`10` (default) | `scalar` | `vector`

Set the maximum value of the time delay input. This value defines the largest time delay input that this block allows. The block clips any delay that exceeds this value. This value cannot be negative. If the time delay becomes negative, the block clips it to zero and issues a warning message.

Programmatic Use

Block Parameter: `MaximumDelay`

Type: character vector, string

Value: `scalar` | `vector`

Default: `'10'`

Initial output – Initial output

`0` (default) | `scalar` | `vector`

Specify the output that the block generates until the simulation time first exceeds the time delay input.

Dependencies

- The initial output of this block cannot be `inf` or `NaN`.
- A Run-to-run tunable parameter cannot be changed during simulation run time. However, changing it before a simulation begins does not cause Accelerator or Rapid Accelerator to regenerate code.

Programmatic Use**Block Parameter:** InitialOutput**Type:** character vector, string**Values:** scalar | vector**Default:** '0'**Initial buffer size — Initial memory allocation**

1024 (default) | scalar

Define the initial memory allocation for the number of input points to store. The input points define the history of the input signal up to the current simulation time.

- If the number of input points exceeds the initial buffer size, the block allocates additional memory.
- After simulation ends, a message displays if the buffer is not sufficient and more memory must be allocated.

Tips

- Because allocating memory slows down simulation, choose this value carefully if simulation speed is an issue.
- For long time delays, this block might use a large amount of memory, particularly for dimensionalized input.

Programmatic Use**Block Parameter:** MaximumPoints**Type:** character vector, string**Values:** scalar | vector**Default:** '1024'**Use fixed buffer size — Use fixed-size buffer**

off (default) | on

Selecting this check box uses a fixed-size buffer to save input data from previous time steps. When you clear this check box, the block does not use a fixed-size buffer.

The **Initial buffer size** parameter specifies the buffer size. If the buffer is full, new data replaces data already in the buffer. Simulink software uses linear extrapolation to estimate output values that are not in the buffer.

Note ERT or GRT code generation uses a fixed-size buffer even if you do not select this check box.

Tips

- If the input data is linear, selecting this check box can save memory.
- If the input data is nonlinear, do not select this check box. Doing so might yield inaccurate results.

Programmatic Use**Block Parameter:** FixedBuffer**Type:** character vector, string**Values:** 'off' | 'on'**Default:** 'off'**Handle zero delay — Use direct feedthrough**

off (default) | on

Selecting this check box converts this block to a direct feedthrough block. When you clear this check box, the block does not use direct feedthrough.

Dependencies

To enable this parameter, set **Select delay type** to Variable time delay.

Programmatic Use**Block Parameter:** ZeroDelay**Type:** character vector, string**Values:** 'off' | 'on'**Default:** 'off'**Direct feedthrough of input during linearization — Use direct feedthrough during linearization**

off (default) | on

When you select this parameter, the block outputs its input during linearization and trim, which sets the block mode to direct feedthrough. To disable direct feedthrough, clear this check box.

Tips

- Selecting this check box can cause a change in the ordering of states in the model when you use the functions `linmod`, `dlinmod`, or `trim`. To extract this new state ordering:

- 1 Compile the model using the following command, where `model` is the name of the Simulink model.

```
[sizes, x0, x_str] = model([],[],[],'lincompile');
```

- 2 Terminate the compilation with the following command.

```
model([],[],[],'term');
```

- The output argument `x_str`, which is a cell array of the states in the Simulink model, contains the new state ordering. When you pass a vector of states as input to the `linmod`, `dlinmod`, or `trim` functions, the state vector must use this new state ordering.

Programmatic Use**Block Parameter:** TransDelayFeedthrough**Type:** character vector, string**Values:** 'off' | 'on'**Default:** 'off'**Pade order (for linearization) — Order of Pade approximation**

0 (default) | scalar

Set the order of the Pade approximation for linearization routines.

- The default value is 0, which results in a unity gain with no dynamic states.
- Setting the order to a positive integer n adds n states to your model, but results in a more accurate linear model of the transport delay.

Programmatic Use**Block Parameter:** PadeOrder**Type:** character vector, string**Values:** scalar**Default:** '0'**Absolute tolerance – Absolute tolerance for computing block state**

auto (default) | positive, real, scalar or vector

Specify the absolute tolerance for computing the block state.

DependenciesTo enable this parameter, set **Select delay type** to Variable transport delay.**Programmatic Use****Block Parameter:** AbsoluteTolerance**Type:** character vector, string**Values:** 'auto' | '-1' | any positive real scalar or vector**Default:** 'auto'**State Name (e.g., 'position') – Unique name for each state**

' ' (default) | character vector, string

Assign a unique name to each state. If this field is blank, no name assignment occurs.

Tips

- To assign a name to a single state, enter the name between quotes, for example, 'velocity'.
- To assign names to multiple states, enter a comma-delimited list surrounded by braces, for example, {'a', 'b', 'c'}. Each name must be unique.
- The state names apply only to the selected block.
- The number of states must divide evenly among the number of state names.
- You can specify fewer names than states, but you cannot specify more names than states.

For example, you can specify two names in a system with four states. The first name applies to the first two states and the second name to the last two states.

- To assign state names with a variable in the MATLAB workspace, enter the variable without quotes. A variable can be a character vector, string, cell array, or structure.

DependenciesTo enable this parameter, set **Select delay type** to Variable transport delay.**Programmatic Use****Block Parameter:** ContinuousStateAttributes**Type:** character vector, string**Values:** ' ' | user-defined character vector, user-defined string**Default:** ' '

Block Characteristics

| | |
|---------------------------------|--------|
| Data Types | double |
| Direct Feedthrough | yes |
| Multidimensional Signals | no |
| Variable-Size Signals | no |
| Zero-Crossing Detection | no |

Extended Capabilities

C/C++ Code Generation

Generate C and C++ code using Simulink® Coder™.

Not recommended for production-quality code. Relates to resource limits and restrictions on speed and memory often found in embedded systems. The code generated can contain dynamic allocation and freeing of memory, recursion, additional memory overhead, and widely-varying execution times. While the code is functionally valid and generally acceptable in resource-rich environments, smaller embedded targets often cannot support such code.

In general, consider using the Simulink Model Discretizer to map continuous blocks into discrete equivalents that support production code generation. To start the Model Discretizer, in the Simulink Editor, on the **Apps** tab, under **Apps**, under **Control Systems**, click **Model Discretizer**. One exception is the Second-Order Integrator block because, for this block, the Model Discretizer produces an approximate discretization.

See Also

Transport Delay | Variable Transport Delay

Topics

“State”

Introduced in R2007a

Variable Transport Delay

Delay input by variable amount of time

Library: Simulink / Continuous



Description

The Variable Transport Delay and Variable Time Delay blocks appear as two blocks in the Simulink block library. However, they are the same Simulink block with different settings for the **Select delay type** parameter. Use this parameter to specify the mode in which the block operates.

Variable Transport Delay

In this mode, the block output at the current time step is equal to the value of its data (top, or left) input at an earlier time step equal to the current time minus a transport delay.

$$y(t) = u(t - t_d(t))$$

Simulink software finds the transport delay, $t_d(t)$, by solving the following equation:

$$\int_{-t_d(t)}^t \frac{1}{t_i(\tau)} d\tau = 1$$

This equation involves an instantaneous time delay, $t_i(t)$, given by the time delay (bottom, or right) input.

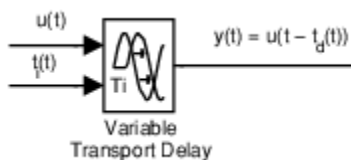

Suppose that you want to use this block to model the fluid flow through a pipe where the fluid speed varies with time. In this case, the time delay input to the block is

$$t_i(t) = \frac{L}{v_i(t)}$$

where L is the length of the pipe and $v_i(t)$ is the speed of the fluid.

Variable Time Delay

In this mode, the block has a data input, a time delay input, and a data output. (See “Port Location After Rotating or Flipping” for a description of the port order for various block orientations.) The output at the current time step equals the value of its data input at a previous time step. This time step is the current simulation time minus a delay time specified by the time delay input.

$$y(t) = u(t - t_0) = u(t - \tau(t))$$

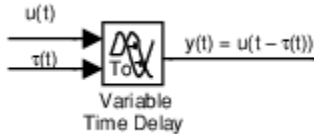

During the simulation, the block stores time and input value pairs in an internal buffer. At the start of simulation, the block outputs the value of the **Initial output** parameter until the simulation time exceeds the time delay input. Then, at each simulation step, the block outputs the signal at the time that corresponds to the current simulation time minus the delay time.

If you want the output at a time between input storing times and the solver is a continuous solver, the block interpolates linearly between points. If the time delay is smaller than the step size, the block extrapolates an output point from a previous point. For example, consider a fixed-step simulation with a step size of 1 and the current time at $t = 5$. If the delay is 0.5, the block must generate a point at $t = 4.5$, but the most recent stored time value is at $t = 4$. Thus, the block extrapolates the input at 4.5 from the input at 4 and uses the extrapolated value as its output at $t = 5$.

Extrapolating forward from the previous time step can produce a less accurate result than extrapolating back from the current time step. However, the block cannot use the current input to calculate its output value because the input port does not have direct feedthrough.

If the model specifies a discrete solver, the block does not interpolate between time steps. Instead, it returns the nearest stored value that precedes the required value.

Ports

Input

Port_1 — Input signal

scalar | vector | matrix

Input signal specified as a scalar, vector, or matrix.

Data Types: double

t_0 — Time delay input

scalar | vector | matrix

Time delay input specified as a scalar, vector, or matrix. When the block is in **Variable time delay** mode, this value specifies the time delay. For more information about that calculation, see “Variable Time Delay” on page 1-1943.

Dependencies

To enable this port, set **Select delay type** to **Variable time delay**.

Data Types: double

t_i — Instantaneous time delay input

scalar | vector | matrix

Instantaneous time delay input specified as a scalar, vector, or matrix. When the block is in **Variable transport delay** mode, this value is used to calculate the transport delay. For more information about that calculation, see “Variable Transport Delay” on page 1-1943.

Dependencies

To enable this port, set **Select delay type** to `Variable transport delay`.

Data Types: `double`

Output**Port_1 – Delayed signal**

`scalar` | `vector` | `matrix`

Output signal specified as a scalar, vector, or matrix.

Data Types: `double`

Parameters**Select delay type – Type of delay**

`Variable time delay` | `Variable transport delay`

Specify the type of delay as `Variable time delay` or `Variable transport delay`.

The default value of this parameter depends on the block implementation: `Variable time delay` for the Variable Time Delay block, and `Variable transport delay` for the Variable Transport Delay block.

Dependencies

- Setting this parameter to `Variable time delay` enables the **Handle zero delay** parameter.
- Setting this parameter to `Variable transport delay` enables the **Absolute tolerance** and **State Name** parameters.

Programmatic Use

Block Parameter: `VariableDelayType`

Type: character vector, string

Values: `'Variable transport delay'` | `'Variable time delay'`

Maximum delay – Maximum value of time delay input

`10` (default) | `scalar` | `vector`

Set the maximum value of the time delay input. This value defines the largest time delay input that this block allows. The block clips any delay that exceeds this value. This value cannot be negative. If the time delay becomes negative, the block clips it to zero and issues a warning message.

Programmatic Use

Block Parameter: `MaximumDelay`

Type: character vector, string

Value: `scalar` | `vector`

Default: `'10'`

Initial output – Initial output

`0` (default) | `scalar` | `vector`

Specify the output that the block generates until the simulation time first exceeds the time delay input.

Dependencies

- The initial output of this block cannot be `inf` or `NaN`.
- A Run-to-run tunable parameter cannot be changed during simulation run time. However, changing it before a simulation begins does not cause Accelerator or Rapid Accelerator to regenerate code.

Programmatic Use**Block Parameter:** `InitialOutput`**Type:** character vector, string**Values:** scalar | vector**Default:** `'0'`**Initial buffer size — Initial memory allocation**

1024 (default) | scalar

Define the initial memory allocation for the number of input points to store. The input points define the history of the input signal up to the current simulation time.

- If the number of input points exceeds the initial buffer size, the block allocates additional memory.
- After simulation ends, a message displays if the buffer is not sufficient and more memory must be allocated.

Tips

- Because allocating memory slows down simulation, choose this value carefully if simulation speed is an issue.
- For long time delays, this block might use a large amount of memory, particularly for dimensionalized input.

Programmatic Use**Block Parameter:** `MaximumPoints`**Type:** character vector, string**Values:** scalar | vector**Default:** `'1024'`**Use fixed buffer size — Use fixed-size buffer**

off (default) | on

Selecting this check box uses a fixed-size buffer to save input data from previous time steps. When you clear this check box, the block does not use a fixed-size buffer.

The **Initial buffer size** parameter specifies the buffer size. If the buffer is full, new data replaces data already in the buffer. Simulink software uses linear extrapolation to estimate output values that are not in the buffer.

Note ERT or GRT code generation uses a fixed-size buffer even if you do not select this check box.

Tips

- If the input data is linear, selecting this check box can save memory.
- If the input data is nonlinear, do not select this check box. Doing so might yield inaccurate results.

Programmatic Use**Block Parameter:** FixedBuffer**Type:** character vector, string**Values:** 'off' | 'on'**Default:** 'off'**Handle zero delay — Use direct feedthrough**

off (default) | on

Selecting this check box converts this block to a direct feedthrough block. When you clear this check box, the block does not use direct feedthrough.

Dependencies

To enable this parameter, set **Select delay type** to Variable time delay.

Programmatic Use**Block Parameter:** ZeroDelay**Type:** character vector, string**Values:** 'off' | 'on'**Default:** 'off'**Direct feedthrough of input during linearization — Use direct feedthrough during linearization**

off (default) | on

When you select this parameter, the block outputs its input during linearization and trim, which sets the block mode to direct feedthrough. To disable direct feedthrough, clear this check box.

Tips

- Selecting this check box can cause a change in the ordering of states in the model when you use the functions `linmod`, `dlinmod`, or `trim`. To extract this new state ordering:
 - 1 Compile the model using the following command, where `model` is the name of the Simulink model.

```
[sizes, x0, x_str] = model([],[],[],'lincompile');
```
 - 2 Terminate the compilation with the following command.

```
model([],[],[],'term');
```
- The output argument `x_str`, which is a cell array of the states in the Simulink model, contains the new state ordering. When you pass a vector of states as input to the `linmod`, `dlinmod`, or `trim` functions, the state vector must use this new state ordering.

Programmatic Use**Block Parameter:** TransDelayFeedthrough**Type:** character vector, string**Values:** 'off' | 'on'**Default:** 'off'**Pade order (for linearization) — Order of Pade approximation**

0 (default) | scalar

Set the order of the Pade approximation for linearization routines.

- The default value is 0, which results in a unity gain with no dynamic states.
- Setting the order to a positive integer n adds n states to your model, but results in a more accurate linear model of the transport delay.

Programmatic Use**Block Parameter:** PadeOrder**Type:** character vector, string**Values:** scalar**Default:** '0'**Absolute tolerance – Absolute tolerance for computing block state**

auto (default) | positive, real, scalar or vector

Specify the absolute tolerance for computing the block state.

Dependencies

To enable this parameter, set **Select delay type** to Variable transport delay.

Programmatic Use**Block Parameter:** AbsoluteTolerance**Type:** character vector, string**Values:** 'auto' | '-1' | any positive real scalar or vector**Default:** 'auto'**State Name (e.g., 'position') – Unique name for each state**

' ' (default) | character vector, string

Assign a unique name to each state. If this field is blank, no name assignment occurs.

Tips

- To assign a name to a single state, enter the name between quotes, for example, 'velocity'.
- To assign names to multiple states, enter a comma-delimited list surrounded by braces, for example, {'a', 'b', 'c'}. Each name must be unique.
- The state names apply only to the selected block.
- The number of states must divide evenly among the number of state names.
- You can specify fewer names than states, but you cannot specify more names than states.

For example, you can specify two names in a system with four states. The first name applies to the first two states and the second name to the last two states.

- To assign state names with a variable in the MATLAB workspace, enter the variable without quotes. A variable can be a character vector, string, cell array, or structure.

Dependencies

To enable this parameter, set **Select delay type** to Variable transport delay.

Programmatic Use**Block Parameter:** ContinuousStateAttributes**Type:** character vector, string**Values:** ' ' | user-defined character vector, user-defined string**Default:** ' '

Block Characteristics

| | |
|---------------------------------|--------|
| Data Types | double |
| Direct Feedthrough | yes |
| Multidimensional Signals | no |
| Variable-Size Signals | no |
| Zero-Crossing Detection | no |

Extended Capabilities

C/C++ Code Generation

Generate C and C++ code using Simulink® Coder™.

Not recommended for production-quality code. Relates to resource limits and restrictions on speed and memory often found in embedded systems. The code generated can contain dynamic allocation and freeing of memory, recursion, additional memory overhead, and widely-varying execution times. While the code is functionally valid and generally acceptable in resource-rich environments, smaller embedded targets often cannot support such code.

In general, consider using the Simulink Model Discretizer to map continuous blocks into discrete equivalents that support production code generation. To start the Model Discretizer, in the Simulink Editor, on the **Apps** tab, under **Apps**, under **Control Systems**, click **Model Discretizer**. One exception is the Second-Order Integrator block because, for this block, the Model Discretizer produces an approximate discretization.

See Also

Transport Delay | Variable Time Delay | Entity Transport Delay

Topics

“State”

Introduced in R2007a

Variant Sink

Route amongst multiple outputs using Variants

Library: Simulink / Signal Routing

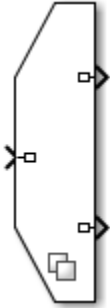

Description

The Variant Sink block has one input port and one or more output ports. You can define Variant choices as blocks that are connected to the output port so that, at most, one choice is active.

Each output port is associated with a Variant control. The Variant control that evaluates to `true`, determines which output port is active.

During simulation, Simulink connects the active choice directly to the input port of the Variant Sink block and ignores the inactive choices.

Note Sample time for single input Variant Sink blocks can differ with multiple input Variant Sink blocks. For more information on sample time, see “What Is Sample Time?”

Ports

Input

Port_1 — Input signal

scalar | vector | matrix

Input signal, specified as a scalar, vector, or matrix, to be connected to the active output port.

Data Types: `single` | `double` | `half` | `int8` | `int16` | `int32` | `int64` | `uint8` | `uint16` | `uint32` | `uint64` | `Boolean` | `fixed point` | `enumerated` | `bus` | `struct`

Output

Port_1 — Output from first Variant

scalar | vector | matrix

Output signal from the first Variant. The Variant control that evaluates to `true`, determines which output port is active.

Data Types: `single` | `double` | `half` | `int8` | `int16` | `int32` | `int64` | `uint8` | `uint16` | `uint32` | `uint64` | `Boolean` | `fixed point` | `enumerated` | `bus`

Port_N — Output from Nth Variant

scalar | vector | matrix

Output signal from the Nth Variant. The Variant control that evaluates to `true`, determines which output port is active.

Data Types: `single` | `double` | `half` | `int8` | `int16` | `int32` | `int64` | `uint8` | `uint16` | `uint32` | `uint64` | `Boolean` | `fixed point` | `enumerated` | `bus`

Parameters**Variant control mode — Name of Variant control mode**

expression (default) | label | sim codegen switching

- `expression`— To choose the active Variant based on the evaluation of the Variant conditions, use `expression` mode. The Variant control variables used in the Variant condition must be created in a global workspace or in a data dictionary.
- `label`— To choose the active Variant based on the name of the Variant you specify in the **Label mode active choice** parameter, use `label` mode. In `label` mode, the Variant control is a string and does not need to be created in any workspaces.

When you select `label` mode, the Variant badge indicates the change.

Note When you promote the **Label mode active choice** parameter to a mask, **Variant control mode** is disabled.

- If the block is in `expression` mode while promoting the **Label mode active choice** parameter to a mask, you can change the **Variant control mode** to `label` by changing the promoted **Label mode active choice** parameter from the Mask dialog box.
- If the block is in `label` mode while promoting the **Label mode active choice** parameter to a mask, you cannot change the **Variant control mode** to `expression` mode.

For information about promoting parameters to masks, see “Promote Parameter to Mask”.

- `sim codegen switching`— To automatically switch between the Variants for simulation and code generation workflows, use `sim codegen switching` mode. When you simulate (Normal, Accelerator, Rapid Accelerator) a model, then Simulink automatically chooses the `sim` branch as the active choice. Similarly, when you do a Software-in-the-loop (SIL), Processor-In-Loop (PIL) simulation or generate code or use external mode, Simulink automatically chooses the `codegen` branch.

When you set this parameter to different values, the Variant badge changes as shown in “Variant Badges”.

Dependencies

The **Variant activation time** parameter is available only when you set the **Variant control mode** parameter to `expression` or `sim codegen switching`.

Variant activation time — Determine when Simulink chooses active variant choice

update diagram (default) | update diagram analyze all choices | code compile

This parameter determines if Simulink sets the active choice of a Variant Sink block during update diagram or code compile. This parameter also determines which variability to include in the generated code for ERT targets. If you choose to include all the Variant choices, the choices are enclosed within C preprocessor conditional statements (`#if` and `#endif`) in the generated code.

When you set this parameter to different values, the variant badge changes as shown in “Variant Badges”.

You can set the **Variant activation time** parameter as:

- `update diagram`— Simulink sets the active choice during update diagram before the propagation of signal attributes. Inactive choices are removed prior to propagation of signal attributes, so the generated code contains only active choice.
- `update diagram analyze all choices`— Simulink sets the active choice during update diagram after the propagation of signal attributes. Signal attributes are propagated to both active and inactive choices. All choices are analyzed to ensure consistency of all variant branches between the results of simulation and code generation. Inactive choices are removed at the end of update diagram before model start occurs. The generated code contains only active choices. This workflow remains the same for simulation and code generation.
- `code compile`— For simulation, the workflow is same as the `update diagram analyze all choices`. However, the inactive choices are not removed during code generation. The generated code contains active and inactive choices, and the choices are enclosed in C preprocessor conditional statements, `#if` and `#endif`.
- `startup`— When you execute the model, both active and inactive choices are analyzed for consistency across the model and the choices participate in the simulation and the code generation workflow. With this option, you can improve the speed of iterative simulations using fast restart. For more information, see “How Fast Restart Improves Iterative Simulations”. The code that you generate from the model contains both active and inactive choices that are enclosed in regular `if` conditions. The executable that you build from the generated code also contains both active and inactive choices.

This figure shows the Variant activation time for the different values you specify in this parameter.

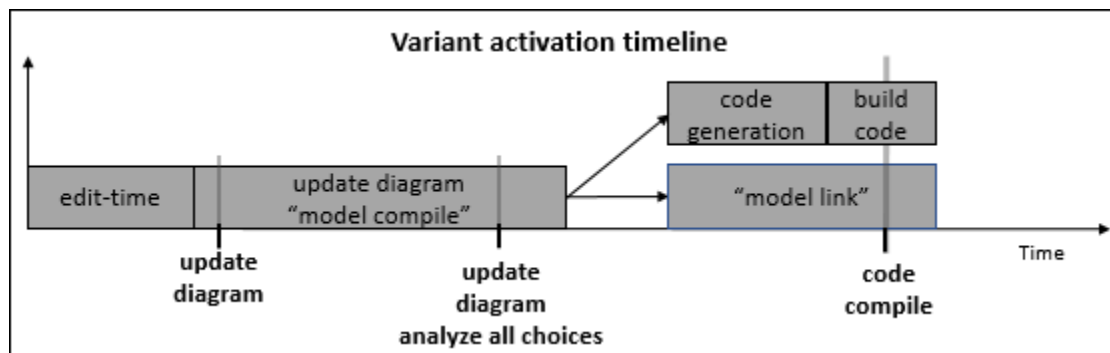

For more information, see “Represent Variant Source and Sink Blocks in Generated Code” (Embedded Coder).

Dependencies

The availability of different variant activation times depends on the type of the variant control mode that you specify. The **Variant activation time** parameter determines the time frame when Simulink

sets the active choice. The parameter also determines which variability to include in the generated code. This table explains the variant activation time supported by each variant control mode.

| Variant activation time | | | | |
|-------------------------|----------------|------------------------------------|--------------|---------|
| Variant control mode | update diagram | update diagram analyze all choices | code compile | startup |
| expression | ✓ | ✓ | ✓ | ✓ |
| label | ✓ | x | x | x |
| sim codegen switching | ✓ | ✓ | x | x |

Programmatic Use

Block Parameter: VariantActivationTime

Type: character vector

Values: update diagram | update diagram analyze all choices | code compile

Default: update diagram

Port — Number of connected input port

no default

Number of the input port that is connected to one Variant choice upstream of the Variant Sink block. This value is read-only.

Click  to add a port or  to delete an existing one.

Variant control expression — Variant controls available in the global workspace

'Variant' (default) | boolean condition expression | Simulink.Variant object | Simulink.Parameter object | enum

Displays the Variant controls available in the global workspace. The Variant control can be a Boolean condition expression or a Simulink.Variant object representing a Boolean condition expression. If you want to generate code for your model, you must define the control variables as MATLAB variables.

To enter non-numeric Variant control values, use enumerated data. For information about using enumerated data, see “Use Enumerated Data in Simulink Models”

To enter a Variant name, double-click a **Variant control expression** cell in a new row and type in the Variant control expression. Click **Apply** after you edit a Variant control name. If you add or delete a Variant control without applying the changes, the previous edits on the Variant control name are lost.

Programmatic Use

Block Parameter: VariantControls

Type: cell array of character vectors

Values: Variant control that is associated with the Variant choice

Default: 'Variant'

Condition (read-only) — Condition for Variant controls

no default

Displays the **Condition** for the Variant controls that are `Simulink.Variant` objects. Create or change a Variant condition in the `Simulink.Variant` parameter dialog box or in the global workspace.

For more information, see “Create Variant Controls Programmatically” and `Simulink.Variant`.

Label mode active choice — Name of Variant to use if Label control mode is selected

Choice_1 (default) | name of variant control

When you select the **Variant control mode** as `Label`, the **Label mode active choice** option is available. You can select an active Variant choice from **Label mode active choice** options. You can also right-click the badge on the Variant Sink block and select **Label Mode Active Choice**.

The **Label mode active choice** drop-down list displays all Variant controls that are currently defined in the global workspace or a data dictionary. Use valid MATLAB identifiers to specify Variant controls. For more information, see `Simulink.Variant`.

Note **Label mode active choice** option is not available in `Expression` mode.

Dependencies

To enable this parameter, select `Label` mode.

Programmatic Use

Block Parameter: `LabelModeActivechoice`

Type: character vector

Values: Specified by the Variant control expression

Default: `Choice_1`

Allow zero active variant controls — Simulate model without active Variant choice

off (default) | on

To simulate a model (containing a Variant block) without an active Variant choice, select the **Allow zero active variant controls** option. When this option is selected and there is no active Variant choice, Simulink disables all the blocks connected to the input and output stream of Variant Sink block. The removed blocks are ignored from update diagram or simulation.

If you do not select this option, Simulink generates an error when there is no active Variant choice.

When you select this option, the Variant badge indicates the change.

Dependencies

Expression option from **Variant control mode** is selected.

Programmatic Use

Block Parameter: `AllowZeroVariantControls`

Type: character vector

Values: 'off' | 'on'

Default: 'off'

Show variant condition on block — Annotate block ports

off (default) | on

When you select this option, Simulink annotates each Variant control (condition expression) on the Variant Sink block ports.

Programmatic Use

Block Parameter: ShowConditionOnBlock

Type: character vector

Values: 'off' | 'on'

Default: 'off'

Block Characteristics

| | |
|---------------------------------|--|
| Data Types | Boolean bus double enumerated fixed point half integer single string |
| Direct Feedthrough | no |
| Multidimensional Signals | no |
| Variable-Size Signals | no |
| Zero-Crossing Detection | no |

Extended Capabilities

C/C++ Code Generation

Generate C and C++ code using Simulink® Coder™.

Fixed-Point Conversion

Design and simulate fixed-point systems using Fixed-Point Designer™.

See Also

Variant Source | Simulink.Variant | Manual Variant Source | Manual Variant Sink | Variant Subsystem | Model

Topics

“Introduction to Variant Controls”

“Define, Configure, and Activate Variant Choices in a Variant Subsystem Block”

“Working with Variant Choices”

“Variant Systems” (Embedded Coder)

“Represent Variant Source and Sink Blocks in Generated Code” (Embedded Coder)

“Variants Example Models”

Introduced in R2016a

Variant Source

Route among multiple inputs using Variants

Library: Simulink / Signal Routing



Description

The Variant Source block has one or more input ports and one output port. You can define Variant choices as blocks that are connected to the input port so that, at most, one choice is active.

Each input port is associated with a Variant control. The Variant control that evaluates to `true`, determines which input port is active.

When the **Variant activation time** option in the block dialog box is set to `update diagram`, then during simulation Simulink connects the active choice directly to the output port of the Variant Source block and ignores the inactive choices.

Note Sample time for single input Variant Source blocks can differ with multiple input Variant Source blocks. For more information on sample time, see “What Is Sample Time?”

Ports

Input

Port_1 – Input port associated with first Variant control

scalar | vector | matrix

Input port associated with the first Variant control. The Variant control that evaluates to `true`, determines which input port is active.

Data Types: `single` | `double` | `half` | `int8` | `int16` | `int32` | `int64` | `uint8` | `uint16` | `uint32` | `uint64` | `Boolean` | `fixed point` | `enumerated` | `bus`

Port_N – Input port associated with Nth Variant control

scalar | vector | matrix

Input port associated with the Nth Variant control. The Variant control that evaluates to `true`, determines which input port is active.

Data Types: `single` | `double` | `half` | `int8` | `int16` | `int32` | `int64` | `uint8` | `uint16` | `uint32` | `uint64` | `Boolean` | `fixed point` | `enumerated` | `bus`

Output

Port_1 — Output of active Variant

scalar | vector | matrix

Output signal from the active Variant.

Data Types: single | double | half | int8 | int16 | int32 | int64 | uint8 | uint16 | uint32 | uint64 | Boolean | fixed point | enumerated | bus

Parameters

Variant control mode — Name of Variant control mode

expression (default) | label | sim codegen switching

- **expression**— To choose the active Variant based on the evaluation of the Variant conditions, use **expression** mode. The Variant control variables used in the Variant condition must be created in a global workspace or in a data dictionary.
- **label**— To choose the active Variant based on the name of the Variant you specify in the **Label mode active choice** parameter, use **label** mode. In **label** mode, the Variant control is a string and does not need to be created in any workspaces.

When you select **label** mode, the Variant badge indicates the change.

Note When you promote the **Label mode active choice** parameter to a mask, **Variant control mode** is disabled.

- If the block is in **expression** mode while promoting the **Label mode active choice** parameter to a mask, you can change the **Variant control mode** to **label** by changing the promoted **Label mode active choice** parameter from the Mask dialog box.
- If the block is in **label** mode while promoting the **Label mode active choice** parameter to a mask, you cannot change the **Variant control mode** to **expression** mode.

For information about promoting parameters to masks, see “Promote Parameter to Mask”.

- **sim codegen switching**— To automatically switch between the Variants for simulation and code generation workflows, use **sim codegen switching** mode. When you simulate (Normal, Accelerator, Rapid Accelerator) a model, then Simulink automatically chooses the **sim** branch as the active choice. Similarly, when you do a Software-in-the-loop (SIL), Processor-In-Loop (PIL) simulation or generate code or use external mode, Simulink automatically chooses the **codegen** branch.

When you set this parameter to different values, the Variant badge changes as shown in “Variant Badges”.

Dependencies

The **Variant activation time** parameter is available only when you set the **Variant control mode** parameter to **expression** or **sim codegen switching**.

Variant activation time — Determine when Simulink chooses active variant choice

update diagram (default) | update diagram analyze all choices | code compile

This parameter determines if Simulink sets the active choice of a Variant Source block during update diagram or code compile. This parameter also determines which variability to include in the

generated code for ERT targets. If you choose to include all the Variant choices, the choices are enclosed within C preprocessor conditional statements (`#if` and `#endif`) in the generated code.

When you set this parameter to different values, the variant badge changes as shown in “Variant Badges”.

You can set the **Variant activation time** parameter as:

- **update diagram**— Simulink sets the active choice during update diagram before the propagation of signal attributes. Inactive choices are removed prior to propagation of signal attributes, so the generated code contains only active choice.
- **update diagram analyze all choices**— Simulink sets the active choice during update diagram after the propagation of signal attributes. Signal attributes are propagated to both active and inactive choices. All choices are analyzed to ensure consistency of all variant branches between the results of simulation and code generation. Inactive choices are removed at the end of update diagram before model start occurs. The generated code contains only active choices. This workflow remains the same for simulation and code generation.
- **code compile**— For simulation, the workflow is same as the **update diagram analyze all choices**. However, the inactive choices are not removed during code generation. The generated code contains active and inactive choices, and the choices are enclosed in C preprocessor conditional statements, `#if` and `#endif`.
- **startup**— When you execute the model, both active and inactive choices are analyzed for consistency across the model and the choices participate in the simulation and the code generation workflow. With this option, you can improve the speed of iterative simulations using fast restart. For more information, see “How Fast Restart Improves Iterative Simulations”. The code that you generate from the model contains both active and inactive choices that are enclosed in regular `if` conditions. The executable that you build from the generated code also contains both active and inactive choices.

This figure shows the Variant activation time for the different values you specify in this parameter.

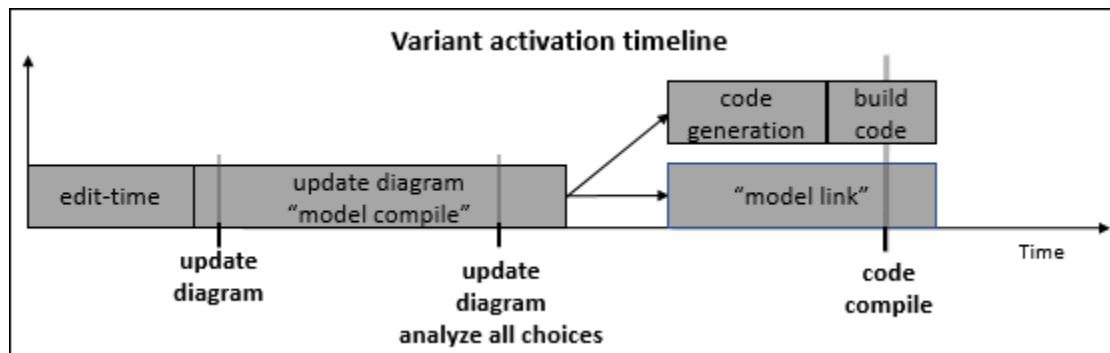

For more information, see “Represent Variant Source and Sink Blocks in Generated Code” (Embedded Coder).

Dependencies

The availability of different variant activation times depends on the type of the variant control mode that you specify. The **Variant activation time** parameter determines the time frame when Simulink sets the active choice. The parameter also determines which variability to include in the generated code. This table explains the variant activation time supported by each variant control mode.

| Variant activation time | | | | |
|-------------------------|----------------|------------------------------------|--------------|---------|
| Variant control mode | update diagram | update diagram analyze all choices | code compile | startup |
| expression | ✓ | ✓ | ✓ | ✓ |
| label | ✓ | x | x | x |
| sim codegen switching | ✓ | ✓ | x | x |

Programmatic Use**Block Parameter:** VariantActivationTime**Type:** character vector**Values:** update diagram | update diagram analyze all choices | code compile**Default:** update diagram**Port — Number of connected input port**

no default

Number of the input port that is connected to one Variant choice upstream of the Variant Source block. This value is read-only.

Click  to add a port or  to delete an existing one.

Variant control expression — Variant controls available in the global workspace

'Variant' (default) | boolean condition expression | Simulink.Variant object | Simulink.Parameter object | enum

Displays the Variant controls available in the global workspace. The Variant control can be a Boolean condition expression or a Simulink.Variant object representing a Boolean condition expression. If you want to generate code for your model, you must define the control variables as Simulink.Parameter objects.

To enter non-numeric Variant control values, use enumerated data. For information about using enumerated data, see “Use Enumerated Data in Simulink Models”

To edit a Variant name, double-click a **Variant control expression** cell and type in the Variant control expression. Click **Apply** after you edit a Variant control name. If you add or delete a Variant control without applying the changes, the previous edits on the Variant control name are lost.

The **Variant control** that evaluates to true determines which input port must be active.

Programmatic Use**Block Parameter:** VariantControls**Type:** cell array of character vectors**Value:** Variant control that is associated with the Variant choice**Default:** 'Variant'**Condition (read-only) — Condition for Variant controls**

no default

Displays the **Condition** for the Variant controls that are Simulink.Variant objects. Create or change a Variant condition in the Simulink.Variant parameter dialog box or in the global workspace.

For more information, see “Create Variant Controls Programmatically” and `Simulink.Variant`.

Label mode active choice — Name of Variant to use if Label control mode is selected

`Choice_1` (default) | name of Variant control

When you select the **Variant control mode** as `Label`, the **Label mode active choice** option is available. You can select an active Variant choice from **Label mode active choice** options. You can also right-click the badge on the Variant Source block and select **Label Mode Active Choice**.

The **Label mode active choice** drop-down list displays all Variant controls that are currently defined in the global workspace or a data dictionary. Use valid MATLAB identifiers to specify Variant controls. For more information, see `Simulink.Variant`.

Note **Label mode active choice** option is not available in Expression mode.

Dependencies

To enable this parameter, select `Label` mode.

Programmatic Use

Block Parameter: `LabelModeActivechoice`

Type: character vector

Value: Specified by the Variant control expression.

Default: `Choice_1`

Allow zero active variant controls — Simulate model without active Variant choice

`off` (default) | `on`

To simulate a model (containing a Variant block) without an active Variant choice, select the **Allow zero active variant controls** option. When this option is selected and there is no active Variant choice, Simulink disables all the blocks connected to the input and output stream of Variant Source block. The removed blocks are ignored from update diagram or simulation.

If you do not select this option, Simulink generates an error when there is no active Variant choice.

When you select this option, the Variant badge indicates the change.

Dependencies

Expression option from **Variant control mode** is selected.

Programmatic Use

Block Parameter: `AllowZeroVariantControls`

Type: character vector

Values: `'off'` | `'on'`

Default: `'off'`

Show variant condition on block — Annotate block ports

`off` (default) | `on`

When you select this option, Simulink annotates each Variant control (condition expression) on the Variant Source block ports.

Programmatic Use**Block Parameter:** ShowConditionOnBlock**Type:** character vector**Value:** 'off' | 'on'**Default:** 'off'**Block Characteristics**

| | |
|---------------------------------|--|
| Data Types | Boolean bus double enumerated fixed point half integer single string |
| Direct Feedthrough | no |
| Multidimensional Signals | no |
| Variable-Size Signals | no |
| Zero-Crossing Detection | no |

Extended Capabilities**C/C++ Code Generation**

Generate C and C++ code using Simulink® Coder™.

Fixed-Point Conversion

Design and simulate fixed-point systems using Fixed-Point Designer™.

See Also

Variant Sink | Simulink.Variant | Manual Variant Source | Manual Variant Sink | Variant Subsystem | Model

Topics

“Introduction to Variant Controls”

“Define, Configure, and Activate Variant Choices in a Variant Subsystem Block”

“Create Variant Controls Programmatically”

“Variant Systems” (Embedded Coder)

“Propagate Variant Conditions from Variant Source Blocks to Conditionally Executed Subsystems”

“Represent Variant Source and Sink Blocks in Generated Code” (Embedded Coder)

“Variants Example Models”

Introduced in R2016a

Variant Subsystem, Variant Model

Template subsystem containing Subsystem, Model, or Subsystem Reference blocks as Variant choices

Library: Simulink / Ports & Subsystems
HDL Coder / Ports & Subsystems

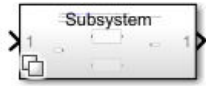

Description

The Variant Subsystem block enables you to include multiple implementations of a component in a separate hierarchy.

For example, suppose you want to simulate a model that represents a vehicle with three possible engine configurations: 4-cylinder gas, 6-cylinder gas, and 8-cylinder gas. You could implement each engine model as a separate subsystem inside the Variant Subsystem and then switch between the subsystems based on the “Variant control mode” on page 1-0 you select. For more information, see “Introduction to Variant Controls”.

Note Only one implementation of a Variant Subsystem is active during simulation.

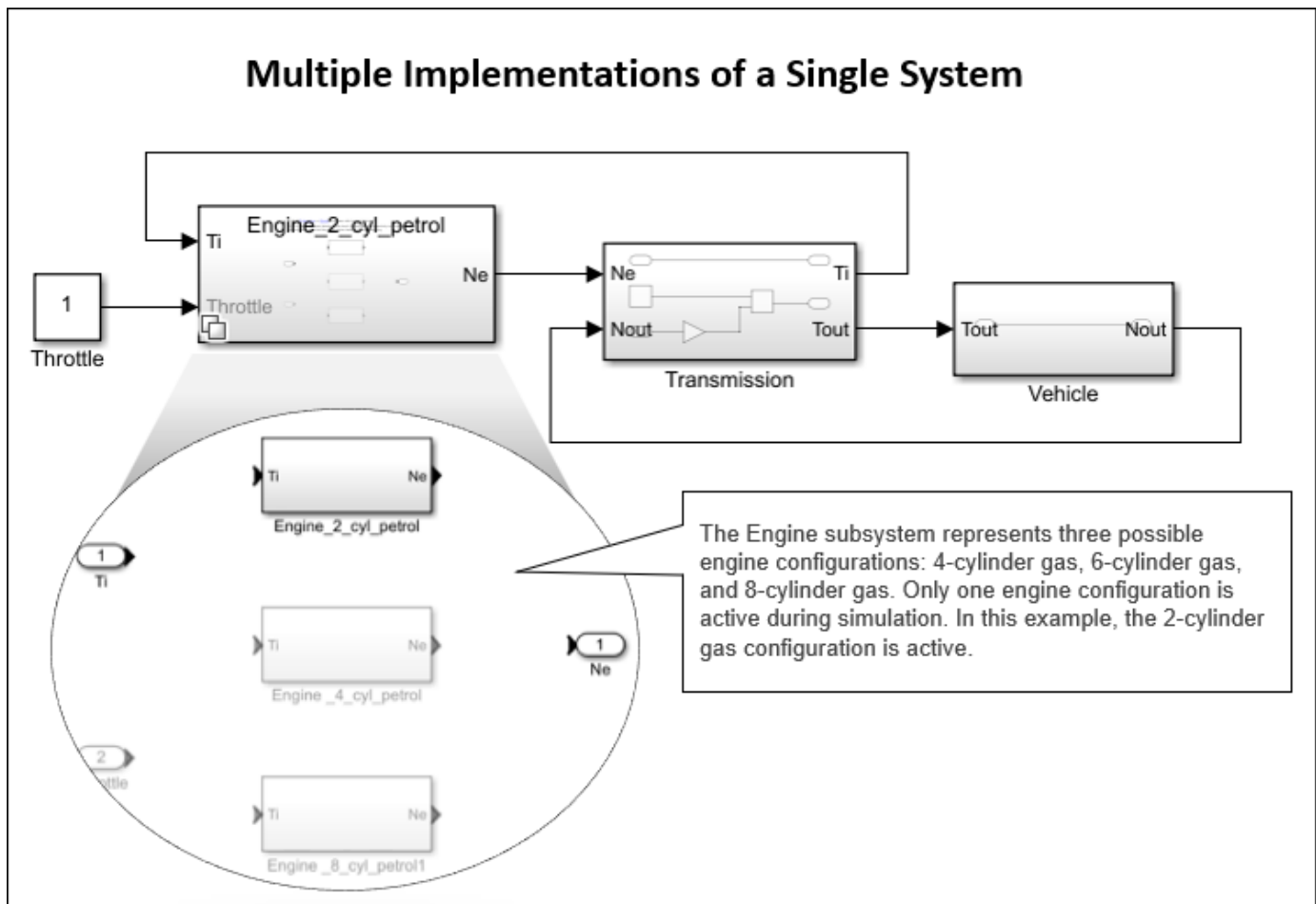

The Variant Subsystem block is a template preconfigured to contain two or more blocks to use as Variant choices. These choices represent multiple implementations of a system. Only one child block is active during model execution. The active child block is referred to as the active variant.

Each variant choice inside the Variant Subsystem block is associated with a “Variant control mode” on page 1-0 and a “Variant activation time” on page 1-0. The variant control mode determines which variant choice is active. The variant activation time determines a time to activate the choices and to decide whether to include only the active choice or both active and inactive choices in the generated code.

A Variant Subsystem block can contain a mixture of Subsystem blocks, Model blocks, or Subsystem Reference blocks as variant choices. A Variant Subsystem block with Model blocks as choices is called a Variant Model block. For more information on these blocks, see “Create Subsystems”, Model, and “Subsystem Reference”.

Apart from the variant choices, you can include Inport, Outport, and Connection Port (Simscape) blocks inside a Variant Subsystem block. There are no drawn connections between the blocks that are inside the Variant Subsystem blocks. Simulink automatically wires the active variant to the Inport and Outport blocks of the Variant Subsystem during model compilation. The blocks representing variant choices can have input and output ports that differ in number from the input and output ports in the parent Variant Subsystem block. For more information, “Mapping Inports and Outports of Variant Choices in a Variant Subsystem”.

Using Variant Subsystem block allows you to:

- Mix Subsystem, Model, and Subsystem Reference blocks as variant choices.
- Model components that do not have similar interface. You can have different numbers of inports and outports for multiple variant choices inside a Variant Subsystem.
- Establish a hierarchical block diagram, where the Variant Subsystem block is on one layer and the variant choices are on another layer.
- Keeps functionally related blocks together.
- Reduce the complexity of your model.

The color and icon of the variant badge on the block icon changes depending on the values of the **Variant activation time**, **Variant control mode**, and **Propagate conditions outside of variant subsystem** parameters set on the block. For more information, see “Variant Badges”.

Ports

During simulation, Simulink disables the inactive ports in a Variant Subsystem block.

Input

In_1 — Input port corresponding to root-level Inport blocks contained in Variant Subsystem
same data types accepted by Inport blocks

Each Subsystem, Model, or Subsystem Reference block contained within a Variant Subsystem represents one variant choice. The variant choices can have same set or a subset of inports as the Variant Subsystem container block.

Output

Out_1 — Output port corresponding to root-level Outport blocks contained in Variant Subsystem
same data types accepted by Outport blocks

Each Subsystem, Model, or Subsystem Reference block contained within a Variant Subsystem represents one variant choice. The variant choices can have same set or a subset of outports as the Variant Subsystem container block or it can be a subset of ports on the container block.

Note The unconnected outports (inactive outports) of a Variant Subsystem outputs a ground value. To output a value other than ground, select the **Specify output when source is unconnected** parameter of the Outport block and specify a value.

Parameters

Variant control mode — Variant control mode
expression (default) | label | sim codegen switching

The variant control that determines the active variant choice can be any of these types.

- **expression** — In expression mode, Simulink chooses the active variant based on the evaluation of the variant conditions. When a condition expression evaluates to `true`, the corresponding variant choice becomes active. When a condition expression evaluates to `false`,

the corresponding variant choice becomes inactive. See “Switch Between Choices Using Condition Expressions in Variant Blocks and Variant Parameters”.

- **label** — In **label** mode, Simulink chooses the active variant based on the name of the variant. The variant control is a string and does not require you to create variable in any workspaces. See “Switch Between Choices Using Labels in Variant Blocks”.
- **sim codegen switching** — To automatically switch between the variants for simulation and code generation workflows without creating any workspace variable, use **sim codegen switching** mode. When you simulate a model, Simulink automatically chooses the **sim** branch as the active choice. Similarly, when you do a Software-in-the-loop (SIL) or Processor-In-Loop (PIL) simulation, generate code, or use external mode, Simulink automatically chooses the **codegen** branch. See “Switch Between Choices For Simulation And Code Generation Workflows in Variant Blocks”.

For more information on variant control mode, see “Introduction to Variant Controls”. For comparison between different types of variant control mode, see “Compare Different Types of Variant Control Modes”.

Dependencies

The availability of different variant activation times depends on the type of the **Variant control mode** that you specify. The **Variant activation time** parameter determines the time when Simulink sets the active choice. The parameter also determines which variability to include in the generated code. This table explains the variant activation time supported by each variant control mode.

| Variant activation time | | | | |
|-------------------------|----------------|------------------------------------|--------------|---------|
| Variant control mode | update diagram | update diagram analyze all choices | code compile | startup |
| expression | ✓ | ✓ | ✓ | ✓ |
| label | ✓ | x | x | x |
| sim codegen switching | ✓ | ✓ | x | x |

Variant activation time — Time when Simulink chooses active variant choice

update diagram (default) | update diagram analyze all choices | code compile | startup

This parameter determines which variability to include in the simulation and code generation workflows. For more information, see “Activate Variant During Different Stages of Simulation and Code Generation Workflow”.

You can set the **Variant activation time** parameter as:

- **update diagram** — When you execute the model, only the active choice is included in the simulation and the code generation workflow. Generated code contains only the active choice.
- **update diagram analyze all choices** — When you execute the model, both active and inactive choices are analyzed for consistency across the model. However, only the active choice is included in the simulation and the code generation workflow. Generated code contains only the active choice.
- **code compile** — When you execute the model, both active and inactive choices are analyzed for consistency across the model, and all choices are included in the simulation and the code

generation workflow. Generated code contains both the active and inactive choices enclosed in the preprocessor conditionals `#if` and `#elif`. However, the executable built from the generated code contains only active choice.

- **startup** — When you execute the model, both active and inactive choices are analyzed for consistency across the model, and all choices are included in the simulation and the code generation workflow. With this option, you can improve the speed of iterative simulations using fast restart. For more information, see “How Fast Restart Improves Iterative Simulations”. Code generated from the model contains both the active and inactive choices that are enclosed in regular `if` conditions. The executable built from the generated code also contains both active and inactive choices.

Dependencies

The availability of different variant activation times depends on the type of the variant control mode that you specify. The **Variant activation time** parameter determines when Simulink sets the active choice. The parameter also determines which variability to include in the generated code. This table explains the variant activation time supported by each variant control mode.

| Variant activation time | | | | |
|-------------------------|----------------|------------------------------------|--------------|---------|
| Variant control mode | update diagram | update diagram analyze all choices | code compile | startup |
| expression | ✓ | ✓ | ✓ | ✓ |
| label | ✓ | x | x | x |
| sim codegen switching | ✓ | ✓ | x | x |

Programmatic Use

Block Parameter: VariantActivationTime

Type: character vector

Values: update diagram | update diagram analyze all choices | code compile | startup



Default: update diagram



Variant choices (table of variant systems) — Table of variant choices, variant controls, and conditions

empty table (default)

The table has a row for each variant choice contained in the Variant Subsystem. If there are no variant choices, the table is empty.

You can use buttons to the left of the **Variant choices** table to modify the elements in the table.

| To... | Click... |
|--|---|
| Create and add a new subsystem choice: Create a new Subsystem block as a variant choice and add an entry for the new choice in the table. |  |
| Create and add a new model variant choice: Create a new Model block as a variant choice and add an entry for the new choice in the table. |  |

| To... | Click... |
|--|---|
| Create/Edit selected variant object: Create or edit a Simulink.Variant object in the global workspace and specify the variant condition using the Simulink.Variant object parameter dialog box. |  |
| Open selected variant choice block: Open the Subsystem block for the selected row. |  |
| Refresh dialog information from Variant Subsystem contents: Update the Variant choices table according to the variant choices and values of the variant control in the global workspace. |  |

Name (read-only) – Variant choice name

Subsystemor Subsystem1 (default) | name of Subsystem or Model block contained in the Variant Subsystem

This read-only field displays the name of the blocks contained in the Variant Subsystem.

Variant control label – Name of choice in label mode

true or false (default) | string

A name for a choice, specified as a string.

Dependency

To enable this parameter, set **Variant control mode** to label.

Variant control expression – Condition expression that determines the active choice inside Variant Subsystem

true or false (default) | boolean condition expression | a Simulink.Variant object representing a boolean condition expression | (default)

Specify the condition expression to determine the active choice inside the Variant Subsystem. When a condition expression evaluates to true, Simulink activates the corresponding variant choice. When a condition expression evaluates to false, Simulink deactivates the corresponding variant choice.

The variant controls can be:

- Boolean condition expression for rapid prototyping. For example, $A + B$, $A == B$, $A \&\& B$, and so on.
- a Simulink.Variant object that contains a condition expression for condition reuse. See “Simulink.Variant Objects for Variant Condition Reuse in Variant Blocks”.
- “Default Variant Choice” if none of the choices evaluates to true.

Here, A and B are operands called as variant control variables. +, ==, and && are operators in the condition expression. The condition expression can contain one or more such variant control variables and operators. For information on supported types and storage location of variant control variables, see “Types of Variant Control Variables (Operands) in Variant Condition Expressions” and “Storage Locations for Variant Control Variables (Operands) in Variant Condition Expressions”. For information on operators, see “Operators in Variant Condition Expressions”.

For more information, see “Switch Between Choices Using Condition Expressions in Variant Blocks and Variant Parameters”.

Programmatic Use

Structure field: Represented by the read-only `variant.Name` field in the `Variant` parameter structure

Type: character vector

Value: variant control that is associated with the variant choice

Default: 'variant'

Condition (read-only) — Condition expression in Simulink.Variant object

N/A (default)

This read-only field displays the condition expression specified as `Simulink.Variant` object. To change or edit the condition expression, use the `Simulink.Variant` parameter dialog box that appears when you double-click the object in the workspace.

Note The operands that you specify in a condition expression of type `Simulink.Variant` must be defined in the base workspace or a data dictionary. Specifying operands that are defined in the mask or model workspace is not supported.

Label mode active choice — Name of active choice in label mode

`true(Subsystem)` (default) | `false(Subsystem1)`

This list contains the labels of all the choices inside the Variant Subsystem. To set an active choice, select a label from the list. The corresponding choice turns active. Alternatively, you can follow the approaches described in “Variant control mode” on page 1-0 to change the active choice in label mode.

Dependencies

To enable this parameter, set the **Variant control mode** parameter to `label`.

Programmatic Use

Parameter: `LabelModeActivechoice`

Type: character vector

Value: if no label mode active choice is specified, the value is empty. If label mode active choice is specified, the value is the name of the label mode active choice.

Default: ''

Allow zero active variant controls — Whether to allow zero active variant choices

`off` (default) | `on`

When you select this option and if there is no active variant choice, Simulink simulates the model without any active variant choice in the Variant Subsystem. Simulink disconnects all the blocks connected to the input and output stream of Variant Subsystem block, thus removing the variant regions completely from the model. The inactive outputs of the Subsystem output a ground value. To output a value other than ground, select the **Specify output when source is unconnected** parameter of the Outputport block and specify a value of your choice.

If you do not select this option, Simulink generates an error when there is no active variant choice.

Dependencies

This parameter is available only if there are no default variant choices in the Variant Subsystem and when if you set **Variant control mode** to `expression`.

Programmatic Use**Parameter:** AllowZeroVariantControls**Type:** character vector**Value:** 'off' | 'on'**Default:** 'off'**Propagate conditions outside of variant subsystem — Option to choose if components outside of the Variant Subsystem must be informed of the active and inactive state of underlying blocks**

off (default) | on

When you select the **Propagate conditions outside of variant subsystem** parameter, Simulink propagates the variant condition of the underlying blocks to the Variant Subsystem container block so the subsystem can adapt its interface to the state of the underlying blocks. Ports that are mapped to the ports on the active choice becomes active. Ports that are not mapped to the ports on the inactive choice becomes inactive. Selecting this option ensures that the components outside of the Variant Subsystem are aware of the active and inactive state of blocks within the Variant Subsystem block. For more information, see “Adaptive Interface for Variant Subsystems”.

The propagation of variant conditions outside of Variant Subsystem may improve the accuracy of the model and may simplify model construction because you are not required to manually compute the variant condition to assign to dependent blocks. For more information, see “Propagate Variant Conditions Outside a Variant Subsystem Block” and “Use Variant Subsystem Blocks with Conditionally Executed Subsystems”

Programmatic Use**Parameter:** PropagateVariantConditions**Type:** character vector**Value:** 'off' | 'on'**Default:** 'off'**Block Characteristics**

| | |
|---------------------------------|---|
| Data Types | Boolean ^a bus ^a double ^a enumerated ^a fixed point ^a half ^a integer ^a single ^a string ^a |
| Direct Feedthrough | no |
| Multidimensional Signals | limited ^a |
| Variable-Size Signals | limited ^a |
| Zero-Crossing Detection | no |

a. Actual data type or capability support depends on block implementation.

Extended Capabilities**C/C++ Code Generation**

Generate C and C++ code using Simulink® Coder™.

Actual data type or capability support depends on block implementation.

HDL Code Generation

Generate Verilog and VHDL code for FPGA and ASIC designs using HDL Coder™.

HDL Coder provides additional configuration options that affect HDL implementation and synthesized logic. Actual data type or capability support depends on block implementation.

HDL Architecture

| Architecture | Description |
|------------------|--|
| Module (default) | Generate code for the subsystem and the blocks within the subsystem. HDL Coder generates code for only the active variant. |
| BlackBox | Generate a black-box interface. That is, the generated HDL code includes only the input/output port definitions for the subsystem. In this way, you can use a subsystem in your model to generate an interface to existing manually written HDL code. The black-box interface generated for subsystems is similar to the interface generated for Model blocks, but without generation of clock signals. |
| No HDL | Remove the subsystem from the generated code. You can use the subsystem in simulation but treat it as a “no-op” in the HDL code. |

Black Box Interface Customization

For the BlackBox architecture, you can customize port names and set attributes of the external component interface. See “Customize Black Box or HDL Cosimulation Interface” (HDL Coder).

HDL Block Properties

| General | |
|----------------------------------|--|
| AdaptivePipelining | Automatic pipeline insertion based on the synthesis tool, target frequency, and multiplier word-lengths. The default is <code>inherit</code> . See also “AdaptivePipelining” (HDL Coder). |
| BalanceDelays | Detects introduction of new delays along one path and inserts matching delays on the other paths. The default is <code>inherit</code> . See also “BalanceDelays” (HDL Coder). |
| ClockRatePipelining | Insert pipeline registers at a faster clock rate instead of the slower data rate. The default is <code>inherit</code> . See also “ClockRatePipelining” (HDL Coder). |
| ConstrainedOutputPipeline | Number of registers to place at the outputs by moving existing delays within your design. Distributed pipelining does not redistribute these registers. The default is 0. For more details, see “ConstrainedOutputPipeline” (HDL Coder). |
| DistributedPipelining | Pipeline register distribution, or register retiming. The default is <code>off</code> . See also “DistributedPipelining” (HDL Coder). |
| DSPStyle | Synthesis attributes for multiplier mapping. The default is <code>none</code> . See also “DSPStyle” (HDL Coder). |
| FlattenHierarchy | Remove subsystem hierarchy from generated HDL code. The default is <code>inherit</code> . See also “FlattenHierarchy” (HDL Coder). |
| InputPipeline | Number of input pipeline stages to insert in the generated code. Distributed pipelining and constrained output pipelining can move these registers. The default is 0. For more details, see “InputPipeline” (HDL Coder). |

| General | |
|------------------------|--|
| OutputPipeline | Number of output pipeline stages to insert in the generated code. Distributed pipelining and constrained output pipelining can move these registers. The default is 0. For more details, see “OutputPipeline” (HDL Coder). |
| SharingFactor | Number of functionally equivalent resources to map to a single shared resource. The default is 0. See also “Resource Sharing” (HDL Coder). |
| StreamingFactor | Number of parallel data paths, or vectors, that are time multiplexed to transform into serial, scalar data paths. The default is 0, which implements fully parallel data paths. See also “Streaming” (HDL Coder). |

Target Specification

This block cannot be the DUT, so the block property settings in the **Target Specification** tab are ignored.

Restrictions

- The DUT cannot be a Variant Subsystem.

Fixed-Point Conversion

Design and simulate fixed-point systems using Fixed-Point Designer™.

Actual data type or capability support depends on block implementation.

See Also

“Define, Configure, and Activate Variant Choices in a Variant Subsystem Block” | “Working with Variant Choices”

Introduced in R2010b

Vector Concatenate, Matrix Concatenate

Concatenate input signals of same data type to create contiguous output signal

Library: Simulink / Commonly Used Blocks
 Simulink / Math Operations
 Simulink / Signal Routing
 HDL Coder / Math Operations
 HDL Coder / Signal Routing



Description

The Vector Concatenate and Matrix Concatenate blocks concatenate the input signals to create a nonvirtual output signal whose elements reside in contiguous locations in memory.

In the Simulink library, these blocks are different configurations of the same block. They differ based on the setting of their **Mode** parameter, which determines whether the block operates in vector or multidimensional array concatenation mode. The input signal requirements and output signal depend on the mode of concatenation.

| Block | Mode Setting | Input Signal Requirements | Output Signal |
|--------------------|--------------|---|---|
| Vector Concatenate | Vector | <ul style="list-style-type: none"> Vectors Row vectors (1-by-M matrices) Column vectors (M-by-1 matrices) Combination of vectors and either row or column vectors | <p>When all inputs are vectors, the output is a vector.</p> <p>If any of the inputs are row or column vectors, the output is a row or column vector, respectively.</p> <hr/> <p>Tip To create a vector of function calls, use a Mux block.</p> |

| Block | Mode Setting | Input Signal Requirements | Output Signal |
|--------------------|------------------------|--|--|
| Matrix Concatenate | Multidimensional array | Signals of any dimensionality (scalars, vectors, and matrices) | <p>The output is always an array.</p> <p>Trailing dimensions are assumed to be 1 for lower dimensionality inputs. For example, if the output is 4-D and the input is [2×3] (2-D), this block treats the input as [2×3×1×1].</p> <p>Concatenation is on the dimension that you specify with the Concatenate dimension parameter.</p> |

The signals in the output signal appear in the same order as the input signals for the block. For a description of the port order for various block orientations, see “Port Location After Rotating or Flipping”.

You can use multiple Vector Concatenate or Matrix Concatenate blocks to create the output signal in stages, but the result is flat, as if you used a single block to concatenate the signals.

You must use a Vector Concatenate or Matrix Concatenate block to define an array of buses. For more information, see “Group Nonvirtual Buses in Arrays of Buses”.

Ports

Input

Port_1 — First input to concatenate

scalar | vector | matrix | *N*-D array

First input to concatenate, specified as a scalar, vector, matrix, or *N*-D array.

- Inputs must be of the same data type.
- Matrix and *N*-D array inputs are supported only when you set **Mode** to Multidimensional array.

Data Types: single | double | half | int8 | int16 | int32 | int64 | uint8 | uint16 | uint32 | uint64 | Boolean | fixed point | enumerated | bus

Port_N — *N*th input to concatenate

scalar | vector | matrix | *N*-D array

*N*th input to concatenate, specified as a scalar, vector, matrix, or *N*-D array.

- Inputs must be of the same data type.
- Matrix and *N*-D array inputs are supported only when you set **Mode** to Multidimensional array.

Dependencies

To enable this port, set **Number of inputs** to an integer greater than or equal to 2.

Data Types: `single` | `double` | `half` | `int8` | `int16` | `int32` | `int64` | `uint8` | `uint16` | `uint32` | `uint64` | `Boolean` | `fixed point` | `enumerated` | `bus`

Output

Port_1 — Concatenation of input signals

`scalar` | `vector` | `matrix` | `N-D array`

Concatenation of input signals along specified dimension. Outputs have the same data type as the input.

Data Types: `single` | `double` | `half` | `int8` | `int16` | `int32` | `int64` | `uint8` | `uint16` | `uint32` | `uint64` | `Boolean` | `fixed point` | `enumerated` | `bus`

Parameters

Number of inputs — Number of input ports

2 (default) | positive integer

Specify the number of inputs for the block as a real-valued, positive integer, less than or equal to 65536.

Programmatic Use

Block Parameter: `NumInputs`

Type: character vector

Values: positive integer

Default: '2'

Mode — Type of concatenation

`Vector` | `Multidimensional array`

Select the type of concatenation that this block performs. The default **Mode** of the Vector Concatenate block is `Vector`. The default **Mode** of the Matrix Concatenate block is `Multidimensional array`.

- When you select `Vector`, the block performs vector concatenation.
- When you select `Multidimensional array`, the block performs matrix concatenation.

| Mode Setting | Input Signals | Output |
|---------------------|---|--|
| <code>Vector</code> | <ul style="list-style-type: none"> • Vectors • Row vectors (1-by-M matrices) • Column vectors (M-by-1 matrices) • Combination of vectors and either row or column vectors | <p>When all inputs are vectors, the output is a vector.</p> <p>If any of the inputs are row or column vectors, the output is a row or column vector, respectively.</p> |

| Mode Setting | Input Signals | Output |
|------------------------|--|--|
| Multidimensional array | Signals of any dimensionality (scalars, vectors, and matrices) | <p>The output is always an array.</p> <p>Trailing dimensions are assumed to be 1 for lower dimensionality inputs. For example, if the output is 4-D and the input is [2x3] (2-D), this block treats the input as [2x3x1x1].</p> <p>Concatenation is on the dimension that you specify with the Concatenate dimension parameter.</p> |

Programmatic Use**Block Parameter:** Mode**Type:** character vector**Values:** 'Vector' | 'Multidimensional array'**Default:** 'Vector'**Concatenate dimension — Output dimension along which to concatenate input arrays**

1 (default) | scalar integer

Specify the output dimension along which to concatenate the input arrays.

- To concatenate input arrays vertically, enter 1.
- To concatenate input arrays horizontally, enter 2.
- To perform multidimensional concatenation on the inputs, specify an integer greater than 2.

If this parameter is set to 1 and the block inputs are 2-D matrices, the block performs vertical matrix concatenation and stacks the input matrices on top of each other to create the output matrix. For example, see the `ex_concatenate_vertical` model.

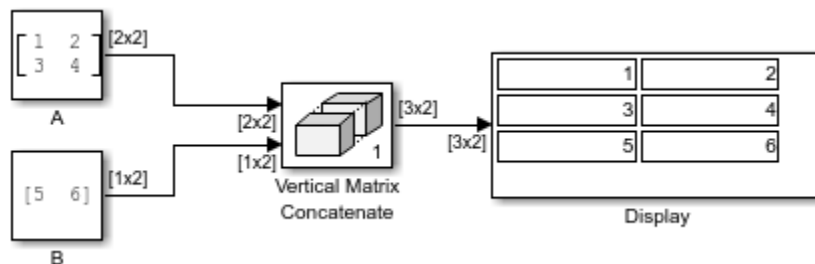

If you set this parameter to 2 and the block inputs are 2-D matrices, the block performs horizontal matrix concatenation and places the input matrices side by side to create the output matrix. For example, see the `ex_concatenate_horizontal` model.

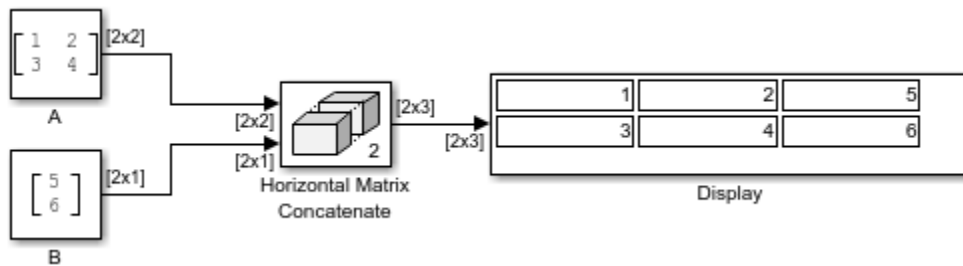

The input matrices must have compatible sizes for concatenation. Vertical concatenation requires the input matrices to have the same number of columns. Horizontal concatenation requires input matrices to have the same number of rows.

If you set this parameter to 3 and the block inputs are 2-D matrices, the block performs multidimensional matrix concatenation. For example, see the `ex_concatenate_multidims` model

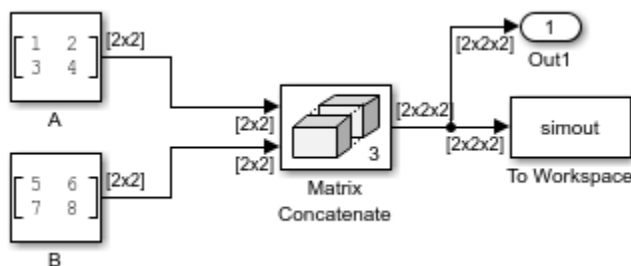

Dependencies

To enable this parameter, set **Mode** to Multidimensional array.

Programmatic Use

Block Parameter: ConcatenatedDimension

Type: character vector

Values: scalar integer

Default: '1'

Block Characteristics

| | |
|---------------------------------|---|
| Data Types | Boolean double enumerated fixed point half integer single |
| Direct Feedthrough | yes |
| Multidimensional Signals | no |
| Variable-Size Signals | yes |
| Zero-Crossing Detection | no |

Extended Capabilities

C/C++ Code Generation

Generate C and C++ code using Simulink® Coder™.

HDL Code Generation

Generate Verilog and VHDL code for FPGA and ASIC designs using HDL Coder™.

HDL Coder provides additional configuration options that affect HDL implementation and synthesized logic.

HDL Architecture

This block has a single, default HDL architecture.

HDL Block Properties

| | |
|----------------------------------|--|
| ConstrainedOutputPipeline | Number of registers to place at the outputs by moving existing delays within your design. Distributed pipelining does not redistribute these registers. The default is 0. For more details, see “ConstrainedOutputPipeline” (HDL Coder). |
| InputPipeline | Number of input pipeline stages to insert in the generated code. Distributed pipelining and constrained output pipelining can move these registers. The default is 0. For more details, see “InputPipeline” (HDL Coder). |
| OutputPipeline | Number of output pipeline stages to insert in the generated code. Distributed pipelining and constrained output pipelining can move these registers. The default is 0. For more details, see “OutputPipeline” (HDL Coder). |

Complex Data Support

This block supports code generation for complex signals.

FOR-GENERATE Loop Support

For this block, HDL Coder generates code using FOR-GENERATE loop when you set the target language to VHDL. For more information, see “Unroll For-Generate Loops in VHDL code” (HDL Coder)

PLC Code Generation

Generate Structured Text code using Simulink® PLC Coder™.

Fixed-Point Conversion

Design and simulate fixed-point systems using Fixed-Point Designer™.

See Also**Functions**

cat

Blocks

Mux | Selector

Topics

“Group Nonvirtual Buses in Arrays of Buses”

“Creating, Concatenating, and Expanding Matrices”

Introduced in R2009b

Vertical Gauge

Display signal value during simulation on vertical gauge with customizable appearance

Library: Simulink / Dashboard / Customizable Blocks



Description

The Vertical Gauge block displays the value of the connected signal on a linear gauge that you can customize to look like a gauge in a real system.

The Vertical Gauge block displays instantaneous value of the connected signal throughout simulation. You can modify the range and tick values on the Vertical Gauge block to fit your data. Use the Vertical Gauge block with other dashboard blocks to build an interactive dashboard of controls and indicators for your model.

Customize Vertical Gauge Blocks

When you add a Vertical Gauge block to your model, the block is preconfigured with a default design. You can use the block with the default design, or you can customize the appearance of the block using design mode. You can enter design mode in one of three ways after selecting the block:

- On the **Gauge** tab, under **Design**, click **Edit**.
- In the **Property Inspector**, on the **Design** tab, click **Edit**.
- Pause on the ellipsis that appears above the block and click the **Edit Custom Block** button.

In design mode, you have access to block parameters and settings that allow you to design the appearance of the block. You can use the toolbar above the block to change the background image or needle image and to set the opacity and color for the scale, tick labels, and value bar. To design the appearance of the scale, select the aspect of the scale you want to edit in the middle section of the toolbar. Use the controls on the right of the toolbar to set the color and opacity. You can also click and drag to reposition the needle or the scale.

For fine control of the block design, use the **Design** tab in the **Property Inspector**. You can use the **Property Inspector** to enter exact values for design settings. The **Design** tab also includes design parameters that are not available through the toolbar or interactive editing, such as the ability to add a foreground image to the block.

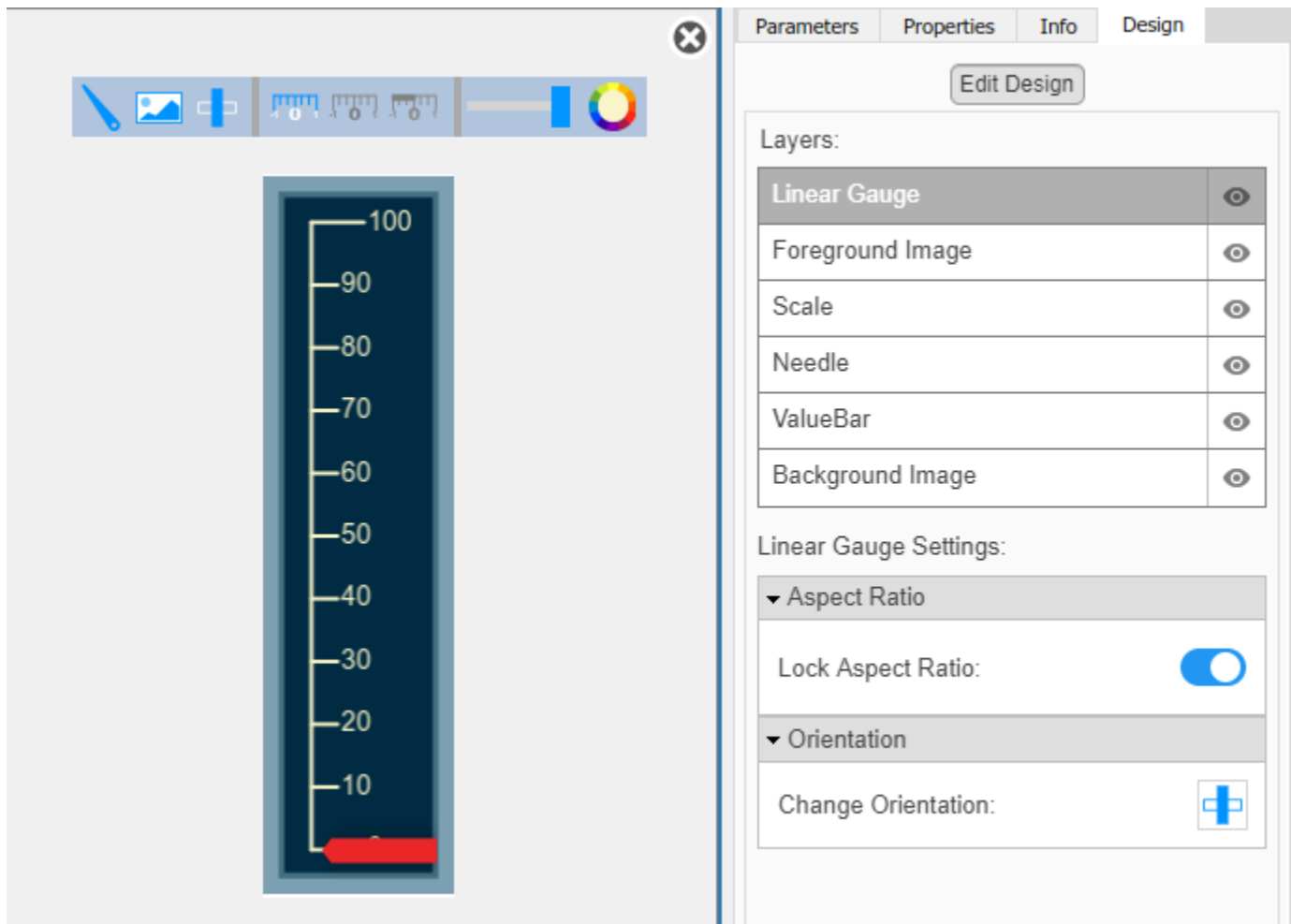

When you finish editing the gauge, click **Exit** in the upper-right of the canvas to exit design mode.

Connect Dashboard Blocks

Dashboard blocks do not use ports to connect to model elements. To connect dashboard blocks to signals in your model, use connect mode. Connect mode facilitates the process of connecting dashboard blocks in your model, especially when you want to connect multiple blocks at once. To connect a single dashboard block, you can also use the **Connection** table in the block dialog box.

Tip You can modify dashboard block connections during normal and accelerator mode simulations.

To enter connect mode, select a dashboard block to connect. Then, on the block tab, click **Connect**. In connect mode, when you select one or more signals or blocks, a list of signals that are available for connection appears. Select a signal from the list to connect to the selected dashboard block. To connect another dashboard block, pause on the block you want to connect and click the **Connect** button above it. Then, select one or more signals and blocks in the model and choose a signal to connect.

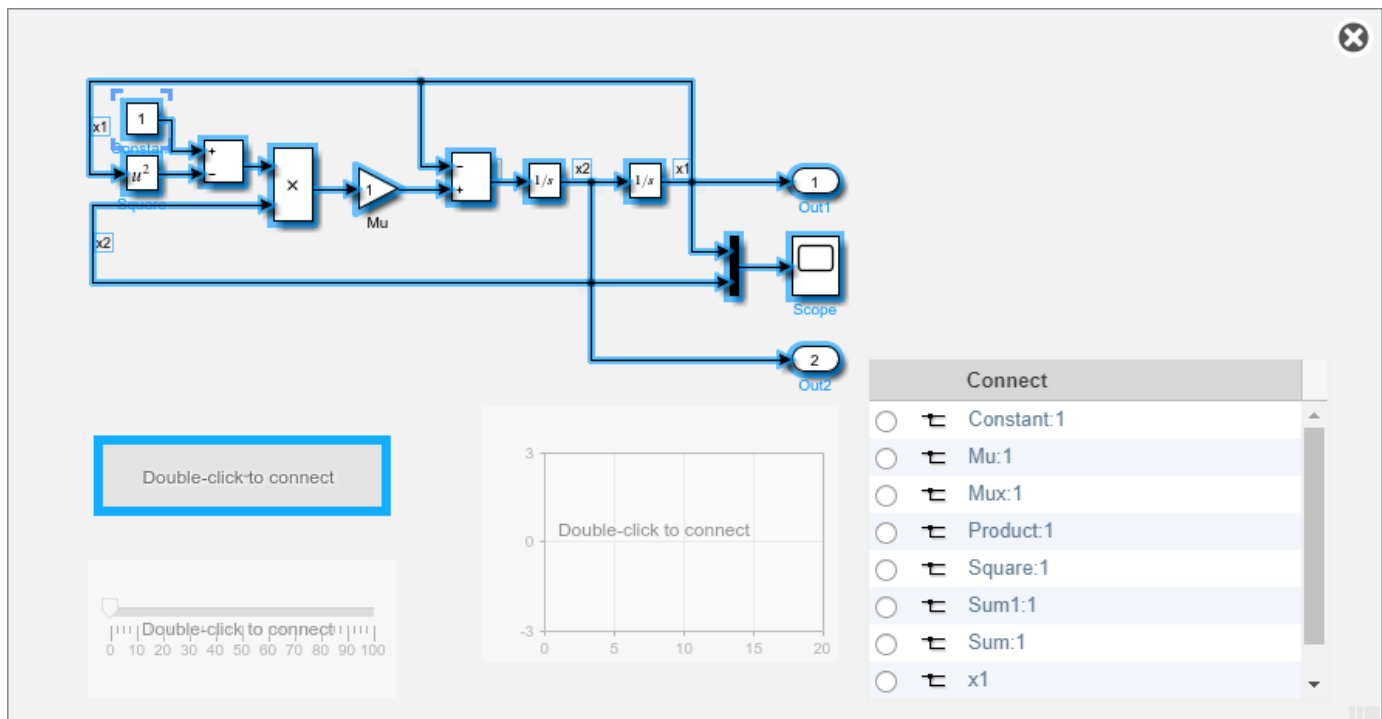

When you finish connecting the dashboard blocks in your model, on the block tab, click **Done Connecting**.

Tip You can hide the message shown on unconnected blocks using the `set_param` function with the `ShowInitialText` block parameter. The message also disappears when you connect the block.

Limitations

- Except for the Dashboard Scope block and the Display block, dashboard blocks can only connect to real scalar signals.
- The toolstrip does not support blocks that are inside a panel.
- You cannot use the **Connection** table in the block dialog to connect a dashboard block to a block that is commented out. When you connect a dashboard block to a commented block using connect mode, the dashboard block does not display the connected value until the you uncomment the block.
- Dashboard blocks cannot connect to model elements inside referenced models.
- When you simulate a model hierarchy, dashboard blocks inside referenced models do not update.
- Dashboard blocks do not support rapid accelerator simulation.
- You cannot connect a dashboard block to data or activity in Stateflow during simulation.
- Some signals do not have data available during simulation due to block reduction or optimization for accelerator mode simulations. To view such a signal using a dashboard block, mark the signal for logging.

Parameters

Connection — Signal to connect and display

signal connection options

Use the connection table to select the signal to connect to the block. To connect the block to a signal:

- 1 Make a selection in the model that includes one or more signals.
- 2 In the table, select the signal you want to connect.
- 3 Click **Apply**.

Tip You can connect dashboard blocks to signals in the model during simulation.

Programmatic Use

Block Parameter: Binding

Type: Simulink.HMI.SignalSpecification

Default: []

Minimum — Minimum tick mark value

0 (default) | scalar

Finite, real, double, scalar value specifying the minimum tick mark value for the scale. The minimum must be less than the value of the **Maximum** parameter.

Programmatic Use

To programmatically set the Minimum parameter, use a 1-by-3 vector containing values for the Minimum, Tick Interval, and Maximum parameters, in that order. To use the **auto** value for the Tick Interval, leave the Tick Interval position in the vector empty or specify -1.

Block Parameter: Limits

Type: 1x3 vector

Default: [0 -1 100]

Maximum — Maximum tick mark value

100 (default) | scalar

Finite, real, double, scalar value specifying the maximum tick mark value for the scale. The maximum must be greater than the value of the **Minimum** parameter.

Programmatic Use

To programmatically set the Maximum parameter, use a 1-by-3 vector containing values for the Minimum, Tick Interval, and Maximum parameters, in that order. To use the **auto** value for the Tick Interval, leave the Tick Interval position in the vector empty or specify -1.

Block Parameter: Limits

Type: 1x3 vector

Default: [0 -1 100]

Tick Interval — Interval between major tick marks

auto (default) | scalar

Finite, real, positive, whole, scalar value specifying the interval of major tick marks on the scale. When set to `auto`, the block automatically adjusts the tick interval based on the values of the **Maximum** and **Minimum** parameters.

Programmatic Use

To programmatically set the `Tick Interval` parameter, use a 1-by-3 vector containing values for the `Minimum`, `Tick Interval`, and `Maximum` parameters, in that order. To use the `auto` value for the `Tick Interval`, leave the `Tick Interval` position in the vector empty or specify `-1`.

Block Parameter: Limits

Type: 1x3 vector

Default: [0 -1 100]

Scale Colors — Color indications on gauge scale

colors for scale ranges

Color specifications for value ranges on the scale. Press the **+** button to add a scale color. For each color added, specify the minimum and maximum values of the range in which you want to display that color.

Programmatic Use

To programmatically specify the `Scale Colors` parameter, use an array of structures with the fields:

- `Min` — Minimum value for the color range on the scale
- `Max` — Maximum value for the color range on the scale
- `Color` — 1-by-3 vector of double values between 0 and 1 that specify the color for the range in the form [r g b]

Include a structure in the array for each scale range for which you want to specify a color.

```
range1.Min = 0;
range1.Max = 10;
range1.Color = [0 0 1];
range2.Min = 10;
range2.Max = 15;
range2.Color = [0 1 0];
scaleRanges = [range1 range2];
```

Block Parameter: ScaleColors

Type: structure array

Default: 0x1 struct array

Lock Aspect Ratio — Whether to maintain block aspect ratio

on (default) | off

Whether to maintain the block aspect ratio when resizing the block and when you specify a new background image.

Label — Block label position

Top (default) | Bottom | Hide

Position of the block label. When the block is connected to an element in the model, the label is the name of the connected element.

Programmatic Use**Block Parameter:** LabelPosition**Type:** character vector**Values:** 'Top' | 'Bottom' | 'Hide'**Default:** 'Top'**Opacity — Block background opacity**

1 (default) | scalar

Block background opacity, specified as a scalar value between 0 and 1. Specify the background opacity using the **Design** tab in the Property Inspector.

- 1 On the **Design** tab, click **Edit Design**.
- 2 Select the **Background** component.
- 3 In the **Background Color** section, specify the desired opacity.

Example: 0.5

Programmatic Use**Block Parameter:** Opacity**Type:** scalar**Default:** 1**Foreground Color — Block foreground color**

[r g b] vector

Block foreground color, excluding the text. The **Foreground Color** applies to the scale and the block name. To specify the color for the block text, use the **Font Color**.

Specify the **Foreground Color** for the block using the **Design** tab in the Property Inspector.

- 1 On the **Design** tab, click **Edit Design**.
- 2 Select the **Scale** component.
- 3 In the **Ticks** section, open the **Color** menu. You can choose from the palette of standard colors or specify a custom color.

Programmatic Use

Specify the `ForegroundColor` parameter for the block as a 1-by-3 [r g b] vector with values between 0 and 1.

Block Parameter: ForegroundColor**Type:** [r g b] vector**Background Color — Block background color**

[r g b] vector

Block background color. You can choose to select a solid background color instead of providing a background image. To design a block that uses a solid background, use the **Design** tab in the Property Inspector.

- 1 On the **Design** tab, click **Edit Design**.
- 2 Select the **Background** component.
- 3 Select **Use background color**.

- 4 Choose a background color from the palette of standard colors or specify a custom color.
- 5 Adjust the **Offset from scale** option until the solid background is the desired size.

Changing the background color using the toolbar removes the background image and enables the **Use background color** option.

Programmatic Use

Specify the `BackgroundColor` parameter for the block as a 1-by-3 [r g b] vector with values between 0 and 1.

Block Parameter: `BackgroundColor`

Type: [r g b] vector

Font Color — Block font color

[r g b] vector

Block font color. The **Font Color** applies to the scale labels. To specify the color of the scale, use the **Foreground Color**.

Specify the **Font Color** for the block using the **Design** tab in the Property Inspector.

- 1 On the **Design** tab, click **Edit Design**.
- 2 Select the **Scale** component.
- 3 In the **Labels** section, open the **Color** menu. You can choose from the palette of standard colors or specify a custom color.

Block Characteristics

| | |
|---------------------------------|---|
| Data Types | Boolean double enumerated fixed point half integer single |
| Direct Feedthrough | no |
| Multidimensional Signals | no |
| Variable-Size Signals | no |
| Zero-Crossing Detection | no |

Extended Capabilities

C/C++ Code Generation

Generate C and C++ code using Simulink® Coder™.

Dashboard blocks are ignored for code generation.

See Also

Circular Gauge | Horizontal Gauge | Linear Gauge

Topics

“Tune and Visualize Your Model with Dashboard Blocks”

“Simulation Pacing”

Introduced in R2020a

Vertical Slider

Change parameter or variable value using vertical slider with customizable appearance

Library: Simulink / Dashboard / Customizable Blocks



Description

Use the Vertical Slider block to tune the value of a variable or block parameter during simulation. You can customize the appearance of the Vertical Slider block to look like a control in a real system. You can adjust the scale range and tick values to fit the desired range for the value you want to tune. Use the Vertical Slider block with other dashboard blocks to create an interactive dashboard to control your model.

Customize Vertical Slider Blocks

When you add a Vertical Slider block to your model, the block is preconfigured with a default design. You can use the block with the default design or customize the appearance of the block using design mode. You can enter design mode in one of three ways after selecting the block:

- On the **Slider** tab, under **Design**, click **Edit**.
- In the **Property Inspector**, on the **Design** tab, click **Edit Design**.
- Pause on the ellipsis that appears above the block and click the **Edit Custom Block** button.

In design mode, you have access to block parameters and settings that allow you to design the appearance of the block. You can use the toolbar above the block to change the background image or needle image and to set the opacity and color for the scale, tick labels, and value bar. To design the appearance of the scale, select the aspect of the scale you want to edit in the middle section of the toolbar. Use the controls on the right of the toolbar to set the color and opacity. You can also click and drag to reposition the needle or the scale.

For fine control of the block design, use the **Design** tab in the **Property Inspector**. You can use the **Property Inspector** to enter exact values for design settings. The **Design** tab also includes design parameters that are not available through the toolbar or interactive editing, such as the ability to add a foreground image to the block.

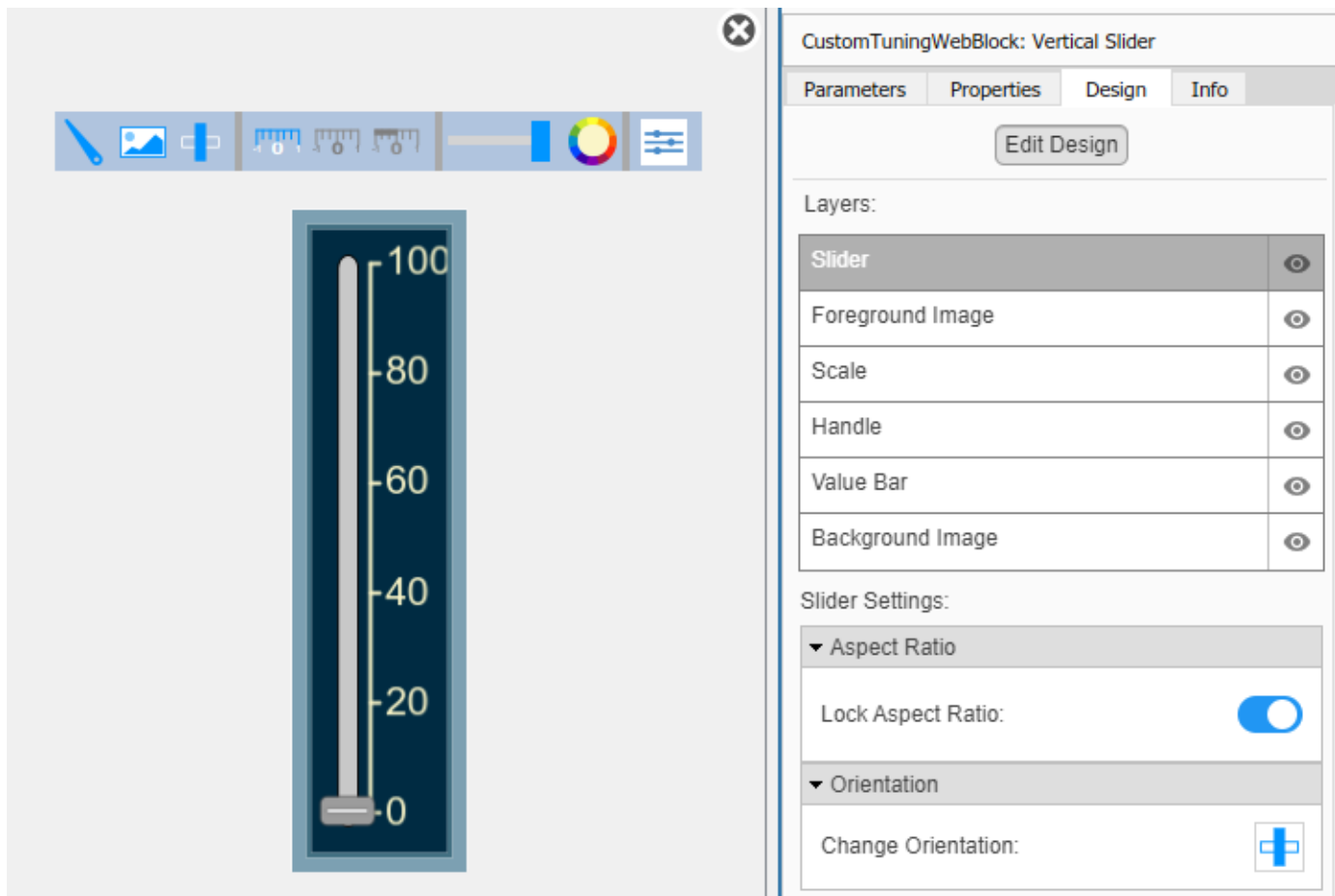

When you finish editing the design, click **Exit** in the upper-right of the canvas to exit design mode.

Connect Dashboard Blocks

Dashboard blocks do not use ports to connect to model elements. To connect dashboard blocks to variables and block parameters, use connect mode. Connect mode facilitates the process of connecting dashboard blocks in your model, especially when you want to connect multiple blocks at once. To connect a single dashboard block, you can also use the **Connection** table in the block dialog box.

Tip You can modify dashboard block connections in your model during normal and accelerator mode simulations.

Note Dashboard blocks cannot connect to variables until you update the model diagram. To connect dashboard blocks to variables or modify variable values between opening your model and running a simulation, update the model diagram using **Ctrl+D**.

To enter connect mode, select the block. Then, on the block tab, click **Connect**. In connect mode, when you select one or more blocks, a list of parameters and variables available for connection appears. Select a variable or parameter from the list to connect to the selected dashboard block.

When the value of the selected variable or block parameter is nonscalar, use the text box at the bottom of the **Connection** table to specify the element you want to connect to the dashboard block. To connect to an element of a vector, matrix, or array, specify the element index, for example, 3 or (1,3). To connect to an element in a bus or structure, specify the element in the context of the bus or structure hierarchy by using dots to indicate different levels in the hierarchy, and omit the top level. For example, specify a.b to connect to scalar element b of the structure or bus a nested inside the selected composite variable or parameter.

To connect another dashboard block, pause on another dashboard block and click the **Connect** button above it. Then, make a selection of signals and blocks in your model and choose a model element to connect.

The screenshot displays the Simulink dashboard connection interface. The main workspace shows a control system model with various blocks including gain blocks, summing junctions, product blocks, and integrators. A 'Connect' panel on the right lists available elements for connection, such as 'Constant: Value', 'Mu: Gain', 'Out1: InitialOutput', 'Out2: InitialOutput', 'Scope: ActiveDisplayString', 'Scope: ActiveDisplayYMaximum', 'Scope: ActiveDisplayYMinimum', and 'Scope: AxesScalingNumUpdates'. A 'Double-click to connect' tooltip is visible over a slider block in the bottom left.

When you finish connecting the dashboard blocks in your model, on the block tab, click **Done Connecting**.

Tip You can hide the message shown on unconnected blocks using the `set_param` function with the `ShowInitialText` block parameter. The message also disappears when you connect the block.

Parameter Logging

Tunable parameters connected to dashboard blocks are logged to the Simulation Data Inspector, where you can view the parameter values along with logged signal data. You can access logged parameter data in the MATLAB workspace by exporting the parameter data from the Simulation Data Inspector by using the UI or the `Simulink.sdi.exportRun` function. For more information about exporting data using the Simulation Data Inspector UI, see “Export Data to the Workspace or a File”. The parameter data is stored in a `Simulink.SimulationData.Parameter` object, accessible as an element in the exported `Simulink.SimulationData.Dataset`.

Limitations

- Except for the Dashboard Scope block and the Display block, dashboard blocks can only connect to real scalar signals.
- The toolstrip does not support blocks that are inside a panel.
- You cannot use the **Connection** table in the block dialog to connect a dashboard block to a block that is commented out. When you connect a dashboard block to a commented block using connect mode, the dashboard block does not display the connected value until the you uncomment the block.
- Dashboard blocks cannot connect to model elements inside referenced models.
- When you simulate a model hierarchy, dashboard blocks inside referenced models do not update.
- Dashboard blocks do not support rapid accelerator simulation.
- When you connect a dashboard block to a variable or parameter during simulation, the data for that variable or parameter is not logged to the Simulation Data Inspector. To log variable and parameter data to the Simulation Data Inspector, connect the dashboard block to the variable or parameter prior to simulation.
- When you simulate a model in external mode with the **Default parameter behavior** set to **Inlined**, dashboard blocks can appear to change parameter and variable values. However, the change does not propagate to the simulation. For example, Gain blocks display changes made to the **Gain** parameter using the dashboard blocks, but the **Gain** value used in the simulation does not change.

Parameters

Connection — Select a variable or block parameter to connect

variable and parameter connection options

Select the variable or block parameter to control using the **Connection** table. To connect the block to a signal:

- 1 Make a selection in the model that includes one or more blocks.
- 2 Select the variable or parameter you want to connect.

When the value of the selected variable or block parameter is nonscalar, use the text box at the bottom of the **Connection** table to specify the element you want to connect to the dashboard block. To connect to an element of a vector, matrix, or array, specify the element index, for example, 3 or (1,3). To connect to an element in a bus or structure, specify the element in the context of the bus or structure hierarchy by using dots to indicate different levels in the hierarchy, and omit the top level. For example, specify a.b to connect to scalar element b of the structure or bus a nested inside the selected composite variable or parameter.

- 3 Click **Apply**.

To facilitate understanding and debugging your model, you can connect Dashboard blocks to variables and parameters in your model during simulation.

Note To see workspace variables in the connection table, update the model diagram using **Ctrl+D**.

Programmatic Use

To programmatically connect a dashboard block to a tunable parameter or a variable, use a `Simulink.HMI.ParamSourceInfo` object. The `Simulink.HMI.ParamSourceInfo` object contains four properties. Some of the properties apply to connecting dashboard blocks to parameters, and some apply to connecting dashboard blocks to variables. Not all fields have a value for a connection because a given dashboard block connects to either a parameter or a variable.

Block Parameter: Binding

Type: `Simulink.HMI.ParamSourceInfo`

Default: []

Minimum — Minimum tick mark value

0 (default) | scalar

Finite, real, double, scalar value specifying the minimum tick mark value for the scale. The minimum must be less than the value of the **Maximum** parameter.

Programmatic Use

To programmatically set the `Minimum` parameter, use a 1-by-3 vector containing values for the `Minimum`, `Tick Interval`, and `Maximum` parameters, in that order. To use the `auto` value for the `Tick Interval`, leave the `Tick Interval` position in the vector empty or specify -1.

Block Parameter: Limits

Type: 1x3 vector

Default: [0 -1 100]

Maximum — Maximum tick mark value

100 (default) | scalar

Finite, real, double, scalar value specifying the maximum tick mark value for the scale. The maximum must be greater than the value of the **Minimum** parameter.

Programmatic Use

To programmatically set the `Maximum` parameter, use a 1-by-3 vector containing values for the `Minimum`, `Tick Interval`, and `Maximum` parameters, in that order. To use the `auto` value for the `Tick Interval`, leave the `Tick Interval` position in the vector empty or specify -1.

Block Parameter: Limits

Type: 1x3 vector

Default: [0 -1 100]

Tick Interval — Interval between major tick marks

auto (default) | scalar

Finite, real, positive, whole, scalar value specifying the interval of major tick marks on the scale. When set to `auto`, the block automatically adjusts the tick interval based on the values of the **Maximum** and **Minimum** parameters.

Programmatic Use

To programmatically set the `Tick Interval` parameter, use a 1-by-3 vector containing values for the `Minimum`, `Tick Interval`, and `Maximum` parameters, in that order. To use the `auto` value for the `Tick Interval`, leave the `Tick Interval` position in the vector empty or specify -1.

Block Parameter: Limits

Type: 1x3 vector

Default: [0 -1 100]

Label — Block label position

Top (default) | Bottom | Hide

Position of the block label. When the block is connected to an element in the model, the label is the name of the connected element.

Programmatic Use

Block Parameter: LabelPosition

Type: character vector

Values: 'Top' | 'Bottom' | 'Hide'

Default: 'Top'

Foreground Color — Block foreground color

[r g b] vector

Block foreground color, excluding the text. The **Foreground Color** applies to the scale and the block name. To specify the color for the block text, use the **Font Color**.

Specify the **Foreground Color** for the block using the **Design** tab in the Property Inspector.

- 1 On the **Design** tab, click **Edit Design**.
- 2 Select the **Scale** component.
- 3 In the **Ticks** section, open the **Color** menu. You can choose from the palette of standard colors or specify a custom color.

Programmatic Use

Specify the `ForegroundColor` parameter for the block as a 1-by-3 [r g b] vector with values between 0 and 1.

Block Parameter: ForegroundColor

Type: [r g b] vector

Background Color — Block background color

[r g b] vector

Block background color. You can choose to select a solid background color instead of providing a background image. To design a block that uses a solid background, use the **Design** tab in the Property Inspector.

- 1 On the **Design** tab, click **Edit Design**.
- 2 Select the **Background** component.
- 3 Select **Use background color**.
- 4 Choose a background color from the palette of standard colors or specify a custom color.
- 5 Adjust the **Offset from scale** option until the solid background is the desired size.

Changing the background color using the toolbar removes the background image and enables the **Use background color** option.

Programmatic Use

Specify the `BackgroundColor` parameter for the block as a 1-by-3 [r g b] vector with values between 0 and 1.

Block Parameter: BackgroundColor

Type: [r g b] vector

Font Color — Block font color

[r g b] vector

Block font color. The **Font Color** applies to the scale labels. To specify the color of the scale, use the **Foreground Color**.

Specify the **Font Color** for the block using the **Design** tab in the Property Inspector.

- 1 On the **Design** tab, click **Edit Design**.
- 2 Select the **Scale** component.
- 3 In the **Labels** section, open the **Color** menu. You can choose from the palette of standard colors or specify a custom color.

Block Characteristics

| | |
|---------------------------------|----------------------------------|
| Data Types | double half integer single |
| Direct Feedthrough | no |
| Multidimensional Signals | no |
| Variable-Size Signals | no |
| Zero-Crossing Detection | no |

Extended Capabilities

C/C++ Code Generation

Generate C and C++ code using Simulink® Coder™.

Dashboard blocks are ignored for code generation.

See Also

Blocks

Horizontal Slider | Slider | Knob | Circular Gauge | Horizontal Gauge | Vertical Gauge

Topics

“Tune and Visualize Your Model with Dashboard Blocks”

“Simulation Pacing”

Introduced in R2021a

Waveform Generator

Output waveforms using signal notations

Library: Simulink / Sources



Description

The Waveform Generator block outputs waveforms based on signal notations that you enter in the **Waveform Definition** table.

This block supports these syntaxes for the signal notations:

- Function syntax — Specify all arguments in the specific order for the signal syntax (see “Algorithms” on page 1-2000).
- Name-value syntax — Specify optional comma-separated pairs of `Name`, `Value` arguments. `Name` is the argument name and `Value` is the corresponding value. `Name` must appear inside single quotes (' '). You can specify several name and value pair arguments in any order as `Name1, Value1, . . . , NameN, ValueN`. For more information, see “Algorithms” on page 1-2000.

This block supports normal, accelerator, and rapid accelerator modes and fast restart.

Supported Operators

| Operation | Operator |
|----------------|----------------------|
| Absolute value | <code>abs ()</code> |
| Addition | <code>+</code> |
| Division | <code>/</code> |
| Multiplication | <code>*</code> |
| Parentheses | <code>()</code> |
| Subtraction | <code>-</code> |
| Unary minus | <code>-</code> |

The Waveform block observes the following rules of operator precedence:

- 1 ()
- 2 + - (unary)
- 3 * /
- 4 + -

Supported Operations

The Waveform Generator block outputs one signal at a time. You can change this output signal. Express frequency and phase offset parameters in radians. You can also:

- Nest signal notations, for example:

```
sin('Amplitude',sin('Amplitude',1,'Frequency',1,'Phase',0),'Frequency',1,'Phase',1)
```

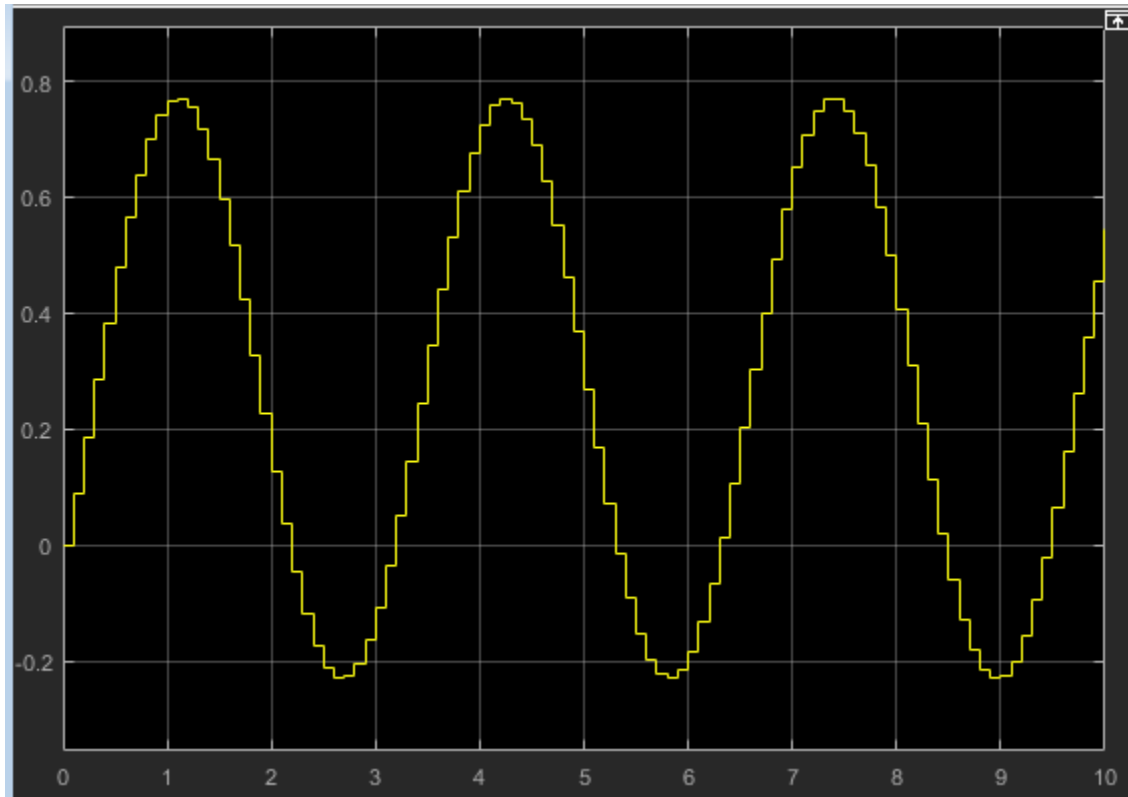

- Reference real scalar variables in the base or model workspace, for example:

```
sin('Amplitude',x,'Frequency',y,'Phase',z)
```

x , y , and z exist in the base workspace.

For more information on waveforms, see the Algorithms section.

To quickly determine the response of a system to different types of inputs, you can vary the output signal of the Waveform Generator block while a simulation is in progress.

Limitations

- You cannot tune the parameters of a waveform, such as frequency or amplitude, during execution of the code that you generate by using Simulink Coder. Instead, you can generate code that enables you to switch between waveform variants that you specify. For more information, see “Switch Between Output Waveforms During Code Execution for Waveform Generator Block” (Simulink Coder).

Ports

Output

Port_1 — Generated output signal

scalar | vector

Output signal specified by an entry in the **Waveform Definition** table.

Data Types: `single` | `double` | `int8` | `int16` | `int32` | `int64` | `uint8` | `uint16` | `uint32` | `uint64` | `Boolean` | `fixed point` | `bus`

Parameters

Main

Output Signal — Waveform for output signal

1 (default) | integer

Select waveform definition to specify the output signal. The number corresponds to the line item in the **Waveform Definition** table. You can change this parameter while a simulation is running.

Programmatic Use

Block Parameter: SelectedSignal

Type: character vector

Values: scalar

Default: '1'

Waveform Definition — Waveform signal notations

`constant` | `gaussian(mean,variance,seed)` | `pulse(amplitude,trigger_time,duration)` | `sawtooth(amplitude,frequence,phase_offset)` | `sin(amplitude,frequence,phase_offset)` | `square(amplitude,frequence,phase_offset)` | `step(step_time,initial_value,final_value)`

Enter signal notations in the **Waveform Definition** table, one waveform definition per line. For syntax details, see Algorithms.

Signal Attributes

Click the **Show data type assistant** button  to display the **Data Type Assistant**, which helps you set the data type attributes. For more information, see “Specify Data Types Using Data Type Assistant”.

Output minimum — Minimum output value for range checking

[] (default) | scalar

Lower value of the output range that Simulink checks.

Simulink uses the minimum to perform:

- Parameter range checking (see “Specify Minimum and Maximum Values for Block Parameters”) for some blocks.
- Simulation range checking (see “Specify Signal Ranges” and “Enable Simulation Range Checking”).
- Automatic scaling of fixed-point data types.
- Optimization of the code that you generate from the model. This optimization can remove algorithmic code and affect the results of some simulation modes such as SIL or external mode. For more information, see “Optimize using the specified minimum and maximum values” (Embedded Coder).

Note Output minimum does not saturate or clip the actual output signal. Use the Saturation block instead.

Programmatic Use

Block Parameter: OutMin

Type: character vector

Values: '[]' | scalar

Default: '[]'

Output maximum — Maximum output value for range checking

[] (default) | scalar

Upper value of the output range that Simulink checks.

Simulink uses the maximum value to perform:

- Parameter range checking (see “Specify Minimum and Maximum Values for Block Parameters”) for some blocks.
- Simulation range checking (see “Specify Signal Ranges” and “Enable Simulation Range Checking”).
- Automatic scaling of fixed-point data types.
- Optimization of the code that you generate from the model. This optimization can remove algorithmic code and affect the results of some simulation modes such as SIL or external mode. For more information, see “Optimize using the specified minimum and maximum values” (Embedded Coder).

Note Output maximum does not saturate or clip the actual output signal. Use the Saturation block instead.

Programmatic Use

Block Parameter: OutMax

Type: character vector

Values: '[]' | scalar

Default: '[]'

Output data type — Specify the output data type

double (default) | Inherit: Inherit via back propagation | single | int8 | int32 | uint32 | int64 | uint64 | fixdt(1,16,2^0,0) | <data type expression> | ...

Choose the data type for the output. The type can be inherited, specified directly, or expressed as a data type object such as Simulink.NumericType.

Programmatic Use

Block Parameter: OutDataTypeStr

Type: character vector

Values: , 'Inherit: Inherit via back propagation', 'single', 'int8', 'uint8', int16, 'uint16', 'int32', 'uint32', 'int64', 'uint64', fixdt(1,16,0), fixdt(1,16,2^0,0), fixdt(1,16,2^0,0). '<data type expression>'

Default: 'Double'

Lock output data type setting against changes by the fixed-point tools — Prevent fixed-point tools from overriding data types`off (default) | on`

Select to lock the output data type setting of this block against changes by the Fixed-Point Tool and the Fixed-Point Advisor. For more information, see “Use Lock Output Data Type Setting” (Fixed-Point Designer).

Programmatic Use**Block Parameter:** LockScale**Type:** character vector**Values:** 'off' | 'on'**Default:** 'off'**Lock data type settings against changes by the fixed-point tools — Prevent fixed-point tools from overriding data types**`off (default) | on`

Select to lock data type settings of this block against changes by the Fixed-Point Tool and the Fixed-Point Advisor. For more information, see “Lock the Output Data Type Setting” (Fixed-Point Designer).

Programmatic Use**Block Parameter:** LockScale**Values:** 'off' | 'on'**Default:** 'off'**Integer rounding mode — Specify the rounding mode for fixed-point operations**`Floor (default) | Ceiling | Convergent | Nearest | Round | Simplest | Zero`

Choose one of these rounding modes.

Ceiling

Rounds both positive and negative numbers toward positive infinity. Equivalent to the MATLAB `ceil` function.

Convergent

Rounds number to the nearest representable value. If a tie occurs, rounds to the nearest even integer. Equivalent to the Fixed-Point Designer `convergent` function.

Floor

Rounds both positive and negative numbers toward negative infinity. Equivalent to the MATLAB `floor` function.

Nearest

Rounds number to the nearest representable value. If a tie occurs, rounds toward positive infinity. Equivalent to the Fixed-Point Designer `nearest` function.

Round

Rounds number to the nearest representable value. If a tie occurs, rounds positive numbers toward positive infinity and rounds negative numbers toward negative infinity. Equivalent to the Fixed-Point Designer `round` function.

Simplest

Automatically chooses between round toward floor and round toward zero to generate rounding code that is as efficient as possible.

Zero

Rounds number toward zero. Equivalent to the MATLAB `fix` function.

Programmatic Use

Block Parameter: `RndMeth`

Type: character vector

Values: 'Ceiling' | 'Convergent' | 'Floor' | 'Nearest' | 'Round' | 'Simplest' | 'Zero'

Default: 'Floor'

See Also

For more information, see “Rounding” (Fixed-Point Designer).

Saturate on integer overflow – Method of overflow action

`off` (default) | `on`

Specify whether overflows saturate or wrap.

| Action | Rationale | Impact on Overflows | Example |
|--|---|---|---|
| Select this check box (<code>on</code>). | Your model has possible overflow, and you want explicit saturation protection in the generated code. | Overflows saturate to either the minimum or maximum value that the data type can represent. | The maximum value that the <code>int8</code> (signed, 8-bit integer) data type can represent is 127. Any block operation result greater than this maximum value causes overflow of the 8-bit integer. With the check box selected, the block output saturates at 127. Similarly, the block output saturates at a minimum output value of -128. |
| Do not select this check box (<code>off</code>). | You want to optimize efficiency of your generated code. You want to avoid overspecifying how a block handles out-of-range signals. For more information, see “Troubleshoot Signal Range Errors”. | Overflows wrap to the appropriate value that is representable by the data type. | The maximum value that the <code>int8</code> (signed, 8-bit integer) data type can represent is 127. Any block operation result greater than this maximum value causes overflow of the 8-bit integer. With the check box cleared, the software interprets the overflow-causing value as <code>int8</code> , which can produce an unintended result. For example, a block result of 130 (binary 1000 0010) expressed as <code>int8</code> , is -126. |

When you select this check box, saturation applies to every internal operation on the block, not just the output, or result. Usually, the code generation process can detect when overflow is not possible. In this case, the code generator does not produce saturation code.

Programmatic Use**Block Parameter:** SaturateOnIntegerOverflow**Type:** character vector**Values:** 'off' | 'on'**Default:** 'off'**Sample time — Time interval between samples**

0.1 (default) | scalar

Specify the time interval between samples. To inherit the sample time, set this parameter to -1. See “Specify Sample Time” for more information.

Programmatic Use**Block Parameter:** SampleTime**Type:** character vector**Values:** scalar**Default:** '0.1'**Block Characteristics**

| | |
|---------------------------------|---|
| Data Types | Boolean double fixed point integer single |
| Direct Feedthrough | no |
| Multidimensional Signals | no |
| Variable-Size Signals | no |
| Zero-Crossing Detection | no |

Algorithms

Enter signal notations in the **Waveform Definition** table, one waveform definition per line. To add a waveform definition, click **Add**. The new waveform appears as an empty character vector. The block interprets empty character vectors or white space character vectors as ground.

To remove a waveform definition, click **Remove**. You can select multiple waveforms using **Ctrl+click** or **Shift+click**.

Constant

Constant values can be:

- Numbers
- Workspace variables
 - Scalar, real variables only
- Built-in MATLAB constant, pi

Examples

- 1
- 1.1

- x
- pi

Gaussian Noise

Syntax

```
gaussian(mean,variance,seed)
```

```
gaussian('Mean',mean,'Variance',variance,'Seed',seed)
```

Input Arguments

- mean — Mean value of the random variable output.
 - Default: 0
- variance — Standard deviation squared of the random variable output.
 - Default: 1
 - Value: Positive constant or positive real scalar variable
- seed — Initial seed value for the random number generator.
 - Default: 0
 - Value: Constant or real scalar variable

Example

```
gaussian('Mean',0,'Variance',10,'Seed',1)
```

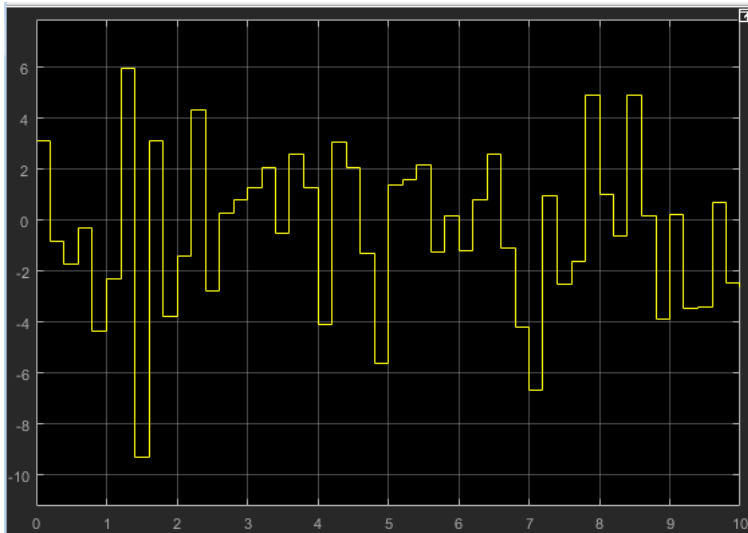

Pulse

Syntax

```
pulse(amplitude,trigger_time,duration)
```

```
pulse('Amplitude',amplitude,'TriggerTime',trigger_time,'Duration',duration)
```

Input Arguments

- `amplitude` — Value of signal when pulse is high.
 - Default: 1
- `trigger_time` — Elapsed simulation time when signal changes to amplitude, in seconds.
 - Default: 1
 - Value: Constant or real scalar variable
- `duration` — How long the signal remains at the given amplitude before returning to ground, in seconds.
 - Default: 1
 - Value: Positive constant or positive real scalar variable

Example

```
pulse('Amplitude',1,'TriggerTime',1,'Duration',1)
```

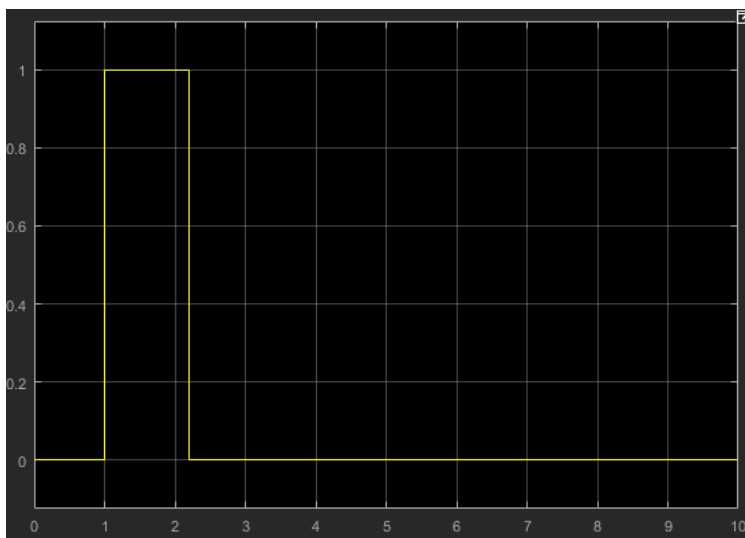
**Sawtooth****Syntax**

```
sawtooth(amplitude,frequency,phase_offset)
```

```
sawtooth('Amplitude',amplitude,'Frequency',frequency,'Phase',phase_offset)
```

Input Arguments

- `amplitude` — Sawtooth peak value.
 - Default: 1
- `frequency` — Waveform frequency, in rad/s.
 - Default: 1
- `phase_offset` — Horizontal signal shift, based on elapsed simulation time, in seconds.

- Default: 0

Example

```
sawtooth('Amplitude',1,'Frequency',1,'Phase',0)
```

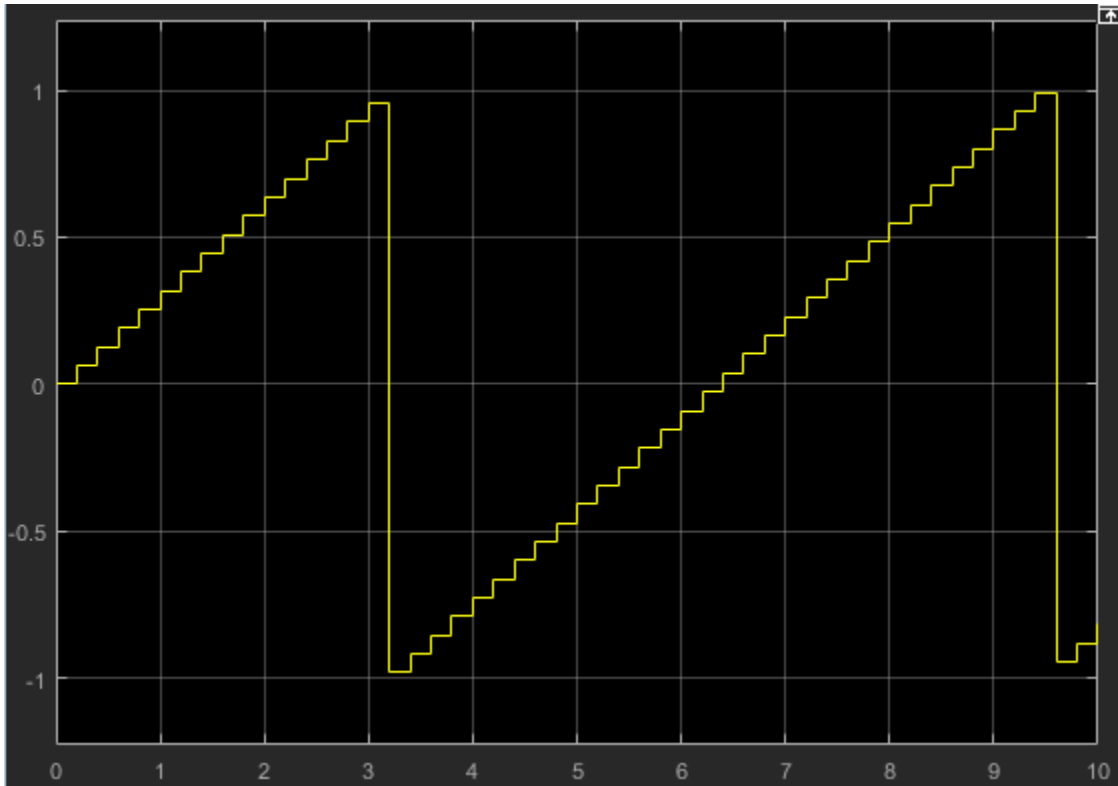
**Sine Wave****Syntax**

```
sin(amplitude,frequency,phase_offset)
```

```
sin('Amplitude',amplitude,'Frequency',frequency,'Phase',phase_offset)
```

Input Arguments

- `amplitude` — Amplitude of sine wave.
 - Default: 1
- `frequency` — Waveform frequency, in rad/s.
 - Default: 1
- `phase_offset` — Phase offset, in rads.
 - Default: 0

Examples

```
sin('Amplitude',1,'Frequency',1,'Phase',0)
```

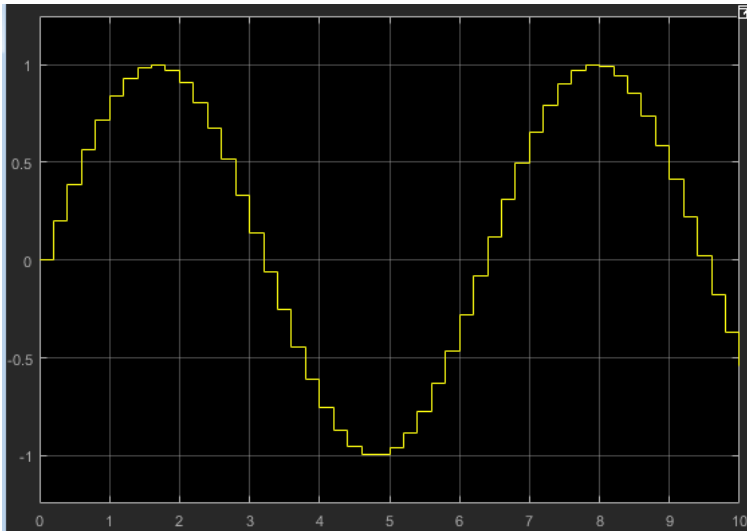

To get the cosine waveform:

```
sin('Amplitude',1,'Frequency',1,'Phase',pi/2)
```

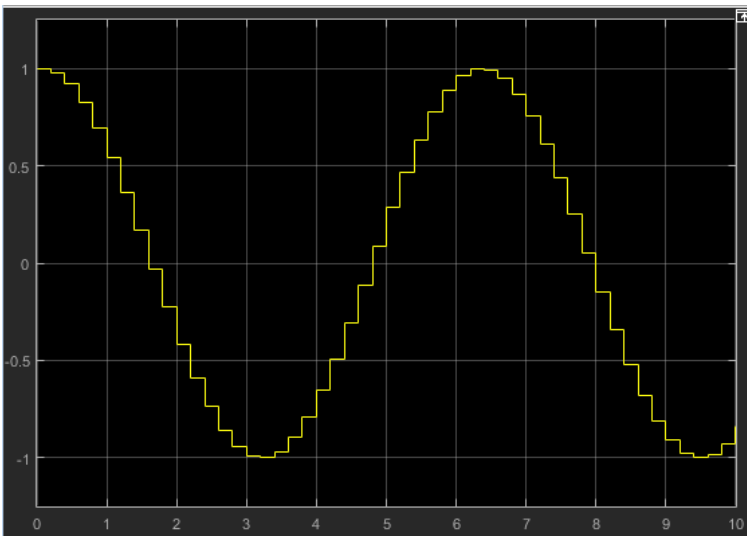

Square

Syntax

```
square(amplitude,frequency,phase_delay,duty_cycle)
```

```
square('Amplitude',amplitude,'Frequency',frequency,'Phase',phase_delay,...  
'DutyCycle',duty_cycle)
```

Input Arguments

- `amplitude` — Amplitude of signal.
 - Default: 1
- `frequency` — Waveform frequency in rad/s.

- Default: 1
- `phase_delay` — Horizontal signal shift based on elapsed simulation time, in seconds.
 - Default: 0
- `duty_cycle` — Percentage of high signal per period (0-100%). The block clips the minimum signal to 0% and the maximum signal to 100%.
 - Default: 50

Example

```
square('Amplitude',1,'Frequency',1,'Phase',0,'DutyCycle',50)
```

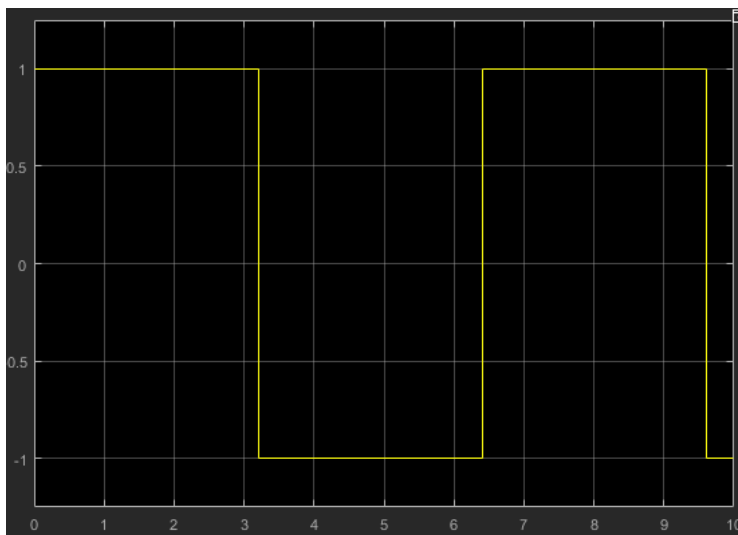

Step

Syntax

```
step(step_time,initial_value,final_value)
```

```
step('StepTime',step_time,'InitialValue',initial_value,'FinalValue',final_value)
```

Input Arguments

- `step_time` — Elapsed simulation time when signal changes from `initial_value` to `final_value`, in seconds.
 - Default: 1
 - Value: Constant or positive real scalar variable.
- `initial_value` — Value of signal when elapsed simulation time is less than `step_time`, in seconds.
 - Default: 0
- `final_value` — Value of signal when elapsed simulation time is greater than or equal to `step_time`, in seconds.
 - Default: 1

Example

```
step('StepTime',1,'InitialValue',0,'FinalValue',1)
```

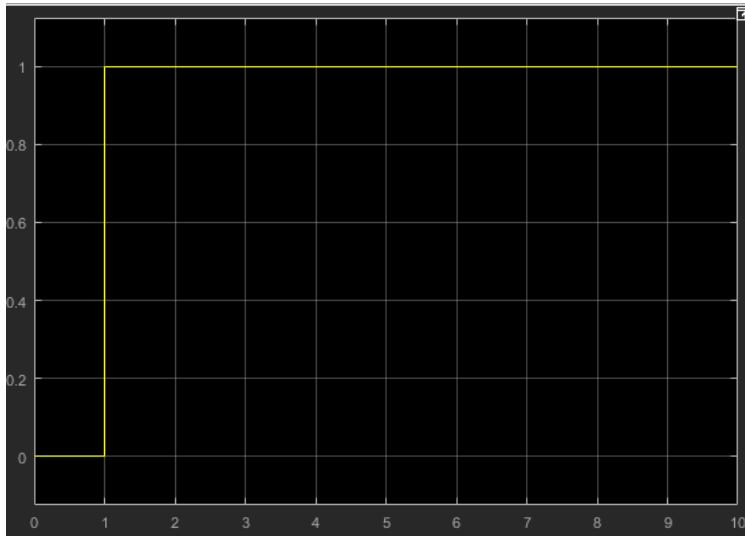
**Extended Capabilities****C/C++ Code Generation**

Generate C and C++ code using Simulink® Coder™.

Not recommended for production code.

Fixed-Point Conversion

Design and simulate fixed-point systems using Fixed-Point Designer™.

See Also

Signal Editor | Repeating Sequence

Topics

“Signal Basics”

Introduced in R2015b

Weighted Sample Time

Support calculations involving sample time

Library: Simulink / Signal Attributes



Description

The Weighted Sample Time block outputs the weighted sample time or weighted sample rate. Because the Weighted Sample Time block is an implementation of the Weighted Sample Time Math, you can also add, subtract, multiply, or divide the input signal, u , by a weighted sample time, T_s . If the input signal is continuous, T_s is the sample time of the Simulink model. Otherwise, T_s is the sample time of the discrete input signal. If the input signal is constant, Simulink assigns a finite sample time to the block based on its connectivity and context.

You specify the math operation with the **Operation** parameter. The block can output just a weighted sample time (**Ts Only**) or a weighted sample rate (**1/Ts Only**).

Enter the weighting factor in the **Weight value** parameter. If the weight, w , is 1, that value does not appear in the equation on the block icon.

Tip You can use the Weighted Sample Time and Weighted Sample Time Math blocks to extract the sample time from a Simulink signal. To do so, set the **Operation** parameter to **Ts** and the **Weight value** to 1.0. In this configuration, the block outputs the sample time of the input signal.

The block computes its output using the precedence rules for MATLAB operators. See “Operator Precedence” for information. For example, if the **Operation** parameter specifies $+$, the block calculates output using this equation:

$$u + (T_s * w)$$

However, if the **Operation** parameter specifies $/$, the block calculates output using this equation:

$$(u / T_s) / w$$

Ports

Input

Port_1 — Input signal

scalar | vector | matrix

Specify the input signal, u , as a scalar, vector, or matrix. Depending on the value of the **Operation** parameter, the block can add, subtract, multiply, or divide the input signal by weighted sample time or just output the weighted sample time or weighted sample rate.

Data Types: single | double | int8 | int16 | int32 | int64 | uint8 | uint16 | uint32 | uint64 | Boolean | fixed point

Output

Port_1 — Output signal

scalar | vector | matrix

Output the weighted sample time or sample rate of the input signal, or output the input signal adjusted by the weighted sample time, T_s . If the input signal is continuous, T_s is the sample time of the Simulink model. Otherwise, T_s is the sample time of the discrete input signal. When the input signal is constant, Simulink assigns a finite sample time to the block based on its connectivity and context.

Data Types: single | double | int8 | int16 | int32 | int64 | uint8 | uint16 | uint32 | uint64 | Boolean | fixed point

Parameters

Main

Operation — Math operation

T_s Only (default) | + | - | * | / | 1/ T_s Only

Specify the operation to use for adjusting the input signal. You can select: +, -, *, /, T_s Only, or 1/ T_s Only.

Programmatic Use

Block Parameter: TsamMathOp

Type: character vector

Values: '+' | '-' | '*' | '/' | 'Ts Only' | '1/Ts Only'

Default: 'Ts Only'

Weight value — Weight of sample time

1.0 (default) | real-valued scalar

Enter the weight of the sample time as a real-valued scalar.

Programmatic Use

Block Parameter: weightValue

Type: character vector

Values: real-valued scalar

Default: '1.0'

Implement using — Method for adjusting sample time

Online Calculations (default) | Offline Scaling Adjustment

Select one of two modes: online calculations or offline scaling adjustment.

| Result of ($T_s * w$) | Output Data Type of Two Modes | Block Execution |
|---|--|---|
| A power of 2, or an integer value | The same, when Output data type is Inherit: Inherit via internal rule | Equally efficient in both modes |
| Not power of 2 and not an integer value | Different | More efficient for the offline scaling mode |

Note When the **Implement using** parameter is not visible, operations default to online calculations.

Dependencies

To enable this parameter, set **Operation** to * or /.

Programmatic Use

Block Parameter: TsampMathImp

Type: character vector

Values: 'Online Calculations' | 'Offline Scaling Adjustment'

Default: 'Online Calculations'

Signal Attributes

Output data type — Data type of output signal

Inherit: Inherit via internal rule (default) | Inherit: Inherit via back propagation | <data type expression>

Specify the data type for the output.

Programmatic Use

Block Parameter: OutDataTypeStr

Type: character vector

Values: 'Inherit: Inherit via internal rule' | 'Inherit: Inherit via back propagation' | '<data type expression>'

Default: 'Inherit: Inherit via internal rule'

Integer rounding mode — Rounding mode for fixed-point operations

Floor (default) | Ceiling | Convergent | Nearest | Round | Simplest | Zero

Specify the rounding mode for fixed-point operations. For more information, see “Rounding” (Fixed-Point Designer).

Block parameters always round to the nearest representable value. To control the rounding of a block parameter, enter an expression using a MATLAB rounding function into the mask field.

Dependencies

To enable this parameter, set **Operation** to +, -, *, or /. If you set the **Operation** parameter to * or /, you must also set **Implement using** to Online Calculations.

Programmatic Use

Block Parameter: RndMeth

Type: character vector

Values: 'Ceiling' | 'Convergent' | 'Floor' | 'Nearest' | 'Round' | 'Simplest' | 'Zero'

Default: 'Floor'

Saturate on integer overflow — Method of overflow action

off (default) | on

Specify whether overflows saturate or wrap.

| Action | Rationale | Impact on Overflows | Example |
|-------------------------------------|---|---|---|
| Select this check box (on). | Your model has possible overflow, and you want explicit saturation protection in the generated code. | Overflows saturate to either the minimum or maximum value that the data type can represent. | The maximum value that the <code>int8</code> (signed, 8-bit integer) data type can represent is 127. Any block operation result greater than this maximum value causes overflow of the 8-bit integer. With the check box selected, the block output saturates at 127. Similarly, the block output saturates at a minimum output value of -128. |
| Do not select this check box (off). | You want to optimize efficiency of your generated code. You want to avoid overspecifying how a block handles out-of-range signals. For more information, see "Troubleshoot Signal Range Errors". | Overflows wrap to the appropriate value that is representable by the data type. | The maximum value that the <code>int8</code> (signed, 8-bit integer) data type can represent is 127. Any block operation result greater than this maximum value causes overflow of the 8-bit integer. With the check box cleared, the software interprets the overflow-causing value as <code>int8</code> , which can produce an unintended result. For example, a block result of 130 (binary 1000 0010) expressed as <code>int8</code> , is -126. |

When you select this check box, saturation applies to every internal operation on the block, not just the output, or result. Usually, the code generation process can detect when overflow is not possible. In this case, the code generator does not produce saturation code.

Dependencies

To enable this parameter, set **Operation** to +, -, *, or /. If you set the **Operation** parameter to * or /, you must also set **Implement using** to Online Calculations.

Programmatic Use

Block Parameter: SaturateOnIntegerOverflow

Type: character vector

Values: 'off' | 'on'

Default: 'off'

Block Characteristics

| | |
|---------------------------|---|
| Data Types | Boolean double fixed point integer single |
| Direct Feedthrough | yes |

| | |
|---------------------------------|----|
| Multidimensional Signals | no |
| Variable-Size Signals | no |
| Zero-Crossing Detection | no |

Extended Capabilities

C/C++ Code Generation

Generate C and C++ code using Simulink® Coder™.

Fixed-Point Conversion

Design and simulate fixed-point systems using Fixed-Point Designer™.

See Also

Weighted Sample Time Math | Probe

Topics

“What Is Sample Time?”

“Specify Sample Time”

“View Sample Time Information”

Introduced before R2006a

Weighted Sample Time Math

Support calculations involving sample time

Library: Simulink / Math Operations



Description

The Weighted Sample Time Math block adds, subtracts, multiplies, or divides its input signal, u , by a weighted sample time, T_s . If the input signal is continuous, T_s is the sample time of the Simulink model. Otherwise, T_s is the sample time of the discrete input signal. If the input signal is constant, Simulink assigns a finite sample time to the block based on its connectivity and context.

You specify the math operation with the **Operation** parameter. The block can output just a weighted sample time (T_s Only) or a weighted sample rate ($1/T_s$ Only).

Enter the weighting factor in the **Weight value** parameter. If the weight, w , is 1, that value does not appear in the equation on the block icon.

Tip You can use the Weighted Sample Time and Weighted Sample Time Math blocks to extract the sample time from a Simulink signal. To do so, set the **Operation** parameter to T_s and the **Weight value** to 1.0. In this configuration, the block outputs the sample time of the input signal.

The block computes its output using the precedence rules for MATLAB operators. See “Operator Precedence” for information. For example, if the **Operation** parameter specifies $+$, the block calculates output using this equation:

$$u + (T_s * w)$$

However, if the **Operation** parameter specifies $/$, the block calculates output using this equation:

$$(u / T_s) / w$$

Ports

Input

Port_1 – Input signal

scalar | vector | matrix

Specify the input signal, u , as a scalar, vector, or matrix. Depending on the value of the **Operation** parameter, the block can add, subtract, multiply, or divide the input signal by weighted sample time or just output the weighted sample time or weighted sample rate.

Data Types: single | double | int8 | int16 | int32 | int64 | uint8 | uint16 | uint32 | uint64 | Boolean | fixed point

Output

Port_1 — Output signal

scalar | vector | matrix

Output the weighted sample time or sample rate of the input signal, or output the input signal adjusted by the weighted sample time, T_s . If the input signal is continuous, T_s is the sample time of the Simulink model. Otherwise, T_s is the sample time of the discrete input signal. When the input signal is constant, Simulink assigns a finite sample time to the block based on its connectivity and context.

Data Types: single | double | int8 | int16 | int32 | int64 | uint8 | uint16 | uint32 | uint64 | Boolean | fixed point

Parameters

Main

Operation — Math operation

+ (default) | - | * | / | Ts Only | 1/Ts Only

Specify the operation to use for adjusting the input signal. You can select: +, -, *, /, Ts Only, or 1/Ts Only.

Programmatic Use

Block Parameter: TsamMathOp

Type: character vector

Values: '+' | '-' | '*' | '/' | 'Ts Only' | '1/Ts Only'

Default: '+'

Weight value — Weight of sample time

1.0 (default) | real-valued scalar

Enter the weight of the sample time as a real-valued scalar.

Programmatic Use

Block Parameter: weightValue

Type: character vector

Values: real-valued scalar

Default: '1.0'

Implement using — Method for adjusting sample time

Online Calculations (default) | Offline Scaling Adjustment

Select one of two modes: online calculations or offline scaling adjustment.

| Result of ($T_s * w$) | Output Data Type of Two Modes | Block Execution |
|---|--|---|
| A power of 2, or an integer value | The same, when Output data type is Inherit: Inherit via internal rule | Equally efficient in both modes |
| Not power of 2 and not an integer value | Different | More efficient for the offline scaling mode |

Note When the **Implement using** parameter is not visible, operations default to online calculations.

Dependencies

To enable this parameter, set **Operation** to * or /.

Programmatic Use

Block Parameter: TsampMathImp

Type: character vector

Values: 'Online Calculations' | 'Offline Scaling Adjustment'

Default: 'Online Calculations'

Signal Attributes

Output data type — Data type of output signal

Inherit: Inherit via internal rule (default) | Inherit: Inherit via back propagation | <data type expression>

Specify the data type for the output.

Programmatic Use

Block Parameter: OutDataTypeStr

Type: character vector

Values: 'Inherit: Inherit via internal rule' | 'Inherit: Inherit via back propagation' | '<data type expression>'

Default: 'Inherit: Inherit via internal rule'

Integer rounding mode — Rounding mode for fixed-point operations

Floor (default) | Ceiling | Convergent | Nearest | Round | Simplest | Zero

Specify the rounding mode for fixed-point operations. For more information, see “Rounding” (Fixed-Point Designer).

Block parameters always round to the nearest representable value. To control the rounding of a block parameter, enter an expression using a MATLAB rounding function into the mask field.

Dependencies

To enable this parameter, set **Operation** to +, -, *, or /. If you set the **Operation** parameter to * or /, you must also set **Implement using** to Online Calculations.

Programmatic Use

Block Parameter: RndMeth

Type: character vector

Values: 'Ceiling' | 'Convergent' | 'Floor' | 'Nearest' | 'Round' | 'Simplest' | 'Zero'

Default: 'Floor'

Saturate on integer overflow — Method of overflow action

off (default) | on

Specify whether overflows saturate or wrap.

| Action | Rationale | Impact on Overflows | Example |
|-------------------------------------|---|---|---|
| Select this check box (on). | Your model has possible overflow, and you want explicit saturation protection in the generated code. | Overflows saturate to either the minimum or maximum value that the data type can represent. | The maximum value that the <code>int8</code> (signed, 8-bit integer) data type can represent is 127. Any block operation result greater than this maximum value causes overflow of the 8-bit integer. With the check box selected, the block output saturates at 127. Similarly, the block output saturates at a minimum output value of -128. |
| Do not select this check box (off). | You want to optimize efficiency of your generated code. You want to avoid overspecifying how a block handles out-of-range signals. For more information, see "Troubleshoot Signal Range Errors". | Overflows wrap to the appropriate value that is representable by the data type. | The maximum value that the <code>int8</code> (signed, 8-bit integer) data type can represent is 127. Any block operation result greater than this maximum value causes overflow of the 8-bit integer. With the check box cleared, the software interprets the overflow-causing value as <code>int8</code> , which can produce an unintended result. For example, a block result of 130 (binary 1000 0010) expressed as <code>int8</code> , is -126. |

When you select this check box, saturation applies to every internal operation on the block, not just the output, or result. Usually, the code generation process can detect when overflow is not possible. In this case, the code generator does not produce saturation code.

Dependencies

To enable this parameter, set **Operation** to +, -, *, or /. If you set the **Operation** parameter to * or /, you must also set **Implement using** to Online Calculations.

Programmatic Use

Block Parameter: SaturateOnIntegerOverflow

Type: character vector

Values: 'off' | 'on'

Default: 'off'

Block Characteristics

| | |
|---------------------------|---|
| Data Types | Boolean double fixed point integer single |
| Direct Feedthrough | yes |

| | |
|---------------------------------|----|
| Multidimensional Signals | no |
| Variable-Size Signals | no |
| Zero-Crossing Detection | no |

Extended Capabilities

C/C++ Code Generation

Generate C and C++ code using Simulink® Coder™.

Fixed-Point Conversion

Design and simulate fixed-point systems using Fixed-Point Designer™.

See Also

Weighted Sample Time | Probe

Topics

“What Is Sample Time?”

“Specify Sample Time”

“View Sample Time Information”

Introduced before R2006a

While Iterator

Control block for While Iterator subsystem

Description

The While Iterator block, when placed in a Subsystem block, repeatedly executes the contents of the subsystem during the current time step while the value of the input condition is true or 1. Use this block to implement the block diagram equivalent of a `while` loop in a programming language.

The While Iterator Subsystem block is preconfigured with a While Iterator block. Placing a While Iterator block in a Subsystem block makes it an atomic subsystem.

Ports

Input

cond — Logical condition signal

scalar

Signal with the result from evaluating a logical condition. Because the subsystem is not externally triggered during a time step, evaluating a condition as true (1) or false (0) must reside within the subsystem.

The data type and values of the signal can be:

- Logical (Boolean) — true (1) or false (0) .
- Numerical — true (any positive or negative number) or false (0).

Data Types: `single` | `double` | `int8` | `int16` | `int32` | `uint8` | `uint16` | `uint32` | `Boolean` | `fixed point`

IC — Initial logical condition

scalar

Signal with the initial logical condition. At the beginning of each time step:

- If IC is false (0), the subsystem does not execute during the time step.
- If IC is true (value not equal to 0), the subsystem starts executing and continues to repeat execution as long as the `cond` signal is true.

Data Types: `single` | `double` | `int8` | `int16` | `int32` | `uint8` | `uint16` | `uint32` | `Boolean` | `fixed point`

Output Arguments

Iteration number — Signal with the number of iterations

scalar

Signal with the number of While Iterator Subsystem block executions during each time step.

Data Types: `double` | `int8` | `int16` | `int32`

Parameters

Maximum number of iterations — Specify maximum number of iterations

-1 (default) | integer

Specify maximum number of iterations allowed during a time step.

-1

Any number of iterations as long as the cond signal is true (value not equal to 0) . If you specify -1 and the cond signal never becomes false (0), the simulation runs in an infinite loop. In this case, the only way to stop the simulation is to terminate MATLAB.

integer

Maximum number of iterations during a time step.

Programmatic Use

Block Parameter: MaxIters

Type: character vector

Values: '5' | '-1' | '<integer>'

Default: '5'

While loop type — Select type of block

while (default) | do-while

Select type of block.

while

The While Iterator block has two inputs, a cond (logical condition) input and an IC (initial logical condition) input. The source of the IC signal must be external to the While Iterator Subsystem block.

At the beginning of each time step:

- If the IC input is true (value not equal to 0), the blocks in the subsystem repeat execution while the cond input is true. This process continues during a time step as long as the cond input is true and the number of iterations is less than or equal to the **Maximum number of iterations**.
- If the IC input is false, the While Iterator block does not execute the contents of the subsystem.

do-while

The While Iterator block has one input, the cond (while condition) input.

At each time step, the blocks in the subsystem repeat execution while the cond input is true (value not equal to 0). This process continues as long as the cond input is true and the number of iterations is less than or equal to the **Maximum number of iterations**.

Programmatic Use

Block Parameter: WhileBlockType

Type: character vector

Values: 'while' | 'do-while'

Default: 'while'

States when starting — Select block states between time steps

held (default) | reset

Select how to handle block states between time steps.

held

Hold block states between time steps. Block state values persist across time steps.

reset

Reset block states to their initial values at the beginning of each time step and before the first iteration loop.

Programmatic Use

Block Parameter: ResetStates

Type: character vector

Values: 'held' | 'reset'

Default: 'held'

Show iteration number port — Control display of output port

clear | select

Control display of output port for signal with number of block executions. The value of the signal from this port starts at 1 and is incremented by 1 for each succeeding iteration.

off

Remove output port.

on

Display output port for signal with iteration number.

Dependencies

Selecting this parameter enables the **Output data type** parameter.

Programmatic Use

Block Parameter: ShowIterationPort

Type: character vector

Values: 'off' | 'on'

Default: 'off'

Output data type — Select output data type for current iteration number

int32 (default) | uint32 | int16 | uint16 | int8 | uint8 | double

Select output data type for iteration number signal. The value of this signal is the number of iterations during a time step and the total number of iterations at the end of a time step.

int32

Signed 32-bit integer.

uint32

Unsigned 32-bit integer.

int16

Signed 16-bit integer.

uint16

unsigned 16-bit integer.

int8

Signed 8-bit integer.

uint8

Unsigned 8-bit integer.

double

Double-precision floating point.

Dependencies

Select the **Show iteration number port** check box to enable this parameter.

Programmatic Use

Block Parameter: OutputDataType

Type: character vector

Value: 'int32' | 'unt32' | 'int16' | 'uint16' | 'int8' | 'uint8' | 'double'

Default: 'int32'

See Also

Blocks

While Iterator Subsystem | Subsystem

Topics

Iterator Subsystem Execution

Introduced before R2006a

While Iterator Subsystem

Repeat subsystem execution during simulation time step while logical expression is true

Library: Simulink / Ports & Subsystems

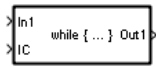

Description

The While Iterator Subsystem block is a Subsystem block preconfigured as a starting point for creating a subsystem that repeats execution during a simulation time step while a logical condition is true. Execution is controlled by a While Iterator block inside the subsystem. For an example, see `ex_while_iterator_block`.

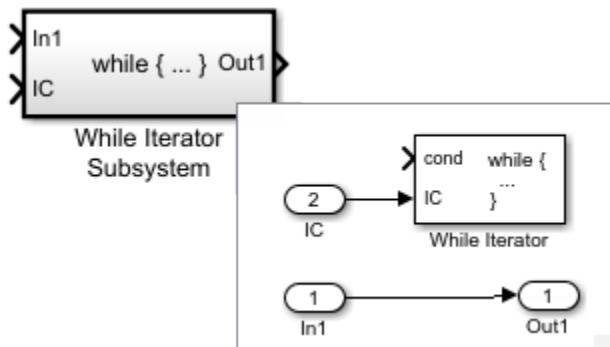

Use While Iterator Subsystem blocks to model:

- Block diagram equivalent of a program `while` or `do-while` loop.
- An iterative algorithm that converges on a more accurate solution after multiple iterations.

When using simplified initialization mode, if you place a block that needs elapsed time (such as a Discrete-Time Integrator block) in a While Iterator Subsystem block, Simulink displays an error.

If the output signal from a While Iterator Subsystem block is a function-call signal, Simulink displays an error when you simulate the model or update the diagram.

Ports

Input

In1 — Signal input to a subsystem block

scalar | vector | matrix

Placing an Inport block in a subsystem block adds an external input port to the block. The port label matches the name of the Inport block.

Use Inport blocks to get signals from the local environment.

Data Types: half | single | double | int8 | int16 | int32 | int64 | uint8 | uint16 | uint32 | uint64 | Boolean | fixed point | enumerated | bus

IC (initial logical condition) – Control initial execution of a subsystem block
 scalar

Placing a While Iterator block connected to an Input block in a Subsystem block adds this external input port to the block.

Data Types: half | single | double | int8 | int16 | int32 | int64 | uint8 | uint16 | uint32 | uint64 | Boolean | fixed point

Output

Out – Signal output from a subsystem
 scalar | vector | matrix

Placing an Outport block in a subsystem block adds an output port from the block. The port label on the subsystem block is the name of the Outport block.

Use Outport blocks to send signals to the local environment.

Data Types: half | single | double | int8 | int16 | int32 | int64 | uint8 | uint16 | uint32 | uint64 | Boolean | fixed point | enumerated | bus

Block Characteristics

| | |
|---------------------------------|---|
| Data Types | Boolean ^a bus ^a double ^a enumerated ^a fixed point ^a half ^a integer ^a single ^a string ^a |
| Direct Feedthrough | no |
| Multidimensional Signals | limited ^a |
| Variable-Size Signals | limited ^a |
| Zero-Crossing Detection | no |

a. Actual data type or capability support depends on block implementation.

Extended Capabilities

C/C++ Code Generation

Generate C and C++ code using Simulink® Coder™.

Actual data type or capability support depends on block implementation.

Fixed-Point Conversion

Design and simulate fixed-point systems using Fixed-Point Designer™.

Actual data type support depends on block implementation.

See Also

Blocks

While Iterator | Subsystem

Topics

“Iterate Subsystem Execution with While Iterator and For Iterator Subsystems”

Introduced before R2006a

Width

Output width of input vector

Library: Simulink / Signal Attributes



Description

The Width block generates as output the width of its input vector.

You can use an array of buses as an input signal to a Width block. For details about defining and using an array of buses, see “Group Nonvirtual Buses in Arrays of Buses”.

Ports

Input

Port_1 — Input signal

scalar | vector | matrix | N-D array

Input signal specified as a scalar, vector, matrix, or N-D array.

Data Types: single | double | half | int8 | int16 | int32 | int64 | uint8 | uint16 | uint32 | uint64 | string | Boolean | fixed point | enumerated | bus

Output

Port_1 — Width of input signal

scalar

Output is the width of the input signal, specified as a scalar.

Data Types: single | double | half | int8 | int16 | int32 | int64 | uint8 | uint16 | uint32 | uint64 | fixed point

Parameters

Output data type mode — Output data type mode

Choose intrinsic data type (default) | Inherit via back propagation | All ports same datatype

Specify the output data type to be the same as the input, or inherit the data type by back propagation. You can also choose to specify a built-in data type from the drop-down list in the **Output data type** parameter.

Programmatic Use

Block Parameter: OutputDataTypeScalingMode

Type: character vector

Values: 'Choose intrinsic data type' | 'Inherit via back propagation' | 'All ports same datatype'

Default: 'Choose intrinsic data type'

Output data type — Output data type

double (default) | single | int8 | uint8 | int16 | uint16 | int32 | uint32

This parameter is visible when you select Choose intrinsic data type for **Output data type mode**. Select a built-in data type from the drop-down list.

Programmatic Use

Block Parameter: DataType

Type: character vector

Values: 'double' | 'single' | 'int8' | 'uint8' | 'int16' | 'uint16' | 'int32' | 'uint32'

Default: 'double'

Block Characteristics

| | |
|---------------------------------|--|
| Data Types | Boolean bus double enumerated fixed point half integer single string |
| Direct Feedthrough | yes |
| Multidimensional Signals | yes |
| Variable-Size Signals | yes |
| Zero-Crossing Detection | no |

Extended Capabilities

C/C++ Code Generation

Generate C and C++ code using Simulink® Coder™.

Fixed-Point Conversion

Design and simulate fixed-point systems using Fixed-Point Designer™.

See Also

Probe

Topics

“Variable-Size Signal Basics”

Introduced before R2006a

Wrap To Zero

Set output to zero if input is above threshold

Library: Simulink / Discontinuities
HDL Coder / Discontinuities



Description

The Wrap To Zero block sets the output to zero when the input is above the **Threshold** value. When the input is less than or equal to the **Threshold**, then the output is equal to the input.

Ports

Input

Port_1 — Input signal

scalar | vector

Input signal, specified as a scalar or vector. Signal values equal to or greater than the value of **Threshold** are set to zero.

Data Types: single | double | int8 | int16 | int32 | int64 | uint8 | uint16 | uint32 | uint64 | Boolean | fixed point

Output

Port_1 — Output signal

scalar | vector

Output signal set to the input signal value or zero. The data type of the output is the same data type as the input.

Tip If the input data type cannot represent zero, parameter overflow occurs. To detect this overflow, go to the **Diagnostics > Data Validity** pane of the Configuration Parameters dialog box and set **Parameters > Detect overflow** to warning or error.

Data Types: single | double | int8 | int16 | int32 | int64 | uint8 | uint16 | uint32 | uint64 | Boolean | fixed point

Parameters

To edit the parameters for the Wrap to Zero block, double-click the block icon.

Threshold — Threshold for outputting zero

255 (default) | scalar

Threshold value for setting the output value to zero.

Programmatic Use**Block Parameter:** Threshold**Type:** character vector**Values:** scalar**Default:** '255'**Block Characteristics**

| | |
|---------------------------------|---|
| Data Types | Boolean double fixed point integer single |
| Direct Feedthrough | no |
| Multidimensional Signals | yes |
| Variable-Size Signals | no |
| Zero-Crossing Detection | no |

Extended Capabilities**C/C++ Code Generation**

Generate C and C++ code using Simulink® Coder™.

HDL Code Generation

Generate Verilog and VHDL code for FPGA and ASIC designs using HDL Coder™.

HDL Coder provides additional configuration options that affect HDL implementation and synthesized logic.

HDL Architecture

This block has a single, default HDL architecture.

HDL Block Properties

| | |
|----------------------------------|--|
| ConstrainedOutputPipeline | Number of registers to place at the outputs by moving existing delays within your design. Distributed pipelining does not redistribute these registers. The default is 0. For more details, see “ConstrainedOutputPipeline” (HDL Coder). |
| InputPipeline | Number of input pipeline stages to insert in the generated code. Distributed pipelining and constrained output pipelining can move these registers. The default is 0. For more details, see “InputPipeline” (HDL Coder). |
| OutputPipeline | Number of output pipeline stages to insert in the generated code. Distributed pipelining and constrained output pipelining can move these registers. The default is 0. For more details, see “OutputPipeline” (HDL Coder). |

Restrictions

The input signal and **Threshold** parameter must have equal size. For example, if the input is a two-dimensional vector, **Threshold** must also be a two-dimensional vector.

PLC Code Generation

Generate Structured Text code using Simulink® PLC Coder™.

Fixed-Point Conversion

Design and simulate fixed-point systems using Fixed-Point Designer™.

See Also

Saturation | Saturation Dynamic

Introduced before R2006a

Zero-Order Hold

Implement zero-order hold sample period

Library: Simulink / Discrete
HDL Coder / Discrete



Description

The Zero-Order Hold block holds its input for the sample period you specify. If the input is a vector, the block holds all elements of the vector for the same sample period.

You specify the time between samples with the **Sample time** parameter. A setting of -1 means the block inherits the **Sample time**.

Tip Do not use the Zero-Order Hold block to create a fast-to-slow transition between blocks operating at different sample rates. Instead, use the Rate Transition block.

Bus Support

The Zero-Order Hold block is a bus-capable block. The input can be a virtual or nonvirtual bus signal. No block-specific restrictions exist. All signals in a nonvirtual bus input to a Zero-Order Hold block must have the same sample time, even if the elements of the associated bus object specify inherited sample times. You can use a Rate Transition block to change the sample time of an individual signal, or of all signals in a bus. See “Modify Sample Times for Nonvirtual Buses” and “Bus-Capable Blocks” for more information.

You can use an array of buses as an input signal to a Zero-Order Hold block. For details about defining and using an array of buses, see “Group Nonvirtual Buses in Arrays of Buses”.

Comparison with Similar Blocks

The Memory, Unit Delay, and Zero-Order Hold blocks provide similar functionality but have different capabilities. Also, the purpose of each block is different.

This table shows recommended usage for each block.

| Block | Purpose of the Block | Reference Examples |
|------------|---|---|
| Unit Delay | Implement a delay using a discrete sample time that you specify. The block accepts and outputs signals with a discrete sample time. | <ul style="list-style-type: none"> “Engine Timing Model with Closed Loop Control” on page 13-140 (Compression subsystem) |

| Block | Purpose of the Block | Reference Examples |
|-----------------------|--|--|
| Memory on page 1-1086 | Implement a delay by one major integration time step. Ideally, the block accepts continuous (or fixed in minor time step) signals and outputs a signal that is fixed in minor time step. | <ul style="list-style-type: none"> • “Building a Clutch Lock-Up Model” on page 13-144 (Friction Mode Logic/Lockup FSM subsystem) • “Capture the Velocity of a Bouncing Ball with the Memory Block” on page 12-85 |
| Zero-Order Hold | Convert an input signal with a continuous sample time to an output signal with a discrete sample time. | <ul style="list-style-type: none"> • “Developing the Apollo Lunar Module Digital Autopilot” on page 13-203 • “Radar Tracking Using MATLAB Function Block” on page 13-227 |

Each block has the following capabilities.

| Capability | Memory | Unit Delay | Zero-Order Hold |
|------------------------------------|--|------------|--|
| Specification of initial condition | Yes | Yes | No, because the block output at time $t = 0$ must match the input value. |
| Specification of sample time | No, because the block can only inherit sample time from the driving block or the solver used for the entire model. | Yes | Yes |
| Support for frame-based signals | No | Yes | Yes |
| Support for state logging | No | Yes | No |

Ports

Input

Port_1 – Input signal

scalar | vector

Input signal that the block holds by one sample period.

Data Types: single | double | int8 | int16 | int32 | int64 | uint8 | uint16 | uint32 | uint64 | Boolean | fixed point | enumerated | bus

Output

Port_1 – Output signal

scalar | vector

Output signal that is the input held by one sample period.

Data Types: single | double | int8 | int16 | int32 | int64 | uint8 | uint16 | uint32 | uint64 | Boolean | fixed point | enumerated | bus

Parameters

Sample time (-1 for inherited) — Discrete interval between sample time hits

-1 (default) | scalar

Specify the time interval between samples. To inherit the sample time, set this parameter to -1. See “Specify Sample Time” in the online documentation for more information.

Do not specify a continuous sample time, either 0 or [0, 0]. This block supports only discrete sample times. When this parameter is -1, the inherited sample time must be discrete and not continuous.

Block Characteristics

| | |
|---------------------------------|--|
| Data Types | Boolean bus double enumerated fixed point integer single |
| Direct Feedthrough | yes |
| Multidimensional Signals | no |
| Variable-Size Signals | no |
| Zero-Crossing Detection | no |

Extended Capabilities

C/C++ Code Generation

Generate C and C++ code using Simulink® Coder™.

Generated code relies on memcpy or memset functions (strong.h) under certain conditions.

HDL Code Generation

Generate Verilog and VHDL code for FPGA and ASIC designs using HDL Coder™.

HDL Coder provides additional configuration options that affect HDL implementation and synthesized logic.

HDL Architecture

This block has a single, default HDL architecture.

HDL Block Properties

| | |
|----------------------------------|--|
| ConstrainedOutputPipeline | Number of registers to place at the outputs by moving existing delays within your design. Distributed pipelining does not redistribute these registers. The default is 0. For more details, see “ConstrainedOutputPipeline” (HDL Coder). |
| InputPipeline | Number of input pipeline stages to insert in the generated code. Distributed pipelining and constrained output pipelining can move these registers. The default is 0. For more details, see “InputPipeline” (HDL Coder). |

| | |
|-----------------------|--|
| OutputPipeline | Number of output pipeline stages to insert in the generated code. Distributed pipelining and constrained output pipelining can move these registers. The default is 0. For more details, see “OutputPipeline” (HDL Coder). |
|-----------------------|--|

Complex Data Support

This block supports code generation for complex signals.

PLC Code Generation

Generate Structured Text code using Simulink® PLC Coder™.

Fixed-Point Conversion

Design and simulate fixed-point systems using Fixed-Point Designer™.

See Also

Memory | Unit Delay

Introduced before R2006a

Zero-Pole

Model system by zero-pole-gain transfer function

Library: Simulink / Continuous

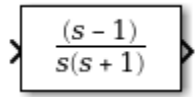

Description

The Zero-Pole block models a system that you define with the zeros, poles, and gain of a Laplace-domain transfer function. This block can model single-input single-output (SISO) and single-input multiple-output (SIMO) systems.

Conditions for Using This Block

The Zero-Pole block assumes the following conditions:

- The transfer function has the form

$$H(s) = K \frac{Z(s)}{P(s)} = K \frac{(s - Z(1))(s - Z(2)) \dots (s - Z(m))}{(s - P(1))(s - P(2)) \dots (s - P(n))},$$

where Z represents the zeros, P the poles, and K the gain of the transfer function.

- The number of poles must be greater than or equal to the number of zeros.
- If the poles and zeros are complex, they must be complex-conjugate pairs.
- For a multiple-output system, all transfer functions must have the same poles. The zeros can differ in value, but the number of zeros for each transfer function must be the same.

Note You cannot use a Zero-Pole block to model a multiple-output system when the transfer functions have a differing number of zeros or a single zero each. Use multiple Zero-Pole blocks to model such systems.

Modeling a Single-Output System

For a single-output system, the input and the output of the block are scalar time-domain signals. To model this system:

- 1 Enter a vector for the zeros of the transfer function in the **Zeros** field.
- 2 Enter a vector for the poles of the transfer function in the **Poles** field.
- 3 Enter a 1-by-1 vector for the gain of the transfer function in the **Gain** field.

Modeling a Multiple-Output System

For a multiple-output system, the block input is a scalar and the output is a vector, where each element is an output of the system. To model this system:

- 1 Enter a matrix of zeros in the **Zeros** field.

Each *column* of this matrix contains the zeros of a transfer function that relates the system input to one of the outputs.

- 2 Enter a vector for the poles common to all transfer functions of the system in the **Poles** field.
- 3 Enter a vector of gains in the **Gain** field.

Each element is the gain of the corresponding transfer function in **Zeros**.

Each element of the output vector corresponds to a column in **Zeros**.

Transfer Function Display on the Block

The Zero-Pole block displays the transfer function depending on how you specify the zero, pole, and gain parameters.

- If you specify each parameter as an expression or a vector, the block shows the transfer function with the specified zeros, poles, and gain. If you specify a variable in parentheses, the block evaluates the variable.

For example, if you specify **Zeros** as [3,2,1], **Poles** as (poles), where poles is [7,5,3,1], and **Gain** as gain, the block looks like this.

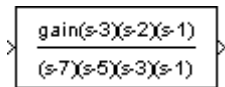

$$\frac{\text{gain}(s-3)(s-2)(s-1)}{(s-7)(s-5)(s-3)(s-1)}$$

- If you specify each parameter as a variable, the block shows the variable name followed by (s) if appropriate.

For example, if you specify **Zeros** as zeros, **Poles** as poles, and **Gain** as gain, the block looks like this.

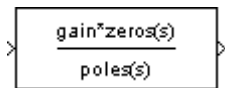

$$\frac{\text{gain}^*\text{zeros}(s)}{\text{poles}(s)}$$

Ports

Input

Port_1 – Input signal

scalar

Input signal, specified as a scalar with data type double.

Data Types: double

Output

Port_1 – Output signal

scalar | vector

System modeled by a zero-pole gain transfer function, provided as a scalar or vector signal with data type double.

- When modeling a single-output system, the block outputs a scalar time-domain signal. For more information, see “Modeling a Single-Output System” on page 1-2033.

- When modeling a multiple-output system, the block outputs a vector, where each element is an output of the system. For more information, see “Modeling a Multiple-Output System” on page 1-2033.

Data Types: double

Parameters

Zeros — Matrix of zeros

[1] (default) | vector | matrix

Define the matrix of zeros.

- For a single-output system, enter a vector for the zeros of the transfer function.
- For a multiple-output system, enter a matrix. Each *column* of this matrix contains the zeros of a transfer function that relates the system input to one of the outputs.

Programmatic Use

Block Parameter: Zeros

Type: character vector, string

Value: vector | matrix

Default: ' [1] '

Poles — Vector of poles

[0 -1] (default) | vector

Define the vector of poles.

- For a single-output system, enter a vector for the poles of the transfer function.
- For a multiple-output system, enter a vector for the poles common to all transfer functions of the system.

Programmatic Use

Block Parameter: Poles

Type: character vector, string

Value: vector

Default: ' [0 -1] '

Gain — Vector of gains

[1] (default) | vector

Define the vector of gains.

- For a single-output system, enter a 1-by-1 vector for the gain of the transfer function.
- For a multiple-output system, enter a vector of gains. Each element is the gain of the corresponding transfer function in **Zeros**.

Programmatic Use

Block Parameter: Gain

Type: character vector, string

Value: vector

Default: ' [1] '

Parameter tunability — Tunable representation of block parameters in code

Auto (default) | Optimized | Unconstrained

Tunability level of the zeros, poles, and gains for accelerated simulation modes and simulations deployed using Simulink Compiler. Set this parameter to Auto to allow Simulink to choose the appropriate level of parameter tunability.

Set this parameter to Optimized to generate an optimized representation zeros, poles, and gain in generated code for accelerated and deployed simulations.

Set this parameter to Unconstrained to support full tunability (between simulations) of zeros, poles, and gain parameters in accelerated and deployed simulations.

Programmatic Use**Block Parameter:** ParameterTunability**Type:** character vector, string**Values:** 'Auto' | 'Optimized' | 'Unconstrained'**Default:** 'Auto'**Absolute tolerance — Absolute tolerance for computing block states**

auto (default) | scalar | vector

Absolute tolerance for computing block states, specified as a positive, real-valued, scalar or vector. To inherit the absolute tolerance from the Configuration Parameters, specify auto or -1.

- If you enter a real scalar, then that value overrides the absolute tolerance in the Configuration Parameters dialog box for computing all block states.
- If you enter a real vector, then the dimension of that vector must match the dimension of the continuous states in the block. These values override the absolute tolerance in the Configuration Parameters dialog box.
- If you enter auto or -1, then Simulink uses the absolute tolerance value in the Configuration Parameters dialog box (see “Solver Pane”) to compute block states.

Programmatic Use**Block Parameter:** AbsoluteTolerance**Type:** character vector, string**Values:** 'auto' | '-1' | any positive real-valued scalar or vector**Default:** 'auto'**State Name (e.g., 'position') — Assign unique name to each state**

' ' (default) | 'position' | {'a', 'b', 'c'} | a | ...

Assign a unique name to each state. If this field is blank (' '), no name assignment occurs.

- To assign a name to a single state, enter the name between quotes, for example, 'position'.
- To assign names to multiple states, enter a comma-delimited list surrounded by braces, for example, {'a', 'b', 'c'}. Each name must be unique.
- To assign state names with a variable in the MATLAB workspace, enter the variable without quotes. A variable can be a character vector, string, cell array, or structure.

Limitations

- The state names apply only to the selected block.

- The number of states must divide evenly among the number of state names.
- You can specify fewer names than states, but you cannot specify more names than states.

For example, you can specify two names in a system with four states. The first name applies to the first two states and the second name to the last two states.

Programmatic Use

Block Parameter: ContinuousStateAttributes

Type: character vector, string

Values: ' ' | user-defined

Default: ' '

Block Characteristics

| | |
|---------------------------------|--------|
| Data Types | double |
| Direct Feedthrough | yes |
| Multidimensional Signals | no |
| Variable-Size Signals | no |
| Zero-Crossing Detection | no |

Extended Capabilities

C/C++ Code Generation

Generate C and C++ code using Simulink® Coder™.

Not recommended for production-quality code. Relates to resource limits and restrictions on speed and memory often found in embedded systems. The code generated can contain dynamic allocation and freeing of memory, recursion, additional memory overhead, and widely-varying execution times. While the code is functionally valid and generally acceptable in resource-rich environments, smaller embedded targets often cannot support such code.

In general, consider using the Simulink Model Discretizer to map continuous blocks into discrete equivalents that support production code generation. To start the Model Discretizer, in the Simulink Editor, on the **Apps** tab, under **Apps**, under **Control Systems**, click **Model Discretizer**. One exception is the Second-Order Integrator block because, for this block, the Model Discretizer produces an approximate discretization.

See Also

Discrete Zero-Pole

Topics

“State”

Introduced before R2006a

Functions

add_block

Add block to model

Syntax

```
h = add_block(source,dest)
h = add_block(source,dest,'MakeNameUnique','on')
h = add_block(____,'CopyOption','nolink')
h = add_block(sourceIn,destIn,'CopyOption','duplicate')
h = (____,Name,Value)
```

Description

`h = add_block(source,dest)` adds a copy of the block `source` from a library or model to the specified destination model and block name. This syntax creates the block at the same location as it appears in the model or the library model.

If you are copying between models or from a library, load the destination model first.

`h = add_block(source,dest,'MakeNameUnique','on')` ensures that the destination block name is unique in the model. This syntax adds a number to the destination block name if a block with that name exists, incrementing to ensure a unique name.

`h = add_block(____,'CopyOption','nolink')` copies the block or subsystem `source` from a library without creating a link to the library block.

`h = add_block(sourceIn,destIn,'CopyOption','duplicate')` duplicates an inport block in a subsystem, giving the destination block the same port number as the source block. Duplicate an inport to branch a signal from an input port without creating a port or adding lines. For more information, see “Creating Duplicate Inport Blocks” on page 1-775.

`h = (____,Name,Value)` uses optional `Name,Value` arguments.

Specify optional comma-separated pairs of `Name,Value` arguments. `Name` is the argument name and `Value` is the corresponding value. `Name` must appear inside quotes. You can specify several name and value pair arguments in any order as `Name1,Value1,...,NameN,ValueN`.

With the `add_block` function, you can use block parameter and value pairs. For a list of all the block parameters, see “Common Block Properties” on page 6-12 and “Block-Specific Parameters” on page 6-26.

Examples

Add Block to Model from a Library

Add the block from the Simulink library to the model `f14`.

Load or open the destination model.

```
open_system('f14');
```

Add the Scope block from the Simulink Sinks library to f14, naming the new block MyScope.

```
add_block('simulink/Sinks/Scope','f14/MyScope');
```

Add a Block from Another Model

Add a copy of a block from the model f14 to vdp.

Load or open the destination model.

```
open_system('vdp');
```

Add the Actuator Model block from f14 to vdp.

```
add_block('f14/Actuator Model','vdp/Actuator Model');
```

Add a Block Using a Unique Name

Add the block from the Simulink library to the model vdp. Because there is already a block named Scope in vdp, use the MakeNameUnique option to ensure that the new block name is unique.

Load or open the destination model.

```
open_system('vdp');
```

Add the Scope block from the Simulink Sinks library to vdp, ensuring that the name is unique.

```
add_block('simulink/Sinks/Scope','vdp/Scope','MakeNameUnique','on')
```

Duplicate an Inport Block in a Subsystem

Add an inport block in the f14/Controller subsystem that uses the same port number as another inport in that subsystem.

Duplicate the Stick Input (in) block in the Controller subsystem, naming the copy Stick Input (in)2. The resulting block uses the same port number as Stick Input (in) but does not add an inport on the parent subsystem. The signal that enters that port branches to both inports.

```
add_block('f14/Controller/Stick Input (in)',...  
'f14/Controller/Stick Input (in)2','CopyOption','duplicate')
```

Add a Block and Set Parameters

Add a block from a library to a model and set parameters using a Name, Value pair.

Load or open the destination model.

```
open_system('vdp');
```

Add a Gain block from the library to vdp, and set the Gain value to 5.

```
add_block('simulink/Math Operations/Gain','vdp/Five','Gain','5')
```

Input Arguments

source — Block to copy to model

block path | library block path

Block to copy to model, specified as:

- The full block path if you are copying the block from another model, for example, 'vdp/Mu'. This usage copies the block and its settings.
- The library block path if you want to add a block from a library, for example, 'simulink/Math Operations/Gain'.

To get the library block path, you can hover over the block in the Library Browser. Alternatively, you can open the library model, select the block, and enter `gcb` at the command line. To open the library model, in the Library Browser, right-click the library name in the library list and select **Open *Library_name* library**.

You can also use the syntax '`built-in/blocktype`' as the source block path, where *blocktype* is the programmatic block name—the value of the `BlockType` parameter (see “Common Block Properties” on page 6-12). However, blocks added using '`built-in/blocktype`' sometimes have different default parameter values from library blocks.

For subsystems and masked blocks, use the library block path. Using the `BlockType` value (`SubSystem`) creates an empty subsystem.

Example: 'vdp/Mu', 'simulink/Sinks/Scope'

dest — Name and location of new block

block path

Name and location of the new block in the model, specified as the block path.

Example: 'f14/Controller/MyNewBlock'

sourceIn — Inport block whose port number to copy

block path

Inport block whose port number to copy, specified as the block path.

Example: 'f14/Controller/Stick Input (in)', 'myModel/mySubsystem/In1'

destIn — Inport block to create

block path

Inport block with duplicate port number to create, specified as the block path. Create the destination block in the same system as the source block.

Example: 'myModel/mySubsystem/DupPortIn'

Output Arguments

h — New block

handle

New block, returned as a handle.

See Also

`delete_block`

Topics

“Create and Edit Annotations Programmatically”

Introduced before R2006a

add_exec_event_listener

Register listener for block method execution event

Syntax

```
h = add_exec_event_listener(blk,event,listener);
```

Description

`h = add_exec_event_listener(blk,event,listener)` registers a listener for a block method execution event where the listener is a MATLAB program that performs some task, such as logging runtime data for a block, when the event occurs (see “Listen for Method Execution Events”). Simulink software invokes the registered listener whenever the specified event occurs during simulation of the model. You cannot register a listener for virtual blocks.

Note Simulink software can register a listener only while a simulation is running. Invoking this function when no simulation is running results in an error message. To ensure that a listener catches all relevant events triggered by a model's simulation, you should register the listener in the model's `StartFcn` callback function (see “Callbacks for Customized Model Behavior”).

Input Arguments

`blk`

Specifies the block whose method execution event the listener is intended to handle. May be one of the following:

- Full pathname of a block
- A block handle
- A block runtime object (see “Access Block Data During Simulation”).

`event`

Specifies the type of event for which the listener listens. It may be any of the following:

| Event | Occurs... |
|-------------------|--|
| 'PreDerivatives' | Before a block's Derivatives method executes |
| 'PostDerivatives' | After a block's Derivatives method executes |
| 'PreOutputs' | Before a block's Outputs method executes. |
| 'PostOutputs' | After a block's Outputs method executes |
| 'PreUpdate' | Before a block's Update method executes |
| 'PostUpdate' | After a block's Update method executes |

`listener`

Specifies the listener to be registered. It may be either a character vector specifying a MATLAB expression, e.g., `'disp(''here'')` or a handle to a MATLAB function that accepts two

arguments. The first argument is the block runtime object of the block that triggered the event. The second argument is an instance of `EventData` class that specifies the runtime object and the name of the event that just occurred.

Output Arguments

`add_exec_event_listener` returns a handle to the listener that it registered. To stop listening for an event, use the MATLAB `clear` command to clear the listener handle from the workspace in which the listener was registered.

Introduced before R2006a

add_line

Add line to Simulink model

Syntax

```
h = add_line(sys,out,in)
h = add_line(sys,out,in,'autorouting',autoOption)
h = add_line(sys,points)
```

Description

`h = add_line(sys,out,in)` adds a line in the model or subsystem `sys` that connects one block's output port `out` to another block's input port `in`. This syntax draws the most direct route from port to port, for example, diagonal lines or lines that go through other blocks.

You can connect ports when:

- The input port does not already have a connection.
- The blocks are compatible for connecting.

`h = add_line(sys,out,in,'autorouting',autoOption)` connects blocks, specifying whether to route the lines around other blocks.

`h = add_line(sys,points)` adds a line drawn by (x,y) coordinate `points` relative to the upper-left corner of the Simulink Editor canvas before any canvas resizing. If either end of the line is within five pixels of a corresponding port, the function connects the line to it. The line can have multiple segments.

Examples

Connect Blocks Using Port Numbers

Use the block port numbers to add a line to connect blocks.

Create a model and open it.

```
open_system(new_system('connect_model'));
```

Add and position a Constant block and a Gain block.

```
add_block('simulink/Commonly Used Blocks/Constant','connect_model/Constant');
set_param('connect_model/Constant','position',[140,80,180,120]);
add_block('simulink/Commonly Used Blocks/Gain','connect_model/Gain');
set_param('connect_model/Gain','position',[220,80,260,120]);
```

Connect the blocks. Each block has one port, so specify port 1.

```
add_line('connect_model','Constant/1','Gain/1');
```

Connect Blocks Using Port Handles

Get the port handles and connect the ports using `add_line`.

Open the model `vdp`.

```
open_system('vdp');
```

Delete the line that connects the Mu gain block to the Sum block.

```
delete_line('vdp','Mu/1','Sum/2');
```

Get the port handles from the Mu block and the Sum block.

```
h = get_param('vdp/Mu','PortHandles');
h1 = get_param('vdp/Sum','PortHandles');
```

Look at the `h1` structure. Notice the two handles for the `Inport` property.

```
h1
```

```
h1 =
```

```
struct with fields:
    Inport: [47.0002 54.0002]
    Output: 39.0002
    Enable: []
    Trigger: []
    State: []
    LConn: []
    RConn: []
    Ifaction: []
    Reset: []
```

Index into the `Outputport` and `Inport` properties on the port handles to get the handles you want and connect them. Connect to the second inport.

```
add_line('vdp',h.Outputport(1),h1.Inport(2));
```

Add a Branched Line

You can branch a line by adding a connection programmatically. You can use the `points` syntax to draw the segment, or you can draw the line by specifying the ports to connect. When using the port, use automatic line routing to improve the look of the branched line.

Add a scope to the `vdp` model above the output.

```
vdp
add_block('simulink/Commonly Used Blocks/Scope','vdp/Scope1');
set_param('vdp/Scope1','position',[470,70,500,110]);
```

Connect the Integrator block `x1` to `Scope1`. This code branches the existing line from the `x1` output and connects it to the scope. With autorouting on, the resulting line is segmented.

```
add_line('vdp', 'x1/1', 'Scope1/1', 'autorouting', 'on')
```

Connect Blocks Using Points

You can use points on the canvas as the start and end of each segment. Get the port locations using `get_param` with the 'PortConnectivity' option.

Open the model `vdp` and delete the line that connects the Mu and Sum blocks.

```
vdp
delete_line('vdp', 'Mu/1', 'Sum/2')
```

Get the port locations for Mu. Mu has two ports. The first is the input port, and the second is the output port.

```
mu = get_param('vdp/Mu', 'PortConnectivity');
mu.Position
```

```
ans =
    190    150
```

```
ans =
    225    150
```

Get the port locations for Sum, which has three ports. The second position is the lower input port.

```
s = get_param('vdp/Sum', 'PortConnectivity');
s.Position
```

```
ans =
    250    135
```

```
ans =
    250    150
```

```
ans =
    285    145
```

Connect the ports using the output and input points.

```
add_line('vdp', [225 150; 250 150])
```

Connect Blocks Using Autorouting Options

This example shows the effect of adding lines with and without autorouting options.

Create a model route. Display default block names.

```
open_system(new_system('route'));
set_param('route','HideAutomaticNames','off')
```

Add blocks as shown. Add an inport and outport to each subsystem.



Add lines to connect the outputs from Subsystem to the inputs of Subsystem1.

```
add_line('route',{'Subsystem/1','Subsystem/2'},...
        {'Subsystem1/1','Subsystem1/2'})
```

Because you did not use the autorouting options, the function draws straight lines, which pass through the Gain block.

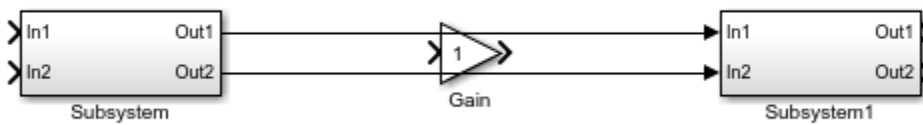

Delete the lines. Add lines again, this time using the autorouting option set to 'on'.

```
add_line('route',{'Subsystem/1','Subsystem/2'},...
        {'Subsystem1/1','Subsystem1/2'},'autorouting','on')
```

The lines route around the Gain block.

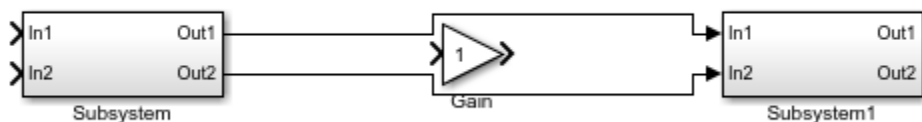

Delete the lines. Add lines again, using the smart autorouting option. When you use an array to connect two sets of inports and outports, 'smart' autorouting routes them together if doing so makes better use of the space.

```
add_line('route',{'Subsystem/1','Subsystem/2'},...
        {'Subsystem1/1','Subsystem1/2'},'autorouting','smart')
```

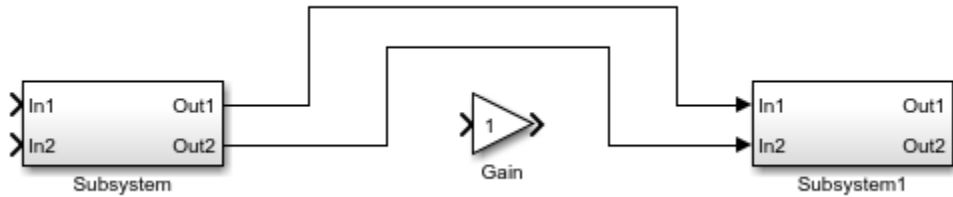

Input Arguments

sys – Model or subsystem to add line to

character vector

Model or subsystem to add the line to, specified as character vector.

Example: 'vdp', 'f14/Controller'

out – Block output port to connect line from

block/port name or number character vector | port handle | array of port designators

Block output port to connect line from, specified as:

- The block name, a slash, and the port name or number. Most block ports are numbered from top to bottom or from left to right. For a state port, use the port name State instead of a port number.
- The port handle that you want to connect from.
- An array of either of these port designators.

Use 'PortHandles' with `get_param` to get the handles.

Example: 'Mu/1', 'Subsystem/2', h.Outputport(1){'Subsystem/1', 'Subsystem/2'}

in – Block input port to connect line to

block/port name or number character vector | port handle | array of port designators

Block input port to connect line to, specified as:

- The block name, a slash, and the port name or number. The port name on:
 - An enabled subsystem is Enable.
 - A triggered subsystem is Trigger.
 - If Action and Switch Case Action subsystems is Action.
- The port handle that you want to add the line to.
- An array of either of these port designators.

Use the 'PortHandles' option with `get_param` to get handles.

Example: 'Mu/1', 'Subsystem/2', h.Inport(1), {'Subsystem/1', 'Subsystem/2'}

autoOption – Type of automatic line routing

'off' (default) | 'on' | 'smart'

Type of automatic line routing around other blocks, specified as:

- 'off' for no automatic line routing
- 'on' for automatic line routing
- 'smart' for automatic line routing that takes the best advantage of the blank spaces on the canvas and avoids overlapping other lines and labels

points — Points of the line to draw

matrix

Points of the line to draw, specified as at least a 2-by-2 matrix. Add a row for every segment you want to draw. Specify points as (x,y) coordinates from the upper-left corner of the Editor before any canvas resizing.

Example: [100 300; 200 300; 200 300; 200 500]

Output Arguments**h — Line**

handle

Line created by add_line, returned as a handle.

See Also

delete_line | add_block | delete_block | set_param | get_param

Topics

“Create an Enabled Subsystem”

“Create a Triggered Subsystem”

Introduced before R2006a

add_param

Add parameter to Simulink system

Syntax

```
add_param(sys,param1,val1,...,paramN,valN)
```

Description

`add_param(sys,param1,val1,...,paramN,valN)` adds the specified parameters to the specified system and initializes the parameters to the specified values. The parameters are saved in the corresponding SLX or MDL file. You can use the `set_param` and `get_param` functions on the parameters.

Examples

Add Parameters and Values to System

Add the parameters `DemoName` and `EquationOrder` to the `vdp` model with the values `'VanDerPolEquation'` and `'2'`, respectively.

```
add_param('vdp','DemoName','VanDerPolEquation','EquationOrder','2')
```

Use the `get_param` function to query the values of the new parameters.

```
get_param('vdp','DemoName')
```

```
ans =
```

```
    'VanDerPolEquation'
```

Input Arguments

sys — System name or handle

character vector | string scalar | numeric scalar

System name or handle, specified as a character vector, string scalar, or numeric scalar. The system must be an SLX or MDL file.

Data Types: double | char | string

paramN — Name of parameter

character vector | string scalar

Name of parameter, specified as a character vector or string scalar.

Parameter names are case insensitive. For example, `'ParameterName'` is equivalent to `'parametername'`.

You cannot add a parameter that has the same name as an existing parameter of the system.

Dependencies

To use this parameter, specify a corresponding `val1` argument.

Data Types: `char` | `string`

valN — Initial value of parameter

`character vector` | `string scalar`

Initial value of parameter, specified as a character vector or string scalar.

Values are case sensitive.

Dependencies

To use this parameter, specify a corresponding `param1` argument.

Data Types: `char` | `string`

See Also

`delete_param` | `get_param` | `set_param`

Introduced before R2006a

addterms

Add terminators to unconnected ports in model

Syntax

```
addterms('sys')
```

Description

`addterms('sys')` adds Terminator and Ground blocks to the unconnected ports in the Simulink block diagram `sys`.

See Also

`upgradeadvisor`

Introduced before R2006a

attachConfigSet

Associate configuration set or configuration reference with model

Syntax

```
attachConfigSet(model, configObj)
attachConfigSet(model, configObj, allowRename)
```

Description

`attachConfigSet(model, configObj)` associates the configuration set or configuration reference `configObj` with `model`.

`attachConfigSet(model, configObj, allowRename)` associates the configuration set to the model and determines how Simulink handles a name conflict between `configObj` and any configuration objects that are already attached to the model.

If `allowRename` is `false` and the configuration object specified by `configObj` has the same name as a configuration object already attached to `model`, Simulink generates an error. If `allowRename` is `true` and a name conflict occurs, Simulink provides a unique name for `configObj` before associating it with the model.

Examples

Create and Attach a Configuration Set

Create a configuration set and attach it to a model.

Open the model `sldemo_fuelsys`.

```
sldemo_fuelsys
```

Create a configuration set named `Config1` and attach it to the model.

```
configObj = Simulink.ConfigSet;
set_param(configObj, 'Name', 'Config1')
attachConfigSet('sldemo_fuelsys', configObj)
```

To use the configuration set for the model, activate it.

Attach and Rename a Configuration Set

Attach a configuration set to a model that already has a configuration set with the same name.

Open the model `sldemo_fuelsys`. The model uses a configuration set with the default name `Configuration`.

```
sldemo_fuelsys
```

Create another configuration set and name it Configuration.

```
configObj = Simulink.ConfigSet;  
set_param(configObj, 'Name', 'Configuration')
```

Attach the configuration to the model. Specify `allowRename` as `true`.

```
attachConfigSet('sldemo_fuelsys', configObj, true)
```

Because the model already has a configuration set named `Configuration`, Simulink changes the name of `configObj` to `Configuration1` before attaching it to the model.

To use the configuration for the model, activate `Configuration1`.

Input Arguments

model — Model to attach configuration set to

character vector | string scalar

Model to which you want to attach a configuration set, specified as a character vector or string scalar. The model must be open.

Example: 'my_model'

configObj — Configuration object

ConfigSet object | ConfigSetRef object

Configuration object that you want to attach to the model, specified as a `ConfigSet` object or a `Simulink.ConfigSetRef` object.

Example: `myConfigObj`

allowRename — Rename configuration object if there is a naming conflict

false (default) | true

Specification that determines if Simulink renames the configuration object in the case of a name conflict, specified as a Boolean. If `allowRename` is `false` and a name conflict occurs, Simulink generates an error. You cannot attach a configuration object to a model if the configuration object is already attached to another model.

Example: `true`

See Also

`setActiveConfigSet` | `getConfigSet` | `getConfigSets` | `attachConfigSetCopy` | `detachConfigSet`

Topics

“Manage Configuration Sets for a Model”

“Share a Configuration with Multiple Models”

Introduced before R2006a

attachConfigSetCopy

Copy configuration set or configuration reference and associate it with model

Syntax

```
configObjCopy = attachConfigSetCopy(model, configObj)
attachConfigSetCopy(model, configObj, allowRename)
```

Description

`configObjCopy = attachConfigSetCopy(model, configObj)` creates a copy of the configuration set or configuration reference `configObj` and associates it with `model`. The function returns the copy of the configuration as a `Simulink.ConfigSet` object or a `Simulink.ConfigSetRef` object.

`attachConfigSetCopy(model, configObj, allowRename)` associates the configuration copy with the model and determines how Simulink handles a name conflict between the configuration and any configuration objects that are already attached to the model.

If `allowRename` is `false` and the configuration object specified by `configObj` has the same name as a configuration object already attached to `model`, Simulink generates an error. If `allowRename` is `true` and a name conflict occurs, Simulink provides a unique name for the copy of `configObj` before associating it with the model.

Examples

Copy Configuration From One Model to Another Model

This example shows to create a copy of the active configuration for the model `sldemo_bounce` and attach the copy to the model `sldemo_boiler`.

Open the model `sldemo_bounce` and get the active configuration object.

```
sldemo_bounce
slbounceConfigObj = getActiveConfigSet('sldemo_bounce');
```

Each model has a configuration with the default name `Configuration`. To avoid a naming conflict when you attach the configuration copy to `sldemo_boiler`, name the configuration `slbounceConfig`.

```
set_param(slbounceConfigObj, 'Name', 'slbounceConfig');
```

Open the model `sldemo_boiler`. Copy the configuration object `slbounceConfigObj` and attach it to `sldemo_boiler`.

```
sldemo_boiler
attachConfigSetCopy('sldemo_boiler', slbounceConfigObj);
```

To use the configuration in `sldemo_boiler`, activate it.

Copy and Rename Configuration Set

This example shows to create a copy of the active configuration for the model `sldemo_bounce` and attach the copy to the model `sldemo_boiler`. Use the `allowRename` argument to avoid naming conflicts.

Open the model `sldemo_bounce` and get the active configuration object.

```
sldemo_bounce
slbounceConfigObj = getActiveConfigSet('sldemo_bounce');
```

Open the model `sldemo_boiler`. Copy the configuration object `slbounceConfigObj` and attach it to `sldemo_boiler`. Specify `allowRename` as `true`.

```
sldemo_boiler
attachConfigSetCopy('sldemo_boiler',slbounceConfigObj,true);
```

Because the model already has a configuration set named `Configuration`, Simulink® changes the name of `slbounceConfigObj` to `Configuration1` before attaching it to `sldemo_boiler`.

To use the configuration in `sldemo_bounce`, activate `Configuration1`.

Input Arguments

model — Model to attach configuration set to

character vector | string scalar

Model to which you want to attach a configuration set, specified as a character vector or string scalar. The model must be open.

Example: `'my_model'`

configObj — Configuration object

ConfigSet object | ConfigSetRef object

Configuration object that you want to copy, specified as a `Simulink.ConfigSet` object or a `Simulink.ConfigSetRef` object.

Example: `myConfigObj`

allowRename — Rename configuration object copy if there is a naming conflict

false (default) | true

Specification that determines if Simulink renames the configuration object copy in the case of a name conflict, specified as a Boolean. If `allowRename` is `false` and a name conflict occurs, Simulink generates an error.

Example: `true`

See Also

`setActiveConfigSet` | `getConfigSet` | `attachConfigSet` | `getConfigSets` | `detachConfigSet`

Topics

“Manage Configuration Sets for a Model”

“Share a Configuration with Multiple Models”

Introduced in R2006b

sltrace

Trace signals in a model

Syntax

```
g = sltrace(p)
g = sltrace(block, direction)
g = sltrace(___, Name, Value)
```

Description

`g = sltrace(p)` traces a signal oriented from the port `p` and stores the results in the `sltrace.Graph` object `g`.

`g = sltrace(block, direction)` traces a signal oriented from the `block` toward the `direction`, and stores the results in `g`. The argument `direction` includes 'source' and 'destination'.

`g = sltrace(___, Name, Value)` traces a signal using one or more `Name, Value` arguments.

Examples

Trace all sources in model

Trace from the first inport of 'vdp/Scope' to all sources.

```
vdp
g = sltrace('vdp/Scope', 'Source', 'Port', 1, 'TraceAll', 'on')
```

```
g =
```

Graph with properties:

```
SrcBlocks: [2.0001 5.0001 6.0001 7.0001 9.0001 10.0001 11.0001 12.0001 13.0001]
DstBlocks: []
TraceGraph: [1x1 digraph]
```

Trace using block path

Trace from the second inport handle of 'vdp/Sum' to Stop block 'vdp/Product' and display the results in `Simulink.BlockPath` format.

```
bPort = get_param('vdp/Sum', 'PortHandles').Inport(2);
G = sltrace(bPort, 'Stop', 'vdp/Product', 'BlockPath', 'On');
```

Input Arguments

p — Block port

port handle

Block port where tracing begins, specified as a port handle.

block — Block where tracing begins

block name | block handle | Simulink.BlockPath

Block where tracing begins, specified as a block name, block handle, or as Simulink.BlockPath object.

direction — Direction of traced signal

'Source' | 'Destination'

Direction of traced signal, specified as either 'Source' or 'Destination'.

Data Types: char | string

Name-Value Pair Arguments

Specify optional Name, Value arguments, where Name is the argument name and Value is the corresponding value. Name must appear inside quotes. You can specify several name and value pair arguments in any order as Name1, Value1, ..., NameN, ValueN.

Example: 'TraceAll', 'on', 'BlockPath', 'on'

TraceAll — Trace to all sources and destinations

off (default) | on

Trace to all sources or destinations, specified as 'off' or 'on'. By default, tracing stops at the first non-virtual block. Set this argument to 'on' to trace to all sources or destinations.

Example: 'TraceAll', 'on'

Stop — Block where tracing stops

block name | block handle | Simulink.BlockPath

Block where tracing stops, specified as a block name, block handle, or as Simulink.BlockPath object. If the block where tracing stops is not on the tracing path, sltrace traces to all blocks.

Example: 'Stop', 'vdp/Sum'

Port — Port where tracing begins

real positive scalar

Port where tracing begins, specified as a real positive scalar. When tracing from a block with multiple inports or outports, you can enable the 'Port' option to select a specific port to trace from. Without enabling 'Port', sltrace will trace from all inports or outports. You can omit 'Port' when tracing from a block port handle.

Example: 'Port', '2'

Data Types: `double` | `single`

Element — Bus element where tracing begins

bus element name

Bus element where tracing begins. `sltrace` supports tracing to the source from a Bus Creator block and tracing to a destination from a Bus Selector block. You do not need to specify this parameter if tracing from block port handle `p`.

Example: `'Element', 'b'`

Data Types: `char` | `string`

BlockPath — Option to return tracing information as `Simulink.BlockPath`

`'off'` (default) | `'on'`

Option to return tracing information as `Simulink.BlockPath` object, specified as `'off'` or `'on'`. If there are multiple instances of a referenced model, set `'BlockPath'` to `'on'` to obtain accurate tracing results for different model instances.

Output Arguments**g — Tracing results**

`sltrace.Graph` object

Tracing result, returned as a `sltrace.Graph` object.

See Also

`sltrace.Graph`

Topics

“Find Shortest Control Path in Simulink Model” on page 13-637

Introduced in R2021b

highlight

Package: Simulink

Highlight tracing results

Syntax

```
highlight(g)  
highlight(g,target)
```

Description

`highlight(g)` highlights all tracing results, blocks and lines in the `sltrace.Graph` object `g`.

`highlight(g,target)` highlights the blocks and lines specified in `target`.

Examples

Trace All Sources in Model

This example shows how to trace from the first inport of the block `vdp/x1` to all sources.

```
open_system('vdp')  
G = sltrace('vdp/x1', 'Source', 'Port', 1, 'TraceAll', 'on');
```

Highlight the tracing results and plot the trace graph.

```
highlight(G)
```

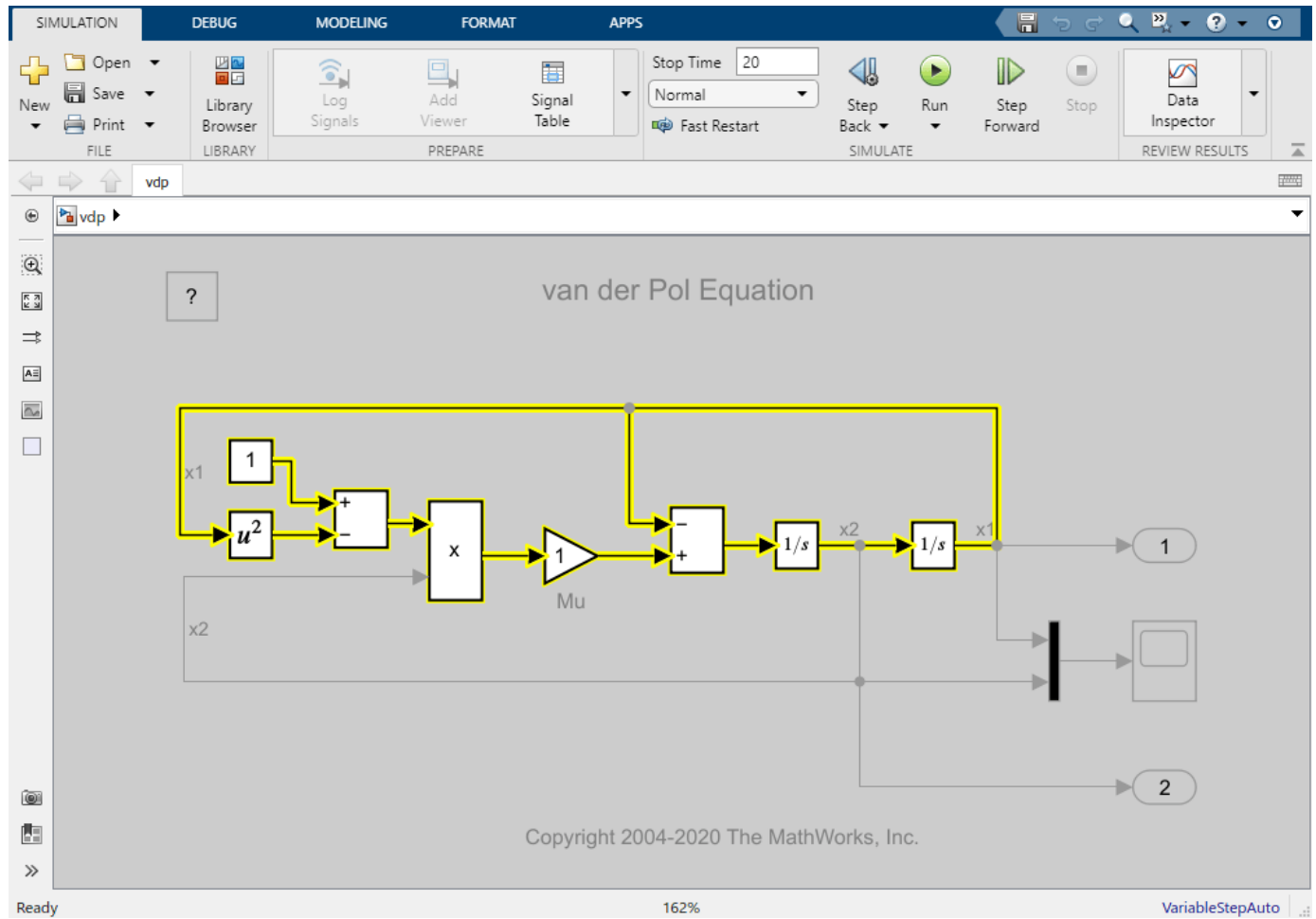

plot(G.TraceGraph)

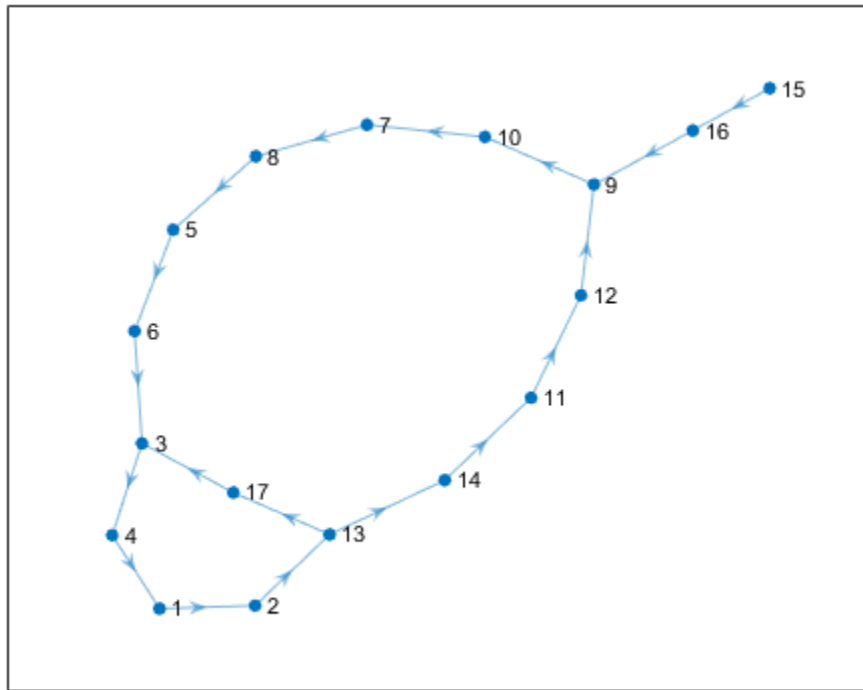

Highlight the block vdp/Scope and the line connecting to the inport of vdp/Scope.

```
bh = get_param('vdp/Scope', 'Handle');  
inportH = get_param('vdp/Scope', 'PortHandles').Inport;  
lh = get_param(inportH, 'line');  
highlight(G, [bh, lh])
```

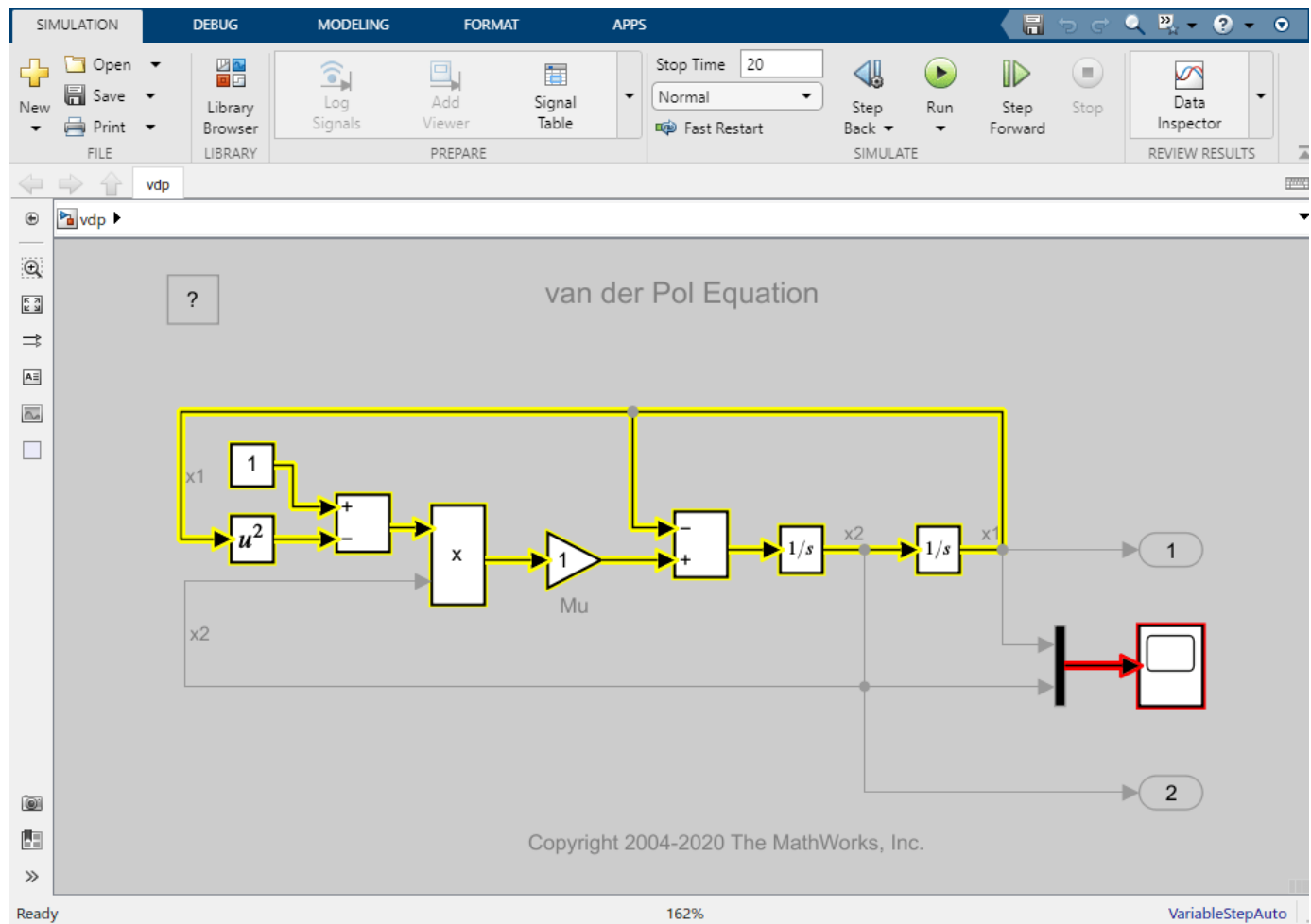

Remove the highlighting.

`removeHighlight(G)`

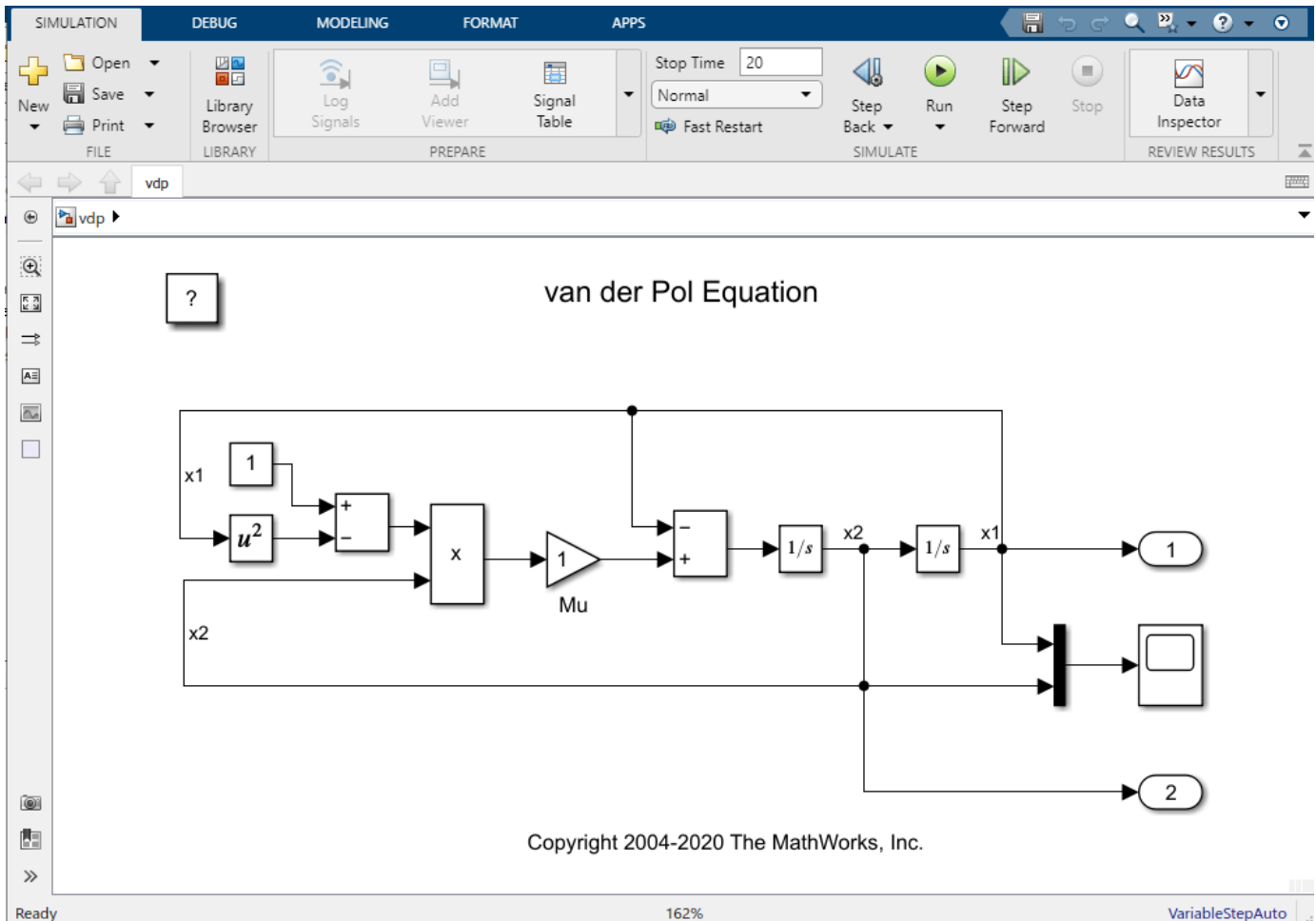

Input Arguments

g – Graph object

`sltrace.Graph` object

Graph created by `sltrace` function, specified as a `sltrace.Graph` object.

target – Items to highlight

block handle | line handle | array of block or line handles

Specific items to highlight, specified as a block handle, a line handle, or an array of block and line handles.

Example: `g.highlight([bh, seg]);`

See Also

`removeHighlight` | `sltrace.Graph` | `sltrace`

Introduced in R2021b

removeHighlight

Package: Simulink

Remove highlighted tracing results

Syntax

```
removeHighlight(g)
```

Description

`removeHighlight(g)` removes all highlighting in a model created by the `highlight` function of `sltrace.Graph` object `g`.

Examples

Trace All Sources in Model

This example shows how to trace from the first inport of the block `vdp/x1` to all sources.

```
open_system('vdp')  
G = sltrace('vdp/x1', 'Source', 'Port', 1, 'TraceAll', 'on');
```

Highlight the tracing results and plot the trace graph.

```
highlight(G)
```

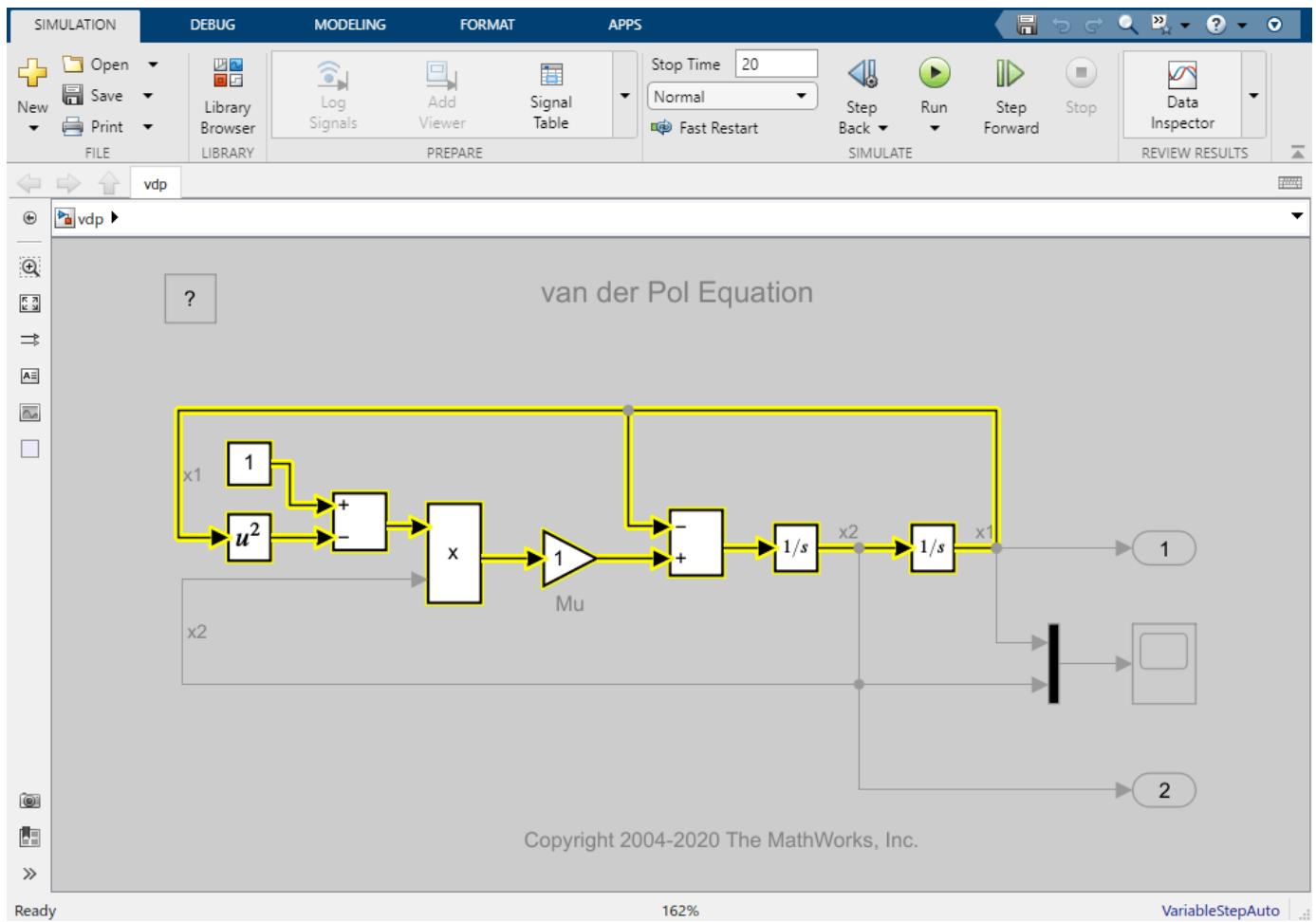

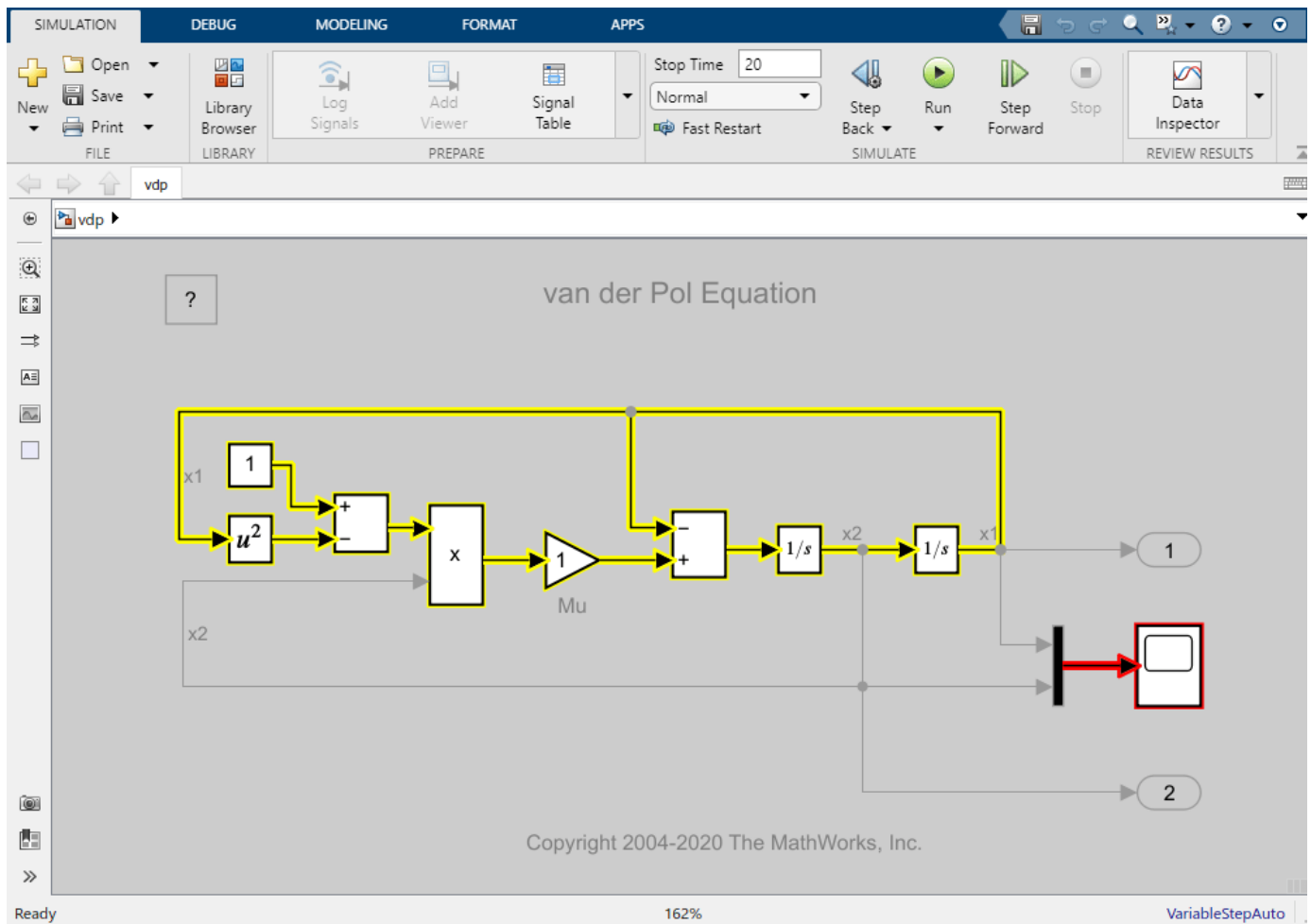

```
plot(G.TraceGraph)
```

Remove the highlighting.

removeHighlight(G)

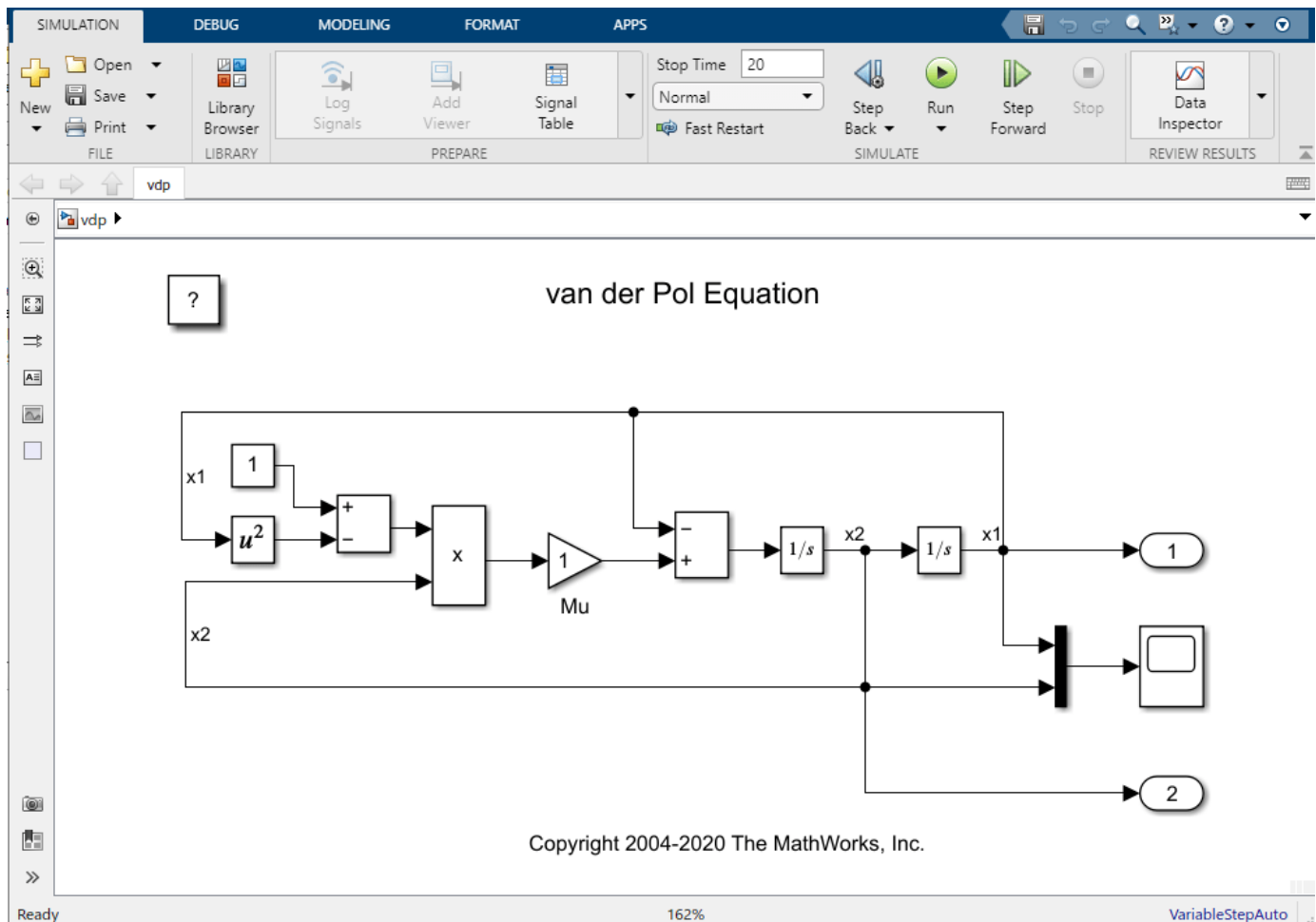

Input Arguments

g — Graph object

sltrace.Graph object

Graph created by sltrace function, specified as a sltrace.Graph object.

See Also

highlight | sltrace.Graph | sltrace

Introduced in R2021b

batchsim

Offload simulations to run on a compute cluster

Syntax

```
simJob = batchsim(in)
simJob = batchsim(myCluster,in)
simJob = batchsim(...,Name,Value)
```

Description

`simJob = batchsim(in)` runs a batch job on a single worker to simulate a model using the inputs specified in the `SimulationInput` object, `in`.

`simJob = batchsim(myCluster,in)` runs a batch job on the cluster identified by the cluster object `myCluster`. If a cluster profile is not specified, `batchsim` uses a default cluster profile as set up in the parallel preferences. For more information, see “Discover Clusters and Use Cluster Profiles” (Parallel Computing Toolbox).

`simJob = batchsim(...,Name,Value)` runs a batch job that simulates a model using the inputs specified in the `SimulationInput` object and the options specified as `Name, Value` pair.

`batchsim` offloads simulations to a compute cluster, enabling you to carry out other tasks while the batch job is processing, or close the client MATLAB and access the batch job later. Use the 'Pool' argument to run simulations in parallel.

The `batchsim` command uses the Parallel Computing Toolbox™ and MATLAB Parallel Server™ licenses to run the simulations on compute cluster. `batchsim` runs the simulations in serial if a parallel pool cannot be created. If Parallel Computing Toolbox license is not available, `batchsim` errors out.

Examples

Run Parallel Simulations with batchsim

This example shows how to run parallel simulations in batch. `batchsim` offloads simulations to a compute cluster, enabling you to carry out other tasks while the batch job is processing, or close the client MATLAB and access the batch job later.

This example uses the `ex_sldemo_househeat` model and runs simulations in batch to observe the model behavior for different temperature set points.

Open the model.

```
openExample('simulink/OpenTheModelExample');
open_system('ex_sldemo_househeat');
load_system('ex_sldemo_househeat')
```

Define a set of values for different temperatures.

```
setPointValues = 65:2:85;
spv_Length = length(setPointValues);
```

Using the `setPointValues`, initialize an array of `Simulink.SimulationInput` objects.

```
in(1:spv_Length) = Simulink.SimulationInput('ex_sl-demo_househeat');
for i = 1:1:spv_Length
    in(i) = in(i).setBlockParameter('ex_sl-demo_househeat/Set Point',...
        'Value',num2str(setPointValues(i)));
end
```

Specify the pool size of the number of workers to use. In addition to the number of workers used to run simulations in parallel, a head worker is required. In this case, let's assume that three workers are available to run a batch job for the parallel simulations. The job object returns useful metadata as shown. You can use the job ID to access the job object later from any machine. `NumWorkers` tells you how many workers are running the simulations. `NumWorkers` is always the number of workers specified in the `'Pool'` argument and an additional head worker.

```
simJob = batchsim(in, 'Pool', 3)

      ID: 1
      Type: pool
      NumWorkers: 4
      Username: #####
      State: running
      SubmitDateTime: ##-###-#### ##:##:##
      StartDateTime:
      Running Duration: 0 days 0h 0m 0s
```

Access the results of the batch job using the `fetchOutputs` method. `fetchOutputs` returns an array of `Simulink.SimulationOutput` objects.

```
out = fetchOutputs(simJob)
```

```
1x11 Simulink.SimulationOutput array
```

Input Arguments

in — `Simulink.SimulationInput` object used to simulate the model
object, array

Specified as a `Simulink.SimulationInput` object or an array of `Simulink.SimulationInput` objects that is used to specify changes to the model for simulation.

Example: `in = Simulink.SimulationInput('vdp')`

myCluster — `parallel.Cluster` object
object

Cluster object that is used to specify the cluster in which the batch job runs.

Name-Value Pair Arguments

Specify optional comma-separated pairs of `Name`, `Value` arguments. `Name` is the argument name and `Value` is the corresponding value. You can specify several name and value pair arguments in any order as `Name1, Value1, ..., NameN, ValueN`.

Example: 'Pool', 5

AdditionalPaths — Files to attach to parallel pool

character vector | cell array

Specified as a character vector, a cell array or an array of character vector to define paths to be added to the MATLAB search path of the workers before the simulations execute. The default search path might not be the same on the workers as it is on the client; the path difference could be the result of different current working folders (pwd), platforms, or network file system access. The 'AdditionalPaths' property can assure that workers are looking in the correct locations for necessary code files, data files, model files, etc.

AttachedFiles — Files to attach to parallel pool

cell array

Specified as a cell array of additional files to attach to the parallel pool.

AutoAddClientPath — Whether user-added entries on client path are added to each worker path

true (default) | false

Specified as true or false to control whether user-added entries on the client path are added to each worker path.

AutoAttachFiles — Whether code files should be automatically attached to the job

true (default) | false

Specified as true or false to control whether code files are automatically attached to the job.

CaptureDiary — Whether diary is collected

true (default) | false

Specified as true or false to indicate collection of the diary.

CleanupFcn — Function handle to run once per worker after running simulations

function handle

Specify a function handle to 'CleanupFcn' to run once per worker after the simulations are completed.

EnvironmentVariables — Names of environment variables copied from client session to workers

character vector | cell array

Specifies the names of environment variables copied from the client session to the workers. The names specified here are appended to the 'EnvironmentVariables' property specified in the applicable parallel profile to form the complete list of environment variables. Any variables listed which are not set are not copied to the workers. These environment variables will be set on the workers for the duration of the batch job.

ManageDependencies — Manage model dependencies

'on' (default) | 'off'

When `ManageDependencies` is set to 'on', model dependencies are automatically sent to the parallel workers if necessary. If `ManageDependencies` is set to 'off', explicitly attach model dependencies to the parallel pool.

Pool — Size of the number of workers for a parallel pool

integer

An integer specifying the number of workers to make into a parallel pool for the job *in addition* to the worker running the batch job itself. The simulations use this pool for execution. Because the pool requires N workers in addition to the worker running the batch, there must be at least N+1 workers available on the cluster.

Profile — Cluster profile name

profile name

The name of a cluster profile used to identify the cluster. If this option is omitted, the default profile is used to identify the cluster and is applied to the job and task properties.

SetupFcn — Function handle to run once per worker

function handle

Specify a function handle to 'SetupFcn' to run once per worker before the start of the simulations.

Note When `buildRapidAcceleratorTarget` is used in the `SetupFcn` and the model has external inputs specified, either set 'LoadExternalInput' to 'off' or ensure that the specified external input is available on the workers to prevent compilation error.

ShowProgress — Show the progress of the simulations in diary

'on' | 'off'

Set to 'on', to copy the progress of the simulations in the command window to diary of `Simulink.Simulation.Job` object. The progress is hidden when set to 'off'.

StopOnError — Stop simulations on errors

'off' (default) | 'on'

Setting 'StopOnError' to 'on' stops the execution of simulations if an error is encountered.

TransferBaseWorkspaceVariables — Transfer variables to the parallel workers

'off' (default) | 'on'

When `TransferBaseWorkspaceVariables` is set to true, variables used in the model and defined in the base workspace are transferred to the parallel workers.

Note Use of `TransferBaseWorkspaceVariables` requires model compilation.

UseFastRestart — Use fast restart

'off' (default) | 'on'

When `UseFastRestart` is set to true, simulations run on the workers using fast restart.

Note When using `batchsim`, use the `UseFastRestart` option and not the `FastRestart` option. See “Get Started with Fast Restart” for more information.

Output Arguments

`simJob` — `Simulink.Simulation.Job` job object

object

An object containing metadata of submitted batch job. Poll job object using its ID to check the status of simulations or to access outputs on completion of the job.

Extended Capabilities

Automatic Parallel Support

Accelerate code by automatically running computation in parallel using Parallel Computing Toolbox™.

Using `batchsim` with Parallel Computing Toolbox installed, MATLAB automatically opens a worker and runs the job in the background on another session on your local machine. Specifying a pool size runs the simulations on the number of workers specified. Control parallel behavior with the parallel preferences, including scaling up to a cluster.

For details, see “Running Multiple Simulations”.

See Also

Functions

`parsim` | `batchsim` | `batch` | `parcluster` | `cancel` | `diary` | `fetchOutputs` | `listAutoAttachedFiles` | `wait` | `getSimulationJobs`

Classes

`Simulink.SimulationInput` | `Simulink.Simulation.Job`

Topics

“Comparison Between Multiple Simulation Workflows”

“Running Multiple Simulations”

“Batch Processing” (Parallel Computing Toolbox)

“Job Monitor” (Parallel Computing Toolbox)

Introduced in R2018b

bdclose

Close any or all Simulink system windows unconditionally

Syntax

```
bdclose
bdclose(sys)
bdclose('all')
```

Description

`bdclose` closes the current system window unconditionally and without confirmation. Any changes made to the system since it was last saved are lost. To find out the current system, use `gcs`. If a model was only loaded, `bdclose` clears the model from memory.

`bdclose(sys)` closes the specified system window, discarding all changes.

`bdclose('all')` closes all open system windows, discarding all changes.

Examples

Close a System Without Saving

Open the `vdp` system. Then, close it without saving any changes.

```
open_system('vdp')
bdclose('vdp')
```

Input Arguments

sys — System to close

character vector | string scalar | cell array

System to close, specified as a character vector, string scalar, or cell array. To specify multiple systems to close, specify a cell array of system names.

Example: `bdclose("vdp")`

Example: `bdclose({'vdp', 'f14'})`

Data Types: `char` | `string` | `cell`

Compatibility Considerations

Closing a window for a model hierarchy closes referenced models

Behavior changed in R2019b

Starting in R2019b, when you close a window for a model hierarchy by closing the top model, all referenced models that are not open in another window are also closed, which clears them from

memory. To keep referenced models loaded in memory, use the `close_system` function and set the `'closeReferencedModels'` argument to `false`.

See Also

`close_system` | `new_system` | `open_system` | `save_system`

Introduced before R2006a

bdIsDirty

Determine whether model, subsystem, or library has unsaved changes

Syntax

```
tf = bdIsDirty(bd)
```

Description

`tf = bdIsDirty(bd)` returns whether the specified model, subsystem, or library has unsaved changes. Unsaved changes can include changes to the block diagram, configuration parameters, or properties.

Examples

Check Models for Unsaved Changes

Check if models contain unsaved changes using `bdIsDirty`.

Check if a single model is dirty.

```
vdp  
bdIsDirty('vdp')
```

```
ans =  
  
    logical  
  
     0
```

Check if multiple models are dirty.

```
vdp  
f14  
bdIsDirty({'f14','vdp'})
```

```
ans =  
  
    1×2 logical array  
  
     0     0
```

Input Arguments

bd — Name or handle of loaded model, subsystem, or library

numeric array | string array | character vector | cell array of character vectors

Name or handle of loaded model, subsystem, or library, specified as a numeric array, string array, character vector, or cell array of character vectors.

You cannot check whether blocks, such as Subsystem blocks, have unsaved changes. You can check whether referenced subsystems have unsaved changes. For more information, see “Subsystem Reference”.

Data Types: `double` | `char` | `string` | `cell`

Output Arguments

tf — True or false result

1 | 0 | logical array

True or false result, returned as a 1 or 0 of data type `logical`.

- 1 (`true`) — File has been modified in memory since it was loaded or last saved.
- 0 (`false`) — File has no unsaved changes.

When multiple files are specified, the function returns a logical array with one entry for each file.

See Also

`bdIsLoaded`

Topics

“Manage Shadowed and Dirty Models and Other Project Files”

Introduced in R2017a

bdIsLibrary

Determine whether block diagram is a library

Syntax

```
tf = bdIsLibrary(bd)
```

Description

`tf = bdIsLibrary(bd)` returns whether the specified block diagram is a library.

Examples

Check Whether Block Diagrams Are Libraries

Load the `hdlib` and `vdp` block diagrams. Get the handle for `hdlib`.

```
load_system({'hdlib','vdp'})  
h = get_param('hdlib','Handle');
```

Check whether `vdp` is a library. The returned value `0` indicates that it is not.

```
bdIsLibrary('vdp')
```

```
ans =  
  
    logical  
  
     0
```

Check whether `hdlib` and `vdp` are libraries. The returned value shows that `hdlib` is a library and `vdp` is not.

```
bdIsLibrary({'hdlib','vdp'})
```

```
ans =  
  
    1×2 logical array  
  
     1     0
```

Using the handle to `hdlib`, check whether `hdlib` is a library. The value returned shows that it is.

```
bdIsLibrary(h)
```

```
ans =  
  
    logical
```

1

Input Arguments

bd — Name or handle of loaded block diagram

numeric array | string array | character vector | cell array of character vectors

Name or handle of loaded block diagram, specified as a numeric array, string array, character vector, or cell array of character vectors.

Data Types: `double` | `char` | `string` | `cell`

Output Arguments

tf — True or false result

1 | 0 | logical array

True or false result, returned as a 1 or 0 of data type `logical`.

- 1 (`true`) — File is a library.
- 0 (`false`) — File is not a library.

When multiple files are specified, the function returns a logical array with one entry for each file.

See Also

`bdIsLoaded` | `bdroot` | `find_system`**Introduced in R2015a**

bdIsLoaded

Determine whether model, subsystem, or library is loaded

Syntax

```
tf = bdIsLoaded(bd)
```

Description

`tf = bdIsLoaded(bd)` returns whether the specified model, subsystem, or library is loaded.

Examples

Check Whether Model Is Loaded

Check whether the f14 model is loaded.

```
bdIsLoaded('f14')
```

```
ans =  
    logical  
    0
```

The function returns a logical scalar, 0, which indicates that the file is not loaded.

To load the f14 model, use the `load_system` function.

```
load_system('f14')
```

Check Whether Multiple Models Are Loaded

Determine whether the f14 and vdp models are loaded.

```
bdIsLoaded({'f14','vdp'})
```

```
ans =  
    1×2 logical array  
    1    0
```

The function returns a 1-by-2 logical array, which indicates that the first model in the cell array (f14) is loaded and the second model in the cell array (vdp) is not loaded.

To load the vdp model, use the `load_system` function.

```
load_system('vdp')
```

Input Arguments

bd — Name of model, subsystem, or library

string array | character vector | cell array of character vectors

Name of model, subsystem, or library, specified as a string array, character vector, or cell array of character vectors.

Blocks, such as Subsystem blocks, cannot be loaded independently. Referenced subsystems can be loaded independently. For more information, see “Subsystem Reference”.

Data Types: `char` | `string` | `cell`

Output Arguments

tf — True or false result

1 | 0 | logical array

True or false result, returned as a 1 or 0 of data type `logical`.

- 1 (`true`) — File is loaded.
- 0 (`false`) — File is not loaded.

When multiple files are specified, the function returns a logical array with one entry for each file.

See Also

`find_system` | `bdIsLibrary` | `bdIsDirty`

Introduced in R2008a

bdroot

Top-level model of current system

Syntax

```
model = bdroot
model = bdroot(elements)
```

Description

`model = bdroot` returns the top-level model of the current system. The current system is the currently active Simulink Editor window or the system in which a block is selected.

`model = bdroot(elements)` returns the top-level model of the specified model elements. Before using `bdroot`, make sure the top-level model of each element in `elements` is loaded.

Examples

Get Top-Level Model of Current System

Open the system Controller in the model f14.

```
load_system('f14')
open_system('f14/Controller')
```

Get the top-level model of the current system.

```
bdroot
ans =
    'f14'
```

Get Top-Level Model of a System

Open the system Controller in the model f14.

```
load_system('f14')
open_system('f14/Controller')
```

Get the top-level model of the current system.

```
bdroot(gcs)
```

```
ans =  
    'f14'
```

Input Arguments

elements — Model elements whose top-level models to return

model name | block path name | handle | cell array of character vectors | string array | numeric array

Model elements whose top-level model to return, specified as the model name, block or system path name, handle, cell array of character vectors or string array of system names, or numeric array of handles.

Tip Use `bdroot` with `gcs`, `gcb`, and `gcbh` to get the top-level model of the current system or block.

Output Arguments

model — Top-level model

character vector | cell array | string array

Top-level model, returned as a character vector of the model name. If the input was an array, `model` is returned as an array of the same type as the input.

See Also

`gcb` | `gcs` | `gcbh`

Introduced before R2006a

dlinmod

Extract discrete-time linear state-space model around operating point

Syntax

```
argout = dlinmod('sys', Ts)
```

```
argout = dlinmod('sys', Ts, x, u)
```

```
argout = dlinmod('sys', Ts, x, u, para, 'v5')
```

```
argout = dlinmod('sys', Ts, x, u, para, xpert, upert, 'v5')
```

Arguments

| | |
|---------------------|---|
| <i>sys</i> | Name of the Simulink system from which the linear model is extracted. |
| <i>x</i> , <i>u</i> | State (<i>x</i>) and the input (<i>u</i>) vectors. If specified, they set the operating point at which the linear model is extracted. When a model has model references using the Model block, you must use the Simulink structure format to specify <i>x</i> . To extract the <i>x</i> structure from the model, use the following command: <pre>x = Simulink.BlockDiagram.getInitialState('sys');</pre> <p>You can then change the operating point values within this structure by editing <code>x.signals.values</code>.</p> <p>If the state contains different data types (for example, 'double' and 'uint8'), then you cannot use a vector to specify this state. You must use a structure instead. In addition, you can only specify the state as a vector if the state data type is 'double'.</p> |
| <i>Ts</i> | Sample time of the discrete-time linearized model |
| 'v5' | An optional argument that invokes the perturbation algorithm created prior to MATLAB 5.3. Invoking this optional argument is equivalent to calling <code>linmodv5</code> . |
| <i>para</i> | A three-element vector of optional arguments: <ul style="list-style-type: none"> • <code>para(1)</code> — Perturbation value of delta, the value used to perform the perturbation of the states and the inputs of the model. This is valid for linearizations using the 'v5' flag. The default value is 1e-05. • <code>para(2)</code> — Linearization time. For blocks that are functions of time, you can set this parameter with a nonnegative value that gives the time (<i>t</i>) at which Simulink evaluates the blocks when linearizing a model. The default value is 0. • <code>para(3)</code> — Set <code>para(3)=1</code> to remove extra states associated with blocks that have no path from input to output. The default value is 0. |

xpert, upert

The perturbation values used to perform the perturbation of all the states and inputs of the model. The default values are

```
xpert = para(1) + 1e-3*para(1)*abs(x)
upert = para(1) + 1e-3*para(1)*abs(u)
```

When a model has model references using the Model block, you must use the Simulink structure format to specify *xpert*. To extract the *xpert* structure, use the following command:

```
xpert = Simulink.BlockDiagram.getInitialState('sys');
```

You can then change the perturbation values within this structure by editing `xpert.signals.values`.

The perturbation input arguments are only available when invoking the perturbation algorithm created prior to MATLAB 5.3, either by calling `linmodv5` or specifying the 'v5' input argument to `linmod`.

argout

`linmod`, `dlinmod`, and `linmod2` return state-space representations if you specify the output (left-hand) side of the equation as follows:

- `[A,B,C,D] = linmod('sys', x, u)` obtains the linearized model of *sys* around an operating point with the specified state variables *x* and the input *u*. If you omit *x* and *u*, the default values are zero.

`linmod` and `dlinmod` both also return a transfer function and MATLAB data structure representations of the linearized system, depending on how you specify the output (left-hand) side of the equation. Using `linmod` as an example:

- `[num, den] = linmod('sys', x, u)` returns the linearized model in transfer function form.
- `sys_struc = linmod('sys', x, u)` returns a structure that contains the linearized model, including state names, input and output names, and information about the operating point.

Description

`dlinmod` compute a linear state-space model for a discrete-time system by linearizing each block in a model individually.

`linmod` obtains linear models from systems of ordinary differential equations described as Simulink models. Inputs and outputs are denoted in Simulink block diagrams using Inport and Outport blocks.

The default algorithm uses preprogrammed analytic block Jacobians for most blocks which should result in more accurate linearization than numerical perturbation of block inputs and states. A list of blocks that have preprogrammed analytic Jacobians is available in the Simulink Control Design documentation along with a discussion of the block-by-block analytic algorithm for linearization.

The default algorithm also allows for special treatment of problematic blocks such as the Transport Delay and the Quantizer. See the mask dialog of these blocks for more information and options.

Discrete-Time System Linearization

The function `dlinmod` can linearize discrete, multirate, and hybrid continuous and discrete systems at any given sampling time. Use the same calling syntax for `dlinmod` as for `linmod`, but insert the sample time at which to perform the linearization as the second argument. For example,

```
[Ad,Bd,Cd,Dd] = dlinmod('sys', Ts, x, u);
```

produces a discrete state-space model at the sampling time T_s and the operating point given by the state vector x and input vector u . To obtain a continuous model approximation of a discrete system, set T_s to ∞ .

For systems composed of linear, multirate, discrete, and continuous blocks, `dlinmod` produces linear models having identical frequency and time responses (for constant inputs) at the converted sampling time T_s , provided that

- T_s is an integer multiple of all the sampling times in the system.
- The system is stable.

For systems that do not meet the first condition, in general the linearization is a time-varying system, which cannot be represented with the $[A,B,C,D]$ state-space model that `dlinmod` returns.

Computing the eigenvalues of the linearized matrix A_d provides an indication of the stability of the system. The system is stable if $T_s > 0$ and the eigenvalues are within the unit circle, as determined by this statement:

```
all(abs(eig(Ad))) < 1
```

Likewise, the system is stable if $T_s = \infty$ and the eigenvalues are in the left half plane, as determined by this statement:

```
all(real(eig(Ad))) < 0
```

When the system is unstable and the sample time is not an integer multiple of the other sampling times, `dlinmod` produces A_d and B_d matrices, which can be complex. The eigenvalues of the A_d matrix in this case still, however, provide a good indication of stability.

You can use `dlinmod` to convert the sample times of a system to other values or to convert a linear discrete system to a continuous system or vice versa.

You can find the frequency response of a continuous or discrete system by using the `bode` command.

Notes

By default, the system time is set to zero. For systems that are dependent on time, you can set the variable `para` to a two-element vector, where the second element is used to set the value of t at which to obtain the linear model.

The ordering of the states from the nonlinear model to the linear model is maintained. For Simulink systems, a character vector variable that contains the block name associated with each state can be obtained using

```
[sizes,x0,xstring] = sys
```

where `xstring` is a vector of strings whose *i*th row is the block name associated with the *i*th state. Inputs and outputs are numbered sequentially on the diagram.

For single-input multi-output systems, you can convert to transfer function form using the routine `ss2tf` or to zero-pole form using `ss2zp`. You can also convert the linearized models to LTI objects using `ss`. This function produces an LTI object in state-space form that can be further converted to transfer function or zero-pole-gain form using `tf` or `zpk`.

The default algorithms in `linmod` and `dlinmod` handle Transport Delay blocks by replacing the linearization of the blocks with a Pade approximation. For the 'v5' algorithm, linearization of a model that contains Derivative or Transport Delay blocks can be troublesome. For more information, see "Linearizing Models".

See Also

`linmod` | `linmod2` | `linmodv5`

Introduced in R2007a

close_system

Close Simulink system window or block dialog box

Syntax

```
close_system
close_system(blockOrSys)
close_system(sys,saveflag)
close_system(sys,newsys)
close_system(sys, ___,Name,Value)
```

Description

`close_system` closes the current system or subsystem. If the current system is the top-level model and has been modified, `close_system` returns an error.

Use the `gcs` function to determine the current system.

Note You cannot use `close_system` in a block or menu callback to close the root-level model. Attempting to close the root-level model in a block or menu callback causes an error and discontinues the callback execution.

`close_system(blockOrSys)` closes the specified model or subsystem, or the block dialog box of the specified block. If the model was only loaded, that is, with `load_system`, this syntax clears the model from memory.

`close_system(sys,saveflag)` lets you specify whether to save the model with its current name or to close it without saving.

`close_system(sys,newsys)` saves the model to a file with the specified name before closing.

`close_system(sys, ___,Name,Value)` specifies additional options using one or more `Name,Value` pair arguments.

Examples

Close the Current System

Open the model `vdp` and then close it.

```
vdp
close_system
```

Close a Block Dialog Box

Open the model `vdp`.

vdp

In the model, double-click the Mu block to open its block dialog box.

Close the block dialog box

```
close_system('vdp/Mu');
```

Close a Model and Save with New Name

Open a model, modify it, save the model with a new name and close it.

Open the model vdp and add a block to it.

```
vdp
block = add_block('vdp/Mu','vdp/Mu','MakeNameUnique','on');
```

Close the model, saving it with a new name.

```
close_system('vdp','myvdp');
```

Close a Model Using Name,Value Options

This command tries to save the vdp system to a file with the name 'max', but returns an error because 'max' is the name of an existing MATLAB function.

```
close_system('vdp','max','ErrorIfShadowed',true)
```

Close a Top Model and Keep Referenced Models Loaded

Open a model hierarchy, load the referenced model, then close the top model, leaving the referenced model loaded.

Open the sldemo_mdhref_basic model and load its referenced model, sldemo_mdhref_counter.

```
open_system('sldemo_mdhref_basic')
load_system('sldemo_mdhref_counter')
```

Check what models are loaded in memory.

```
loadedModels = Simulink.allBlockDiagrams('model');
modelName = get_param(loadedModels,'Name')
```

```
modelName =
```

```
2x1 cell array
```

```
 {'sldemo_mdhref_counter'}
 {'sldemo_mdhref_basic' }
```

Close sldemo_mdhref_basic while keeping the referenced model loaded.

```
close_system('sldemo_mdhref_basic',0,'closeReferencedModels',false)
```

Check what models are loaded in memory.

```
loadedModels = Simulink.allBlockDiagrams('model');
modelName = get_param(loadedModels, 'Name')

modelName =

    'sldemo_mdref_counter'
```

Closing the top model clears it from memory. By default, because they share a window, using `close_system` on the top model would also close the referenced model and clear it from memory. Setting `'closeReferencedModels'` to `false` keeps the referenced model, `sldemo_mdref_counter`, loaded.

Input Arguments

blockOrSys — Block, model, or subsystem to close

character vector | cell array of character vectors | string array | handle | array of handles

Name of model, subsystem, or the block whose dialog box you want to close, specified as a character vector, cell array of character vectors, string array, handle, or array of handles. Do not use a file extension.

Example: `"vdp/Mu" 'vdp'`

sys — Name of model to close

character vector | cell array of character vectors | string array | handle | array of handles

Name of model to close, specified as a character vector, cell array of character vectors, string array, handle, or array of handles. Do not use a file extension.

saveFlag — Option to save file with current name

0 (default) | 1 | numeric array

Option to save model using the current file name, specified as 0 to close without saving or 1 to save and then close. If `sys` is an array, you can supply a single character to apply to all of the models in the array. Or you can provide a numeric array with values that correspond with each model in the `sys` array.

For information on rules for naming models, see “Model Names”.

newsys — File to save to

character vector | cell array of character vectors | string array

File to save to, specified as a character vector, cell array of character vectors, or string array. You can specify a model name in the current folder or the full path name, with or without an extension.

When you specify a name without an extension, `close_system` saves to the file format specified in your Simulink preferences. Possible model extensions are `.slx` and `.mdl`.

For information on rules for naming models, see “Model Names”.

Name-Value Pair Arguments

Specify optional comma-separated pairs of **Name**, **Value** arguments. **Name** is the argument name and **Value** is the corresponding value. **Name** must appear inside quotes. You can specify several name and value pair arguments in any order as **Name1**, **Value1**, . . . , **NameN**, **ValueN**.

Example:

```
close_system('mymodel','newmodel','closeReferencedModels',false,'ErrorIfShadowed',true,'OverwriteIfChangedOnDisk',true,'SaveModelWorkspace',true)
```

closeReferencedModels — Option to close all referenced models

true (default) | false | 'on' | 'off'

Option to close all referenced models when you close the window for the top model, specified as the comma-separated pair consisting of 'closeReferencedModels' and true, false, 'on', or 'off'. Referenced models that are open in another window are unaffected by this setting. To keep referenced models loaded, set this argument to false.

ErrorIfShadowed — Option to return an error if the new name is already used

false (default) | true | 'on' | 'off'

Option to return an error if the new name is already used on the MATLAB path or in the workspace, specified as the comma-separated pair consisting of 'ErrorIfShadowed' and true, false, 'on', or 'off'. To receive this error, you must use the newsys argument to save the model with a new name. To learn about shadowed files, see “Shadowed Files”.

OverwriteIfChangedOnDisk — Option to overwrite the file on disk

false (default) | true | 'on' | 'off'

Option to overwrite the file on disk when you save the model, even if it has been modified since the system was loaded, specified as the comma-separated pair consisting of 'OverwriteIfChangedOnDisk' and true, false, 'on', or 'off'. By default, if the file changed on disk since the model was loaded, close_system displays an error to prevent the changes on disk from being overwritten.

You can control whether saving the model displays an error if the file has changed on disk by using a Simulink preference. In the **Model File** pane of the Simulink Preferences dialog box, under **Change Notification**, select **Saving the model**. This preference is on by default.

SaveModelWorkspace — Option to save the model workspace

false (default) | true | 'on' | 'off'

Option to save the model workspace when you save the model, specified as the comma-separated pair consisting of 'SaveModelWorkspace' and true, false, 'on', or 'off'. The model workspace DataSource must be a MAT-file. If the data source is not a MAT-file, saving the model does not save the workspace. See “Specify Source for Data in Model Workspace”.

Compatibility Considerations

Closing a window for a model hierarchy closes referenced models

Behavior changed in R2019b

Starting in R2019b, when you close a window for a model hierarchy by closing the top model, all referenced models that are not open in another window are also closed, which clears them from

memory. To keep referenced models loaded in memory, set the 'closeReferencedModels' argument to false.

See Also

`bdclose` | `gcs` | `new_system` | `open_system` | `save_system` | `load_system`

Introduced before R2006a

closeDialog

Close configuration parameters dialog

Syntax

```
closeDialog(configObj)
```

Arguments

configObj

A configuration set (`Simulink.ConfigSet`) or configuration reference (`Simulink.ConfigSetRef`)

Description

`closeDialog` closes an open configuration parameters dialog box. If *configObj* is a configuration set, the function closes the dialog box that displays the configuration set. If *configObj* is a configuration reference, the function closes the dialog box that displays the referenced configuration set, or generates an error if the reference does not specify a valid configuration set. If the dialog box is already closed, the function does nothing.

Examples

The following example closes a configuration parameters dialog box that shows the current parameters for the current model. The parameter values derive from the active configuration set or configuration reference (configuration object). The code is the same in either case; the only difference is which type of configuration object is currently active.

```
myConfigObj = getActiveConfigSet(gcs);  
closeDialog(myConfigObj);
```

See Also

[attachConfigSet](#) | [attachConfigSetCopy](#) | [detachConfigSet](#) | [getActiveConfigSet](#) | [getConfigSet](#) | [getConfigSets](#) | [openDialog](#) | [setActiveConfigSet](#)

Topics

“Manage Configuration Sets for a Model”

“Share a Configuration with Multiple Models”

Introduced in R2006b

closeReport

Package: Simulink

Close MATLAB function report

Syntax

```
closeReport(config)
```

Description

`closeReport(config)` closes the MATLAB function report for a MATLAB Function block.

Examples

Open and Close MATLAB Function Report

Access the `MATLABFunctionConfiguration` object for the MATLAB Function block in the model `call_stats_block1` described in “Create Custom Functionality Using MATLAB Function Blocks”.

```
config = get_param('call_stats_block1/MATLAB Function', ...  
    'MATLABFunctionConfiguration');
```

Open the MATLAB function report.

```
openReport(config)
```

Close the MATLAB function report.

```
closeReport(config)
```

Input Arguments

config — MATLAB Function block property configuration

`MATLABFunctionConfiguration` object

MATLAB Function block property configuration, specified as a `MATLABFunctionConfiguration` object.

Data Types: `MATLABFunctionConfiguration`

See Also

MATLAB Function | `MATLABFunctionConfiguration` | `openReport`

Topics

“MATLAB Function Reports”

“Create Custom Functionality Using MATLAB Function Blocks”

Introduced in R2021a

coder.allowpcode

Package: coder

Control code generation from protected MATLAB files

Syntax

```
coder.allowpcode('plain')
```

Description

`coder.allowpcode('plain')` allows you to generate protected MATLAB code (P-code) that you can then compile into optimized MEX functions or embeddable C/C++ code. This function does not obfuscate the generated MEX functions or embeddable C/C++ code.

With this capability, you can distribute algorithms as protected P-files that provide code generation optimizations.

Call this function in the top-level function before control-flow statements, such as `if`, `while`, `switch`, and function calls.

MATLAB functions can call P-code. When the `.m` and `.p` versions of a file exist in the same folder, the P-file takes precedence.

`coder.allowpcode` is ignored outside of code generation.

Examples

Generate optimized embeddable code from protected MATLAB code:

- 1 Write an function `p_abs` that returns the absolute value of its input:

```
function out = p_abs(in)    %#codegen
% The directive %#codegen indicates that the function
% is intended for code generation
coder.allowpcode('plain');
out = abs(in);
```

- 2 Generate protected P-code. At the MATLAB prompt, enter:

```
pcode p_abs
```

The P-file, `p_abs.p`, appears in the current folder.

- 3 Generate a MEX function for `p_abs.p`, using the `-args` option to specify the size, class, and complexity of the input parameter (requires a MATLAB Coder license). At the MATLAB prompt, enter:

```
codegen p_abs -args { int32(0) }
```

`codegen` generates a MEX function in the current folder.

- 4 Generate embeddable C code for `p_abs.p` (requires a MATLAB Coder license). At the MATLAB prompt, enter:

```
codegen p_abs -config:lib -args { int32(0) };
```

codegen generates C library code in the `codegen\lib\p_abs` folder.

Extended Capabilities

C/C++ Code Generation

Generate C and C++ code using MATLAB® Coder™.

GPU Code Generation

Generate CUDA® code for NVIDIA® GPUs using GPU Coder™.

See Also

[pcode](#) | [codegen](#)

Introduced in R2011a

coder.ceval

Call external C/C++ function

Syntax

```

coder.ceval(cfun_name)
coder.ceval(cfun_name,cfun_arguments)

coder.ceval('-global',cfun_name)
coder.ceval('-global',cfun_name,cfun_arguments)

coder.ceval('-gpudevicefcn',devicefun_name,devicefun_arguments)

coder.ceval('-layout:rowMajor',cfun_name,cfun_arguments)
coder.ceval('-layout:columnMajor',cfun_name,cfun_arguments)
coder.ceval('-layout:any',cfun_name,cfun_arguments)

cfun_return = coder.ceval( ___ )

```

Description

`coder.ceval(cfun_name)` executes the external C/C++ function specified by `cfun_name`. Define `cfun_name` in an external C/C++ source file or library. Provide the external source, library, and header files to the code generator.

`coder.ceval(cfun_name,cfun_arguments)` executes `cfun_name` with arguments `cfun_arguments`. `cfun_arguments` is a comma-separated list of input arguments in the order that `cfun_name` requires.

By default, `coder.ceval` passes arguments by value to the C/C++ function whenever C/C++ supports passing arguments by value. To make `coder.ceval` pass arguments by reference, use the constructs `coder.ref`, `coder.rref`, and `coder.wref`. If C/C++ does not support passing arguments by value, for example, if the argument is an array, `coder.ceval` passes arguments by reference. If you do not use `coder.ref`, `coder.rref` or `coder.wref`, a copy of the argument can appear in the generated code to enforce MATLAB semantics for arrays.

`coder.ceval('-global',cfun_name)` executes `cfun_name` and indicates that `cfun_name` uses one or more MATLAB global variables. The code generator can then produce code that is consistent with this global variable usage.

`coder.ceval('-global',cfun_name,cfun_arguments)` executes `cfun_name` with arguments `cfun_arguments` and indicates that `cfun_name` uses one or more MATLAB global variables.

`coder.ceval('-gpudevicefcn',devicefun_name,devicefun_arguments)` allows you to call CUDA® GPU `__device__` functions from within kernels. `'-gpudevicefcn'` indicates to `coder.ceval` that the target function is on the GPU device. `devicefun_name` is the name of the `__device__` function and `devicefun_arguments` is a comma-separated list of input arguments in the order that `devicefun_name` requires. This option requires the GPU Coder™ product.

`coder.ceval('-layout:rowMajor',cfun_name,cfun_arguments)` executes `cfun_name` with arguments `cfun_arguments` and passes data stored in row-major layout. When called from a

function that uses column-major layout, the code generator converts inputs to row-major layout and converts outputs back to column-major layout. For a shorter syntax, use `coder.ceval(' -row', ...)`.

`coder.ceval(' -layout:columnMajor', cfun_name, cfun_arguments)` executes `cfun_name` with arguments `cfun_arguments` and passes data stored in column-major layout. When called from a function that uses row-major layout, the code generator converts inputs to column-major layout and converts outputs back to row-major layout. For a shorter syntax, use `coder.ceval(' -col', ...)`.

`coder.ceval(' -layout:any', cfun_name, cfun_arguments)` executes `cfun_name` with arguments `cfun_arguments` and passes data with its current array layout, even when array layouts do not match. The code generator does not convert the array layout of the input or output data.

`cfun_return = coder.ceval(___)` executes `cfun_name` and returns a single scalar value, `cfun_return`, corresponding to the value that the C/C++ function returns in the `return` statement. To be consistent with C/C++, `coder.ceval` can return only a scalar value. It cannot return an array. Use this option with any of the input argument combinations in the previous syntaxes.

Examples

Call External C Function

Call a C function `foo(u)` from a MATLAB function from which you intend to generate C code.

Create a C header file `foo.h` for a function `foo` that takes two input parameters of type `double` and returns a value of type `double`.

```
double foo(double in1, double in2);
```

Write the C function `foo.c`.

```
#include <stdio.h>
#include <stdlib.h>
#include "foo.h"

double foo(double in1, double in2)
{
    return in1 + in2;
}
```

Write a function `callfoo` that calls `foo` by using `coder.ceval`. Provide the source and header files to the code generator in the function.

```
function y = callfoo %#codegen
y = 0.0;
if coder.target('MATLAB')
    % Executing in MATLAB, call MATLAB equivalent of
    % C function foo
    y = 10 + 20;
else
    % Executing in generated code, call C function foo
    coder.updateBuildInfo('addSourceFiles','foo.c');
    coder.cinclude('foo.h');
    y = coder.ceval('foo', 10, 20);
```

```
end
end
```

Generate C library code for function `callfoo`. The `codegen` function generates C code in the `\codegen\lib\callfoo` subfolder.

```
codegen -config:lib callfoo -report
```

Call a C Library Function

Call a C library function from MATLAB code.

Write a MATLAB function `myabsval`.

```
function y = myabsval(u)
%#codegen
y = abs(u);
```

Generate a C static library for `myabsval`, using the `-args` option to specify the size, type, and complexity of the input parameter.

```
codegen -config:lib myabsval -args {0.0}
```

The `codegen` function creates the library file `myabsval.lib` and header file `myabsval.h` in the folder `\codegen\lib\myabsval`. (The library file extension can change depending on your platform.) It generates the functions `myabsval_initialize` and `myabsval_terminate` in the same folder.

Write a MATLAB function to call the generated C library function using `coder.ceval`.

```
function y = callmyabsval(y)
%#codegen
% Check the target. Do not use coder.ceval if callmyabsval is
% executing in MATLAB
if coder.target('MATLAB')
    % Executing in MATLAB, call function myabsval
    y = myabsval(y);
else
    % add the required include statements to generated function code
    coder.updateBuildInfo('addIncludePaths', '${START_DIR}\codegen\lib\myabsval');
    coder.cinclude('myabsval_initialize.h');
    coder.cinclude('myabsval.h');
    coder.cinclude('myabsval_terminate.h');

    % Executing in the generated code.
    % Call the initialize function before calling the
    % C function for the first time
    coder.ceval('myabsval_initialize');

    % Call the generated C library function myabsval
    y = coder.ceval('myabsval',y);

    % Call the terminate function after
    % calling the C function for the last time
    coder.ceval('myabsval_terminate');
end
```

Generate the MEX function `callmyabsval_mex`. Provide the generated library file at the command line.

```
codegen -config:mex callmyabsval codegen\lib\myabsval\myabsval.lib -args {-2.75}
```

Rather than providing the library at the command line, you can use `coder.updateBuildInfo` to specify the library within the function. Use this option to preconfigure the build. Add this line to the `else` block:

```
coder.updateBuildInfo('addLinkObjects','myabsval.lib','$(START_DIR)\codegen\lib\myabsval',100, true);
```

Run the MEX function `callmyabsval_mex` which calls the library function `myabsval`.

```
callmyabsval_mex(-2.75)
```

```
ans =
```

```
2.7500
```

Call the MATLAB function `callmyabsval`.

```
callmyabsval(-2.75)
```

```
ans =
```

```
2.7500
```

The `callmyabsval` function exhibits the desired behavior for execution in MATLAB and in code generation.

Call C Function That Uses Global Variable

Use the `'-global'` flag when you call a C function that modifies a global variable.

Write a MATLAB function `useGlobal` that calls a C function `addGlobal`. Use the `'-global'` flag to indicate to the code generator that the C function uses a global variable.

```
function y = useGlobal()
global g;
t = g;
% compare execution with/without '-global' flag
coder.ceval('-global','addGlobal');
y = t;
end
```

Create a C header file `addGlobal.h` for the function `addGlobal`.

```
void addGlobal(void);
```

Write the C function `addGlobal` in the file `addGlobal.c`. This function includes the header file `useGlobal_data.h` that the code generator creates when you generate code for the function `useGlobal`. This header file contains the global variable declaration for `g`.

```
#include "addGlobal.h"
#include "useGlobal_data.h"
void addGlobal(void) {
```

```

    g++;
}

```

Generate the MEX function for `useGlobal`. To define the input to the code generator, declare the global variable in the workspace.

```

global g;
g = 1;
codegen useGlobal -report addGlobal.h addGlobal.c
y = useGlobal_mex();

```

With the `'-global'` flag, the MEX function produces the result `y = 1`. The `'-global'` flag indicates to the code generator that the C function possibly modifies the global variable. For `useGlobal`, the code generator produces this code:

```

real_T useGlobal(const emlrtStack *sp)
{
    real_T y;
    (void)sp;
    y = g;
    addGlobal();
    return y;
}

```

Without the `'-global'` flag, the MEX function produces `y = 2`. Because there is no indication that the C function modifies `g`, the code generator assumes that `y` and `g` are identical. This C code is generated:

```

real_T useGlobal(const emlrtStack *sp)
{
    (void)sp;
    addGlobal();
    return g;
}

```

Call C Function That Uses Different Array Layout

Suppose that you have a C function `testRM` that is designed to use row-major layout. You want to integrate this function into a MATLAB function `bar` that operates on arrays. The function `bar` is designed to use column-major layout, employing the `coder.columnMajor` directive.

```

function out = bar(in)
%#codegen
coder.columnMajor;
coder.ceval('-layout:rowMajor','testRM', ...
    coder.rref(in),coder.wref(out));
end

```

In the generated code, the code generator inserts a layout conversion from column-major layout to row-major layout on the variable `in` before passing it to `testRM`. On the output variable `out`, the code generator inserts a layout conversion back to column-major.

In general, if you do not specify the `layout` option for `coder.ceval`, the external function arguments are assumed to use column-major.

Call C Function That Takes Complex Number Inputs

Suppose you have a MATLAB function that calls custom C code that takes complex number inputs. You must define your C code input parameters so that the complex number inputs from your MATLAB function can map to your C code.

In generated code, complex numbers are defined as a `struct` that has two fields, `re` and `im`, which are the real and imaginary part of a complex number respectively. This `struct` is defined in the header file `rtwtypes.h`, which you can find in the `codegen\lib\functionName` folder of your current path. The `struct` is defined as follows:

```
typedef struct {
    real32_T re; /*Real Component*/
    real32_T im; /*Imaginary Component*/
} creal32_T;
```

For more information, see “Mapping MATLAB Types to Types in Generated Code” (MATLAB Coder).

The C code that you want to integrate must include the `rtwtypes.h` header file. An example C code `foo.c` is shown below:

```
#include "foo.h"
#include<stdio.h>
#include<stdlib.h>
#include "rtwtypes.h"

double foo(creal32_T x) {
    double z = 0.0;
    z = x.re*x.re + x.im*x.im;
    return (z);
}
```

The `struct` is named `creal32_T`. A header file `foo.h` must also be defined as:

```
#include "rtwtypes.h"
double foo(creal32_T x);
```

The MATLAB code executes `foo.c` by using the `coder.ceval` function that has a complex numbers input:

```
function y = complexCeval %#codegen
y = 0.0;
coder.updateBuildInfo('addSourceFiles','foo.c');
coder.cinclude('foo.h');
y = coder.ceval('foo', 10+20i);
end
```

The `coder.ceval` command takes the complex number input. The code generator maps the complex number to the `struct creal32_T` variable `x` and its fields `re` and `im`.

Generate code for the function `complexCeval` by running this command:

```
codegen -config:lib -report complexCeval
```

Input Arguments

cfun_name — C/C++ function name

character vector | string scalar

Name of external C/C++ function to call.

Example: `coder.ceval('foo')`

Data Types: `char` | `string`

cfun_arguments — C/C++ function arguments

scalar variable | array | element of an array | structure | structure field | object property

Comma-separated list of input arguments in the order that `cfun_name` requires.

Example: `coder.ceval('foo', 10, 20);`

Example: `coder.ceval('myFunction', coder.ref(x));`

Data Types: `single` | `double` | `int8` | `int16` | `int32` | `int64` | `uint8` | `uint16` | `uint32` | `uint64` | `logical` | `char` | `struct`

Complex Number Support: Yes

Limitations

- You cannot use `coder.ceval` on functions that you declare extrinsic with `coder.extrinsic`.
- When the LCC compiler creates a library, it adds a leading underscore to the library function names. If the compiler for the library was LCC and your code generation compiler is not LCC, you must add the leading underscore to the function name, for example, `coder.ceval('_mylibfun')`. If the compiler for a library was not LCC, you cannot use LCC to generate code from MATLAB code that calls functions from that library. Those library function names do not have the leading underscore that the LCC compiler requires.
- If a property has a get method, a set method, or validators, or is a System object property with certain attributes, then you cannot pass the property by reference to an external function. See “Passing By Reference Not Supported for Some Properties”.

Tips

- For code generation, before calling `coder.ceval`, you must specify the type, size, and complexity data type of return values and output arguments.
- To apply `coder.ceval` to a function that accepts or returns variables that do not exist in MATLAB code, such as pointers, FILE types for file I/O, and C/C++ macros, use the `coder.opaque` function.
- Use `coder.ceval` only in MATLAB for code generation. `coder.ceval` generates an error in uncompiled MATLAB code. To determine if a MATLAB function is executing in MATLAB, use `coder.target`. If the function is executing in MATLAB, call the MATLAB version of the C/C++ function.
- External code called by using `coder.ceval` and the generated code run within the same process and share memory. If external code erroneously writes to the memory that contains data structures used by the generated code, it might cause the process to behave unexpectedly or

crash. For example, if the external code attempts to write data to an array after its end point, the process might behave unexpectedly or crash.

Extended Capabilities

C/C++ Code Generation

Generate C and C++ code using MATLAB® Coder™.

GPU Code Generation

Generate CUDA® code for NVIDIA® GPUs using GPU Coder™.

See Also

`coder.ref` | `coder.rref` | `coder.wref` | `coder.target` | `coder.extrinsic` | `coder.opaque` | `coder.updateBuildInfo` | `coder.ExternalDependency` | `coder.reservedName`

Topics

“Integrate C Code by Using the MATLAB Function Block”

“Generate Code That Uses Row-Major Array Layout” (MATLAB Coder)

“Interface with Row-Major Data in MATLAB Function Block”

“Unknown Output Type for `coder.ceval`”

Introduced in R2011a

coder.cinclude

Include header file in generated code

Syntax

```
coder.cinclude(headerfile)
coder.cinclude(headerfile, 'InAllSourceFiles', allfiles)
```

Description

`coder.cinclude(headerfile)` includes a header file in generated C/C++ source code.

MATLAB Coder generates the include statement in the C/C++ source files that are generated from the MATLAB code that contains the `coder.cinclude` call.

In a Simulink model, when a `coder.cinclude` call appears in a MATLAB Function block, the code generator puts the include statement in the model header file.

Note Place a `coder.cinclude` call as close as possible to the `coder.ceval` call that requires the header file.

`coder.cinclude(headerfile, 'InAllSourceFiles', allfiles)` uses the `allfiles` option to determine whether to include the header file in almost all C/C++ source files.

If `allfiles` is true, MATLAB Coder generates the include statement in almost all C/C++ source files, except for some utility files. This behavior is the `coder.cinclude` behavior from R2016a and earlier releases. The presence of the include statement in these additional files can increase compile time and make the generated code less readable. Use this option only if your code depends on the legacy behavior. If `allfiles` is false, the behavior is the same as the behavior of `coder.cinclude(headerfile)`.

In a MATLAB Function block, `coder.cinclude(headerfile, 'InAllSourceFiles', allfiles)` is the same as `coder.cinclude(headerfile)`.

Examples

Include Header File in C/C++ Code Generated by Using the MATLAB Coder codegen Command

Generate code from a MATLAB function that calls an external C function. Use `coder.cinclude` to include the required header file in the generated C code.

In a writable folder, create a subfolder `mycfiles`.

Write a C function `myMult2.c` that doubles its input. Save it in `mycfiles`.

```
#include "myMult2.h"
double myMult2(double u)
```

```
{
    return 2 * u;
}
```

Write the header file `myMult2.h`. Save it in `mycfiles`.

```
#if !defined(MYMULT2)
#define MYMULT2
extern double myMult2(double);
#endif
```

Write a MATLAB function, `myfunc`, that includes `myMult2.h` and calls `myMult2` for code generation only.

```
function y = myfunc
%#codegen
y = 21;
if ~coder.target('MATLAB')
    % Running in generated code
    coder.cinclude('myMult2.h');
    y = coder.ceval('myMult2', y);
else
    % Running in MATLAB
    y = y * 2;
end
end
```

Create a code configuration object for a static library. Specify the locations of `myMult2.h` and `myMult2.c`.

```
cfg = coder.config('lib');
cfg.CustomInclude = fullfile(pwd, 'mycfiles');
cfg.CustomSource = fullfile(pwd, 'mycfiles', 'myMult2.c');
```

Generate the code.

```
codegen -config cfg myfunc -report
```

The file `myfunc.c` contains this statement:

```
#include "myMult2.h"
```

The include statement does not appear in any other file.

Include Header File in C/C++ Code Generated from a MATLAB Function Block in a Simulink Model

Generate code from a MATLAB Function block that calls an external C function. Use `coder.cinclude` to include the required header file in the generated C code.

In a writable folder, create a subfolder `mycfiles`.

Write a C function `myMult2.c` that doubles its input. Save it in `mycfiles`.

```
#include "myMult2.h"
double myMult2(double u)
```

```
{
    return 2 * u;
}
```

Write the header file `myMult2.h`. Save it in `mycfiles`.

```
#if !defined(MYMULT2)
#define MYMULT2
extern double myMult2(double);
#endif
```

Create a Simulink model that contains a MATLAB Function block connected to an Output block.



In the MATLAB Function block, add the function `myfunc` that includes `myMult2.h` and calls `myMult2`.

```
function y = myfunc
%#codegen
y = 21;
coder.cinclude('myMult2.h');
y = coder.ceval('myMult2', y);
% Specify the locations of myMult2.h and myMult2.c
coder.extrinsic('pwd', 'fullfile');
customDir = coder.const(fullfile(pwd, 'mycfiles'));
coder.updateBuildInfo('addIncludePaths', customDir);
coder.updateBuildInfo('addSourcePaths', customDir);
coder.updateBuildInfo('addSourceFiles', 'myMult2.c');
end
```

Open the Configuration Parameters dialog box.

On the **Solver** pane, select a fixed-step solver.

Save the model as `mymodel`.

Build the model.

The file `mymodel.h` contains this statement:

```
#include "myMult2.h"
```

To read more about integrating custom code in a MATLAB Function block, see “Integrate C Code by Using the MATLAB Function Block”.

Input Arguments

headerfile — Name of header file

character vector | string scalar

Name of a header file specified as a character vector or string scalar. `headerfile` must be a compile-time constant.

Enclose a system header file name in angle brackets < >. The generated `#include` statement for a system header file has the format `#include <sysheader>`. A system header file must be in a standard location or on the include path. Specify the include path by using code generation custom code parameters.

Example: `coder.cinclude('<sysheader.h>')`

For a header file that is not a system header file, omit the angle brackets. The generated `#include` statement for a header file that is not a system header file has the format `#include "myHeader"`. The header file must be in the current folder or on the include path. Specify the include path by using code generation custom code parameters.

Example: `coder.cinclude('myheader.h')`

Data Types: `char`

allfiles — All source files option

`true` | `false`

Option to include header file in all generated C/C++ source files. If `allfiles` is `true`, MATLAB Coder generates the include statement in almost all of the C/C++ source files, except for some utility files. If `allfiles` is `false`, the behavior is the same as the behavior of `coder.cinclude(headerfile)`.

In a MATLAB Function block, the code generator ignores the all source files option.

Data Types: `logical`

Limitations

- Do not call `coder.cinclude` inside run-time conditional constructs such as `if` statements, `switch` statements, `while`-loops, and `for`-loops. You can call `coder.cinclude` inside compile-time conditional statements, such as `coder.target`. For example:

```
...
if ~coder.target('MATLAB')
    coder.cinclude('foo.h');
    coder.ceval('foo');
end
...
```

Tips

- Before a `coder.ceval` call, call `coder.cinclude` to include the header file required by the external function that `coder.ceval` calls.
- Extraneous include statements in generated C/C++ code can increase compile time and reduce code readability. To avoid extraneous include statements in code generated by MATLAB Coder, follow these best practices:
 - Place a `coder.cinclude` call as close as possible to the `coder.ceval` call that requires the header file.
 - Do not set `allfiles` to `true`.

For the MATLAB Function block, the code generator generates the include statement in the model header file.

- In R2016a and earlier releases, for any `coder.cinclude` call, MATLAB Coder included the header file in almost all generated C/C++ source files, except for some utility files. If you have code that depends on this legacy behavior, you can preserve the legacy behavior by using this syntax:

```
coder.cinclude(headerfile,'InAllSourceFiles',true)
```

Extended Capabilities

C/C++ Code Generation

Generate C and C++ code using MATLAB® Coder™.

GPU Code Generation

Generate CUDA® code for NVIDIA® GPUs using GPU Coder™.

See Also

`coder.ceval` | `coder.target` | `coder.reservedName`

Topics

“Model Configuration Parameters: Code Generation Custom Code” (Simulink Coder)

Introduced in R2013a

coder.columnMajor

Specify column-major array layout for a function or class

Syntax

```
coder.columnMajor
```

Description

`coder.columnMajor` specifies column-major array layout for the data used by the current function in generated code. When placed in a class constructor, `coder.columnMajor` specifies column-major layout for data used by the class.

Note By default, code generation uses column-major array layout.

Examples

Specify Column-Major Array Layout for a Function

Specify column-major array layout for a function by inserting `coder.columnMajor` into the function body.

Suppose that `myFunction` is the top-level function of your code. Your application requires you to perform matrix addition with column-major array layout and matrix multiplication with row-major layout.

```
function S = myFunction(A,B)
%#codegen
% check to make sure inputs are valid
if size(A,1) ~= size(B,1) || size(A,2) ~= size(B,2)
    disp('Matrices must be same size.')
    return;
end
% make both matrices symmetric
B = B*B';
A = A*A';
% add matrices
S = addMatrix(A,B);
end
```

Write a function for matrix addition called `addMatrix`. Specify column-major for `addMatrix` by using `coder.columnMajor`.

```
function S = addMatrix(A,B)
%#codegen
S = zeros(size(A));
coder.columnMajor; % specify column-major array layout
S = A + B;
end
```

Generate code for `myFunction`. Use the `codegen` command.

```
codegen myFunction -args {ones(10,20),ones(10,20)} -config:lib -launchreport -rowmajor
```

Because of the `codegen -rowmajor` option, the matrix multiplication in `myFunction` uses row-major layout. However, the generated code for `addMatrix` uses column-major array layout due to the `coder.columnMajor` call.

Tips

- The code generator uses column-major array layout by default.
- The specification of array layout inside a function supersedes the array layout specified with the `codegen` command. For example, if the function `foo` contains `coder.columnMajor`, and you generate code by using:

```
codegen foo -rowmajor
```

then the generated code still uses column-major layout.
- Other functions called from within a column-major function inherit the column-major specification. However, if one of the called functions has its own distinct `coder.rowMajor` call, the code generator changes the array layout accordingly. If a row-major function and a column-major function call the same function, which does not have its own array layout specification, the code generator produces a row-major version and column-major version of the function.
- `coder.columnMajor` is ignored outside of code generation and simulation.

Extended Capabilities

C/C++ Code Generation

Generate C and C++ code using MATLAB® Coder™.

GPU Code Generation

Generate CUDA® code for NVIDIA® GPUs using GPU Coder™.

See Also

`coder.ceval` | `coder.rowMajor` | `coder.isColumnMajor` | `coder.isRowMajor`

Topics

“Interface with Row-Major Data in MATLAB Function Block”

“Specify Array Layout in Functions and Classes”

“Code Generation of Matrices and Arrays” (Simulink Coder)

Introduced in R2018a

coder.const

Fold expressions into constants in generated code

Syntax

```
out = coder.const(expression)
[out1,...,outN] = coder.const(handle,arg1,...,argN)
```

Description

`out = coder.const(expression)` evaluates `expression` and replaces `out` with the result of the evaluation in generated code.

`[out1,...,outN] = coder.const(handle,arg1,...,argN)` evaluates the multi-output function having handle `handle`. It then replaces `out1,...,outN` with the results of the evaluation in the generated code.

Examples

Specify Constants in Generated Code

This example shows how to specify constants in generated code using `coder.const`.

Write a function `AddShift` that takes an input `Shift` and adds it to the elements of a vector. The vector consists of the square of the first 10 natural numbers. `AddShift` generates this vector.

```
function y = AddShift(Shift) %#codegen
y = (1:10).^2+Shift;
```

Generate code for `AddShift` using the `codegen` command. Open the Code Generation Report.

```
codegen -config:lib -launchreport AddShift -args 0
```

The code generator produces code for creating the vector. It adds `Shift` to each element of the vector during vector creation. The definition of `AddShift` in generated code looks as follows:

```
void AddShift(double Shift, double y[10])
{
    int k;
    for (k = 0; k < 10; k++) {
        y[k] = (double)((1 + k) * (1 + k)) + Shift;
    }
}
```

Replace the expression `(1:10).^2` with `coder.const((1:10).^2)`, and then generate code for `AddShift` again using the `codegen` command. Open the Code Generation Report.

```
codegen -config:lib -launchreport AddShift -args 0
```

The code generator creates the vector containing the squares of the first 10 natural numbers. In the generated code, it adds `Shift` to each element of this vector. The definition of `AddShift` in generated code looks as follows:

```
void AddShift(double Shift, double y[10])
{
    int i;
    static const signed char iv[10] = { 1, 4, 9, 16, 25, 36,
                                        49, 64, 81, 100 };

    for (i = 0; i < 10; i++) {
        y[i] = (double)iv[i] + Shift;
    }
}
```

Create Lookup Table in Generated Code

This example shows how to fold a user-written function into a constant in generated code.

Write a function `getsine` that takes an input `index` and returns the element referred to by `index` from a lookup table of sines. The function `getsine` creates the lookup table using another function `gettable`.

```
function y = getsine(index) %#codegen
    assert(isa(index, 'int32'));
    persistent tbl;
    if isempty(tbl)
        tbl = gettable(1024);
    end
    y = tbl(index);

function y = gettable(n)
    y = zeros(1,n);
    for i = 1:n
        y(i) = sin((i-1)/(2*pi*n));
    end
```

Generate code for `getsine` using an argument of type `int32`. Open the Code Generation Report.

```
codegen -config:lib -launchreport getsine -args int32(0)
```

The generated code contains instructions for creating the lookup table.

Replace the statement:

```
tbl = gettable(1024);
```

with:

```
tbl = coder.const(gettable(1024));
```

Generate code for `getsine` using an argument of type `int32`. Open the Code Generation Report.

The generated code contains the lookup table itself. `coder.const` forces the expression `gettable(1024)` to be evaluated during code generation. The generated code does not contain instructions for the evaluation. The generated code contains the result of the evaluation itself.

Specify Constants in Generated Code Using Multi-Output Function

This example shows how to specify constants in generated code using a multi-output function in a `coder.const` statement.

Write a function `MultiplyConst` that takes an input `factor` and multiplies every element of two vectors `vec1` and `vec2` with `factor`. The function generates `vec1` and `vec2` using another function `EvalConsts`.

```
function [y1,y2] = MultiplyConst(factor) %#codegen
    [vec1,vec2]=EvalConsts(pi.*(1./2.^(1:10)),2);
    y1=vec1.*factor;
    y2=vec2.*factor;

function [f1,f2]=EvalConsts(z,n)
    f1=z.^(2*n)/factorial(2*n);
    f2=z.^(2*n+1)/factorial(2*n+1);
```

Generate code for `MultiplyConst` using the `codegen` command. Open the Code Generation Report.

```
codegen -config:lib -launchreport MultiplyConst -args 0
```

The code generator produces code for creating the vectors.

Replace the statement

```
[vec1,vec2]=EvalConsts(pi.*(1./2.^(1:10)),2);
```

with

```
[vec1,vec2]=coder.const(@EvalConsts,pi.*(1./2.^(1:10)),2);
```

Generate code for `MultiplyConst` using the `codegen` command. Open the Code Generation Report.

```
codegen -config:lib -launchreport MultiplyConst -args 0
```

The code generator does not generate code for creating the vectors. Instead, it calculates the vectors and specifies the calculated vectors in generated code.

Read Constants by Processing XML File

This example shows how to call an extrinsic function using `coder.const`.

Write an XML file `MyParams.xml` containing the following statements:

```
<params>
  <param name="hello" value="17"/>
  <param name="world" value="42"/>
</params>
```

Save `MyParams.xml` in the current folder.

Write a MATLAB function `xml2struct` that reads an XML file. The function identifies the XML tag `param` inside another tag `params`.

After identifying `param`, the function assigns the value of its attribute `name` to the field name of a structure `s`. The function also assigns the value of attribute `value` to the value of the field.

```
function s = xml2struct(file)

s = struct();
doc = xmlread(file);
els = doc.getElementsByTagName('params');
for i = 0:els.getLength-1
    it = els.item(i);
    ps = it.getElementsByTagName('param');
    for j = 0:ps.getLength-1
        param = ps.item(j);
        paramName = char(param.getAttribute('name'));
        paramValue = char(param.getAttribute('value'));
        paramValue = evalin('base', paramValue);
        s.(paramName) = paramValue;
    end
end
```

Save `xml2struct` in the current folder.

Write a MATLAB function `MyFunc` that reads the XML file `MyParams.xml` into a structure `s` using the function `xml2struct`. Declare `xml2struct` as extrinsic using `coder.extrinsic` and call it in a `coder.const` statement.

```
function y = MyFunc(u) %#codegen
    assert(isa(u, 'double'));
    coder.extrinsic('xml2struct');
    s = coder.const(xml2struct('MyParams.xml'));
    y = s.hello + s.world + u;
```

Generate code for `MyFunc` using the `codegen` command. Open the Code Generation Report.

```
codegen -config:dll -launchreport MyFunc -args 0
```

The code generator executes the call to `xml2struct` during code generation. It replaces the structure fields `s.hello` and `s.world` with the values 17 and 42 in generated code.

Input Arguments

expression — MATLAB expression or user-written function

expression with constants | single-output function with constant arguments

MATLAB expression or user-defined single-output function.

The expression must have compile-time constants only. The function must take constant arguments only. For instance, the following code leads to a code generation error, because `x` is not a compile-time constant.

```
function y=func(x)
    y=coder.const(log10(x));
```

To fix the error, assign `x` to a constant in the MATLAB code. Alternatively, during code generation, you can use `coder.Constant` to define input type as follows:

```
codegen -config:lib func -args coder.Constant(10)
```

Example: `2*pi, factorial(10)`

handle — Function handle

function handle

Handle to built-in or user-written function.

Example: `@log, @sin`

Data Types: `function_handle`

arg1, ..., argN — Arguments to the function with handle handle

function arguments that are constants

Arguments to the function with handle `handle`.

The arguments must be compile-time constants. For instance, the following code leads to a code generation error, because `x` and `y` are not compile-time constants.

```
function y=func(x,y)
    y=coder.const(@choosek,x,y);
```

To fix the error, assign `x` and `y` to constants in the MATLAB code. Alternatively, during code generation, you can use `coder.Constant` to define input type as follows:

```
codegen -config:lib func -args {coder.Constant(10),coder.Constant(2)}
```

Output Arguments

out — Value of expression

value of the evaluated expression

Value of expression. In the generated code, MATLAB Coder replaces occurrences of `out` with the value of expression.

out1, ..., outN — Outputs of the function with handle handle

values of the outputs of the function with handle `handle`

Outputs of the function with handle `handle`. MATLAB Coder evaluates the function and replaces occurrences of `out1, ..., outN` with constants in the generated code.

Tips

- When possible, the code generator constant-folds expressions automatically. Typically, automatic constant-folding occurs for expressions with scalars only. Use `coder.const` when the code generator does not constant-fold expressions on its own.
- When constant-folding computationally intensive function calls, to reduce code generation time, make the function call extrinsic. The extrinsic function call causes evaluation of the function call by MATLAB instead of by the code generator. For example:

```
function j = fcn(z)
zTable = coder.const(0:0.01:100);
jTable = coder.const(feval('besselj',3,zTable));
j = interp1(zTable,jTable,z);
end
```

See “Use coder.const with Extrinsic Function Calls” (MATLAB Coder).

- If `coder.const` is unable to constant-fold a function call, try to force constant-folding by making the function call extrinsic. The extrinsic function call causes evaluation of the function call by MATLAB instead of by the code generator. For example:

```
function yi = fcn(xi)
y = coder.const(feval('rand',1,100));
yi = interp1(y,xi);
end
```

See “Use coder.const with Extrinsic Function Calls” (MATLAB Coder).

Extended Capabilities

C/C++ Code Generation

Generate C and C++ code using MATLAB® Coder™.

GPU Code Generation

Generate CUDA® code for NVIDIA® GPUs using GPU Coder™.

See Also

Topics

“Fold Function Calls into Constants” (MATLAB Coder)

“Use coder.const with Extrinsic Function Calls” (MATLAB Coder)

Introduced in R2013b

coder.cstructname

Package: coder

Name C structure type in generated code

Syntax

```
coder.cstructname(var,structName)
coder.cstructname(var,structName,'extern','HeaderFile',headerfile)
coder.cstructname(var,structName,'extern','HeaderFile',
headerfile,'Alignment',alignment)

outtype = coder.cstructname(intype,structName)
outtype = coder.cstructname(intype,structName,'extern','HeaderFile',
headerfile)
outtype = coder.cstructname(intype,structName,'extern','HeaderFile',
headerfile,'Alignment',alignment)
```

Description

`coder.cstructname` names the generated or externally defined C structure type to use for MATLAB variables that are represented as structures in generated code.

`coder.cstructname(var,structName)` names the C structure type generated for the MATLAB variable `var`. The input `var` can be a structure or a cell array. Use this syntax in a function from which you generate code. Place `coder.cstructname` after the definition of `var` and before the first use of `var`. If `var` is an entry-point (top-level) function input argument, place `coder.cstructname` at the beginning of the function, before any control flow statements.

`coder.cstructname(var,structName,'extern','HeaderFile',headerfile)` specifies that the C structure type to use for `var` has the name `structName` and is defined in the external file, `headerfileName`.

It is possible to use the 'extern' option without specifying the header file. However, it is a best practice to specify the header file so that the code generator produces the `#include` statement in the correct location.

`coder.cstructname(var,structName,'extern','HeaderFile',headerfile,'Alignment',alignment)` also specifies the run-time memory alignment for the externally defined structure type `structName`. If you have Embedded Coder and use custom Code Replacement Libraries (CRLs), specify the alignment so that the code generator can match CRL functions that require alignment for structures. See “Data Alignment for Code Replacement” (Embedded Coder).

`outtype = coder.cstructname(intype,structName)` returns a structure or cell array type object `outtype` that specifies the name of the C structure type to generate. `coder.cstructname` creates `outtype` with the properties of the input type `intype`. Then, it sets the `TypeName` property to `structName`. Use this syntax to create a type object that you use with the `codegen -args` option. You cannot use this syntax in a function from which you generate code.

You cannot use this syntax in a MATLAB Function block.

`outtype = coder.cstructname(intype, structName, 'extern', 'HeaderFile', headerfile)` returns a type object `outtype` that specifies the name and location of an externally defined C structure type. The code generator uses the externally defined structure type for variables with type `outtype`.

You cannot use this syntax in a MATLAB Function block.

`outtype = coder.cstructname(intype, structName, 'extern', 'HeaderFile', headerfile, 'Alignment', alignment)` creates a type object `outtype` that also specifies the C structure type alignment.

You cannot use this syntax in a MATLAB Function block.

Examples

Name the C Structure Type for a Variable in a Function

In a MATLAB function, `myfun`, assign the name `MyStruct` to the generated C structure type for the variable `v`.

```
function y = myfun()
    %#codegen
    v = struct('a',1,'b',2);
    coder.cstructname(v, 'myStruct');
    y = v;
end
```

Generate standalone C code. For example, generate a static library.

```
codegen -config:lib myfun -report
```

To see the generated structure type, open `codegen/lib/myfun/myfun_types.h` or view `myfun_types.h` in the code generation report. The generated C structure type is:

```
typedef struct {
    double a;
    double b;
} myStruct;
```

Name the C Structure Type Generated for a Substructure

In a MATLAB function, `myfun1`, assign the name `MyStruct` to the generated C structure type for the structure `v`. Assign the name `mysubStruct` to the structure type generated for the substructure `v.b`.

```
function y = myfun()
    %#codegen
    v = struct('a',1,'b',struct('f',3));
    coder.cstructname(v, 'myStruct');
    coder.cstructname(v.b, 'mysubStruct');
    y = v;
end
```

The generated C structure type `mysubStruct` is:

```
typedef struct {
    double f;
} mysubStruct;
```

The generated C structure type `myStruct` is:

```
typedef struct {
    double a;
    mysubStruct b;
} myStruct;
```

Name the Structure Type Generated for a Cell Array

In a MATLAB function, `myfun2`, assign the name `myStruct` to the generated C structure type for the cell array `c`.

```
function z = myfun2()
c = {1 2 3};
coder.cstructname(c, 'myStruct')
z = c;
```

The generated C structure type for `c` is:

```
typedef struct {
    double f1;
    double f2;
    double f3;
} myStruct;
```

Name an Externally Defined C Structure Type

Specify that a structure passed to a C function has a structure type defined in a C header file.

Create a C header file `mycadd.h` for the function `mycadd` that takes a parameter of type `mycstruct`. Define the type `mycstruct` in the header file.

```
#ifndef MYCADD_H
#define MYCADD_H

typedef struct {
    double f1;
    double f2;
} mycstruct;

double mycadd(mycstruct *s);
#endif
```

Write the C function `mycadd.c`.

```
#include <stdio.h>
#include <stdlib.h>
```

```
#include "mycadd.h"

double mycadd(mycstruct *s)
{
    return s->f1 + s->f2;
}
```

Write a MATLAB function `mymAdd` that passes a structure by reference to `mycadd`. Use `coder.cstructname` to specify that in the generated code, the structure has the C type `mycstruct`, which is defined in `mycadd.h`.

```
function y = mymAdd
%#codegen
s = struct('f1', 1, 'f2', 2);
coder.cstructname(s, 'mycstruct', 'extern', 'HeaderFile', 'mycadd.h');
y = 0;
y = coder.ceval('mycadd', coder.ref(s));
```

Generate a C static library for function `mymAdd`.

```
codegen -config:lib mymAdd mycadd.c
```

The generated header file `mymadd_types.h` does not contain a definition of the structure `mycstruct` because `mycstruct` is an external type.

Create a Structure Type Object That Names the Generated C Structure Type

Suppose that the entry-point function `myFunction` takes a structure argument. To specify the type of the input argument at the command line:

- 1 Define an example structure `S`.
- 2 Create a type `T` from `S` by using `coder.typeof`.
- 3 Use `coder.cstructname` to create a type `T1` that:
 - Has the properties of `T`.
 - Names the generated C structure type `myStruct`.
- 4 Pass the type to `codegen` by using the `-args` option.

For example:

```
S = struct('a',double(0),'b',single(0));
T = coder.typeof(S);
T1 = coder.cstructname(T,'myStruct');
codegen -config:lib myFunction -args T1
```

Alternatively, you can create the structure type directly from the example structure.

```
S = struct('a',double(0),'b',single(0));
T1 = coder.cstructname(S,'myStruct');
codegen -config:lib myFunction -args T1
```

Input Arguments

var — MATLAB structure or cell array variable

structure | cell array

MATLAB structure or cell array variable that is represented as a structure in the generated code.

structName — Name of C structure type

character vector | string scalar

Name of generated or externally defined C structure type, specified as a character vector or string scalar.

headerfile — Header file that contains the C structure type definition

character vector | string scalar

Header file that contains the C structure type definition, specified as a character vector or string scalar.

To specify the path to the file:

- Use the `codegen -I` option or the **Additional include directories** parameter on the MATLAB Coder app settings **Custom Code** tab.
- For a MATLAB Function block, on the **Simulation Target** and the **Code Generation > Custom Code** panes, under **Additional build information**, set the **Include directories** parameter.

Alternatively, use `coder.updateBuildInfo` with the `'addIncludePaths'` option.

Example: `'mystruct.h'`

alignment — Run-time memory alignment for structure

-1 (default) | power of 2 not greater than 128

Run-time memory alignment for generated or externally defined structure.

intype — Type object or variable for creation of new type object

`coder.StructType` | `coder.CellType` | structure | cell array

Structure type object, cell array type object, structure variable, or cell array variable from which to create a type object.

Limitations

- You cannot apply `coder.cstructname` directly to a global variable. To name the structure type to use with a global variable, use `coder.cstructname` to create a type object that names the structure type. Then, when you run `codegen`, specify that the global variable has that type. See “Name the C Structure Type to Use With a Global Structure Variable” (MATLAB Coder).
- For cell array inputs, the field names of externally defined structures must be `f1`, `f2`, and so on.
- You cannot apply `coder.cstructname` directly to a class property.

Tips

- For information about how the code generator determines the C/C++ types of structure fields, see “Mapping MATLAB Types to Types in Generated Code” (MATLAB Coder).
- Using `coder.cstructname` on a structure array sets the name of the structure type of the base element, not the name of the array. Therefore, you cannot apply `coder.cstructname` to a structure array element, and then apply it to the array with a different C structure type name. For example, the following code is not allowed. The second `coder.cstructname` attempts to set the name of the base type to `myStructArrayName`, which conflicts with the previously specified name, `myStructName`.

```
% Define scalar structure with field a
myStruct = struct('a', 0);
coder.cstructname(myStruct, 'myStructName');
% Define array of structure with field a
myStructArray = repmat(myStruct,4,6);
coder.cstructname(myStructArray, 'myStructArrayName');
```

- Applying `coder.cstructname` to an element of a structure array produces the same result as applying `coder.cstructname` to the entire structure array. If you apply `coder.cstructname` to an element of a structure array, you must refer to the element by using a single subscript. For example, you can use `var(1)`, but not `var(1,1)`. Applying `coder.cstructname` to `var(:)` produces the same result as applying `coder.cstructname` to `var` or `var(n)`.
- Heterogeneous cell arrays are represented as structures in the generated code. Here are considerations for using `coder.cstructname` with cell arrays:
 - In a function from which you generate code, using `coder.cstructname` with a cell array variable makes the cell array heterogeneous. Therefore, if a cell array is an entry-point function input and its type is permanently homogeneous, then you cannot use `coder.cstructname` with the cell array.
 - Using `coder.cstructname` with a homogeneous `coder.CellType` object `intype` makes the returned object heterogeneous. Therefore, you cannot use `coder.cstructname` with a permanently homogeneous `coder.CellType` object. For information about when a cell array is permanently homogeneous, see “Specify Cell Array Inputs at the Command Line” (MATLAB Coder).
 - When used with a `coder.CellType` object, `coder.cstructname` creates a `coder.CellType` object that is permanently heterogeneous.
- When you use a structure named by `coder.cstructname` in a project with row-major and column-major array layouts, the code generator renames the structure in certain cases, appending `row_` or `col_` to the beginning of the structure name. This renaming provides unique type definitions for the types that are used in both array layouts.
- These tips apply only to MATLAB Function blocks:
 - MATLAB Function block input and output structures are associated with bus signals. The generated name for the structure type comes from the bus signal name. Do not use `coder.cstructname` to name the structure type for input or output signals. See “Create Structures in MATLAB Function Blocks”.
 - The code generator produces structure type names according to identifier naming rules, even if you name the structure type with `coder.cstructname`. If you have Embedded Coder, you can customize the naming rules. See “Construction of Generated Identifiers” (Embedded Coder).

Extended Capabilities

C/C++ Code Generation

Generate C and C++ code using MATLAB® Coder™.

GPU Code Generation

Generate CUDA® code for NVIDIA® GPUs using GPU Coder™.

See Also

`coder.ceval`

Topics

“Structure Definition for Code Generation”

“Code Generation for Cell Arrays”

“Integrate C Code by Using the MATLAB Function Block”

Introduced in R2011a

coder.extrinsic

Declare a function as extrinsic and execute it in MATLAB

Syntax

```
coder.extrinsic(function)
coder.extrinsic(function1, ... ,functionN)

coder.extrinsic('-sync:on', function1, ... ,functionN)
coder.extrinsic('-sync:off', function1, ... ,functionN)
```

Description

`coder.extrinsic(function)` declares `function` as an extrinsic function. The code generator does not produce code for the body of the extrinsic function and instead uses the MATLAB engine to execute the call. This functionality is available only when the MATLAB engine is available during execution. Examples of situations during which the MATLAB engine is available include execution of MEX functions, Simulink simulations, or function calls at the time of code generation (also known as compile time).

During standalone code generation, the code generator attempts to determine whether an extrinsic function affects the output of the function in which it is called — for example by returning `mxArrays` to an output variable. Provided that there is no change to the output, the code generator proceeds with code generation, but excludes the extrinsic function from the generated code. Otherwise, the code generator produces a compilation error.

You cannot use `coder.ceval` on functions that you declare as extrinsic by using `coder.extrinsic`.

`coder.extrinsic` is ignored outside of code generation.

Note The code generator automatically treats many common MATLAB visualization functions, such as `plot`, `disp`, and `figure`, as extrinsic. You do not have to explicitly declare them as extrinsic functions by using `coder.extrinsic`.

`coder.extrinsic(function1, ... ,functionN)` declares `function1` through `functionN` as extrinsic functions.

`coder.extrinsic('-sync:on', function1, ... ,functionN)` enables synchronization of global data between MATLAB execution and generated code execution or Simulink simulation before and after calls to the extrinsic functions `function1` through `functionN`. If only a few extrinsic calls use or modify global data, turn off synchronization before and after all extrinsic function calls by setting the global synchronization mode to `At MEX-function entry and exit`. Use the `'-sync:on'` option to turn on synchronization for only the extrinsic calls that do modify global data.

See “Generate Code for Global Data” (MATLAB Coder).

`coder.extrinsic('-sync:off', function1, ... ,functionN)` disables synchronization of global data between MATLAB execution and generated code execution before and after calls to the

extrinsic functions `function1` through `functionN`. If most extrinsic calls use or modify global data, but a few do not, use the `'-sync:off'` option to turn off synchronization for the extrinsic calls that do not modify global data.

See “Generate Code for Global Data” (MATLAB Coder).

Examples

Declare a MATLAB Visualization Function as Extrinsic

The MATLAB function `patch` is not supported for code generation. This example shows how you can still use the functionality of `patch` in your generated MEX function by declaring `patch` as extrinsic your MATLAB function.

This MATLAB code declares `patch` as extrinsic in the local function `create_plot`. By declaring `patch` as extrinsic, you instruct the code generator not to produce code for `patch`. Instead, the code generator dispatches `patch` to MATLAB for execution.

The code generator automatically treats many common MATLAB visualization functions, such as the function `axis` as extrinsic.

```
function c = pythagoras(a,b,color) %#codegen
% Calculate the hypotenuse of a right triangle
% and display the triangle as a patch object.
c = sqrt(a^2 + b^2);
create_plot(a, b, color);
end
```

```
function create_plot(a, b, color)
%Declare patch as extrinsic
coder.extrinsic('patch');
x = [0;a;a];
y = [0;0;b];
patch(x,y,color);
axis('equal');
end
```

Generate a MEX function for `pythagoras`. Also, generate the code generation report.

```
codegen -report pythagoras -args {1, 1, [.3 .3 .3]}
```

In the report, view the MATLAB code for `create_plot`.

```
7 function create_plot(a, b, color)
8 coder.extrinsic('patch');
9 x = [0;a;a];
10 y = [0;0;b];
11 patch(x,y,color);
12 axis('equal');
13 end
```

The report highlights the `patch` and `axis` functions to indicate that they are treated as extrinsic functions.

Run the MEX function.

```
pythagoras_mex(3, 4, [1.0 0.0 0.0]);
```

MATLAB displays the plot of the right triangle as a red patch object.

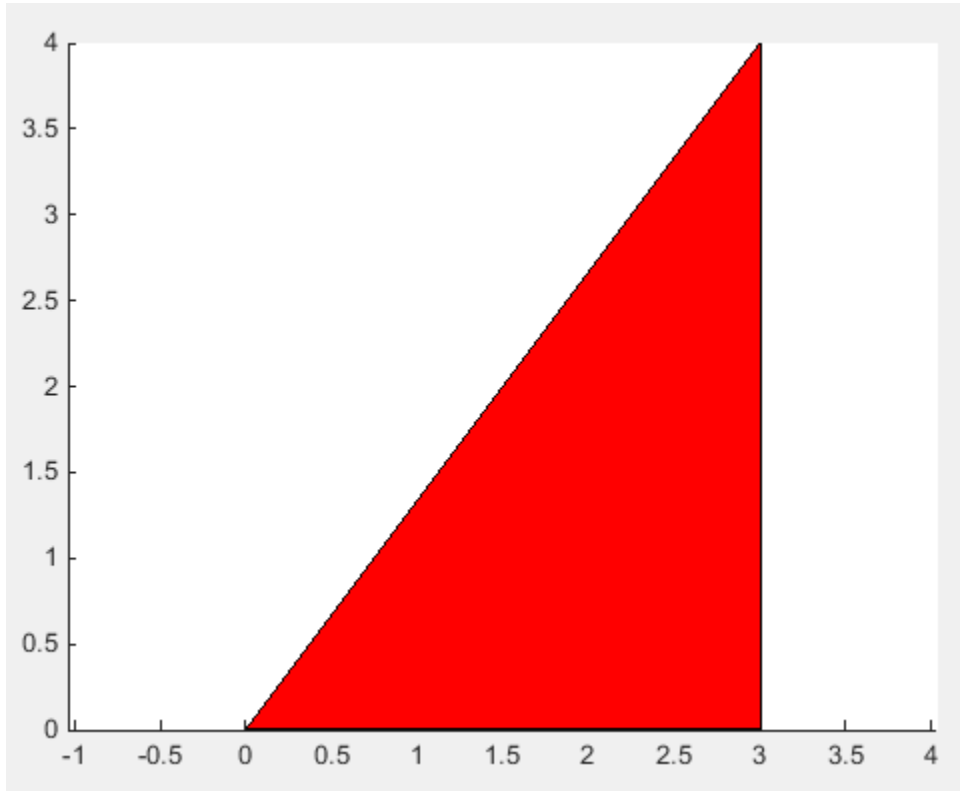

Note Instead of generating a MEX file by using the `codegen` command, you could also place the function `pythagoras` inside a MATLAB Function block in a Simulink model. When you simulate the model, the MATLAB Function block has similar behavior as `pythagoras_mex`.

Declare MATLAB Graph Functions as Extrinsic

Certain MATLAB functions for graph and network algorithms are not supported for code generation. This example shows how you can still use these functions in your generated MEX code by declaring them as extrinsic.

Define a MATLAB function `foo` that accepts source and target node indices for a directed graph as inputs and determines if the graph is acyclic. The function `foo` also plots the directed graph.

The function `foo` contains calls to the functions `plot`, `hascycles`, and `isdag` that are not supported for code generation. These three functions are explicitly declared to be extrinsic by using the `coder.extrinsic` construct.

```
function [hasCycles,isDAG] = foo(source,target)
coder.extrinsic('hascycles','isdag','plot');
```



```
assert(numel(source) == numel(target))
G = digraph(source,target);
plot(G)
hasCycles = hascycles(G);
isDAG = isdag(G);
end
```

Generate MEX code for `foo`. Specify the inputs to be unbounded vectors of type double.

```
codegen foo -args {coder.typeof(0,Inf),coder.typeof(0,Inf)}
```

Call the generated MEX function `foo_mex` with suitable inputs:

```
[out1,out2] = foo_mex([1 2 4 4],[2 3 3 1])
```

```
out1 =
```

```
    logical
```

```
    0
```

```
out2 =
```

```
    logical
```

```
    1
```

MATLAB also displays the graph:

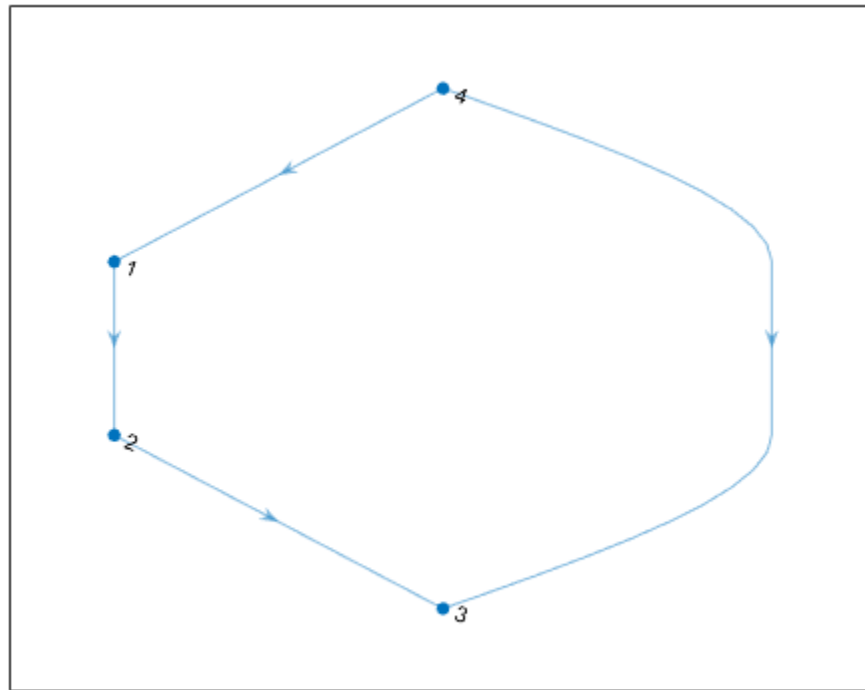

Input Arguments

function – MATLAB function name

character vector

Name of the MATLAB function that is declared as extrinsic.

Example: `coder.extrinsic('patch')`

Data Types: char

Limitations

- Extrinsic function calls have some overhead that can affect performance. Input data that is passed in an extrinsic function call must be provided to MATLAB, which requires making a copy of the data. If the function has any output data, this data must be transferred back into the MEX function environment, which also requires a copy.
- The code generator does not support the use of `coder.extrinsic` to call functions that are located in a private folder.
- The code generator does not support the use of `coder.extrinsic` to call local functions.

Tips

- The code generator automatically treats many common MATLAB visualization functions, such as `plot`, `disp`, and `figure`, as extrinsic. You do not have to explicitly declare them as extrinsic functions by using `coder.extrinsic`.
- Use the `coder.screener` function to detect which functions you must declare as extrinsic. This function runs the Code Generation Readiness Tool that screens the MATLAB code for features and functions that are not supported for code generation.

Extended Capabilities

C/C++ Code Generation

Generate C and C++ code using MATLAB® Coder™.

GPU Code Generation

Generate CUDA® code for NVIDIA® GPUs using GPU Coder™.

See Also

`coder.ceval` | `coder.screener`

Topics

“Use MATLAB Engine to Execute a Function Call in Generated Code”

“Generate Code for Global Data” (MATLAB Coder)

“Resolution of Function Calls for Code Generation”

Introduced in R2011a

coder.ignoreConst

Prevent use of constant value of expression for function specializations

Syntax

```
coder.ignoreConst(expression)
```

Description

`coder.ignoreConst(expression)` prevents the code generator from using the constant value of expression to create function specializations on page 2-100. `coder.ignoreConst(expression)` returns the value of expression.

Examples

Prevent Function Specializations Based on Constant Input Values

Use `coder.ignoreConst` to prevent function specializations for a function that is called with constant values.

Write the function `call_myfcn`, which calls `myfcn`.

```
function [x, y] = call_myfcn(n)
    %#codegen
    x = myfcn(n, 'mode1');
    y = myfcn(n, 'mode2');
end

function y = myfcn(n,mode)
    coder.inline('never');
    if strcmp(mode, 'mode1')
        y = n;
    else
        y = -n;
    end
end
```

Generate standalone C code. For example, generate a static library. Enable the code generation report.

```
codegen -config:lib call_myfcn -args {1} -report
```

In the code generation report, you see two function specializations for `call_myfcn`.

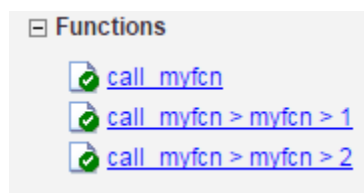

The code generator creates `call_myfcn>myfcn>1` for `mode` with a value of `'mode1'`. It creates `call_myfcn>myfcn>2` for `mode` with a value of `'mode2'`.

In the generated C code, you see the specializations `my_fcn` and `b_my_fcn`.

```
static double b_myfcn(double n)
{
    return -n;
}

static double myfcn(double n)
{
    return n;
}
```

To prevent the function specializations, instruct the code generator to ignore that values of the `mode` argument are constant.

```
function [x, y] = call_myfcn(n)
%#codegen
x = myfcn(n, coder.ignoreConst('mode1'));
y = myfcn(n, coder.ignoreConst('mode2'));
end

function y = myfcn(n,mode)
coder.inline('never');
if strcmp(mode,'mode1')
    y = n;
else
    y = -n;
end
end
```

Generate the C code.

```
codegen -config:lib call_myfcn -args {1} -report
```

In the code generation report, you do not see multiple function specializations.

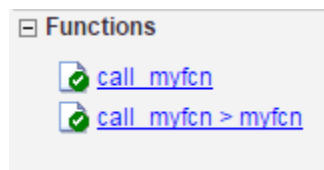

In the generated C code, you see one function for `my_fcn`.

Input Arguments

expression — Expression whose value is to be treated as a nonconstant

MATLAB expression

Expression whose value is to be treated as a nonconstant, specified as a MATLAB expression.

More About

Function Specialization

Version of a function in which an input type, size, complexity, or value is customized for a particular invocation of the function.

Function specialization produces efficient C code at the expense of code duplication. The code generation report shows all MATLAB function specializations that the code generator creates. However, the specializations might not appear in the generated C/C++ code due to later transformations or optimizations.

Tips

- For some recursive function calls, you can use `coder.ignoreConst` to force run-time recursion. See “Force Code Generator to Use Run-Time Recursion”.
- `coder.ignoreConst(expression)` prevents the code generator from using the constant value of `expression` to create function specializations. It does not prevent other uses of the constant value during code generation.

Extended Capabilities

C/C++ Code Generation

Generate C and C++ code using MATLAB® Coder™.

GPU Code Generation

Generate CUDA® code for NVIDIA® GPUs using GPU Coder™.

See Also

`coder.inline` | `coder.ignoreSize`

Topics

“Force Code Generator to Use Run-Time Recursion”

“Compile-Time Recursion Limit Reached”

“Avoid Duplicate Functions in Generated Code”

Introduced in R2017a

coder.ignoreSize

Package: coder

Prevent code generator from creating function specializations for constant-size expressions

Syntax

```
coder.ignoreSize(expression)
```

Description

`coder.ignoreSize(expression)` declares that the code generator must not use the constant size of an expression to create function specializations.

Examples

Duplicate Functions Generated for Multiple Input Sizes

If your MATLAB code calls a function multiple times and passes inputs of different sizes, the code generator can create function specializations for each size. To avoid this issue, use `coder.ignoreSize` on the function input. For example, this code uses `coder.ignoreSize` to avoid creating multiple copies of the function `indexOf`:

```
function [out1, out2] = test1(in)
    a = 1:10;
    b = 2:40;
    % Without coder.ignoreSize duplicate functions are generated
    out1 = indexOf(coder.ignoreSize(a), in);
    out2 = indexOf(coder.ignoreSize(b), in);
end

function index = indexOf(array, value)
    coder.inline('never');
    for i = 1:numel(array)
        if array(i) == value
            index = i;
            return
        end
    end
    index = -1;
    return
end
```

To generate code, enter:

```
codegen test1 -config:lib -report -args {1}
```

Input Arguments

expression — Expression whose size is to be treated as nonconstant
MATLAB expression

Example: `foo(coder.ignoreSize(1:10))`

More About

Function Specialization

Version of a function in which an input type, size, complexity, or value is customized for a particular invocation of the function.

Function specialization produces efficient C code at the expense of code duplication. The code generation report shows all MATLAB function specializations that the code generator creates. However, the specializations might not appear in the generated C/C++ code due to later transformations or optimizations.

Tips

- If you assign an expression to a variable and declare the variable as variable-size by using `coder.varsizes`, this declaration has the same effect as using `coder.ignoreSize` on the expression.

Extended Capabilities

C/C++ Code Generation

Generate C and C++ code using MATLAB® Coder™.

GPU Code Generation

Generate CUDA® code for NVIDIA® GPUs using GPU Coder™.

See Also

`coder.ignoreConst`

Topics

“Avoid Duplicate Functions in Generated Code”

Introduced in R2019b

coder.inline

Control inlining of a specific function in generated code

Syntax

```
coder.inline('always')
coder.inline('never')
coder.inline('default')
```

Description

`coder.inline('always')` forces inlining on page 2-104 of the current function in the generated code. Place the `coder.inline` directive inside the function that you want to inline. The code generator does not inline entry-point functions and recursive functions. Also, the code generator does not inline functions into `parfor` loops, or inline functions called from `parfor` loops.

`coder.inline('never')` prevents inlining of the current function in the generated code. Prevent inlining when you want to simplify the mapping between the MATLAB source code and the generated code.

Note If you use the `codegen` or the `fiaccel` command, you can disable inlining for all functions by using the `-O disable:inline` option.

If you generate C/C++ code by using the `codegen` command or the MATLAB Coder app, you might have different speed and readability requirements for the code generated for functions that you write and the code generated for MathWorks® functions. Certain additional global settings enable you to separately control the inlining behavior for these two parts of the generated code base and at the boundary between them. See .

`coder.inline('default')` instructs the code generator to use internal heuristics to determine whether to inline the current function. Usually, the heuristics produce highly optimized code. Use `coder.inline` explicitly in your MATLAB functions only when you need to fine-tune these optimizations.

Examples

Prevent Function Inlining

In this example, function `foo` is not inlined in the generated code:

```
function y = foo(x)
    coder.inline('never');
    y = x;
end
```

Use `coder.inline` in Control Flow Statements

You can use `coder.inline` in control flow code. If the software detects contradictory `coder.inline` directives, the generated code uses the default inlining heuristic and issues a warning.

Suppose that you want to generate code for a division function that runs on a system with limited memory. To optimize memory use in the generated code, the `inline_division` function manually controls inlining based on whether it performs scalar division or vector division:

```
function y = inline_division(dividend, divisor)

% For scalar division, inlining produces smaller code
% than the function call itself.
if isscalar(dividend) && isscalar(divisor)
    coder.inline('always');
else
% Vector division produces a for-loop.
% Prohibit inlining to reduce code size.
    coder.inline('never');
end

if any(divisor == 0)
    error('Cannot divide by 0');
end

y = dividend / divisor;
```

More About

Inlining

Technique that replaces a function call with the contents (body) of that function. Inlining eliminates the overhead of a function call, but can produce larger C/C++ code. Inlining can create opportunities for further optimization of the generated C/C++ code.

Extended Capabilities

C/C++ Code Generation

Generate C and C++ code using MATLAB® Coder™.

GPU Code Generation

Generate CUDA® code for NVIDIA® GPUs using GPU Coder™.

See Also

Introduced in R2011a

coder.isColumnMajor

Determine whether the current function or variable uses column-major layout

Syntax

```
coder.isColumnMajor
coder.isColumnMajor(arg)
```

Description

`coder.isColumnMajor` resolves as true in the generated code if the current function uses column-major array layout. Use the function as the expression in control flow (`if`, `else`, `switch`) statements.

`coder.isColumnMajor(arg)` resolves as true if the current variable uses column-major array layout.

Examples

Query Array Layout of a Function

To query the array layout of a function at compile time, use `coder.isColumnMajor` or `coder.isRowMajor`. This query can be useful for specializing your generated code when it involves row-major and column-major functions. For example, consider this function:

```
function S = addMatrixRouted(A,B)
    if coder.isRowMajor
        %execute this code if row major
        S = addMatrix_OptimizedForRowMajor(A,B);
    elseif coder.isColumnMajor
        %execute this code if column major
        S = addMatrix_OptimizedForColumnMajor(A,B);
    end
```

The function `addMatrixRouted` behaves differently depending on whether it uses row-major layout or column-major layout. The layout that the function uses, for example, can depend on whether it is called from a function that contains `coder.rowMajor` or `coder.columnMajor`. When `addMatrixRouted` uses row-major layout, it calls the `addMatrix_OptimizedForRowMajor` function, which has efficient memory access for row-major data. When the function uses column-major layout, it calls a version of the `addMatrix` function optimized for column-major data.

By using the query functions, the generated code for `addMatrixRouted` provides efficient memory access for either choice of array layout.

Query Array Layout of a Variable

Consider the function `bar`:

```
function bar
    coder.columnMajor;
```

```
x = magic(3);
if coder.isColumnMajor(x)
    fprintf('This will always be displayed in generated code.\n');
else
    fprintf('This will never be displayed in generated code.\n');
end
end
```

Generate code:

```
codegen bar
```

To run the MEX function, enter:

```
bar_mex
```

Input Arguments

arg — Variable name

array variable

Variable to query for array layout.

Example: `coder.isColumnMajor(x)`;

Limitations

- You cannot query the array layout of a structure field or property.

Tips

- The code generator uses column-major layout by default.
- Outside of code generation and simulation, `coder.isColumnMajor` is always true.
- If `coder.isColumnMajor` always resolves to true for your code, other branches in the `if` statement are ignored by the code generator. Otherwise, one instance of the current function is created for each array layout.

Extended Capabilities

C/C++ Code Generation

Generate C and C++ code using MATLAB® Coder™.

GPU Code Generation

Generate CUDA® code for NVIDIA® GPUs using GPU Coder™.

See Also

`coder.ceval` | `coder.rowMajor` | `coder.columnMajor` | `coder.isRowMajor`

Topics

“Interface with Row-Major Data in MATLAB Function Block”

“Specify Array Layout in Functions and Classes”

“Code Generation of Matrices and Arrays” (Simulink Coder)

Introduced in R2018a

coder.isRowMajor

Determine whether the current function or variable uses row-major layout

Syntax

```
coder.isRowMajor
coder.isRowMajor(arg)
```

Description

`coder.isRowMajor` resolves as true in the generated code if the current function uses row-major array layout. Use the function as the expression in control flow (`if`, `else`, `switch`) statements.

`coder.isRowMajor(arg)` resolves as true if the current variable uses row-major array layout.

Examples

Query Array Layout of a Function

To query the array layout of a function at compile time, use `coder.isRowMajor` or `coder.isColumnMajor`. This query can be useful for specializing your generated code when it involves row-major and column-major functions. For example, consider this function:

```
function S = addMatrixRouted(A,B)
    if coder.isRowMajor
        %execute this code if row major
        S = addMatrix_OptimizedForRowMajor(A,B);
    elseif coder.isColumnMajor
        %execute this code if column major
        S = addMatrix_OptimizedForColumnMajor(A,B);
    end
```

The function `addMatrixRouted` behaves differently depending on whether it uses row-major layout or column-major layout. The layout that the function uses, for example, can depend on whether it is called from a function that contains `coder.rowMajor` or `coder.columnMajor`. When `addMatrixRouted` uses row-major layout, it calls the `addMatrix_OptimizedForRowMajor` function, which has efficient memory access for row-major data. When the function uses column-major layout, it calls a version of the `addMatrix` function optimized for column-major data.

By using the query functions, the generated code for `addMatrixRouted` provides efficient memory access for either choice of array layout.

Query Array Layout of a Variable

Consider the function `foo`:

```
function foo
    coder.rowMajor;
```

```
x = magic(3);  
if coder.isRowMajor(x)  
    fprintf('This will always be displayed in generated code.\n');  
else  
    fprintf('This will never be displayed in generated code.\n');  
end  
end
```

Generate code:

```
codegen foo
```

To run the MEX function, enter:

```
foo_mex
```

Input Arguments

arg — Variable name

array variable

Variable to query for array layout.

Example: `coder.isRowMajor(x)`;

Limitations

- You cannot query the array layout of a structure field or property.

Tips

- Outside of code generation and simulation, `coder.isRowMajor` is always false.
- If `coder.isRowMajor` always resolves to true for your code, other branches in the `if` statement are ignored by the code generator. Otherwise, one instance of the current function is created for each array layout.

Extended Capabilities

C/C++ Code Generation

Generate C and C++ code using MATLAB® Coder™.

GPU Code Generation

Generate CUDA® code for NVIDIA® GPUs using GPU Coder™.

See Also

`coder.ceval` | `coder.rowMajor` | `coder.columnMajor` | `coder.isColumnMajor`

Topics

“Interface with Row-Major Data in MATLAB Function Block”

“Specify Array Layout in Functions and Classes”

“Code Generation of Matrices and Arrays” (Simulink Coder)

Introduced in R2018a

coder.load

Load compile-time constants from MAT-file or ASCII file into caller workspace

Syntax

```
S = coder.load(filename)
S = coder.load(filename,var1,...,varN)
S = coder.load(filename,'-regex',expr1,...,exprN)
S = coder.load(filename,'-ascii')
S = coder.load(filename,'-mat')
S = coder.load(filename,'-mat',var1,...,varN)
S = coder.load(filename,'-mat','-regex', expr1,...,exprN)
```

Description

`S = coder.load(filename)` loads compile-time constants from `filename`.

- If `filename` is a MAT-file, then `coder.load` loads variables from the MAT-file into a structure array.
- If `filename` is an ASCII file, then `coder.load` loads data into a double-precision array.

`coder.load` loads data at code generation time, also referred to as *compile time*. If you change the content of `filename` after you generate code, the change is not reflected in the behavior of the generated code.

`S = coder.load(filename,var1,...,varN)` loads only the specified variables from the MAT-file `filename`.

`S = coder.load(filename,'-regex',expr1,...,exprN)` loads only the variables that match the specified regular expressions.

`S = coder.load(filename,'-ascii')` treats `filename` as an ASCII file, regardless of the file extension.

`S = coder.load(filename,'-mat')` treats `filename` as a MAT-file, regardless of the file extension.

`S = coder.load(filename,'-mat',var1,...,varN)` treats `filename` as a MAT-file and loads only the specified variables from the file.

`S = coder.load(filename,'-mat','-regex', expr1,...,exprN)` treats `filename` as a MAT-file and loads only the variables that match the specified regular expressions.

Examples

Load compile-time constants from MAT-file

Generate code for a function `edgeDetect1` which given a normalized image, returns an image where the edges are detected with respect to the threshold value. `edgeDetect1` uses `coder.load` to load the edge detection kernel from a MAT-file at compile time.

Save the Sobel edge-detection kernel in a MAT-file.

```
k = [1 2 1; 0 0 0; -1 -2 -1];
```

```
save sobel.mat k
```

Write the function `edgeDetect1`.

```
function edgeImage = edgeDetect1(originalImage, threshold) %#codegen
assert(all(size(originalImage) <= [1024 1024]));
assert(isa(originalImage, 'double'));
assert(isa(threshold, 'double'));

S = coder.load('sobel.mat', 'k');
H = conv2(double(originalImage), S.k, 'same');
V = conv2(double(originalImage), S.k', 'same');
E = sqrt(H.*H + V.*V);
edgeImage = uint8((E > threshold) * 255);
```

Create a code generation configuration object for a static library.

```
cfg = coder.config('lib');
```

Generate a static library for `edgeDetect1`.

```
codegen -report -config cfg edgeDetect1
```

`codegen` generates C code in the `codegen\lib\edgeDetect1` folder.

Load compile-time constants from ASCII file

Generate code for a function `edgeDetect2` which given a normalized image, returns an image where the edges are detected with respect to the threshold value. `edgeDetect2` uses `coder.load` to load the edge detection kernel from an ASCII file at compile time.

Save the Sobel edge-detection kernel in an ASCII file.

```
k = [1 2 1; 0 0 0; -1 -2 -1];
```

```
save sobel.dat k -ascii
```

Write the function `edgeDetect2`.

```
function edgeImage = edgeDetect2(originalImage, threshold) %#codegen
assert(all(size(originalImage) <= [1024 1024]));
assert(isa(originalImage, 'double'));
assert(isa(threshold, 'double'));

k = coder.load('sobel.dat');
H = conv2(double(originalImage), k, 'same');
V = conv2(double(originalImage), k', 'same');
```

```
E = sqrt(H.*H + V.*V);
edgeImage = uint8((E > threshold) * 255);
```

Create a code generation configuration object for a static library.

```
cfg = coder.config('lib');
```

Generate a static library for `edgeDetect2`.

```
codegen -report -config cfg edgeDetect2
```

codegen generates C code in the `codegen\lib\edgeDetect2` folder.

Input Arguments

filename — Name of file

character vector | string scalar

Name of file. `filename` must be a compile-time constant.

`filename` can include a file extension and a full or partial path. If `filename` has no extension, `load` looks for a file named `filename.mat`. If `filename` has an extension other than `.mat`, `load` treats the file as ASCII data.

ASCII files must contain a rectangular table of numbers, with an equal number of elements in each row. The file delimiter (the character between elements in each row) can be a blank, comma, semicolon, or tab character. The file can contain MATLAB comments (lines that begin with a percent sign, %).

Example: `'myFile.mat'`

var1, ..., varN — Names of variables to load

character vector | string scalar

Names of variables, specified as one or more character vectors or string scalars. Each variable name must be a compile-time constant. Use the `*` wildcard to match patterns.

Example: `coder.load('myFile.mat', 'A*')` loads all variables in the file whose names start with `A`.

expr1, ..., exprN — Regular expressions indicating which variables to load

character vector | string scalar

Regular expressions indicating which variables to load specified as one or more character vectors or string scalars. Each regular expression must be a compile-time constant.

Example: `coder.load('myFile.mat', '-regexp', '^A')` loads only variables whose names begin with `A`.

Output Arguments

S — Loaded variables or data

structure array | m-by-n array

If `filename` is a MAT-file, `S` is a structure array.

If `filename` is an ASCII file, `S` is an `m`-by-`n` array of type `double`. `m` is the number of lines in the file and `n` is the number of values on a line.

Limitations

- Arguments to `coder.load` must be compile-time constants.
- The output `S` must be the name of a structure or array without any subscripting. For example, `S(i) = coder.load('myFile.mat')` is not allowed.
- You cannot use `save` to save workspace data to a file inside a function intended for code generation. The code generator does not support the `save` function. Furthermore, you cannot use `coder.extrinsic` with `save`. Prior to generating code, you can use `save` to save workspace data to a file.

Tips

- `coder.load` loads data at compile time, not at run time. If you are generating MEX code or code for Simulink simulation, you can use the MATLAB function `load` to load run-time values.
- If the MAT-file contains unsupported constructs, use `coder.load(filename, var1, ..., varN)` to load only the supported constructs.
- If you generate code in a MATLAB Coder project, the code generator practices incremental code generation for the `coder.load` function. When the MAT-file or ASCII file used by `coder.load` changes, the software rebuilds the code.

Extended Capabilities

C/C++ Code Generation

Generate C and C++ code using MATLAB® Coder™.

GPU Code Generation

Generate CUDA® code for NVIDIA® GPUs using GPU Coder™.

See Also

`matfile` | `regexp` | `save`

Topics

“Regular Expressions”

Introduced in R2013a

coder.nullcopy

Package: coder

Declare uninitialized variables in code generation

Syntax

```
X = coder.nullcopy(A)
```

Description

`X = coder.nullcopy(A)` copies type, size, and complexity of `A` to `X`, but does not copy element values. The function preallocates memory for `X` without incurring the overhead of initializing memory. In code generation, the `coder.nullcopy` function declares uninitialized variables. In MATLAB, `coder.nullcopy` returns the input such that `X` is equal to `A`.

If `X` is a structure or a class containing variable-sized arrays, then you must assign the size of each array. `coder.nullcopy` does not copy sizes of arrays or nested arrays from its argument to its result.

Note Before you use `X` in a function or a program, ensure that the data in `X` is completely initialized. Declaring a variable through `coder.nullcopy` without assigning all the elements of the variable results in nondeterministic program behavior. For more information, see “How to Eliminate Redundant Copies by Defining Uninitialized Variables”.

Examples

Declare Variables for Optimized Initialization

Declare variable `X` as a 1-by-5 vector of real doubles without performing an unnecessary initialization:

```
function X = foo %#codegen

N = 5;
X = coder.nullcopy(zeros(1,N));
for i = 1:N
    if mod(i,2) == 0
        X(i) = i;
    else
        X(i) = 0;
    end
end
```

Using `coder.nullcopy` with `zeros` lets you specify the size of vector `X` without initializing each element to zero.

Input Arguments

A — Variable to copy

scalar | vector | matrix | class | multidimensional array

Variable to copy, specified as a scalar, vector, matrix, or multidimensional array.

Example: `coder.nullcopy(A)`;

Data Types: `single` | `double` | `int8` | `int16` | `int32` | `int64` | `uint8` | `uint16` | `uint32` | `uint64` | `logical` | `char` | `string` | `class`

Complex Number Support: Yes

Limitations

- You cannot use `coder.nullcopy` on sparse matrices.
- You cannot use `coder.nullcopy` with classes that support overloaded parentheses or require indexing methods to access their data, such as `table`.

Extended Capabilities

C/C++ Code Generation

Generate C and C++ code using MATLAB® Coder™.

GPU Code Generation

Generate CUDA® code for NVIDIA® GPUs using GPU Coder™.

See Also

Topics

“Eliminate Redundant Copies of Variables in Generated Code”

Introduced in R2011a

coder.opaque

Declare variable in generated code

Syntax

```
y = coder.opaque(type)
y = coder.opaque(type,value)
y = coder.opaque( ____, 'Size',Size)
y = coder.opaque( ____, 'HeaderFile',HeaderFile)
```

Description

`y = coder.opaque(type)` declares a variable `y` with the specified type and no initial value in the generated code.

- `y` can be a variable or a structure field.
- MATLAB code cannot set or access `y`, but external C functions can accept `y` as an argument.
- `y` can be an:
 - Argument to `coder.rref`, `coder.wref`, or `coder.ref`
 - Input or output argument to `coder.ceval`
 - Input or output argument to a user-written MATLAB function
 - Input to a subset of MATLAB toolbox functions supported for code generation
- Assignment from `y` declares another variable with the same type in the generated code. For example:

```
y = coder.opaque('int');
z = y;
```

declares a variable `z` of type `int` in the generated code.

- You can assign `y` from another variable declared using either `coder.opaque` or assignment from a variable declared using `coder.opaque`. The variables must have identical types.
- You can compare `y` to another variable declared using either `coder.opaque` or assignment from a variable declared using `coder.opaque`. The variables must have identical types.

`y = coder.opaque(type,value)` specifies the type and initial value of `y`.

`y = coder.opaque(____, 'Size',Size)` specifies the size, in bytes, of `y`. You can specify the size with any of the previous syntaxes.

`y = coder.opaque(____, 'HeaderFile',HeaderFile)` specifies the header file that contains the type definition. The code generator produces the `#include` statement for the header file where the statement is required in the generated code. You can specify the header file with any of the previous syntaxes.

Examples

Declare Variable Specifying Initial Value

Generate code for a function `valtest` which returns 1 if the call to `myfun` is successful. This function uses `coder.opaque` to declare a variable `x1` with type `int` and initial value 0. The assignment `x2 = x1` declares `x2` to be a variable with the type and initial value of `x1`.

Write a function `valtest`.

```
function y = valtest
codegen
%declare x1 to be an integer with initial value '0'
x1 = coder.opaque('int','0');
%Declare x2 to have same type and initial value as x1
x2 = x1;
x2 = coder.ceval('myfun');
%test the result of call to 'myfun' by comparing to value of x1
if x2 == x1
    y = 0;
else
    y = 1;
end
end
```

Declare Variable Specifying Initial Value and Header File

Generate code for a MATLAB function `filetest` which returns its own source code using `fopen/fread/fclose`. This function uses `coder.opaque` to declare the variable that stores the file pointer used by `fopen/fread/fclose`. The call to `coder.opaque` declares the variable `f` with type `FILE *`, initial value `NULL`, and header file `<stdio.h>`.

Write a MATLAB function `filetest`.

```
function buffer = filetest
%#codegen

% Declare 'f' as an opaque type 'FILE *' with initial value 'NULL'
%Specify the header file that contains the type definition of 'FILE *';

f = coder.opaque('FILE *', 'NULL', 'HeaderFile', '<stdio.h>');
% Open file in binary mode
f = coder.ceval('fopen', cstring('filetest.m'), cstring('rb'));

% Read from file until end of file is reached and put
% contents into buffer
n = int32(1);
i = int32(1);
buffer = char(zeros(1,8192));
while n > 0
    % By default, MATLAB converts constant values
    % to doubles in generated code
    % so explicit type conversion to int32 is inserted.
    n = coder.ceval('fread', coder.ref(buffer(i)), int32(1), ...
        int32(numel(buffer)), f);
    i = i + n;
end
coder.ceval('fclose', f);

buffer = strip_cr(buffer);

% Put a C termination character '\0' at the end of MATLAB character vector
```



```

function y = cstring(x)
    y = [x char(0)];

% Remove all character 13 (CR) but keep character 10 (LF)
function buffer = strip_cr(buffer)
    j = 1;
    for i = 1:numel(buffer)
        if buffer(i) ~= char(13)
            buffer(j) = buffer(i);
            j = j + 1;
        end
    end
    buffer(i) = 0;

```

Compare Variables Declared Using coder.opaque

Compare variables declared using `coder.opaque` to test for successfully opening a file.

Use `coder.opaque` to declare a variable `null` with type `FILE *` and initial value `NULL`.

```
null = coder.opaque('FILE *', 'NULL', 'HeaderFile', '<stdio.h>');
```

Use assignment to declare another variable `ftmp` with the same type and value as `null`.

```
ftmp = null;
ftmp = coder.ceval('fopen', ['testfile.txt', char(0)], ['r', char(0)]);
```

Compare the variables.

```
if ftmp == null
    %error condition
end
```

Cast to and from Types of Variables Declared Using coder.opaque

This example shows how to cast to and from types of variables that are declared using `coder.opaque`. The function `castopaque` calls the C run-time function `strncmp` to compare at most `n` characters of the strings `s1` and `s2`. `n` is the number of characters in the shorter of the strings. To generate the correct C type for the `strncmp` input `nsizet`, the function casts `n` to the C type `size_t` and assigns the result to `nsizet`. The function uses `coder.opaque` to declare `nsizet`. Before using the output `retval` from `strncmp`, the function casts `retval` to the MATLAB type `int32` and stores the results in `y`.

Write this MATLAB function:

```

function y = castopaque(s1,s2)

% <0 - the first character that does not match has a lower value in s1 than in s2
%  0 - the contents of both strings are equal
% >0 - the first character that does not match has a greater value in s1 than in s2
%
%#codegen

coder.cinclude('<string.h>');
n = min(numel(s1), numel(s2));

% Convert the number of characters to compare to a size_t
nsizet = cast(n,'like',coder.opaque('size_t','0'));

```

```
% The return value is an int
retval = coder.opaque('int');
retval = coder.ceval('strcmp', cstr(s1), cstr(s2), nsizet);

% Convert the opaque return value to a MATLAB value
y = cast(retval, 'int32');

%-----
function sc = cstr(s)
% NULL terminate a MATLAB character vector for C
sc = [s, char(0)];
```

Generate the MEX function.

```
codegen castopaque -args {blanks(3), blanks(3)} -report
```

Call the MEX function with inputs 'abc' and 'abc'.

```
castopaque_mex('abc', 'abc')
```

```
ans =
```

```
0
```

The output is 0 because the strings are equal.

Call the MEX function with inputs 'abc' and 'abd'.

```
castopaque_mex('abc', 'abd')
```

```
ans =
```

```
-1
```

The output is -1 because the third character d in the second string is greater than the third character c in the first string.

Call the MEX function with inputs 'abd' and 'abc'.

```
castopaque_mex('abd', 'abc')
```

```
ans =
```

```
1
```

The output is 1 because the third character d in the first string is greater than the third character c in the second string.

In the MATLAB workspace, you can see that the type of y is int32.

Declare Variable Specifying Initial Value and Size

Declare y to be a 4-byte integer with initial value 0.

```
y = coder.opaque('int', '0', 'Size', 4);
```

Input Arguments

type — Type of variable

character vector | string scalar

Type of variable in generated code. `type` must be a compile-time constant. The type must be a:

- Built-in C data type or a type defined in a header file
- C type that supports copy by assignment
- Legal prefix in a C declaration

Example: 'FILE *'

value — Initial value of variable

character vector | string scalar

Initial value of variable in generated code. `value` must be a compile-time constant. Specify a C expression not dependent on MATLAB variables or functions.

If you do not provide the initial value in `value`, initialize the value of the variable before using it. To initialize a variable declared using `coder.opaque`:

- Assign a value from another variable with the same type declared using either `coder.opaque` or assignment from a variable declared using `coder.opaque`.
- Assign a value from an external C function.
- Pass the address of the variable to an external function using `coder.wref`.

Specify a `value` that has the type that `type` specifies. Otherwise, the generated code can produce unexpected results.

Example: 'NULL'

Size — Size of variable

integer

Number of bytes for the variable in the generated code, specified as an integer. If you do not specify the size, the size of the variable is 8 bytes.

Data Types: `single` | `double` | `int8` | `int16` | `int32` | `int64` | `uint8` | `uint16` | `uint32` | `uint64`

HeaderFile — Name of header file

character vector | string scalar

Name of header file that contains the definition of `type`. `HeaderFile` must be a compile-time constant.

For a system header file, use angle brackets.

Example: '<stdio.h>' generates `#include <stdio.h>`

For an application header file, use double quotes.

Example: '"foo.h"' generates `#include "foo.h"`

If you omit the angle brackets or double quotes, the code generator produces double quotes.

Example: 'foo.h' generates #include "foo.h"

Specify the include path in the build configuration parameters.

Example: `cfg.CustomInclude = 'c:\myincludes'`

Tips

- Specify a value that has the type that type specifies. Otherwise, the generated code can produce unexpected results. For example, the following `coder.opaque` declaration can produce unexpected results.

```
y = coder.opaque('int', '0.2')
```

- `coder.opaque` declares the type of a variable. It does not instantiate the variable. You can instantiate a variable by using it later in the MATLAB code. In the following example, assignment of `fp1` from `coder.ceval` instantiates `fp1`.

```
% Declare fp1 of type FILE *
fp1 = coder.opaque('FILE *');
%Create the variable fp1
fp1 = coder.ceval('fopen', ['testfile.txt', char(0)], ['r', char(0)]);
```

- In the MATLAB environment, `coder.opaque` returns the value specified in `value`. If `value` is not provided, it returns an empty character vector.
- You can compare variables declared using either `coder.opaque` or assignment from a variable declared using `coder.opaque`. The variables must have identical types. The following example demonstrates how to compare these variables. “Compare Variables Declared Using `coder.opaque`” on page 2-119
- To avoid multiple inclusions of the same header file in generated code, enclose the header file in the conditional preprocessor statements `#ifndef` and `#endif`. For example:

```
#ifndef MyHeader_h
#define MyHeader_h
<body of header file>
#endif
```

- You can use the MATLAB `cast` function to cast a variable to or from a variable that is declared using `coder.opaque`. Use `cast` with `coder.opaque` only for numeric types.

To cast a variable declared by `coder.opaque` to a MATLAB type, you can use the `B = cast(A, type)` syntax. For example:

```
x = coder.opaque('size_t', '0');
x1 = cast(x, 'int32');
```

You can also use the `B = cast(A, 'like', p)` syntax. For example:

```
x = coder.opaque('size_t', '0');
x1 = cast(x, 'like', int32(0));
```

To cast a MATLAB variable to the type of a variable declared by `coder.opaque`, you must use the `B = cast(A, 'like', p)` syntax. For example:

```
x = int32(12);
x1 = coder.opaque('size_t', '0');
x2 = cast(x, 'like', x1);
```

Use `cast` with `coder.opaque` to generate the correct data types for:

- Inputs to C/C++ functions that you call using `coder.ceval`.
- Variables that you assign to outputs from C/C++ functions that you call using `coder.ceval`.

Without this casting, it is possible to receive compiler warnings during code generation.

Extended Capabilities

C/C++ Code Generation

Generate C and C++ code using MATLAB® Coder™.

GPU Code Generation

Generate CUDA® code for NVIDIA® GPUs using GPU Coder™.

See Also

`coder.ceval` | `coder.ref` | `coder.rref` | `coder.wref`

Topics

“Integrate C Code by Using the MATLAB Function Block”

Introduced in R2011a

coder.ref

Indicate data to pass by reference

Syntax

```
coder.ref(arg)
```

Description

`coder.ref(arg)` indicates that `arg` is an expression or variable to pass by reference to an external C/C++ function. Use `coder.ref` inside a `coder.ceval` call only. The C/C++ function can read from or write to the variable passed by reference. Use a separate `coder.ref` construct for each argument that you pass by reference to the function.

See also `coder.rref` and `coder.wref`.

Examples

Pass Scalar Variable by Reference

Consider the C function `addone` that returns the value of an input plus one:

```
double addone(double* p) {  
    return *p + 1;  
}
```

The C function defines the input variable `p` as a pointer to a double.

Pass the input by reference to `addone`:

```
...  
y = 0;  
u = 42;  
y = coder.ceval('addone', coder.ref(u));  
...
```

Pass Multiple Arguments by Reference

```
...  
u = 1;  
v = 2;  
y = coder.ceval('my_fcn', coder.ref(u), coder.ref(v));  
...
```

Pass Class Property by Reference

```
...  
x = myClass;  
x.prop = 1;  
coder.ceval('foo', coder.ref(x.prop));  
...
```

Pass a Structure by Reference

To indicate that the structure type is defined in a C header file, use `coder.cstructname`.

Suppose that you have the C function `incr_struct`. This function reads from and writes to the input argument.

```
#include "MyStruct.h"

void incr_struct(struct MyStruct *my_struct)
{
    my_struct->f1 = my_struct->f1 + 1;
    my_struct->f2 = my_struct->f2 + 1;
}
```

The C header file, `MyStruct.h`, defines a structure type named `MyStruct`:

```
#ifndef MYSTRUCT
#define MYSTRUCT

typedef struct MyStruct
{
    double f1;
    double f2;
} MyStruct;

void incr_struct(struct MyStruct *my_struct);

#endif
```

In your MATLAB function, pass a structure by reference to `incr_struct`. To indicate that the structure type for `s` has the name `MyStruct` that is defined in the C header file `MyStruct.h`, use `coder.cstructname`.

```
function y = foo
%#codegen
y = 0;
coder.updateBuildInfo('addSourceFiles','incr_struct.c');

s = struct('f1',1,'f2',2);
coder.cstructname(s,'MyStruct','extern','HeaderFile','MyStruct.h');
coder.ceval('incr_struct', coder.ref(s));
```

To generate standalone library code, enter:

```
codegen -config:lib foo -report
```

Pass Structure Field by Reference

```
...
s = struct('s1', struct('a', [0 1]));
coder.ceval('foo', coder.ref(s.s1.a));
...
```

You can also pass an element of an array of structures:

```
...
c = repmat(struct('u',magic(2)),1,10);
```

```
b = repmat(struct('c',c),3,6);
a = struct('b',b);
coder.ceval('foo', coder.ref(a.b(3,4).c(2).u));
...
```

Input Arguments

arg — Argument to pass by reference

scalar variable | array | element of an array | structure | structure field | object property

Argument to pass by reference to an external C/C++ function. The argument cannot be a class, a System object, a cell array, or an index into a cell array.

Data Types: `single` | `double` | `int8` | `int16` | `int32` | `int64` | `uint8` | `uint16` | `uint32` | `uint64` | `logical` | `char` | `struct`
Complex Number Support: Yes

Limitations

- You cannot pass these data types by reference:
 - Class or System object
 - Cell array or index into a cell array
- If a property has a get method, a set method, or validators, or is a System object property with certain attributes, then you cannot pass the property by reference to an external function. See “Passing By Reference Not Supported for Some Properties”.

Tips

- If `arg` is an array, then `coder.ref(arg)` provides the address of the first element of the array. The `coder.ref(arg)` function does not contain information about the size of the array. If the C function must know the number of elements of your data, pass that information as a separate argument. For example:

```
coder.ceval('myFun',coder.ref(arg),int32(numel(arg)));
```
- When you pass a structure by reference to an external C/C++ function, use `coder.cstructname` to provide the name of a C structure type that is defined in a C header file.
- In MATLAB, `coder.ref` results in an error. To parameterize your MATLAB code so that it can run in MATLAB and in generated code, use `coder.target`.
- You can use `coder.opaque` to declare variables that you pass to and from an external C/C++ function.

Extended Capabilities

C/C++ Code Generation

Generate C and C++ code using MATLAB® Coder™.

GPU Code Generation

Generate CUDA® code for NVIDIA® GPUs using GPU Coder™.

See Also

`coder.rref` | `coder.wref` | `coder.ceval` | `coder.opaque` | `coder.cstructname` | `numel`

Topics

“Integrate C Code by Using the MATLAB Function Block”

Introduced in R2011a

coder.rowMajor

Specify row-major array layout for a function or class

Syntax

```
coder.rowMajor
```

Description

`coder.rowMajor` specifies row-major array layout for the data used by the current function in generated code. When placed in a class constructor, `coder.rowMajor` specifies row-major layout for data used by the class.

Note By default, code generation uses column-major array layout.

Examples

Specify Row-Major Array Layout for a Function

Specify row-major array layout for a function by inserting `coder.rowMajor` into the function body.

Suppose that `myFunction` is the top-level function of your code. Your application requires you to perform matrix addition with row-major array layout and matrix multiplication with column-major layout.

```
function S = myFunction(A,B)
%#codegen
% check to make sure inputs are valid
if size(A,1) ~= size(B,1) || size(A,2) ~= size(B,2)
    disp('Matrices must be same size.');
```

return;

```
end
% make both matrices symmetric
B = B*B';
A = A*A';
% add matrices
S = addMatrix(A,B);
end
```

Write a function for matrix addition called `addMatrix`. Specify row-major layout for `addMatrix` by using `coder.rowMajor`.

```
function S = addMatrix(A,B)
%#codegen
S = zeros(size(A));
coder.rowMajor; % specify row-major array layout
S = A + B;
end
```

Generate code for `myFunction`. Use the `codegen` command.

```
codegen myFunction -args {ones(10,20),ones(10,20)} -config:lib -launchreport
```

The code generator produces code for `addMatrix` that uses row-major array layout. However, the matrix multiplication from the top-level function uses the default layout, column-major.

Tips

- To specify row-major array layout for all the functions in your generated code, use the `codegen -rowmajor` option.
- Other functions called from within a row-major function inherit the row-major specification. However, if one of the called functions has its own distinct `coder.columnMajor` call, the code generator changes the array layout accordingly. If a row-major function and a column-major function call the same function, which does not have its own array layout specification, the code generator produces a row-major version and column-major version of the function.
- `coder.rowMajor` is ignored outside of code generation and simulation.

Extended Capabilities

C/C++ Code Generation

Generate C and C++ code using MATLAB® Coder™.

GPU Code Generation

Generate CUDA® code for NVIDIA® GPUs using GPU Coder™.

See Also

`coder.ceval` | `coder.columnMajor` | `coder.isColumnMajor` | `coder.isRowMajor`

Topics

“Interface with Row-Major Data in MATLAB Function Block”

“Specify Array Layout in Functions and Classes”

“Code Generation of Matrices and Arrays” (Simulink Coder)

Introduced in R2018a

coder.rref

Indicate read-only data to pass by reference

Syntax

```
coder.rref(arg)
```

Description

`coder.rref(arg)` indicates that `arg` is a read-only expression or variable to pass by reference to an external C/C++ function. Use `coder.rref` only inside a `coder.ceval` call.

The `coder.rref` function can enable the code generator to optimize the generated code. Because the external function is assumed to not write to `coder.rref(arg)`, the code generator can perform optimizations such as expression folding on assignments to `arg` that occur before and after the `coder.ceval` call. Expression folding is the combining of multiple operations into one statement to avoid the use of temporary variables and improve code performance.

Note The code generator assumes that the memory that you pass with `coder.rref(arg)` is read-only. To avoid unpredictable results, the C/C++ function must not write to this variable.

See also `coder.ref` and `coder.wref`.

Examples

Pass Scalar Variable as a Read-Only Reference

Consider the C function `addone` that returns the value of a constant input plus one:

```
double addone(const double* p) {  
    return *p + 1;  
}
```

The C function defines the input variable `p` as a pointer to a constant double.

Pass the input by reference to `addone`:

```
...  
y = 0;  
u = 42;  
y = coder.ceval('addone', coder.rref(u));  
...
```

Pass Multiple Arguments as a Read-Only Reference

```
...  
u = 1;  
v = 2;  
y = coder.ceval('my_fcn', coder.rref(u), coder.rref(v));  
...
```

Pass Class Property as a Read-Only Reference

```
...
x = myClass;
x.prop = 1;
y = coder.ceval('foo', coder.rref(x.prop));
...
```

Pass Structure as a Read-Only Reference

To indicate that the structure type is defined in a C header file, use `coder.cstructname`.

Suppose that you have the C function `use_struct`. This function reads from the input argument but does not write to it.

```
#include "MyStruct.h"

double use_struct(const struct MyStruct *my_struct)
{
    return my_struct->f1 + my_struct->f2;
}
```

The C header file, `MyStruct.h`, defines a structure type named `MyStruct`:

```
#ifndef MYSTRUCT
#define MYSTRUCT

typedef struct MyStruct
{
    double f1;
    double f2;
} MyStruct;

double use_struct(const struct MyStruct *my_struct);

#endif
```

In your MATLAB function, pass a structure as a read-only reference to `use_struct`. To indicate that the structure type for `s` has the name `MyStruct` that is defined in the C header file `MyStruct.h`, use `coder.cstructname`.

```
function y = foo
%#codegen
y = 0;
coder.updateBuildInfo('addSourceFiles','use_struct.c');

s = struct('f1',1,'f2',2);
coder.cstructname(s,'MyStruct','extern','HeaderFile','MyStruct.h');
y = coder.ceval('use_struct', coder.rref(s));
```

To generate standalone library code, enter:

```
codegen -config:lib foo -report
```

Pass Structure Field as a Read-Only Reference

```
...
s = struct('s1', struct('a', [0 1]));
```

```
y = coder.ceval('foo', coder.rref(s.s1.a));
...
```

You can also pass an element of an array of structures:

```
...
c = repmat(struct('u',magic(2)),1,10);
b = repmat(struct('c',c),3,6);
a = struct('b',b);
coder.ceval('foo', coder.rref(a.b(3,4).c(2).u));
...
```

Input Arguments

arg — Argument to pass by reference

scalar variable | array | element of an array | structure | structure field | object property

Argument to pass by reference to an external C/C++ function. The argument cannot be a class, a System object, a cell array, or an index into a cell array.

Data Types: single | double | int8 | int16 | int32 | int64 | uint8 | uint16 | uint32 | uint64 | logical | char | struct

Complex Number Support: Yes

Limitations

- You cannot pass these data types by reference:
 - Class or System object
 - Cell array or index into a cell array
- If a property has a get method, a set method, or validators, or is a System object property with certain attributes, then you cannot pass the property by reference to an external function. See “Passing By Reference Not Supported for Some Properties”.

Tips

- If `arg` is an array, then `coder.rref(arg)` provides the address of the first element of the array. The `coder.rref(arg)` function does not contain information about the size of the array. If the C function must know the number of elements of your data, pass that information as a separate argument. For example:

```
coder.ceval('myFun', coder.rref(arg), int32(numel(arg)));
```

- When you pass a structure by reference to an external C/C++ function, use `coder.cstructname` to provide the name of a C structure type that is defined in a C header file.
- In MATLAB, `coder.rref` results in an error. To parametrize your MATLAB code so that it can run in MATLAB and in generated code, use `coder.target`.
- You can use `coder.opaque` to declare variables that you pass to and from an external C/C++ function.

Extended Capabilities

C/C++ Code Generation

Generate C and C++ code using MATLAB® Coder™.

GPU Code Generation

Generate CUDA® code for NVIDIA® GPUs using GPU Coder™.

See Also

[coder.ref](#) | [coder.wref](#) | [coder.ceval](#) | [coder.opaque](#) | [coder.cstructname](#)

Topics

“Integrate C Code by Using the MATLAB Function Block”

Introduced in R2011a

coder.screener

Package: coder

Determine if function is suitable for code generation

Syntax

```
coder.screener(fcn)
coder.screener(fcn, '-gpu')
coder.screener(fcn_1, ..., fcn_n)
```

Description

`coder.screener(fcn)` analyzes the entry-point MATLAB function `fcn` to identify unsupported functions and language features as code generation compliance issues. The code generation compliance issues are displayed in the readiness report.

If `fcn` calls other functions directly or indirectly that are not MathWorks functions (MATLAB built-in functions and toolbox functions), `coder.screener` analyzes these functions. It does not analyze the MathWorks functions.

It is possible that `coder.screener` does not detect all code generation issues. Under certain circumstances, it is possible that `coder.screener` reports false errors.

To avoid undetected code generation issues and false errors, before generating code, verify that your MATLAB code is suitable for code generation by performing these additional checks:

- Before using `coder.screener`, fix issues that the Code Analyzer identifies.
- After using `coder.screener`, and before generating C/C++ code, verify that your MATLAB code is suitable for code generation by generating and verifying a MEX function.

The `coder.screener` function does not report functions that the code generator treats as extrinsic. Examples of such functions are `plot`, `disp`, and `figure`. See “Use MATLAB Engine to Execute a Function Call in Generated Code”.

`coder.screener(fcn, '-gpu')` analyzes the entry-point MATLAB function `fcn` to identify unsupported functions and language features for GPU code generation. This option requires a GPU Coder license.

`coder.screener(fcn_1, ..., fcn_n)` analyzes multiple entry-point MATLAB functions.

Examples

Identify Unsupported Functions

The `coder.screener` function identifies calls to functions that are not supported for code generation. It checks the entry-point function, `foo1`, and the function, `foo2`, that `foo1` calls.

Write the function `foo2` and save it in the file `foo2.m`.

```
function [tf1,tf2] = foo2(source,target)
G = digraph(source,target);
tf1 = hascycles(G);
tf2 = isdag(G);
end
```

Write the function `foo1` that calls `foo2`. Save `foo1` in the file `foo1.m`.

```
function [tf1,tf2] = foo1(source,target)
assert(numel(source)==numel(target))
[tf1,tf2] = foo2(source,target);
end
```

Analyze `foo1`.

```
coder.screener('foo1')
```

The Code Generation Readiness report displays a summary of the unsupported MATLAB function calls. The report **Summary** tab indicates that `foo2.m` contains one call to the `isdag` function and one call to the `hascycles`, which are not supported for code generation.

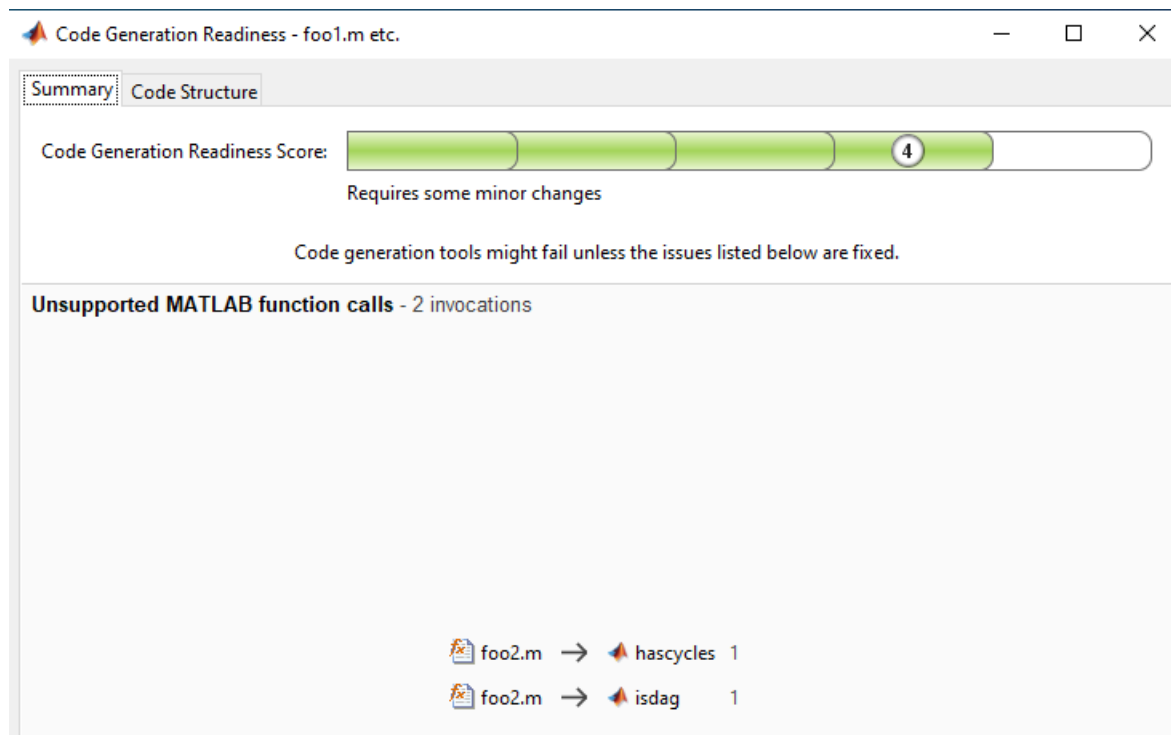

In the report, click the **Code Structure** tab and select the **Show MATLAB functions** check box.

This tab displays a pie chart showing the relative size of each file and how suitable each file is for code generation. The report displays:

- Green: Function (`foo1.m`) suitable for code generation.
- Yellow: Function (`foo2.m`) requires significant changes.

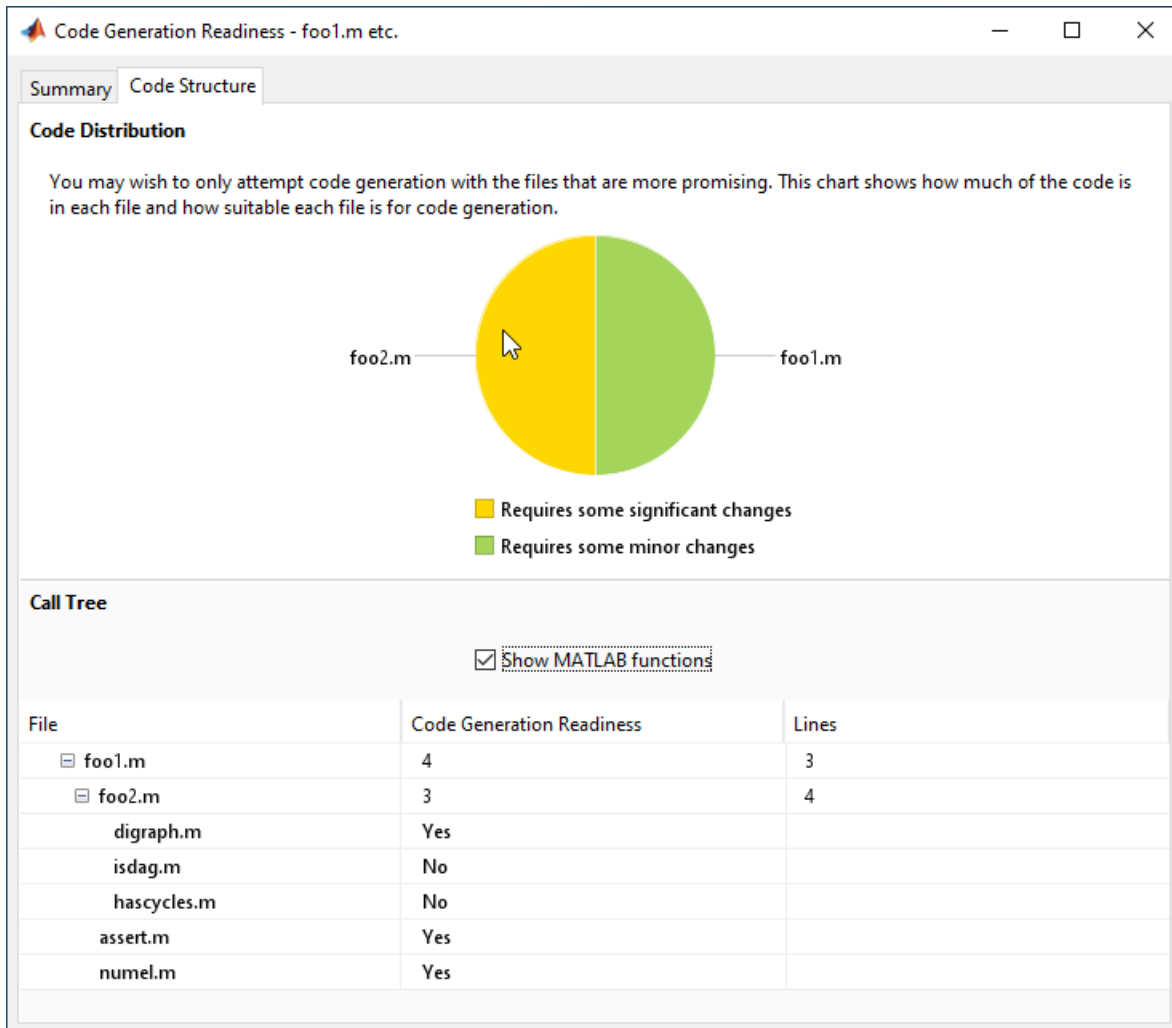

The report also displays a **Call Tree** with **Code Generation Readiness Score**. The score is based on a scale of 1–5. 1 indicates that significant changes are required. 5 indicates that the code generation readiness tool does not detect issues. In this example, the report assigns `foo1.m` a code generation readiness score of 4 and `foo2.m` a score of 3.

The function `foo2` calls two unsupported MATLAB functions. To generate a MEX function, modify the code to make the calls to `hascycles` and `isdag` extrinsic by using the `coder.extrinsic` directive, and then rerun the code generation readiness tool.

```
function [tf1,tf2] = foo2(source,target)
coder.extrinsic('hascycles','isdag');
G = digraph(source,target);
tf1 = hascycles(G);
tf2 = isdag(G);
end
```

Rerun `coder.screener` on the entry-point function `foo1`.

```
coder.screener('foo1')
```

The report no longer flags that code generation does not support the `hascycles` and `isdag` functions. When you generate a MEX function for `foo1`, the code generator dispatches these two functions to MATLAB for execution.

Identify Unsupported Data Types

The `coder.screener` function identifies MATLAB data types that code generation does not support.

Write the function `myfun1` that contains a MATLAB calendar duration array data type.

```
function out = myfun1(A)
out = calyears(A);
end
```

Analyze `myfun1`.

```
coder.screener('myfun1');
```

The code generation readiness report indicates that the `calyears` data type is not supported for code generation.

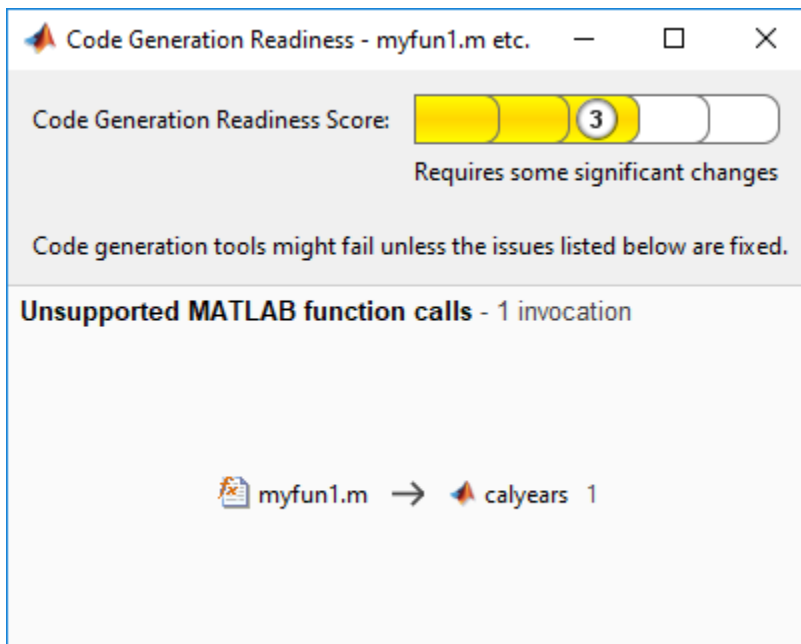

The report assigns `myfun1` a code generation readiness score of 3. Before generating code, fix the reported issues.

Input Arguments

fcn — Name of entry-point function

character vector | string scalar

Name of entry-point MATLAB function for analysis. Specify as a character vector or a string scalar.

Example: `coder.screener('myfun');`

Data Types: char | string

fcn_1, ..., fcn_n — List of entry-point function names

character vector | string scalar

Comma-separated list of entry-point MATLAB function names for analysis. Specify as character vectors or string scalars.

Example: `coder.screener('myfun1','myfun2');`

Data Types: char | string

Alternatives

- “Run the Code Generation Readiness Tool From the Current Folder Browser”

See Also

`coder.extrinsic`

Topics

“Functions and Objects Supported for C/C++ Code Generation”

“Code Generation Readiness Tool”

Introduced in R2012b

coder.target

Determine if code generation target is specified target

Syntax

```
tf = coder.target(target)
```

Description

`tf = coder.target(target)` returns true (1) if the code generation target is `target`. Otherwise, it returns false (0).

If you generate code for MATLAB classes, MATLAB computes class initial values at class loading time before code generation. If you use `coder.target` in MATLAB class property initialization, `coder.target('MATLAB')` returns true.

Examples

Use coder.target to Parametrize a MATLAB Function

Parametrize a MATLAB function so that it works in MATLAB or in generated code. When the function runs in MATLAB, it calls the MATLAB function `myabsval`. The generated code, however, calls a C library function `myabsval`.

Write a MATLAB function `myabsval`.

```
function y = myabsval(u)
%#codegen
y = abs(u);
```

Generate a C static library for `myabsval`, using the `-args` option to specify the size, type, and complexity of the input parameter.

```
codegen -config:lib myabsval -args {0.0}
```

The `codegen` function creates the library file `myabsval.lib` and header file `myabsval.h` in the folder `\codegen\lib\myabsval`. (The library file extension can change depending on your platform.) It generates the functions `myabsval_initialize` and `myabsval_terminate` in the same folder.

Write a MATLAB function to call the generated C library function using `coder.ceval`.

```
function y = callmyabsval(y)
%#codegen
% Check the target. Do not use coder.ceval if callmyabsval is
% executing in MATLAB
if coder.target('MATLAB')
    % Executing in MATLAB, call function myabsval
    y = myabsval(y);
else
```

```

% add the required include statements to generated function code
coder.updateBuildInfo('addIncludePaths', '$(START_DIR)\codegen\lib\myabsval');
coder.cinclude('myabsval_initialize.h');
coder.cinclude('myabsval.h');
coder.cinclude('myabsval_terminate.h');

% Executing in the generated code.
% Call the initialize function before calling the
% C function for the first time
coder.ceval('myabsval_initialize');

% Call the generated C library function myabsval
y = coder.ceval('myabsval',y);

% Call the terminate function after
% calling the C function for the last time
coder.ceval('myabsval_terminate');
end

```

Generate the MEX function `callmyabsval_mex`. Provide the generated library file at the command line.

```
codegen -config:mex callmyabsval codegen\lib\myabsval\myabsval.lib -args {-2.75}
```

Rather than providing the library at the command line, you can use `coder.updateBuildInfo` to specify the library within the function. Use this option to preconfigure the build. Add this line to the `else` block:

```
coder.updateBuildInfo('addLinkObjects', 'myabsval.lib', '$(START_DIR)\codegen\lib\myabsval', 100, true);
```

Run the MEX function `callmyabsval_mex` which calls the library function `myabsval`.

```
callmyabsval_mex(-2.75)
```

```
ans =
```

```
2.7500
```

Call the MATLAB function `callmyabsval`.

```
callmyabsval(-2.75)
```

```
ans =
```

```
2.7500
```

The `callmyabsval` function exhibits the desired behavior for execution in MATLAB and in code generation.

Input Arguments

target — code generation target

```
'MATLAB' | 'MEX' | 'Sfun' | 'Rtw' | 'HDL' | 'Custom'
```

Code generation target, specified as a character vector or a string scalar. Specify one of these targets.

| | |
|----------|---|
| 'MATLAB' | Running in MATLAB (not generating code) |
| 'MEX' | Generating a MEX function |
| 'Sfun' | Simulating a Simulink model. Also used for running in Accelerator mode. |
| 'Rtw' | Generating a LIB, DLL, or EXE target. Also used for running in Simulink Coder and Rapid Accelerator mode. |
| 'HDL' | Generating an HDL target |
| 'Custom' | Generating a custom target |

Example: `tf = coder.target('MATLAB')`

Example: `tf = coder.target("MATLAB")`

Extended Capabilities

C/C++ Code Generation

Generate C and C++ code using MATLAB® Coder™.

GPU Code Generation

Generate CUDA® code for NVIDIA® GPUs using GPU Coder™.

See Also

`coder.ceval` | `coder.cinclude` | `coder.updateBuildInfo` | `coder.BuildConfig` | `coder.ExternalDependency`

Topics

“Integrate C Code by Using the MATLAB Function Block”

Introduced in R2011a

coder.unroll

Unroll for-loop by making a copy of the loop body for each loop iteration

Syntax

```
coder.unroll()  
coder.unroll(flag)
```

Description

`coder.unroll()` unrolls a for-loop. The `coder.unroll` call must be on a line by itself immediately preceding the for-loop that it unrolls.

Instead of producing a for-loop in the generated code, loop unrolling produces a copy of the for-loop body for each loop iteration. In each iteration, the loop index becomes constant. To unroll a loop, the code generator must be able to determine the bounds of the for-loop.

For small, tight loops, unrolling can improve performance. However, for large loops, unrolling can increase code generation time significantly and generate inefficient code.

`coder.unroll` is ignored outside of code generation.

`coder.unroll(flag)` unrolls a for-loop if `flag` is `true`. `flag` is evaluated at code generation time. The `coder.unroll` call must be on a line by itself immediately preceding the for-loop that it unrolls.

Examples

Unroll a for-loop

To produce copies of a for-loop body in the generated code, use `coder.unroll`.

In one file, write the entry-point function `call_getrand` and a local function `getrand`. `getrand` unrolls a for-loop that assigns random numbers to an n-by-1 array. `call_getrand` calls `getrand` with the value 3.

```
function z = call_getrand  
%#codegen  
z = getrand(3);  
end  
  
function y = getrand(n)  
coder.inline('never');  
y = zeros(n, 1);  
coder.unroll();  
for i = 1:n  
    y(i) = rand();  
end  
end
```

Generate a static library.

```
codegen -config:lib call_getrand -report
```

In the generated code, the code generator produces a copy of the for-loop body for each of the three loop iterations.

```
static void getrand(double y[3])
{
    y[0] = b_rand();
    y[1] = b_rand();
    y[2] = b_rand();
}
```

Control for-loop Unrolling with Flag

Control loop unrolling by using `coder.unroll` with the `flag` argument.

In one file, write the entry-point function `call_getrand_unrollflag` and a local function `getrand_unrollflag`. When the number of loop iterations is less than 10, `getrand_unrollflag` unrolls the for-loop. `call_getrand` calls `getrand` with the value 50.

```
function z = call_getrand_unrollflag
    %#codegen
    z = getrand_unrollflag(50);
end

function y = getrand_unrollflag(n)
    coder.inline('never');
    unrollflag = n < 10;
    y = zeros(n, 1);
    coder.unroll(unrollflag)
    for i = 1:n
        y(i) = rand();
    end
end
```

Generate a static library.

```
codegen -config:lib call_getrand_unrollflag -report
```

```
static void getrand_unrollflag(double y[50])
{
    int i;
    for (i = 0; i < 50; i++) {
        y[i] = b_rand();
    }
}
```

The number of iterations is not less than 10. Therefore, the code generator does not unroll the for-loop. It produces a for-loop in the generated code.

Use Legacy Syntax to Unroll for-Loop

- ```
function z = call_getrand
 %#codegen
 z = getrand(3);
end

function y = getrand(n)
 coder.inline('never');
 y = zeros(n, 1);
 for i = coder.unroll(1:n)
 y(i) = rand();
 end
end
```

### Use Legacy Syntax to Control for-Loop Unrolling

- ```
function z = call_getrand_unrollflag
    %#codegen
    z = getrand_unrollflag(50);
end

function y = getrand_unrollflag(n)
    coder.inline('never');
    unrollflag = n < 10;
    y = zeros(n, 1);
    for i = coder.unroll(1:n, unrollflag)
        y(i) = rand();
    end
end
```

Input Arguments

flag — Indicates whether to unroll the for-loop

true (default) | false

When `flag` is `true`, the code generator unrolls the `for`-loop. When `flag` is `false`, the code generator produces a `for`-loop in the generated code. `flag` is evaluated at code generation time.

Tips

- Sometimes, the code generator unrolls a `for`-loop even though you do not use `coder.unroll`. For example, if a `for`-loop indexes into a heterogeneous cell array or into `varargin` or `varargout`, the code generator unrolls the loop. By unrolling the loop, the code generator can determine the value of the index for each loop iteration. The code generator uses heuristics to determine when to unroll a `for`-loop. If the heuristics fail to identify that unrolling is warranted, or if the number of loop iterations exceeds a limit, code generation fails. In these cases, you can force loop unrolling by using `coder.unroll`. See “Nonconstant Index into `varargin` or `varargout` in a `for`-Loop”.

Extended Capabilities

C/C++ Code Generation

Generate C and C++ code using MATLAB® Coder™.

GPU Code Generation

Generate CUDA® code for NVIDIA® GPUs using GPU Coder™.

See Also

`coder.inline`

Topics

“Unroll for-Loops and parfor-Loops”

“Nonconstant Index into varargin or varargout in a for-Loop”

Introduced in R2011a

coder.updateBuildInfo

Update build information object RTW.BuildInfo

Syntax

```
coder.updateBuildInfo('addCompileFlags',options)
coder.updateBuildInfo('addLinkFlags',options)
coder.updateBuildInfo('addDefines',options)
coder.updateBuildInfo( __ ,group)
```

```
coder.updateBuildInfo('addLinkObjects',filename,path)
coder.updateBuildInfo('addLinkObjects',filename,path,priority,precompiled)
coder.updateBuildInfo('addLinkObjects',filename,path,priority,precompiled,
linkonly)
coder.updateBuildInfo( __ ,group)
```

```
coder.updateBuildInfo('addNonBuildFiles',filename)
coder.updateBuildInfo('addSourceFiles',filename)
coder.updateBuildInfo('addIncludeFiles',filename)
coder.updateBuildInfo( __ ,path)
coder.updateBuildInfo( __ ,path,group)
```

```
coder.updateBuildInfo('addSourcePaths',path)
coder.updateBuildInfo('addIncludePaths',path)
coder.updateBuildInfo( __ ,group)
```

Description

`coder.updateBuildInfo('addCompileFlags',options)` adds compiler options to the build information object.

`coder.updateBuildInfo('addLinkFlags',options)` adds link options to the build information object.

`coder.updateBuildInfo('addDefines',options)` adds preprocessor macro definitions to the build information object.

`coder.updateBuildInfo(__ ,group)` assigns a group name to options for later reference.

`coder.updateBuildInfo('addLinkObjects',filename,path)` adds a link object from a file to the build information object.

`coder.updateBuildInfo('addLinkObjects',filename,path,priority,precompiled)` specifies if the link object is precompiled.

`coder.updateBuildInfo('addLinkObjects',filename,path,priority,precompiled,linkonly)` specifies if the object is to be built before being linked or used for linking alone. If the object is to be built, it specifies if the object is precompiled.

`coder.updateBuildInfo(__ ,group)` assigns a group name to the link object for later reference.

`coder.updateBuildInfo('addNonBuildFiles', filename)` adds a nonbuild-related file to the build information object.

`coder.updateBuildInfo('addSourceFiles', filename)` adds a source file to the build information object.

`coder.updateBuildInfo('addIncludeFiles', filename)` adds an include file to the build information object.

`coder.updateBuildInfo(____, path)` adds the file from specified path.

`coder.updateBuildInfo(____, path, group)` assigns a group name to the file for later reference.

`coder.updateBuildInfo('addSourcePaths', path)` adds a source file path to the build information object.

`coder.updateBuildInfo('addIncludePaths', path)` adds an include file path to the build information object.

`coder.updateBuildInfo(____, group)` assigns a group name to the path for later reference.

Examples

Add Multiple Compiler Options

Add the compiler options `-Zi` and `-Wall` during code generation for function, `func`.

Anywhere in the MATLAB code for `func`, add the following line:

```
coder.updateBuildInfo('addCompileFlags', '-Zi -Wall');
```

Generate code for `func` using the `codegen` command. Open the Code Generation Report.

```
codegen -config:lib -launchreport func
```

Add Source File Name

Add a source file to the project build information while generating code for a function, `calc_factorial`.

- 1 Write a header file `fact.h` that declares a C function `factorial`.

```
double factorial(double x);
```

`fact.h` will be included as a header file in generated code. This inclusion ensures that the function is declared before it is called.

Save the file in the current folder.

- 2 Write a C file `fact.c` that contains the definition of `factorial`. `factorial` calculates the factorial of its input.

```
#include "fact.h"
```

```

double factorial(double x)
{
    int i;
    double fact = 1.0;
    if (x == 0 || x == 1) {
        return 1.0;
    } else {
        for (i = 1; i <= x; i++) {
            fact *= (double)i;
        }
        return fact;
    }
}

```

`fact.c` is used as a source file during code generation.

Save the file in the current folder.

- 3 Write a MATLAB function `calc_factorial` that uses `coder.ceval` to call the external C function `factorial`.

Use `coder.updateBuildInfo` with option `'addSourceFiles'` to add the source file `fact.c` to the build information. Use `coder.cinclude` to include the header file `fact.h` in the generated code.

```

function y = calc_factorial(x) %#codegen

    coder.cinclude('fact.h');
    coder.updateBuildInfo('addSourceFiles', 'fact.c');

    y = 0;
    y = coder.ceval('factorial', x);

```

- 4 Generate code for `calc_factorial` using the `codegen` command.

```

codegen -config:dll -launchreport calc_factorial -args 0

```

Add Link Object

Add a link object `LinkObj.lib` to the build information while generating code for a function `func`. For this example, you must have a link object `LinkObj.lib` saved in a local folder, for example, `c:\Link_Objects`.

Anywhere in the MATLAB code for `func`, add the following lines:

```

libPriority = '';
libPreCompiled = true;
libLinkOnly = true;
libName = 'LinkObj.lib';
libPath = 'c:\Link_Objects';
coder.updateBuildInfo('addLinkObjects', libName, libPath, ...
    libPriority, libPreCompiled, libLinkOnly);

```

Generate a MEX function for `func` using the `codegen` command. Open the Code Generation Report.

```
codegen -launchreport func
```

Add Include Paths

Add an include path to the build information while generating code for a function, `adder`. Include a header file, `adder.h`, existing on the path.

When header files do not reside in the current folder, to include them, use this method:

- 1 Write a header file `mysum.h` that contains the declaration for a C function `mysum`.

```
double mysum(double, double);
```

Save it in a local folder, for example `c:\coder\myheaders`.

- 2 Write a C file `mysum.c` that contains the definition of the function `mysum`.

```
#include "mysum.h"

double mysum(double x, double y)
{
    return(x+y);
}
```

Save it in the current folder.

- 3 Write a MATLAB function `adder` that adds the path `c:\coder\myheaders` to the build information.

Use `coder.cinclude` to include the header file `mysum.h` in the generated code.

```
function y = adder(x1, x2) %#codegen
    coder.updateBuildInfo('addIncludePaths','c:\coder\myheaders');
    coder.updateBuildInfo('addSourceFiles','mysum.c');
    %Include the source file containing C function definition
    coder.cinclude('mysum.h');
    y = 0;
    if coder.target('MATLAB')
        % This line ensures that the function works in MATLAB
        y = x1 + x2;
    else
        y = coder.ceval('mysum', x1, x2);
    end
end
```

- 4 Generate code for `adder` using the `codegen` command.

```
codegen -config:lib -launchreport adder -args {0,0}
```

Input Arguments

options — Build options

character vector | string scalar

Build options, specified as a character vector or string scalar. The value must be a compile-time constant.

Depending on the leading argument, `options` specifies the relevant build options to be added to the project's build information.

| Leading Argument | Values in options |
|-------------------|--------------------------------|
| 'addCompileFlags' | Compiler options |
| 'addLinkFlags' | Link options |
| 'addDefines' | Preprocessor macro definitions |

The function adds the options to the end of an option vector.

Example: `coder.updateBuildInfo('addCompileFlags', '-Zi -Wall')`

group – Group name

character vector | string scalar

Name of user-defined group, specified as a character vector or string scalar. The value must be a compile-time constant.

The group option assigns a group name to the parameters in the second argument.

| Leading Argument | Second Argument | Parameters Named by group |
|--------------------|-----------------|--|
| 'addCompileFlags' | options | Compiler options |
| 'addLinkFlags' | options | Link options |
| 'addLinkObjects' | filename | Name of file containing linkable objects |
| 'addNonBuildFiles' | filename | Name of nonbuild-related file |
| 'addSourceFiles' | filename | Name of source file |
| 'addSourcePaths' | path | Name of source file path |

You can use `group` to:

- Document the use of specific parameters.
- Retrieve or apply multiple parameters together as one group.

filename – File name

character vector | string scalar

File name, specified as a character vector or string scalar. The value must be a compile-time constant.

Depending on the leading argument, `filename` specifies the relevant file to be added to the project's build information.

| Leading Argument | File Specified by filename |
|--------------------|----------------------------------|
| 'addLinkObjects' | File containing linkable objects |
| 'addNonBuildFiles' | Nonbuild-related file |
| 'addSourceFiles' | Source file |

The function adds the file name to the end of a file name vector.

Example: `coder.updateBuildInfo('addSourceFiles', 'fact.c')`

path — Path name

character vector | string scalar

Relative path name, specified as a character vector or string scalar. The value must be a compile-time constant.

Depending on the leading argument, `path` specifies the relevant path name to be added to the project's build information. The function adds the path to the end of a path name vector.

| Leading Argument | Path Specified by path |
|------------------------------------|--------------------------------|
| 'addLinkObjects' | Path to linkable objects |
| 'addNonBuildFiles' | Path to nonbuild-related files |
| 'addSourceFiles', 'addSourcePaths' | Path to source files |

The relative path starts from the *current working folder* in which you generate code. In the relative path name, reference the current working folder by using the `START_DIR` macro. For example, suppose that your source file `fact.c` is contained in `C:\myCode\mySrcDir`, and you generate code from `C:\myCode`. Write the path as in this example:

```
Example: coder.updateBuildInfo('addSourceFiles','fact.c','$(START_DIR)\mySrcDir')
```

priority — Relative priority of link object

Priority of link objects.

This feature applies only when several link objects are added. Currently, only a single link object file can be added for every `coder.updateBuildInfo` statement. Therefore, this feature is not available for use.

To use the succeeding arguments, include `' '` as a placeholder argument.

precompiled — Variable indicating if link objects are precompiled

logical value

Variable indicating if the link objects are precompiled, specified as a logical value. The value must be a compile-time constant.

If the link object has been prebuilt for faster compiling and linking and exists in a specified location, specify `true`. Otherwise, the MATLAB Coder build process creates the link object in the build folder.

If `linkonly` is set to `true`, this argument is ignored.

Data Types: `logical`

linkonly — Variable indicating if objects must be used for linking only

logical value

Variable indicating if objects must be used for linking only, specified as a logical value. The value must be a compile-time constant.

If you want that the MATLAB Coder build process must not build or generate rules in the makefile for building the specified link object, specify `true`. Instead, when linking the final executable, the

process should just include the object. Otherwise, rules for building the link object are added to the makefile.

You can use this argument to incorporate link objects for which source files are not available.

If `linkonly` is set to `true`, the value of `precompiled` is ignored.

Data Types: `logical`

Extended Capabilities

C/C++ Code Generation

Generate C and C++ code using MATLAB® Coder™.

GPU Code Generation

Generate CUDA® code for NVIDIA® GPUs using GPU Coder™.

See Also

`coder.ref` | `coder.rref` | `coder.wref` | `coder.target` | `coder.ceval` | `coder.cinclude` | `coder.ExternalDependency`

Topics

“Build Process Customization” (MATLAB Coder)

“Integrate C Code by Using the MATLAB Function Block”

Introduced in R2013b

coder.varsize

Package: coder

Declare variable-size data

Syntax

```
coder.varsize(varName1,...,varNameN)
coder.varsize(varName1,...,varNameN,ubounds)
coder.varsize(varName1,...,varNameN,ubounds,dims)
```

Description

`coder.varsize(varName1,...,varNameN)` declares that the variables named `varName1,...,varNameN` have a variable size. The declaration instructs the code generator to allow the variables to change size during execution of the generated code. With this syntax, you do not specify the upper bounds of the dimensions of the variables or which dimensions can change size. The code generator computes the upper bounds. All dimensions, except singleton dimensions on page 2-158, are allowed to change size.

Use `coder.varsize` according to these restrictions and guidelines:

- Use `coder.varsize` inside a MATLAB function intended for code generation.
- The `coder.varsize` declaration must precede the first use of a variable. For example:

```
...
x = 1;
coder.varsize('x');
disp(size(x));
...
```

- Use `coder.varsize` to declare that an output argument has a variable size or to address size mismatch errors. Otherwise, to define variable-size data, use the methods described in “Define Variable-Size Data for Code Generation”.

Note For MATLAB Function blocks, to declare variable-size input or output signals, use the Ports and Data Manager. See “Declare Variable-Size Inputs and Outputs”. If you provide upper bounds in a `coder.varsize` declaration, the upper bounds must match the upper bounds in the Ports and Data Manager.

For more restrictions and guidelines, see “Limitations” on page 2-156 and “Tips” on page 2-158.

`coder.varsize(varName1,...,varNameN,ubounds)` also specifies an upper bound for each dimension of the variables. All variables must have the same number of dimensions. All dimensions, except singleton dimensions on page 2-158, are allowed to change size.

`coder.varsize(varName1,...,varNameN,ubounds,dims)` also specifies an upper bound for each dimension of the variables and whether each dimension has a fixed size or a variable size. If a dimension has a fixed size, then the corresponding `ubound` element specifies the fixed size of the dimension. All variables have the same fixed-size dimensions and the same variable-size dimensions.

Examples

Address Size Mismatch Error by Using `coder. varsize`

After a variable is used (read), changing the size of the variable can cause a size mismatch error. Use `coder. varsize` to specify that the size of the variable can change.

Code generation for the following function produces a size mismatch error because `x = 1:10` changes the size of the second dimension of `x` after the line `y = size(x)` that uses `x`.

```
function [x,y] = usevarsize(n)
%#codegen
x = 1;
y = size(x);
if n > 10
    x = 1:10;
end
```

To declare that `x` can change size, use `coder. varsize`.

```
function [x,y] = usevarsize(n)
%#codegen
x = 1;
coder. varsize('x');
y = size(x);
if n > 10
    x = 1:10;
end
```

If you remove the line `y = size(x)`, you no longer need the `coder. varsize` declaration because `x` is not used before its size changes.

Declare Variable-Size Array with Upper Bounds

Specify that `A` is a row vector whose second dimension has a variable size with an upper bound of 20.

```
function fcn()
...
coder. varsize('A',[1 20]);
...
end
```

When you do not provide `dims`, all dimensions, except singleton dimensions, have a variable size.

Declare Variable-Size Array with a Mix of Fixed and Variable Dimensions

Specify that `A` is an array whose first dimension has a fixed size of three and whose second dimension has a variable size with an upper bound of 20.

```
function fcn()
...
coder. varsize('A',[3 20], [0 1] );
```

```
...
end
```

Declare Variable-Size Structure Fields

In this function, the statement `coder.varsize('data.values')` declares that the field `values` inside each element of `data` has a variable size.

```
function y = varsize_field()
%#codegen

d = struct('values', zeros(1,0), 'color', 0);
data = repmat(d, [3 3]);
coder.varsize('data.values');

for i = 1:numel(data)
    data(i).color = rand-0.5;
    data(i).values = 1:i;
end

y = 0;
for i = 1:numel(data)
    if data(i).color > 0
        y = y + sum(data(i).values);
    end
end
```

Declare Variable-Size Cell Array

Specify that cell array `C` has a fixed-size first dimension and variable-size second dimension with an upper bound of three. The `coder.varsize` declaration must precede the first use of `C`.

```
...
C = {1 [1 2]};
coder.varsize('C', [1 3], [0 1]);
y = C{1};
...
end
```

Without the `coder.varsize` declaration, `C` is a heterogeneous cell array whose elements have the same class and different sizes. With the `coder.varsize` declaration, `C` is a homogeneous cell array whose elements have the same class and maximum size. The first dimension of each element is fixed at 1. The second dimension of each element has a variable size with an upper bound of 3.

Declare That a Cell Array Has Variable-Size Elements

Specify that the elements of cell array `C` are vectors with a fixed-size first dimension and variable-size second dimension with an upper bound of 5.

```
...
C = {1 2 3};
coder.varsize('C{:}', [1 5], [0 1]);
```

```
C = {1, 1:5, 2:3};
...
```

Input Arguments

varName1, ..., varNameN — Names of variables to declare as having a variable size
character vectors | string scalars

Names of variables to declare as having a variable size, specified as one or more character vectors or string scalars.

Example: `coder.varsize('x','y')`

ubounds — Upper bounds for array dimensions
[] (default) | vector of integer constants

Upper bounds for array dimensions, specified as a vector of integer constants.

When you do not specify `ubounds`, the code generator computes the upper bound for each variable. If the `ubounds` element corresponds to a fixed-size dimension, the value is the fixed size of the dimension.

Example: `coder.varsize('x','y',[1 2])`

dims — Indication of whether each dimension has a fixed size or a variable size
logical vector

Indication of whether each dimension has a fixed size or a variable size, specified as a logical vector. Dimensions that correspond to 0 or `false` in `dims` have a fixed size. Dimensions that correspond to 1 or `true` have a variable size.

When you do not specify `dims`, the dimensions have a variable size, except for the singleton dimensions.

Example: `coder.varsize('x','y',[1 2], [0 1])`

Limitations

- The `coder.varsize` declaration instructs the code generator to allow the size of a variable to change. It does not change the size of the variable. Consider this code:

```
...
x = 7;
coder.varsize('x', [1,5]);
disp(size(x));
...
```

After the `coder.varsize` declaration, `x` is still a 1-by-1 array. You cannot assign a value to an element beyond the current size of `x`. For example, this code produces a run-time error because the index 3 exceeds the dimensions of `x`.

```
...
x = 7;
coder.varsize('x', [1,5]);
x(3) = 1;
...
```

- `coder.versize` is not supported for a function input argument. Instead:
 - If the function is an entry-point function, specify that an input argument has a variable size by using `coder.typeof` at the command line. Alternatively, specify that an entry-point function input argument has a variable size by using the **Define Input Types** step of the app.
 - If the function is not an entry-point function, use `coder.versize` in the calling function with the variable that is the input to the called function.
- For sparse matrices, `coder.versize` drops upper bounds for variable-size dimensions.
- Limitations for using `coder.versize` with cell arrays:
 - A cell array can have a variable size only if it is homogeneous. When you use `coder.versize` with a heterogeneous cell array, the code generator tries to make the cell array homogeneous. The code generator tries to find a class and maximum size that apply to all elements of the cell array. For example, consider the cell array `c = {1, [2 3]}`. Both elements can be represented by a double type whose first dimension has a fixed size of 1 and whose second dimension has a variable size with an upper bound of 2. If the code generator cannot find a common class and a maximum size, code generation fails. For example, consider the cell array `c = {'a', [2 3]}`. The code generator cannot find a class that can represent both elements because the first element is `char` and the second element is `double`.
 - If you use the `cell` function to define a fixed-size cell array, you cannot use `coder.versize` to specify that the cell array has a variable size. For example, this code causes a code generation error because `x = cell(1,3)` makes `x` a fixed-size,1-by-3 cell array.

```
...
x = cell(1,3);
coder.versize('x',[1 5])
...
```

You can use `coder.versize` with a cell array that you define by using curly braces. For example:

```
...
x = {1 2 3};
coder.versize('x',[1 5])
...
```

- To create a variable-size cell array by using the `cell` function, use this code pattern:

```
function mycell(n)
%#codegen
x = cell(1,n);
for i = 1:n
    x{i} = i;
end
end
```

See “Definition of Variable-Size Cell Array by Using `cell`”.

To specify upper bounds for the cell array, use `coder.versize`.

```
function mycell(n)
%#codegen
x = cell(1,n);
for i = 1:n
    x{i} = i;
coder.versize('x',[1,20]);
```

```
end  
end
```

More About

Singleton Dimension

Dimension for which `size(A,dim) = 1`.

Tips

- In a code generation report or a MATLAB Function report, a colon (:) indicates that a dimension has a variable size. For example, a size of `1x:2` indicates that the first dimension has a fixed size of one and the second dimension has a variable size with an upper bound of two.
- If you use `coder. varsize` to specify that the upper bound of a dimension is 1, by default, the dimension has a fixed size of 1. To specify that the dimension can be 0 (empty array) or 1, set the corresponding element of the `dims` argument to `true`. For example, this code specifies that the first dimension of `x` has a fixed size of 1 and the other dimensions have a variable size of 5.

```
coder. varsize('x', [1,5,5])
```

In contrast, this code specifies that the first dimension of `x` has an upper bound of 1 and has a variable size (can be 0 or 1).

```
coder. varsize('x', [1,5,5], [1,1,1])
```

Note For a MATLAB Function block, you cannot specify that an input or output signal with size 1 has a variable size.

- If you use input variables or the result of a computation using input variables to specify the size of an array, it is declared as variable-size in the generated code. Do not re-use `coder. varsize` on the array, unless you also want to specify an upper bound for its size.
- If you do not specify upper bounds with a `coder. varsize` declaration and the code generator is unable to determine the upper bounds, the generated code uses dynamic memory allocation. Dynamic memory allocation can reduce the speed of generated code. To avoid dynamic memory allocation, specify the upper bounds by providing the `ubounds` argument.

See Also

Topics

“Code Generation for Variable-Size Arrays”

“Incompatibilities with MATLAB in Variable-Size Support for Code Generation”

“Avoid Duplicate Functions in Generated Code”

Introduced in R2011a

coder.wref

Indicate write-only data to pass by reference

Syntax

```
coder.wref(arg)
```

Description

`coder.wref(arg)` indicates that `arg` is a write-only expression or variable to pass by reference to an external C/C++ function. Use `coder.wref` only inside a `coder.ceval` call. This function enables the code generator to optimize the generated code by ignoring prior assignments to `arg` in your MATLAB code, because the external function is assumed to not read from the data. Write to all the elements of `arg` in your external code to fully initialize the memory.

Note The C/C++ function must fully initialize the memory referenced by `coder.wref(arg)`. Initialize the memory by assigning values to every element of `arg` in your C/C++ code. If the generated code tries to read from uninitialized memory, it can cause undefined run-time behavior.

See also `coder.ref` and `coder.rref`.

Examples

Pass Array by Reference as Write-Only

Suppose that you have a C function `init_array`.

```
void init_array(double* array, int numel) {
    for(int i = 0; i < numel; i++) {
        array[i] = 42;
    }
}
```

The C function defines the input variable `array` as a pointer to a double.

Call the C function `init_array` to initialize all elements of `y` to 42:

```
...
Y = zeros(5, 10);
coder.ceval('init_array', coder.wref(Y), int32(numel(Y)));
...
```

Pass Multiple Arguments as a Write-Only Reference

```
...
U = zeros(5, 10);
V = zeros(5, 10);
coder.ceval('my_fcn', coder.wref(U), int32(numel(U)), coder.wref(V), int32(numel(V)));
...
```

Pass Class Property as a Write-Only Reference

```

...
x = myClass;
x.prop = 1;
coder.ceval('foo', coder.wref(x.prop));
...

```

Pass Structure as a Write-Only Reference

To indicate that the structure type is defined in a C header file, use `coder.cstructname`.

Suppose that you have the C function `init_struct`. This function writes to the input argument but does not read from it.

```

#include "MyStruct.h"

void init_struct(struct MyStruct *my_struct)
{
    my_struct->f1 = 1;
    my_struct->f2 = 2;
}

```

The C header file, `MyStruct.h`, defines a structure type named `MyStruct`:

```

#ifndef MYSTRUCT
#define MYSTRUCT

typedef struct MyStruct
{
    double f1;
    double f2;
} MyStruct;

void init_struct(struct MyStruct *my_struct);

#endif

```

In your MATLAB function, pass a structure as a write-only reference to `init_struct`. Use `coder.cstructname` to indicate that the structure type for `s` has the name `MyStruct` that is defined in the C header file `MyStruct.h`.

```

function y = foo
%#codegen
y = 0;
coder.updateBuildInfo('addSourceFiles','init_struct.c');

s = struct('f1',1,'f2',2);
coder.cstructname(s,'MyStruct','extern','HeaderFile','MyStruct.h');
coder.ceval('init_struct', coder.wref(s));

```

To generate standalone library code, enter:

```
codegen -config:lib foo -report
```

Pass Structure Field as a Write-Only Reference

```

...
s = struct('s1', struct('a', [0 1]));

```

```
coder.ceval('foo', coder.wref(s.s1.a));
...
```

You can also pass an element of an array of structures:

```
...
c = repmat(struct('u',magic(2)),1,10);
b = repmat(struct('c',c),3,6);
a = struct('b',b);
coder.ceval('foo', coder.wref(a.b(3,4).c(2).u));
...
```

Input Arguments

arg — Argument to pass by reference

scalar variable | array | element of an array | structure | structure field | object property

Argument to pass by reference to an external C/C++ function. The argument cannot be a class, a System object, a cell array, or an index into a cell array.

Data Types: single | double | int8 | int16 | int32 | int64 | uint8 | uint16 | uint32 | uint64 | logical | char | struct

Complex Number Support: Yes

Limitations

- You cannot pass these data types by reference:
 - Class or System object
 - Cell array or index into a cell array
- If a property has a get method, a set method, or validators, or is a System object property with certain attributes, then you cannot pass the property by reference to an external function. See “Passing By Reference Not Supported for Some Properties”.

Tips

- If `arg` is an array, then `coder.wref(arg)` provides the address of the first element of the array. The `coder.wref(arg)` function does not contain information about the size of the array. If the C function must know the number of elements of your data, pass that information as a separate argument. For example:

```
coder.ceval('myFun',coder.wref(arg),int32(numel(arg)));
```

- When you pass a structure by reference to an external C/C++ function, use `coder.cstructname` to provide the name of a C structure type that is defined in a C header file.
- In MATLAB, `coder.wref` results in an error. To parametrize your MATLAB code so that it can run in MATLAB and in generated code, use `coder.target`.
- You can use `coder.opaque` to declare variables that you pass to and from an external C/C++ function.

Extended Capabilities

C/C++ Code Generation

Generate C and C++ code using MATLAB® Coder™.

GPU Code Generation

Generate CUDA® code for NVIDIA® GPUs using GPU Coder™.

See Also

`coder.ref` | `coder.rref` | `coder.ceval` | `coder.opaque` | `coder.cstructname`

Topics

“Integrate C Code by Using the MATLAB Function Block”

Introduced in R2011a

configset.reference.getOverriddenParameters

Parameters that are overridden in a configuration reference

Syntax

```
parameters = getOverriddenParameters(model)
```

Description

`parameters = getOverriddenParameters(model)` returns the parameters that are overridden in the configuration reference that is active for the model.

Examples

Override Parameters in a Configuration Reference

Programmatically override a parameter in a configuration reference and set a value that is different from the referenced configuration set.

Open the model `slexConfigSetRefExample`, which uses a configuration reference as the active configuration.

```
model = 'slexConfigSetRefExample';
open(model)
```

Check if the model has any overridden parameters.

```
configset.reference.hasOverriddenParameters(model)
```

```
ans = logical
      0
```

The model does not have any overridden parameters. For this example, override the parameter `ModelReferenceNumInstancesAllowed`. This parameter controls the number of times that the model can be referenced directly or indirectly by another model. In the referenced configuration set, the value is `Multi`. For the model `slexConfigSetRefExample`, override the parameter and set the value to `Single` so that it can be referenced only once by another model.

```
configset.reference.overrideParameter(model, "ModelReferenceNumInstancesAllowed", "Single");
```

Verify that the parameter `ModelReferenceNumInstancesAllowed` is overridden and check its value for the model.

```
configset.reference.isParameterOverridden(model, "ModelReferenceNumInstancesAllowed")
```

```
ans = logical
      1
```

```
get_param(model, "ModelReferenceNumInstancesAllowed")
```

```
ans =  
'Single'
```

Restore the parameter to the value in the referenced configuration set. Restoring the parameter makes it read-only again.

```
configset.reference.restoreOverriddenParameter(model, "ModelReferenceNumInstancesAllowed");
```

If multiple parameters are overridden for the model, you can interact with all of them at once. For example, override the parameters `StartTime`, `StopTime`, and `SolverType`. Then, use the function `configset.reference.getOverriddenParameters` to see a list of the overridden parameters.

```
configset.reference.overrideParameter(model, "StartTime");  
configset.reference.overrideParameter(model, "StopTime");  
configset.reference.overrideParameter(model, "Solver");  
configset.reference.getOverriddenParameters(model)
```

```
ans = 3x1 string  
    "StartTime"  
    "StopTime"  
    "Solver"
```

Now, restore all of the overridden parameters for the model. The parameters reset to the values in the referenced configuration set and become read-only again.

```
configset.reference.restoreAllOverriddenParameters(model)
```

Input Arguments

model — Model that uses configuration reference

character vector | string scalar

Model that uses configuration reference, specified as a character vector or string scalar.

Example: 'vdp'

Output Arguments

parameters — Overridden parameters

string array

Overridden parameters, returned as a string array.

See Also

`configset.reference.overrideParameter` |
`configset.reference.restoreOverriddenParameter` |
`configset.reference.restoreAllOverriddenParameters`

Topics

“Change Parameter Value in a Configuration Reference”

Introduced in R2021a

configset.reference.hasOverriddenParameters

Determine if model configuration reference has overridden parameters

Syntax

```
tf = configset.reference.hasOverriddenParameters(model)
```

Description

`tf = configset.reference.hasOverriddenParameters(model)` determines if the `model` uses a configuration reference that contains overridden parameters. An overridden parameter can have a value that is different from the value in the referenced configuration set.

Examples

Override Parameters in a Configuration Reference

Programmatically override a parameter in a configuration reference and set a value that is different from the referenced configuration set.

Open the model `slexConfigSetRefExample`, which uses a configuration reference as the active configuration.

```
model = 'slexConfigSetRefExample';
open(model)
```

Check if the model has any overridden parameters.

```
configset.reference.hasOverriddenParameters(model)
```

```
ans = logical
      0
```

The model does not have any overridden parameters. For this example, override the parameter `ModelReferenceNumInstancesAllowed`. This parameter controls the number of times that the model can be referenced directly or indirectly by another model. In the referenced configuration set, the value is `Multi`. For the model `slexConfigSetRefExample`, override the parameter and set the value to `Single` so that it can be referenced only once by another model.

```
configset.reference.overrideParameter(model, "ModelReferenceNumInstancesAllowed", "Single");
```

Verify that the parameter `ModelReferenceNumInstancesAllowed` is overridden and check its value for the model.

```
configset.reference.isParameterOverridden(model, "ModelReferenceNumInstancesAllowed")
```

```
ans = logical
      1
```

```
get_param(model, "ModelReferenceNumInstancesAllowed")
```

```
ans =  
'Single'
```

Restore the parameter to the value in the referenced configuration set. Restoring the parameter makes it read-only again.

```
configset.reference.restoreOverriddenParameter(model, "ModelReferenceNumInstancesAllowed");
```

If multiple parameters are overridden for the model, you can interact with all of them at once. For example, override the parameters `StartTime`, `StopTime`, and `SolverType`. Then, use the function `configset.reference.getOverriddenParameters` to see a list of the overridden parameters.

```
configset.reference.overrideParameter(model, "StartTime");  
configset.reference.overrideParameter(model, "StopTime");  
configset.reference.overrideParameter(model, "Solver");  
configset.reference.getOverriddenParameters(model)
```

```
ans = 3x1 string  
    "StartTime"  
    "StopTime"  
    "Solver"
```

Now, restore all of the overridden parameters for the model. The parameters reset to the values in the referenced configuration set and become read-only again.

```
configset.reference.restoreAllOverriddenParameters(model)
```

Input Arguments

model — Model that uses configuration reference

character vector | string scalar

Model that uses configuration reference, specified as a character vector or string scalar.

Example: `'vdp'`

Output Arguments

tf — True or false result

1 | 0 | logical array

True or false result, returned as a 1 or 0 of data type `logical`.

See Also

```
configset.reference.overrideParameter |  
configset.reference.getOverriddenParameters |  
configset.reference.restoreOverriddenParameter |  
configset.reference.restoreAllOverriddenParameters
```

Topics

“Change Parameter Value in a Configuration Reference”

Introduced in R2021a

configset.reference.isParameterOverridden

Determine if parameter is overridden in configuration reference of model

Syntax

```
tf = configset.reference.isParameterOverridden(model, parameter)
```

Description

`tf = configset.reference.isParameterOverridden(model, parameter)` determines if the specified model uses a configuration reference in which the parameter that you specify is overridden. An overridden parameter can have a value that is different from the value in the referenced configuration set.

Examples

Override Parameters in a Configuration Reference

Programmatically override a parameter in a configuration reference and set a value that is different from the referenced configuration set.

Open the model `slexConfigSetRefExample`, which uses a configuration reference as the active configuration.

```
model = 'slexConfigSetRefExample';
open(model)
```

Check if the model has any overridden parameters.

```
configset.reference.hasOverriddenParameters(model)
```

```
ans = logical
      0
```

The model does not have any overridden parameters. For this example, override the parameter `ModelReferenceNumInstancesAllowed`. This parameter controls the number of times that the model can be referenced directly or indirectly by another model. In the referenced configuration set, the value is `Multi`. For the model `slexConfigSetRefExample`, override the parameter and set the value to `Single` so that it can be referenced only once by another model.

```
configset.reference.overrideParameter(model, "ModelReferenceNumInstancesAllowed", "Single");
```

Verify that the parameter `ModelReferenceNumInstancesAllowed` is overridden and check its value for the model.

```
configset.reference.isParameterOverridden(model, "ModelReferenceNumInstancesAllowed")
```

```
ans = logical
      1
```

```
get_param(model, "ModelReferenceNumInstancesAllowed")
```

```
ans =  
'Single'
```

Restore the parameter to the value in the referenced configuration set. Restoring the parameter makes it read-only again.

```
configset.reference.restoreOverriddenParameter(model, "ModelReferenceNumInstancesAllowed");
```

If multiple parameters are overridden for the model, you can interact with all of them at once. For example, override the parameters `StartTime`, `StopTime`, and `SolverType`. Then, use the function `configset.reference.getOverriddenParameters` to see a list of the overridden parameters.

```
configset.reference.overrideParameter(model, "StartTime");  
configset.reference.overrideParameter(model, "StopTime");  
configset.reference.overrideParameter(model, "Solver");  
configset.reference.getOverriddenParameters(model)
```

```
ans = 3x1 string  
    "StartTime"  
    "StopTime"  
    "Solver"
```

Now, restore all of the overridden parameters for the model. The parameters reset to the values in the referenced configuration set and become read-only again.

```
configset.reference.restoreAllOverriddenParameters(model)
```

Input Arguments

model — Model that uses configuration reference

character vector | string scalar

Model that uses configuration reference, specified as a character vector or string scalar.

Example: 'vdp'

parameter — Parameter to check

character vector | string scalar

Parameter to check, specified as a character vector or string scalar.

Example: 'ModelReferenceNumInstancesAllowed'

Output Arguments

tf — True or false result

1 | 0 | logical array

True or false result, returned as a 1 or 0 of data type logical.

See Also

`configset.reference.restoreOverriddenParameter |`
`configset.reference.overrideParameter`

Topics

“Change Parameter Value in a Configuration Reference”

Introduced in R2021a

configset.reference.overrideParameter

Change value of parameter in configuration reference

Syntax

```
configset.reference.overrideParameter(model, parameter)
configset.reference.overrideParameter(model, parameter, value)
```

Description

`configset.reference.overrideParameter(model, parameter)` overrides the parameter `parameter` in the active configuration reference that `model` uses. By default, a configuration reference uses the parameter values from the configuration set that it references and does not enable editing. Overriding a parameter enables editing in the configuration reference so that you can change the value for the parameter in the reference without changing the referenced configuration set. Changing the value in the referenced configuration set does not affect the value of the overridden parameter. Some parameters cannot be overridden.

`configset.reference.overrideParameter(model, parameter, value)` overrides the parameter and sets the value in the configuration reference to `value`.

Examples

Override Parameters in a Configuration Reference

Programmatically override a parameter in a configuration reference and set a value that is different from the referenced configuration set.

Open the model `slexConfigSetRefExample`, which uses a configuration reference as the active configuration.

```
model = 'slexConfigSetRefExample';
open(model)
```

Check if the model has any overridden parameters.

```
configset.reference.hasOverriddenParameters(model)
```

```
ans = logical
      0
```

The model does not have any overridden parameters. For this example, override the parameter `ModelReferenceNumInstancesAllowed`. This parameter controls the number of times that the model can be referenced directly or indirectly by another model. In the referenced configuration set, the value is `Multi`. For the model `slexConfigSetRefExample`, override the parameter and set the value to `Single` so that it can be referenced only once by another model.

```
configset.reference.overrideParameter(model, "ModelReferenceNumInstancesAllowed", "Single");
```

Verify that the parameter `ModelReferenceNumInstancesAllowed` is overridden and check its value for the model.

```
configset.reference.isParameterOverridden(model, "ModelReferenceNumInstancesAllowed")
```

```
ans = logical
      1
```

```
get_param(model, "ModelReferenceNumInstancesAllowed")
```

```
ans =
'Single'
```

Restore the parameter to the value in the referenced configuration set. Restoring the parameter makes it read-only again.

```
configset.reference.restoreOverriddenParameter(model, "ModelReferenceNumInstancesAllowed");
```

If multiple parameters are overridden for the model, you can interact with all of them at once. For example, override the parameters `StartTime`, `StopTime`, and `SolverType`. Then, use the function `configset.reference.getOverriddenParameters` to see a list of the overridden parameters.

```
configset.reference.overrideParameter(model, "StartTime");
configset.reference.overrideParameter(model, "StopTime");
configset.reference.overrideParameter(model, "Solver");
configset.reference.getOverriddenParameters(model)
```

```
ans = 3x1 string
      "StartTime"
      "StopTime"
      "Solver"
```

Now, restore all of the overridden parameters for the model. The parameters reset to the values in the referenced configuration set and become read-only again.

```
configset.reference.restoreAllOverriddenParameters(model)
```

Input Arguments

model — Model that uses configuration reference

character vector | string scalar

Model that uses the configuration reference, specified as a character vector or string scalar.

Example: `'vdp'`

parameter — Parameter to override

character vector | string scalar

Parameter to override, specified as a character vector or string scalar.

Example: `'ModelReferenceNumInstancesAllowed'`

value — Value to set

character vector | string scalar

Value to set for the overridden parameter, specified as a character vector or string scalar.

Example: 'Multi'

See Also

`configset.reference.restoreOverriddenParameter` |
`configset.reference.getOverriddenParameters`

Topics

“Change Parameter Value in a Configuration Reference”

Introduced in R2021a

configset.reference.restoreAllOverriddenParameters

Restore all overridden parameters in configuration reference of model

Syntax

```
configset.reference.restoreAllOverriddenParameters(model)
```

Description

`configset.reference.restoreAllOverriddenParameters(model)` restores all parameters that are overridden in the configuration reference that is active in the model. The overridden parameters reset to the values in the referenced configuration and become read-only again.

Examples

Override Parameters in a Configuration Reference

Programmatically override a parameter in a configuration reference and set a value that is different from the referenced configuration set.

Open the model `slexConfigSetRefExample`, which uses a configuration reference as the active configuration.

```
model = 'slexConfigSetRefExample';  
open(model)
```

Check if the model has any overridden parameters.

```
configset.reference.hasOverriddenParameters(model)
```

```
ans = logical  
     0
```

The model does not have any overridden parameters. For this example, override the parameter `ModelReferenceNumInstancesAllowed`. This parameter controls the number of times that the model can be referenced directly or indirectly by another model. In the referenced configuration set, the value is `Multi`. For the model `slexConfigSetRefExample`, override the parameter and set the value to `Single` so that it can be referenced only once by another model.

```
configset.reference.overrideParameter(model, "ModelReferenceNumInstancesAllowed", "Single");
```

Verify that the parameter `ModelReferenceNumInstancesAllowed` is overridden and check its value for the model.

```
configset.reference.isParameterOverridden(model, "ModelReferenceNumInstancesAllowed")
```



```
ans = logical
      1
```

```
get_param(model, "ModelReferenceNumInstancesAllowed")
```

```
ans =
'Single'
```

Restore the parameter to the value in the referenced configuration set. Restoring the parameter makes it read-only again.

```
configset.reference.restoreOverriddenParameter(model, "ModelReferenceNumInstancesAllowed");
```

If multiple parameters are overridden for the model, you can interact with all of them at once. For example, override the parameters `StartTime`, `StopTime`, and `SolverType`. Then, use the function `configset.reference.getOverriddenParameters` to see a list of the overridden parameters.

```
configset.reference.overrideParameter(model, "StartTime");
configset.reference.overrideParameter(model, "StopTime");
configset.reference.overrideParameter(model, "Solver");
configset.reference.getOverriddenParameters(model)
```

```
ans = 3x1 string
      "StartTime"
      "StopTime"
      "Solver"
```

Now, restore all of the overridden parameters for the model. The parameters reset to the values in the referenced configuration set and become read-only again.

```
configset.reference.restoreAllOverriddenParameters(model)
```

Input Arguments

model — Model that uses configuration reference

character vector | string scalar

Model that uses configuration reference, specified as a character vector or string scalar.

Example: 'vdp'

See Also

`configset.reference.restoreOverriddenParameter` |
`configset.reference.getOverriddenParameters` |
`configset.reference.overrideParameter`

Topics

"Change Parameter Value in a Configuration Reference"

Introduced in R2021a

configset.reference.restoreOverriddenParameter

Restore overridden parameter in configuration reference of model

Syntax

```
configset.reference.restoreOverriddenParameter(model, parameter)
```

Description

`configset.reference.restoreOverriddenParameter(model, parameter)` restores the overridden parameter that you specify in the configuration reference that is active in the model. The overridden parameter resets to the value in the referenced configuration and becomes read-only again.

Examples

Override Parameters in a Configuration Reference

Programmatically override a parameter in a configuration reference and set a value that is different from the referenced configuration set.

Open the model `slexConfigSetRefExample`, which uses a configuration reference as the active configuration.

```
model = 'slexConfigSetRefExample';
open(model)
```

Check if the model has any overridden parameters.

```
configset.reference.hasOverriddenParameters(model)
```

```
ans = logical
      0
```

The model does not have any overridden parameters. For this example, override the parameter `ModelReferenceNumInstancesAllowed`. This parameter controls the number of times that the model can be referenced directly or indirectly by another model. In the referenced configuration set, the value is `Multi`. For the model `slexConfigSetRefExample`, override the parameter and set the value to `Single` so that it can be referenced only once by another model.

```
configset.reference.overrideParameter(model, "ModelReferenceNumInstancesAllowed", "Single");
```

Verify that the parameter `ModelReferenceNumInstancesAllowed` is overridden and check its value for the model.

```
configset.reference.isParameterOverridden(model, "ModelReferenceNumInstancesAllowed")
```

```
ans = logical
      1
```

```
get_param(model, "ModelReferenceNumInstancesAllowed")
```

```
ans =  
'Single'
```

Restore the parameter to the value in the referenced configuration set. Restoring the parameter makes it read-only again.

```
configset.reference.restoreOverriddenParameter(model, "ModelReferenceNumInstancesAllowed");
```

If multiple parameters are overridden for the model, you can interact with all of them at once. For example, override the parameters `StartTime`, `StopTime`, and `SolverType`. Then, use the function `configset.reference.getOverriddenParameters` to see a list of the overridden parameters.

```
configset.reference.overrideParameter(model, "StartTime");  
configset.reference.overrideParameter(model, "StopTime");  
configset.reference.overrideParameter(model, "Solver");  
configset.reference.getOverriddenParameters(model)
```

```
ans = 3x1 string  
    "StartTime"  
    "StopTime"  
    "Solver"
```

Now, restore all of the overridden parameters for the model. The parameters reset to the values in the referenced configuration set and become read-only again.

```
configset.reference.restoreAllOverriddenParameters(model)
```

Input Arguments

model — Model that uses configuration reference

character vector | string scalar

Model that uses configuration reference, specified as a character vector or string scalar.

Example: `'vdp'`

parameter — Parameter to restore

character vector | string scalar

Parameter to restore, specified as a character vector or string scalar.

Example: `'ModelReferenceNumInstancesAllowed'`

See Also

`configset.reference.restoreAllOverriddenParameters` |
`configset.reference.overrideParameter` |
`configset.reference.isParameterOverridden`

Topics

“Change Parameter Value in a Configuration Reference”

Introduced in R2021a

createCustomDBFromExcel

Create custom units database file from Microsoft Excel spreadsheet

Syntax

```
createCustomDBFromExcel(units_db.xlsx)
```

Description

`createCustomDBFromExcel(units_db.xlsx)` creates a custom units database file from an Excel spreadsheet that contains custom units. On all supported platforms, the `createCustomDBFromExcel` function supports: `.xls` and `.xlsx` files.

To see the supported spreadsheet format, see “Custom Units Spreadsheet Format”.

Examples

Create Custom Units Database File from Excel Spreadsheet

Create a custom units database file from custom Excel spreadsheet file, `unitsDB.xlsx`.

Create a Excel spreadsheet containing these columns and data in any order:

- **name**, containing `ounce_force`
- **symbol**, containing `ozf`
- **asciiSymbol**, containing `ozf`
- **displayName**, containing $\{\rm\{oz_force\}}$
- **definitionExpression**, containing `oz*gn`
- **conversionFactor**, containing `1`
- **conversionOffset**, containing `0`
- **physicalQuantity**, containing `force`

Enter your custom unit specifications.

Save the database file, for example `unitsDB.xlsx`.

Create the database.

```
createCustomDBFromExcel('unitsDB.xlsx')
```

The function creates `unitsDB.slunitdb.mldatx` in the current folder.

Add the current folder to the MATLAB path.

```
addpath C:\work\custom_units
```

Load the new units database into memory.

rehashUnitDBs

Input Arguments

units_db.xlsx — Custom unit database

Excel units database file name

Custom unit database, specified as the file name of an Excel units database file. Create this file as an Excel spreadsheet with columns that contain custom unit information.

The function creates a unit database file, *units_db.slunitdb.mldatx*, in the current folder, where *units_db* is the name of the Excel file. If the unit entry is empty for the **symbol**, **asciiSymbol**, or **displayName** columns, the function uses the unit name for the missing **symbol**, **asciiSymbol**, or **displayName** entries.

To see the supported spreadsheet format, see “Custom Units Spreadsheet Format”.

Example: `custom_units.xlsx`

Data Types: `char` | `string`

See Also

rehashUnitDBs | Unit System Configuration | Unit Conversion

Topics

“Working with Custom Unit Databases”

“Unit Specification in Simulink Models”

“Displaying Units”

“Unit Consistency Checking and Propagation”

“Converting Units”

Introduced in R2020a

createInputDataset

Generate dataset object for root-level Inport or bus element ports in model

Syntax

```
[inports_dataset] = createInputDataset(model)
[inports_dataset] = createInputDataset(model,
'DatasetSignalFormat',signalFormat)
```

Description

[inports_dataset] = createInputDataset(model) generates a Simulink.SimulationData.Dataset object from the root-level Inport blocks or bus element ports in a model. Signals in the generated dataset have the properties of the root inports and the corresponding ground values at model start and stop times. You can create timetable or timeseries objects for the time and values for signals for which you want to load data for simulation. The other signals use ground values.

```
[inports_dataset] = createInputDataset(model,
'DatasetSignalFormat',signalFormat) generates a Simulink.SimulationData.Dataset object whose signal dataset signal elements are either timeseries or timetable.
```

Examples

Generate and Populate Dataset for Root-Level Inport Blocks

This example shows how to create a dataset with elements for the four root-level Inport blocks in a model. Use that dataset as a basis for creating a dataset to load signal data into the model.

The In1 block outputs a double, In2 and In3 each output a nonvirtual bus, and In4 outputs an int16.

```
mdl = 'ex_dataset_for_inports';
open_system(mdl)
```

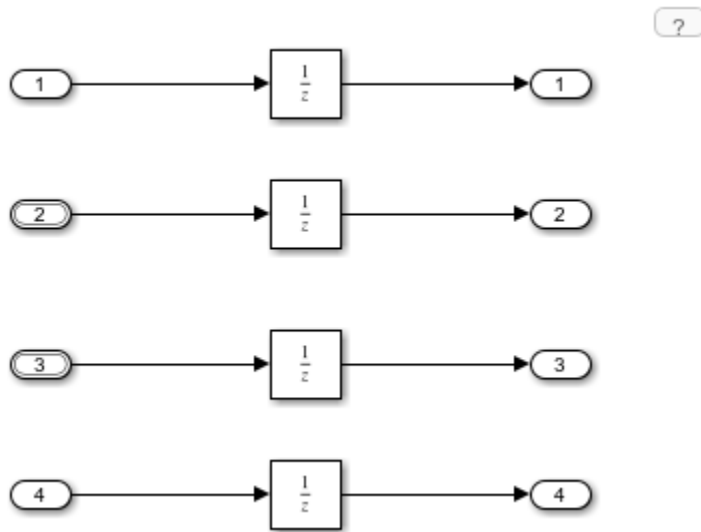

Create a Dataset object for the root-level Inport blocks.

```
ds = createInputDataset mdl
```

```
ds =
```

```
Simulink.SimulationData.Dataset '' with 4 elements
```

| | Name | BlockPath |
|---|------------------|-----------|
| 1 | [1x1 timeseries] | In1 |
| 2 | [1x1 struct] | In2 |
| 3 | [1x1 struct] | In3 |
| 4 | [1x1 timeseries] | In4 |

- Use braces { } to access, modify, or add elements using index.

Replace the placeholder value for the first signal in the Dataset with actual signal values that you want to load into the model.

```
ds{1} = ds{1}.delsample('Index',[1,2]);
ds{1} = ds{1}.addsample('time',[1 3 3 10]','data',[1 1 5 5]');
```

Examine the In2 signal.

```
ds{2}
```

```
ans =
```

```
struct with fields:
    a: [1x1 timeseries]
    b: [1x1 timeseries]
```

For In2 , create data for bus elements a and b.

```
ds{2}.a = ds{2}.a.delsample('Index',[1,2]);
ds{2}.a = addsample(ds{2}.a,'time',[1:10]','data',[1:10]');
ds{2}.b = timeseries((1:10)',0.1:.1:1,'Name','sig2_b');
```

For In3, specify data for element a of the bus, and use ground values for element b.

```
ds{3}.a = timeseries((1:10)',0.1:.1:1,'Name','sig3_a');
```

Plot ds.

```
plot(ds)
```

Set the **Input** configuration parameter to ds. Alternatively, you can use the Root Inport Mapper tool to set the **Input** parameter.

```
set_param mdl, 'LoadExternalInput', 'on';
set_param mdl, 'ExternalInput', 'ds';
```

Run the simulation. The Inport blocks use the signal data specified in ds or ground values for elements that do not have specified signal data.

```
sim mdl)
```

Input Arguments

mdl — Model for which to generate dataset for root-level Inport blocks or bus element ports

character vector | model handle

Model for which to generate a dataset with an element for each root-level Inport block, specified as a character vector or model handle.

'DatasetSignalFormat' — Signal format for dataset signal elements

'timeseries' (default) | 'timedata'

Signal format for dataset signal elements, specified as 'timedata' or 'timeseries'.

Data Types: char | string

Output Arguments

inports_dataset — Dataset with an element for each root-level Inport block

a Simulink.SimulationData.Dataset object

Dataset with an element for each root-level Inport block, returned as a Simulink.SimulationData.Dataset object.

See Also

Simulink.SimulationData.Dataset | timeseries | timetable

Topics

“Create a Dataset Object for Inport Blocks”

Introduced in R2017a

getHardwareImplementation

Class: `coder.BuildConfig`

Package: `coder`

Get handle of copy of hardware implementation object

Syntax

```
hw = bldcfg.getHardwareImplementation()
```

Description

`hw = bldcfg.getHardwareImplementation()` returns the handle of a copy of the hardware implementation object.

Input Arguments

bldcfg

`coder.BuildConfig` object.

Output Arguments

hw

Handle of copy of hardware implementation object.

See Also

getStdLibInfo

Class: coder.BuildConfig

Package: coder

Get standard library information

Syntax

```
[linkLibPath,linkLibExt,execLibExt,libPrefix]= bldcfg.getStdLibInfo()
```

Description

[linkLibPath,linkLibExt,execLibExt,libPrefix]= bldcfg.getStdLibInfo() returns character vectors representing the:

- Standard MATLAB architecture-specific library path
- Platform-specific library file extension for use at link time
- Platform-specific library file extension for use at run time
- Standard architecture-specific library name prefix

Input Arguments

bldcfg

coder.BuildConfig object.

Output Arguments

linkLibPath

Standard MATLAB architecture-specific library path specified as a character vector. The character vector can be empty.

linkLibExt

Platform-specific library file extension for use at link time, specified as a character vector. The value is one of `'.lib'`, `'.dylib'`, `'.so'`, `''`.

execLibExt

Platform-specific library file extension for use at run time, specified as a character vector. The value is one of `'.dll'`, `'.dylib'`, `'.so'`, `''`.

linkPrefix

Standard architecture-specific library name prefix, specified as a character vector. The character vector can be empty.

getTargetLang

Class: coder.BuildConfig

Package: coder

Get target code generation language

Syntax

```
lang = bldcfg.getTargetLang()
```

Description

`lang = bldcfg.getTargetLang()` returns a character vector containing the target code generation language.

Input Arguments

bldcfg

coder.BuildConfig object.

Output Arguments

lang

A character vector containing the target code generation language. The value is 'C' or 'C++'.

getToolchainInfo

Class: `coder.BuildConfig`

Package: `coder`

Returns handle of copy of toolchain information object

Syntax

```
tc = bldcfg.getToolchainInfo()
```

Description

`tc = bldcfg.getToolchainInfo()` returns a handle of a copy of the toolchain information object.

Input Arguments

bldcfg

`coder.BuildConfig` object.

Output Arguments

tc

Handle of copy of toolchain information object.

See Also

isCodeGenTarget

Class: coder.BuildConfig

Package: coder

Determine if build configuration represents specified target

Syntax

```
tf = bldcfg.isCodeGenTarget(target)
```

Description

`tf = bldcfg.isCodeGenTarget(target)` returns true (1) if the code generation target of the current build configuration represents the code generation target specified by `target`. Otherwise, it returns false (0).

Input Arguments

bldcfg

coder.BuildConfig object.

target

Code generation target specified as a character vector or cell array of character vectors.

| Specify | For code generation target |
|---------|--|
| 'rtw' | C/C++ dynamic Library, C/C++ static library, or C/C++ executable |
| 'sfun' | S-function (Simulation) |
| 'mex' | MEX-function |

Specify `target` as a cell array of character vectors to test if the code generation target of the build configuration represents one of the targets specified in the cell array.

For example:

```
...
mytarget = {'sfun','mex'};
tf = bldcfg.isCodeGenTarget(mytarget);
...
```

tests whether the build context represents an S-function target or a MEX-function target.

Output Arguments

tf

The value is true (1) if the code generation target of the build configuration represents the code generation target specified by `target`. Otherwise, the value is false (0).

See Also

`coder.target`

isMatlabHostTarget

Class: coder.BuildConfig

Package: coder

Determine if hardware implementation object target is MATLAB host computer

Syntax

```
tf = bldcfg.isMatlabHostTarget()
```

Description

`tf = bldcfg.isMatlabHostTarget()` returns true (1) if the current hardware implementation object targets the MATLAB host computer. Otherwise, it returns false (0).

Input Arguments

bldcfg

coder.BuildConfig object.

Output Arguments

tf

Value is true (1) if the current hardware implementation object targets the MATLAB host computer. Otherwise, the value is false (0).

See Also

coder.ExternalDependency.getDescriptiveName

Class: coder.ExternalDependency

Package: coder

Return descriptive name for external dependency

Syntax

```
extname = coder.ExternalDependency.getDescriptiveName(bldcfg)
```

Description

`extname = coder.ExternalDependency.getDescriptiveName(bldcfg)` returns the name that you want to associate with an “external dependency” on page 2-193. The code generator uses the external dependency name for error messages.

Input Arguments

bldcfg

`coder.BuildConfig` object. Use `coder.BuildConfig` methods to get information about the “build context” on page 2-193

You can use this information when you want to return different names based on the build context.

Output Arguments

extname

External dependency name returned as a character vector.

Examples

Return external dependency name

Define a method that always returns the same name.

```
function myextname = getDescriptiveName(~)
    myextname = 'MyLibrary'
end
```

Return external library name based on the code generation target

Define a method that uses the build context to determine the name.

```
function myextname = getDescriptiveName(context)
    if context.isMatlabHostTarget()
```

```
        myextname = 'MyLibrary_MatlabHost';  
    else  
        myextname = 'MyLibrary_Local';  
    end  
end
```

More About

external dependency

External code interface represented by a class derived from a `coder.ExternalDependency` class. The external code can be a library, object files, or C/C++ source.

build context

Information used by the build process including:

- Target language
- Code generation target
- Target hardware
- Build toolchain

See Also

`coder.updateBuildInfo` | `coder.BuildConfig` | `coder.ceval` | `coder.ExternalDependency`

Topics

“Develop Interface for External C/C++ Code” (MATLAB Coder)

“Build Process Customization” (MATLAB Coder)

“Integrate External/Custom Code” (MATLAB Coder)

coder.ExternalDependency.isSupportedContext

Class: `coder.ExternalDependency`

Package: `coder`

Determine if build context supports external dependency

Syntax

```
tf = coder.ExternalDependency.isSupportedContext(blcfg)
```

Description

`tf = coder.ExternalDependency.isSupportedContext(blcfg)` returns true (1) if you can use the “external dependency” on page 2-195 in the current “build context” on page 2-195 . You must provide this method in the class definition for a class that derives from `coder.ExternalDependency`.

If you cannot use the “external dependency” on page 2-195 in the current “build context” on page 2-195, display an error message and stop code generation. The error message must describe why you cannot use the external dependency in this build context. If the method returns false (0), the code generator uses a default error message. The default error message uses the name returned by the `getDescriptiveName` method of the `coder.ExternalDependency` class.

Use `coder.BuildConfig` methods to determine if you can use the external dependency in the current build context.

Input Arguments

blcfg

`coder.BuildConfig` object. Use `coder.BuildConfig` methods to get information about the “build context” on page 2-195.

Output Arguments

tf

Value is true (1) if the build context supports the external dependency.

Examples

Report error when build context does not support external library

This method returns true(1) if the code generation target is a MATLAB host target. Otherwise, the method reports an error and stops code generation.

Write `isSupportedContext` method.

```
function tf = isSupportedContext(ctx)
    if ctx.isMatlabHostTarget()
        tf = true;
    else
        error('adder library not available for this target');
    end
end
```

More About

external dependency

External code interface represented by a class derived from `coder.ExternalDependency` class. The external code can be a library, object file, or C/C++ source.

build context

Information used by the build process including:

- Target language
- Code generation target
- Target hardware
- Build toolchain

See Also

[coder.updateBuildInfo](#) | [coder.BuildConfig](#) | [coder.ceval](#) | [coder.ExternalDependency](#)

Topics

“Develop Interface for External C/C++ Code” (MATLAB Coder)

“Build Process Customization” (MATLAB Coder)

“Integrate External/Custom Code” (MATLAB Coder)

coder.ExternalDependency.updateBuildInfo

Class: `coder.ExternalDependency`

Package: `coder`

Update build information

Syntax

```
coder.ExternalDependency.updateBuildInfo(buildInfo, bldcfg)
```

Description

`coder.ExternalDependency.updateBuildInfo(buildInfo, bldcfg)` updates the build information object whose handle is `buildInfo`. After code generation, the build information object has standard information. Use this method to provide additional information required to link to external code. Use `coder.BuildConfig` methods to get information about the “build context” on page 2-196.

You must implement this method in a subclass of `coder.ExternalDependency`. For an example, see `coder.ExternalDependency`.

Input Arguments

buildInfo

Handle of build information object.

bldcfg

`coder.BuildConfig` object. Use `coder.BuildConfig` methods to get information about the “build context” on page 2-196.

Limitations

- The build information method `AddIncludeFiles` has no effect in a `coder.ExternalDependency.updateBuildInfo` method.

More About

build context

Information used by the build process including:

- Target language
- Code generation target
- Target hardware
- Build toolchain

See Also

`coder.updateBuildInfo` | `coder.BuildConfig` | `coder.ceval` | `coder.ExternalDependency`

Topics

“Develop Interface for External C/C++ Code” (MATLAB Coder)

“Build Process Customization” (MATLAB Coder)

“Integrate External/Custom Code” (MATLAB Coder)

convertToSLDataset

Convert contents of MAT-file to `Simulink.SimulationData.Dataset` object

Syntax

```
success=convertToSLDataset(source,destination)
success=convertToSLDataset(source,destination,datasetname)
```

Description

`success=convertToSLDataset(source,destination)` converts the contents of a MAT-file (`source`) to a destination MAT-file (`destination`).

`success=convertToSLDataset(source,destination,datasetname)` names the dataset `datasetname`.

When converting structure signal data, the function names the signal using the value contained in the `label` field of the structure signal field, such as: `mySignal.signal(1).label`.

This function ignores time expressions in `source`.

Examples

Save Signals to Dataset in file2.mat

Save signals from `file1.mat` to a dataset named `file1` in `file2.mat`.

```
success=convertToSLDataset('file1.mat','file2.mat')
```

Save Signals to Dataset Named myDataset in file2.mat

Save signals from `file1.mat` to a dataset named `myDataset` in `file2.mat`.

```
success=convertToSLDataset('file1.mat','file2.mat','myDataset')
```

Input Arguments

source — MAT-file

character vector

MAT-file that contains Simulink inputs.

destination — MAT-file

character vector

MAT-file to contain `Simulink.SimulationData.Dataset` converted from contents of `source`.

datasetname — Data set name

character vector

Data set name for new `Simulink.SimulationData.Dataset` object.

Output Arguments**success — Outcome of conversion**

binary

Outcome of conversion, specified as binary:

- 1
Conversion is successful.
- 0
Conversion is not successful.

See Also**Introduced in R2016a**

copy

Copy configuration set or reference

Syntax

```
copyCs = copy(cs)
```

Description

`copyCs = copy(cs)` returns a copy of a configuration set or configuration reference.

Examples

Attach New Configuration Set to a Model

Create a copy of a configuration set and attach it to a model.

Get the active configuration set for your model.

```
activeConfig = getActiveConfigSet ('vdp');
```

Copy the active configuration set.

```
develConfig = copy(activeConfig);
```

Give the copied configuration set a name.

```
develConfig.Name = 'develConfig';
```

Attach the new configuration set to the model.

```
attachConfigSet('vdp',develConfig);
```

Input Arguments

cs — Configuration set

`ConfigSet` object | `ConfigSetRef` object

Configuration set object to copy, specified as a `ConfigSet` object or a `Simulink.ConfigSetRef` object.

Output Arguments

copyCs — Copy of configuration set

`ConfigSet` object

A copy of the configuration set, returned as a `ConfigSet` object or a `ConfigSetRef` object.

See Also

Topics

“Manage Configuration Sets for a Model”

Introduced before R2006a

delete_block

Delete blocks from Simulink system

Syntax

```
delete_block(blockArg)
```

Description

`delete_block(blockArg)` deletes the specified blocks from a system. Open the system before you delete blocks.

Examples

Delete Block Using Full Path Name

Delete the block Mu from the vdp system.

```
open_system('vdp')  
delete_block('vdp/Mu')
```

Delete Block Using Block Handle

Delete the block Out2 from the vdp system using the block handle.

Open the vdp system.

```
open_system('vdp')
```

Interactively select the block Out1. Get the block's handle and assign it to the variable `Out1_handle`. Delete the block using the handle.

```
Out1_handle = get_param(gcf, 'Handle');  
delete_block(Out1_handle)
```

Delete Blocks Using Vector of Handles

Delete three blocks from the vdp system.

Open the vdp system. Add three blocks and assign their handles to variables.

```
open_system('vdp')  
Constant_handle = add_block('built-in/Constant', 'vdp/MyConstant');  
Gain_handle = add_block('built-in/Gain', 'vdp/MyGain');  
Outputport_handle = add_block('built-in/Outputport', 'vdp/MyOutputport');
```

Delete the blocks you added using a vector of handles.

```
delete_block([Constant_handle Gain_handle Outport_handle])
```

Input Arguments

blockArg — Blocks to delete

full path name | handle | vector of handles | 1-D cell array of handles or block path names

Blocks to delete, specified as the full block path name, a handle, a vector of handles, or a 1-D cell array of handles or block path names.

Example: 'vdp/Mu'

Example: [handle1 handle2]

Example: {'vdp/Mu' 'vdp/Out1' 'vdp/Out2'}

See Also

add_block

Introduced before R2006a

delete_line

Delete line from Simulink model

Syntax

```
delete_line(sys,out,in)
delete_line(sys,point)
delete_line(lineHandle)
```

Description

`delete_line(sys,out,in)` deletes the line from the model or subsystem `sys` that connects the output port `out` to the input port `in`.

`delete_line(sys,point)` deletes the line that includes the point `point`.

`delete_line(lineHandle)` deletes the line using the line handle.

Examples

Remove Line Using Block Port Names

For the model `vdp`, remove the line connecting the Product block with the Gain block.

```
load_system('vdp');
delete_line('vdp','Product/1','Mu/1');
```

Remove Line Using Line Handle

For the model `vdp`, remove a line using the line handle. You can get the line handle using different techniques.

```
load_system('vdp');
h = get_param('vdp/Mu','LineHandles');
delete_line(h.Outputport(1));
```

Get a line handle when you create the line. Delete the line using that handle.

```
a = add_line('vdp','Mu/1','Sum/2');
delete_line(a)
```

Delete a Line Using a Point

You can use a point on the line to delete the whole line.

Find the port coordinates for the block `Mu` in the model `vdp`.

```
open_system('vdp');
mu = get_param('vdp/Mu', 'PortConnectivity');
mu.Position
```

```
ans = 1×2
    190    150
```

```
ans = 1×2
    225    150
```

The line that connects the Mu block to the Sum block starts at the output port, which is at (225,150). You can use any point to the right of that point along the same x-axis to delete the line.

```
delete_line('vdp',[230,150]);
```

Delete Segments of Branched Lines

Use `delete_line` with branched lines to remove the segment for any connection.

Open the model `vdp`.

```
open_system('vdp');
```

Delete the line from `x1` to the `Out1` block. This command deletes only the segment of the line that connects the branch to the specified block.

```
delete_line('vdp','x1/1','Out1/1')
```

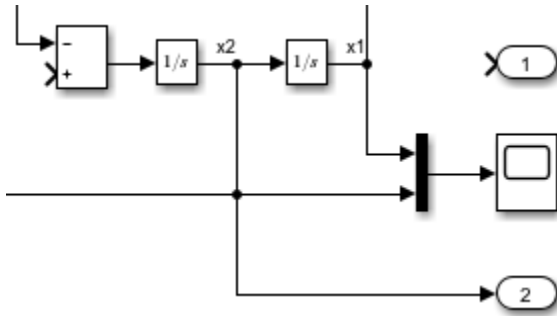

Delete the line segment from `x2` to the Mux.

```
delete_line('vdp','x2/1','Mux/2')
```

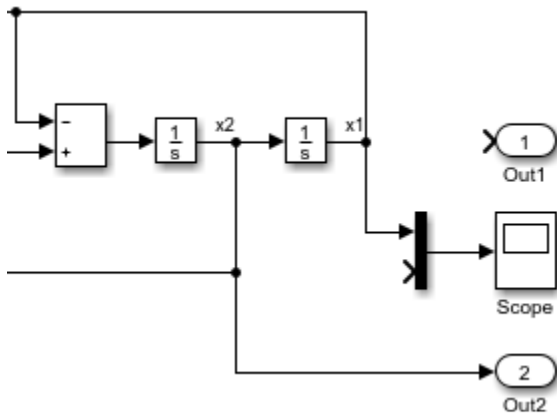

Delete the line segment from x2 to the Product block.

```
delete_line('vdp', 'x2/1', 'Product/2')
```

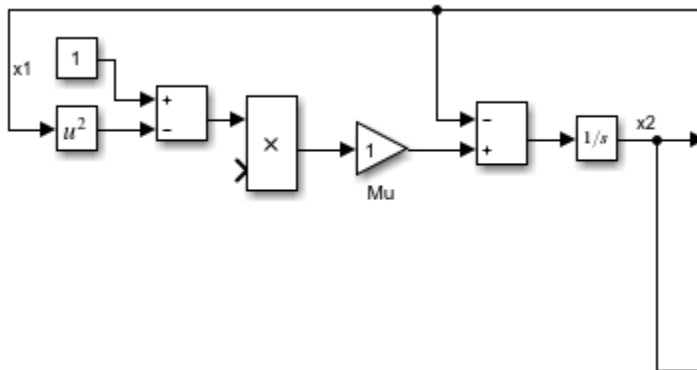

Input Arguments

sys — Model or subsystem to delete line from
 character vector

Model or subsystem to delete the line from, specified as a character vector.

Example: 'vdp', 'f14/Controller'

out — Block output port to delete line from
 block/port name or number character vector | port handle

Block output port to delete line from, specified as either:

- The block name, a slash, and the port name or number. Most block ports are numbered from top to bottom or from left to right. For a state port, use the port name State instead of a port number.
- The port handle that you want to delete the line from.

Use 'PortHandles' with get_param to get the handles.

Example: 'Mu/1', 'Subsystem/2'

in — Block input port to delete line from

block/port name or number character vector | port handle

Block input port to delete line from, specified as either:

- The block name, a slash, and the port name or number. The port name on:
 - An enabled subsystem is Enable.
 - A triggered subsystem is Trigger.
 - If Action and Switch Case Action subsystems is Action.
- The port handle that you want to delete the line from.

Use 'PortHandles' with get_param to get handles.

Example: 'Mu/1', 'Subsystem/2'

point — Point on the line you want to delete

1-by-2 matrix

Point that falls on the line you want to delete, specified as a 1-by-2 matrix.

Example: [150 200]

lineHandle — Handle of the line you want to delete

handle

Handle of the line you want to delete. You can get the line handle by using get_param with the 'LineHandles' option or by assigning the line to a handle when you create it programmatically.

See Also

add_line | get_param

Introduced before R2006a

delete_param

Delete system parameter added with add_param function

Syntax

```
delete_param(sys,param1,...,paramN)
```

Description

delete_param(sys,param1,...,paramN) deletes parameters that were added to the system using the add_param function. If a specified parameter was not added with the add_param function, you receive an error.

Examples

Delete Added Parameter

Add parameters to a system, then delete one of the parameters from the system.

Load the vdp system.

```
load_system('vdp')
```

Add the DemoName and EquationOrder parameters to the vdp system.

```
add_param('vdp','DemoName','VanDerPolEquation','EquationOrder','2')
```

Delete the DemoName parameter from the vdp system.

```
delete_param('vdp','DemoName')
```

Input Arguments

sys — System name

character vector | string scalar

System name, specified as a character vector or string scalar.

Data Types: char | string

param1,...,paramN — One or more parameters to delete from system

character vector | string scalar

One or more parameters to delete from system, each specified as a character vector or string scalar.

Data Types: char | string

See Also

add_param

Introduced before R2006a

dependencies.fileDependencyAnalysis

Find model file dependencies

Syntax

```
files = dependencies.fileDependencyAnalysis('modelname')
[files,missing] = dependencies.fileDependencyAnalysis('modelname')
[files,missing,depfile] = dependencies.fileDependencyAnalysis('modelname')
[files,missing,depfile,manifestfile] = dependencies.fileDependencyAnalysis('modelname','manifestfile')
```

Description

`files = dependencies.fileDependencyAnalysis('modelname')` returns the full paths of all existing files referenced by the model `modelname`.

`[files,missing] = dependencies.fileDependencyAnalysis('modelname')` also returns `missing`, any referenced files that cannot be found.

`[files,missing,depfile] = dependencies.fileDependencyAnalysis('modelname')` also returns `depfile`, the full path of the user dependencies (.smd) file, if it exists, that stores the names of any files the user manually added or excluded.

`[files,missing,depfile,manifestfile] = dependencies.fileDependencyAnalysis('modelname','manifestfile')` also creates a manifest file specified in `manifestfile`.

Examples

Find Model File Dependencies

Programmatically find all the file dependencies of the model `sldemo_mdref_depgraph`.

```
files = dependencies.fileDependencyAnalysis('sldemo_mdref_depgraph')
```

```
files = 7x1 cell
    {'C:\TEMP\Bdoc21b_1757077_3096\ib2EDA31\21\tp30def87b\simulink-ex05898741\sldemo_mdref_F2C.
    {'C:\TEMP\Bdoc21b_1757077_3096\ib2EDA31\21\tp30def87b\simulink-ex05898741\sldemo_mdref_depgraph
    {'C:\TEMP\Bdoc21b_1757077_3096\ib2EDA31\21\tp30def87b\simulink-ex05898741\sldemo_mdref_heate
    {'C:\TEMP\Bdoc21b_1757077_3096\ib2EDA31\21\tp30def87b\simulink-ex05898741\sldemo_mdref_heate
    {'C:\TEMP\Bdoc21b_1757077_3096\ib2EDA31\21\tp30def87b\simulink-ex05898741\sldemo_mdref_hous
    {'C:\TEMP\Bdoc21b_1757077_3096\ib2EDA31\21\tp30def87b\simulink-ex05898741\sldemo_mdref_outd
    {'C:\TEMP\Bdoc21b_1757077_3096\ib2EDA31\21\tp30def87b\simulink-ex05898741\sldemo_mdref_therm
```

Input Arguments

modelname — Model, library, or subsystem name or path

character vector | string

Full name or path of a model, library, or subsystem to analyze, specified as a character vector or string.

Data Types: `char` | `string`

manifestfile — Manifest file name or path

character vector | string

(Optional) Full name or path of the manifest file to create, specified as a character vector or string. The function adds the suffix `.smf` to the user-specified name.

Data Types: `char` | `string`

Output Arguments

files — Full paths of referenced files

character vector | cell array of character vectors

Full paths of all existing files referenced by the model or library `modelName`, returned as a character vector or a cell array of character vectors.

missing — Full paths of missing files

character vector | cell array of character vectors

Full paths of files referenced by the model or library `modelName` that cannot be found, returned as a character vector or a cell array of character vectors.

depfile — Full path of user dependencies file

character vector

Full path of user dependencies (`.smd`) file, if it exists, that stores the names of any files the user manually added or excluded, returned as a character vector.

manifestfile — Full path of created manifest file

character vector

Full path of new manifest (`.smf`) file, returned as a character vector.

Tips

- Interactively generate a dependency graph and a report summarizing the list of required files and products. For more details, see “Analyze Model Dependencies”.
- If your model is in a project, use `listRequiredFiles` instead.
- To programmatically check which add-ons are required, use `dependencies.toolboxDependencyAnalysis` instead.

Compatibility Considerations

Output arguments `manifestfile` and `depfile` will be removed

Not recommended starting in R2020b

Output arguments `manifestfile` and `depfile` will be removed in a future release.

Starting in R2020b, you can only generate the manifest file programmatically. You can open manifest files created prior to R2020b using the Dependency Analyzer. To interactively generate a dependency graph and report, perform a dependency analysis. For more details, see “Analyze Model Dependencies”.

Starting in R2020b, you can no longer generate a user dependencies file (.smd file). The function only returns a .smd file if it already exists. To manually add or exclude dependencies, create a project from your model. For more details, see “Create a Project from a Model” and “Add Files to the Project”.

See Also

`listRequiredFiles` | `listImpactedFiles` | `dependencies.toolboxDependencyAnalysis`

Topics

“What Is Dependency Analysis?”

Introduced in R2012a

dependencies.toolboxDependencyAnalysis

Find add-on dependencies

Syntax

```
names = dependencies.toolboxDependencyAnalysis(files)
[names, folders] = dependencies.toolboxDependencyAnalysis(files)
```

Description

`names = dependencies.toolboxDependencyAnalysis(files)` returns `names`, a cell array of the add-on names required by the files in `files`.

`[names, folders] = dependencies.toolboxDependencyAnalysis(files)` also returns `folders`, a cell array of the add-on folders.

Examples

Find Required Add-Ons

Find all the required add-ons for the model `vdp`.

```
files={'vdp'};
names = dependencies.toolboxDependencyAnalysis(files)

names =

    1x1 cell array

    {'Simulink'}
```

Tip You can interactively run a dependency analysis. You can find the required add-ons for the entire project, for selected files, or for a model. You can see which products a new team member requires to use the design, or find which file is introducing a product dependency. See “Find Required Products and Add-Ons”.

To programmatically check which files are required, see `dependencies.fileDependencyAnalysis`.

To view long product names, examine the `names` cell array as follows:

```
names{:}

ans =

    'Simulink'
```

Find Names and Folders of Required Add-Ons

Find the names and folders of the required add-ons for the model vdp.

```
files={'vdp'};
[names, folders] = dependencies.toolboxDependencyAnalysis(files)

names =

    1×1 cell array

    {'Simulink'}

folders =

    1×1 cell array

    {'simulink'}
```

Input Arguments

files — Files names or paths

" " (default) | cell array of strings

Names of files on the MATLAB path or full paths to files, specified as a cell array of strings.

Output Arguments

names — Add-on names

cell array of character vectors

Add-on names required by the files in `files`, returned as a cell array of character vectors.

folders — Add-on folders

cell array of character vectors

(Optional) Required add-on folders, returned as a cell array of character vectors.

See Also

`dependencies.fileDependencyAnalysis`

Topics

"Dependency Analysis"

"What Is Dependency Analysis?"

Introduced in R2012a

depview

Analyze and visualize model referencing dependencies with or without library dependencies

Syntax

```
depview(sys)
depview(sys,Name,Value)
```

Description

depview opens the Dependency Analyzer. While `view_mdrefs` also opens the Dependency Analyzer, `depview` provides programmatic options that allow you to open a specific configuration of the dependency graph.

`depview(sys)` opens the Dependency Analyzer and displays a graph of dependencies for the model or library specified by `sys`.

`depview(sys,Name,Value)` opens the Dependency Analyzer and displays a graph of dependencies as specified by one or more `Name,Value` pair arguments.

Examples

Open Dependency Analyzer with Default Settings

Open the Dependency Analyzer for the `sldemo_mdref_depgraph` model.

```
depview('sldemo_mdref_depgraph');
```

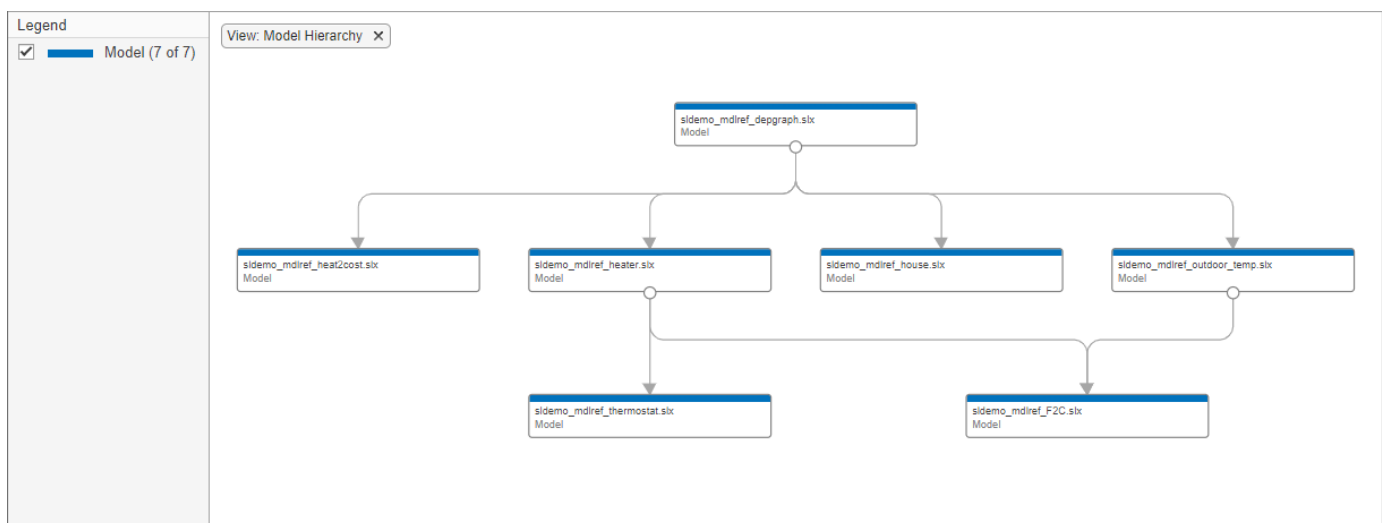

Open Dependency Analyzer with Custom Settings

Open the Dependency Analyzer for the `sldemo_mdhref_depgraph` model in **Model Instances** view with a **Horizontal** layout.

```
depview('sldemo_mdhref_depgraph', 'ModelReferenceInstance', true, 'ShowHorizontal', true);
```

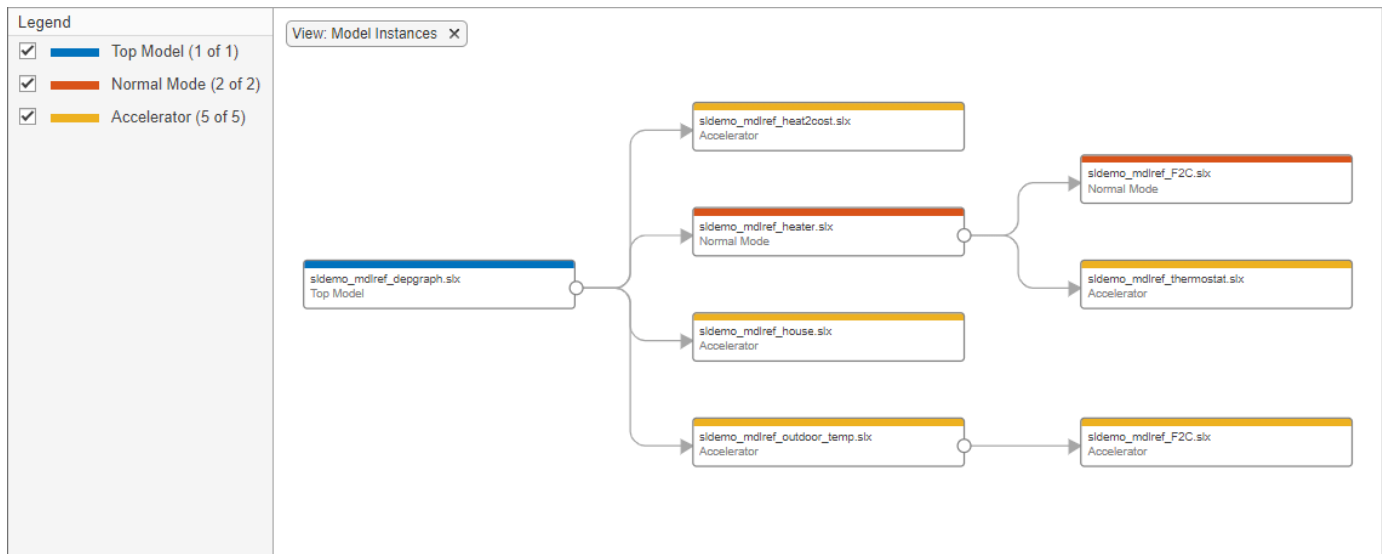

In **Model Instances** view, node appearance corresponds to simulation mode.

Input Arguments

`sys` — Name or path of model or library

' ' (default) | character vector

Name or path of model or library, specified as a character vector.

Data Types: `char`

Name-Value Pair Arguments

Specify optional comma-separated pairs of `Name`, `Value` arguments. `Name` is the argument name and `Value` is the corresponding value. `Name` must appear inside quotes. You can specify two name and value pair arguments in any order as `Name1`, `Value1`, `Name2`, `Value2`.

Example:

```
depview('sldemo_mdhref_depgraph', 'ModelReferenceInstance', true, 'ShowHorizontal', true)
```

`FileDependenciesExcludingLibraries` — Graph with only models

false (default) | true

To open the dependency graph with only models, set this parameter to `true`. In this view, node appearance corresponds to file type.

Dependencies

You can only set one of 'FileDependenciesExcludingLibraries', 'FileDependenciesIncludingLibraries', and 'ModelReferenceInstance' to true.

FileDependenciesIncludingLibraries — Graph with models and user-defined libraries

true (default) | false

To open the dependency graph with models and user-defined libraries, use the default setting. In this view, node appearance corresponds to file type.

Dependencies

You can only set one of 'FileDependenciesExcludingLibraries', 'FileDependenciesIncludingLibraries', and 'ModelReferenceInstance' to true.

ModelReferenceInstance — Graph with only models that shows each model instance separately

false (default) | true

To open the dependency graph with each instance of a model as a separate node in the graph, set this parameter to true. In this view, node appearance corresponds to simulation mode.

Dependencies

You can only set one of 'FileDependenciesExcludingLibraries', 'FileDependenciesIncludingLibraries', and 'ModelReferenceInstance' to true.

ShowHorizontal — Horizontal dependency display

false (default) | true

To open the dependency graph with referenced models and libraries to the right of their parents, set this parameter to true. By default, the Dependency Analyzer shows referenced models and libraries below their parents.

See Also

Blocks

Model

Functions

find_mdrefs

Topics

“Model Reference Basics”

“Analyze Model Dependencies”

Introduced in R2006b

detachConfigSet

Dissociate configuration set or configuration reference from model

Syntax

```
configObj = detachConfigSet(model, configObjName)
```

Description

`configObj = detachConfigSet(model, configObjName)` dissociates the configuration set or configuration reference with the name `configObjName` from the model. The function returns the detached configuration as a `Simulink.ConfigSet` object or a `Simulink.ConfigSetRef` object. You cannot detach the active configuration from a model. When you want to detach the active configuration, first activate a different configuration for the model.

Examples

Detach Configuration Set From Model

Create, attach, and activate a configuration set for a model. Then, detach the default configuration set from the model.

Open the model `sldemo_fuelsys`. Create a configuration set named 'MyConfig' and attach it to the model.

```
sldemo_fuelsys
configObj = Simulink.ConfigSet;
set_param(configObj, 'Name', 'MyConfig')
attachConfigSet('sldemo_fuelsys', configObj)
```

The active configuration for `sldemo_fuelsys` is the default configuration set, `Configuration`. To detach `Configuration`, activate another configuration for the model. For this example, set `MyConfig` as the active configuration set for `sldemo_fuelsys`.

```
setActiveConfigSet('sldemo_fuelsys', 'MyConfig')
```

Detach the default configuration set `Configuration` from the model.

```
detachConfigSet('sldemo_fuelsys', 'Configuration');
```

Input Arguments

model — Model from which to detach configuration set

character vector | string scalar

Model from which to disassociate a configuration set, specified as a character vector or string scalar. The model must be open.

Example: 'my_model'

configObjName — Configuration object name

character vector | string scalar

Name of the configuration object to detach from the model, specified as a character vector or string scalar.

Example: 'Configuration'

See Also

setActiveConfigSet | attachConfigSet | attachConfigSetCopy

Topics

“Manage Configuration Sets for a Model”

Introduced in R2006a

disableimplicitsignalresolution

Convert model to use only explicit signal resolution

Syntax

```
retVal = disableimplicitsignalresolution('model')  
retVal = disableimplicitsignalresolution('model', displayOnly)
```

Description

`retVal = disableimplicitsignalresolution('model')` inputs a model, reports all signals and states that implicitly resolve to signal objects, and converts the model to resolve only signals and states that explicitly require it. The report and any changes are limited to the model itself; they do not include blocks that are library links.

Before executing this function, ensure that all relevant Simulink data objects are defined in the base workspace or a data dictionary to which the model is linked. The function ignores any data objects that are defined elsewhere.

The function scans *model*, returns a structure of handles to signals and states that resolve implicitly to signal objects, and performs the following operations on *model*:

- Search the model for all output ports and block states that resolve to Simulink signal objects.
- Modify these ports and blocks to enforce signal object resolution in the future.
- Set the model's `SignalResolutionControl` parameter to 'UseLocalSettings' (GUI: **Explicit Only**).

If `SignalResolutionControl` is already set to 'UseLocalSettings' or to 'None', the function takes no action and returns a warning.

- If any Stateflow output data resolves to a Simulink signal object:
 - Turn off hierarchical scoping of signal objects from within the Stateflow chart.
 - Explicitly label the output signal of the Stateflow chart.
 - Enforce signal object resolution for this signal in the future.

Any changes made by `disableimplicitsignalresolution` permanently change the model. Be sure to back up the model before calling the function with `displayOnly` defaulted to or specified as `false`.

`retVal = disableimplicitsignalresolution('model', displayOnly)` is equivalent to `disableimplicitsignalresolution(model)` if `displayOnly` is `false`.

If `displayOnly` is `true`, the function returns a structure of handles to signals and states that resolve implicitly to signal objects, but leaves the model unchanged.

Input Arguments

displayOnly

Boolean specifying whether to change the model.

- `false` — Changes the model.
- `true` — The function returns a structure of handles to signals and states that resolve implicitly to signal objects, but leaves the model unchanged.

Default: `false`

model

Model name or handle

Output Arguments

retVal

A MATLAB structure containing:

| | |
|---------|---|
| Signals | Handles to ports with signal names that resolve to signal objects |
| States | Handles to blocks with states that resolve to signal objects |

See Also

`Simulink.Signal`

Topics

“Model Configuration Parameters: Data Validity Diagnostics”

“Symbol Resolution”

Introduced in R2007a

docblock

Get or set editor invoked by Simulink DocBlock block

Syntax

```
docblock(setEditorType,command)
```

```
editCommand = docblock(getEditorType)
```

Description

`docblock(setEditorType,command)` uses the specified command to set the editor opened by double-clicking a DocBlock block.

By default, a DocBlock block opens Microsoft Word to edit HTML or RTF files. If Word is not available on your system, the block opens these file types using the text editor specified on the **Editor/Debugger Preferences** pane of the MATLAB Preferences dialog box. For text files, the default editor is the text editor specified in the MATLAB preferences.

The editor specifications persist between MATLAB sessions.

`editCommand = docblock(getEditorType)` returns the current command to open the specified editor from a DocBlock block.

Examples

Set DocBlock Text Editor

Specify Notepad as the DocBlock editor for text files.

```
docblock('setEditorTXT','system(''notepad "%<FileName>"'');')
```

Set and Get Current HTML Editor

You can use the `docblock` command to get the current editor.

Set your HTML editor for the DocBlock block to Mozilla Composer. The ampersand executes the command in the background.

```
docblock('setEditorHTML',...  
         'system('/usr/local/bin/mozilla -edit "%<FileName>" &'');')
```

Get the current HTML editor.

```
htmlEd = docblock('getEditorHTML')
```



```
htmlEd =
    'system('/usr/local/bin/mozilla -edit "%<FileName>" &');'
```

Reset Text Editor to Default

Specify Notepad as the DocBlock editor for text files.

```
docblock('setEditorTXT','system('notepad "%<FileName>"');')
```

Get the current text editor.

```
txtEd = docblock('getEditorTXT')
txtEd =
    'system('notepad "%<FileName>"');
```

Reset the editor to the default editor.

```
docblock('setEditorTXT','')
```

Input Arguments

setEditorType — File type for which to set editor command

```
'setEditorHTML' | 'setEditorDOC' | 'setEditorTXT'
```

File type for which to set editor command, specified as 'setEditorHTML', 'setEditorDOC', or 'setEditorTXT'.

command — Command to open file type in editor

```
character vector | ''
```

Command to open file type in editor from the MATLAB Command Window, specified as a character vector. Use '' to reset to the default editor for that file type.

In the command, use the "%<FileName>" token to represent the full pathname to the document.

getEditorType — File type of editor command to return

```
'getEditorHTML' | 'getEditorDOC' | 'getEditorTXT'
```

File type of editor command to return, specified as 'getEditorHTML', 'getEditorDOC', or 'getEditorTXT'.

Output Arguments

editCommand — Command to open editor

```
character vector
```

Command to open editor, returned as a character vector.

Compatibility Considerations

Editor specification does not persist between previous releases and R2021b or later
Behavior changed in R2021b

If you used `docblock` to specify the editors that a DocBlock block uses for HTML, RTF, or text documents before R2021b, you must specify the editors again in R2021b or a later release. Otherwise, a DocBlock block uses the default editor for the document type.

See Also

DocBlock

Topics

“Use a Simulink DocBlock to Add a Comment” (Embedded Coder)

Introduced in R2007a

edittime.getDisplayIssues

Check whether model design warnings and errors is on

Syntax

```
val= edittime.getDisplayIssue
```

Description

Use the `val= edittime.getDisplayIssue` function to check whether model design errors and warnings is on.

Examples

Enable model design errors and warnings via the command-line

By default, model design errors and warnings are visible while you edit a model. You can turn them off by entering this command at the MATLAB command line.

```
edittime.setDisplayIssues('off')
```

You can turn them on by entering this command at the MATLAB command line.

```
edittime.setDisplayIssues('on')
```

You can check whether they are on by entering this command at the MATLAB command line.

```
val=edittime.getDisplayIssues
```

Output Arguments

val — Returns on or off

char

If edit-time checking is on, this function returns on. If edit-time checking is off, this function returns off.

See Also

`edittime.setDisplayIssues` | **Simulink Editor**

Introduced in R2019a

edittime.setDisplayIssues

Detect model design errors and warnings

Syntax

```
edittime.setDisplayIssues(value)
```

Description

`edittime.setDisplayIssues(value)` function sets whether to display model design errors and warnings while you design your model. This function is equivalent to selecting **Diagnostics > Edit-Time Errors & Warnings**. This setting persists for all models.

Examples

Enable model design errors and warnings through the command-line

By default, model design errors and warnings are visible while you edit a model. You can turn them off. At the MATLAB command line, enter:

```
edittime.setDisplayIssues('off')
```

To turn on errors and warnings, at the MATLAB command line, enter:

```
edittime.setDisplayIssues('on')
```

Input Arguments

value — Enable model design warning and error detection

character vector

To enable warnings and errors while you edit your model, set value to `on`. To disable warnings and errors while you edit, set value to `off`.

Data Types: `char`

See Also

`edittime.getDisplayIssues` | **Simulink Editor**

Introduced in R2019a

find_mdrefs

Find referenced models and Model blocks in model hierarchy

Syntax

```
[models,blocks] = find_mdrefs(system)
[models,blocks] = find_mdrefs(system,Name,Value)
```

Description

`[models,blocks] = find_mdrefs(system)` finds all referenced models and Model blocks in the model hierarchy below the specified system. The `find_mdrefs` function temporarily loads the models.

`[models,blocks] = find_mdrefs(system,Name,Value)` provides additional search options using one or more name-value pairs. For example, to keep the models loaded instead of temporarily loading them, set `KeepModelsLoaded` to `true`.

Examples

Find Referenced Models in Model Hierarchy

Find referenced models and Model blocks for all models referenced by the specified model.

```
load_system('sldemo_mdref_basic');
[myModels,myModelBlks] = find_mdrefs('sldemo_mdref_basic')

myModels = 2x1 cell
    {'sldemo_mdref_counter'}
    {'sldemo_mdref_basic' }

myModelBlks = 3x1 cell
    {'sldemo_mdref_basic/CounterA'}
    {'sldemo_mdref_basic/CounterB'}
    {'sldemo_mdref_basic/CounterC'}
```

Find and Load All Models in Model Hierarchy

By default, the `find_mdrefs` function loads and then closes the models that were not already loaded. To identify what models are loaded, use the `find_system` function.

```
find_mdrefs('sldemo_mdref_depgraph');
find_system('type','block_diagram')

ans =

    0x1 empty cell array
```

To find and load all models in the model hierarchy, set `KeepModelsLoaded` to `true`.

```
find_mdrefs('sldemo_mdhref_depgraph', 'KeepModelsLoaded', true);
find_system('type', 'block_diagram')

ans = 7x1 cell
    {'sldemo_mdhref_thermostat' }
    {'sldemo_mdhref_heater'     }
    {'sldemo_mdhref_F2C'       }
    {'sldemo_mdhref_outdoor_temp'}
    {'sldemo_mdhref_house'     }
    {'sldemo_mdhref_heat2cost' }
    {'sldemo_mdhref_depgraph'  }
```

The top model and all referenced models remain loaded. If you open `sldemo_mdhref_depgraph`, you can navigate the model hierarchy without waiting for the referenced models to load as you open them.

Input Arguments

system — System name, block path, or handle

character vector | string scalar | numeric scalar

System name, block path, or handle, specified as a character vector, string scalar, or numeric scalar.

The system must be an SLX file, MDL file, Model block, or Subsystem block.

If you specify a file name, do not include the file extension.

Data Types: double | char | string

Name-Value Pair Arguments

Specify optional comma-separated pairs of `Name`, `Value` arguments. `Name` is the argument name and `Value` is the corresponding value. `Name` must appear inside quotes. You can specify several name and value pair arguments in any order as `Name1, Value1, ..., NameN, ValueN`.

Example: `refModels = find_mdrefs(topmodel, 'KeepModelsLoaded', true, 'ReturnTopModelAsLastElement', false)`

KeepModelsLoaded — Option to keep models loaded

false or 0 (default) | true or 1

Option to keep models loaded, specified as the comma-separated pair consisting of `'KeepModelsLoaded'` and a numeric or logical 1 (`true`) or 0 (`false`).

By default the function loads and then closes the models that were not already loaded. To keep the models loaded, set this argument to `true`. Keeping the models loaded can be useful if you plan on interacting with the models after finding them.

Data Types: logical

AllLevels — Levels to search

true or 1 (default) | false or 0

Levels to search, specified as the comma-separated pair consisting of 'AllLevels' and a numeric or logical 1 (true) or 0 (false).

- `true` — Search all Model blocks in the model hierarchy of the specified system.
- `false` — Search only the top-level system.

Data Types: `logical`

IncludeProtectedModels — Option to include protected models

`false` or 0 (default) | `true` or 1

Option to include protected models in the search results, specified as the comma-separated pair consisting of 'IncludeProtectedModels' and a numeric or logical 1 (true) or 0 (false).

This setting only affects the returned list of referenced models; It does not affect the returned list of Model blocks.

Data Types: `logical`

IncludeCommented — Option to include commented blocks

`false` or 0 (default) | `true` or 1

Option to include commented blocks in the search results, specified as the comma-separated pair consisting of 'IncludeCommented' and a numeric or logical 1 (true) or 0 (false).

Data Types: `logical`

CaseSensitive — Option to match case when searching

`true` (default) | `false`

Option to match case when searching, specified as `true` for case-sensitive search or `false` for case-insensitive search.

Data Types: `logical`

FollowLinks — Option for search to follow library links

`false` (default) | `true`

Option for the search to follow library links, specified as `true` or `false`. If `true`, search follows links into library blocks.

Data Types: `logical`

LookUnderMasks — Options to search masked blocks

'all' (default) | 'none' | 'functional' | 'graphical'

Options to search masked blocks, specified as:

- 'all' — Search in all masked blocks.
- 'none' — Prevent searching in masked systems.
- 'functional' — Include masked subsystems that do not have dialogs.
- 'graphical' — Include masked subsystems that do not have workspaces or dialogs.

Data Types: `char` | `string`

MatchFilter — Function handle that determines whether to include or skip elements in search

function handle

Function handle to match elements in a search, such as blocks, system, lines, ports, and annotations. Use `MatchFilter` to determine whether elements should be included or skipped in the search.

The named function must be defined within a MATLAB program file. The function takes the handle of the element as input and returns two outputs.

```
function [match, prune] = func(element)
```

- The input `element` is the handle of the block being processed.
- The first output, `match`, is a logical value. If `false`, search skips the element.
- The second output, `prune`, is an optional logical value that only applies when `element` is a subsystem. The default value is `false`. If this value is set to `true`, the entire subsystem is omitted from the search.

For example, use `MatchFilter` to find all `Model` blocks in a model for which the `InitFcn` callback is defined using the filter function, `initFcnMdlBlocks`:

```
function match = initFcnMdlBlocks(handle)
    match = ~isempty(get_param(handle, 'InitFcn'));
end

addpath(fullfile(matlabroot, 'examples', 'simulink_variants', 'main'));
model='slexVariantMdlRefCondProp';
load_system(model);
[models,blocks] = find_mdrefs(model, 'MatchFilter', @initFcnMdlBlocks)
```

Variants: To find active variants or code compile variant blocks, compile the model and apply the appropriate match filter function that Simulink provides.

- `Simulink.match.activeVariants` — Match blocks that are active in simulation after model compilation.
- `Simulink.match.codeCompileVariants` — Match blocks that are part of generated code after model compilation.

For example, use the `Simulink.match.activeVariants` option to find active variants in a model.

```
addpath(fullfile(matlabroot, 'examples', 'simulink_variants', 'main'));
model='slexVariantMdlRefCondProp';
load_system(model);
set_param(model, 'SimulationCommand', 'update');
[models,blocks] = find_mdrefs(model, 'MatchFilter', @Simulink.match.activeVariants);
```

For example, use the `Simulink.match.codeCompileVariants` option to find variant choices that are part of the generated C code.

```
addpath(fullfile(matlabroot, 'examples', 'simulink_variants', 'main'));
load_system('slexVariantMdlRefCondProp');
assignin('base', 'VSS_MODE', 2);
slexVariantMdlRefCondProp([], [], [], 'compileForCodegen');
[models,blocks] = find_mdrefs('slexVariantMdlRefCondProp', ...
    'MatchFilter', @Simulink.match.codeCompileVariants);
slexVariantMdlRefCondProp([], [], [], 'term');
```

Variants — Option to include variant models

'ActivePlusCodeVariants' (default) | 'ActiveVariants' | 'AllVariants'

Note The `Variants` argument will be removed. Use `MatchFilter` instead. For more information, see “Compatibility Considerations” on page 2-231.

Option to include variant models in the search results, specified as the comma-separated pair consisting of 'Variants' and 'ActivePlusCodeVariants', 'ActiveVariants', or 'AllVariants'.

- 'ActivePlusCodeVariants' — Include all variant models in the Variant Subsystem that are active in simulation and is part of the generated code.
- 'ActiveVariants' — Include the active variant models in the Variant Subsystem block.
- 'AllVariants' — Include all variant models in the Variant Subsystem block.

This search constraint applies only to Variant Subsystem blocks that have the **Variant control mode** set to `expression` or `label`. Use the `find_mdhrefs` function with the `MatchFilter` option to operate on all types of variant blocks.

Data Types: `char` | `string`

ReturnTopModelAsLastElement — Option to include specified system

`true` or `1` (default) | `false` or `0`

Option to include the specified system in the search results, specified as the comma-separated pair consisting of 'ReturnTopModelAsLastElement' and a numeric or logical `1` (`true`) or `0` (`false`).

By default, the last element in the returned list of referenced models is the name of the model, library, or subsystem file that you specified with the `system` argument. If you specify a block, the last element is the name of the file that contains it.

Data Types: `logical`

Output Arguments

models — Names of models

cell array of character vectors

Names of models, returned as a cell array of character vectors.

By default, the last element is the name of the model, library, or subsystem file that you specified with the `system` argument. If you specify a block, the last element is the model, library, or subsystem file that contains it.

blocks — Names of Model blocks

cell array of character vectors

Names of Model blocks, returned as a cell array of character vectors.

Compatibility Considerations

Variants argument will be removed

Warns starting in R2021a

The `Variants` option will be removed from `find_mdhrefs` in a future release. Scripts that use the `Variants` option continue to work with a warning.

To find Model blocks that are active during simulation or code generation, compile the model and use the `find_mdhrefs` function with the `MatchFilter` option.

Default behavior has changed for `find_mdhrefs` with `Variants` and `MatchFilter` options in a model with variant blocks

Behavior changed in R2021a

- **Variants:** Using the `find_mdhrefs` function *without* the `Variants` option includes only the Model blocks that are active during simulation or code generation in the search by default.

Consider a model with a Variant Model block that has two variant choices, `Mdl_Linear_Controller` and `Mdl_NonLinear_Controller`.

This command returns only the active Model blocks in the model.

```
[myModels,myModelBlks] = find_mdhrefs...
('sldemo_variant_subsystems_modelblocks')
```

```
myModels =
```

```
2x1 cell array
```

```
    {'mdlref_nonlinear_controller'      }
    {'sldemo_variant_subsystems_modelblocks'}
```

```
myModelBlks =
```

```
1x1 cell array
```

```
    {'sldemo_variant_subsystems_modelblocks/Controller/Mdl_NonLinear_Controller'}
```

- **MatchFilter:** Using the `find_mdhrefs` function with the `MatchFilter` option applies the filters on the active and inactive variant choices by default.

Consider a model with a Variant Model block that has two variant choices, `Mdl_Linear_Controller` and `Mdl_NonLinear_Controller`. The filter function `initFcnMdlBlocks` finds all the Model blocks for which the `InitFcn` callback is set.

```
function match = initFcnMdlBlocks(handle)
match = ~isempty(get_param(handle, 'InitFcn'));
end
```

This command returns both the active and inactive Model blocks in the model.

```
[myModels,myModelBlks] = find_mdhrefs('sldemo_variant_subsystems_modelblocks',...
'MatchFilter', @initFcnMdlBlocks)
```

```
myModels =
```

```
3x1 cell array
```

```
    {'mdlref_linear_controller'      }
    {'mdlref_nonlinear_controller'   }
    {'sldemo_variant_subsystems_modelblocks'}
```

```
myModelBlks =
```

```
2x1 cell array
```

```
    {'sldemo_variant_subsystems_modelblocks/Controller/Mdl_Linear_Controller'   }
    {'sldemo_variant_subsystems_modelblocks/Controller/Mdl_NonLinear_Controller'}
```

- `find_mdrefs` does not support the use of `MatchFilter` along with the `Variants` option.

This command produces an error:

```
find_mdrefs(bdroot, 'MatchFilter', @Simulink.match.activeVariants, ...  
            'Variants', 'ActiveVariants');
```

Specifying a logical value as the second argument of `find_mdrefs` is discouraged

Not recommended starting in R2020b

The `find_mdrefs` function provides two ways to specify whether to search all levels of the model hierarchy. Both techniques give the same results, but only the name-value pair technique allows you to specify additional options.

Instead of specifying whether to search all levels of the model hierarchy with a logical as the second argument, use the `AllLevels` name-value pair.

See Also

Blocks

Model

Functions

`find_system`

Topics

“Model Reference Basics”

“Inspect Model Hierarchies”

Introduced before R2006a

find_system

Find systems, blocks, lines, ports, and annotations

Syntax

```
Objects = find_system
Objects = find_system(System)
Objects = find_system(Name,Value)
Objects = find_system(System,Name,Value)
```

Description

`Objects = find_system` returns loaded systems and their blocks, including subsystems.

`Objects = find_system(System)` returns the specified system and its blocks.

`Objects = find_system(Name,Value)` returns loaded systems and the objects in those systems that meet the criteria specified by one or more `Name, Value` pair arguments. You can use this syntax to specify search constraints and to search for specific parameter values. Specify the search constraints before the parameter and value pairs.

`Objects = find_system(System,Name,Value)` returns the objects in the specified system that meet the specified criteria.

Examples

Find Loaded Systems and Their Blocks

Return the names of all loaded systems and their blocks.

```
load_system('vdp')
find_system

ans = 15x1 cell
    {'vdp' }
    {'vdp/Constant' }
    {'vdp/More Info' }
    {'vdp/More Info/Model Info'}
    {'vdp/Mu' }
    {'vdp/Mux' }
    {'vdp/Product' }
    {'vdp/Scope' }
    {'vdp/Square' }
    {'vdp/Sum' }
    {'vdp/Sum1' }
    {'vdp/x1' }
    {'vdp/x2' }
    {'vdp/Out1' }
    {'vdp/Out2' }
```

Returns loaded systems and libraries, including vdp.

Find Specific System and Its Blocks

Return vdp system and its blocks.

```
load_system({'vdp','ex_sl-demo-clutch'})
find_system('vdp')
```

```
ans = 15x1 cell
    {'vdp' }
    {'vdp/Constant' }
    {'vdp/More Info' }
    {'vdp/More Info/Model Info' }
    {'vdp/Mu' }
    {'vdp/Mux' }
    {'vdp/Product' }
    {'vdp/Scope' }
    {'vdp/Square' }
    {'vdp/Sum' }
    {'vdp/Sum1' }
    {'vdp/x1' }
    {'vdp/x2' }
    {'vdp/Out1' }
    {'vdp/Out2' }
```

Return Names of Loaded Models, Subsystems, and Libraries

Return the names of the loaded models, subsystems, and libraries. A subsystem name is returned only if the subsystem can be loaded independently.

```
load_system('vdp');
find_system('type','block-diagram')
```

```
ans = 1x1 cell array
    {'vdp'}
```

Search Children of Subsystem

Return the names of all Goto blocks that are children of the Unlocked subsystem in the ex_sl-demo-clutch system.

```
load_system('ex_sl-demo-clutch');
find_system('ex_sl-demo-clutch/Unlocked','SearchDepth',1,'BlockType','Goto')
```

```
ans = 2x1 cell
    {'ex_sl-demo-clutch/Unlocked/Goto' }
    {'ex_sl-demo-clutch/Unlocked/Goto1' }
```

Copyright 2020 The MathWorks, Inc.

Search Using Multiple Criteria

Search in the vdp system and return the names of all Gain blocks whose **Gain** value is set to 1.

```
load_system('vdp');
find_system('vdp','BlockType','Gain','Gain','1')

ans = 1x1 cell array
     {'vdp/Mu'}
```

Return Lines and Annotations as Handles

Get the handles of all lines and annotations in the vdp system. With 'FindAll', the function returns handles regardless of how you specify the system to search.

```
load_system('vdp');
L = find_system('vdp','FindAll','on','type','line')

L = 19x1

    34.0106
    33.0106
    32.0106
    31.0106
    30.0106
    29.0106
    28.0106
    27.0106
    26.0106
    25.0106
     :

A = find_system('vdp','FindAll','on','type','annotation')

A = 2x1

    36.0106
    35.0106
```

Search for Specific Block Parameter Value

Find any block dialog box parameters with a value of 0 in the vdp and ex_sl-demo_clutch systems.

```
load_system({'vdp','f14'})
find_system({'vdp','f14'},'BlockDialogParams','0')
```

```
ans =
    32x1 cell array

    {'vdp/More Info' }
    {'vdp/More Info/Model Info' }
    {'vdp/Scope' }
    {'vdp/x2' }
    {'vdp/Out1' }
    {'vdp/Out1' }
    {'vdp/Out2' }
    {'vdp/Out2' }
    {'f14/AircraftDynamicsModel' }
    {'f14/AircraftDynamicsModel/Vertical Velocity-w (ft//sec)'}
    {'f14/AircraftDynamicsModel/Vertical Velocity-w (ft//sec)'}
    {'f14/AircraftDynamicsModel/Pitch Rate-q (rad//sec)'}
    {'f14/AircraftDynamicsModel/Pitch Rate-q (rad//sec)'}
    .
    .
    .
```

Search Using Regular Expressions

Find all blocks in the top level of the currently loaded systems with a block dialog parameter value that starts with 3.

```
load_system({'ex_sl-demo-clutch','vdp'});
find_system('SearchDepth','1','regexp','on','BlockDialogParams','^3')
```

```
ans = 4x1 cell
    {'vdp/Scope' }
    {'vdp/Scope' }
    {'vdp/Square' }
    {'ex_sl-demo-clutch/w'}
```

Regular Expression Search for Partial Match

When you search using regular expressions, you can specify a part of the character vector you want to match to return all objects that contain that character vector. Find all the inport and outport blocks in the ex_sl-demo-clutch model.

```
load_system('ex_sl-demo-clutch');
find_system('ex_sl-demo-clutch','regexp','on','blocktype','port')
```

```
ans = 39x1 cell
    {'ex_sl-demo-clutch/Friction...' }
    {'ex_sl-demo-clutch/Friction...' }
    {'ex_sl-demo-clutch/Friction...' }
    {'ex_sl-demo-clutch/Friction Mode Logic/Tin' }
    {'ex_sl-demo-clutch/Friction Mode Logic/Tfmaxs' }
    {'ex_sl-demo-clutch/Friction Mode Logic/Break Apart...' }
    {'ex_sl-demo-clutch/Friction Mode Logic/Break Apart...' }
```

```

{'ex_sl-demo_clutch/Friction Mode Logic/Break Apart...'} }
{'ex_sl-demo_clutch/Friction Mode Logic/Lockup...'} }
{'ex_sl-demo_clutch/Friction Mode Logic/Lockup...'} }
{'ex_sl-demo_clutch/Friction Mode Logic/Lockup...'} }
{'ex_sl-demo_clutch/Friction Mode Logic/Lockup...'} }
{'ex_sl-demo_clutch/Friction Mode Logic/Lockup...'} }
{'ex_sl-demo_clutch/Friction Mode Logic/Lockup...'} }
{'ex_sl-demo_clutch/Friction Mode Logic/Lockup...'} }
{'ex_sl-demo_clutch/Friction Mode Logic/Lockup...'} }
{'ex_sl-demo_clutch/Friction Mode Logic/Lockup FSM/lock'} }
{'ex_sl-demo_clutch/Friction Mode Logic/Lockup FSM/unlock'} }
{'ex_sl-demo_clutch/Friction Mode Logic/Lockup FSM/locked'} }
{'ex_sl-demo_clutch/Friction Mode Logic/Requisite Friction/Tin'} }
{'ex_sl-demo_clutch/Friction Mode Logic/Requisite Friction/Tf'} }
{'ex_sl-demo_clutch/Friction Mode Logic/locked'} }
{'ex_sl-demo_clutch/Friction Mode Logic/lock'} }
{'ex_sl-demo_clutch/Friction Mode Logic/unlock'} }
{'ex_sl-demo_clutch/Friction Mode Logic/Tf'} }
{'ex_sl-demo_clutch/Locked/Tin'} }
{'ex_sl-demo_clutch/Locked/w'} }
{'ex_sl-demo_clutch/Unlocked/Tfmaxk'} }
{'ex_sl-demo_clutch/Unlocked/Tin'} }
{'ex_sl-demo_clutch/Unlocked/we'} }
:

```

Update Library Links in a Subsystem

In this example, `myModel` contains a single subsystem, which is a library link. After the model was last opened, a Gain block was added to the corresponding subsystem in the library.

Open the model. Use `find_system` with `'FollowLinks'` set to `'off'`. The command does not follow the library links into the subsystem and returns only the subsystem at the top level.

```

open_system('myModel')
find_system(bdroot,'LookUnderMasks','on','FollowLinks','off')

```

ans =

```

' myModel'
' myModel/Subsystem'

```

Use `find_system` with `'FollowLinks'` set to `'on'`. `find_system` updates the library links and returns the block in the subsystem.

```

find_system(bdroot,'LookUnderMasks','on','FollowLinks','on')

```

```

Updating Link: myModel/Subsystem/Gain
Updating Link: myModel/Subsystem/Gain

```

ans =

```

' myModel'

```



```
'myModel/Subsystem'
'myModel/Subsystem/Gain'
```

Return Values as Handles

Provide the system to `find_system` as a handle. Search for block dialog box parameters with a value of 0. If you make multiple calls to `get_param` for the same block, then using the block handle is more efficient than specifying the full block path as a character vector.

```
load_system('vdp');
sys = get_param('vdp','Handle');
find_system(sys,'BlockDialogParams','0')
```

```
ans = 8×1

    3.0109
    4.0109
    8.0109
   13.0109
   14.0109
   14.0109
   15.0109
   15.0109
```

Input Arguments

System — System to search

path name | cell array of path names | handle | vector of handles

System to search, specified as the full system path name, a cell array of system path names, a handle, or a vector of handles.

Example: 'MyModel/Subsystem1'

Example: {'vdp','ex_sl-demo_clutch'}

Name-Value Pair Arguments

Specify optional comma-separated pairs of `Name`, `Value` arguments. `Name` is the argument name and `Value` is the corresponding value. `Name` must appear inside quotes. You can specify several name and value pair arguments in any order as `Name1`, `Value1`, ..., `NameN`, `ValueN`.

When you use the `find_system` function, `Name`, `Value` pair arguments can include search constraints and parameter name and value pairs. You can specify search constraints in any order, but they must precede the parameter name and value pairs.

See “Block-Specific Parameters” on page 6-26 for the list of block parameters.

Example: 'SearchDepth','0','LookUnderMasks','none','BlockType','Goto' searches in loaded systems, excluding masked subsystems, for Goto blocks.

BlockDialogParams — Option to search block dialog box parameters for the specified value
character vector | string scalar

Option to search block dialog box parameters for the specified value, specified as the comma-separated pair consisting of 'BlockDialogParams' and a character vector or string scalar. This pair must follow the other search constraint pairs.

CaseSensitive – Option to consider case when matching

'on' (default) | 'off'

Option to consider case when matching, specified as the comma-separated pair consisting of 'CaseSensitive' and 'on' for case-sensitive searching or 'off'.

FindAll – Option to include lines, ports, and annotations within systems

'off' (default) | 'on'

Option to include lines, ports, and annotations in systems in the search, specified as the comma-separated pair consisting of 'FindAll' and 'on' or 'off'. When this option is set to 'on', `find_system` returns a vector of handles regardless of how you specify the `System` argument.

FirstResultOnly – Option to return only the first result

'off' (default) | 'on'

Option to return only the first result and then stop the search, specified as the comma-separated pair consisting of 'FirstResultOnly' and 'on' or 'off'.

LookInsideSubsystemReference – Option to look inside a referenced subsystem

'on' (default) | 'off'

Option to look inside a referenced subsystem in a model and list child blocks specified as the comma-separated pair consisting of 'LookInsideSubsystemReference' and 'on' or 'off'.

FollowLinks – Option to follow links into library blocks

'off' (default) | 'on'

Option to follow links into library blocks, specified as the comma-separated pair consisting of 'FollowLinks' and 'on' or 'off'. If you do not specify a system to search, `find_system` includes loaded libraries in the results, whether you set 'FollowLinks' to 'on' or 'off'. You can use 'FollowLinks' with 'LookUnderMasks' to update library links in subsystems. See “Update Library Links in a Subsystem” on page 2-238.

IncludeCommented – Option to include commented blocks

'off' (default) | 'on'

Option to include commented blocks in the search, specified as the comma-separated pair consisting of 'IncludeCommented' and 'on' or 'off'.

LoadFullyIfNeeded – Option to load any partially loaded models

'on' (default) | 'off'

Option to load any partially loaded models, specified as the comma-separated pair of 'LoadFullyIfNeeded' and 'on' to load models or 'off' to disable loading. Use this option, for example, to prevent load warnings.

LookUnderMasks – Options for searching under masks

'graphical' (default) | 'none' | 'functional' | 'all' | 'on' | 'off'

Options for searching under masks, specified as the comma-separated pair consisting of 'LookUnderMasks' and one of these options:

- 'graphical' — Search includes masked subsystems that have no workspaces and no dialogs.
- 'none' — Search skips masked subsystems.
- 'functional' — Search includes masked subsystems that do not have dialogs.
- 'all' — Search includes all masked subsystems.
- 'on' — Search includes all masked subsystems.
- 'off' — Search skips masked subsystem.

RegExp — Option to treat search expressions as regular expressions

'off' (default) | 'on'

Option to treat search expressions as regular expressions specified as the comma-separated pair consisting of 'RegExp' and 'on' to treat search expressions as regular expressions or 'off'. To learn more about MATLAB regular expressions, see “Regular Expressions”.

SearchDepth — Option to restrict the search depth

positive integer character vector or string scalar

Option to restrict the search depth to the specified level, specified as the comma-separated pair consisting of 'SearchDepth' and a positive integer character vector or string scalar. For example, specify '0' to search loaded systems only, '1' for blocks and subsystems of the top-level system, '2' for the top-level system and its children, etc. The default is to search all levels.

Variants — Options for searching variants

'ActiveVariants' (default) | 'AllVariants' | 'ActivePlusCodeVariants'

Note The Variants argument will be removed. Use MatchFilter instead. For more information, see “Compatibility Considerations” on page 2-243.

Options for searching variants, specified as the comma-separated pair consisting of 'Variants' and one of these options:

- 'ActiveVariants' — Search only the active variant choice in the Variant Subsystem.
- 'AllVariants' — Search all variant choices in the Variant Subsystem.
- 'ActivePlusCodeVariants' — Search all variant choices in the Variant Subsystem that are active in simulation and is part of the generated code.

This search constraint applies only to Variant Subsystem blocks that have the **Variant control mode** set to expression or label. Use the find_system function with the MatchFilter option to operate on all types of variant blocks.

MatchFilter — Function handle to match elements

function handle

Function handle to match elements in a search, such as blocks, system, lines, ports, and annotations. Use MatchFilter to determine whether elements should be included or skipped in a search.

The named function must be defined within a MATLAB program file. The function takes the handle of the element as input and returns two outputs.

```
function [match, prune] = func(element)
```

- The input `element` is the handle of the block being processed.
- The first output, `match`, is a logical value. If `false`, search skips the element.
- The second output, `prune`, is an optional logical value that only applies when `element` is a subsystem. The default value is `false`. If this value is set to `true`, the entire subsystem is omitted from the search.

Example: Use `MatchFilter` to find all non Inport and Outport blocks in a model using your own defined filter function, `nonInOutBlocks`.

```
function match = nonInOutBlocks(handle)
match = true;
if strcmp(get_param(handle, 'Type'), 'block')
    blockType = get_param(handle, 'BlockType');
    if strcmp(blockType, 'Inport') || ...
        strcmp(blockType, 'Outport')
        match = false;
    end
end
end

load_system('vdp');
blks = find_system('vdp', 'MatchFilter', @nonInOutBlocks)
```

Variants: Simulink provides these built-in match filter functions to find variant blocks that are active in simulation or part of the generated code.

- `Simulink.match.activeVariants` — Filter function to find blocks that are active in simulation after model compilation.
- `Simulink.match.codeCompileVariants` — Filter function to find blocks that are part of generated code after model compilation.

Example: Use the `Simulink.match.activeVariants` filter to find active variants in a model.

```
model='sldemo_variant_subsystems';
load_system(model);
assignin('base','VSS_MODE',2);
set_param(model, 'SimulationCommand', 'update');
activeBlks = find_system(model, 'MatchFilter', @Simulink.match.activeVariants);
```

Example: Use the `Simulink.match.codeCompileVariants` filter to find variant choices that are part of the generated C code.

```
load_system('sldemo_variant_subsystems');
assignin('base','VSS_MODE',2);
sldemo_variant_subsystems([], [], [], 'compileForCodegen');
activeBlks= find_system('sldemo_variant_subsystems', 'MatchFilter', @Simulink.match.codeCompileVariants);
sldemo_variant_subsystems([], [], [], 'term');
```

Output Arguments

Objects — Matching objects

cell array of path names | vector of handles

Matching objects found, returned as:

- A cell array of path names if you specified `System` as a path name or cell array of path names, or if you did not specify a system
- A vector of handles if you specified `System` as a handle or vector of handles

Compatibility Considerations

Variants argument will be removed

Warns starting in R2021a

The `Variants` option will be removed from `find_system` in a future release. Scripts that use the `Variants` option continue to work with a warning.

To find variant blocks in a model that are active during simulation or code generation, compile the model and use the `find_system` function with the `MatchFilter` option.

Default behavior has changed for find_system with Variants and MatchFilter options in a model with variant blocks

Behavior changed in R2021a

- **Variants:** Using the `find_system` function *without* the `Variants` option includes only the active variant choice in the search by default.

Consider a model with a Variant Subsystem that has two variant choices, `Linear Controller` and `Non-Linear Controller`.

This command returns only the active Add blocks in the model.

```
add_blocks=find_system('sldemo_variant_subsystems/Controller',...
'BlockType','Sum')
```

```
add_blocks =
```

```
1x1 cell array
```

```
{'sldemo_variant_subsystems/Controller/Nonlinear Controller/Add'}
```

- **MatchFilter:** Using the `find_system` function with the `MatchFilter` option applies the filters on the active and inactive variant choices by default.

Consider a model with a Variant Subsystem that has two variant choices, `Linear Controller` and `Non-Linear Controller`. The filter function `findAddBlocks` finds all the Add blocks in the model.

```
function match = findAddBlocks(handle)
match = strcmp(get_param(handle, 'Type'), 'block') &&...
strcmp(get_param(handle, 'BlockType'), 'Sum');
end
```

This command returns both the active and inactive Add blocks in the model.

```
add_blocks=find_system('sldemo_variant_subsystems','MatchFilter',...
@findAddBlocks)
```

```
add_blocks =
```

```
2x1 cell array
```

```
{'sldemo_variant_subsystems/Controller/Linear Controller/Add' }  
{'sldemo_variant_subsystems/Controller/Nonlinear Controller/Add'}
```

- `find_system` does not support the use of `MatchFilter` along with the `Variants` option.

This command produces an error:

```
find_system(bdroot, 'MatchFilter', @Simulink.match.activeVariants, ...  
            'Variants', 'ActiveVariants');
```

See Also

`Simulink.findBlocksOfType` | `Simulink.findBlocks` | `Simulink.allBlockDiagrams` | `find_mdrefs` | `get_param` | `getSimulinkBlockHandle` | `set_param` | **Model Explorer** | **Simulink Editor**

Topics

“Edit and Manage Workspace Variables by Using Model Explorer”

“Regular Expressions”

“Block-Specific Parameters” on page 6-26

Introduced before R2006a

fixdt

Package: Simulink

Create `Simulink.NumericType` object describing a fixed-point or floating-point data type

Syntax

```
a = fixdt(Signed,WordLength)
a = fixdt(Signed,WordLength,FractionLength)
a = fixdt(Signed,WordLength,TotalSlope,Bias)
a = fixdt(Signed,WordLength,SlopeAdjustmentFactor,FixedExponent,Bias)
a = fixdt(DataTypeNameString)
a = fixdt(___, 'DataTypeOverride', 'Off')
[a,IsScaledDouble] = fixdt(___)
```

Description

`a = fixdt(Signed,WordLength)` returns a `Simulink.NumericType` object that describes a fixed-point data type with the specified signedness and wordlength, and unspecified scaling.

`a = fixdt(Signed,WordLength,FractionLength)` returns a `Simulink.NumericType` object that describes a fixed-point data type with binary point scaling.

`a = fixdt(Signed,WordLength,TotalSlope,Bias)` returns a `Simulink.NumericType` object that describes a fixed-point data type with slope and bias scaling.

`a = fixdt(Signed,WordLength,SlopeAdjustmentFactor,FixedExponent,Bias)` returns a `Simulink.NumericType` object that describes a fixed-point data type with slope and bias scaling.

`a = fixdt(DataTypeNameString)` returns a `Simulink.NumericType` object that describes an integer, fixed-point, or floating-point data type specified by the name of a data type.

`a = fixdt(___, 'DataTypeOverride', 'Off')` returns a `Simulink.NumericType` object with its `DataTypeOverride` parameter set to `Off`. The default value for this property is `Inherit`. You can specify the `DataTypeOverride` parameter after any combination of other input parameters.

`[a,IsScaledDouble] = fixdt(___)` returns a `Simulink.NumericType` object that describes a fixed-point or floating-point data type and a flag that indicates whether the specified data type is of a scaled double data type.

Examples

Create a `Simulink.NumericType` Object with Unspecified Scaling

Create a signed `Simulink.NumericType` object with a word length of 16 bits and unspecified scaling.

```
a = fixdt(1,16)
```

```
a =  
  NumericType with properties:  
  
    DataTypeMode: 'Fixed-point: unspecified scaling'  
    Signedness: 'Signed'  
    WordLength: 16  
    IsAlias: 0  
    DataScope: 'Auto'  
    HeaderFile: ''  
    Description: ''
```

Create a Simulink.NumericType Object with Binary Point Scaling

Create a `Simulink.NumericType` object that describes a signed fixed-point data types with a word length of 16 bits and fraction length of 2 bits.

```
a = fixdt(1,16,2)  
  
a =  
  NumericType with properties:  
  
    DataTypeMode: 'Fixed-point: binary point scaling'  
    Signedness: 'Signed'  
    WordLength: 16  
    FractionLength: 2  
    IsAlias: 0  
    DataScope: 'Auto'  
    HeaderFile: ''  
    Description: ''
```

Create a Simulink.NumericType Object with Slope and Bias Scaling

The real-world value of a slope bias scaled number is represented by:

$$\text{real world value} = (\text{slope} \times \text{integer}) + \text{bias}$$

Create a `Simulink.NumericType` object that describes a signed fixed-point data type with a word length of 16 bits, slope of 2^{-2} , and bias of 4.

```
a = fixdt(1,16,2^-2,4)  
  
a =  
  NumericType with properties:  
  
    DataTypeMode: 'Fixed-point: slope and bias scaling'  
    Signedness: 'Signed'  
    WordLength: 16  
    Slope: 0.2500  
    Bias: 4  
    IsAlias: 0  
    DataScope: 'Auto'
```



```
HeaderFile: ''
Description: ''
```

Alternatively, the slope can be represented by:

$$\text{slope} = \text{slopeadjustmentfactor} \times 2^{\text{fixedexponent}}$$

```
a = fixdt(1,16,1,-2,4)
```

```
a =
```

```
NumericType with properties:
```

```
DataTypeMode: 'Fixed-point: slope and bias scaling'
Signedness: 'Signed'
WordLength: 16
    Slope: 0.2500
    Bias: 4
    IsAlias: 0
DataScope: 'Auto'
HeaderFile: ''
Description: ''
```

The `DataTypeMode` property of the `Simulink.NumericType` object, `a`, is slope and bias scaling.

Create a `Simulink.NumericType` Object Using a Data Type Name

Use a data type name to create a `Simulink.NumericType` object that describes an 8-bit, unsigned, fixed-point data type and return a flag that indicates whether the object is of a scaled double data type.

```
[a,IsScaledDouble] = fixdt('ufix8')
```

```
a =
```

```
NumericType with properties:
```

```
DataTypeMode: 'Fixed-point: binary point scaling'
Signedness: 'Unsigned'
WordLength: 8
FractionLength: 0
    IsAlias: 0
DataScope: 'Auto'
HeaderFile: ''
Description: ''
```

```
IsScaledDouble = logical
0
```

The `IsScaledDouble` output returns `0`, which indicates that the data type of `a` is not a scaled double data type.

Create a Simulink.NumericType Object with DataTypeOverride Set to Off

Create a Simulink.NumericType object with its DataTypeOverride property set to Off.

```
a = fixdt(0,8,2,'DataTypeOverride','Off')  
  
a =  
  NumericType with properties:  
  
    DataTypeMode: 'Fixed-point: binary point scaling'  
    Signedness: 'Unsigned'  
    WordLength: 8  
    FractionLength: 2  
    DataTypeOverride: 'Off'  
    IsAlias: 0  
    DataScope: 'Auto'  
    HeaderFile: ''  
    Description: ''
```

Input Arguments

Signed — Signedness

true or 1 | false or 0

Signedness of the Simulink.NumericType object, specified as a numeric or logical 1 (true) or 0 (false). A value of 1, or true, indicates a signed data type. A value of 0, or false, indicates an unsigned data type.

Data Types: logical

WordLength — Word length

positive scalar

Word length, in bits, of the Simulink.NumericType object, specified as a positive scalar.

Data Types: half | single | double | int8 | int16 | int32 | int64 | uint8 | uint16 | uint32 | uint64

FractionLength — Fraction length

0 (default) | scalar

Fraction length, in bits, of the Simulink.NumericType object, specified as a scalar.

FractionLength can be greater than WordLength. For more information, see “Binary Point Interpretation” (Fixed-Point Designer).

Data Types: half | single | double | int8 | int16 | int32 | int64 | uint8 | uint16 | uint32 | uint64

TotalSlope — Slope of the scaling

1 (default) | scalar

Slope of the scaling, specified as a scalar.

The following equation represents the real-world value of a slope bias scaled number:

$$realworldvalue = (slope \times integer) + bias$$

Data Types: half | single | double | int8 | int16 | int32 | int64 | uint8 | uint16 | uint32 | uint64

Bias — Bias of the scaling

0 (default) | scalar

Bias of the scaling, specified as a scalar.

The following equation represents the real-world value of a slope bias scaled number:

$$realworldvalue = (slope \times integer) + bias$$

Data Types: half | single | double | int8 | int16 | int32 | int64 | uint8 | uint16 | uint32 | uint64

SlopeAdjustmentFactor — Slope adjustment factor of slope and bias scaled number

1 (default) | positive scalar

Slope adjustment factor of a slope bias scaled number, specified as a positive scalar.

The slope adjustment factor must be greater than or equal to 1 and less than 2. If you input a `SlopeAdjustmentFactor` outside this range, `fixdt` automatically applies a scaling normalization to the values of `SlopeAdjustmentFactor` and `FixedExponent` so that the revised slope adjustment factor is greater than or equal to 1 and less than 2, and maintains the value of the slope.

The following equation demonstrates the relationship between the slope, fixed exponent, and slope adjustment factor:

$$slope = slopeadjustmentfactor \times 2^{fixedexponent}$$

Data Types: half | single | double | int8 | int16 | int32 | int64 | uint8 | uint16 | uint32 | uint64

FixedExponent — Fixed exponent of slope and bias scaled number

0 (default) | scalar

Fixed exponent of a slope bias scaled number, specified as a scalar.

The following equation demonstrates the relationship between the slope, fixed exponent, and slope adjustment factor:

$$slope = slopeadjustmentfactor \times 2^{fixedexponent}$$

Data Types: single | double | int8 | int16 | int32 | int64 | uint8 | uint16 | uint32 | uint64

DataTypeNameString — Data type name

character vector

Data type name, specified as a character vector.

The data type name can be either the name of a built-in Simulink data type or the name of a fixed-point data type that conforms to the naming convention for fixed-point names established by the

Fixed-Point Designer product. For more information, see “Fixed-Point Data Type and Scaling Notation” (Fixed-Point Designer).

Data Types: char

Output Arguments

a — Data type

Simulink.NumericType object

Data type, returned as a Simulink.NumericType object.

IsScaledDouble — Scaled double flag

logical

Scaled double flag, returned as a logical that indicates whether the specified data type name is the name of a scaled double data type.

See Also

float | sfix | sfrac | sint | ufix | ufrac | uint

Topics

“Fixed-Point Data Type and Scaling Notation” (Fixed-Point Designer)

Introduced before R2006a

fixpt_evenspace_cleanup

Modify breakpoints of lookup table to have even spacing

Syntax

```
xdata_modified = fixpt_evenspace_cleanup(xdata,xdt,xscale)
```

Description

xdata_modified = `fixpt_evenspace_cleanup(xdata,xdt,xscale)` modifies breakpoints of a lookup table to have even spacing after quantization. By adjusting breakpoints to have even spacing after quantization, Simulink Coder generated code can exclude breakpoints from memory.

xdata is the breakpoint vector of a lookup table to make evenly spaced, such as `0:0.005:1`. *xdt* is the data type of the breakpoints, such as `sfix(16)`. *xscale* is the scaling of the breakpoints, such as 2^{-12} . Using these three inputs, `fixpt_evenspace_cleanup` returns the modified breakpoints in *xdata_modified*.

This function works only with nontunable data and considers data to have even spacing relative to the scaling slope. For example, the breakpoint vector `[0 2 5]`, which has spacing value 2 and 3, appears to have uneven spacing. However, the difference between the maximum spacing 3 and the minimum spacing 2 equals 1. If the scaling slope is 1 or greater, a spacing variation of 1 represents a 1-bit change or less. In this case, the `fixpt_evenspace_cleanup` function considers a spacing variation of 1 bit or less to be even.

Modifications to breakpoints can change the numerical behavior of a lookup table. To check for changes, test the model using simulation, rapid prototyping, or other appropriate methods.

Examples

Modify breakpoints of a lookup table to have even spacing after quantization:

```
xdata = 0:0.005:1;
xdt = sfix(16);
xscale = 2^-12;
xdata_modified = fixpt_evenspace_cleanup(xdata,xdt,xscale)
```

See Also

`fixdt` | `fixpt_interp1` | `fixpt_look1_func_approx` | `fixpt_look1_func_plot` | `sfix` | `ufix`

Topics

“Effects of Spacing on Speed, Error, and Memory Usage” (Fixed-Point Designer)
 “Create Lookup Tables for a Sine Function” (Fixed-Point Designer)

Introduced before R2006a

fixpt_interp1

Implement 1-D lookup table

Syntax

```
y = fixpt_interp1(xdata,ydata,x,xdtype,xscale,ydt,yscale,rndmeth)
```

Description

y = fixpt_interp1(*xdata*,*ydata*,*x*,*xdtype*,*xscale*,*ydt*,*yscale*,*rndmeth*) implements a one-dimensional lookup table to find output *y* for input *x*. If *x* falls between two *xdata* values (breakpoints), *y* is the result of interpolating between the corresponding *ydata* values. If *x* is greater than the maximum value in *xdata*, *y* is the maximum *ydata* value. If *x* is less than the minimum value in *xdata*, *y* is the minimum *ydata* value.

If the input data type *xdtype* or the output data type *ydt* is floating point, fixpt_interp1 performs the interpolation using floating-point calculations. Otherwise, fixpt_interp1 uses integer-only calculations. These calculations handle the input scaling *xscale* and the output scaling *yscale* and obey the rounding method *rndmeth*.

Input Arguments

xdata

Vector of breakpoints for the lookup table, such as `linspace(0,8,33)`.

ydata

Vector of table data that correspond to the breakpoints for the lookup table, such as `sin(xdata)`.

x

Vector of input values for the lookup table to process, such as `linspace(-1,9,201)`.

xdtype

Data type of input *x*, such as `sfixed(8)`.

xscale

Scaling for input *x*, such as 2^{-3} .

ydt

Data type of output *y*, such as `sfixed(16)`.

yscale

Scaling for output *y*, such as 2^{-14} .

rndmeth

Rounding mode supported by fixed-point Simulink blocks:

| | |
|-------------------|--|
| 'Ceiling' | Round to the nearest representable number in the direction of positive infinity. |
| 'Floor' (default) | Round to the nearest representable number in the direction of negative infinity. |
| 'Nearest' | Round to the nearest representable number. |
| 'Toward Zero' | Round to the nearest representable number in the direction of zero. |

Examples

Interpolate outputs for x using a 1-D lookup table that approximates the sine function:

```
xdata = linspace(0,8,33).';
ydata = sin(xdata);
% Define input x as a vector of 201 evenly
% spaced points between -1 and 9 (includes
% values both lower and higher than the range
% of breakpoints in xdata)
x = linspace(-1,9,201).';
% Interpolate output values for x
y = fixpt_interp1(xdata,ydata,x,sfix(8),2^-3,sfix(16),...
  2^-14,'Floor')
```

See Also

[fixpt_evenspace_cleanup](#) | [fixpt_look1_func_approx](#) | [fixpt_look1_func_plot](#)

Topics

"Producing Lookup Table Data" (Fixed-Point Designer)

Introduced before R2006a

fixpt_look1_func_approx

Optimize fixed-point approximation of nonlinear function by interpolating lookup table data points

Syntax

```
[xdata,ydata,errworst] = fixpt_look1_func_approx('func',...
xmin,xmax,xdt,xscale,ydt,yscale,rndmeth,errmax,nptsmax)
[xdata,ydata,errworst] = fixpt_look1_func_approx('func',...
xmin,xmax,xdt,xscale,ydt,yscale,rndmeth,errmax,[])
[xdata,ydata,errworst] = fixpt_look1_func_approx('func',...
xmin,xmax,xdt,xscale,ydt,yscale,rndmeth,[],nptsmax)
[xdata,ydata,errworst] = fixpt_look1_func_approx('func',...
xmin,xmax,xdt,xscale,ydtydt,yscale,rndmeth,errmax,nptsmax,spacing)
```

Description

[xdata,ydata,errworst] = fixpt_look1_func_approx('func',...
xmin,xmax,xdt,xscale,ydt,yscale,rndmeth,errmax,nptsmax) returns the optimal breakpoints of a lookup table, an ideal function applied to the breakpoints, and the worst-case approximation error. The lookup table satisfies the maximum acceptable error and maximum number of points that you specify.

[xdata,ydata,errworst] = fixpt_look1_func_approx('func',...
xmin,xmax,xdt,xscale,ydt,yscale,rndmeth,errmax,[]) returns the optimal breakpoints of a lookup table, an ideal function applied to the breakpoints, and the worst-case approximation error. The lookup table satisfies the maximum acceptable error that you specify.

[xdata,ydata,errworst] = fixpt_look1_func_approx('func',...
xmin,xmax,xdt,xscale,ydt,yscale,rndmeth,[],nptsmax) returns the optimal breakpoints of a lookup table, an ideal function applied to the breakpoints, and the worst-case approximation error. The lookup table satisfies the maximum number of points that you specify.

[xdata,ydata,errworst] = fixpt_look1_func_approx('func',...
xmin,xmax,xdt,xscale,ydtydt,yscale,rndmeth,errmax,nptsmax,spacing) returns the optimal breakpoints of a lookup table, an ideal function applied to the breakpoints, and the worst-case approximation error. The lookup table satisfies the maximum acceptable error, maximum number of points, and breakpoint spacing that you specify.

In each case, `fixpt_look1_func_approx` interpolates between lookup table data points to optimize the fixed-point approximation. The inputs `xmin` and `xmax` specify the range over which to approximate the breakpoints. The inputs `xdt`, `xscale`, `ydt`, `yscale`, and `rndmeth` follow conventions used by fixed-point Simulink blocks.

The inputs `errmax`, `nptsmax`, and `spacing` are optional. Of these inputs, you must specify at least `errmax` or `nptsmax`. If you omit one of those two inputs, you must use brackets, `[]`, in place of the omitted input. `fixpt_look1_func_approx` ignores that requirement for the lookup table.

If you do not specify spacing, and more than one spacing satisfies `errmax` and `nptsmax`, `fixpt_look1_func_approx` chooses in this order: power-of-2 spacing, even spacing, uneven

spacing. This behavior applies when you specify both *errmax* and *nptsmax*, but not when you specify just one of the two.

Input Arguments

func

Function of x for which to approximate breakpoints. Enclose this expression in single quotes, for example, `'sin(2*pi*x)'`.

xmin

Minimum value of x .

xmax

Maximum value of x .

xdt

Data type of x .

xscale

Scaling for the x values.

ydt

Data type of y .

yscale

Scaling for the y values.

rndmeth

Rounding mode supported by fixed-point Simulink blocks:

| | |
|-------------------|--|
| 'Ceiling' | Round to the nearest representable number in the direction of positive infinity. |
| 'Floor' (default) | Round to the nearest representable number in the direction of negative infinity. |
| 'Nearest' | Round to the nearest representable number. |
| 'Toward Zero' | Round to the nearest representable number in the direction of zero. |

errmax

Maximum acceptable error between the ideal function and the approximation given by the lookup table.

nptsmax

Maximum number of points for the lookup table.

spacing

Spacing of breakpoints for the lookup table:

| | |
|--------------------------|--------------------------|
| 'even' | Even spacing |
| 'pow2' | Even, power-of-2 spacing |
| 'unrestricted' (default) | Uneven spacing |

| If you specify... | The breakpoints of the lookup table... |
|----------------------------------|---|
| <i>errmax</i> and <i>nptsmax</i> | Meet both criteria, if possible. The <i>errmax</i> requirement has higher priority than <i>nptsmax</i> . If the breakpoints cannot meet both criteria with the specified spacing, <i>nptsmax</i> does not apply. |
| <i>errmax</i> only | Meet the error criteria, and <code>fixpt_look1_func_approx</code> returns the fewest number of points. |
| <i>nptsmax</i> only | Meet the points criteria, and <code>fixpt_look1_func_approx</code> returns the smallest worst-case error. |

Output Arguments**xdata**

Vector of breakpoints for the lookup table.

ydata

Vector of values from applying the ideal function to the breakpoints.

errworst

Worst-case error, which is the maximum absolute error between the ideal function and the approximation given by the lookup table.

Examples

Approximate a fixed-point sine function using a lookup table:

```
func = 'sin(2*pi*x)';
% Define the range over which to optimize breakpoints
xmin = 0;
xmax = 0.25;
% Define the data type and scaling for the inputs
xdt = ufix(16);
xscale = 2^-16;
% Define the data type and scaling for the outputs
ydt = sfix(16);
yscale = 2^-14;
% Specify the rounding method
rndmeth = 'Floor';
```

```
% Define the maximum acceptable error
errmax = 2^-10;
% Choose even, power-of-2 spacing for breakpoints
spacing = 'pow2';
% Create the lookup table
[xdata,ydata,errworst] = fixpt_look1_func_approx(func,...
    xmin,xmax,xdt,xscale,ydt,yscale,rndmeth,errmax,[],spacing);
```

See Also

[fixpt_evenspace_cleanup](#) | [fixpt_interpl](#) | [fixpt_look1_func_plot](#)

Topics

“Producing Lookup Table Data” (Fixed-Point Designer)

“Use Lookup Table Approximation Functions” (Fixed-Point Designer)

Introduced before R2006a

fixpt_look1_func_plot

Plot fixed-point approximation function for lookup table

Syntax

```
fixpt_look1_func_plot(xdata,ydata,'func',...  
xmin,xmax,xdt,xscale,ydt,yscale,rndmeth)  
errworst = fixpt_look1_func_plot(xdata,ydata,'func',...  
xmin,xmax,xdt,xscale,ydt,yscale,rndmeth)
```

Description

`fixpt_look1_func_plot(xdata,ydata,'func',...
xmin,xmax,xdt,xscale,ydt,yscale,rndmeth)` plots a lookup table approximation function and the error from the ideal function.

`errworst = fixpt_look1_func_plot(xdata,ydata,'func',...
xmin,xmax,xdt,xscale,ydt,yscale,rndmeth)` plots a lookup table approximation function and the error from the ideal function. The output `errworst` is the maximum absolute error.

You can use `fixpt_look1_func_approx` to generate `xdata` and `ydata`, the breakpoints and table data for the lookup table, respectively. `fixpt_look1_func_approx` applies the ideal function to the breakpoints in `xdata` to produce `ydata`. While this method is the easiest way to generate `ydata`, you can choose other values for `ydata` as input for `fixpt_look1_func_plot`. Choosing different values for `ydata` can, in some cases, produce a lookup table with a smaller maximum absolute error.

Input Arguments

xdata

Vector of breakpoints for the lookup table.

ydata

Vector of values from applying the ideal function to the breakpoints.

func

Function of `x` for which to approximate breakpoints. Enclose this expression in single quotes, for example, `'sin(2*pi*x)'`.

xmin

Minimum value of `x`.

xmax

Maximum value of `x`.

xdt

Data type of x.

xscale

Scaling for the x values.

ydt

Data type of y.

yscale

Scaling for the y values.

rndmeth

Rounding mode supported by fixed-point Simulink blocks:

| | |
|-------------------|--|
| 'Ceiling' | Round to the nearest representable number in the direction of positive infinity. |
| 'Floor' (default) | Round to the nearest representable number in the direction of negative infinity. |
| 'Nearest' | Round to the nearest representable number. |
| 'Toward Zero' | Round to the nearest representable number in the direction of zero. |

Examples

Plot a fixed-point approximation of the sine function using data points generated by `fixpt_look1_func_approx`:

```
func = 'sin(2*pi*x)';
% Define the range over which to optimize breakpoints
xmin = 0;
xmax = 0.25;
% Define the data type and scaling for the inputs
xdt = ufix(16);
xscale = 2^-16;
% Define the data type and scaling for the outputs
ydt = sfix(16);
yscale = 2^-14;
% Specify the rounding method
rndmeth = 'Floor';
% Define the maximum acceptable error
errmax = 2^-10;
% Choose even, power-of-2 spacing for breakpoints
spacing = 'pow2';
% Generate data points for the lookup table
[xdata,ydata,errworst]=fixpt_look1_func_approx(func,...
    xmin,xmax,xdt,xscale,ydt,yscale,rndmeth,errmax,[],spacing);
% Plot the sine function (ideal and fixed-point) & errors
fixpt_look1_func_plot(xdata,ydata,func,xmin,xmax,...
    xdt,xscale,ydt,yscale,rndmeth);
```

`fixpt_look1_func_plot` plots the fixed-point sine function, using generated data points, and plots the error between the ideal function and the fixed-point function. The maximum absolute error and the number of points required appear on the plot. The error drops to zero at a breakpoint, but increases between breakpoints due to curvature differences between the ideal function and the line drawn between breakpoints.

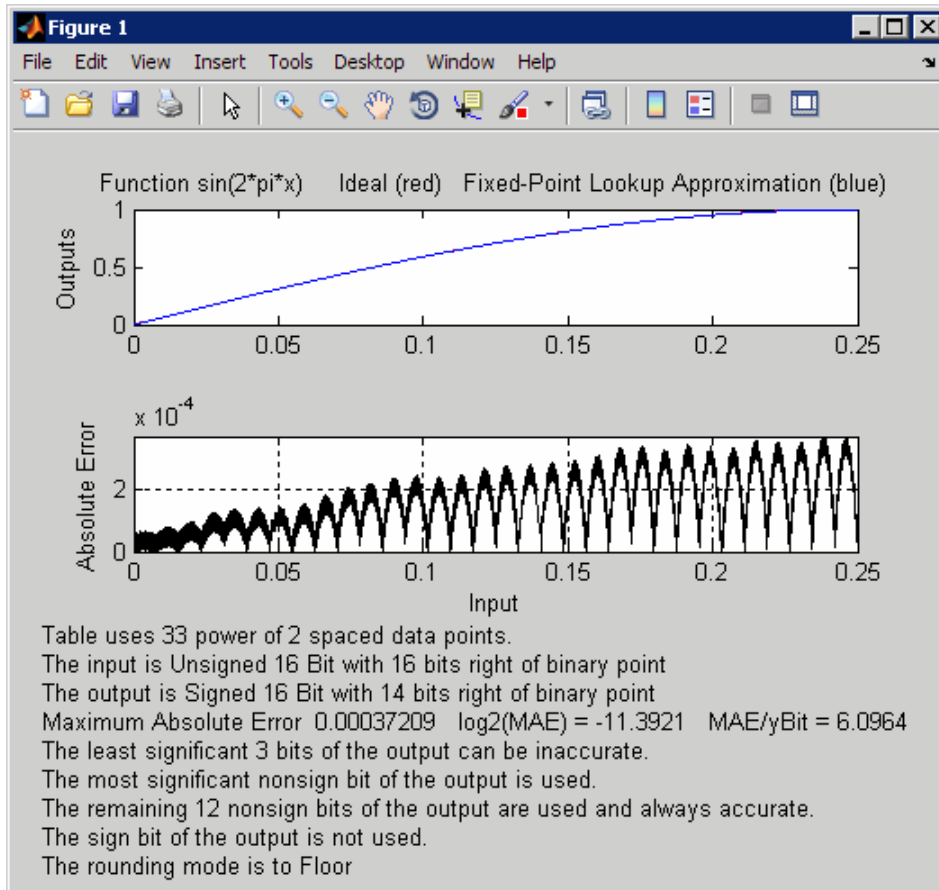

The lookup table requires 33 points to achieve a maximum absolute error of $2^{-11.3922}$.

See Also

`fixpt_evenspace_cleanup` | `fixpt_interp1` | `fixpt_look1_func_approx`

Topics

“Producing Lookup Table Data” (Fixed-Point Designer)

“Use Lookup Table Approximation Functions” (Fixed-Point Designer)

Introduced before R2006a

fixpt_set_all

Set property for each fixed-point block in subsystem

Syntax

```
fixpt_set_all(SystemName, fixptPropertyName, fixptPropertyValue)
```

Description

`fixpt_set_all(SystemName, fixptPropertyName, fixptPropertyValue)` sets the property `fixptPropertyName` of every applicable block in the model or subsystem `SystemName` to the value `fixptPropertyValue`

Examples

Set each fixed-point block in a model `Filter_1` to round towards the floor and saturate upon overflow:

```
% Round towards the floor  
fixpt_set_all('Filter_1', 'RndMeth', 'Floor')
```

```
% Saturate upon overflow  
fixpt_set_all('Filter_1', 'DoSatur', 'on')
```

Introduced before R2006a

fixptbestexp

Exponent that gives best precision for fixed-point representation of value

Syntax

```
out = fixptbestexp(RealWorldValue, TotalBits, IsSigned)
out = fixptbestexp(RealWorldValue, FixPtDataType)
```

Description

`out = fixptbestexp(RealWorldValue, TotalBits, IsSigned)` returns the exponent that gives the best precision for the fixed-point representation of *RealWorldValue*. *TotalBits* specifies the number of bits for the fixed-point number. *IsSigned* specifies whether the fixed-point number is signed: 1 indicates the number is signed and 0 indicates the number is not signed.

`out = fixptbestexp(RealWorldValue, FixPtDataType)` returns the exponent that gives the best precision based on the data type *FixPtDataType*.

Examples

Get the exponent that gives the best precision for the real-world value 4/3 using a signed, 16-bit number:

```
out = fixptbestexp(4/3,16,1)
```

```
out =
    -14
```

Alternatively, specify the fixed-point data type:

```
out = fixptbestexp(4/3,sfix(16))
```

```
out =
    -14
```

This shows that the maximum precision representation of 4/3 is obtained by placing 14 bits to the right of the binary point:

```
01.01010101010101
```

You can specify the precision of this representation in fixed-point blocks by setting the scaling to 2^{-14} or `2^fixptbestexp(4/3,16,1)`.

See Also

fixptbestprec

Introduced before R2006a

fixptbestprec

Determine maximum precision available for fixed-point representation of value

Syntax

```
out = fixptbestprec(RealWorldValue,TotalBits,IsSigned)
out = fixptbestprec(RealWorldValue,FixPtDataType)
```

Description

`out = fixptbestprec(RealWorldValue,TotalBits,IsSigned)` determines the maximum precision for the fixed-point representation of the real-world value specified by `RealWorldValue`. You specify the number of bits for the fixed-point number with `TotalBits`, and you specify whether the fixed-point number is signed with `IsSigned`. If `IsSigned` is 1, the number is signed. If `IsSigned` is 0, the number is not signed. The maximum precision is returned to `out`.

`out = fixptbestprec(RealWorldValue,FixPtDataType)` determines the maximum precision based on the data type specified by `FixPtDataType`.

Examples

Example 1

The following command returns the maximum precision available for the real-world value 4/3 using a signed, 8-bit number:

```
out = fixptbestprec(4/3,8,1)

out =
    0.015625
```

Alternatively, you can specify the fixed-point data type:

```
out = fixptbestprec(4/3,sfix(8))

out =
    0.015625
```

This value means that the maximum precision available for 4/3 is obtained by placing six bits to the right of the binary point since 2^{-6} equals 0.015625:

```
01.010101
```

Example 2

You can use the maximum precision as the scaling in fixed-point blocks. This enables you to use `fixptbestprec` to perform a type of autoscaling if you would like to designate a known range of your simulation. For example, if your known range is -13 to 22, and you are using a safety margin of 30%:

```
knownMax = 22;
knownMin = -13;
```

```
localSafetyMargin = 30;  
slope = max( fixptbestprec( (1+localSafetyMargin/100)* ...  
    [knownMax,knownMin], sfix(16) ) );
```

The variable `slope` can then be used in the expression that you specify for the **Output data type** parameter in a block mask. Be sure to select the **Lock output data type setting against changes by the fixed-point tools** check box in the same block to prevent the Fixed-Point Tool from overriding the scaling. If you know the range, you can use this technique in place of relying on a model simulation to provide the range to the autoscaling tool, as described in `autofixexp`.

See Also

`fixptbestexp`

Introduced before R2006a

float

Create `Simulink.NumericType` object describing floating-point data type

Syntax

```
a = float('half')
a = float('single')
a = float('double')
```

Description

`a = float('half')` returns a `Simulink.NumericType` object that describes the data type of an IEEE half (16 total bits, 5 exponent bits).

`a = float('single')` returns a `Simulink.NumericType` object that describes the data type of an IEEE single (32 total bits, 8 exponent bits).

`a = float('double')` returns a `Simulink.NumericType` object that describes the data type of an IEEE double (64 total bits, 11 exponent bits).

Note `float` is a legacy function. In new code, use `fixdt` instead. In existing code, replace `float('half')` with `fixdt('half')`, `float('single')` with `fixdt('single')`, and `float('double')` with `fixdt('double')`.

Examples

Define an IEEE single data type.

```
>> a = float('single')
```

```
a =
```

```
    NumericType with properties:
```

```
    DataTypeMode: 'Single'
        IsAlias: 0
        DataScope: 'Auto'
        HeaderFile: ''
        Description: ''
```

See Also

`fixdt` | `Simulink.NumericType` | `sfix` | `sfrac` | `sint` | `ufix` | `ufrac` | `uint`

Introduced before R2006a

fmudialog.createBusType

Create all FMU bus objects required for structured input or output ports in workspace

Syntax

```
fmudialog.createBusType(currentBlock)
```

Description

`fmudialog.createBusType(currentBlock)` creates all the FMU bus objects required for structured input or output ports in the workspace.

Examples

Create FMU Bus Object in Current Workspace

Create FMU bus object in current workspace.

```
fmudialog.createBusType(gcb)
```

Input Arguments

currentBlock — Current block

current block

Current block for which to create all required FMU bus objects.

Data Types: char | string

See Also

FMU

Topics

“Import FMUs”

“Implement an FMU Block”

Introduced in R2020b

frameedit

Open PrintFrame Editor to edit print frames for Simulink and Stateflow block diagrams

Syntax

```
frameedit  
frameedit(filename)
```

Description

frameedit opens a new file in the **PrintFrame Editor**, which is a graphical interface you use to create borders for Simulink and Stateflow block diagrams.

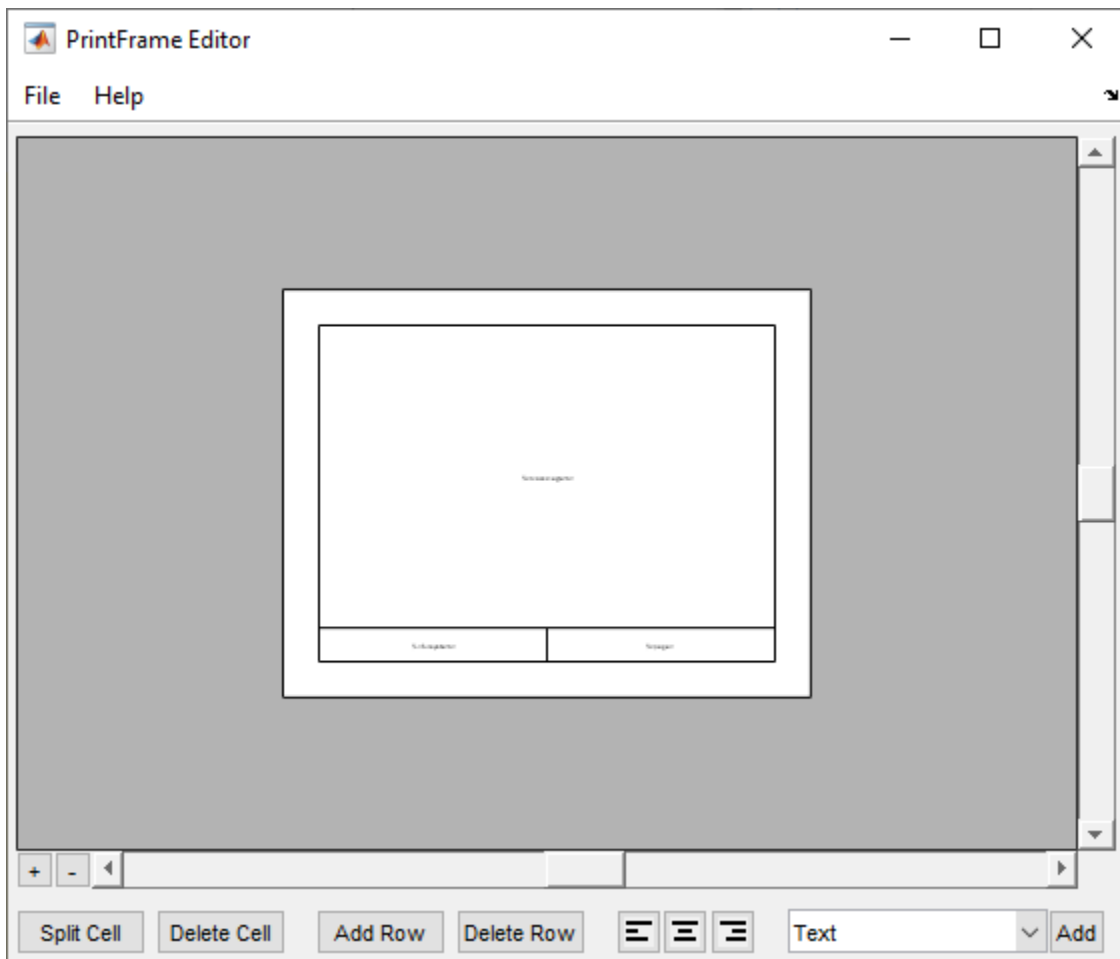

frameedit(filename) opens the specified file in the **PrintFrame Editor**.

Examples

Open Existing Print Frame for Editing

Suppose you have a print frame named `myFrame.fig`. You can open it directly in the **PrintFrame Editor** from the MATLAB Command Window.

```
frameedit('myFrame.fig')
```

The **PrintFrame Editor** opens the print frame named `myFrame.fig`.

Input Arguments

filename — Print frame file name

character vector | string scalar

Print frame file name, specified as a character vector or string scalar.

The specified file must be a figure file (`.fig`) previously created and saved with the **PrintFrame Editor**.

Example: `frameedit('myFrame.fig')`

Data Types: `char` | `string`

See Also

Topics

“Print Model Diagrams”

“Create Print Frames for Printed Pages”

Introduced in R2008b

gcb

Get path name of current block

Syntax

```
b1 = gcb  
b1 = gcb(sys)
```

Description

`b1 = gcb` returns the full block path name of the current block in the current system. The current block is:

- The most recently clicked block
- The S-Function block currently executing its corresponding MATLAB function
- The block whose callback routine is being executed
- The block whose mask is being evaluated as part of the `MaskInitialization` parameter evaluation
- The last block loaded after opening a model

`b1 = gcb(sys)` returns the full block path name of the current block in the specified system. Load the system first.

Examples

Get Path Name of Most Recently Selected Block

Open a model.

```
vdp
```

In the model, select a block. For example, select the Gain block. Then, enter `gcb` at the command prompt.

```
gcb
```

```
ans =
```

```
vdp/Mu
```

Get Parameters of Current Block

Open a model.

```
vdp
```

Select the Gain block.

Use the value of `gcb` with `get_param` to get the value of the Gain parameter.

```
x = get_param(gcb, 'Gain')
```

```
x =
```

```
1
```

Get Current Block in Specified System

Load the model.

```
load_system('sldemo_fuelsys');
```

Get the current block in the `fuel_rate_control` subsystem.

```
bl = gcb('sldemo_fuelsys/fuel_rate_control')
```

```
bl =
```

```
sldemo_fuelsys/fuel_rate_control/validate_sample_time
```

Input Arguments

sys — System that contains the block

character vector

System that contains the block, specified as a character vector.

Example: `'vdp' 'sldemo_fuelsys/fuel_rate_control'`

See Also

`gcbh` | `gcbp` | `gcs` | `get_param`

Topics

“Mask Callback Code”

Introduced before R2006a

gcbh

Get handle of current block

Syntax

```
handle = gcbh
```

Description

handle = gcbh returns the handle of the current block in the current system.

Examples

Get Handle of Current Block

Get the handle of the most recently selected block.

```
handle = gcbh
```

```
handle =
```

```
    281.0001
```

See Also

gcb | gcbp | gcs | getSimulinkBlockHandle

Introduced before R2006a

gcbp

Get `Simulink.BlockPath` object for current block

Syntax

```
path = gcbp
```

Description

`path = gcbp` returns the `Simulink.BlockPath` object of the current block in the current system. The current block is:

- The most recently clicked block
- The last block loaded after opening a model

The returned `Simulink.BlockPath` object is context sensitive to model hierarchy.

Examples

Create `Simulink.BlockPath` Object for Selected Block

Open `sldemo_mdref_basic`.

```
sldemo_mdref_basic
```

Click a block in the model hierarchy. For example, click the block labeled `ScopeA` in the `CounterA` instance of `sldemo_mdref_counter`. Then, use `gcbp` in the Command Window.

```
path = gcbp
```

```
path =
```

```
Simulink.BlockPath  
Package: Simulink
```

```
Block Path:  
  sldemo_mdref_basic/CounterA  
  sldemo_mdref_counter/ScopeA
```

Use the `getBlock` method to access block path strings from this object.

```
Methods
```

See Also

Objects

`Simulink.BlockPath`

Functions

`gcb` | `gcbh` | `gcs` | `get_param` | `open` (`BlockPath`)

Introduced in R2019a

gcs

Get path name of current system

Syntax

`gcs`

Description

`gcs` returns the path name of the current system. The current system is one of these:

- During editing, the system or subsystem most recently clicked or that contains the block most recently clicked
- During simulation of a system that contains an S-Function block, the system or subsystem containing the S-Function block currently being evaluated
- During callbacks, the system containing any block whose callback routine is being executed
- During evaluation of `MaskInitialization`, the system containing the block whose mask is being evaluated
- The system most recently loaded into memory with `load_system`; only the first use of `load_system` makes the model the current system

The current system is the current model or a subsystem of the current model. Use `bdroot` to get the current model.

If you close the model that contains the current system, another open or loaded system becomes the current one. Use `gcs` to find out the new current system.

To explicitly set the current system, you can either:

- Use `set_param` with the 'CurrentSystem' parameter on the root Simulink model, for example:
`set_param(0, 'CurrentSystem', 'mymodel')`
- Open the model by using `open_system` or the model name at the MATLAB command prompt.

Examples

Get Current System That Contains a Block

Return the path of the system that contains the most recently selected block.

Open the model `sldemo_fuelsys`. Open the subsystem To Controller.

```
sldemo_fuelsys  
open_system('sldemo_fuelsys/To Controller')
```

Click the Rate Transition block. Get the current system.

```
gcs
```

```
ans =  
    'sldemo_fuelsys/To Controller'
```

Get Current System After Loading a Model

Open the model f14 and get the current system.

```
f14  
gcs  
ans =  
    'f14'
```

Load the model vdp using `load_system`. Then get the current system.

```
load_system('vdp');  
gcs  
ans =  
    'vdp'
```

To remove vdp from memory, close it. In this example, the current system becomes the open model, f14.

```
close_system('vdp');  
gcs  
ans =  
    'f14'
```

See Also

`bdroot` | `gcb` | `gcbp`

Introduced before R2006a

get_param

Get parameter names and values

Syntax

```
ParamValue = get_param(Object,Parameter)
```

Description

`ParamValue = get_param(Object,Parameter)` returns the name or value of the specified parameter for the specified model or block object. Open or load the Simulink model first.

Tip If you make multiple calls to `get_param` for the same block, then specifying the block using a numeric handle is more efficient than using the full block path. Use `getSimulinkBlockHandle` to get a block handle.

For parameter names, see:

- “Block-Specific Parameters” on page 6-26
- “Common Block Properties” on page 6-12

Examples

Get a Block Parameter Value and a Model Parameter Value

Load the vdp model.

```
load_system('vdp');
```

Get the value for the Expression block parameter.

```
BlockParameterValue = get_param('vdp/Mu','Multiplication')
```

```
BlockParameterValue =  
    'Element-wise(K.*u)'
```

Get the value for the SolverType model parameter.

```
SolverType = get_param('vdp','SolverType')
```

```
SolverType =  
    Variable-step
```

Get Root Parameter Names and Values

Get a list of global parameter names by finding the difference between the Simulink root parameter names and the model parameter names.

```
RootParameterNames = fieldnames(get_param(0, 'ObjectParameters'));
load_system('vdp')
ModelParameterNames = fieldnames(get_param('vdp', 'ObjectParameters'));
GlobalParameterNames = setdiff(RootParameterNames, ModelParameterNames)
```

```
GlobalParameterNames =
    'AutoSaveOptions'
    'CacheFolder'
    'CallbackTracing'
    'CharacterEncoding'
    .
    .
    'CurrentSystem'
```

Get the value of a global parameter.

```
GlobalParameterValue = get_param(0, 'CurrentSystem')
```

```
GlobalParameterValue =
    vdp
```

Get Model Parameter Names and Values

Get a list of model parameters for the vdp model .

```
load_system('vdp')
ModelParameterNames = get_param('vdp', 'ObjectParameters')
```

```
ModelParameterNames =
    Name: [1x1 struct]
    Tag: [1x1 struct]
    Description: [1x1 struct]
    Type: [1x1 struct]
    Parent: [1x1 struct]
    Handle: [1x1 struct]
    .
    .
    Version: [1x1 struct]
```

Get the current value of the ModelVersion model parameter for the vdp model.

```
ModelParameterValue = get_param('vdp', 'ModelVersion')
```

```
ModelParameterValue =
    1.6
```

Get All Blocks and a Parameter Value

Get a list of block paths and names for the vdp model.

```
load_system('vdp')
BlockPaths = find_system('vdp', 'Type', 'Block')
```

```
BlockPaths =
    14x1 cell array

    {'vdp/Constant'           }
    {'vdp/More Info'         }
    {'vdp/More Info/Model Info'}
    {'vdp/Mu'                 }
    {'vdp/Mux'                }
    {'vdp/Product'           }
    {'vdp/Scope'             }
    {'vdp/Square'            }
    {'vdp/Sum'                }
    {'vdp/Sum1'              }
    {'vdp/x1'                 }
    {'vdp/x2'                 }
    {'vdp/Out1'              }
    {'vdp/Out2'              }
```

Get a list of block dialog parameters for the Mu block.

```
BlockDialogParameters = get_param('vdp/Mu','DialogParameters')
```

```
BlockDialogParameters =
    struct with fields:

        Gain: [1x1 struct]
        Multiplication: [1x1 struct]
        ParamMin: [1x1 struct]
        ParamMax: [1x1 struct]
        ParamDataTypeStr: [1x1 struct]
        OutMin: [1x1 struct]
        OutMax: [1x1 struct]
        OutDataTypeStr: [1x1 struct]
        LockScale: [1x1 struct]
        RndMeth: [1x1 struct]
        SaturateOnIntegerOverflow: [1x1 struct]
        SampleTime: [1x1 struct]
```

Get the value for the Multiplication block parameter.

```
BlockParameterValue = get_param('vdp/Mu','Multiplication')
```

```
BlockParameterValue =
    'Element-wise(K.*u)'
```

Get a Block Parameter Value Using a Block Handle

If you make multiple calls to `get_param` for the same block, then using the block handle is more efficient than specifying the full block path as a character vector, e.g., `'vdp/Mu'`.

You can use the block handle in subsequent calls to `get_param` or `set_param`. If you examine the handle, you can see that it contains a double. Do not try to use the number of a handle alone (e.g., `5.007`) because you usually need to specify many more digits than MATLAB displays. Instead, assign the handle to a variable and use that variable name to specify a block.

Use `getSimulinkBlockHandle` to load the vdp model if necessary (by specifying `true`), and get a handle to the Mu block.

```
mublockhandle = getSimulinkBlockHandle('vdp/Mu',true);
```

Use the block handle with `get_param` and get the value for the `Expr` block parameter.

```
BlockParameterValue = get_param(mublockhandle,'Multiplication')
```

```
BlockParameterValue =  
    'Element-wise(K.*u)'
```

Display Block Types for all Blocks in a Model

Get a list of block paths and names for the vdp model.

```
load_system('vdp')  
BlockPaths = find_system('vdp','Type','Block')
```

```
BlockPaths =
```

```
14x1 cell array
```

```
{'vdp/Constant'      }  
{'vdp/More Info'    }  
{'vdp/More Info/Model Info'}  
{'vdp/Mu'           }  
{'vdp/Mux'          }  
{'vdp/Product'      }  
{'vdp/Scope'        }  
{'vdp/Square'       }  
{'vdp/Sum'          }  
{'vdp/Sum1'         }  
{'vdp/x1'           }  
{'vdp/x2'           }  
{'vdp/Out1'         }  
{'vdp/Out2'         }
```

Get the value for the `BlockType` parameter for each of the blocks in the vdp model.

```
BlockTypes = get_param(BlockPaths,'BlockType')
```

```
BlockTypes =
```

```
14x1 cell array
```

```
{'Constant'  }  
{'SubSystem' }  
{'SubSystem' }  
{'Gain'     }  
{'Mux'      }  
{'Product'  }  
{'Scope'    }  
{'Math'     }  
{'Sum'      }  
{'Sum'      }  
{'Integrator'}
```

```
{'Integrator'}
{'Outport'   }
{'Outport'   }
```

Input Arguments

Object — Name or handle of a model or block, or root

handle | character vector | cell array of character vectors | string array | 0

Handle or name of a model or block, or root, specified as a numeric handle or a character vector, a cell array of character vectors for multiple blocks, or 0 for root. A numeric handle must be a scalar. You can also get parameters of lines and ports, but you must use numeric handles to specify them.

Tip If you make multiple calls to `get_param` for the same block, then specifying a block using a numeric handle is more efficient than using the full block path. Use `getSimulinkBlockHandle` to get a block handle. Do not try to use the number of a handle alone (e.g., `5.007`) because you usually need to specify many more digits than MATLAB displays. Assign the handle to a variable and use that variable name to specify a block.

Specify 0 to get root parameter names, including global parameters and model parameters for the current Simulink session.

- Global parameters include Editor preferences and Simulink Coder parameters.
- Model parameters include configuration parameters, Simulink Coder parameters, and Simulink Code Inspector parameters.

Example: `'vdp/Mu'`

Parameter — Parameter of model or block, or root

character vector | string scalar

Parameter of model or block, or root, specified as a character vector or 0 for root. The table shows special cases.

| Specified Parameter | Result |
|---------------------|---|
| 'ObjectParameters' | Returns a structure array with the parameter names of the specified object (model, block, or root) as separate fields in the structure. |
| 'DialogParameters' | Returns a structure array with the block dialog box parameter names as separate fields in the structure. If the block has a mask, the function instead returns the mask parameters. |

| Specified Parameter | Result |
|---|--|
| Parameter name, e.g., 'BlockType'. Specify any model or block parameter, or block dialog box parameter. | Returns the value of the specified model or block parameter. If you specified multiple blocks as a cell array, returns a cell array with the values of the specified parameter common to all blocks. All of the specified blocks in the cell array must contain the parameter, otherwise the function returns an error. |

Example: 'ObjectParameters'

Data Types: char

Output Arguments

ParamValue — The name or value of the specified parameter for the specified model or block, or root

any data type, depending on the parameter

The name or value of the specified parameter for the specified model or block, or root. If you specify multiple objects, the output is a cell array of objects. The table shows special cases.

| Specified Parameter | ParamValue Returned |
|-----------------------------------|--|
| 'ObjectParameters' | A structure array with the parameter names of the specified object (model, block, or root) as separate fields in the structure. |
| 'DialogParameters' | A structure array with the block dialog box parameter names as separate fields in the structure. If the block has a mask, the function instead returns the mask parameters. |
| Parameter name, e.g., 'BlockType' | The value of the specified model or block parameter. If multiple blocks are specified as a cell array, returns a cell array with the values of the specified parameter common to all blocks. |

If you get the root parameters by specifying `get_param(0, 'ObjectParameters')`, then the output `ParamValue` is a structure array with the root parameter names as separate fields in the structure. Each parameter field is a structure containing these fields:

- **Type** — Parameter type values are: 'boolean', 'string', 'int', 'real', 'point', 'rectangle', 'matrix', 'enum', 'ports', or 'list'
- **Enum** — Cell array of enumeration character vector values that applies only to 'enum' parameter types
- **Attributes** — Cell array of character vectors defining the attributes of the parameter. Values are: 'read-write', 'read-only', 'read-only-if-compiled', 'write-only', 'dont-eval', 'always-save', 'never-save', 'nondirty', or 'simulation'

See Also

`set_param` | `getSimulinkBlockHandle` | `find_system` | `gcb` | `gcs` | `bdroot`

Topics

“Associating User Data with Blocks”

“Use MATLAB Commands to Change Workspace Data”

“Block-Specific Parameters” on page 6-26

“Common Block Properties” on page 6-12

Introduced before R2006a

getActiveConfigSet

Get active configuration set or configuration reference of model

Syntax

```
getActiveConfigSet(model)
```

Description

`getActiveConfigSet(model)` returns the active configuration object of the model as a `ConfigSet` object or a `Simulink.ConfigSetRef` object.

Examples

Get Active Configuration Set

Get the active configuration set for a model that is open.

Open the model `vdp` and get the active configuration set.

```
vdp  
vdpConfig = getActiveConfigSet('vdp');
```

Input Arguments

model — Name of model

character vector | string scalar

Name of model, specified as a character vector or string scalar. The model must be open.

Example: `'vdp'`

See Also

[setActiveConfigSet](#) | [attachConfigSet](#) | [attachConfigSetCopy](#) | [detachConfigSet](#)

Topics

“Manage Configuration Sets for a Model”

Introduced before R2006a

getCallbackAnnotation

Get annotation executing callback

Syntax

```
ann = getCallbackAnnotation
```

Description

`ann = getCallbackAnnotation` gets the annotation from which a callback was invoked. Invoke a callback from an annotation click function. After you get the annotation, you can, for example, get text or parameters from the annotation to use someplace else in your model.

For information on click functions, see “Make Annotations Interactive”.

Examples

Click Annotation to Change Parameter Value

Invoke a callback by way of an annotation click function. This example shows how to change a parameter value on a block to the value shown on an annotation.

Open `vdp`. Add and position two annotations. Each annotation displays a different value.

```
open_system('vdp');  
an1 = Simulink.Annotation('vdp/1');  
an1.position = [100,300];  
an2 = Simulink.Annotation('vdp/3');  
an2.position = [150,300];
```

Assign a click function to each annotation. The click function uses `getAnnotationCallback` to get the annotation instance. Get the text from each annotation and use it to set the parameter on the Gain block (Mu).

```
an1.ClickFcn = 'ann = getCallbackAnnotation; v = ann.Text; set_param(''vdp/Mu'', ''Gain'', v)';  
an2.ClickFcn = 'ann = getCallbackAnnotation; v = ann.Text; set_param(''vdp/Mu'', ''Gain'', v)';
```

Click each annotation. When you click, the gain value on the Mu block changes to the number shown on the annotation.

Output Arguments

ann — Annotation

`Simulink.Annotation` instance

Annotation, returned as a `Simulink.Annotation` instance.

See Also

Simulink.Annotation

Topics

“Describe Models Using Notes and Annotations”

Introduced before R2006a

getConfigSet

Get configuration set or configuration reference from model

Syntax

```
myConfigObj = getConfigSet(model, configObjName)
```

Description

`myConfigObj = getConfigSet(model, configObjName)` returns the configuration set or configuration reference that is attached to `model` and is named `configObjName`.

Examples

Get a Configuration Set

Get a configuration set for a model that is open.

Open the model `vdp` and get the configuration set `Configuration`.

```
vdp  
vdpConfig = getConfigSet('vdp','Configuration');
```

Input Arguments

model — Name of model

character vector | string scalar

Name of model, specified as a character vector or string scalar. The model must be open.

Example: `'vdp'`

configObjName — Configuration object

character vector | string scalar

Name of the configuration object, specified as a character vector or string scalar.

Example: `'Configuration'`

Output Arguments

myConfigObj — Configuration object

`ConfigSet` object | `ConfigSetRef` object

The configuration object, returned as a `ConfigSet` object or a `Simulink.ConfigSetRef` object. If no such object exists, the function returns an empty object.

See Also

`setActiveConfigSet` | `attachConfigSet` | `attachConfigSetCopy` | `detachConfigSet`

Topics

“Manage Configuration Sets for a Model”

Introduced before R2006a

getConfigSets

Get names of all of model's configuration sets or configuration references

Syntax

```
myConfigObjNames = getConfigSets(model)
```

Description

`myConfigObjNames = getConfigSets(model)` returns the names of the configuration objects that are attached to the model. You can use the returned name of a configuration set from `myConfigObjNames` to activate it for the model.

Examples

Get Names of Configurations for a Model

Get the names of the configuration sets and configuration references that are attached to a model.

Open the model `sldemo_fuelsys_dd_controller` and get the configuration object names.

```
sldemo_fuelsys_dd_controller
configObjNames = getConfigSets('sldemo_fuelsys_dd_controller')

configObjNames =

    1×1 cell array

    {'ModelReferencing'}
```

The model has one configuration set with the name `ModelReferencing`.

Input Arguments

model — Name of model

character vector | string scalar

Name of model, specified as a character vector or string scalar. The model must be open.

Example: `'vdp'`

Output Arguments

myConfigObjNames — Names of configuration objects

cell array of character vectors

Names of the configuration objects that are attached to the model, returned as a cell array of character vectors. The configuration objects include configuration sets and configuration references.

See Also

[setActiveConfigSet](#) | [detachConfigSet](#) | [ConfigSet](#) | [Simulink.ConfigSetRef](#)

Topics

“Manage Configuration Sets for a Model”

Introduced before R2006a

getfullname

Get path that identifies block or line

Syntax

```
path = getfullname(handle)
```

Description

`path = getfullname(handle)` returns the full path that identifies the block or line specified by `handle`. If you specify multiple block or line handles, the function returns a cell array of paths.

Examples

Get Path That Identifies Block

Open the vdp model.

```
vdp
```

Interactively, select the block named Mu.

Get the path that identifies the currently selected block.

```
blkpath = getfullname(gcf)
```

```
blkpath =  
    'vdp/Mu'
```

Get Path That Identifies Line

Open the vdp model.

```
vdp
```

Interactively, select the output line from the block named Mu.

Get the handle associated with the currently selected line.

```
line = find_system(gcf, 'SearchDepth', 1, 'FindAll', 'on', ...  
    'Type', 'line', 'Selected', 'on');
```

Get the path that identifies the currently selected line.

```
linepath = getfullname(line)
```

```
linepath =  
    'vdp/Mu/1'
```

The path describes the source port of the line.

Input Arguments

handle — Block or line

handle | cell array of handles

Block or line, specified as a handle or cell array of handles.

Example: `getfullname(gcf)`

Example: `getfullname({handle1,handle2})`

Data Types: double | cell

See Also

`gcb` | `find_system`

Introduced in R2007a

getGlobalArg

Package: Simulink.CustomCode

Get an object definition of a global variable in a C Caller block

Syntax

```
GlobalArg = PortSpecObj.getGlobalArg(globalVariableName)
```

Description

GlobalArg = PortSpecObj.getGlobalArg(globalVariableName), where PortSpecObj is an object of class FunctionPortSpecification or Simulink.CodeImporter.SimulinkPortSpecification, creates a FunctionArgument on page 8-41 object. To use global variables in a model that uses C Caller blocks, turn on the **Enable custom code globals as function interface** setting from **Configuration Parameters > Simulation Target**.

Examples

Create Handle to Global Variable in C Caller Block

Access the properties of a global variable used in a C Caller block.

Create a FunctionPortSpecification object.

```
myFunctionPortSpecObject = get_param(gcb, 'FunctionPortSpecification')
```

Query and create a FunctionArgument object for the global argument.

```
myGlobalVariable = myFunctionPortSpecObject.getGlobalArg('myGlobalVariableName')
```

```
myGlobalVariable =
```

```
FunctionArgument with properties:
```

```
    Name: 'myGlobalVarPort'
PortNumber: 1
    Size: '1'
    Type: 'double'
    Label: 'myGlobalVarPort'
    Scope: 'Input'
```

Input Arguments

globalVariableName — Name of global variable

character vector | string scalar

Name of global variable, specified as a character vector.

Data Types: char

Output Arguments

GlobalArg — Global argument object

FunctionArgument object

Global argument object associated with the C Caller block, returned as a FunctionArgument object.

See Also

C Caller | FunctionPortSpecification |

Simulink.CodeImporter.SimulinkPortSpecification

Topics

“Integrate C Code Using C Caller Blocks”

Introduced in R2020b

getInputString

Create comma-separated list of variables to map

Syntax

```
externalInputString = getInputString(inputmap, 'base')
```

```
externalInputString = getInputString(inputmap, filename)
```

```
externalInputString = getInputString(inputmap)
```

Description

`externalInputString = getInputString(inputmap, 'base')` creates an input character vector using the supplied mapping `inputmap` and the variables loaded in the base workspace ('base').

This function generates a comma-separated list of variables (input character vector) to be mapped. You can then use this list:

- As input to the `sim` command. Load the variables in the base workspace first.
- As input for the **Configuration Parameters > Data Import/Export > Input** parameter. Copy the contents of the input character vector into the text field.

This function is most useful if you have created a custom mapping.

`externalInputString = getInputString(inputmap, filename)` creates an input character vector using the supplied mapping `inputmap` and the variables defined in `filename`.

`externalInputString = getInputString(inputmap)` creates an input character vector using the signals from the most recently created mapping.

Examples

Create an input character vector from the base workspace

Create an input character vector from the base workspace and simulate a model.

Open the model

```
slexAutotransRootInportsExample;
```

Create signal variables in the base workspace

```
Throttle = timeseries(ones(10,1)*10);
Brake     = timeseries(zeros(10,1));
```

Create a mapping (`inputMap`) for the model.

```
inputMap = getRootInportMap('model', ...
    'slexAutotransRootInportsExample', ...
```



```
'signalName', {'Throttle', 'Brake'}, ...
'blockName', {'Throttle', 'Brake'});
```

Call `getInputString` with `inputMap` and `'base'` as inputs.

```
externalInputString = getInputString(inputMap, 'base')
```

```
externalInputString =
```

```
Throttle, Brake
```

Simulate the model with the input character vector.

```
sim('slexAutotransRootInportsExample', 'ExternalInput', ...
externalInputString);
```

Create an external input character vector from variables in a MAT-file

Create an external input character vector from variables in a MAT-file named `input.mat`.

In a writable folder, create a MAT-file with input variables.

```
Throttle = timeseries(ones(10,1)*10);
Brake    = timeseries(zeros(10,1));
save('input.mat', 'Throttle', 'Brake');
```

Open the model.

```
slexAutotransRootInportsExample;
```

Create map object.

```
inputMap = getRootInportMap('model', ...
'slexAutotransRootInportsExample', ...
'signalName', {'Throttle', 'Brake'}, ...
'blockName', {'Throttle', 'Brake'});
```

Get the resulting input character vector.

```
externalInputString = getInputString(inputMap, 'input.mat')
```

```
externalInputString =
```

```
Throttle, Brake
```

Load variables from the base workspace for the simulation.

```
load('input.mat');
```

Simulate the model.

```
sim('slexAutotransRootInportsExample', 'ExternalInput', ...
externalInputString);
```

Create an external input character vector from only an input map

Create an input character vector from only an input map vector and simulate the model.

Open the model.

```
slexAutotransRootInportsExample;
```

Create signal variables in the base workspace

```
Throttle = timeseries(ones(10,1)*10);
Brake     = timeseries(zeros(10,1));
```

Create a mapping vector for the model.

```
inputMap = getSIRootInportMap('model', 'slexAutotransRootInportsExample', ...
'MappingMode', 'BlockName', ...
'signalName', {'Throttle', 'Brake'}, ...
'signalValue', {Throttle, Brake});
```

Get the resulting input character vector.

```
externalInputString = getInputString(inputMap)
```

Simulate the model with the input character vector.

```
sim('slexAutotransRootInportsExample', 'ExternalInput', ...
externalInputString);
```

Alternatively, if you want to input the list of variables through the Configuration Parameters dialog, copy the contents of `externalInputString` (Throttle, Brake) into the **Data Import/Export > Input** parameter. Apply the changes, and then simulate the model.

Input Arguments

inputmap — Map object

character vector

Map object, as returned from the `getRootInportMap` or `getSIRootInportMap` functions.

filename — Input variables

MAT-file name as character vector

Input variables, contained in a MAT-file. The file contains variables to map.

Example: 'data.mat'

Data Types: char

Output Arguments

externalInputString — External input

comma-separated character vector

External input, returned as a comma-separated character vector. The character vector contains root inport information that you can specify to the `sim` command or the **Configuration Parameters > Data Import/Export > Input** parameter.

See Also

getRootInportMap | getSlRootInportMap

Topics

“Map Root Inport Signal Data”

Introduced in R2013a

getReport

Package: Simulink

Generate MATLAB function report

Syntax

```
report = getReport(config)
```

Description

`report = getReport(config)` returns the `MATLABFunctionReport` object for a MATLAB Function block. Use the `MATLABFunctionReport` object to access information about the functions and variables used by the MATLAB Function block.

Examples

Create Custom Report for MATLAB Function Block

Access the `MATLABFunctionConfiguration` object for the MATLAB Function block in the model `call_stats_block1` described in “Create Custom Functionality Using MATLAB Function Blocks”.

```
config = get_param('call_stats_block1/MATLAB Function', ...
    'MATLABFunctionConfiguration');
```

Create the `MATLABFunctionReport` object for the MATLAB Function block.

```
report = getReport(config);
```

Access the `coder.Function` objects in the report.

```
functions = report.Functions;
```

Create a custom report that lists the functions and variables in the MATLAB Function block.

```
for i = 1:numel(functions)
    fprintf('Function %s uses these variables:\n', functions(i).Name)
    variables = functions(i).Variables;
    for j = 1:numel(variables)
        fprintf('%d. %s -- %s\n', j, variables(j).Name, variables(j).Scope)
    end
    fprintf('\n')
end
```

```
Function stats uses these variables:
```

```
1. mean -- Output
2. stdev -- Output
3. vals -- Input
4. len -- Local
```

```
Function avg uses these variables:
```

1. mean -- Output
2. array -- Input
3. size -- Input

Input Arguments

config — MATLAB Function block property configuration

MATLABFunctionConfiguration object

MATLAB Function block property configuration, specified as a MATLABFunctionConfiguration object.

Tips

The first time that you create a MATLABFunctionReport object or open the MATLAB function report, Simulink automatically updates your model. If you make subsequent changes to the MATLAB code in the block, you must update your model before you generate a new MATLABFunctionReport object. Otherwise, the object does not reflect your changes. From the **Modeling** tab, select **Update Model**, or press **Ctrl+D**. For more information, see “Update Diagram and Run Simulation”.

See Also

MATLAB Function | MATLABFunctionConfiguration | MATLABFunctionReport | coder.Function Properties

Topics

“MATLAB Function Reports”

“Create Custom Functionality Using MATLAB Function Blocks”

Introduced in R2021a

getRootInportMap

Create custom object to map signals to root-level inports

Syntax

```
map = getRootInportMap('Empty');
map = getRootInportMap(model,mdl,Name,Value);
map = getRootInportMap(inputmap,map,Name,Value);
```

Description

`map = getRootInportMap('Empty');` creates an empty map object, *map*. Use this map object to set up an empty custom mapping object. Load the model before using this function. If you do not load the model first, the function loads the model to make the mapping and then closes the model afterwards.

`map = getRootInportMap(model,mdl,Name,Value);` creates a map object for *model*, *mdl*, with block names and signal names specified. Load the model before using this function. If you do not load the model first, the function loads the model to make the mapping and then closes the model afterwards. To create a comma-separated list of variables to map from this object, use the `getInputString` function.

`map = getRootInportMap(inputmap,map,Name,Value);` overrides the mapping object with the specified property. You can override only the properties *model*, *blockName*, and *signalName*. Load the model before using this function. If you do not load the model first, the function loads the model to make the mapping and then closes the model afterwards. To create a comma-separated list of variables to map from this object, use the `getInputString` function.

Use the `getRootInportMap` function when creating a custom mapping mode to map data to root-level inports. See the example file `BlockNameIgnorePrefixMap.m`, located in `matlabroot/help/toolbox/simulink/examples`, for an example of a custom mapping algorithm.

Input Arguments

Empty

Create an empty map object.

Default: none

Name-Value Pair Arguments

Specify optional comma-separated pairs of *Name*, *Value* arguments. *Name* is the argument name and *Value* is the corresponding value. *Name* must appear inside quotes. You can specify several name and value pair arguments in any order as *Name1*, *Value1*, ..., *NameN*, *ValueN*.

model

Name of model to associate with the root inport map.

Default: None

blockName

Block names of root-level input ports. The tool assigns data to ports according to the name of the root-inport block. If the tool finds a data element whose name matches the name of a root-inport block, it maps the data to the corresponding port.

The value for this argument can be:
 Block name of root-level input ports.
 Cell array containing multiple block names of root-level input ports.

Default: None

signalName

Signal names to be mapped. The tool assigns data to ports according to the name of the signal on the port. If the tool finds a data element whose name matches the name of a signal at a port, it maps the data to the corresponding port.

The value for this argument can be:
 Signal name to be mapped.
 Cell array containing multiple signal names of signals to be mapped.

Default: None

inputmap

Name of mapping object to override.

Default: None

Output Arguments

map

Custom object that you can use to map data to root-level input port. To create a comma-separated list of variables to map from this object, use the `getInputString` function.

Examples

Empty Mapping Object

Create an empty custom mapping object.

```
map = getRootInportMap('Empty')
```

```
map =
```

```
1x0 InputMap array with properties:
```

```
Type
```

```
DataSourceName
Destination
```

Simple Mapping Object

Create a simple mapping object using a MATLAB time series object.

Create a time series object, `signalIn1`.

```
signalIn1 = timeseries((1:10)')
```

Common Properties:

```
Name: 'unnamed'
Time: [10x1 double]
TimeInfo: [1x1 tsdata.timemetadata]
Data: [10x1 double]
DataInfo: [1x1 tsdata.datametadata]
```

Create a mapping object for the time series object for the model, `ex_minportsOnlyModel`.

```
modelFile = fullfile(matlabroot,'help','toolbox','simulink',...
'examples','ex_minportsOnlyModel');
load_system(modelFile);
map = getRootInportMap('model','ex_minportsOnlyModel',...
'blockName','In1','signalname','signalIn1')
```

```
map =
```

```
InputMap with properties:
```

```
Type: 'Inport'
DataSourceName: 'signalIn1'
Destination: [1x1 Simulink.iospecification.Destination]
```

Mapping Object with Vectors

Create a mapping object using vectors of block names and signal names for the model `ex_minportsOnlyModel`.

Create a mapping object of vectors.

```
modelFile = fullfile(matlabroot,'help','toolbox','simulink',...
'examples','ex_minportsOnlyModel');
load_system(modelFile);
map = getRootInportMap('model','ex_minportsOnlyModel',...
'blockName',{'In1' 'In2'}, ...
'signalname',{'signalIn1' 'signalIn2'})
```

```
map =
```

```
1x2 InputMap array with properties:
```

```
Type
```



```
DataSourceName
Destination
```

Overriding Maps

Create a mapping object that contains the signal *var2*, then override *var2* with *var1*.

Create a mapping object of vectors.

```
% Load the model and define variables
modelFile = fullfile(matlabroot,'help','toolbox','simulink',...
'examples','ex_minportsOnlyModel');
load_system(modelFile);
modelValue = 'ex_minportsOnlyModel';
blockNameValue = 'In1';
signalNameValue = 'var2';
portType = 'Inport';
```

```
% Define var1 and override var2 with var1
signalNameToOverload = 'var1';
mapToOverload = getRootInportMap('model',modelValue,...
'blockName',blockNameValue,...
'signalName',signalNameToOverload)
```

```
mapToOverload =
```

```
InputMap with properties:
```

```
    Type: 'Inport'
DataSourceName: 'var1'
Destination: [1x1 Simulink.iospecification.Destination]
```

Tips

- Load the model before running this function.
- If your custom mapping mode similar to an existing Simulink mapping mode, consider using the `getSlRootInportMap` function instead.

See Also

`getInputString` | `getSlRootInportMap`

Topics

“Create Custom Mapping File Function”

Introduced in R2012b

getSimulinkBlockHandle

Get block handle from block path

Syntax

```
handle = getSimulinkBlockHandle(path)
handle = getSimulinkBlockHandle(path,true)
```

Description

`handle = getSimulinkBlockHandle(path)` returns the numeric handle of the block specified by `path`, if it exists in a loaded model or library. Returns -1 if the block is not found. Library links are resolved where necessary.

Use the numeric handle returned by `getSimulinkBlockHandle` to manipulate the block in subsequent calls to `get_param` or `set_param`. This approach is more efficient than making multiple calls to these functions using the full block path. Do not try to use the number of a handle alone (e.g., 5.0007) because you usually need to specify many more digits than MATLAB displays. Assign the handle to a variable and use that variable name to specify a block. The handle applies only to the current MATLAB session.

Use `getSimulinkBlockHandle` to check whether a block path is valid. This approach is more efficient than calling `get_param` inside a `try` statement.

`handle = getSimulinkBlockHandle(path,true)` attempts to load the model or library containing the specified block path, and then checks if the block exists. No error is returned if the model or library is not found. Any models or libraries loaded this way remain in memory even if the function does not find a block with the specified path.

Examples

Get the Handle of a Block

Get the handle of the Pilot block.

```
load_system('f14')
handle = getSimulinkBlockHandle('f14/Pilot')
```

```
handle =
    562.0004
```

You can use the handle in subsequent calls to `get_param` or `set_param`.

Load the Model and Get the Block Handle

Load the model `f14` if necessary (by specifying `true`), and get the handle of the `Pilot` block.

```
handle = getSimulinkBlockHandle('f14/Pilot',true)
handle =
    562.0004
```

You can use the handle in subsequent calls to `get_param` or `set_param`.

Check If a Model Contains a Specific Block

Check whether the model `f14` is loaded and contains a block named `Pilot`. Valid handles are always greater than zero. If the function does not find the block, it returns `-1`.

```
valid_block_path = getSimulinkBlockHandle('f14/Pilot') > 0
valid_block_path =
    0
```

The model contains the block but the model is not loaded, so this command returns `0` because it cannot find the block.

Using `getSimulinkBlockHandle` to check whether a block path is valid is more efficient than calling `get_param` inside a `try` statement.

Input Arguments

path — Block path name

character vector | cell array of character vectors

Block path name, specified as a character vector or a cell array of character vectors.

Example: 'f14/Pilot'

Data Types: char

Output Arguments

handle — Numeric handle of a block

double | array of doubles

Numeric handle of a block, returned as a double or an array of doubles. Valid handles are always greater than zero. If the function does not find the block, it returns `-1`. If the `path` input is a cell array of character vectors, then the output is a numeric array of handles.

Data Types: double

See Also

`get_param` | `set_param`

Introduced in R2015a

getSlRootInportMap

Create custom object to map signals to root-level inports using Simulink mapping mode

Syntax

```
inputMap = getSlRootInportMap('model',modelname,'MappingMode',
mappingmode,'SignalName',signalname,'SignalValue',signalvalue)
[inputMap, hasASignal] = getSlRootInportMap('model',modelname,'MappingMode',
mappingmode,'SignalName',signalname,'SignalValue',signalvalue)
```

```
inputMap = getSlRootInportMap('model',
modelname,'MappingMode','Custom','CustomFunction',
customfunction,'SignalName',signalname,'SignalValue',signalvalue)
[inputMap,hasASignal] = getSlRootInportMap('model',
modelname,'MappingMode','Custom','CustomFunction',
customfunction,'SignalName',signalname,'SignalValue',signalvalue)
```

Description

`inputMap = getSlRootInportMap('model',modelname,'MappingMode', mappingmode,'SignalName',signalname,'SignalValue',signalvalue)` creates a root inport map using one of the Simulink mapping modes. Load the model before using this function. If you do not load the model first, the function loads the model to make the mapping and then closes the model afterwards. To create a comma-separated list of variables to map from this object, use the `getInputString` function.

`[inputMap, hasASignal] = getSlRootInportMap('model',modelname,'MappingMode', mappingmode,'SignalName',signalname,'SignalValue',signalvalue)` returns a vector of logical values specifying whether or not the root inport map has a signal associated with it. To create a comma-separated list of variables to map from this object, use the `getInputString` function.

`inputMap = getSlRootInportMap('model', modelname,'MappingMode','Custom','CustomFunction', customfunction,'SignalName',signalname,'SignalValue',signalvalue)` creates a root inport map using a custom mapping mode specified in `customfunction`. Load the model before using this function. If you do not load the model first, the function loads the model to make the mapping and then closes the model afterwards. To create a comma-separated list of variables to map from this object, use the `getInputString` function.

`[inputMap,hasASignal] = getSlRootInportMap('model', modelname,'MappingMode','Custom','CustomFunction', customfunction,'SignalName',signalname,'SignalValue',signalvalue)` returns a vector of logical values specifying whether or not the root inport map has a signal associated with it. To create a comma-separated list of variables to map from this object, use the `getInputString` function.

To map signals to root-level inports using custom mapping modes, you can use `getSlRootInport` with the Root Inport Mapper dialog box custom mapping capability.

Examples

Create inport map using Simulink mapping mode

Create a vector of inport maps using a built-in mapping mode.

```
Throttle = timeseries(ones(10,1)*10);
Brake    = timeseries(zeros(10,1));
inputMap = getSlRootInportMap('model','slexAutotransRootInportsExample',...
    'MappingMode','BlockName', ...
    'SignalName',{'Throttle' 'Brake'},...
    'SignalValue',{Throttle Brake});
```

Create inport map using custom function

Create a vector of inport maps using a custom function

```
port1    = timeseries(ones(10,1)*10);
port2    = timeseries(zeros(10,1));
inputMap = getSlRootInportMap('model','slexAutotransRootInportsExample',...
    'MappingMode','Custom', ...
    'CustomFunction','slexCustomMappingMyCustomMap',...
    'SignalName',{'port1' 'port2'},...
    'SignalValue',{port1 port2});
```

Input Arguments

modelName — Model name

character vector

Specify the model to associate with the root inport map.

Data Types: char

mappingmode — Simulink mapping mode

character vector

Specify the mapping mode to use with model name and data source. Possible values are:

| | |
|--------------|---|
| 'Index' | Assign sequential index numbers, starting at 1, to the data in the MAT-file, and map this data to the corresponding inport. |
| 'BlockName' | Assign data to ports according to the name of the root-inport block. If the block name of a data element matches the name of a root-inport block, map the data to the corresponding port. |
| 'SignalName' | Assign data to ports according to the name of the signal on the port. If the signal name of a data element matches the name of a signal at a port, map the data to the corresponding port. |
| 'BlockPath' | Assign data to ports according to the block path of the root-inport block. If the block path of a data element matches the block path of a root-inport block, map the data to the corresponding port. |
| 'Custom' | Apply mappings according to the definitions in a custom file. |

Data Types: char

customfunction — Custom function file name

character vector

Specify name of file that implements a custom method to map signals to root-level ports. This function must be on the MATLAB path.

Data Types: `char`**signalname — signal name**

scalar | cell array of character vectors

Specify the signal name(s) of the signal to associate with the root inport map.

Data Types: `char` | `cell`**signalvalue — signal value**

scalar | cell arrays

Specify the values of the signals to map to the root inport map. For the list of supported data types for the values, see “Choose a Base Workspace and MAT-File Format”.

Output Arguments

inputMap — input map

scalar | vector

Mapping object that defines the mapping of input signals to root-level ports. To create a comma-separated list of variables to map from this object, use the `getInputString` function.

hasASignal — signal presence indicator

scalar | vector

A vector of logical values with the same length as `inputMap`. If the value is true the `inputMap` has a signal associated with it. If the value is false the `inputMap` does not have a signal associated with it and will use a ground value as an input

Data Types: `logical`

Tips

- Load the model before running this function.
- If your custom mapping mode is not similar to an existing Simulink mapping mode, consider using the `getRootInportMap` function instead.

See Also

`getRootInportMap` | `getInputString`

Topics

“Map Root Inport Signal Data”

Introduced in R2013b

hdlLib

Display blocks that are compatible with HDL code generation

Syntax

```
hdlLib
hdlLib('off')
hdlLib('html')
hdlLib('librarymodel')
```

Description

`hdlLib` displays the blocks that are supported for HDL code generation, and for which you have a license, in the Library Browser. To build models that are compatible with the HDL Coder software, use blocks from this Library Browser view.

If you close and reopen the Library Browser in the same MATLAB session, the Library Browser continues to show only the blocks supported for HDL code generation. To show all blocks, regardless of HDL code generation compatibility, at the command prompt, enter `hdlLib('off')`.

`hdlLib('off')` displays all the blocks for which you have a license in the Library Browser, regardless of HDL code generation compatibility.

`hdlLib('html')` creates a library of blocks that are compatible with HDL code generation. It generates two additional HTML reports: a categorized list of blocks (`hdlblklist.html`) and a table of blocks and their HDL code generation parameters (`hdlsupported.html`).

To run `hdlLib('html')`, you must have an HDL Coder license.

`hdlLib('librarymodel')` displays blocks that are compatible with HDL code generation in the Library Browser. To build models that are compatible with the HDL Coder software, use blocks from this library.

The default library name is `hdlsupported`. After you generate the library, you can save it to a folder of your choice.

To keep the library current, you must regenerate it each time that you install a new software release.

To run `hdlLib('librarymodel')`, you must have an HDL Coder license.

Examples

Display Supported Blocks in the Library Browser

To display blocks that are compatible with HDL code generation in the Library Browser:

```
hdlLib
### Generating view of HDL Coder compatible blocks in Library Browser.
### To restore the Library Browser to the default Simulink view, enter "hdlLib off".
```

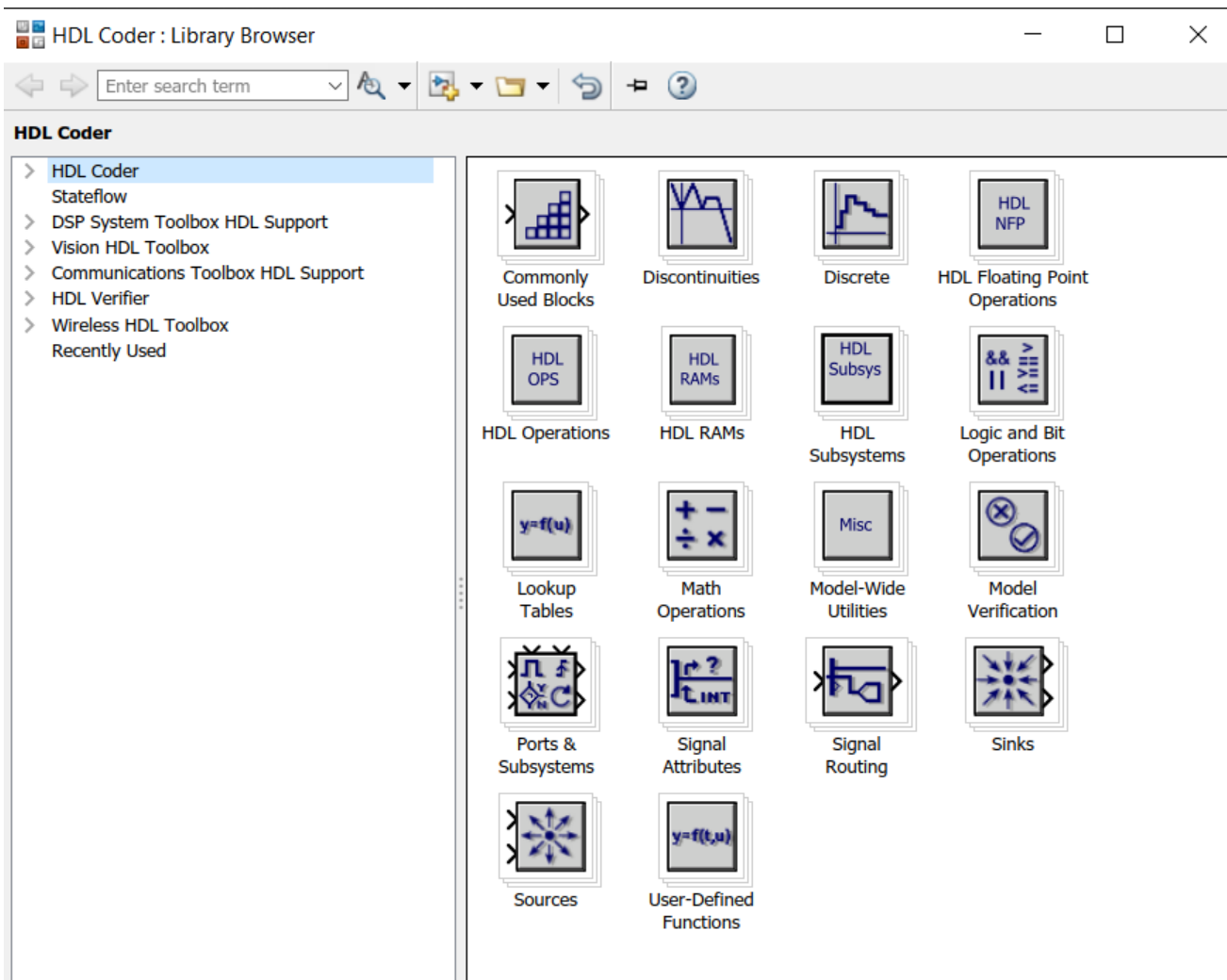

Display All Blocks in the Library Browser

To restore the Library Browser to the default view, in the Library Browser, click the  button. Alternatively, at the command line, enter:

```
hdllib('off')
```

Restoring Library Browser to default view; removing the HDL Coder compatibility filter.

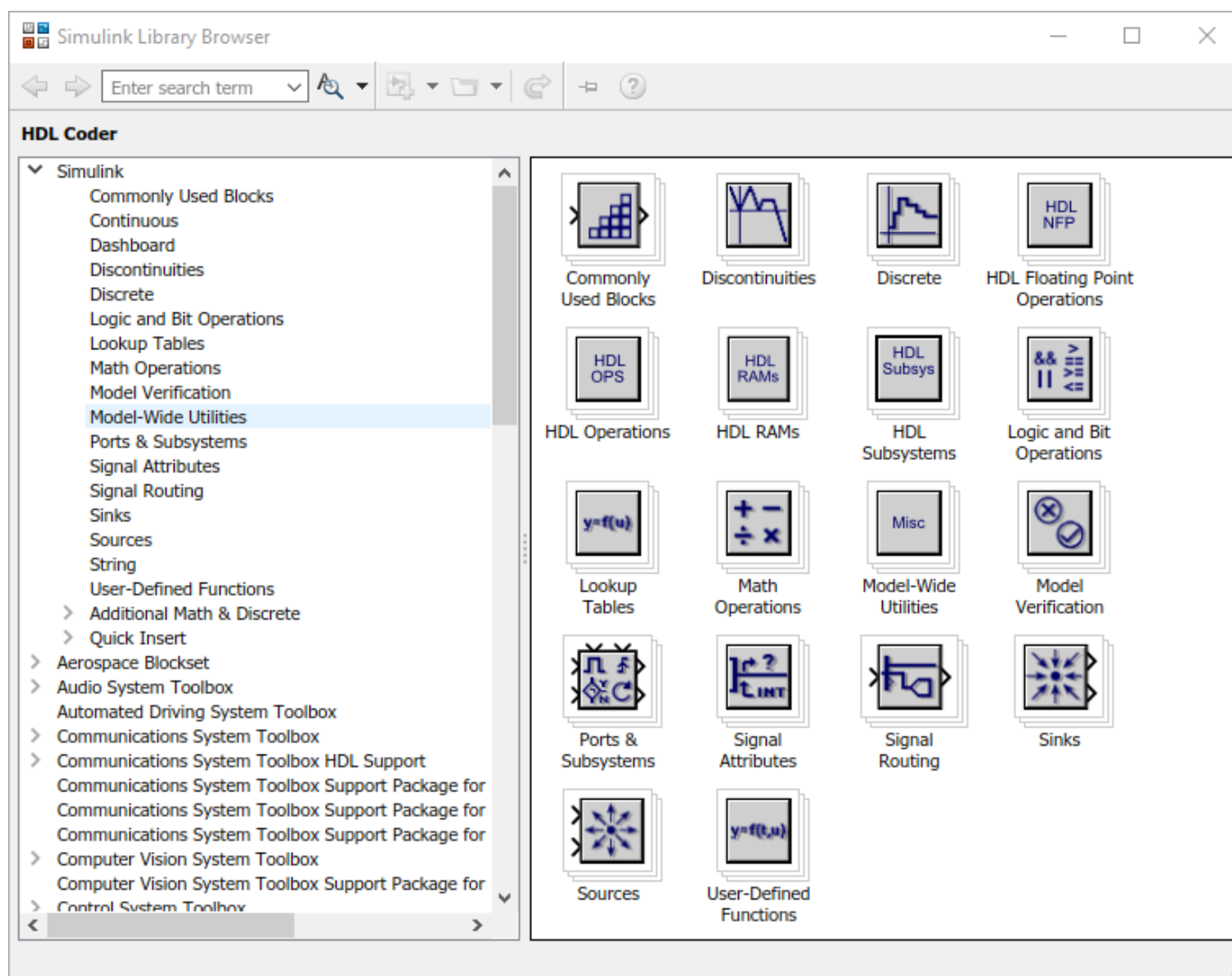

Create a Supported Blocks Library and HTML Reports

To create a library and HTML reports showing the blocks that are compatible with HDL code generation:

```
hdlLib('html')
```

```
### HDL supported block list hdlblklist.html
### HDL implementation list hdl-supported.html
```

The `hdl-supported` library opens. To view the reports, click the `hdlblklist.html` and `hdl-supported.html` links.

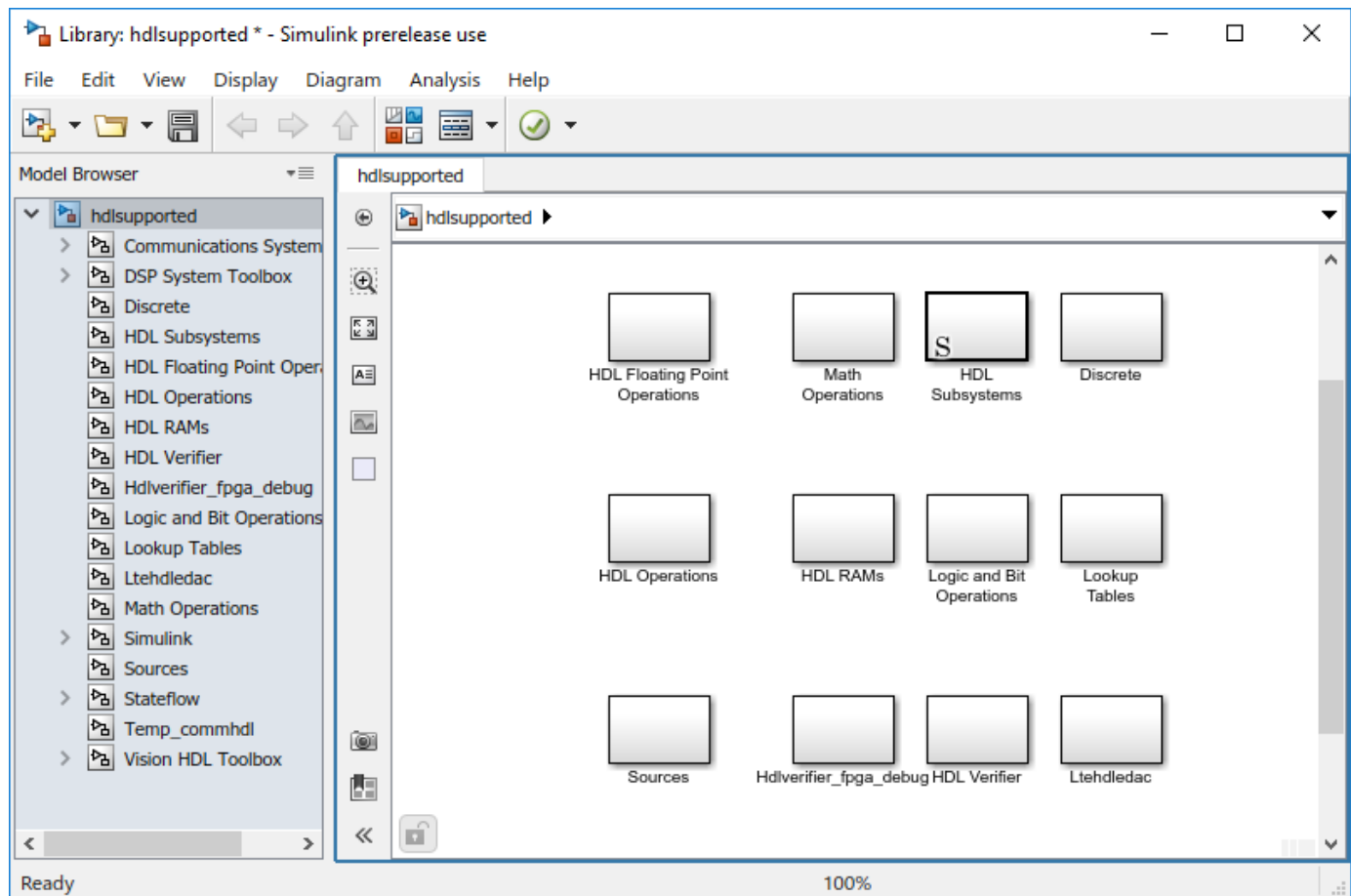

Create a Supported Blocks Library

To create a library that contains blocks that are compatible with HDL code generation:

```
hdllib('librarymodel')
```

The `hdl_supported` block library opens.

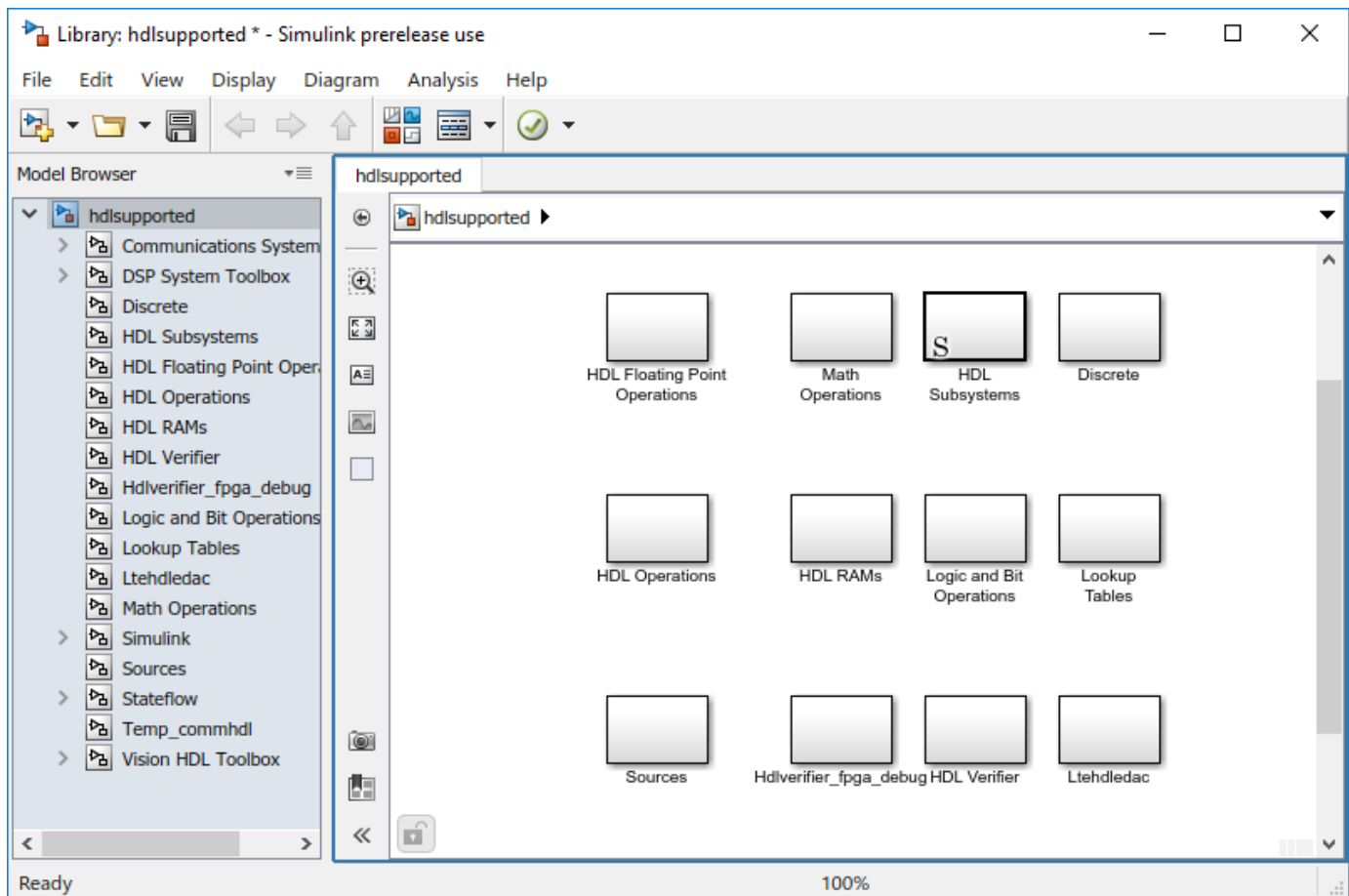

See Also

Topics

- “Display Blocks for HDL Code Generation in Library Browser” (HDL Coder)
- “View HDL-Supported Blocks and HDL-Specific Block Documentation” (HDL Coder)
- “Create HDL-Compatible Simulink Model” (HDL Coder)

Introduced in R2006b

hilite_system

Highlight block, signal line, port, or annotation

Syntax

```
hilite_system(obj)  
hilite_system(obj,style)
```

Description

`hilite_system(obj)` highlights a block, line, port, or annotation in an open model using the default highlight style. Use `hilite_system` with a port to highlight the signal line attached to the port. Each use of `hilite_system` adds to the highlighting. Highlighting is not saved with the model.

`hilite_system(obj,style)` uses the specified highlighting style.

Examples

Highlight Block Using Default Highlight Style

Open the model `slexAircraftExample`.

```
openExample('slexAircraftExample')
```

Highlight the Controller block. When you use the default highlight style, the block appears highlighted with a red outline and yellow fill.

```
hilite_system('slexAircraftExample/Controller')
```

Highlight a Block Using a Highlight Style

Open the model `vdp`.

```
vdp
```

Highlight the Mu block using the style 'fade'.

```
hilite_system('vdp/Mu','fade')
```

Use Block Highlighting to Trace Generated Code

If you have a Simulink Coder license, you can trace generated code to the corresponding source block in a model.

Open the model `f14`.

```
f14
```

In the model configuration parameters, in the **Solver** pane, set **Type** to Fixed-step.

Generate code for the model. In the **Apps** tab, under **Code Generation**, click **Embedded Coder**. The **C Code** tab appears. Click **Build**.

In an editor or in the code generation report, open a generated source or header file. As you review lines of code, note traceability tags that correspond to code of interest.

Highlight a block using a traceability tag.

```
hilite_system('<Root>/Stick Input')
```

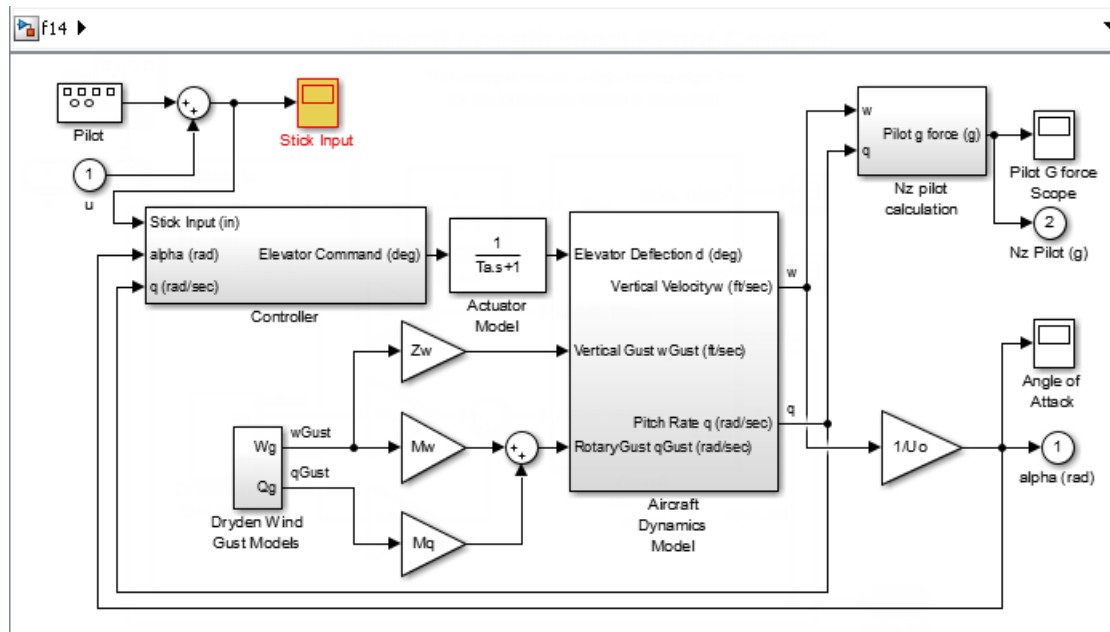

Highlight a block in a subsystem.

```
hilite_system('<S3>/W-gust model')
```

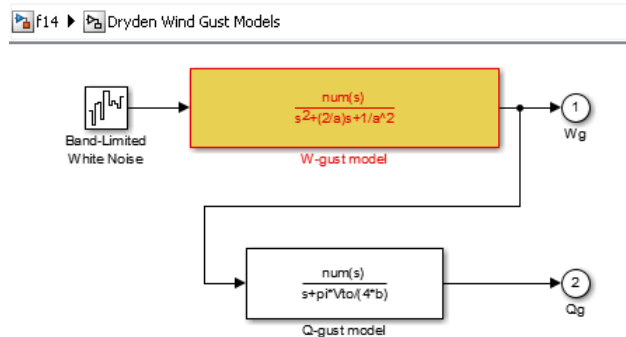

Customize a Highlighting Style

You can customize a highlighting style by setting the 'HiliteAncestorsData' parameter on the root-level model using `set_param` in this form:

```
set_param(0, 'HiliteAncestorsData', hiliteData)
```

Specify `hiliteData` as a structure array that has these fields:

- 'HiliteType' — Highlighting style to customize, such as 'user1', 'debug', or 'error'.
- 'ForegroundColor' — Color for block fill.
- 'BackgroundColor' — Color for block outline.

The supported values for 'ForegroundColor' and 'BackgroundColor' are:

- 'black'
- 'white'
- 'gray'
- 'red'
- 'orange'
- 'yellow'
- 'green'
- 'darkGreen'
- 'blue'
- 'lightBlue'
- 'cyan'
- 'magenta'

Define a highlight style for 'user1', and customize the style for 'debug'.

```
set_param(0, 'HiliteAncestorsData', ...
          struct('HiliteType', 'user1', ...
                'ForegroundColor', 'darkGreen', ...
                'BackgroundColor', 'lightBlue'));
set_param(0, 'HiliteAncestorsData', ...
          struct('HiliteType', 'debug', ...
                'ForegroundColor', 'red', ...
                'BackgroundColor', 'black'));
```

Use the defined style to highlight a block.

```
f14
hilite_system('f14/Controller/Alpha-sensor Low-pass Filter', 'user1')
```

Input Arguments

obj — Block, port, line, or annotation to highlight

block path name | Simulink.BlockPath object | numeric handle | Simulink identifier | traceability tag

Block, port, line, or annotation to highlight, specified as:

- The full block path name
- A Simulink.BlockPath object

- A numeric handle for lines, ports, or annotations
- Simulink identifier
- A traceability tag from the comments of Simulink Coder generated code.

Using a traceability tag requires a Simulink Coder license.

The format for a traceability tag is `<system>/block`, where `system` is either:

- Root
- A unique system number assigned by Simulink during code generation

Example: `'vdp/Mu'`, `'sldemo_fuelsys/fuel_rate_control/airflow_calc'`, `'vdp:3'`, `'<Root>/Mu'`

style — Highlighting style

`'default'` (default) | character vector

Highlighting style, specified as one of these values. You can customize the appearance of any of the styles. See “Customize a Highlighting Style” on page 2-315.

- `'default'` — Default color scheme: red outline, yellow fill.
- `'none'` — Clears the highlight.

To clear all highlighting, in the Simulink Editor, in the **Signal** tab, click **Remove Trace**.

- `'debug'` — Uses default color scheme.
- `'different'` — Applies red outline, white fill.
- `'error'` — Uses default color scheme.
- `'fade'` — Applies gray outline, white fill.
- `'find'` — Applies dark blue outline, blue fill.
- `'lineTrace'` — Applies red outline, blue fill.
- `'unique'` — Dark blue outline, white fill.
- `'user1'`, `'user2'`, `'user3'`, `'user4'`, `'user5'` — Applies custom highlight: black outline, white fill by default (i.e., no highlight).

In addition, you can use these color schemes. The first word is the outline and the second is the fill color.

- `'orangeWhite'`
- `'blackWhite'`
- `'redWhite'`
- `'blueWhite'`
- `'greenWhite'`

See Also

`rtwtrace` | `find_system`

Introduced before R2006a

isSimulinkStarted

Check whether Simulink is started

Syntax

```
tf = isSimulinkStarted
```

Description

`tf = isSimulinkStarted` returns whether Simulink is started.

Examples

Check Whether Simulink Is Started

```
isSimulinkStarted
```

```
ans =  
  
    logical  
  
     0
```

The returned value 0 indicates that Simulink is not started.

Start Simulink.

```
simulink
```

Confirm that Simulink is started.

```
isSimulinkStarted
```

```
ans =  
  
    logical  
  
     1
```

The returned value 1 indicates that Simulink is started.

Output Arguments

tf — True or false result

1 | 0

True or false result, returned as a 1 or 0 of data type `logical`.

- 1 (`true`) — Simulink is started.
- 0 (`false`) — Simulink is not started.

See Also

[bdIsLoaded](#) | [simulink](#) | [start_simulink](#)

Topics

[“Create a Simple Model”](#)

[“Build and Edit a Model Interactively”](#)

Introduced in R2020b

legacy_code

Use Legacy Code Tool

Syntax

```
legacy_code('help')
specs = legacy_code('initialize')
legacy_code('sfcn_cmex_generate', specs)
legacy_code('compile', specs, compilerOptions)
legacy_code('generate_for_sim', specs, modelName)
legacy_code('slblock_generate', specs, modelName)
legacy_code('sfcn_tlc_generate', specs)
legacy_code('sfcn_makecfg_generate', specs)
legacy_code('rtwmakecfg_generate', specs)
legacy_code('backward_compatibility')
```

Description

The `legacy_code` function creates a MATLAB structure for registering the specification for existing C or C++ code and the S-function being generated. In addition, the function can generate, compile and link, and create a masked block for the specified S-function. Other options include generating

- A TLC file for simulation in Accelerator mode or code generation
- An `rtwmakecfg.m` file that you can customize to specify dependent source and header files that reside in a different directory than that of the generated S-function

`legacy_code('help')` displays instructions for using Legacy Code Tool.

`specs = legacy_code('initialize')` initializes the Legacy Code Tool data structure, `specs`, which registers characteristics of existing C or C++ code and properties of the S-function that the Legacy Code Tool generates.

`legacy_code('sfcn_cmex_generate', specs)` generates an S-function source file as specified by the Legacy Code Tool data structure, `specs`.

`legacy_code('compile', specs, compilerOptions)` compiles and links the S-function generated by the Legacy Code Tool based on the data structure, `specs`, and compiler options that you might specify. The compiler options must be supported by the `mex` function.

`legacy_code('generate_for_sim', specs, modelName)` generates, compiles, and links the S-function in a single step. If the `Options.useTlcWithAccel` field of the Legacy Code Tool data structure is set to logical 1 (true), the function also generates a TLC file for accelerated simulations.

`legacy_code('slblock_generate', specs, modelName)` generates a masked S-Function block for the S-function generated by the Legacy Code Tool based on the data structure, `specs`. The block appears in the Simulink model specified by `modelName`. If you omit `modelName`, the block appears in an empty model editor window.

`legacy_code('sfcn_tlc_generate', specs)` generates a TLC file for the S-function generated by the Legacy Code Tool based on the data structure, `specs`. This option is relevant if you want to:

- Force Accelerator mode in Simulink software to use the TLC inlining code of the generated S-function. See the description of the `ssSetOptions` SimStruct function and `SS_OPTION_USE_TLC_WITH_ACCELERATOR` S-function option for more information.
- Use Simulink Coder software to generate code from your Simulink model. For more information, see “Import Calls to External Code into Generated Code with Legacy Code Tool” (Simulink Coder).

`legacy_code('sfcn_makecfg_generate', specs)` generates an `sFunction_makecfg.m` file for the S-function generated by the Legacy Code Tool based on the data structure, `specs`. If you use Simulink Coder to generate code from your Simulink model, you can use this option to specify additional items for the S-function build process such as source folders, preprocessor macros, and link objects. For example, you can specify source files that the S-function depends on that are in folders other than the folder containing the generated S-function executable. For more information, see “Use makecfg to Customize Generated Makefiles for S-Functions” (Simulink Coder) and “Import Calls to External Code into Generated Code with Legacy Code Tool” (Simulink Coder).

`legacy_code('rtwmakecfg_generate', specs)` generates an `rtwmakecfg.m` file for the S-function generated by the Legacy Code Tool based on the data structure, `specs`. If you use Simulink Coder to generate code from your Simulink model, you can use this option to specify additional items for the S-function build process such as source folders, preprocessor macros, and link objects. For example, you can specify source files that the S-function depends on that are in folders other than the folder containing the generated S-function executable. For more information, see “Use rtwmakecfg.m API to Customize Generated Makefiles” (Simulink Coder) and “Import Calls to External Code into Generated Code with Legacy Code Tool” (Simulink Coder).

`legacy_code('backward_compatibility')` automatically updates syntax for using Legacy Code Tool to the supported syntax described in this reference page and in “Integrate C Functions Using Legacy Code Tool”.

Input Arguments

specs

A structure with the following fields:

Name the S-function

`SFunctionName` (Required) — A character vector specifying a name for the S-function to be generated by the Legacy Code Tool.

Define Legacy Code Tool Function Specifications

- `InitializeConditionsFcnSpec` — A nonempty character vector specifying a function that the S-function calls to initialize and reset states. You must declare this function by using tokens that Simulink software can interpret as explained in “Declaring Legacy Code Tool Function Specifications”.
- `OutputFcnSpec` — A nonempty character vector specifying the function that the S-function calls at each time step. You must declare this function by using tokens that Simulink software can interpret as explained in “Declaring Legacy Code Tool Function Specifications”.
- `StartFcnSpec` — A character vector specifying the function that the S-function calls when it begins execution. This function can access S-function parameter arguments and work data. You must declare this function by using tokens that Simulink software can interpret as explained in “Declaring Legacy Code Tool Function Specifications”.

- `TerminateFcnSpec` — A character vector specifying the function that the S-function calls when it terminates execution. This function can access S-function parameter arguments and work data. You must declare this function by using tokens that Simulink software can interpret as explained in “Declaring Legacy Code Tool Function Specifications”.

Define Compilation Resources

- `HeaderFiles` — A cell array of character vectors specifying the file names of header files required for compilation.
- `SourceFiles` — A cell array of character vectors specifying source files required for compilation. You can specify the source files using absolute or relative path names.
- `HostLibFiles` — A cell array of character vectors specifying library files required for host compilation. You can specify the library files using absolute or relative path names.
- `TargetLibFiles` — A cell array of character vectors specifying library files required for target (that is, standalone) compilation. You can specify the library files using absolute or relative path names.
- `IncPaths` — A cell array of character vectors specifying directories containing header files. You can specify the directories using absolute or relative path names.
- `SrcPaths` — A cell array of character vectors specifying directories containing source files. You can specify the directories using absolute or relative path names.
- `LibPaths` — A cell array of character vectors specifying directories containing host and target library files. You can specify the directories using absolute or relative path names.

Specify a Sample Time

`SampleTime` — One of the following:

- `'inherited'` (default) — Sample time is inherited from the source block.
- `'parameterized'` — Sample time is represented as a tunable parameter. Generated code can access the parameter by calling MEX API functions, such as `mxGetPr` or `mxGetData`.
- `Fixed` — Sample time that you explicitly specify. For information on how to specify sample time, see “Specify Sample Time”.

If you specify this field, you must specify it last.

Define S-Function Options

`Options` — A structure that controls S-function options. The structure's fields include:

- `canBeCalledConditionally` — A logical value specifying the setting of the S-function `SS_OPTION_CAN_BE_CALLED_CONDITIONALLY` option. By default, the value is `true` (1).
- `convertNDArrayToRowMajor` — A logical value specifying the automatic conversion of a matrix between a column-major format and a row-major format. The column-major format is used by MATLAB, Simulink, and the generated code. The row-major format is used by C. By default, the value is `false` (0). If you currently specify the previous version of the option, `convert2DMatrixToRowMajor`, the function automatically specifies the new `convertNDArrayToRowMajor` option.

Note This option does not support a 2-D matrix of complex data.

- `isMacro` — A logical value specifying whether the legacy code is a C macro. By default, the value is false (0).
- `isVolatile` — A logical value specifying the setting of the S-function `SS_OPTION_NONVOLATILE` option. By default, the value is true (1).
- `language` — A character vector specifying either 'C' or 'C++' as the target language of the S-function that Legacy Code Tool will produce. By default, the value is 'C'.

Note The Legacy Code Tool can interface with C++ functions, but not C++ objects. For a work around, see “Legacy Code Tool Limitations” in the Simulink documentation.

- `outputsConditionallyWritten`— A logical value specifying whether the legacy code conditionally writes the output ports. If true, the generated S-function specifies that the memory associated with each output port cannot be overwritten and is global (`SS_NOT_REUSABLE_AND_GLOBAL`). If false, the memory associated with each output port is reusable and is local (`SS_REUSABLE_AND_LOCAL`). By default, the value is false (0). For more information, see `ssSetOutputPortOptimOpts`.
- `singleCPPMexFile` — A logical value that, if true, specifies that generated code:
 - Requires you to generate and manage an inlined S-function as only one file (.cpp) instead of two (.c and .tlc).
 - Maintains model code style (level of parentheses usage and preservation of operand order in expressions and condition expressions in if statements) as specified by model configuration parameters.

By default, the value is false.

Limitations You cannot set the `singleCPPMexFile` field to true if

- `Options.language='C++'`
 - You use one of the following Simulink objects with the `IsAlias` property set to true:
 - `Simulink.Bus`
 - `Simulink.AliasType`
 - `Simulink.NumericType`
 - The Legacy Code Tool function specification includes a `void*` or `void**` to represent scalar work data for a state argument
 - `HeaderFiles` field of the Legacy Code Tool structure specifies multiple header files
-
- `supportsMultipleExecInstances`— A logical value specifying whether to include a call to the `ssSupportsMultipleExecInstances` function. By default, the value is false (0).
 - `supportCodeReuseAcrossModels`— A logical value specifying whether the generated S-function can be reused across the model reference hierarchy. If true, the generated S-function includes the `ssSetSupportedForCodeReuseAcrossModels` function call. The code generator produces the code for the S-functions in the `slprj\ert_sharedutils` folder.
 - `supportCoverage`— A logical value specifying whether the generated S-function must be compatible with Model Coverage. By default, the value is false (0).
 - `supportCoverageAndDesignVerifier`— A logical value specifying whether the generated S-function must be compatible with Model Coverage and Simulink Design Verifier. By default, the value is false (0).

- `useTlcWithAccel` — A logical value specifying the setting of the S-function `SS_OPTION_USE_TLC_WITH_ACCELERATOR` option. By default, the value is true (1).

modelName

The name of a Simulink model into which Legacy Code Tool is to insert the masked S-function block generated when you specify `legacy_code` with the action character vector `'slblock_generate'`. If you omit this argument, the block appears in an empty model editor window.

See Also

Topics

“Integrate C Functions Using Legacy Code Tool”

“Import Calls to External Code into Generated Code with Legacy Code Tool” (Simulink Coder)

Introduced in R2006b

libinfo

Get information about library blocks referenced by model

Syntax

```
libdata = libinfo('system')
libdata = libinfo('system', constraint1, value1, ...)
```

Description

`libdata = libinfo('system')` returns information about library blocks referenced by `system` and all the systems underneath it.

`libdata = libinfo('system', constraint1, value1, ...)` restricts the search as indicated by the search constraint(s) `c1, v1, ...`

Input Arguments

system

The system to search recursively for library blocks.

constraint1, value1, ...

One or more pairs, each consisting of a search constraint followed by a constraint value. You can specify any of the search constraints that you can use with `find_system`.

Output Arguments

libdata

An array of structures that describes each library block referenced by `system`. Each structure has the following fields:

| | |
|----------------|---|
| Block | Path of the link to the library block |
| Library | Name of the library containing the referenced block |
| ReferenceBlock | Path of the library block |
| LinkStatus | Value of the LinkStatus parameter for the link to the library block |

See Also

`find_system`

Topics

“Create Custom Library”

Introduced before R2006a

LibraryBrowser.LibraryBrowser2

Get the handle of the Library Browser object

Syntax

```
libraryhandle = LibraryBrowser.LibraryBrowser2
```

Description

`libraryhandle = LibraryBrowser.LibraryBrowser2` returns the handle of the Library Browser (`LibraryBrowser.LBStandalone`) object.

Examples

Keep Library Browser in Front of Other Windows

Create an object that lets you programmatically access the Library Browser.

```
lb = LibraryBrowser.LibraryBrowser2;
```

Set the `IsOnTop` property of the Library Browser to 1 (`true`) using dot notation to access the property.

```
lb.IsOnTop = 1;
```

Compatibility Considerations

LibraryBrowser.LBStandalone object replaces LibraryBrowser.LibraryBrowser2 object
Behavior changed in R2016b

In previous releases, these two commands returned a `LibraryBrowser.LibraryBrowser2` object:

```
lb = slLibraryBrowser  
lb = LibraryBrowser.LibraryBrowser2
```

Starting in R2016b, each command returns a `LibraryBrowser.LBStandalone` object. The functions to access Library Browser operations such as `show` and `refresh` support `LibraryBrowser.LBStandalone` objects.

See Also

Functions

`simulink` | `start_simulink`

Tools

Library Browser

Objects

`LibraryBrowser.LBStandalone`

Topics

“Build and Edit a Model Interactively”

Introduced in R2014b

getPosition

Package: LibraryBrowser

Get position of Simulink Library Browser

Syntax

```
position = getPosition(lb)
```

Description

`position = getPosition(lb)` returns the position of the Simulink Library Browser.

Examples

Get Position of Library Browser

```
lb = LibraryBrowser.LibraryBrowser2;  
getPosition(lb)
```

```
ans =
```

```
    50    279    600    600
```

Input Arguments

lb — Simulink Library Browser

LibraryBrowser.LBStandalone object

Simulink Library Browser, specified as a LibraryBrowser.LBStandalone object.

Output Arguments

position — Position of Library Browser

numeric array

Position of Library Browser, returned as a numeric array of integers, in pixels: upper-left x-coordinate, upper-left y-coordinate, width, and height.

See Also

Tools

Library Browser

Objects

LibraryBrowser.LBStandalone

Functions

LibraryBrowser.LibraryBrowser2 | show | hide | setPosition

Introduced in R2016b

hide

Package: LibraryBrowser

Hide Simulink Library Browser

Syntax

```
hide(lb)
```

Description

hide(lb) hides the Simulink Library Browser.

Examples

Hide Library Browser

```
lb = LibraryBrowser.LibraryBrowser2;  
hide(lb)
```

Input Arguments

lb — Simulink Library Browser

LibraryBrowser.LBStandalone object

Simulink Library Browser, specified as a LibraryBrowser.LBStandalone object.

See Also

Tools

Library Browser

Objects

LibraryBrowser.LBStandalone

Functions

LibraryBrowser.LibraryBrowser2 | show | getPosition | setPosition

Introduced in R2016b

refresh

Package: LibraryBrowser

Refresh Simulink Library Browser

Syntax

```
refresh(lb)
```

Description

`refresh(lb)` updates the Simulink Library Browser with changes that affect it. Examples include adding a library to the Library Browser, removing a library from the Library Browser, and making changes to your custom libraries, `slblocks` function, or `sl_customization.m` file.

Examples

Refresh Library Browser

Refresh the Library Browser when you have made any changes that affect libraries on your MATLAB path that are registered in the Library Browser.

```
lb = LibraryBrowser.LibraryBrowser2;  
refresh(lb)
```

Input Arguments

lb — Simulink Library Browser

`LibraryBrowser.LBStandalone` object

Simulink Library Browser, specified as a `LibraryBrowser.LBStandalone` object.

See Also

Tools

Library Browser

Objects

`LibraryBrowser.LBStandalone`

Functions

`LibraryBrowser.LibraryBrowser2` | `show` | `hide` | `getPosition` | `setPosition`

Topics

“Create Custom Library”

“Add Libraries to the Library Browser”

“Customize Library Browser Appearance”

Introduced in R2016b

setPosition

Package: LibraryBrowser

Set position of Simulink Library Browser

Syntax

```
setPosition(lb,position)
```

Description

`setPosition(lb,position)` sets the position of the Simulink Library Browser.

Examples

Set Position of Library Browser

```
lb = LibraryBrowser.LibraryBrowser2;  
setPosition(lb,[70 250 500 500])
```

Input Arguments

lb — Simulink Library Browser

LibraryBrowser.LBStandalone object

Simulink Library Browser, specified as a LibraryBrowser.LBStandalone object.

position — New position of Library Browser

numeric array

New position of Library Browser, specified as a numeric array of integers, in pixels: upper-left x-coordinate, upper-left y-coordinate, width, and height.

Data Types: double

See Also

Tools

Library Browser

Objects

LibraryBrowser.LBStandalone

Functions

LibraryBrowser.LibraryBrowser2 | show | hide | getPosition

Introduced in R2016b

show

Package: LibraryBrowser

Display Simulink Library Browser

Syntax

```
show(lb)
```

Description

`show(lb)` displays the Simulink Library Browser.

Examples

Display Library Browser

```
lb = LibraryBrowser.LibraryBrowser2;  
show(lb)
```

Input Arguments

lb — Simulink Library Browser

`LibraryBrowser.LBStandalone` object

Simulink Library Browser, specified as a `LibraryBrowser.LBStandalone` object.

See Also

Tools

Library Browser

Objects

`LibraryBrowser.LBStandalone`

Functions

`LibraryBrowser.LibraryBrowser2` | `sLibraryBrowser` | `refresh` | `hide` | `getPosition` | `setPosition`

Introduced in R2016b

linmod

Extract continuous-time linear state-space model around operating point

Syntax

```
argout = linmod('sys');
argout = linmod('sys', x, u);
argout = linmod('sys', x, u, para);
argout = linmod('sys', x, u, 'v5');
argout = linmod('sys', x, u, para, 'v5');
argout = linmod('sys', x, u, para, xpert, upert, 'v5');
```

Arguments

| | |
|-----------------------|---|
| <i>sys</i> | Name of the Simulink system from which the linear model is extracted. |
| <i>x</i> and <i>u</i> | State (<i>x</i>) and the input (<i>u</i>) vectors. If specified, they set the operating point at which the linear model is extracted. When a model has model references using the Model block, you must use the Simulink structure format to specify <i>x</i> . To extract the <i>x</i> structure from the model, use the following command: <pre>x = Simulink.BlockDiagram.getInitialState('sys');</pre> <p>You can then change the operating point values within this structure by editing <code>x.signals.values</code>.</p> <p>If the state contains different data types (for example, 'double' and 'uint8'), then you cannot use a vector to specify this state. You must use a structure instead. In addition, you can only specify the state as a vector if the state data type is 'double'.</p> |
| <i>Ts</i> | Sample time of the discrete-time linearized model |
| 'v5' | An optional argument that invokes the perturbation algorithm created prior to MATLAB 5.3. Invoking this optional argument is equivalent to calling <code>linmodv5</code> . |
| <i>para</i> | A three-element vector of optional arguments: <ul style="list-style-type: none"> • <code>para(1)</code> — Perturbation value of delta, the value used to perform the perturbation of the states and the inputs of the model. This is valid for linearizations using the 'v5' flag. The default value is 1e-05. • <code>para(2)</code> — Linearization time. For blocks that are functions of time, you can set this parameter with a nonnegative value that gives the time (<i>t</i>) at which Simulink evaluates the blocks when linearizing a model. The default value is 0. • <code>para(3)</code> — Set <code>para(3)=1</code> to remove extra states associated with blocks that have no path from input to output. The default value is 0. |

xpert and upert The perturbation values used to perform the perturbation of all the states and inputs of the model. The default values are

```
xpert = para(1) + 1e-3*para(1)*abs(x)
upert = para(1) + 1e-3*para(1)*abs(u)
```

When a model has model references using the Model block, you must use the Simulink structure format to specify `xpert`. To extract the `xpert` structure, use the following command:

```
xpert = Simulink.BlockDiagram.getInitialState('sys');
```

You can then change the perturbation values within this structure by editing `xpert.signals.values`.

The perturbation input arguments are only available when invoking the perturbation algorithm created prior to MATLAB 5.3, either by calling `linmodv5` or specifying the 'v5' input argument to `linmod`.

argout

`linmod`, `dlinmod`, and `linmod2` return state-space representations if you specify the output (left-hand) side of the equation as follows:

- `[A,B,C,D] = linmod('sys', x, u)` obtains the linearized model of `sys` around an operating point with the specified state variables `x` and the input `u`. If you omit `x` and `u`, the default values are zero.

`linmod` and `dlinmod` both also return a transfer function and MATLAB data structure representations of the linearized system, depending on how you specify the output (left-hand) side of the equation. Using `linmod` as an example:

- `[num, den] = linmod('sys', x, u)` returns the linearized model in transfer function form.
- `sys_struct = linmod('sys', x, u)` returns a structure that contains the linearized model, including state names, input and output names, and information about the operating point.

Description

`linmod` compute a linear state-space model by linearizing each block in a model individually.

`linmod` obtains linear models from systems of ordinary differential equations described as Simulink models. Inputs and outputs are denoted in Simulink block diagrams using Inport and Outport blocks.

The default algorithm uses preprogrammed analytic block Jacobians for most blocks which should result in more accurate linearization than numerical perturbation of block inputs and states. A list of blocks that have preprogrammed analytic Jacobians is available in the Simulink Control Design documentation along with a discussion of the block-by-block analytic algorithm for linearization.

The default algorithm also allows for special treatment of problematic blocks such as the Transport Delay and the Quantizer. See the mask dialog of these blocks for more information and options.

Notes

By default, the system time is set to zero. For systems that are dependent on time, you can set the variable `para` to a two-element vector, where the second element is used to set the value of `t` at which to obtain the linear model.

The ordering of the states from the nonlinear model to the linear model is maintained. For Simulink systems, a character vector variable that contains the block name associated with each state can be obtained using

```
[sizes,x0,xstring] = sys
```

where `xstring` is a vector of strings whose *i*th row is the block name associated with the *i*th state. Inputs and outputs are numbered sequentially on the diagram.

For single-input multi-output systems, you can convert to transfer function form using the routine `ss2tf` or to zero-pole form using `ss2zp`. You can also convert the linearized models to LTI objects using `ss`. This function produces an LTI object in state-space form that can be further converted to transfer function or zero-pole-gain form using `tf` or `zpk`.

The default algorithms in `linmod` handle Transport Delay blocks by replacing the linearization of the blocks with a Pade approximation. For the 'v5' algorithm, linearization of a model that contains Derivative or Transport Delay blocks can be troublesome. For more information, see "Linearizing Models".

See Also

`dlinmod` | `linmod2` | `linmodv5`

Introduced in R2007a

linmod2

Extract continuous-time linear state-space model around operating point

Syntax

```
argout = linmod2('sys', x, u);
argout = linmod2('sys', x, u, para);
```

Arguments

sys

Name of the Simulink system from which the linear model is extracted.

x, u

State (x) and the input (u) vectors. If specified, they set the operating point at which the linear model is extracted. When a model has model references using the Model block, you must use the Simulink structure format to specify x . To extract the x structure from the model, use the following command:

```
x = Simulink.BlockDiagram.getInitialState('sys');
```

You can then change the operating point values within this structure by editing `x.signals.values`.

If the state contains different data types (for example, 'double' and 'uint8'), then you cannot use a vector to specify this state. You must use a structure instead. In addition, you can only specify the state as a vector if the state data type is 'double'.

para

A three-element vector of optional arguments:

- `para(1)` — Perturbation value of delta, the value used to perform the perturbation of the states and the inputs of the model. This is valid for linearizations using the 'v5' flag. The default value is 1e-05.
- `para(2)` — Linearization time. For blocks that are functions of time, you can set this parameter with a nonnegative value that gives the time (t) at which Simulink evaluates the blocks when linearizing a model. The default value is 0.
- `para(3)` — Set `para(3)=1` to remove extra states associated with blocks that have no path from input to output. The default value is 0.

argout

`linmod`, `dlinmod`, and `linmod2` return state-space representations if you specify the output (left-hand) side of the equation as follows:

- `[A,B,C,D] = linmod('sys', x, u)` obtains the linearized model of `sys` around an operating point with the specified state variables `x` and the input `u`. If you omit `x` and `u`, the default values are zero.

`linmod` and `dlinmod` both also return a transfer function and MATLAB data structure representations of the linearized system, depending on how you specify the output (left-hand) side of the equation. Using `linmod` as an example:

- `[num, den] = linmod('sys', x, u)` returns the linearized model in transfer function form.
- `sys_struct = linmod('sys', x, u)` returns a structure that contains the linearized model, including state names, input and output names, and information about the operating point.

Description

`linmod2` computes a linear state-space model by perturbing the model inputs and model states, and uses an advanced algorithm to reduce truncation error.

`linmod2` obtains linear models from systems of ordinary differential equations described as Simulink models. Inputs and outputs are denoted in Simulink block diagrams using Inport and Outport blocks.

Notes

By default, the system time is set to zero. For systems that are dependent on time, you can set the variable `para` to a two-element vector, where the second element is used to set the value of `t` at which to obtain the linear model.

The ordering of the states from the nonlinear model to the linear model is maintained. For Simulink systems, a character vector variable that contains the block name associated with each state can be obtained using

```
[sizes,x0,xstring] = sys
```

where `xstring` is a vector of strings whose `ith` row is the block name associated with the `ith` state. Inputs and outputs are numbered sequentially on the diagram.

For single-input multi-output systems, you can convert to transfer function form using the routine `ss2tf` or to zero-pole form using `ss2zp`. You can also convert the linearized models to LTI objects using `ss`. This function produces an LTI object in state-space form that can be further converted to transfer function or zero-pole-gain form using `tf` or `zpk`.

The default algorithms in `linmod` and `dlinmod` handle Transport Delay blocks by replacing the linearization of the blocks with a Pade approximation. For more information, see “Linearizing Models”.

See Also

`linmod` | `dlinmod` | `linmodv5`

Introduced in R2007a

linmodv5

Extract continuous-time linear state-space model around operating point

Syntax

```
argout = linmodv5('sys');
argout = linmodv5('sys',x,u);
argout = linmodv5('sys', x, u, para);
argout = linmodv5('sys', x, u, para, xpert, upert);
```

Arguments

- | | |
|-------------|---|
| <i>sys</i> | Name of the Simulink system from which the linear model is extracted. |
| <i>x, u</i> | State (x) and the input (u) vectors. If specified, they set the operating point at which the linear model is extracted. When a model has model references using the Model block, you must use the Simulink structure format to specify x . To extract the x structure from the model, use the following command: <pre>x = Simulink.BlockDiagram.getInitialState('sys');</pre> <p>You can then change the operating point values within this structure by editing <code>x.signals.values</code>.</p> <p>If the state contains different data types (for example, 'double' and 'uint8'), then you cannot use a vector to specify this state. You must use a structure instead. In addition, you can only specify the state as a vector if the state data type is 'double'.</p> |
| <i>para</i> | A three-element vector of optional arguments: <ul style="list-style-type: none"> • <code>para(1)</code> — Perturbation value of delta, the value used to perform the perturbation of the states and the inputs of the model. This is valid for linearizations using the 'v5' flag. The default value is 1e-05. • <code>para(2)</code> — Linearization time. For blocks that are functions of time, you can set this parameter with a nonnegative value that gives the time (t) at which Simulink evaluates the blocks when linearizing a model. The default value is 0. • <code>para(3)</code> — Set <code>para(3)=1</code> to remove extra states associated with blocks that have no path from input to output. The default value is 0. |

xpert, upert

The perturbation values used to perform the perturbation of all the states and inputs of the model. The default values are

```
xpert = para(1) + 1e-3*para(1)*abs(x)
upert = para(1) + 1e-3*para(1)*abs(u)
```

When a model has model references using the Model block, you must use the Simulink structure format to specify *xpert*. To extract the *xpert* structure, use the following command:

```
xpert = Simulink.BlockDiagram.getInitialState('sys');
```

You can then change the perturbation values within this structure by editing `xpert.signals.values`.

The perturbation input arguments are only available when invoking the perturbation algorithm created prior to MATLAB 5.3, either by calling `linmodv5` or specifying the 'v5' input argument to `linmod`.

argout

`linmod`, `dlinmod`, and `linmod2` return state-space representations if you specify the output (left-hand) side of the equation as follows:

- `[A,B,C,D] = linmod('sys', x, u)` obtains the linearized model of *sys* around an operating point with the specified state variables *x* and the input *u*. If you omit *x* and *u*, the default values are zero.

`linmod` and `dlinmod` both also return a transfer function and MATLAB data structure representations of the linearized system, depending on how you specify the output (left-hand) side of the equation. Using `linmod` as an example:

- `[num, den] = linmod('sys', x, u)` returns the linearized model in transfer function form.
- `sys_struct = linmod('sys', x, u)` returns a structure that contains the linearized model, including state names, input and output names, and information about the operating point.

Description

`linmodv5` computes a linear state space model using the full model perturbation algorithm created prior to MATLAB 5.3.

`linmodv5` obtains linear models from systems of ordinary differential equations described as Simulink models. Inputs and outputs are denoted in Simulink block diagrams using Inport and Outport blocks.

Notes

By default, the system time is set to zero. For systems that are dependent on time, you can set the variable `para` to a two-element vector, where the second element is used to set the value of `t` at which to obtain the linear model.

The ordering of the states from the nonlinear model to the linear model is maintained. For Simulink systems, a character vector variable that contains the block name associated with each state can be obtained using

```
[sizes,x0,xstring] = sys
```

where `xstring` is a vector of strings whose *i*th row is the block name associated with the *i*th state. Inputs and outputs are numbered sequentially on the diagram.

For single-input multi-output systems, you can convert to transfer function form using the routine `ss2tf` or to zero-pole form using `ss2zp`. You can also convert the linearized models to LTI objects using `ss`. This function produces an LTI object in state-space form that can be further converted to transfer function or zero-pole-gain form using `tf` or `zpk`.

The default algorithms in `linmod` and `dlinmod` handle Transport Delay blocks by replacing the linearization of the blocks with a Pade approximation. For the 'v5' algorithm, linearization of a model that contains Derivative or Transport Delay blocks can be troublesome. For more information, see "Linearizing Models".

See Also

`linmod` | `dlinmod` | `linmod2`

Introduced in R2011b

load_system

Load Simulink model into memory

Syntax

```
handle = load_system(sys)
```

Description

`handle = load_system(sys)` loads the model `sys` into memory without opening the model in the Simulink Editor. After you load a model into memory, you can work with it using Simulink API commands. Save changes to the model using `save_system`.

Examples

Load Model into Memory

Load the model `vdp` into memory and return the model handle.

```
h = load_system("vdp")
```

```
h =
```

```
172.0004
```

Input Arguments

sys — System to search

character vector | string scalar

System to search, specified as the full system path name, a cell array of system path names, a handle, or a vector of handles.

Example: "vdp"

Example: 'MyModel/Subsystem1'

Example: {'vdp', 'fuelssystem'}

Output Arguments

handle — Handle of loaded model

handle

Handle of loaded model.

See Also

`close_system` | `open_system` | `save_system`

Introduced before R2006a

loadIntoMemory

Load logged data into memory

Syntax

```
logs = loadIntoMemory(logs)
```

Description

`logs = loadIntoMemory(logs)` loads the data in `logs` into memory. Data is logged to a repository and brought into memory on an as-needed basis. When you want to work with all elements of a large set of logged data, use `loadIntoMemory` to bring all of the elements into memory at once. Loading all the data at once, rather than element by element, is much faster.

Examples

Load Logged Data into Memory

This example shows how to load a set of logged data into memory all at once, rather than element by element.

```
% Simulate model to generate logged data  
sim('sldemo_fuelsys')
```

The simulation logs all of the instrumented signals in the model to the `Simulink.SimulationData.Dataset` object `sldemo_fuelsys_output`. At the end of simulation, the signal data remains in the repository until used in the MATLAB workspace. When you work with small sets of data or only postprocess a subset, leaving signals in the repository improves performance. But when you have a large set of data and need to postprocess all of the signals, you should bring them all into memory at once.

```
% Load all logged signals into memory  
loadIntoMemory(sldemo_fuelsys_output);
```

All of the data in `sldemo_fuelsys_output` is now available for efficient postprocessing.

Input Arguments

logs — Data to load into memory

'Simulink.SimulationData.Dataset' | 'Simulink.SimulationOutput'

Data to load into memory. The `loadIntoMemory` function can load `Simulink.SimulationData.Dataset` and `Simulink.SimulationOutput` data.

Example: `logout`

Output Arguments

Logs — Data

'Simulink.SimulationData.Dataset' | 'Simulink.SimulationOutput'

Data loaded into memory.

See Also

Simulink.SimulationData.Dataset | Simulink.SimulationOutput

Introduced in R2017b

model

Execute particular phase of simulation of model

Syntax

```
[sys,x0,str,ts] = model([],[],[],'sizes');  
[sys,x0,str,ts] = model([],[],[],'compile');  
outputs = model(t,x,u,'outputs');  
derivs = model(t,x,u,'derivs');  
dstates = model(t,x,u,'update');  
model([],[],[],'term');
```

Description

The `model` command executes a specific phase of the simulation of a Simulink model whose name is `model`. The command's last argument (`flag`) specifies the phase of the simulation to be executed. See “Simulation Phases in Dynamic Systems” for a description of the steps that Simulink software uses to simulate a model.

This command ignores the effects of state transitions and conditional execution. Therefore, it is not suitable for models which have such logic. Use this command for models which can be represented as simple dynamic systems. Such systems should meet these requirements.

- All states in the model must be built-in non-bus data types. For a discussion on built-in data types, see “About Data Types in Simulink”.
- If you are using vector format to specify the state, this command can access only non-complex states of `double` data type.
- There is minimal amount of state logic (Stateflow, conditionally executed subsystems etc.)
- The models are not mixed-domain models. That is, most blocks in the model are built-in Simulink blocks and do not include user-written S-functions or blocks from other Sim* products.

For models which do not comply with these requirements, using this command can cause Simulink to produce results which can only be interpreted by further analyzing and simplifying the model.

Note The state variable `x` can be represented in structure as well as vector formats. The variable follows the limitations of the format in which it is specified.

This command is also not intended to be used to run a model step-by-step, for example, to debug a model. Use the Simulink debugger if you need to examine intermediate results to debug a model.

Arguments

| | |
|----------------------|--|
| <code>sys</code> | <p>Vector of model size data:</p> <ul style="list-style-type: none"> • <code>sys(1)</code> = number of continuous states • <code>sys(2)</code> = number of discrete states • <code>sys(3)</code> = number of outputs • <code>sys(4)</code> = number of inputs • <code>sys(5)</code> = reserved • <code>sys(6)</code> = direct-feedthrough flag (1 = yes, 0 = no) • <code>sys(7)</code> = number of Continuous, Discrete, Fixed in minor step, and Controllable sample times (= number of rows in <code>ts</code>) |
| <code>x0</code> | Vector containing the initial conditions of the system's states |
| <code>str</code> | Vector of names of the blocks associated with the model's states. The state names and initial conditions appear in the same order in <code>str</code> and <code>x0</code> , respectively. |
| <code>ts</code> | <p>An m-by-2 matrix containing the sample time (period, offset) information of the Continuous, Discrete, Fixed in minor step, and Controllable sample times in the model.</p> <p>For more information on the sample times in Simulink, see “Types of Sample Time”.</p> |
| <code>outputs</code> | Outputs of the model at time step <code>t</code> . |
| <code>derivs</code> | Derivatives of the continuous states of the model at time <code>t</code> . |
| <code>dstates</code> | <p>States of the model at time <code>t</code> returned as either a structure or an array. Simulink returns a structure when the model has states and <code>x</code> is either empty (<code>[]</code>) or in structure format. Otherwise, Simulink returns an array.</p> <ul style="list-style-type: none"> • If the return type is a vector or array, Simulink returns real double discrete states only. • If the return type is a structure, Simulink returns a structure that contains both continuous and discrete states of built-in types only. Non-built-in types are omitted. |
| <code>t</code> | Time step, specified as real double in scalar format. |
| <code>x</code> | State vector, specified as real double in structure or vector format. |
| <code>u</code> | Inputs, specified as real double in vector format. |

| | |
|------|---|
| flag | <p>Specification of the simulation phase to be executed:</p> <ul style="list-style-type: none"> • 'sizes' executes the size computation phase of the simulation. This phase determines the sizes of the model's inputs, outputs, state vector, etc. • 'compile' executes the compilation phase of the simulation. The compilation phase propagates signal and sample time attributes. • 'update' computes the next values of the model's discrete states. • 'outputs' computes the outputs of the model's blocks at time <i>t</i>. • 'derivs' computes the derivatives of the model's continuous states at time step <i>t</i>. • 'term' causes Simulink software to terminate simulation of the model. <hr/> <p>Note The <code>output</code>, <code>update</code>, and <code>derivs</code> flags are valid only for single-tasking models. For more information on single-tasking and multi-tasking, see “Tasking Modes” (Simulink Coder).</p> |
|------|---|

Examples

The following command executes the compilation phase of the `vdp` model that comes with Simulink software.

```
vdp([], [], [], 'compile')
```

The following command terminates the simulation initiated in the previous example.

```
vdp([], [], [], 'term')
```

Note Simulink does not let you close a model while it is compiling or simulating. For all phases except the 'sizes' phase, before closing the model, you must invoke the model command with the 'term' argument.

See Also

`sim`

Introduced in R2007a

modeladvisor

Open Model Advisor

Syntax

```
modeladvisor(model)
modeladvisor(model, 'configuration', configfile)
```

Description

`modeladvisor(model)` opens the Model Advisor for the model or subsystem specified by `model`. If the specified model or subsystem is not open, this command opens it.

If you have a Simulink Check™ license, you can specify a name-value pair with `modeladvisor(model, 'configuration', configfile)` that opens the Model Advisor with a custom configuration. The configuration defines the organization of folders and checks in the Model Advisor. For more information, see “Create and Deploy a Model Advisor Custom Configuration” (Simulink Check).

Examples

Open Model Advisor for model

Open the Model Advisor for vdp example model:

```
modeladvisor('vdp')
```

Open Model Advisor for subsystem

Open the Model Advisor for the Aircraft Dynamics Model subsystem of the f14 example model:

```
modeladvisor('f14/Aircraft Dynamics Model')
```

Open Model Advisor for currently selected model

Open the Model Advisor on the currently selected model:

```
modeladvisor(bdroot)
```

Open Model Advisor for currently selected subsystem

Open the Model Advisor on the currently selected subsystem:

modeladvisor(gcs)

Input Arguments

model — Model or subsystem name

character vector

Model or subsystem name or handle, specified as a character vector.

Data Types: char

configfile — Custom configuration

character vector

File that contains a Model Advisor custom configuration of folders and checks (available with a Simulink Check license).

Data Types: char

See Also

“Run Model Advisor Checks”

Introduced before R2006a

new_system

Create Simulink model or library in memory

Syntax

```
h = new_system

h = new_system(name)
h = new_system(name, 'FromTemplate', template)
h = new_system(name, 'FromFile', file)
h = new_system( ___, 'ErrorIfShadowed' )

h = new_system(name, 'Model' )
h = new_system(name, 'Model', subsystem)
h = new_system(name, 'Subsystem' )
h = new_system(name, 'Library' )
h = new_system( ___, 'ErrorIfShadowed' )
```

Description

`h = new_system` creates a model named `untitled` (and then `untitled1`, `untitled2`, and so on) based on your default model template and returns the new model's numeric handle. Select your default model template on the Simulink start page or by using the `Simulink.defaultModelTemplate` function.

The `new_system` function does not open the new model. This function creates the model in memory. To save the model, use `save_system`, or open the model with `open_system` and then save it using the Simulink Editor.

`h = new_system(name)` creates a model based on your default model template and gives the new model the specified name. This function returns the new model's numeric handle. Select your default model template on the Simulink start page or by using the `Simulink.defaultModelTemplate` function.

If `name` is empty, the function creates a model named `untitled`, `untitled1`, `untitled2`, and so on.

The `new_system` function does not open the new model. This function creates the model in memory. To save the model, use `save_system`, or open the model with `open_system` and then save it using the Simulink Editor.

`h = new_system(name, 'FromTemplate', template)` creates the model based on the specified template.

`h = new_system(name, 'FromFile', file)` creates the model based on the specified model or template.

`h = new_system(___, 'ErrorIfShadowed')` creates the model or returns an error if another model, MATLAB file, or variable with the same name is on the MATLAB path or in the workspace. It uses any of the input arguments in the previous syntaxes.

`h = new_system(name, 'Model')` creates an empty model based on the Simulink default model and returns the new model's numeric handle. The Simulink default model is also known as the root block diagram and has the numeric handle 0. If `name` is empty, the function creates a model or library named `untitled`, `untitled1`, `untitled2`, and so on.

The `new_system` function does not open the new model. This function creates the model in memory. To save the model, use `save_system`, or open the model with `open_system` and then save it using the Simulink Editor.

`h = new_system(name, 'Model', subsystem)` creates a model based on the subsystem `subsystem` in a currently loaded model.

`h = new_system(name, 'Subsystem')` creates an empty subsystem file that has the specified name.

`h = new_system(name, 'Library')` creates an empty library that has the specified name and returns a numeric handle.

`h = new_system(____, 'ErrorIfShadowed')` returns an error if another model, MATLAB file, or variable with the same name is on the MATLAB path or in the workspace. This syntax uses any of the input arguments in the previous syntaxes.

Examples

Create a Model Based on Default Template

Create a model in memory called `untitled`.

```
h = new_system;
```

You can use `get_param` to get the name.

```
get_param(h, 'Name')
open_system(h)
open_system('untitled')
open_system(get_param(h, 'Name'))
```

```
ans =
```

```
untitled
```

Use the name, the handle, or `get_param` command as input to `open_system`. You can use any of these commands:

Create a Model Based on Named Template

Before you use this syntax, create a template. In the Simulink Editor, create the model you want to use as the template, then in the **Simulation** tab, select **Save > Template**. For this example, name the template `mytemplate`.

By default, the template is on the MATLAB path, so if you change location, add the folder to the MATLAB path.

Create a model named `templateModel` based on the template `mytemplate`.

```
h = new_system('templateModel','FromTemplate','mytemplate');
```

Invoking `template` \\myuserdir\Documents\MATLAB\mytemplate.sltx

Create a Model Based on Another Model

Create a model named `mynewmodel` based on `myoldmodel`, which is in the current folder.

```
h = new_system('mynewmodel','FromFile','myoldmodel.slx');
```

Create Model from Subsystem

Load the model `f14`. Create a model based on the Controller subsystem.

```
load_system('f14');
new_system('mycontroller','Model','f14/Controller');
open_system('mycontroller');
```

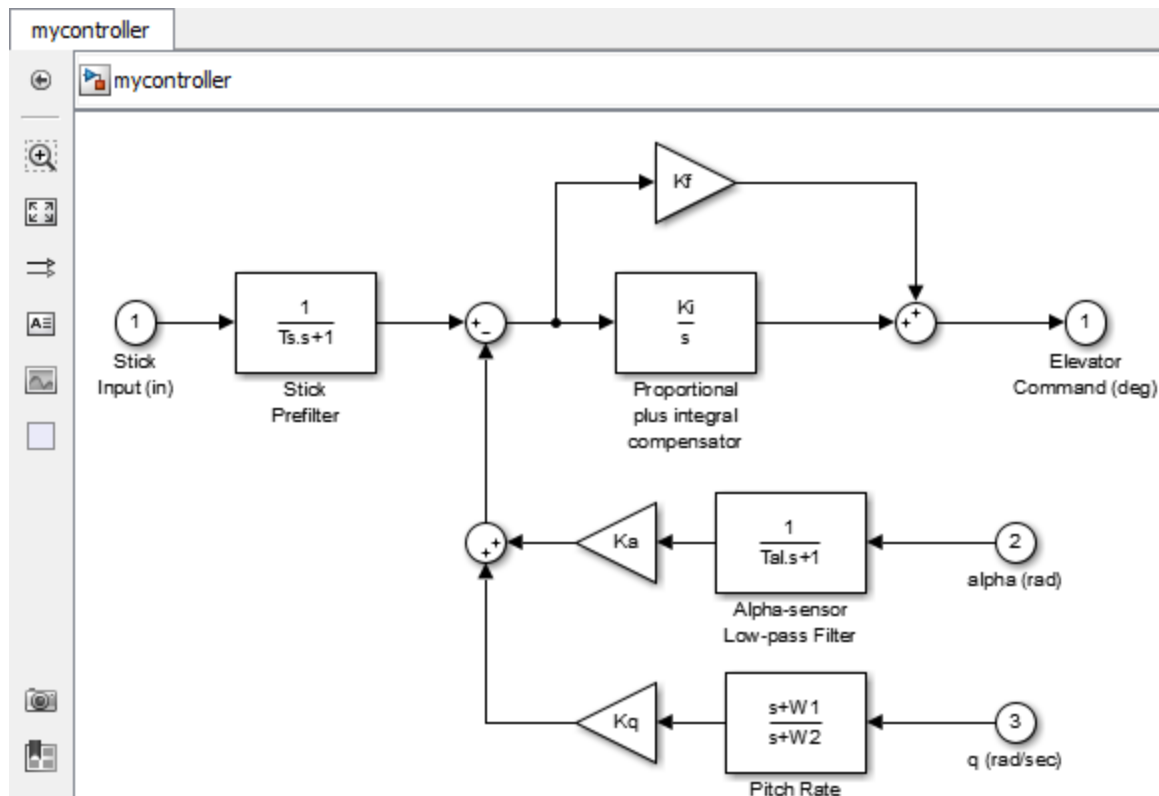

Create a Library

Create a library in memory and then open it.

```
new_system('mylib','Library')
open_system('mylib')
```

Create a Subsystem File

Create a subsystem file in memory and then open it.

```
new_system('mysubsystem','Subsystem')
open_system('mysubsystem')
```

Ensure Model Name Is Unique

Create a variable with the name myvar.

```
myvar = 17
```

Try to create a model that uses the same name as the variable. When you use the 'ErrorIfShadowed' option, the new_system function returns an error.

```
new_system('myvar2','Model','ErrorIfShadowed')
```

The model 'myvar2' cannot be created because this name is shadowing another name on the MATLAB path or in the workspace. Choose another name, or do not use the option 'ErrorIfShadowed'

Input Arguments

name — Name of new model or library

character vector

Name of new model or library, specified as a character vector that:

- Has 63 or fewer characters
- Is not a MATLAB keyword
- Is not 'simulink'
- Is unique among model names, variables, and MATLAB files on the MATLAB path and in the workspace

Example: 'mymodel', 'mylibrary'

subsys — Subsystem to base new model on

subsystem block path name

Subsystem to base the new model on, specified as the subsystem block path name in a currently open model.

Example: 'f14/Controller'

template — Name of template to base new model on

character vector

Name of the template to base the new model on, specified as a character vector of the name of a template on the MATLAB path. Create a template in the Simulink Editor. In the **Simulation** tab, select **Save > Template**.

Example: 'mytemplate', 'mytemplate.slx'

file – Path name of model or template to base new model on

character vector

Path name of the model or template to base the new model on, specified as a character vector. You can use an `.mdl`, `.slx`, or `..slx` file. Include the extension and use a full or relative path.

Example: 'Models/mymodel.slx', 'mytemplate.slx', 'model.mdl'

See Also

`open_system` | `save_system` | `Simulink.defaultModelTemplate`

Introduced before R2006a

num2fixpt

Convert number to nearest value representable by specified fixed-point data type

Syntax

```
outValue = num2fixpt(OrigValue, FixPtDataType, FixPtScaling,
    RndMeth, DoSatur)
```

Description

`num2fixpt(OrigValue, FixPtDataType, FixPtScaling, RndMeth, DoSatur)` returns the result of converting `OrigValue` to the nearest value representable by the fixed-point data type `FixPtDataType`. Both `OrigValue` and `outValue` are of data type `double`. As illustrated in the example that follows, you can use `num2fixpt` to investigate quantization error that might result from converting a number to a fixed-point data type. The arguments of `num2fixpt` include:

| | |
|----------------------------|--|
| <code>OrigValue</code> | Value to be converted to a fixed-point representation. Must be specified using a <code>double</code> data type. |
| <code>FixPtDataType</code> | The fixed-point data type used to convert <code>OrigValue</code> . |
| <code>FixPtScaling</code> | Scaling of the output in either <code>Slope</code> or <code>[Slope Bias]</code> format. If <code>FixPtDataType</code> does not specify a generalized fixed-point data type using the <code>sfix</code> or <code>ufix</code> command, <code>FixPtScaling</code> is ignored. |
| <code>RndMeth</code> | Rounding technique used if the fixed-point data type lacks the precision to represent <code>OrigValue</code> . If <code>FixPtDataType</code> specifies a floating-point data type using the <code>float</code> command, <code>RndMeth</code> is ignored. Valid values are <code>Zero</code> , <code>Nearest</code> , <code>Ceiling</code> , or <code>Floor</code> (the default). |
| <code>DoSatur</code> | Indicates whether the output should be saturated to the minimum or maximum representable value upon underflow or overflow. If <code>FixPtDataType</code> specifies a floating-point data type using the <code>float</code> command, <code>DoSatur</code> is ignored. Valid values are <code>on</code> or <code>off</code> (the default). |

Examples

Suppose you wish to investigate the quantization effect associated with representing the real-world value 9.875 as a signed, 8-bit fixed-point number. The command

```
num2fixpt(9.875, sfix(8), 2^-1)
```

```
ans =
```

```
9.500000000000000
```

reveals that a slope of 2^{-1} results in a quantization error of 0.375. The command

```
num2fixpt(9.875, sfix(8), 2^-2)
```

```
ans =
```

```
9.750000000000000
```

demonstrates that a slope of 2^{-2} reduces the quantization error to 0.125. But a slope of 2^{-3} , as used in the command

```
num2fixpt(9.875, sfix(8), 2^-3)
```

```
ans =
```

```
9.875000000000000
```

eliminates the quantization error entirely.

See Also

`fixptbestexp` | `fixptbestprec`

Introduced before R2006a

open_system

Open model, library, subsystem, or block dialog box

Syntax

```
open_system(obj)

open_system(sys, 'loadonly')

open_system(sbsys, 'window')
open_system(sbsys, 'tab')

open_system(blk, 'mask')
open_system(blk, 'force')
open_system(blk, 'parameter')
open_system(blk, 'OpenFcn')
```

Description

`open_system(obj)` opens the specified model, library, subsystem, or block. This is equivalent to double-clicking the model or library in the Current Folder Browser, or the subsystem or block in the Simulink Editor.

A model or library opens in a new window. For a subsystem or block within a model, the behavior depends on the type of block and its properties.

- Any `OpenFcn` callback parameter is evaluated.
- If there is no `OpenFcn` callback, and a mask is defined, the mask parameter dialog box opens.
- Without an `OpenFcn` callback or a mask parameter, Simulink opens the object.
 - A referenced model opens in a new window.
 - A subsystem opens in a new tab in the same window.
 - For blocks, the parameters dialog box for the block opens.

To open a specific subsystem or block, you must load the model or library containing it. Otherwise Simulink returns an error.

You can override the default behavior by supplying a second input argument.

`open_system(sys, 'loadonly')` loads the specified model or library without opening the Simulink Editor. This is equivalent to using `load_system`.

`open_system(sbsys, 'window')` opens the subsystem `sbsys` in a new Simulink Editor window. Before opening a specific subsystem or block, load the model or library containing it. Otherwise Simulink returns an error.

`open_system(sbsys, 'tab')` opens the subsystem in a new Simulink Editor tab in the same window. Before opening a specific subsystem or block, load the model or library containing it. Otherwise Simulink returns an error.

`open_system(blk, 'mask')` opens the mask dialog box of the block or subsystem specified by `blk`. Load the model or library containing `blk` before opening it.

`open_system(blk, 'force')` looks under the mask of a masked block or subsystem. It opens the dialog box of the block under the mask or opens a masked subsystems in a new Simulink Editor tab. This is equivalent to the **Look Under Mask** menu item. Before opening a specific subsystem or block, load the model or library containing it. Otherwise Simulink returns an error.

`open_system(blk, 'parameter')` opens the block parameter dialog box.

`open_system(blk, 'OpenFcn')` runs the block callback `OpenFcn`.

Examples

Open a Model

Open the f14 model.

```
open_system('f14')
```

Load a Model Without Opening it

Load the f14 model.

```
open_system('f14', 'loadonly')
```

Open a Subsystem

Open the Controller subsystem of the f14 model.

```
load_system('f14')  
open_system('f14/Controller')
```

Open a Subsystem in New Tab in Existing Window

Open the f14 model and open the Controller subsystem in a new tab.

```
f14  
open_system('f14/Controller', 'tab')
```

Open a Subsystem in a Separate Window

Open a subsystem in its own Simulink Editor window.

```
open_system('f14')  
open_system('f14/Controller', 'window')
```

Open a Referenced Model

Open the model `sldemo_mdhref_counter`, which is referenced by the CounterA Model block in `sldemo_mdhref_basic`.

```
open_system('sldemo_mdhref_basic')
open_system('sldemo_mdhref_basic/CounterA')
```

The referenced model opens in its own Simulink Editor window as a top model. To open the referenced model in the context of a model hierarchy, use the `open` function with a `Simulink.BlockPath` object.

Open Block Dialog Box

Open the block parameters dialog box for the first Gain block in the Controller subsystem.

```
load_system('f14')
open_system('f14/Controller/Gain')
```

Run Block Open Callback Function

Define an `OpenFcn` callback for a block and execute the block callback.

```
f14
set_param('f14/Pilot','OpenFcn','disp(''Hello World!'')')
open_system('f14/Pilot','OpenFcn')
```

The words `Hello World` appear on the MATLAB Command Prompt.

Open Masked Subsystem

Open the contents of the masked subsystem Pump in the model `sldemo_hydcyl`.

```
openExample('sldemo_hydcyl')
open_system('sldemo_hydcyl/Pump','force')
```

Open Multiple Systems with One Command

Create a cell array of two model names, `f14` and `vdp`. Open both models using `open_system` with the cell array name.

```
models = {'f14','vdp'}
open_system(models)
```

Input Arguments

obj — Model, referenced model, library, subsystem, or block path

character vector

Model, referenced model, library, subsystem, or block path, specified as a character vector. If the model is not on the MATLAB path, specify the full path to the model file. Specify the block or subsystem using its full name, e.g., `f14/Controller/Gain`, on an opened or loaded model. On UNIX systems, the fully qualified path name of a model can start with a tilde (~), signifying your home directory.

Data Types: `char`

sys — Model or library path

character vector

The full name or path of a model or library, specified as a character vector.

Data Types: `char`

sbsys — Subsystem path

character vector

The full name or path of a subsystem in an open or loaded model, specified as a character vector.

Data Types: `char`

blk — Block or subsystem path

character vector

The full name or path of a block or subsystem in an open or loaded model, specified as a character vector.

Data Types: `char`

Tips

To open a referenced model in the context of a model hierarchy, use the `open` function with a `Simulink.BlockPath` object.

See Also

`new_system` | `load_system` | `close_system` | `save_system` | `open` (`BlockPath`)

Introduced before R2006a

openDialog

Open configuration parameters dialog

Syntax

```
openDialog(configObj)
```

Arguments

configObj

A configuration set (`Simulink.ConfigSet`) or configuration reference (`Simulink.ConfigSetRef`)

Description

`openDialog` opens a configuration parameters dialog box. If *configObj* is a configuration set, the dialog box displays the configuration set. If *configObj* is a configuration reference, the dialog box displays the referenced configuration set, or generates an error if the reference does not specify a valid configuration set. If the dialog box is already open, its window becomes selected.

Examples

The following example opens a configuration parameters dialog box that shows the current parameters for the current model. The parameter values derive from the active configuration set or configuration reference (configuration object). The code is the same in either case; the only difference is which type of configuration object is currently active.

```
myConfigObj = getActiveConfigSet(gcs);  
openDialog(myConfigObj);
```

See Also

[attachConfigSet](#) | [attachConfigSetCopy](#) | [closeDialog](#) | [detachConfigSet](#) | [getActiveConfigSet](#) | [getConfigSet](#) | [getConfigSets](#) | [setActiveConfigSet](#)

Topics

“Manage Configuration Sets for a Model”

“Share a Configuration with Multiple Models”

Introduced in R2006b

openReport

Package: Simulink

Open MATLAB function report

Syntax

```
openReport(config)
```

Description

`openReport(config)` opens the MATLAB function report for a MATLAB Function block.

Examples

Open and Close MATLAB Function Report

Access the `MATLABFunctionConfiguration` object for the MATLAB Function block in the model `call_stats_block1` described in “Create Custom Functionality Using MATLAB Function Blocks”.

```
config = get_param('call_stats_block1/MATLAB Function', ...  
    'MATLABFunctionConfiguration');
```

Open the MATLAB function report.

```
openReport(config)
```

Close the MATLAB function report.

```
closeReport(config)
```

Input Arguments

config — MATLAB Function block property configuration

`MATLABFunctionConfiguration` object

MATLAB Function block property configuration, specified as a `MATLABFunctionConfiguration` object.

Data Types: `MATLABFunctionConfiguration`

Tips

The first time that you open the MATLAB function report, Simulink automatically updates your model. If you make subsequent changes to the MATLAB code in the block, you must update your model before you reopen the report. Otherwise, the report does not reflect your changes. From the **Modeling** tab, select **Update Model**, or press **Ctrl-D**. For more information, see “Update Diagram and Run Simulation”.

See Also

MATLAB Function | MATLABFunctionConfiguration | closeReport

Topics

“MATLAB Function Reports”

“Create Custom Functionality Using MATLAB Function Blocks”

Introduced in R2021a

parsim

Simulate dynamic system multiple times in parallel or serial

Syntax

```
simOut = parsim(in)
simOut = parsim(in, 'ShowSimulationManager', 'on')
simOut = parsim(in, Name, Value)
```

Description

`simOut = parsim(in)` simulates a model using the inputs specified in the `SimulationInput` object, `in`. The `parsim` command uses an array of `SimulationInput` objects to run multiple simulations.

`simOut = parsim(in, 'ShowSimulationManager', 'on')` simulates a model in parallel using the inputs specified in the `SimulationInput` object and opens the Simulation Manager UI. For more information, see `Simulation Manager`.

`simOut = parsim(in, Name, Value)` simulates a model in parallel using the inputs specified in the `SimulationInput` object and the options specified as the `Name, Value` pair.

The `parsim` command uses the Parallel Computing Toolbox license to run the simulations in parallel. `parsim` runs the simulations in serial if a parallel pool cannot be created or if Parallel Computing Toolbox is not used.

Examples

Using `parsim` with Rapid Accelerator

Simulate the model, `vdp`, in rapid accelerator mode.

Load the model.

```
model = 'vdp';
load_system(model)
```

This step builds the Rapid Accelerator target

```
Simulink.BlockDiagram.buildRapidAcceleratorTarget(model);
```

Create a `SimulationInput` object and use `setModelParameter` method to set `RapidAcceleratorUpToDateCheck` to 'off'.

```
in = Simulink.SimulationInput(model);
in = in.setModelParameter('SimulationMode', 'rapid-accelerator');
in = in.setModelParameter('RapidAcceleratorUpToDateCheck', 'off');
```

Simulate the model.

```
out = parsim(in)
```

Simulate Model in Parallel with parsim

Simulate the model, CSTR, in parallel by sweeping over a variable. An array of `SimulationInput` objects is used to perform the sweep.

Specify sweep values.

```
FeedTempSweep = 250:10:300;
```

Create an array of `SimulationInput` objects.

```
for i = length(FeedTempSweep):-1:1
in(i) = Simulink.SimulationInput('CSTR');
in(i) = in(i).setVariable('FeedTemp0',FeedTempSweep(i));
end
```

Simulate the model in parallel.

```
out = parsim(in, 'ShowProgress', 'on')
```

```
[11-Dec-2020 09:14:55] Checking for availability of parallel pool...
Starting parallel pool (parpool) using the 'local' profile ...
Connected to the parallel pool (number of workers: 6).
[11-Dec-2020 09:15:43] Starting Simulink on parallel workers...
[11-Dec-2020 09:16:17] Configuring simulation cache folder on parallel workers...
[11-Dec-2020 09:16:17] Loading model on parallel workers...
[11-Dec-2020 09:16:25] Running simulations...
[11-Dec-2020 09:16:58] Completed 1 of 6 simulation runs
[11-Dec-2020 09:16:58] Completed 2 of 6 simulation runs
[11-Dec-2020 09:16:58] Completed 3 of 6 simulation runs
[11-Dec-2020 09:17:00] Completed 4 of 6 simulation runs
[11-Dec-2020 09:17:01] Completed 5 of 6 simulation runs
[11-Dec-2020 09:17:01] Completed 6 of 6 simulation runs
[11-Dec-2020 09:17:02] Cleaning up parallel workers...
```

```
out =
```

```
1x6 Simulink.SimulationOutput array
```

Input Arguments

in — `Simulink.SimulationInput` object used to simulate the model
object, array

A `Simulink.SimulationInput` object or an array of `Simulink.SimulationInput` objects that is used to specify changes to the model for a simulation.

Example: `in = Simulink.SimulationInput('vdp')`

Name-Value Pair Arguments

Note All parameters passed to `parsim` command are unrelated to the parameters that are used with the `sim` command. To pass to the `parsim` command, use the list of following input arguments

Specify optional comma-separated pairs of `Name`, `Value` arguments. `Name` is the argument name and `Value` is the corresponding value. `Name` and `Value` must appear inside single quotes (' '). You can specify several name and value pair arguments in any order as `Name1, Value1, ..., NameN, ValueN`.

Example: `'ShowProgress', 'on'`

AttachedFiles — Files to attach to parallel pool

cell array

Specified as a cell array of additional files to attach to the parallel pool.

ShowProgress — Show the progress of the simulations

'on'(default) | 'off'

Set to 'on', to see the progress of the simulations in the command window. The progress is hidden when set to 'off'.

Note When the progress is shown, a message 'Cleaning up parallel workers..' may be displayed before the completion of the last few simulations. This message does not depend on the completion of the simulations. Simulations complete when the outputs are fetched from the future. For more information, see `Simulink.Simulation.Future`.

RunInBackground — Run simulations in background

'off' (default) | 'on'

Set to 'on' to run simulations asynchronously, keeping the MATLAB command prompt available for use.

SetupFcn — Function handle to run once per worker

function handle

Specify a function handle to 'SetupFcn' to run once per worker before the start of the simulations.

Example: `'SetupFcn',@()currentProject('Modelex/Model_example.prj')`

Note When `buildRapidAcceleratorTarget` is used in the `SetupFcn` and the model has external inputs specified, either set 'LoadExternalInput' to 'off' or ensure that the specified external input is available on the workers to prevent compilation error.

CleanupFcn — Function handle to run once per worker after running simulations

function handle

Specify a function handle to 'CleanupFcn' to run once per worker after the simulations are completed.

ManageDependencies — Manage model dependencies

'on' (default) | 'off'

When `ManageDependencies` is set to on, model dependencies are automatically sent to the parallel workers if required. If `ManageDependencies` is set to off, explicitly attach model dependencies to the parallel pool.

UseFastRestart — Use fast restart

'off' (default) | 'on'

When `UseFastRestart` is set to on, simulations run on the workers using fast restart.

When performing a parameter sweep varying properties of a Simscape component (e.g. mass and inertia of a Solid block in Simscape Multibody), specify the Simscape block parameter as run-time configurable. For more information, see “About Simscape Run-Time Parameters” (Simscape).

Note When using `parsim`, use the `UseFastRestart` option and not the `FastRestart` option. See “Get Started with Fast Restart” for more information.

TransferBaseWorkspaceVariables — Transfer variables to the parallel workers

'off' (default) | 'on'

When `TransferBaseWorkspaceVariables` is set to on, variables used in the model and everything defined in the base workspace are transferred to the parallel workers.

ShowSimulationManager — Starts the Simulation Manager app

'off' (default) | 'on'

When '`ShowSimulationManager`' is set to 'on', you can use the Simulation Manager App to monitor simulations.

StopOnError — Stop simulations on errors

'off' (default) | 'on'

Setting '`StopOnError`' to 'on' stops the execution of simulations if an error is encountered.

Output Arguments

simOut — Simulation object containing logged simulation results

object

Array of `Simulink.SimulationOutput` objects that contains all of the logged simulation results. The size of the array is equal to the size of the array of `Simulink.SimulationInput` objects.

All simulation outputs (logged time, states, and signals) are returned in a single `Simulink.SimulationOutput` object. You define the model time, states, and output that is logged using the **Data Import/Export** pane of the Model Configuration Parameters dialog box. You can log signals using blocks such as the To Workspace and Scope blocks. The **Signal & Scope Manager** can directly log signals.

Extended Capabilities

Automatic Parallel Support

Accelerate code by automatically running computation in parallel using Parallel Computing Toolbox™.

If you have Parallel Computing Toolbox installed, then when you use `parsim`, MATLAB automatically opens a parallel pool of workers on your local machine. MATLAB runs the simulations across the available workers. Control parallel behavior with the parallel preferences, including scaling up to a cluster.

For details, see “Running Multiple Simulations”.

See Also

`Simulink.SimulationInput` | `Simulink.Simulation.Future` | `applyToModel` | `setBlockParameter` | `setModelParameter` | `setInitialState` | `ExternalInput` | `setVariable` | `validate` | `setPreSimFcn` | `setPostSimFcn` | `Simulation Manager` | `cancel` | `fetchNext` | `fetchOutputs` | `wait`

Topics

“Rapid Accelerator Simulations Using Parsim” on page 13-607

“Parallel Simulations Using Parsim: Test-Case Sweep” on page 13-595

“Parallel Simulations Using Parsim: Parameter Sweep in Normal Mode” on page 13-599

“Parallel Simulations Using Parsim: Parameter Sweep in Rapid Accelerator Mode” on page 13-603

“Running Multiple Simulations”

“Run Parallel Simulations for a Thermal Model of a House Using parsim”

“Run Parallel Simulations”

Introduced in R2017a

performanceadvisor

Open Performance Advisor

Syntax

```
performanceadvisor(model)
```

Description

`performanceadvisor(model)` opens the Performance Advisor on the model or subsystem specified by `model`. If the specified model or subsystem is not open, this command opens it.

Input Arguments

model

A character vector specifying the name or handle to the model or subsystem.

Examples

Open Performance Advisor

Open Performance Advisor on the `vdp` example model.

```
performanceadvisor('vdp')
```

Performance Advisor opens the `vdp` model and opens Performance Advisor on the model.

Alternatives

In the Simulink Editor, in the **Debug** tab, click **Performance Advisor**.

See Also

Topics

“Improve Simulation Performance Using Performance Advisor”

“Perform a Quick Scan Diagnosis”

“Improve vdp Model Performance”

Introduced in R2013a

polyspacePackNGo

Generate and package options files to run Polyspace analysis on code generated from Simulink model

Syntax

```
archivePath = polyspacePackNGo mdlName)
archivePath = polyspacePackNGo mdlName, psOpt)
archivePath = polyspacePackNGo mdlName, psOpt, asModelRef)
```

Description

`archivePath = polyspacePackNGo mdlName)` examines the Simulink model `mdlName`, extracts Polyspace® options files from it, and packages the options files in the zip file located at `archivePath`. Before using `polyspacePackNGo`, generate code from your Simulink model. Then archive the generated code, for instance, by using `packNGo`. Generate the Polyspace options files from the Simulink model and include them in the code archive by using `polyspacePackNGo`. In a different development environment, when running a Polyspace analysis of the generated code, use the options files included in the code archive to preserve model-specific information, such as design range specifications. You must have Embedded Coder to use `slbuild`.

`archivePath = polyspacePackNGo mdlName, psOpt)` generates and packages the Polyspace options files that are generated according to the specification in `psOpt`. The object `psOpt` must be a Polyspace options object that is generated by using `pslinkoptions`. Using `psOpt`, modify the options for the Polyspace analysis.

`archivePath = polyspacePackNGo mdlName, psOpt, asModelRef)` generates and packages the Polyspace options files by using `asModelRef` to specify whether to generate option files for model reference code or standalone code.

Examples

Generate and Package Polyspace Options Files

To generate and package Polyspace options files for a Simulink model, use `polyspacePackNGo`.

Open the Simulink model `rtwdemo_counter` and specify a folder for storing the generated code.

```
% Make temporary folders for code generation
[TEMPDIR, CGDIR] = rtwdemodir();
% Open the model
mdlName = 'rtwdemo_counter';
open_system(mdlName);
% Specify a folder for generated code
codegenFolder = 'rtwdemo_counter_ert_rtw';
```

To enable packing the generated code in an archive, set the option `PackageGeneratedCodeAndArtifacts` to `true`. Specify the name of the generated code archive as `genCodeArchive.zip`.

```
configSet = getActiveConfigSet mdlName);
set_param(configSet, 'PackageGeneratedCodeAndArtifacts', true);
set_param(configSet, 'PackageName', 'genCodeArchive.zip');
```

To make the model compatible with Polyspace, set `SystemTargetFile` to `ert.tlc`.

```
set_param(configSet, 'SystemTargetFile', 'ert.tlc');
```

After configuring the model, generate code.

```
slbuild mdlName)
```

Because `PackageGeneratedCodeAndArtifacts` is set to `true`, the generated code is packed into the archive `genCodeArchive.zip`.

Generate and package Polyspace options files.

```
zipFile = polyspacePackNGo mdlName);
```

In the code archive `genCodeArchive.zip`, the Polyspace options files are packaged in the `polyspace` folder.

Package Polyspace Options Files That Have Specific Polyspace Analysis Options

To specify the Polyspace analysis options when packaging and generating options files, use `pslinktoptions`.

Open the Simulink model `rtwdemo_counter` and configure the model for generating a code archive that is compatible with Polyspace.

```
% Make temporary folders for code generation
[TEMPDIR, CGDIR] = rtwdemodir();
% Open the model
mdlName = 'rtwdemo_counter';
open_system mdlName);
% Specify a folder for generated code
codegenFolder = 'rtwdemo_counter_ert_rtw';
configSet = getActiveConfigSet mdlName);
% Enable packing the generated code into an archive
set_param(configSet, 'PackageGeneratedCodeAndArtifacts', true);
% Specify a name for the code archive
set_param(configSet, 'PackageName', 'genCodeArchive.zip');
% Configure the model to be Polyspace Compatible
set_param(configSet, 'SystemTargetFile', 'ert.tlc');
```

After configuring the model, generate code.

```
slbuild mdlName)
```

Because `PackageGeneratedCodeAndArtifacts` is set to `true`, the generated code is packed into the archive `genCodeArchive.zip`.

To specify the model configuration for the Polyspace analysis, use a `pslinktoptions` object. Create this object by using the function `pslinktoptions`.

```
psOpt = pslinktoptions mdlName);
```

The object `psOpt` is a structure where the fields are model configurations that you can specify.

Specify the model configuration by using `psOpt` object. For instance, set `InputRangeMode` to full range. For a full options list, see the input argument `psOpt`.

```
psOpt.InputRangeMode = 'FullRange';
```

Generate and package Polyspace options files. Use the `psOpt` object as the second argument in `polyspacePacknGo`.

```
zipFile = polyspacePacknGo mdlName, psOpt);
```

In the code archive `genCodeArchive.zip`, the Polyspace options files are packaged in the `polyspace` folder. The file `optionsFile.txt` contains the specified Polyspace analysis options.

Package Polyspace Options Files for Code Generated as a Model Reference

To accelerate model simulations, invoke referenced Simulink models as simulation targets. To generate model reference simulation targets from a Simulink model, generate code from the model by using `slbuild` with the build process specified as `ModelReferenceCoderTargetOnly`. Then, package the generated code by using `packnGo`. To generate and package Polyspace options files for analyzing such code, use the function `polyspacePacknGo` with the optional argument `asModelRef` set to `true`.

Open the Simulink model `rtwdemo_counter` and configure the model for generating a code archive that is compatible with Polyspace.

```
% Make temporary folders for code generation
[TEMPDIR, CGDIR] = rtwmoddir();
% Load model
mdlName = 'rtwdemo_counter';
load_system(mdlName);
configSet = getActiveConfigSet(mdlName);
% Enable packing the generated code into an archive
set_param(configSet, 'PackageGeneratedCodeAndArtifacts', true);
set_param(configSet, 'PackageName', '');
% Configure the model to be Polyspace Compatible
set_param(configSet, 'SystemTargetFile', 'ert.tlc');
```

After configuring the model, generate a model reference simulation target from it by using the function `slbuild`. Specify the option `ModelReferenceCoderTargetOnly`. See `slbuild`.

```
slbuild(mdlName, 'ModelReferenceCoderTargetOnly');
```

The code that is generated is stored in the folder `slprj`.

To package the code that is generated as a model reference, use the function `packnGo`. Locate the file `buildinfo.mat` in `<working folder>/slprj/ert/rtwdemo_counter` and use the full path to it as the input to `packnGo`. This command generates an archive containing the generated code and the object `buildinfo.mat`. See `packnGo`.

```
% Locate buildinfo and generate code archive
buildinfo = fullfile(pwd, 'slprj', 'ert', mdlName, 'buildinfo.mat');
packnGo(buildinfo)
```

Generate and package Polyspace options files. Omit the optional second argument. Set the third argument `asModelRef` to `true`.

```
zipFile = polyspacePackNGo mdlName, [], true);
```

In the code archive `rtwdemo_counter.zip`, the Polyspace options files are packaged in the `polyspace` folder.

Input Arguments

mdlName — Name of Simulink model for which to generate Polyspace options files

model name

A character array containing the name of the model for which you want to generate and package the Polyspace options files.

Example: `polyspacePackNGo('rtwdemo_roll')`

Data Types: `char`

psOpt — Polyspace options object

options associated with `model` (default) | object created by using `pslinkoptions`

Specifies the model configuration for the Polyspace analysis by using a `pslinkoptions` object. You can modify certain analysis options by modifying `psOpt`, which is a structure where individual fields represent analysis options. For a full list of options that you can modify, see the table **Polyspace Analysis Options Supported by polyspacePackNGo**.

Polyspace Analysis Options Supported by polyspacePacknGo

| Property | Value | Description |
|--|--------------------------------|--|
| EnableAdditionalFileList: Enable an additional file list to be analyzed, specified as true or false. Use with the AdditionalFileList option. | true | Polyspace verifies additional files specified in the AdditionalFileList option. |
| | false (default) | Polyspace does not verify additional files. |
| AdditionalFileList: List of additional files to be analyzed specified as a cell array of files. To add these files to the analysis, use the EnableAdditionalFileList option. | cell array | Polyspace considers the listed files for verification. |
| InputRangeMode: Specifies the range of the input variables. | 'DesignMinMax' (default) | Polyspace uses the input range defined in the workspace or a block. |
| | 'Fullrange' | Polyspace uses full range inputs. |
| ParamRangeMode: Specifies the range of the constant parameters. | 'DesignMinmax' | Polyspace uses the constant parameter range defined in the workspace or in a block. |
| | 'None' (default) | Polyspace uses the value of parameters specified in the code. |
| OutputRangeMode: Specifies the output assertions. | 'DesignMinMax' | Polyspace applies assertions to outputs by using a range defined in a block or the workspace. |
| | 'None' (default) | Polyspace does not apply assertions to the output variables. |
| ModelRefVerifDepth: Specify the depth for analyzing the models that are referenced by the current model. | 'Current model Only' (default) | Polyspace analyzes only the top model without analyzing the referenced models. Use this option when you refer to models that do not need to be analyzed, such as library models. |

| Property | Value | Description |
|--|--------------------|---|
| | '1' '2' '3' | Polyspace analyzes referenced models up to the specified depth in the reference hierarchy. To analyze the models that are referenced by the top model, specify the property <code>ModelRefVerifDepth</code> as '1'. To analyze models that are referenced by the first level of references, specify this property as '2'. |
| | 'All' | Polyspace verifies all referenced models. |
| ModelRefByModelRefVerif: Specify whether you want to analyze all referenced models together or individually. | true | Polyspace analyzes the top model and the referenced models together. Use this option to check for integration or scaling issues. |
| | false (default) | Polyspace analyzes the top model and the referenced models individually. |
| AutoStubLUT: Specifies how lookup tables are used. | true (default) | Polyspace stubs the lookup tables and verifies the model without analyzing the lookup table code. |
| | false | Polyspace includes the lookup table code in the analysis. |
| CheckConfigBeforeAnalysis: Specifies the level of configuration checking done before the Polyspace analysis starts. | 'Off' | Polyspace checks only for errors. The analysis stops if errors are found. |
| | 'OnWarn' (default) | Polyspace stops the analysis when errors are found and displays a message when warnings are found. |
| | 'OnHalt' | Polyspace stops the analysis when either errors or warnings are found. |

Example: `polyspacePackNGo('rtwdemo_roll', psOpt)`, where `ps_opt` is an options object created by calling `pslinkoptions`

asModelRef – Indicator for model reference analysis

false (default) | true

Indicator for model reference analysis, specified as true or false.

- If `asModelRef` is false (default), the function generates options files so that Polyspace analyzes the generated code as standalone code.

- If `asModelRef` is `true`, the function generates options files so that Polyspace analyzes the generated code as model reference code.

Note If you set `asModelRef` to `true`, use `slbuild` to generate code.

Example: `polyspacePackNGo('rtwdemo_roll', psOpt,true)`

Data Types: `logical`

Output Arguments

archivePath — The full path to the archive containing the generated options files

path to archive

A character array containing the path to the generated archive. The options files are located in the `polyspace` folder in the archive. The `polyspace` folder contains these options files:

- `optionsFile.txt`: a text file containing the Polyspace options required to run a Polyspace analysis on the generated code without losing model-specific information, such as design range specification.
- `model_drs.xml`: A file containing the design range specification of the model.
- `linkdata.xml`: A file that links the generated code to the components of the model.

To run a Polyspace analysis on the generated code in an environment that is different than the environment where the code was generated from the Simulink model, use these files.

Data Types: `char`

See Also

`slbuild` | `pslinkoptions`

Topics

“Run Polyspace Analysis on Generated Code by Using Packaged Options Files” (Polyspace Bug Finder)

Introduced in R2020b

pslinkoptions

Create an options object to customize configuration of a Simulink model, generated code or a S-Function block. Use the object to specify configuration options for these Simulink objects in a Polyspace run from the MATLAB command line

Syntax

```
opts = pslinkoptions(codegen)
opts = pslinkoptions(model)
opts = pslinkoptions(sfunc)
```

Description

`opts = pslinkoptions(codegen)` returns an options object with the configuration options for code generated by codegen.

`opts = pslinkoptions(model)` returns an options object with the configuration options for the Simulink model.

`opts = pslinkoptions(sfunc)` returns an options object with the configuration options for the S-Function.

Note Before you run Polyspace from MATLAB, you must link your Polyspace and MATLAB installations. See “Integrate Polyspace with MATLAB and Simulink” (Polyspace Bug Finder).

Examples

Create generic options object for code generated by Embedded Coder

This example shows how you can create a generic Polyspace options object that is suitable for analyzing code generated by using Embedded Coder. This options object is prepopulated with appropriate Embedded Coder parameters. Edit the options object to modify the generic analysis.

Create a new Polyspace configuration object `new_opt` by calling the function `pslinkoptions` and specify `'ec'` as the input argument.

```
new_opt = pslinkoptions('ec')
new_opt =
    ResultDir: 'results_ $ModelName$'
    VerificationSettings: 'PrjConfig'
    OpenProjectManager: 0
    AddSuffixToResultDir: 0
    EnableAdditionalFileList: 0
    AdditionalFileList: {}
    VerificationMode: 'BugFinder'
    EnablePrjConfigFile: 0
```

```

        PrjConfigFile: ''
    AddToSimulinkProject: 0
        InputRangeMode: 'DesignMinMax'
        ParamRangeMode: 'None'
        OutputRangeMode: 'None'
        ModelRefVerifDepth: 'Current model only'
    ModelRefByModelRefVerif: 0
        AutoStubLUT: 1
    CxxVerificationSettings: 'PrjConfig'
    CheckConfigBeforeAnalysis: 'OnWarn'
    VerifAllSFcnInstances: 0

```

By default, this options object uses the same verification settings that you specify in the Polyspace project. To check MISRA C® 2012 coding rule violations in addition to the existing verifications specified in the project, run this code at the MATLAB command line:

```
new_opt.VerificationSettings = 'PrjConfigAndMisraC2012'
```

```
new_opt =
```

```

        ResultDir: 'results_ $ModelName$'
    VerificationSettings: 'PrjConfigAndMisraC2012'
        OpenProjectManager: 0
        AddSuffixToResultDir: 0
    EnableAdditionalFileList: 0
        AdditionalFileList: {}
        VerificationMode: 'BugFinder'
        EnablePrjConfigFile: 0
        PrjConfigFile: ''
    AddToSimulinkProject: 0
        InputRangeMode: 'DesignMinMax'
        ParamRangeMode: 'None'
        OutputRangeMode: 'None'
        ModelRefVerifDepth: 'Current model only'
    ModelRefByModelRefVerif: 0
        AutoStubLUT: 1
    CxxVerificationSettings: 'PrjConfig'
    CheckConfigBeforeAnalysis: 'OnWarn'
    VerifAllSFcnInstances: 0

```

When you start the Polyspace analysis of the generated code, you might want to open the Polyspace User Interface to follow the progress of the and to review the results afterwards. To open the Polyspace interface when you start the analysis, run this code:

```
new_opt.OpenProjectManager = true
```

```
new_opt =
```

```

        ResultDir: 'results_ $ModelName$'
    VerificationSettings: 'PrjConfigAndMisraC2012'
        OpenProjectManager: 1
        AddSuffixToResultDir: 0
    EnableAdditionalFileList: 0
        AdditionalFileList: {}
        VerificationMode: 'BugFinder'
        EnablePrjConfigFile: 0
        PrjConfigFile: ''
    AddToSimulinkProject: 0

```



```

        InputRangeMode: 'DesignMinMax'
        ParamRangeMode: 'None'
        OutputRangeMode: 'None'
        ModelRefVerifDepth: 'Current model only'
ModelRefByModelRefVerif: 0
        AutoStubLUT: 1
        CxxVerificationSettings: 'PrjConfig'
CheckConfigBeforeAnalysis: 'OnWarn'
        VerifAllSFcnInstances: 0

```

Create and edit options object to modify Polyspace configuration

This example shows how you can store the Polyspace configurations of a Simulink model in to an object, and use the object to edit the configuration options.

Load the model `closed_loop_control`.

```
load_system('closed_loop_control');
```

To create an object containing the Polyspace configurations of the model, call `pslinkoptions`.

```
model_opt = pslinkoptions('closed_loop_control')
```

```
model_opt =
```

```

        ResultDir: 'results_ $ModelName$'
VerificationSettings: 'PrjConfig'
        OpenProjectManager: 0
        AddSuffixToResultDir: 0
EnableAdditionalFileList: 0
        AdditionalFileList: {}
        VerificationMode: 'BugFinder'
        EnablePrjConfigFile: 0
        PrjConfigFile: ''
AddToSimulinkProject: 0
        InputRangeMode: 'DesignMinMax'
        ParamRangeMode: 'None'
        OutputRangeMode: 'None'
        ModelRefVerifDepth: 'Current model only'
ModelRefByModelRefVerif: 0
        AutoStubLUT: 1
        CxxVerificationSettings: 'PrjConfig'
CheckConfigBeforeAnalysis: 'OnWarn'
        VerifAllSFcnInstances: 0

```

The model is already configured for Embedded Coder®, so only the Embedded Coder configuration options appear as the fields of the object `model_opt`.

To modify a Polyspace configuration option, set the corresponding field of `model_opt`. For instance, change the results directory and set the verification mode to CodeProver by modifying fields : `model_opt.ResultDir` and `model_opt.VerificationMode`, respectively.

```
model_opt.ResultDir = 'results_v1_ $ModelName$';
model_opt.VerificationMode = 'CodeProver'
```

```
model_opt =  
    ResultDir: 'results_v1_$(ModelName)'  
    VerificationSettings: 'PrjConfig'  
    OpenProjectManager: 0  
    AddSuffixToResultDir: 0  
    EnableAdditionalFileList: 0  
    AdditionalFileList: {}  
    VerificationMode: 'CodeProver'  
    EnablePrjConfigFile: 0  
    PrjConfigFile: ''  
    AddToSimulinkProject: 0  
    InputRangeMode: 'DesignMinMax'  
    ParamRangeMode: 'None'  
    OutputRangeMode: 'None'  
    ModelRefVerifDepth: 'Current model only'  
    ModelRefByModelRefVerif: 0  
    AutoStubLUT: 1  
    CxxVerificationSettings: 'PrjConfig'  
    CheckConfigBeforeAnalysis: 'OnWarn'  
    VerifAllSFcnInstances: 0
```

Create and edit an options object for TargetLink at the command line

Create a Polyspace® options object called `new_opt` with TargetLink® parameters:

```
new_opt = pslinkoptions('tl')  
new_opt =  
    ResultDir: 'results_$(ModelName)'  
    VerificationSettings: 'PrjConfig'  
    OpenProjectManager: 0  
    AddSuffixToResultDir: 0  
    EnableAdditionalFileList: 0  
    AdditionalFileList: {}  
    VerificationMode: 'CodeProver'  
    EnablePrjConfigFile: 0  
    PrjConfigFile: ''  
    AddToSimulinkProject: 0  
    InputRangeMode: 'DesignMinMax'  
    ParamRangeMode: 'None'  
    OutputRangeMode: 'None'  
    AutoStubLUT: 1
```

Set the `OpenProjectManager` option to true to follow the progress in the Polyspace interface. Also change the configuration to check for both run-time errors and MISRA C® coding rule violations:

```
new_opt.OpenProjectManager = true;  
new_opt.VerificationSettings = 'PrjConfigAndMisra'  
new_opt =  
    ResultDir: 'results_$(ModelName)'  
    VerificationSettings: 'PrjConfigAndMisra'  
    OpenProjectManager: 1
```

```

    AddSuffixToResultDir: 0
    EnableAdditionalFileList: 0
        AdditionalFileList: {}
        VerificationMode: 'CodeProver'
    EnablePrjConfigFile: 0
        PrjConfigFile: ''
    AddToSimulinkProject: 0
        InputRangeMode: 'DesignMinMax'
        ParamRangeMode: 'None'
        OutputRangeMode: 'None'
        AutoStubLUT: 1

```

Input Arguments

codegen — Code generator

'ec' | 'tl'

Code generator, specified as either 'ec' for Embedded Coder or 'tl' for TargetLink®. Each argument creates a Polyspace options object with properties specific to that code generator.

For a description of all configuration options and their values, see `pslinkoptions`.

Example: `ec_opt = pslinkoptions('ec')`

Example: `tl_opt = pslinkoptions('tl')`

Data Types: char

model — Simulink model name

model name

Simulink model, specified by the model name. Creates a Polyspace options object with the configuration options of that model. If you have not set any options, the object has the default configuration options. If you have set a code generator, the object has the default options for that code generator.

For a description of all configuration options and their values, see `pslinkoptions`.

Example: `model_opt = pslinkoptions('my_model')`

Data Types: char

sfunc — path to S-Function

character vector

Path to S-Function, specified as a character vector. Creates a Polyspace options object with the configuration options for the S-function. If you have not set any options, the object has the default configuration options.

For a description of all configuration options and their values, see `pslinkoptions`.

Example: `sfunc_opt = pslinkoptions('path/to/sfunction')`

Data Types: char

Output Arguments

opts — Polyspace configuration options

options object

Polyspace configuration options, returned as an options object. The object is used with `pslinkrun` to run Polyspace from the MATLAB command line.

For the list of object properties, see `pslinkoptions`.

```
Example: opts= pslinkoptions('ec')  
opts.VerificationSettings = 'Misra'
```

See Also

`pslinkoptions`

Introduced in R2012a

rehashUnitDBs

Refresh unit database files on MATLAB path

Syntax

rehashUnitDBs

Description

rehashUnitDBs refreshes unit database files on the MATLAB path. To load a custom unit database, use this function in conjunction with the createCustomDBFromExcel function.

The rehashUnitDBs function:

- Clears all previously loaded custom units in memory.
- Resets the set of supported units to the built-in set of units.
- Looks for database files with the extension `.slunitdb.mldtax` on the MATLAB path and loads those databases.
- Issues warnings if units with the same names are loaded. If units have several definitions with the same name in different databases, by default the function tries to use the definition in a built-in units databases. If the unit is not defined in a built-in database, the function uses the definition in the database highest on the MATLAB path.

To see the supported spreadsheet format, see “Custom Units Spreadsheet Format”.

Examples

Create Custom Units Database File from Excel Spreadsheet

Create a custom units database file from custom Excel spreadsheet file, `unitsDB.xlsx`.

Create a Excel spreadsheet containing these columns and data in any order:

- **name**, containing `ounce_force`
- **symbol**, containing `oz f`
- **asciiSymbol**, containing `oz f`
- **displayName**, containing `{\rm{oz}_{force}}`
- **definitionExpression**, containing `oz*gn`
- **conversionFactor**, containing `1`
- **conversionOffset**, containing `0`
- **physicalQuantity**, containing `force`

Enter your custom unit specifications.

Save the database file, for example `unitsDB.xlsx`.

Create the database.

```
createCustomDBFromExcel('unitsDB.xlsx')
```

The function creates `unitsDB.slunitdb.mldatx` in the current folder.

Add the current folder to the MATLAB path.

```
addpath C:\work\custom_units
```

Load the new units database into memory.

```
rehashUnitDBs
```

See Also

[createCustomDBFromExcel](#) | [Unit System Configuration](#) | [Unit Conversion](#)

Topics

[“Working with Custom Unit Databases”](#)

[“Unit Specification in Simulink Models”](#)

[“Displaying Units”](#)

[“Unit Consistency Checking and Propagation”](#)

[“Converting Units”](#)

Introduced in R2020a

replace_block

Replace blocks in Simulink model

Syntax

```
replBlks = replace_block(sys,current,new)
replBlks = replace_block(sys,Name,Value,new)
replBlks = replace_block( ____, 'noprompt')
```

Description

`replBlks = replace_block(sys,current,new)` replaces the blocks `current` in the model `sys` with blocks of type `new`. You can use a block from a Simulink library or from another model as the replacement block.

Load the model `sys` before using this function. The function prompts you to select the blocks you want to replace from a list of blocks that match the `current` argument.

Tip Save the model before using this command.

`replBlks = replace_block(sys,Name,Value,new)` replaces the blocks that match the block parameters specified by the `Name,Value` pair arguments. You can also use `find_system` `Name,Value` pairs to qualify the search for blocks to replace.

Specify optional comma-separated pairs of `Name,Value` arguments. `Name` is the argument name and `Value` is the corresponding value. `Name` must appear inside quotes. You can specify several name and value pair arguments in any order as `Name1,Value1,...,NameN,ValueN`.

With the `replace_block` function, you can use block parameter and value pairs. For a list of all the block parameters, see “Common Block Properties” on page 6-12 and “Block-Specific Parameters” on page 6-26.

To specify additional information about the search for blocks to replace, you use `find_system` `Name,Value` pairs before the block parameters. For example, you can use `'CaseSensitive','off'` to make the search for blocks case insensitive or `'FollowLinks','on'` to follow links into library links. See `find_system` for that list of `Name,Value` pairs.

`replBlks = replace_block(____, 'noprompt')` replaces the blocks without prompting you to select them from a dialog box.

Examples

Replace Blocks in a Model

Replace blocks in the 'vdp' model.

Load the model 'vdp'.

```
load_system('vdp');
```

Replace Gain blocks with Integrator blocks.

```
RepNames = replace_block('vdp','Gain','Integrator');
```

A dialog box prompts you to select the blocks you want to replace.

With vdp/Mu selected in the dialog box, click **OK**.

Replace Scope blocks with To Workspace blocks.

```
RepNames = replace_block('vdp','Scope','simulink/Sinks/To Workspace');
```

A dialog box prompts you to select the blocks you want to replace.

With vdp/Scope selected in the dialog box, click **OK**.

Replace Blocks in a Subsystem Using Parameter Values

Replace blocks in the Unlocked subsystem of the `sldemo_clutch` model. Replace blocks whose Gain parameter is set to `bv`.

Load the model `sldemo_clutch`.

```
openExample('sldemo_clutch');
```

In the 'Unlocked' subsystem, replace blocks whose Gain value is `bv` with Integrator blocks.

```
replace_block('sldemo_clutch/Unlocked','Gain','bv','Integrator');
```

A dialog box prompts you to select the blocks to replace.

With `sldemo_clutch/Unlocked/VehicleDamping` selected in the dialog box, click **OK**.

Replace Blocks Without Dialog Box

Load the model `f14`.

```
load_system('f14')
```

Replace Gain blocks with Integrator blocks. The command returns the blocks it found to replace and replaces the blocks.

```
repl = replace_block('f14','Gain','Integrator','noprompt')
```

```
repl = 13x1 cell
    {'f14/Aircraft...'}
    {'f14/Aircraft...'}
    {'f14/Aircraft...'}
    {'f14/Aircraft...'}
    {'f14/Controller/Gain'}
    {'f14/Controller/Gain2'}
    {'f14/Controller/Gain3'}
```



```

{'f14/Gain'           }
{'f14/Gain1'         }
{'f14/Gain2'         }
{'f14/Gain5'         }
{'f14/Nz pilot...'  }
{'f14/Nz pilot...'  }

```

Use find_system Pairs with replace_block

Select a block that is a library link. Follow the library links and replace Gain blocks with Integrator blocks within them.

```
replace_block(gcb, 'FollowLinks', 'on', 'BlockType', 'Gain', 'Integrator', 'noprompt')
```

Input Arguments

sys — Model or subsystem whose blocks to replace

character vector

Name of model whose blocks to replace, specified as a character vector. If you specify a model, the command replaces all blocks that match in the model. If you specify a subsystem, the command replaces blocks in that subsystem and below.

Example: 'vdp', 'sldemo_fuelsys/fuel_rate_control'

current — Type of block to replace

BlockType value | MaskType value

Type of block to replace, specified as a BlockType or MaskType value. To find out the block type, select the block and, at the command prompt, enter:

```
get_param(gcb, 'BlockType')
```

For masked blocks, to find out the mask type, select the block and enter:

```
get_param(gcb, 'MaskType')
```

new — Block to replace current blocks

BlockType value | MaskType value | library path | block path name from a model

Block to replace the current block, specified in one of these forms:

- BlockType value of the replacement block. Specifying this value uses a library block as the replacement block.
- MaskType value of the replacement block. Specifying this value uses a library block as the replacement block.
- Library path of the replacement block, for example, 'simulink/Sinks/To Workspace'. Hover over the block in the library to see the library path.
- Block path name of a block from a different model, for example, 'vdp/Mu'. Use this value to reuse an instance of a block from another model in your model.

Output Arguments

replBlks — Blocks returned by the current argument

cell array of character vectors

Blocks returned by the `current` argument, returned as a cell array of character vectors. The function returns the values regardless of whether you complete the replacement.

See Also

`find_system` | `get_param`

Topics

“Common Block Properties” on page 6-12

“Block-Specific Parameters” on page 6-26

Introduced before R2006a

save_system

Save Simulink model

Syntax

```
filename = save_system
filename = save_system(sys)
filename = save_system(sys,newsys)
filename = save_system(sys,newsys,Name,Value)
```

Description

`filename = save_system` saves the current top-level model. If the model was not previously saved, `save_system` creates a file in the current folder.

To save a subsystem, instead use `Simulink.SubSystem.copyContentsToBlockDiagram` to copy the subsystem contents to a new model. You can then save that model using `save_system`. See `Simulink.SubSystem.copyContentsToBlockDiagram`.

`filename = save_system(sys)` saves the model `sys`. The model must be open or loaded.

`filename = save_system(sys,newsys)` saves the model to a new file `newsys`. If you do not specify an extension, then `save_system` uses the file format specified in your Simulink preferences.

`filename = save_system(sys,newsys,Name,Value)` saves the system with additional options specified by one or more `Name,Value` pair arguments. To use `Name,Value` pairs without saving to a new file, use `[]` for `newsys`.

Examples

Save Named Model

Create a model.

```
new_system('newmodel')
```

Save the model.

```
save_system('newmodel')
```

Save Model with Another Name

Open the model `vdp`. Save it to a model named `myvdp` in the current folder. Without a file extension, the function saves the model using the format specified in your Simulink preferences.

```
open_system('vdp')
save_system('vdp','myvdp')
```

After you save the model by another name, the model is no longer open under its original name. Open vdp again and save it as an .mdl file in the current folder.

```
open_system('vdp')
save_system('vdp','mynewvdp.mdl')
```

Return Error If Name Exists

Save a model with a new name and return an error if something with this name exists on the MATLAB path. In this case, `save_system` displays an error because `max` is the name of a MATLAB function. The model is not saved.

```
open_system('vdp')
save_system('vdp','max','ErrorIfShadowed',true)
```

```
Error using save_system (line 38)
The model 'vdp' cannot be saved with the new name 'max', because this name is
shadowing another name on the MATLAB path or in the workspace. Choose another
name, or do not use the option 'ErrorIfShadowed'
```

Save Model with Options

Suppose that you have a model named `mymodel`. Open the model and save it to a model named `newmodel`. Also save the model workspace, break links to user-defined library blocks, and overwrite if the file has changed on disk,

```
open_system('mymodel')
save_system('mymodel','mynewmodel','SaveModelWorkspace',
true,'BreakUserLinks',true,'OverwriteIfChangedOnDisk',true)
```

Save Model to Same Name and Use Options

Save the model `mymodel`, breaking links to user-defined library blocks in the model.

```
save_system('mymodel',[],'BreakUserLinks',true)
```

Input Arguments

sys — Name of model to save

character vector | cell array of character vectors | string array | handle | array of handles

Name of model to save, specified as a character, cell array of character vectors, string array, handle, or array of handles. Do not use a file extension.

newsys — File to save to

character vector | cell array of character vectors | string array | []

File to save to, specified as a character vector, cell array of character vectors, string array, or, to use `Name, Value` pairs without changing the file name, []. You can specify a model name in the current folder or the full path name, with or without an extension.

With no an extension, `save_system` saves to the file format specified in your Simulink preferences. Possible model extensions are `.slx` and `.mdl`. With the 'ExportToXML' option, use the extension `.xml`.

For information on rules for naming models, see “Model Names”.

Name-Value Pair Arguments

Specify optional comma-separated pairs of `Name`, `Value` arguments. `Name` is the argument name and `Value` is the corresponding value. `Name` must appear inside quotes. You can specify several name and value pair arguments in any order as `Name1, Value1, . . . , NameN, ValueN`.

Example:

```
save_system('mymodel', 'newmodel', 'SaveModelWorkspace', true, 'BreakUserLinks', true, 'OverwriteIfChangedOnDisk', true)
```

AllowPrompt — Allow dialog box prompts

`false` (default) | `true` | 'on' | 'off'

Option to allow dialog box prompts, specified as `true`, `false`, 'on', or 'off'. By default, warnings and error messages appear at the command line.

BreakAllLinks — Replace links to library blocks

`false` (default) | `true` | 'on' | 'off'

Option to, in the saved file, replace links to library blocks with copies of the library blocks, specified as `true`, `false`, 'on', or 'off'. This option affects user-defined blocks and Simulink library blocks.

Caution The 'BreakAllLinks' option can result in compatibility issues when upgrading to newer versions of Simulink. For example:

- Any masks on top of library links to Simulink S-functions do not upgrade to the new version of the S-function.
- Any library links to masked subsystems in a Simulink library do not upgrade to the new subsystem behavior.
- Any broken links prevent the library forwarding mechanism from upgrading the link.

If you saved a model with broken links to built-in libraries, use the Upgrade Advisor to scan the model for out-of-date blocks. Then upgrade the Simulink blocks to their current versions.

BreakUserLinks — Replace links to user-defined blocks

`false` (default) | `true` | 'on' | 'off'

Option to, in the saved file, replace links to user-defined library blocks with copies of the library blocks, specified as `true`, `false`, 'on', or 'off'.

BreakToolboxLinks — Replace links to built-in library block

`false` (default) | `true` | 'on' | 'off'

Option to, in the saved file, replace links to built-in library blocks with copies of the library blocks, specified as `true`, `false`, 'on', or 'off'. This option affects Simulink library blocks and blocks from libraries supplied with MathWorks toolboxes or blocksets.

ErrorIfShadowed — Return an error if name exists

false (default) | true | 'on' | 'off'

Option to return an error if the new name exists on the MATLAB path or workspace, specified as true, false, 'on', or 'off'.

ExportToXML — Export model to XML format

false (default) | true | 'on' | 'off'

Option to export the model to a file in a simple XML format, specified as true, false, 'on', or 'off'. Specify the full name of the file, including the .xml extension. The block diagram in memory does not change and no callbacks execute. Use this option without any other Name, Value pair arguments. This option warns and will be removed in a future release.

Example: `save_system('mymodel','exportfile.xml','ExportToXML',true)`

ExportToVersion — MATLAB release name to export to

character vector | string scalar

MATLAB release name to export to, specified in either of these forms (not case sensitive). You can export to seven years of previous releases.

- Release name, for example, 'R2013B', 'R2016B'
- Release name, followed by an underscore and then the extension, for example, 'R2016A_SLX', 'R2014A_MDL'. If you do not specify an extension, you export to the file format specified in your Simulink preferences.

`save_system` exports the system such that the specified Simulink version can load it. If the system contains functionality not supported by the specified Simulink version, the command removes the functionality in the exported file. It also replaces unsupported blocks with empty masked subsystem blocks colored yellow. As a result, the exported system might generate different results.

Alternatively, use `Simulink.exportToVersion` or, interactively, the Export to Previous Version dialog box.

To export a project to previous releases, see “Export a Project to a Previous Version” on page 2-684.

OverwriteIfChangedOnDisk — Overwrite file

false (default) | true | 'on' | 'off'

Option to overwrite the file on disk even if it has been modified since the system was loaded, specified as true, false, 'on', or 'off'. By default, if the file changed on disk since the model was loaded, `save_system` displays an error to prevent the changes on disk from being overwritten.

You can control whether `save_system` displays an error if the file has changed on disk using a Simulink preference. In the **Model File** pane of the Simulink Preferences dialog box, under **Change Notification**, select **Saving the model**. This preference is on by default.

SaveDirtyReferencedModels — Save referenced models with unsaved changes

false (default) | true | 'on' | 'off'

Option to save referenced models that have unsaved changes while saving changes to their parent model, specified as true, false, 'on', or 'off'. This option applies to models that are directly referenced by each model that is saved. If the parent model of a dirty referenced model is not saved, the dirty referenced model is not saved.

Suppose you have a model hierarchy in which model A references model B, and model B references model C. If models B and C both have unsaved changes, they are both saved. If model C has unsaved changes but model B does not have unsaved changes, neither model is saved.

By default, attempting to save a model that contains unsaved referenced models return an error.

SaveModelWorkspace — Save model workspace

false (default) | true | 'on' | 'off'

Option to save the contents of the model workspace, specified as true, false, 'on', or 'off'. The model workspace DataSource must be a MAT-file. If the data source is not a MAT-file, save_system does not save the workspace. See “Specify Source for Data in Model Workspace”.

Output Arguments

filename — Name of saved file

character vector | cell array of character vectors

Full name of saved file, returned as a character vector or a cell array of character vectors.

See Also

close_system | new_system | open_system | Simulink.exportToVersion

Topics

“Save the Model”

Introduced before R2006a

Schedule Editor

View and edit the schedule of model components (partitions)

Description

The Schedule Editor is a scheduling tool that represents the components in the model known as partitions, the data connections between them, and the order of those partitions.

Partitions are the components of the model that execute independently as tasks. The data connections between the partitions show the flow of the data between those partitions. The scheduling of these partitions is based on the rates and the events in the model. This schedule is shown in the **Order** table in the Schedule Editor.

Using the Schedule Editor, you can:

- Create partitions and specify their order.
- Edit and analyze the schedule of the executable partitions without disturbing the structure of the model.
- Visualize how Simulink executes partitions.

Changes made in the Schedule Editor affect both, simulation and code generation.

Using the Schedule Editor

The Schedule Editor consists of two parts representing two different views of partitions in the model:

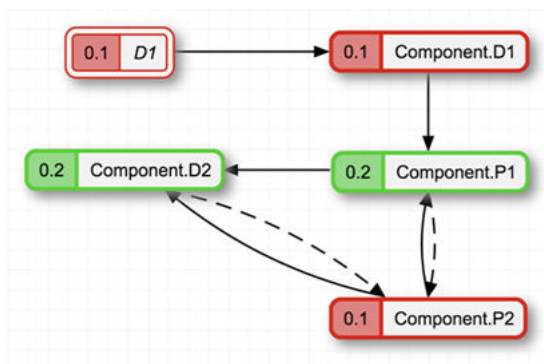

- A graph that shows the partitions and the data connections between them.



- A table that shows the order in which the partitions execute.

| ORDER | | |
|-------|---|------------|
| Order | Name | Trigger |
| 1 | <div style="display: flex; align-items: center;"> <div style="width: 15px; height: 15px; background-color: black; margin-right: 5px;"></div> Cont <i>implicit</i> </div> <div style="display: flex; align-items: center;"> <div style="width: 15px; height: 15px; background-color: red; margin-right: 5px;"></div> D1 <i>implicit</i> </div> | 0 0.001 |
| 2 | <div style="display: flex; align-items: center;"> <div style="width: 15px; height: 15px; background-color: green; margin-right: 5px;"></div> D2 <i>implicit</i> </div> | 0.005 |
| 3 | <div style="display: flex; align-items: center;"> <div style="width: 15px; height: 15px; background-color: #008000; margin-right: 5px;"></div> ThrottleControl.APPSnsrRun </div> | |
| 4 | <div style="display: flex; align-items: center;"> <div style="width: 15px; height: 15px; background-color: green; margin-right: 5px;"></div> ThrottleControl.ActuatorRun5ms </div> | 0.005 |
| 5 | <div style="display: flex; align-items: center;"> <div style="width: 15px; height: 15px; background-color: green; margin-right: 5px;"></div> ThrottleControl.TPSSecondaryRun5ms </div> | 0.005 |
| 6 | <div style="display: flex; align-items: center;"> <div style="width: 15px; height: 15px; background-color: green; margin-right: 5px;"></div> ThrottleControl.MonitorRun5ms </div> | 0.005 |
| 7 | <div style="display: flex; align-items: center;"> <div style="width: 15px; height: 15px; background-color: green; margin-right: 5px;"></div> ThrottleControl.ControllerRun5ms </div> | 0.005 |
| 8 | <div style="display: flex; align-items: center;"> <div style="width: 15px; height: 15px; background-color: blue; margin-right: 5px;"></div> D3 <i>implicit</i> </div> | 0.01 |
| 9 | <div style="display: flex; align-items: center;"> <div style="width: 15px; height: 15px; background-color: blue; margin-right: 5px;"></div> ThrottleControl.TPSPPrimaryRun10ms </div> | 0.01 |

Changing one of the views impacts the other.

To use the Schedule Editor, select **Schedule Editor** in the **Design** section of the **Modeling** tab. If the model is already partitioned, you can open the Schedule Editor by clicking the  badge, which appears above the blocks. To see the default partitions present in the model in the Schedule Editor, update the diagram by clicking the  icon on the toolbar or by selecting **Ctrl+D**. As you create partitions in the model and update the diagram, partitions appear in the Schedule Editor.

To check how the partitions map to the model, right-click the partitions and select **Show Source**. The Simulink model window appears with every block corresponding to the partition highlighted.

Order

The **Order** shows the order in which the partitions execute. To change the order, you can drag and drop the partitions. You can also use the **Up** and **Down** arrows on the toolbar. Partitions are sorted based on their rates. You can only reorder the partitions with the same rate. Clicking a partition in the **Order**, highlights the corresponding partition in the graph. On changing the order, the connections that are affected by this specified change get highlighted.

| | | |
|---|---|-------|
| 3 | <div style="display: flex; align-items: center;"> <div style="width: 15px; height: 15px; background-color: #008000; margin-right: 5px;"></div> ThrottleControl.APPSnsrRun </div> | |
| 4 | <div style="display: flex; align-items: center;"> <div style="width: 15px; height: 15px; background-color: green; margin-right: 5px;"></div> ThrottleControl.ActuatorRun5ms </div> | 0.005 |
| 5 | <div style="display: flex; align-items: center;"> <div style="width: 15px; height: 15px; background-color: green; margin-right: 5px;"></div> ThrottleControl.TPSSecondaryRun5ms </div> | 0.005 |
| 6 | <div style="display: flex; align-items: center;"> <div style="width: 15px; height: 15px; background-color: green; margin-right: 5px;"></div> ThrottleControl.MonitorRun5ms </div> | 0.005 |
| 7 | <div style="display: flex; align-items: center;"> <div style="width: 15px; height: 15px; background-color: green; margin-right: 5px;"></div> ThrottleControl.ControllerRun5ms </div> | 0.005 |
| 8 | <div style="display: flex; align-items: center;"> <div style="width: 15px; height: 15px; background-color: blue; margin-right: 5px;"></div> D3 <i>implicit</i> </div> | 0.01 |
| 9 | <div style="display: flex; align-items: center;"> <div style="width: 15px; height: 15px; background-color: blue; margin-right: 5px;"></div> ThrottleControl.TPSPPrimaryRun10ms </div> | 0.01 |

Connections

Connections between the partitions show data dependencies. You can right-click the connections between the partitions to change the constraints on data connections. The different types of connections illustrate how the partitions behave with each other.

The types of connections are:

- **Dependency** — Indicates that the source always runs before the destination. The dependency connection is a solid line.



- **Delay** — Indicates that the destination runs before the source. When the destination runs before the source, a scheduling delay is introduced. The delay connection is a dashed line.

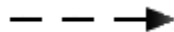

You can put these types of constraints on connections:

- **Allow Delay** — Inserts a delay when required. When you specify this constraint for a connection, Simulink inserts a delay for that connection only when necessary. The unlock icon on the connections signifies an allowed delay. When you select this constraint on a connection, Simulink prefers these connections to be turned into a delay if necessary over other connections.

This constraint is displayed as one of these options.



- **Prevent Delay** — Prevents delay from being inserted in the connection. When you specify this constraint for a connection, Simulink ensures that the connection is a dependency. The lock icon on the connection indicates that the connection is locked as a dependency and is not changed to a delay.



Events

The **Events** panel allows you to manage events in the Schedule Editor. The events in the Schedule Editor can bind with aperiodic partitions to schedule their execution. You can create events in the Schedule Editor and use these events to send from Stateflow to schedule execution of an aperiodic partition. To send the events from the Stateflow chart, use the `send(eventName)` command.

In the **Events** panel, you can see the listeners and the broadcasters of the event. The icon denotes the listeners, and the icon denotes the broadcasters. When you bind the aperiodic partition with an event, the aperiodic partition executes when that event is sent. The broadcaster of the event shows you the path of the Stateflow chart that sends the event.

Click the icon to create an event in the Schedule Editor, and select a listener partition from the drop down. You can also bind an event by dragging and dropping the event over a valid aperiodic partition.

When an event is bound to a partition, the event name appears on the left side of the partition and in the **Trigger** column of the **Order** table.

The screenshot displays the Schedule Editor interface. The main workspace shows a block diagram with several blocks representing events and partitions. The blocks are arranged in a hierarchical structure, with arrows indicating dependencies. The blocks include:

- 0.001 D3** (blue box)
- 0.005 ThrottleControl.TPSSecondaryRun5ms** (green box)
- 0.01 ThrottleControl.TPSPPrimaryRun10ms** (blue box)
- 0.005 ThrottleControl.MonitorRun5ms** (green box)
- 0.005 ThrottleControl.ControllerRun5ms** (green box)
- 0.005 ThrottleControl.ActuatorRun5ms** (green box)
- 0.005 D2** (green box)

The **ORDER** table on the right side of the interface lists the events and their triggers. The table has two columns: **Order Name** and **Trigger**.

| Order Name | Trigger |
|------------|------------------------------------|
| 1 | Cont |
| 2 | D2 |
| 3 | ThrottleControl.APPSnsrRun |
| 4 | ThrottleControl.ActuatorRun5ms |
| 5 | ThrottleControl.TPSSecondaryRun5ms |
| 6 | ThrottleControl.MonitorRun5ms |
| 7 | ThrottleControl.ControllerRun5ms |
| 8 | D3 |
| 9 | ThrottleControl.TPSPPrimaryRun10ms |

The **MANAGE PARTITIONS** table at the bottom left shows the following data:

| Block Name | Partition Name | Sample time |
|----------------------------|-----------------------|-------------|
| Convert Pedal to ADC Range | | |
| Convert TPS to ADC Range | | |
| ThrottleControl | ThrottleControl <...> | |

Open the Schedule Editor

- Simulink: In the **Modeling** tab, expand the **Design** section and select **Schedule Editor** from **System Design**.
- Simulink model: Click the badge on the partitioned blocks.

Examples

- “Schedule an Export-Function Model Using the Schedule Editor”
- “Schedule a Rate-Based Model Using the Schedule Editor”
- “Events in Schedule Editor”

Parameters

Manage Partitions

Partition Name — Name of the partitions

character vector

Name of the partitions created. Double-click the name to edit and use the enter key to save the partition name.

Sample Time — Sample time for partitions to execute

discrete value | variable

Sample time at which the partitions execute. The sample time is a discrete value or a defined variable that contains a discrete value.

Property Inspector**Hit times — Times for aperiodic partitions to execute**

vector

Times at which the aperiodic partitions execute, specified as a vector of discrete values.

Connections — Data connections between partitions

Auto (default) | Delay | Dependency | Prevent Delays | Allow Delays

Dependency between the partitions is shown as a solid line. A delay between the partitions is shown as a dashed line. The arrow tail and head denote the source and destination, respectively.

Specify constraints on the connections by right-clicking the lines and selecting the constraint type.

More About**Order**

By default, the **Order** table is expanded. **Order** shows the order of partition execution. Edit the order by dragging the partitions or using the **Up** and **Down** arrows on the toolstrip.

Manage Partitions

By default, the **Manage Partitions** panel is collapsed. Expand the panel to create partitions, edit names and/or sample times of the existing partitions, and remove existing partitions. Changes made in the **Manage Partitions** panel take effect after updating the diagram.

Property Inspector

The **Property Inspector** shows information about the selected partition. It shows the rate at which the partition executes and the connections on that partition. Enter the **Hit times** when you select an aperiodic partition in the **Property Inspector**.

Arrange

The **Arrange** button organizes the partition graph.

Layout

By default, the **Order** panel and the **Property Inspector** panel are expanded. From the **Layout** drop-down, select the preferred panels to be expanded as per preference. Clearing the panels collapses them.

See Also

“Create Partitions” | “Generate Code from a Partitioned Model”

Topics

“Schedule an Export-Function Model Using the Schedule Editor”

“Schedule a Rate-Based Model Using the Schedule Editor”
“Events in Schedule Editor”

Introduced in R2019a

set_param

Set system and block parameter values

Syntax

```
set_param(Object,ParameterName,Value,...ParameterNameN,ValueN)
```

Description

`set_param(Object,ParameterName,Value,...ParameterNameN,ValueN)` sets the parameter to the specified value on the specified model or block object.

When you set multiple parameters on the same model or block, use a single `set_param` command with multiple pairs of `ParameterName, Value` arguments, rather than multiple `set_param` commands. This technique is efficient because using a single call requires evaluating parameters only once. If any parameter names or values are invalid, then the function doesn't set any parameters.

Tips:

- If you make multiple calls to `set_param` for the same block, then specifying the block using a numeric handle is more efficient than using the full block path. Use `getSimulinkBlockHandle` to get a block handle.
- If you use `matlab -nodisplay` to start a session, you cannot use `set_param` to run your simulation. The `-nodisplay` mode does not support simulation using `set_param`. Use the `sim` command instead.
- After you set parameters in the MATLAB workspace, to see the changes in a model, update the diagram.

```
set_param(model,'SimulationCommand','Update')
```

For parameter names, see:

- “Block-Specific Parameters” on page 6-26
- “Common Block Properties” on page 6-12

Examples

Set Model Configuration Parameters for a Model

Open `vdp` and set the `Solver` and `StopTime` parameters.

```
vdp  
set_param('vdp','Solver','ode15s','StopTime','3000')
```

Set Model Configuration Parameters for Current Model

Open a model and set the Solver and StopTime parameters. Use bdroot to get the current top-level model.

```
vdp
set_param(bdroot, 'Solver', 'ode15s', 'StopTime', '3000')
```

Set a Gain Block Parameter Value

Open vdp and set a Gain parameter value in the Mu block.

```
vdp
set_param('vdp/Mu', 'Gain', '10')
```

Set Position of Block

Open vdp and set the position of the Mu block.

```
vdp
set_param('vdp/Mu', 'Position', [50 100 110 120])
```

Set Position of Block Using a Handle

Set the position of the Mu block in the vdp model.

Use `getSimulinkBlockHandle` to load the vdp model if necessary (by specifying `true`), and get a handle to the Mu block. If you make multiple calls to `set_param` for the same block, then using the block handle is more efficient than specifying the full block path as a character vector.

```
mublockhandle = getSimulinkBlockHandle('vdp/Mu', true);
```

You can use the block handle in subsequent calls to `get_param` or `set_param`. If you examine the handle, you can see that it contains a double. Do not try to use the number of a handle alone (e.g., `5.007`) because you usually need to specify many more digits than MATLAB displays. Instead, assign the handle to a variable and use that variable name to specify a block.

Use the block handle with `set_param` to set the position.

```
set_param(mublockhandle, 'Position', [50 100 110 120])
```

Put Block Name on Top of Block

Set the position of the Mu block name on top in the vdp model.

Open the vdp model. Type `vdp` at the command line.

Select the Mu block.

Set the name of the block on top.

```
set_param(gcb, 'NameLocation', 'top')
```

Input Arguments

Object — Name or handle of a model or block

character vector | string scalar | handle

Handle or name of a model or block, specified as a numeric handle or a character vector. A numeric handle must be a scalar. You can also set parameters of lines and ports, but you must use numeric handles to specify them.

Tip If you make multiple calls to `set_param` for the same block, then specifying a block using a numeric handle is more efficient than using the full block path with `set_param`. Use `getSimulinkBlockHandle` to get a block handle. Do not try to use the number of a handle alone (e.g., 5.007) because you usually need to specify many more digits than MATLAB displays. Assign the handle to a variable and use that variable name to specify a block.

Example: 'vdp/Mu'

ParameterName — Model or block parameter name

character vector | string scalar

Model or block parameter name, specified as a character vector or a string scalar. Some parameter names are case sensitive.

Example: 'Solver'

Example: 'SimulationCommand'

Example: 'Position'

Example: 'NameLocation'

Value — Value of the specified parameter

any data type, depending on the parameter

Model or block parameter value, specified in the format determined by the parameter type. Some parameter values are case sensitive. Values are often character vectors, but they can also be numeric, arrays, and other types. Many block parameter values are specified as character vectors, but two exceptions are these parameters: `Position`, specified as a vector, and `UserData`, which can be any data type.

Example: 'right' 'left' 'top' 'bottom'

See Also

`get_param` | `getSimulinkBlockHandle` | `gcs` | `gcb` | `bdroot` | `open_system` | `new_system`

Topics

“Associating User Data with Blocks”

“Use MATLAB Commands to Change Workspace Data”

“Run Simulations Programmatically”

“Block-Specific Parameters” on page 6-26

“Common Block Properties” on page 6-12

Introduced before R2006a

setActiveConfigSet

Specify active configuration set or configuration reference for model

Syntax

```
setActiveConfigSet(model, configObjName)
```

Description

`setActiveConfigSet(model, configObjName)` activates the configuration set or configuration reference that is attached to `model` and is named `configObjName`. Before you activate a configuration, attach the configuration to the model by using `attachConfigSet`.

Examples

Activate Configuration Set

Create a configuration set, attach it to a model, and activate it.

Open the model `sldemo_fuelsys`.

```
sldemo_fuelsys
```

Create a configuration set named `Config1` and attach it to the model.

```
configObj = Simulink.ConfigSet;  
set_param(configObj, 'Name', 'Config1')  
attachConfigSet('sldemo_fuelsys', configObj)
```

Activate the `Config1` configuration set.

```
setActiveConfigSet('sldemo_fuelsys', 'Config1')
```

Input Arguments

model — Model for which to activate configuration

character vector | string scalar

Name of model for which you want to activate a configuration set, specified as a character vector or string scalar. The model must be open.

Example: `'my_model'`

configObjName — Name of configuration object

character vector | string scalar

Name of the configuration object that you want to activate, specified as a character vector or string scalar.

Example: `'Configuration'`

See Also

[attachConfigSet](#) | [attachConfigSetCopy](#) | [getActiveConfigSet](#) | [getConfigSet](#)

Topics

[“Manage Configuration Sets for a Model”](#)

[“Share a Configuration with Multiple Models”](#)

Introduced before R2006a

sfix

Create `Simulink.NumericType` object describing signed fixed-point data type

Syntax

```
a = sfix(WordLength)
```

Description

`sfix(WordLength)` returns a `Simulink.NumericType` object that describes a signed fixed-point number with the specified word length and unspecified scaling.

Note `sfix` is a legacy function. In new code, use `fixdt` instead. In existing code, replace `sfix(WordLength)` with `fixdt(1,WordLength)`.

Examples

Define a 16-bit signed fixed-point data type.

```
a = sfix(16)
```

```
a =
```

```
    NumericType with properties:
```

```
    DataTypeMode: 'Fixed-point: unspecified scaling'  
    Signedness: 'Signed'  
    WordLength: 16  
    IsAlias: 0  
    DataScope: 'Auto'  
    HeaderFile: ''  
    Description: ''
```

See Also

`fixdt` | `Simulink.NumericType` | `float` | `sfrac` | `sint` | `ufix` | `ufrac` | `uint`

Introduced before R2006a

sfrac

Create `Simulink.NumericType` object describing signed fractional data type

Syntax

```
a = sfrac(WordLength)
a = sfrac(WordLength, GuardBits)
```

Description

`sfrac(WordLength)` returns a `Simulink.NumericType` object that describes the data type of a signed fractional data type with a word size given by `WordLength`.

`sfrac(WordLength, GuardBits)` returns a `Simulink.NumericType` object that describes the data type of a signed fractional number. The total word size is given by `WordLength` with `GuardBits` bits located to the left of the binary point.

The most significant (leftmost) bit is the sign bit. The default binary point for this data type is assumed to lie immediately to the right of the sign bit. If guard bits are specified, they lie to the left of the binary point and to right of the sign bit. For example, the structure for an 8-bit signed fractional data type with 4 guard bits is:

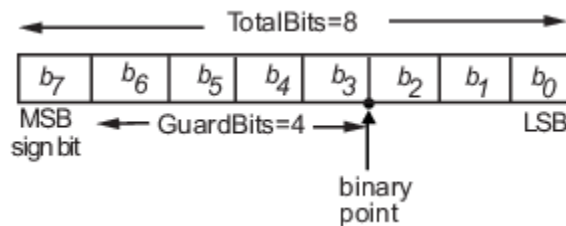

Note `sfrac` is a legacy function. In new code, use `fixdt` instead. In existing code, replace `sfrac(WordLength,GuardBits)` with `fixdt(1,WordLength,(WordLength-1-GuardBits))` and `sfrac(WordLength)` with `fixdt(1,WordLength,(WordLength-1))`.

Examples

Define an 8-bit signed fractional data type with 4 guard bits. Note that the range of this data type is $-2^4 = -16$ to $(1 - 2^{(1-8)}) \cdot 2^4 = 15.875$.

```
a = sfrac(8,4)
```

```
a =
```

```
NumericType with properties:
```

```
    DataTypeMode: 'Fixed-point: binary point scaling'
    Signedness: 'Signed'
    WordLength: 8
    FractionLength: 3
```

```
    IsAlias: 0  
    DataScope: 'Auto'  
    HeaderFile: ''  
    Description: ''
```

See Also

`fixdt` | `Simulink.NumericType` | `float` | `sfix` | `sint` | `ufix` | `ufrac` | `uint`

Introduced before R2006a

showblockdatatypetable

Display HTML page of Simulink block data type support

Syntax

showblockdatatypetable

Description

showblockdatatypetable displays an HTML page of the Simulink block data type support. This table lists the data types that Simulink blocks support.

Examples

Display Support of Simulink Block Data Types

Display an HTML page of the Simulink block data type support.

showblockdatatypetable

Tips

To open the Block Support Table using a block, double-click the Block Support Table block in the block library or add it to a model and then double-click it.

See Also

Block Support Table

Topics

“Data Types Supported by Simulink”

Introduced before R2006a

showunitslist

Show built-in units, physical quantities, and unit systems supported by Simulink

Syntax

```
showunitslist
```

Description

`showunitslist` opens a web browser that contains the list of built-in units, physical quantities, and unit systems supported by Simulink.

Examples

Show Built-in Units, Physical Quantities, and Unit Systems

Show built-in units, physical quantities, and unit systems supported by Simulink.

```
showunitslist
```

This function opens a web browser displaying the allowed units.

See Also

Topics

“Unit Specification in Simulink Models”

Introduced in R2016a

signalbuilder

(Not recommended) Create and access Signal Builder blocks

Note The Signal Builder block is not recommended. Use the Signal Editor block instead.

Syntax

```
[time,data] = signalbuilder(block)
[time,data,signames] = signalbuilder(block)
[time,data,signames,groupnames] = signalbuilder(block)

block = signalbuilder(path,'create',time,data)
block = signalbuilder(path,'create',time,data,signames,groupnames)
block = signalbuilder(path,'create',time,data,signames,groupnames,vis)
block = signalbuilder(path,'create',time,data,signames,groupnames,vis,pos)
block = signalbuilder(path,'create',time,data,signames,groupnames,vis,pos,{
openui openmodel})

block = signalbuilder(block,'appendgroup',time,data,signames,groupnames)
signalbuilder(block,'appendgroup',ds)
signalbuilder(block,'appendgroup',[ds1 ...dsN])
signalbuilder(block,'appendsignal',time,data,signames)

signalbuilder(block,'showsignal',signal,group)
signalbuilder(block,'hidesignal',signal,group)

[time,data] = signalbuilder(block,'get',signal,group)
ds = signalbuilder(block,'get',group)
[ds, ...dsN] = signalbuilder(block,'get',group)
signalbuilder(block,'set',signal,group,time,data)
signalbuilder(block,'set',group,ds)
signalbuilder(block,'set',group,[ds1 ...dsN])

index = signalbuilder(block,'activegroup')
[index, activeGroupLabel] = signalbuilder(block,'activegroup')
signalbuilder(block,'activegroup',index)

signalbuilder(block,'annotategroup')

signalbuilder(block,'print',config,printArgs)
figh = signalbuilder(block,'print',config,'figure')
```

Description

`[time,data] = signalbuilder(block)` returns the time and data of the Signal Builder block, block.

`[time,data,signames] = signalbuilder(block)` returns signal names, signames, and time and data.

`[time,data,signames,groupnames] = signalbuilder(block)` returns the signal names, signames, and group names, groupnames, and time and data.

`block = signalbuilder(path,'create',time,data)` creates a new Signal Builder block at path with specified time and data. Signal and group names are default.

`block = signalbuilder(path,'create',time,data,signames,groupnames)` creates a new Signal Builder block at path with specified time and data, signal names, and group names.

`block = signalbuilder(path,'create',time,data,signames,groupnames,vis)` creates a new Signal Builder block and sets the visible signals in each group based on the values of the matrix vis.

`block = signalbuilder(path,'create',time,data,signames,groupnames,vis,pos)` creates a new Signal Builder block and sets the block position to pos.

If you create signals that are smaller than the display range or do not start from 0, the Signal Builder block extrapolates the undefined signal data. It does so by holding the final value.

`block = signalbuilder(path,'create',time,data,signames,groupnames,vis,pos,{openui openmodel})` creates a new Signal Builder block and opens or invisibly loads the model and Signal Builder block window.

`block = signalbuilder(block,'appendgroup',time,data,signames,groupnames)` appends new groups (groupnames) containing signames to the Signal Builder block, block. The time and data arguments must have the same number of signals as the existing block.

`signalbuilder(block,'appendgroup',ds)` appends one dataset.

`signalbuilder(block,'appendgroup',[ds1 ...dsN])` appends *N* datasets.

`signalbuilder(block,'appendsignal',time,data,signames)` appends new signals to all signal groups in the Signal Builder block, block. You can append either the same signals to all groups, or append different signals to different groups. Regardless of which signals you append, append the same number of signals to all the groups. Append signals to all the groups in the block; you cannot append signals to a subset of the groups. Correspondingly, provide time and data arguments for either one group (append the same information to all groups) or different time and data arguments for different groups.

`signalbuilder(block,'showsignal',signal,group)` makes signals that are hidden from the Signal Builder block visible. By default, signals in the current active group are visible when created.

`signalbuilder(block,'hidesignal',signal, group)` makes signals, signal, hidden from the Signal Builder block. By default, all signals are visible when created.

`[time,data] = signalbuilder(block,'get',signal,group)` gets the time and data values for the specified signal(s) and group(s).

`ds = signalbuilder(block,'get',group)` gets one or more datasets for one requested Signal Builder group. *r* gets *N* datasets for *N* requested Signal Builder groups.

`[ds, ...dsN] = signalbuilder(block,'get',group)` gets *N* datasets for *N* requested Signal Builder groups.

`signalbuilder(block, 'set', signal, group, time, data)` sets the time and data values for the specified signal and group. Use empty values of `time` and `data` to remove groups and signals. To remove a signal group, you must also remove all the signals in that group in the same command.

`signalbuilder(block, 'set', group, ds)` sets one dataset for the requested Signal Builder group. Specifying an empty dataset deletes the groups specified in `group`.

`signalbuilder(block, 'set', group, [ds1 ... dsN])` sets N datasets for N requested groups.

`index = signalbuilder(block, 'activegroup')` gets the index of the active group.

`[index, activeGroupLabel] = signalbuilder(block, 'activegroup')` gets the label value of the active group.

`signalbuilder(block, 'activegroup', index)` sets the active group to indexed active group.

`signalbuilder(block, 'annotategroup')` controls the display of the current group name on the mask of the Signal Builder block. 'annotategroup' takes one of these values:

- 'on' — Shows the current group name
- 'off' — Hides the current group name

`signalbuilder(block, 'print', config, printArgs)` prints the currently active signal group or the signal group that `config` specifies. Use the `config` to customize the printed appearance of a signal group.

`figh = signalbuilder(block, 'print', config, 'figure')` prints the currently active signal group or the signal group that `config` specifies to a new hidden figure handle, `figh`.

Examples

Create Signal Builder Block

Create a Signal Builder block in a new model editor window.

```
block = signalbuilder([], 'create', [0 5], {[2 2];[0 2]});
```

Get Signal Builder data from this block.

```
[time, data, signames, groupnames] = signalbuilder(block)
```

```
time =
```

```
2×1 cell array
```

```
{1×2 double}  
{1×2 double}
```

```
data =
```

```
2×1 cell array
```

```
{1×2 double}  
{1×2 double}
```

```
signames =  
    1x2 cell array  
    {'Signal 1'}    {'Signal 2'}  
groupnames =  
    1x1 cell array  
    {'Group 1'}
```

The Signal Builder block contains two signals in one group. Alter the second signal in the group.

```
signalbuilder(block, 'set', 2, 1, [0 5], [2 0]);
```

To make this same change using the signal name and group name:

```
signalbuilder(block, 'set', 'Signal 2', 'Group 1', [0 5], [2 0])
```

Create Signal Builder Block and Delete Group

Create a Signal Builder block with two signal groups and delete one of the groups.

```
block = signalbuilder([], 'create', [0 2], {[0 1],[1 0]});
```

The Signal Builder block has two groups, each of which contains a signal.

To delete the second group, also delete its signal.

```
signalbuilder(block, 'set', 1, 2, [], [])
```

Create Signal Builder Block with Two Groups

Create a Signal Builder block with two groups, each of which contains three signals.

```
block = signalbuilder([], 'create', [0 1], ...  
    {[0 0],[1 1];[1 0],[0 1];[1 1],[0 0]});
```

Create Signal Builder Block and Append Signal Groups

Create a Signal Builder block in a new model editor window.

```
block = signalbuilder([], 'create', {[0 10],[0 20]},{[6 -6],...  
    [2 5]});
```

The Signal Builder block has two groups. Each group contains one signal.

Append a new signal group to the existing block.

```
block = signalbuilder(block, 'appendgroup', [0 30],[10 -10]);
```

Append a new signal, sig3, to all groups.

```
signalbuilder(block, 'appendsignal', [0 30], [0 10], 'sig3');
```

Create Signal Builder Block and Delete Signal Group

Create a Signal Builder block in a new model editor window.

```
time = [0 1];
data = {[0 0], [1 1]; [1 0], [0 1]; [1 1], [0 0]};
block = signalbuilder([], 'create', time, data);
```

The Signal Builder block has two groups. Each group contains three signals.

Delete the second group. To delete a signal group, also delete all the signals in the group.

```
signalbuilder(block, 'set', [1,2,3], 'Group 2', []);
```

Create Signal Builder Block and Hide Signal

Create a Signal Builder block in a new model editor window and hide signal.

```
block = signalbuilder([], 'create', [0 5], {[2 2]; [0 2]});
```

The Signal Builder block has one group that contains two signals.

Hide the signal, Signal 1.

```
signalbuilder(block, 'hidesignal', 'Signal 1', 'Group 1')
```

Signal 1 is no longer visible in the Signal Builder block.

Make Signal 1 visible again.

```
signalbuilder(block, 'showsignal', 'Signal 1', 'Group 1')
```

Create Two Signal Builder Blocks

Create two Signal Builder blocks in new model editor windows.

```
block = signalbuilder([], 'create', [0 5], {[2 2]; [0 2]});
block1 = signalbuilder('untitled/Signal Builder1', 'create', [1 2], {[1 2]; [0 10]});
```

Get a dataset for group 1 of block.

```
ds=signalbuilder(block, 'get', 1);
```

Get a dataset for group 1 of block1.

```
ds1=signalbuilder(block1, 'get', 1);
```

Set the dataset for group 1 of block to ds1.

```
signalbuilder(block, 'set', 1, ds1);
```

Append the original dataset for group 1 of block (ds) to block.

```
signalbuilder(block, 'appendgroup', ds);
```

To create a third group in `block`, append `ds1` to the end of the groups in `block`.

```
signalbuilder(block, 'appendgroup', ds1);
```

Input Arguments

block — Signal Builder block path or handle

[] (default) | block handle | block name

Signal Builder block handle or name. If you specify [] for this argument, the block has the path 'untitled/Signal Builder'.

Example: 'untitled/Signal Builder'

Example: `block_handle = gcbh`

Data Types: `char` | `string`

time — Time

row vector | column cell vector | row cell vector | cell matrix

Specify `time` format depending on the block configuration.

If `data` is a cell array and `time` is a vector, the `time` values are duplicated for each element of `data`. Each vector within `time` and `data` must be the same length and have at least two elements. If `time` is a cell array, all elements in a column must have the same initial and final value.

| Configuration | Time Format |
|---------------------|---|
| 1 signal, 1 group | Row vector of break points. |
| >1 signal, 1 group | Column cell vector where each element corresponds to a separate signal and contains a row vector of points. |
| 1 signal, >1 group | Row cell vector where each element corresponds to a separate group and contains a row vector of points. |
| >1 signal, >1 group | Cell matrix where each element (i, j) corresponds to signal i and group j. |

Dependencies

If `signalbuilder` is called for an existing block, the `time` argument must have the same number of signals as the existing block.

Data Types: `double`

data — Data

row vector | column cell vector | row cell vector | cell matrix

Specify `data` format depending on the block configuration.

If `data` is a cell array and `time` is a vector, the `time` values are duplicated for each element of `data`. Each vector within `time` and `data` must be the same length and have at least two elements. If `time` is a cell array, all elements in a column must have the same initial and final value.

| Configuration | Time/Data Format |
|---------------------|---|
| 1 signal, 1 group | Row vector of break points. |
| >1 signal, 1 group | Column cell vector where each element corresponds to a separate signal and contains a row vector of points. |
| 1 signal, >1 group | Row cell vector where each element corresponds to a separate group and contains a row vector of points. |
| >1 signal, >1 group | Cell matrix where each element (i, j) corresponds to signal i and group j. |

Data Types: double

config – Configuration structure name

structure name

Configuration structure containing instructions to display signal group information on the block mask. Set up the structure with one or more of these fields before you print.

| Field | Description | Example Value |
|----------------|---|--------------------|
| groupIndex | Scalar specifying index of signal group to print | 2 |
| timeRange | Two-element vector specifying the time range to print (must not exceed the block's time range) | [3 6] |
| visibleSignals | Vector specifying index of signals to print | [1 2] |
| yLimits | Cell array specifying limits for each signal's y-axis | {[-1 1], [0 1]} |
| extent | Two-element vector of the form: [width, height] specifying the dimensions (in pixels) of the area in which to print the signals | [500 300] |
| showTitle | Logical value specifying whether to print a title: true (1) prints the title | false |

For example, to print just group 2 using a configuration structure, `configstruct`, set up the structure as follows. You do not need to specify any other fields.

```
configstruct.groupIndex=1
```

Example: `configstruct`

Data Types: char | string

'create' – Create directive

'create'

Create new Signal Builder block.

Data Types: char | string

signames – Signal names

Signal 1 (default) | ' ' | {} | character vector | cell array of character vectors

Signal names, specified as ' ', {}, a character vector, or cell array of character vectors.

If you specify a value of ' ' or {}, the function uses existing signal names for the new groups.

Data Types: char | string

groupnames — Signal group names

Group 1 (default) | character vector | cell array of character vectors

Group names, specified as a character vector or cell array of character vectors.

Data Types: char | string

path — Block path

[] (default) | full block path

Block path, specified as full block path. To create a Signal Builder block in a new model, untitled, with the name Signal Builder, specify [].

Data Types: char | string

vis — Signal visibility

matrix

Signal visibility, specified as a matrix. The Signal Builder block displays signals in each group based on the values of the matrix vis. This matrix must be the same size as the cell array, data. You cannot create Signal Builder blocks in which all signals are invisible. For example, if you set the vis parameter for all signals to 0, the first signal is still visible.

Data Types: double

pos — Block position in model

[0 0] (default) | [x y right bottom]

Block position in model, specified as [x y right bottom].

Data Types: double

openui — Open Signal Builder block dialog box

0 (default) | 1

Open Signal Builder block dialog upon creation by signalbuilder function, specified as 0 or 1.

Data Types: double

openmodel — Open model

1 (default) | 0

Open model upon creation by signalbuilder function, specified as one of:

- 0 — Load the model but do not open it.
- 1 — Open the model.

Data Types: double

'appendsignal' — Append signals

'appendsignal' (default)

Append new signals to all signal groups in the Signal Builder block. You can append either the same signals to all groups, or append different signals to different groups. Regardless of which signals you append, append the same number of signals to all the groups. Append signals to all the groups in the block. You cannot append signals to a subset of the groups.

Data Types: `char` | `string`

'appendgroup' — Append new signal group

`'appendgroup'`

Append new signal groups whose number of time and signal elements are the same as existing signal groups in the Signal Builder block.

For the `showsignal` and `hidesignal` methods, if you do not specify a value for the `group` argument, `signalbuilder` applies the operation to all the signals and groups.

Data Types: `char`

'set' — Set values

`'set'`

Set values based on input arguments.

- `time` and `data` — Return time and data values.
- `ds` — Return `Simulink.SimulationData.Dataset` object(s).

Data Types: `char`

'get' — Get values

`'get'`

Get values based on output arguments.

- `[time, data]` — Return time and data values.
- `[ds, ...dsN]` — Return `Simulink.SimulationData.Dataset` object(s).

Data Types: `char` | `string`

'showsignal' — Make signal visible

`'showsignal'`

Make one or more signals visible in a signal group. If no group is specified, all the signals and groups are visible.

Data Types: `char` | `string`

'hidesignal' — Hide signal

`'hidesignal'`

Hide one or more signals in a signal group. If no group is specified, all the signals and groups are hidden.

Data Types: `char`

ds — Dataset

`timeseries` data elements | 1-D scalar data value at each time | nonempty data and/or time | empty values

Dataset of timeseries elements, specified as a `Simulink.SimulationData.Dataset` object.

Data Types: `double`

ds1 ... dsN — Multiple datasets

vectors of timeseries data elements | vectors of 1-D scalar data value at each time | nonempty data and/or time

One or more datasets of timeseries elements, specified as `Simulink.SimulationData.Dataset` objects.

Example: `[ds1 ds2 ds3]`

Data Types: `double`

signal — Signal

signal name | scalar index | array of signal indices

Signal, specified as a signal name, scalar index, or array of signal indices.

Data Types: `char` | `double` | `string`

group — Signal group

group name | scalar index | array of group indices

Signal group, specified as a group name, scalar index, or array of group indices.

Data Types: `char` | `double` | `string`

index — Group index

active group index

Active signal group index.

Data Types: `double`

'activegroup' — Get active group

`'activegroup'`

Get currently active signal group.

Data Types: `char` | `string`

'annotategroup' — Display active signal group name

`'on'` (default) | `'off'`

Display active signal group name on Signal Builder block mask:

- `'on'` — Display active signal group names on block mask.
- `'off'` — Do not display active signal group names on block mask.

Data Types: `char` | `string`

'print' — Print signal group

`'print'`

Print signal group.

Data Types: `char` | `string`

printArgs — Configure print options

[] | print function arguments

Configure print options (see print).

To print the entire contents of the Signal Builder block, specify [].

Data Types: char | string

'figure' — Figure

'figure'

Create a figure containing contents of Signal Builder block.

Data Types: char | double | string

Output Arguments**time — Time**

row vector | column cell vector | row cell vector | cell matrix

Time for the Signal Builder block, returned as row vector, column cell vector, row cell vector, or cell matrix. For the Signal Builder block, time is the x-coordinate.

time returns in different formats depending on the block configuration.

| Configuration | Time Format |
|---------------------|---|
| 1 signal, 1 group | Row vector of break points. |
| >1 signal, 1 group | Column cell vector where each element corresponds to a separate signal and contains a row vector of points. |
| 1 signal, >1 group | Row cell vector where each element corresponds to a separate group and contains a row vector of points. |
| >1 signal, >1 group | Cell matrix where each element (i, j) corresponds to signal i and group j. |

data — Data

row vector | column cell vector | row cell vector | cell matrix

Data of the Signal Builder block, returned as a one-dimensional array. For the Signal Builder block, time is the y-coordinate.

data takes different formats depending on the block configuration.

| Configuration | Data Format |
|---------------------|---|
| 1 signal, 1 group | Row vector of break points. |
| >1 signal, 1 group | Column cell vector where each element corresponds to a separate signal and contains a row vector of points. |
| 1 signal, >1 group | Row cell vector where each element corresponds to a separate group and contains a row vector of points. |
| >1 signal, >1 group | Cell matrix where each element (i, j) corresponds to signal i and group j. |

Datasets must have the same number of elements as the signals in a signal group. Dataset format limitations for the `set`, `append`, and `appendgroup` functions include:

- Elements must be MATLAB timeseries data.
Timeseries data and/or time cannot be empty.
- Timeseries data must be of type double.
- Timeseries data must be 1-D (scalar value at each time).

signames — Signal names

character vector | cell array of character vectors

Signal names, returned as a character vector or cell array of character vectors.

block — Signal Builder block path or handle

block handle

Signal Builder block path or handle, returned by block creation or append commands.

ds — Dataset

timeseries data elements | 1-D scalar data value at each time | nonempty data and/or time

Dataset of timeseries elements, returned as a `Simulink.SimulationData.Dataset` object.

ds, ...dsN — Multiple datasets

vectors of timeseries data elements | vectors of 1-D scalar data value at each time | nonempty data and/or time

One or more datasets of timeseries elements, returned as `Simulink.SimulationData.Dataset` objects.

index — Group index

active group index

Active signal group index.

activeGroupLabel — Active group label

index

Active group label, returned as an index.

figh — Figure handle

handle

Figure handle, returned when contents of Signal Builder block are printed to the hidden figure.

More About

Interpolating Missing Data Values

When specifying a periodic signal such as a Sine Wave, the `signalbuilder` function uses linear Lagrangian interpolation to compute data values for time steps that occur between time steps for which the `signalbuilder` function supplies data. When specifying periodic signals, specify them as a time vector that is defined as multiples of sample time, for example:

```
t = 0.2*[0:49]';
```

See Also

Signal Editor | Signal Builder | Simulink.SimulationData.Dataset

Topics

“Load Data with Interchangeable Scenarios”

“Signal Groups”

Introduced in R2007a

signalEditor

Start Signal Editor

Syntax

```
signalEditor  
signalEditor(Name,Value)
```

Description

`signalEditor` starts Signal Editor without an associated model.

`signalEditor(Name,Value)` starts signal Editor using additional options specified by one or more name-value pair arguments.

Specify optional comma-separated pairs of `Name,Value` arguments. `Name` is the argument name and `Value` is the corresponding value. `Name` must appear inside single quotes (' '). You can specify the name and value pair arguments in any order as `Name1,Value1,...,NameN,ValueN`.

- `Model` - Model name, specified as a character array, for which Signal Editor is to start. You can specify one model per call to the `signalEditor` function.

Note Load the model before starting Signal Editor for it.

- `DataSource` - Data set name, specified as a character array, to be edited. You can specify one data set file per call to the `signalEditor` function.

Note You can start multiple sessions of Signal Editor for the same model. However, you can associate a data set file with only one Signal Editor at a time. A data set file cannot have multiple Signal Editor sessions associated with it.

To add a scenario to the Signal Editor interface, select **Scenario** from the **Insert** section of the Signal Editor toolstrip.

Examples

Start Signal Editor for a Model

Start the Signal Editor for the model, `slexAutotransRootInportsExample`.

Load the `slexAutotransRootInportsExample` model, then start Signal Editor for it.

```
open_system('slexAutotransRootInportsExample')  
signalEditor('Model','slexAutotransRootInportsExample');
```

Start Signal Editor to Edit a Data Set File

Start Signal Editor to edit myFile.mat.

```
signalEditor('DataSource', 'myFile.mat');
```

Start Signal Editor and Data Set File for a Model

Load the slxAutotransRootInportsExample model, then start Signal Editor for the model, and edit myFile.mat.

```
open_system('slxAutotransRootInportsExample')  
signalEditor('Model', 'slxAutotransRootInportsExample', 'DataSource', 'myFile.mat');
```

See Also

Topics

“Create and Edit Signal Data”

Introduced in R2017b

sim

Simulate a Simulink model

Syntax

```
simOut = sim(model)
simOut = sim(model,Name,Value)
simOut = sim(simIn)
simOut = sim(model,ParameterStruct)
simOut = sim(model,ConfigSet)
```

Description

A Simulink model represents a dynamic system. Simulating a model lets you understand the behavior of the system as a function of simulated time. The `sim` command uses the specified model and applies the arguments to the model. At the end of the simulation, the `sim` command reverts any arguments that it applied.

`simOut = sim(model)` simulates the specified model using existing model configuration parameters, and returns the result as a `Simulink.SimulationOutput` object (single-output format).

In the **Data Import/Export** pane of the **Configuration Parameters** dialog box, **Single simulation output** is selected by default. If the **Single simulation output** is not selected, the simulation results are returned as a time vector.

To return simulation results using the backward-compatible format (time vector), see “Backward-Compatible Syntax” on page 2-434.

`simOut = sim(model,Name,Value)` simulates the specified model using parameter name-value pairs.

`simOut = sim(simIn)` simulates the model using the inputs specified in the `Simulink.SimulationInput` object `simIn`. The `sim` command can be used with an array of `SimulationInput` objects to run multiple simulations in a series. If `simIn` is an array of `Simulink.SimulationInput` objects, output is returned as an array of `Simulink.SimulationOutput` objects.

`simOut = sim(model,ParameterStruct)` simulates the specified model using the parameter values specified in the structure `ParameterStruct`.

`simOut = sim(model,ConfigSet)` simulates the specified model using the configuration settings specified in the model configuration set `ConfigSet`.

Examples

Set Block Parameters using an Array of Simulink.SimulationInput Objects

This example modifies the block parameters of a model through the `SimulationInput` object.

Open the model.

```
openExample('simulink/OpenTheModelExample');
open_system('ex_sldemo_househeat');
load_system('ex_sldemo_househeat')
```

Create a `SimulationInput` object for this model.

```
mdl = 'sldemo_househeat';
in = Simulink.SimulationInput(mdl);
```

Modify block parameter.

```
in = in.setBlockParameter('sldemo_househeat/Set Point','Value','300');
```

Simulate the model.

```
out = sim(in)
```

Simulate Model with Default Parameter Settings

Simulate the model, `vdp` as it is in the present state, whether it is not loaded or is loaded and has some unsaved changes.

On the Data Import/Export pane of the Configuration Parameters dialog box, **Single simulation output** is selected by default, so `sim` returns the simulation results using the single-output format (simulation object). This selection overrides the Dataset format used for signal logging.

```
simOut = sim('vdp')
```

Simulate Model with `sim` Command-Line Options in Structure

Simulate the model, `vdp`, and save the states in `xoutNew` and the output in `youtNew`.

Specify parameters using a name-value pairs structure `paramNameValStruct` for the `sim` command:

```
paramNameValStruct.SaveState      = 'on';
paramNameValStruct.StateSaveName = 'xoutNew';
paramNameValStruct.SaveOutput    = 'on';
paramNameValStruct.OutputSaveName = 'youtNew';
simOut = sim('vdp',paramNameValStruct)
```

```
simOut =
  Simulink.SimulationOutput:

      xoutNew: [64x2 double]
      youtNew: [64x2 double]

  SimulationMetadata: [1x1 Simulink.SimulationMetadata]
  ErrorMessage: [0x0 char]
```

Simulate Model with `sim` Command-Line Options in Configuration Set

Simulate the model, `vdp`, for an absolute tolerance of $1e-5$ and save the states in `xoutNew` and the output in `youtNew`.

Specify parameters as name-value pairs in configuration set `mdl_cs` for the `sim` command:

```
mdl = 'vdp';
load_system(mdl)
cs = getActiveConfigSet(mdl);
mdl_cs = cs.copy;
set_param(mdl_cs, 'AbsTol', '1e-5', ...
          'SaveState', 'on', 'StateSaveName', 'xoutNew', ...
          'SaveOutput', 'on', 'OutputSaveName', 'youtNew')
simOut = sim(mdl, mdl_cs)

simOut =
  Simulink.SimulationOutput:

          xoutNew: [65x2 double]
          youtNew: [65x2 double]

  SimulationMetadata: [1x1 Simulink.SimulationMetadata]
  ErrorMessage: [0x0 char]
```

Input Arguments

model — Model to simulate

character vector

Model to simulate, specified as a character vector.

Example: `simOut = sim('vdp')`

ParameterStruct — Structure containing parameter settings

structure

Structure containing parameter settings for the simulation specified as a structure. The fields in the structure are the names of the configuration parameters, and the corresponding values are the parameter values.

ConfigSet — Set of configuration parameters

`Simulink.Configset` object

Set of configuration parameters for a model, specified as a `Simulink.Configset` object. For more information, see `Simulink.ConfigSet`.

simIn — `Simulink.SimulationInput` object for a model

`Simulink.SimulationInput` object

Simulation input object for a model, specified as a `Simulink.SimulationInput` object created by specifying the model name. For more information, see `Simulink.SimulationInput`.

Use the `SimulationInput` object to specify Block Parameters, Model Parameters, Variables and External Inputs for simulation.

Example: `simIn = Simulink.SimulationInput('vdp')`

Name-Value Pair Arguments

Specify optional comma-separated pairs of `Name`, `Value` arguments. `Name` is the argument name and `Value` is the corresponding value. `Name` must appear inside quotes. You can specify several name and value pair arguments in any order as `Name1, Value1, . . . , NameN, ValueN`.

Example: `'Solver', 'ode15s', 'Timeout', '30'` specifies that the model is simulated using the `ode15s` solver with a timeout that occurs when `SimulationTime` reaches 30.

You can pass any model parameter and its value to the `sim` command.

In addition, the `sim` command accepts the following parameters that are not available on the `Configset` and `set_param`

CaptureErrors — Option to save errors to SimulationMetadata object

off (default) | on

Option to save errors to `SimulationMetadata` object, specified as 'off' or 'on'. By default, if an error occurs during simulation, the `sim` command stops and reports the error in the MATLAB Command Window. If you specify `'CaptureErrors', 'on'`, the `sim` command saves any errors to the `ErrorDiagnostic` structure within the `SimulationMetadata` object. The error message is saved in the `ErrorMessage` property of the `SimulationOutput` object.

When running multiple simulations in a loop, this option ensures that one simulation error will not stop a script or function from continuing.

If you specify an array of input objects, the `sim` commands runs with `CaptureErrors` enabled. If an error occurs, the error messages are included in the `Simulink.SimulationMetadata` object for the simulation, as well as simulation data up to the point of the failure.

This option is not available for simulation in SIL and PIL modes.

Example: `'CaptureErrors', 'on'`

Debug — Debug mode option

off (default) | on | cmds | cell array

Debug mode option for simulation, specified as 'off' or 'on'. Setting the value of 'Debug' argument to 'on' starts the simulation in debug mode (see “Debugger Graphical User Interface” for more information). The value of this option can be a cell array of commands to be sent to the debugger after it starts.

Example: `'Debug', 'on'`

RapidAcceleratorUpToDateCheck — Perform up-to-date check before simulation

on (default) | off

This option is available in Rapid Accelerator mode only. Pre-simulation up-to-date-check, specified as 'on' or 'off'. If you set this value to 'off', Simulink does not perform an up-to-date check. It skips the start/stop callbacks in blocks. If you call the `sim` command from `parfor`, set this value to 'off'.

When you set this option to 'off', changes that you make to block parameter values in the model (for example, by using block dialog boxes, by using the `set_param` function, or by changing the values of MATLAB variables) do not affect the simulation. Use `RapidAcceleratorParameterSets` to pass new parameter values directly to the simulation.

Example: `'RapidAcceleratorUpToDateCheck', 'off'`

TimeOut — Maximum simulation run time

positive scalar

Maximum simulation run time, specified as a positive scalar. Specify the time, in seconds, to allow the simulation to run. If you run your model for a period longer than the value of `TimeOut`, the software issues a warning and stops the simulation. `TimeOut` refers to the time spent for a simulation.

Example: `'TimeOut',60`

Trace — Enables simulation tracing facilities`minstep` | `siminfo`

Simulation tracing facilities, specified as:

- `'minstep'` specifies that simulation stops when the solution changes so abruptly that the variable-step solvers cannot take a step and satisfy the error tolerances.
- `'siminfo'` provides a short summary of the simulation parameters in effect at the start of simulation.

Example: `'Trace','minstep','Trace','siminfo'`

UseFastRestart — Enables fast restart`off` (default) | `on`

Fast restart option for simulation, specified as `'on'`. Fast restart allows you to perform iterative simulations without compiling a model or terminating the simulation each time.

Output Arguments**simOut — Simulation object containing logged simulation results**`Simulink.SimulationOutput` object

Simulation object containing logged simulation results, returned as a `Simulink.SimulationOutput` object that contains all of the logged simulation results.

All simulation outputs (logged time, states, and signals) are returned in a single `Simulink.SimulationOutput` object. You select the data to be logged, such as the model time, states, and output that is logged using the **Data Import/Export** pane of the **Model Configuration Parameters** dialog box. You can log signals using blocks such as the To Workspace and Scope blocks. For more information on signal logging, see “Signal Logging”.

More About**Backward-Compatible Syntax**

Starting in R2009b, the `sim` command was enhanced to provide greater compatibility with parallel computing. The improved single-output format saves all simulation results to a single object, simplifying the management of output variables.

For compatibility with R2009a or earlier releases, use this syntax:

```
[T,X,Y] = sim('model',Timespan,Options,UT)
[T,X,Y1,...,Yn] = sim('model',Timespan,Options,UT)
```

If you specify only the `model` argument, Simulink automatically saves the time, state, and output to the specified output arguments.

If you do not specify any output arguments, Simulink determines what data to log based on the settings for the **Configuration Parameters > Data Import/Export** pane. Simulink stores the simulation output either in the current workspace or in the variable `ans`, based on the setting for **Save simulation output as a single object** parameter.

Backward-Compatible Syntax Input and Output Arguments

| Argument | Description |
|------------------|--|
| T | The time vector returned. |
| X | The state returned in matrix or structure format. The state matrix contains continuous states followed by discrete states. |
| Y | The output returned in matrix or structure format. For block diagram models, this variable contains all root-level blocks. |
| $Y1, \dots, Yn$ | The outputs, which can only be specified for diagram models. Here, n must be the number of root-level blocks. Each output will be returned in the $Y1, \dots, Yn$ variables. |
| ' <i>model</i> ' | The name of the model to simulate. |
| <i>Timespan</i> | The timespan can be T_{Final} , $[T_{Start} \ T_{Final}]$, or $[T_{Start} \ OutputTimes \ T_{Final}]$. Output times are time points returned in T , but in general, T includes additional time points. |
| <i>Options</i> | Optional simulation parameters created in a structure by the <code>simset</code> command using name-value pairs. |
| <i>UT</i> | Optional external inputs. For supported expressions, see "Load Data to Root-Level Input Ports". |

Simulink requires only the `model` argument. Simulink takes all defaults from the block diagram, including unspecified options. If you specify any optional arguments, your specified settings override the settings in the block diagram.

Specifying an input argument of `sim` as the empty matrix, `[]`, causes Simulink to use the default for that argument.

Tips

- Parameters specified using the `sim` command override the values defined in the **Model Configuration Parameters** dialog box. The software restores the original configuration values at the end of simulation.
- In the case of a model with a Model block, the parameter specifications are applied to the top model.
- When simulating a model with infinite stop time, to stop the simulation, you must press **Ctrl+C**. **Ctrl+C** breaks the simulation, and the simulation results are not saved in the MATLAB workspace.
- To specify the time span for a simulation, you must specify the `StartTime` and `StopTime` parameters.
- To log the model time, states, or outputs, use the **Data Import/Export** pane of the Model Configuration Parameters dialog box.

- To log signals, either use a To Workspace block such as the To Workspace block or the Scope block, or use Signal Logging. For more information, see “Export Signal Data Using Signal Logging”.
- To get a list of simulation parameters for the model vdp, in the MATLAB Command Window, enter:

```
configSet = getActiveConfigSet('vdp')  
configSetNames = get_param(configSet, 'ObjectParameters')
```

This command lists several object parameters, including simulation parameters such as 'StopTime', 'SaveTime', 'SaveState', 'SaveOutput', and 'SignalLogging'.

See Also

Functions

parsim | sldebug | Simulink.ConfigSet | Simulink.SimulationOutput |
Simulink.SimulationInput

Blocks

To Workspace | Scope

Topics

“Run Simulations Programmatically”

“Running Multiple Simulations”

“Manage Configuration Sets for a Model”

“Set Model Configuration Parameters for a Model”

“Log Data to Persistent Storage”

Introduced before R2006a

simplot

Redirects to the Simulation Data Inspector

Note `simplot` will be removed in a future release. Use the Simulation Data Inspector instead.

Syntax

```
simplot
```

Description

`simplot` redirects to the Simulation Data Inspector and returns empty handles. This function is no longer supported and has been replaced by the Simulation Data Inspector. Use the **Simulation Data Inspector** button in the Simulink Editor to capture simulation output in the Simulation Data Inspector. Programmatically, use the function `Simulink.sdi.view` instead.

See Also

`Simulink.sdi.view`

Simulation Manager

Monitor multiple simulations and visualize the simulation data

Description

Simulation Manager allows you to monitor the status of multiple simulations. Using this tool, you can:

- View the progress of the simulations in a high-level grid view or a detailed list view.
- Find the simulations that error out and view diagnostics for each simulation.
- Visualize simulation data to analyze the trends across the simulations.
- Select a simulation run and open the model in Simulink, with all of the simulation settings applied to the model.
- View simulation results in the Simulation Data Inspector.
- Abort simulations.

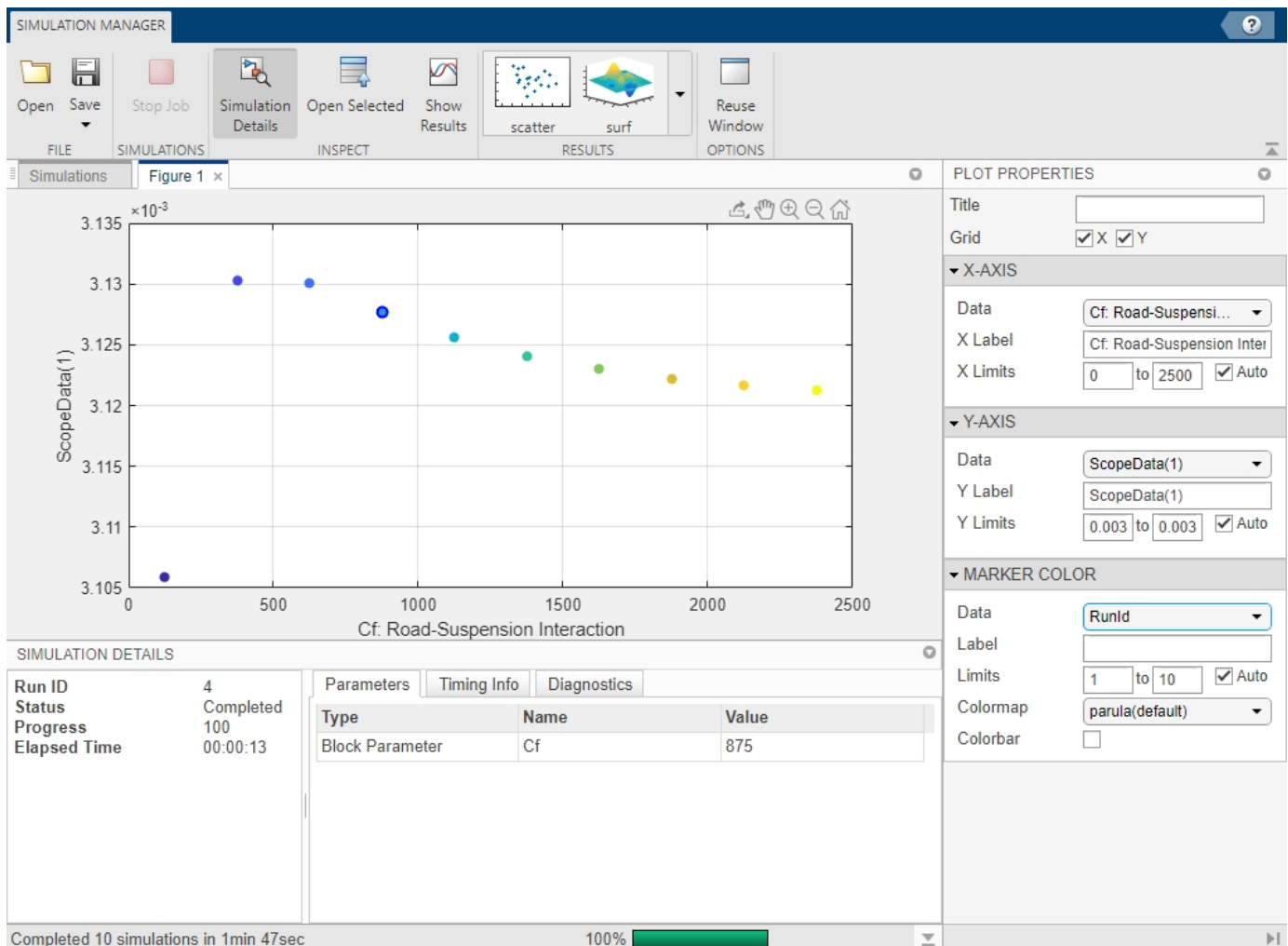

Open the Simulation Manager

- `parsim` and `sim` commands — Set the argument `ShowSimulationManager` to `on` with Parallel Computing Toolbox. The `parsim` and `sim` commands use a `Simulink.SimulationInput` object to run simulations. For more information, see `Simulink.SimulationInput`.

```
out = parsim(in, 'ShowSimulationManager', 'on')
```

```
out = sim(in, 'ShowSimulationManager', 'on')
```

- To open a saved Simulation Manager session, navigate to the folder where the file is saved and double click the `.mldatx` Simulation Manager file.

```
open filename.mldatx
```

- To open a Simulation Manager with the `Simulink.SimulationInput` object, `in`, and a `Simulink.SimulationOutput` object, `out`, of a completed run, use the `openSimulationManager` command.

```
openSimulationManager(in, out)
```

Examples

Open Simulation Manager

Open the model `sldemo_suspn_3dof` and create a set of sweep values.

```
mdl = 'sldemo_suspn_3dof';
open_system(mdl);
Cf_sweep = Cf*(0.05:0.1:0.95);
numSims = length(Cf_sweep);
```

To modify the block parameter **Road-Suspension Interaction** with the sweep values, create an array of `Simulink.SimulationInput` objects.

```
in(1:numSims) = Simulink.SimulationInput(mdl);
for i = 1:numSims
    in(i) = setBlockParameter(in(i), [mdl '/Road-Suspension Interaction'], 'Cf', num2str(Cf_sweep(i)));
end
```

Run multiple simulations and open the Simulation Manager.

```
out = parsim(in, 'ShowSimulationManager', 'on')
```

In the absence of Parallel Computing Toolbox, the simulations run in serial.

Using Simulation Manager

Once you run the `parsim` command, the Simulation Manager UI opens up as follows:

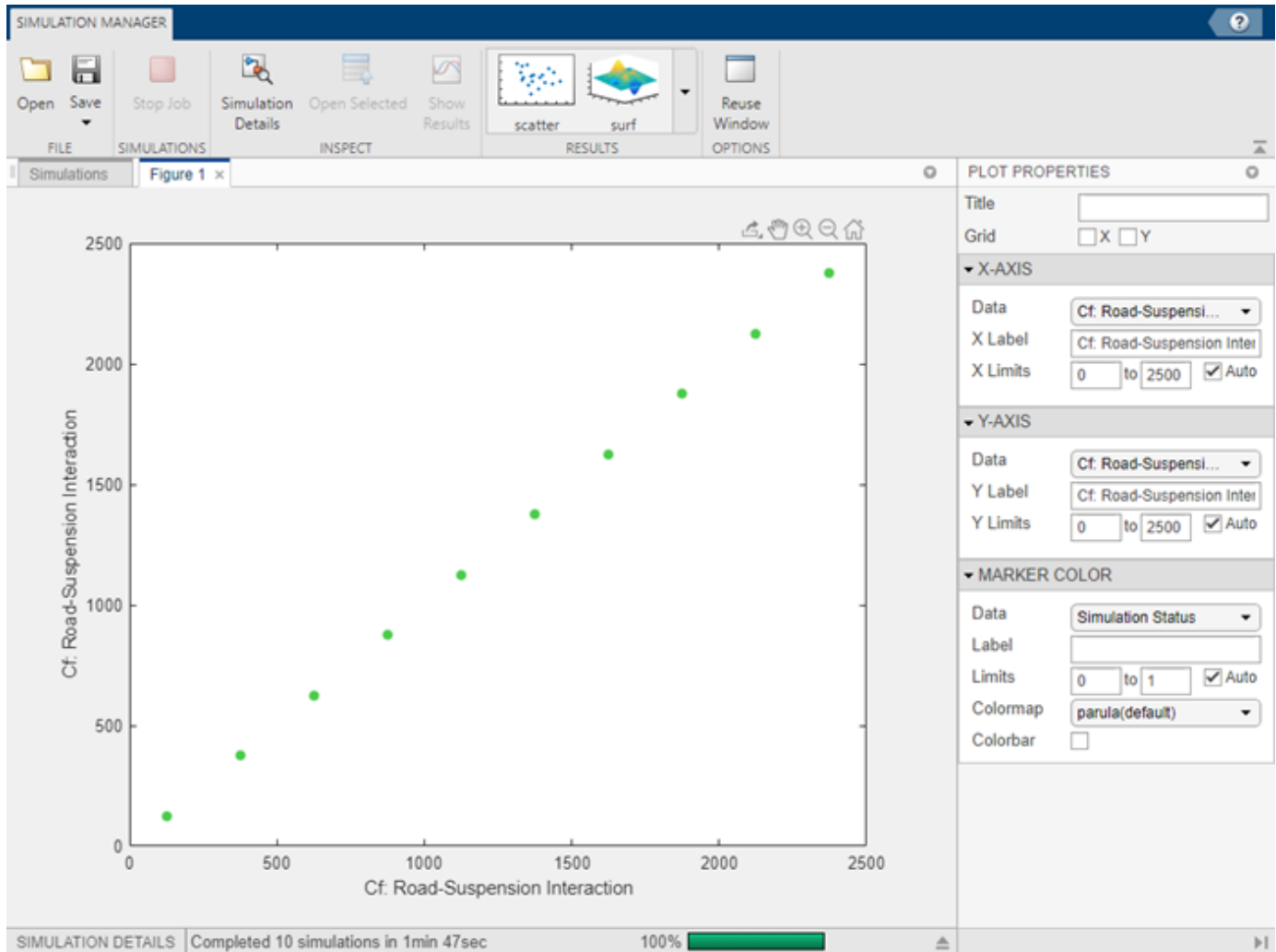

Plot results

In the **Figure 1** tab, you can view the default scatter plot where the parameter `Cf` is plotted against itself. Use the **Plot Properties** to edit the plot. Add grid lines for X and Y by checking the corresponding boxes. You can also change the data that is displayed on X- and Y- axes and the Marker Color. Change the data on y-axis by selecting `ScopeData(1)` from the **Data** drop-down. Set the Marker Color Data field to `RunID`.

To add another figure to the Simulation Manager, click **surf** or **scatter** plot and add plots as desired. In this example, click **surf** plot, located in the **Results** section of the toolbar. Drag the **Figure 2** tab to view the two plots together.

Plots in the Simulation Manager support numeric arrays and datasets.

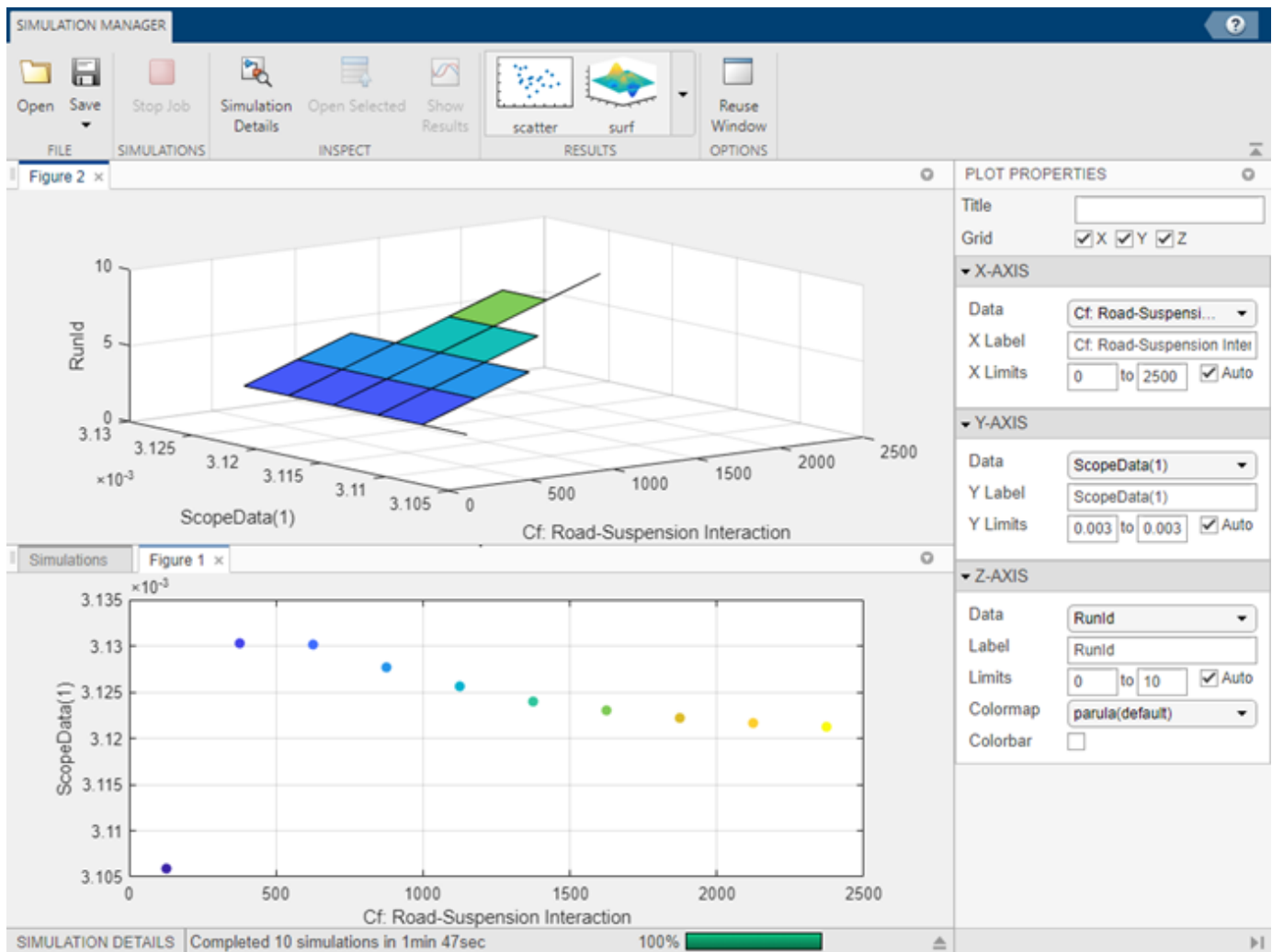

Adding multiple plots to the Simulation Manager enables you to observe the simulation data in different ways. Using the results, you can analyze and study the design space of the parameters and their behavior.

You can modify the configuration of the plot layouts by clicking the down arrow on the right corner of the plot.

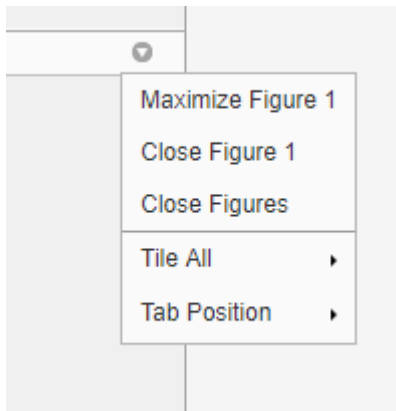

- **Tile All** — Choose a layout for multiple plots.
- **Tab Position** — Select where to display the figure tab.

View the Status

To view the status of the simulations in list and grid views, click the **Simulations** tab next to **Figure 1**. Toggle between the **List** and **Grid** in the **Views** section of the toolbar. The list view shows a tabular view of the simulations with certain details, such as status, parameters and timing information. For large number of simulations, choose grid view for a compact view of the status of the simulations.

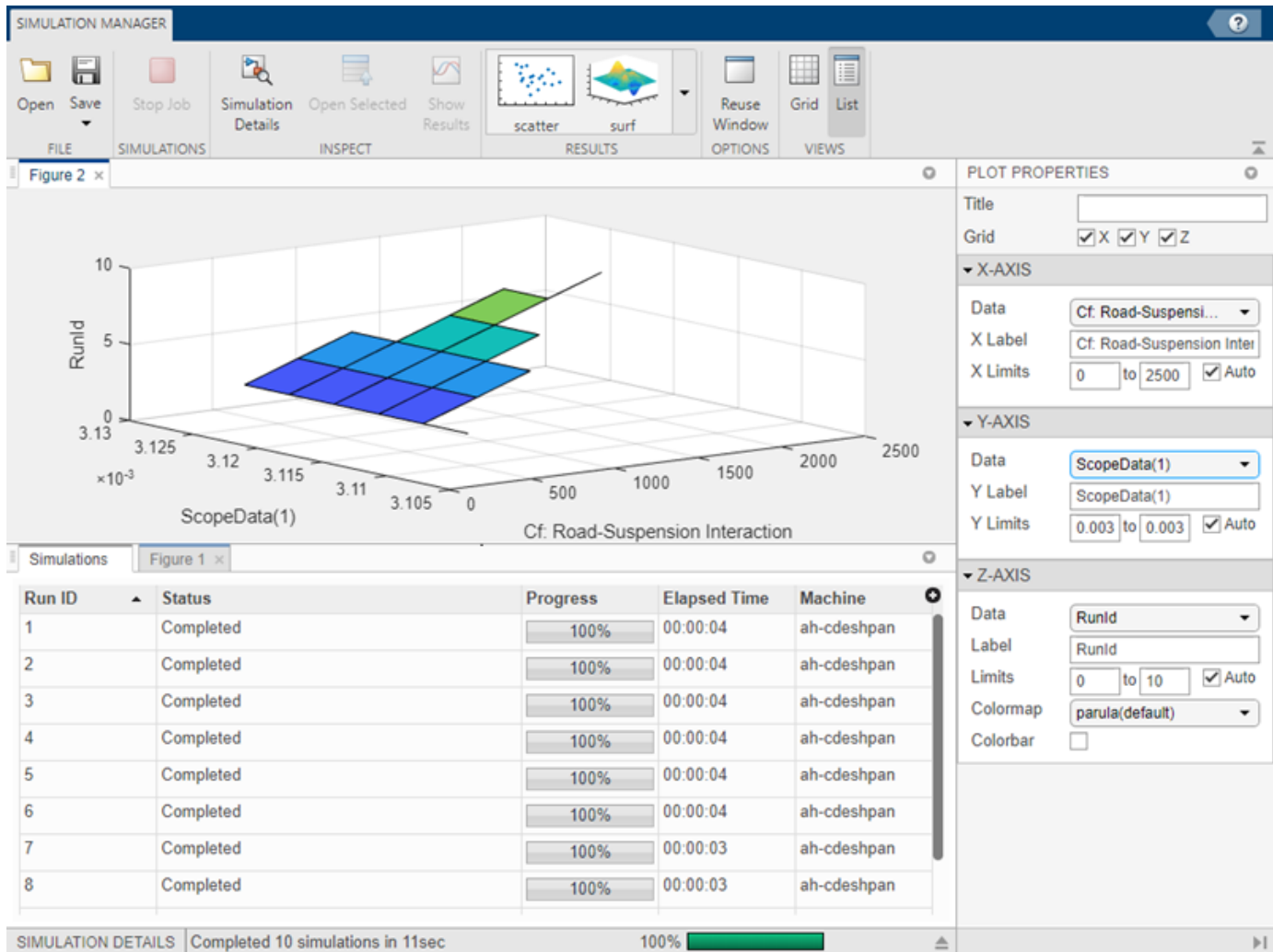



The status bar at the bottom of the window shows the progress of the simulations.

You can view all the multiple simulations in a detailed list view. This view gives you an option to add or delete columns. Use the  button to choose which columns to display. You can also sort the columns based on your preference.

Click a specific run to view more details about it.. The simulation details appear at the bottom of the window.

To show or hide the details of the selected simulation, toggle the **Simulation Details** button, .

Open Selected button, , allows you to open the model with the specifications of the selected run.

You can view the results of one or more runs in the Simulation Data Inspector by clicking the **Show Results** button, . Clicking **Show Results** creates a Simulation Data Inspector run from the `Simulink.SimulationOutput` object and is displayed in Simulation Data Inspector.

To abort the job while the simulations are running, you can use the **Stop Job** button, .

Save the Session

To save the Simulation Manager session, click the **Save** button on the toolbar. The saved session contains all the simulation data and the plot configurations and layout. To reopen the saved Simulation Manager session, navigate to the folder where the file is saved and double-click the `.mlatx` Simulation Manager file.



The **Reuse Window**, , button enables you to reuse the plot layout and configurations for new multiple simulations run with a different set of data. If the button is toggled off, a new window opens with each set of simulations. If the button is toggled on, the new simulations reuse the existing window preserving all plot configurations and layouts.

To reopen a saved file, use the **Open** button, navigate to the file location and double click the file.

See Also

Functions

`parsim` | `sim` | `Simulink.SimulationInput` | `applyToModel` | `setExternalInput` | `setInitialState` | `setVariable` | `setModelParameter` | `setBlockParameter` | `validate` | `setPreSimFcn` | `setPostSimFcn`

Topics

“Run Parallel Simulations for a Thermal Model of a House Using `parsim`”
“Running Multiple Simulations”
“Analyze Results Using Simulation Manager”
“Run Parallel Simulations”

simulink

Open Simulink Start Page

Syntax

```
simulink
```

Description

`simulink` opens the Simulink Start Page. From the Start Page, choose a model or project template or browse the examples. See “Build and Edit a Model Interactively”.

Examples

Open Simulink from MATLAB Command Window

In the MATLAB Command Window, use the `simulink` function.

```
simulink
```

The Simulink Start Page opens.

Tips

To start Simulink without opening the Library Browser or Start Page, use `start_simulink`, which is faster than `simulink`.

Compatibility Considerations

`simulink` function opens Simulink Start Page

Behavior changed in R2016a

The behavior of the `simulink` function changed in R2016a. Formerly, it opened the Simulink Library Browser and loaded the Simulink block library.

- To open the Library Browser, use `sLibraryBrowser`.
- To only load the Simulink block library, use this command.

```
load_system simulink
```

See Also

`start_simulink` | `sLibraryBrowser`

Topics

“Build and Edit a Model Interactively”
“Modeling”

Introduced before R2006a

simulinkproject

(Not recommended) Open project and get project object

Note simulinkproject is not recommended. Use currentProject or openProject instead. For more information, see “Compatibility Considerations”.

Syntax

```
simulinkproject
simulinkproject(projectPath)

proj = simulinkproject
proj = simulinkproject(projectPath)
```

Description

simulinkproject opens the project or brings focus to the tool if it is already open. After you open the tool, you can create projects or access recent projects using the **Project** tab.

simulinkproject(projectPath) opens the project specified by any file or folder under the project root in projectPath and gives focus to the project.

proj = simulinkproject returns a project object proj you can use to manipulate the project at the command line. You need to get a project object before you can use any of the other project functions.

proj = simulinkproject(projectPath) opens the project specified by projectPath and returns a project object.

Examples

Open Project Tool

Open the Project Tool.

```
simulinkproject
```

Open a Project

Specify either the .prj file path or the folder that contains your .SimulinkProject folder and .prj file. The project opens and brings focus to the project.

```
simulinkproject('C:/projects/project1/')
```

Open a Project and Get a Project Object

Open a specified project and get a project object to manipulate the project at the command line. To avoid your startup script opening windows that take focus away from the MATLAB Desktop, use `start_simulink` instead of the `simulink` function, and use `simulinkproject` with an output argument instead of `uiopen`. If you use `uiopen(myproject.prj)` this calls `simulinkproject` with no output argument and gives focus to the project.

```
start_simulink
proj = simulinkproject('C:/projects/project1/myproject.prj')
```

Get Airframe Example Project

Open the Airframe project and create a project object to manipulate and explore the project at the command line.

```
sldemo_slproject_airframe
proj = simulinkproject
```

```
proj =
```

```
    ProjectManager with properties:
```

```
        Name: 'Simulink Project Airframe Example'
    Information: [1x1 slproject.Information]
  Dependencies: [1x1 slproject.Dependencies]
    Categories: [1x1 slproject.Category]
        Files: [1x31 slproject.ProjectFile]
    Shortcuts: [1x7 slproject.Shortcut]
    ProjectPath: [1x7 slproject.PathFolder]
  ProjectReferences: [1x0 slproject.ProjectReference]
    StartupFiles: [1x0 slproject.StartupFile]
  ShutdownFiles: [1x0 slproject.ShutdownFile]
    RootFolder: 'C:\slexamples\airframell'
```

Find Project Commands

Find out what you can do with your project.

```
methods(proj)
```

```
Methods for class slproject.ProjectManager:
```

```
addFile
addFolderIncludingChildFiles
addPath
addReference
addShortcut
addShutdownFile
addStartupFile
close
createCategory
export
```

```

findCategory
findFile
isLoading
listModifiedFiles
listRequiredFiles
refreshSourceControl
reload
removeCategory
removeFile
removePath
removeReference
removeShortcut
removeShutdownFile
RemoveStartupFile

```

Examine Project Properties Programmatically

After you get a project object using the `simulinkproject` function, you can examine project properties.

Examine the project files.

```
files = proj.Files
```

```
files =
```

```
1x31 ProjectFile array with properties:
```

```

Path
Labels
Revision
SourceControlStatus

```

Use indexing to access files in this list. The following command gets file number 14. Each file has properties describing its path, attached labels, and source control information.

```
proj.Files(15)
```

```
ans =
```

```
ProjectFile with properties:
```

```

Path: 'C:\slexamples\airframe24\models\DigitalControl.slx'
Labels: [1x1 slproject.Label]
Revision: '2'
SourceControlStatus: Unmodified

```

Examine the labels of the file.

```
proj.Files(15).Labels
```

```
ans =
```

```
Label with properties:
```

```

File: 'C:\slexamples\airframe24\models\DigitalControl.slx'
DataType: 'none'

```

```
Data: []  
Name: 'Design'  
CategoryName: 'Classification'
```

Get a particular file by name.

```
myfile = findFile(proj, 'models/AnalogControl.slx')
```

```
myfile =
```

```
ProjectFile with properties:
```

```
Path: 'C:\slexamples\airframe24\models\AnalogControl.slx'  
Labels: [1x1 slproject.Label]  
Revision: '2'  
SourceControlStatus: Unmodified
```

Find out what you can do with the file.

```
methods(myfile)
```

```
Methods for class slproject.ProjectFile:
```

```
addLabel findLabel removeLabel
```

Update the file dependencies.

```
update(proj.Dependencies)
```

The project runs a dependency analysis to update the known dependencies between project files.

For more information on working with project files, including modified files and dependencies, see “Automate Project Tasks Using Scripts”.

Input Arguments

projectPath — Full path to project file or folder

character vector

Full path to project .prj file, or the path to the project root folder, or any subfolder or file under your project root, specified as a character vector.

Example: 'C:/projects/project1/myProject.prj'

Example: 'C:/projects/project1/'

Output Arguments

proj — Project

project object

Project, returned as a project object. Use the project object to manipulate the currently open project at the command line.

Properties of proj output argument.

| Project Property | Description |
|-------------------|---|
| Categories | Categories of project labels |
| Dependencies | Dependencies between project files in a MATLAB digraph object |
| Files | Paths and names of project files |
| Information | Information about the project such as the description, source control integration, repository location, and whether it is a top-level project |
| Name | Project name |
| ProjectPath | Folders that the project puts on the MATLAB path |
| ProjectReferences | Folders that contain referenced projects. Contains read-only project objects for referenced projects. |
| RootFolder | Full path to project root folder |
| Shortcuts | An array of the shortcuts in this project |
| ShutdownFiles | An array of the shutdown files in this project |
| StartupFiles | An array of the startup files in this project |

Tips

Alternatively, you can use `slproject.loadProject` to load a project, and `slproject.getCurrentProjects` to get a project object. Use `simulinkproject` to open projects and explore projects interactively. Use `slproject.getCurrentProjects` and `slproject.loadProject` for project automation scripts.

Compatibility Considerations

Simulink project API is not recommended

Not recommended starting in R2019a

Starting in R2019a, instead of `simulinkproject` and related functions, use the `currentProject` or `openProject` functions in MATLAB. The Simulink project API will continue to be supported, but, after R2019a, new features will be available only if you use the new MATLAB project API. There are no plans to remove the Simulink project API at this time.

You can continue to use `simulinkproject` and related functions listed in `methods(simulinkproject)`. New functions added after R2019a, such as `runChecks` and `listImpactedFiles`, do not work with `simulinkproject`. Use `currentProject` instead.

The new MATLAB project API is part of the R2019a functionality enabling you to use projects in MATLAB, with or without Simulink. You can now share projects with users who do not have Simulink.

See Also

Functions

`currentProject` | `slproject.create` | `slproject.getCurrentProjects` | `slproject.loadProject`

Topics

“Automate Project Tasks Using Scripts”

“Create a New Project From a Folder”

“Open Recent Projects”

“Clone Git Repository”

“Check Out SVN Repository”

“What Are Projects?”

Introduced in R2012a

Simulink.allBlockDiagrams

Find loaded Simulink models and libraries

Syntax

```
bd = Simulink.allBlockDiagrams()  
bd = Simulink.allBlockDiagrams(type)
```

Description

`bd = Simulink.allBlockDiagrams()` returns all loaded block diagrams, including models and libraries.

`bd = Simulink.allBlockDiagrams(type)` returns either models or libraries.

Examples

Find Loaded Models

Find all loaded models in the current Simulink session, excluding libraries. The example shows a result from a typical session.

```
Simulink.allBlockDiagrams('model')
```

```
ans =  
  
    237.0001  
     56.0001  
     2.0001
```

Get Names of Loaded Block Diagrams

Find all loaded models in the current Simulink session and return results as names. Use `Simulink.allBlockDiagrams` with `get_param` to get the names. The example shows a result from a typical session and includes loaded libraries and models.

```
get_param(Simulink.allBlockDiagrams(), 'Name')
```

```
ans =  
  
    5×1 cell array  
  
    {'simulink_extras'}  
    {'simulink'      }  
    {'sldemo_fuelsys' }
```

```
{'f14'      }  
{'vdp'     }
```

Get Loaded Block Diagrams Based on Parameter

Find all loaded models in the current Simulink session whose 'Dirty' parameter is 'on'.

```
bds = Simulink.allBlockDiagrams();  
dirtyBds = bds(strcmp(get_param(bds,'Dirty'),'on'));
```

Input Arguments

type — Type of block diagram whose blocks to return

'model' | 'library'

Type of block diagram whose blocks to return, specified as 'model' or 'library'.

Output Arguments

bd — Loaded block diagrams

array of handles

Loaded block diagrams, returned as an array of handles.

See Also

[Simulink.FindOptions](#) | [Simulink.findBlocksOfType](#) | [Simulink.findBlocks](#)

Introduced in R2018a

delete

Package: Simulink

Delete annotation

Syntax

```
delete(a)
```

Description

`delete(a)` deletes the specified annotation.

Examples

Delete Annotation

Programmatically delete an annotation.

Open the vdp model.

```
vdp
```

To get the handles for the annotations in the model, use the `find_system` function.

```
h = find_system(gcs, 'FindAll', 'on', 'Type', 'annotation');
```

To identify the annotations, query the text inside the annotations.

```
get_param(h, 'PlainText')  
  
ans = 2x1 cell  
    {'Copyright 2004-2020 The MathWorks, Inc.'}  
    {'van der Pol Equation'}
```

To delete the title of the model ('van der Pol Equation'), get the `Simulink.Annotation` object that corresponds to the second handle.

```
a = get_param(h(2), 'Object');
```

Delete the annotation from the model.

```
delete(a)
```

Input Arguments

a — Annotation

`Simulink.Annotation` object

Annotation, specified as a `Simulink.Annotation` object.

See Also

`Simulink.Annotation` | `view` | `setImage`

Topics

“Describe Models Using Notes and Annotations”

“Create and Edit Annotations Programmatically”

Introduced before R2006a

setImage

Package: Simulink

Specify image to display as annotation

Syntax

```
setImage(a,img)
```

Description

`setImage(a,img)` changes the annotation to display only the specified image.

Examples

Add Image to Model

Add an image to your model, such as a logo, by creating an image-only annotation.

Open a new model and create an annotation in it.

```
open_system(new_system)
a = Simulink.Annotation(gcs,'This is an annotation.');
```

Change the annotation to display only the specified image.

```
img = fullfile(matlabroot,'toolbox','matlab','imagesci','peppers.png');
setImage(a,img)
```

Input Arguments

a — Annotation

Simulink.Annotation object

Annotation, specified as a Simulink.Annotation object.

img — Image filename

character vector | string scalar

Image filename, specified as a character vector or string scalar. The filename must contain the file extension and can include a partial path, complete path, relative path, or no path.

Data Types: char | string

See Also

Simulink.Annotation | view | delete

Topics

“Describe Models Using Notes and Annotations”

“Create and Edit Annotations Programmatically”

Introduced in R2014a

view

Package: Simulink

Find annotation

Syntax

```
view(a)
```

Description

`view(a)` displays and briefly highlights the specified annotation.

Examples

Create Annotation Programmatically

Programmatically create, modify, and view an annotation.

Open a new model.

```
open_system(new_system)
```

Create an annotation with default properties using the `Simulink.Annotation` function.

```
a = Simulink.Annotation(gcs, 'This is an annotation.');
```

After creating the annotation, use dot notation to set property values. For example, apply an 18-point font and light blue background to the annotation.

```
a.FontSize = 18;  
a.BackgroundColor = 'lightBlue';
```

To view and briefly highlight the new annotation, use the `view` function.

```
view(a)
```

Input Arguments

a — Annotation

`Simulink.Annotation` object

Annotation, specified as a `Simulink.Annotation` object.

See Also

`Simulink.Annotation` | `delete` | `setImage`

Topics

“Describe Models Using Notes and Annotations”

“Create and Edit Annotations Programmatically”

Introduced before R2006a

Simulink.architecture.add

Add tasks or triggers to selected architecture of model

Syntax

```
Simulink.architecture.add(Type, Object)
```

Description

`Simulink.architecture.add(Type, Object)` adds the new task or trigger `Object` of the specified `Type` to a model.

Examples

Add periodic trigger

Add a task, `MyTask1`, to the software node `MulticoreProcessor` of the selected architecture of the `slexMulticoreExample` model.

```
slexMulticoreExample;
Simulink.architecture.add('Task', 'slexMulticoreExample/MulticoreProcessor/Core2/MyTask1');
```

Input Arguments

Type — Object type

'PeriodicTrigger' | 'AperiodicTrigger' | 'Task'

Object type that identifies the kind of trigger or task to add, , specified as a 'PeriodicTrigger', 'AperiodicTrigger', or 'Task'.

- 'PeriodicTrigger'

Adds a periodic trigger to the architecture. Set the properties of the trigger with the `Simulink.architecture.set_param` function.

- 'AperiodicTrigger'

Adds an aperiodic trigger to the architecture. Set the properties of the trigger with the `Simulink.architecture.set_param` function.

- 'Task'

Adds a task to the architecture. Set the properties of the task with the `Simulink.architecture.set_param` function.

Object — Trigger or task object identifier

character vector

Trigger or task object identifier to add to architecture, specified as a character vector.

Example: 'slexMulticoreExample/MulticoreProcessor/Core2/MyTask1'

Data Types: char

See Also

`Simulink.architecture.set_param` | `Simulink.architecture.get_param` |
`Simulink.architecture.delete` | `Simulink.architecture.find_system` |
`Simulink.architecture.importAndSelect` | `Simulink.architecture.profile` |
`Simulink.architecture.register`

Introduced in R2014a

Simulink.architecture.config

Create or convert configuration for concurrent execution

Syntax

```
Simulink.architecture.config(model, 'Convert')  
Simulink.architecture.config(model, 'Add')  
Simulink.architecture.config(model, 'OpenDialog')
```

Description

`Simulink.architecture.config(model, 'Convert')` converts the active configuration set in the specified model to one for concurrent execution.

`Simulink.architecture.config(model, 'Add')` adds and activates a new configuration set for concurrent execution.

`Simulink.architecture.config(model, 'OpenDialog')` opens the Concurrent Execution dialog box for a model configuration.

Examples

Convert existing configuration set

Convert existing configuration set for concurrent execution in the model `vdp`.

```
vdp;  
Simulink.architecture.config('vdp', 'Convert');
```

Add new configuration set

Add a new configuration set (copied from the existing configuration set) for concurrent execution in the model `vdp`.

```
vdp;  
Simulink.architecture.config('vdp', 'Add');
```

Open Concurrent Execution dialog box

Open the Concurrent Execution dialog box in the model `slexMulticoreExample`.

```
slexMulticoreExample;  
Simulink.architecture.config('slexMulticoreExample','OpenDialog');
```

Input Arguments

model — Model name

character vector

Model name whose configuration set you want to convert or add to, specified as a character vector.

Example:

Data Types: char

See Also

[Simulink.architecture.add](#) | [Simulink.architecture.set_param](#) |
[Simulink.architecture.profile](#)

Introduced in R2014a

signalBuilderToSignalEditor

Import signal data and properties from Signal Builder block to Signal Editor block

Syntax

```
signal_editor = signalBuilderToSignalEditor(signal_builder,Name,Value)
[signal_editor,sorted_group_index,sorted_group_names] =
signalBuilderToSignalEditor(signal_builder,Name,Value)
```

Description

`signal_editor = signalBuilderToSignalEditor(signal_builder,Name,Value)` imports signal data and properties from Signal Builder block to the Signal Editor block. This function adds a Signal Editor block to the current model using the signal data and properties from the Signal Builder block.

During the port, the `signalBuilderToSignalEditor` function:

- Unicode group names are prefixed with `Test_Case_`.
- Group names are converted to valid MATLAB variable names with leading and trailing white spaces removed.
- Group names are converted with trailing underscores removed.
- Remaining numbers maintained in the scenario name.
- Orders signal groups alphabetically.
- Creates unique group names from existing names following MATLAB conventions.

The `signalBuilderToSignalEditor` function does not support

- Models that contain test case parameters. You can successfully port data from the Signal Builder block, but you cannot initialize parameters with the Signal Editor block in test harnesses generated by Simulink Design Verifier.
- Models that contain Signal Builder signal generators created from the **Create and Connect Generator** context menu.

`[signal_editor,sorted_group_index,sorted_group_names] = signalBuilderToSignalEditor(signal_builder,Name,Value)` outputs vectors containing the signal groups and group names.

Examples

Replace Signal Builder Block with Signal Editor Block

This example shows how to replace an existing Signal Builder block with a Signal Editor block. To store signals from Signal Builder, the example uses `RoadProfiles.mat`.

```
model = 'ex_replace_signalbuilder';
open_system(model);
```

```

sbBlockH = [model '/Road Profiles'];
seBlockH = signalBuilderToSignalEditor(sbBlockH,...
'Replace',true,'FileName','RoadProfiles.mat');

```

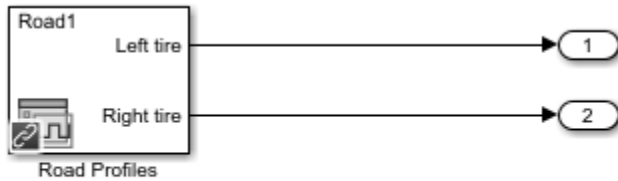

Copyright 2018 The MathWorks, Inc.

Input Arguments

signal_builder — Signal Builder block to replace

current model (default) | scalar

Signal Builder block to replace, specified as a scalar.

Data Types: char | string

Name-Value Pair Arguments

Specify optional comma-separated pairs of **Name**, **Value** arguments. **Name** is the argument name and **Value** is the corresponding value. **Name** must appear inside quotes. You can specify several name and value pair arguments in any order as **Name1**, **Value1**, ..., **NameN**, **ValueN**.

Example: 'FileName', 'RoadProfiles.mat'

FileName — MAT-file that stores signals

'dataset.mat' (default) | scalar

MAT-file that stores signals and properties, specified as a scalar. Do not use a file name from one locale in a different locale. When using the block on multiple platforms, consider specifying just the MAT-file name and having the MAT-file be on the MATLAB path.

Data Types: char | string

Replace — Replace Signal Builder block with Signal Editor block

false (default) | true

Replace Signal Builder block with Signal Editor block, specified as true or false.

Data Types: logical

Output Arguments

signal_editor — Signal Editor block handle

scalar

Signal Editor block handle, specified as a scalar.

sorted_group_index — List of Signal Builder group indices

vector

List of Signal Builder group indices, specified as a vector and ordered as they will appear in the Signal Editor.

sorted_group_names — List of Signal Builder group names

cell array

Signal Editor group names, specified as a cell array of vectors, in alphabetical order.

The names are unique valid MATLAB variable names generated from the Signal Builder group names.

.

Limitations

The Signal Editor block can output a bus for each signal, but cannot output all signals in a single bus. If the Signal Builder block from which you are importing signal data has a bus as output, consider:

- Creating or using an existing `Simulink.Bus` bus object to contain the Signal Builder bus signals. The `Simulink.Bus` object contains the `Simulink.BusElement` that define each element in the `Simulink.Bus` object.
- In the Signal Editor user interface, creating a bus element and dragging and dropping the signals imported from the Signal Builder block into that bus element.
- After running the `signalBuilderToSignalEditor` function, select the **Output a bus signal** check box in the Signal Editor block and enter the Signal Builder bus object name in **Select bus object** text box.

See Also

Signal Builder | Signal Editor | `signalbuilder` | `signalEditor`

Introduced in R2018a

Simulink.architecture.delete

Delete triggers and tasks from selected architecture of model

Syntax

```
Simulink.architecture.delete(Object)
```

Description

`Simulink.architecture.delete(Object)` deletes the specified object trigger or task.

Examples

Delete task Plant

Delete the task Task3 from the Core2 periodic trigger of the MulticoreProcessor software node of the selected architecture of the `slexMulticoreExample` model.

```
slexMulticoreExample  
Simulink.architecture.delete('slexMulticoreExample/MulticoreProcessor/Core2/Task3')
```

Input Arguments

Object — Object to delete, specified as a character vector

character vector

Object to be deleted. Possible objects are:

- Periodic trigger

Note You cannot delete the last periodic trigger. The software node must contain at least one periodic trigger.

- Aperiodic trigger
- Task

Example: `[bdroot '/MulticoreProcessor/Core2/Task3']`

Data Types: char

See Also

`Simulink.architecture.get_param` | `Simulink.architecture.add` |
`Simulink.architecture.find_system` | `Simulink.architecture.importAndSelect` |
`Simulink.architecture.profile` | `Simulink.architecture.register`

Introduced in R2014a

Simulink.architecture.find_system

Find objects under architecture object

Syntax

```
object = Simulink.architecture.find_system(RootObject)
```

```
object = Simulink.architecture.find_system(RootObject, ParamName, ParamValue)
```

Description

`object = Simulink.architecture.find_system(RootObject)` looks for all objects under `RootObject`.

`object = Simulink.architecture.find_system(RootObject, ParamName, ParamValue)` returns the object in `RootObject` whose parameter `ParamName` has the value `ParamValue`. Parameter name and value character vectors are case-sensitive.

Examples

Look for all objects

To find all the objects in `slexMulticoreExample`:

```
slexMulticoreExample
t = Simulink.architecture.find_system('slexMulticoreExample')

t =

    'slexMulticoreExample'
    'slexMulticoreExample/MulticoreProcessor'
    'slexMulticoreExample/MulticoreProcessor/Core1'
    'slexMulticoreExample/MulticoreProcessor/Core1/Task1'
    'slexMulticoreExample/MulticoreProcessor/Core1/Task2'
    'slexMulticoreExample/MulticoreProcessor/Core2'
    'slexMulticoreExample/MulticoreProcessor/Core2/Task3'
    'slexMulticoreExample/MulticoreProcessor/Core2/Task4'
```

Look for all tasks

To find all the tasks in `slexMulticoreExample`:

```
slexMulticoreExample
t = Simulink.architecture.find_system('slexMulticoreExample', 'Type', 'Task')

t =

    'slexMulticoreExample/MulticoreProcessor/Core1/Task1'
    'slexMulticoreExample/MulticoreProcessor/Core1/Task2'
```

```
'slexMulticoreExample/MulticoreProcessor/Core2/Task3'  
'slexMulticoreExample/MulticoreProcessor/Core2/Task4'
```

Input Arguments

RootObject — Object to search

character vector

Object to search for parameter value, specified as a character vector giving the object full path name. Possible objects are:

- Model
- Software node
- Hardware node
- Periodic trigger
- Aperiodic trigger
- Task

Example: 'slexMulticoreExample'

ParamName — Name of parameter to find

character vector | scalar | vector

Name of the parameter to find. Possible values are:

- 'Name'
- 'Type'
- 'ClockFrequency'
- 'Color'
- 'Period'
- 'EventHandlerType'
- 'SignalNumber'
- 'EventName'

Example: 'EventName'

ParamValue — Parameter value to find

character vector | scalar | vector

Parameter value to find, specified as a character vector, a scalar, or a vector.

Example: 'ERTDefaultEvent'

See Also

[Simulink.architecture.set_param](#) | [Simulink.architecture.add](#) |
[Simulink.architecture.delete](#) | [Simulink.architecture.importAndSelect](#) |
[Simulink.architecture.profile](#) | [Simulink.architecture.register](#)

Introduced in R2014a

Simulink.architecture.get_param

Get configuration parameters of architecture objects

Syntax

```
ParamValue = Simulink.architecture.get_param(Object,ParamName)
```

Description

`ParamValue = Simulink.architecture.get_param(Object,ParamName)` returns the value of the specified parameter for the object, `Object`. `ParamName` is case-sensitive.

Examples

Get period

Get the period of task `Task3` of trigger `Core2` of software node `MulticoreProcessor` of the selected architecture for the model `slexMulticoreExample`.

```
slexMulticoreExample;  
p = Simulink.architecture.get_param('slexMulticoreExample/MulticoreProcessor/Core2/Task3','Period')  
  
p =  
  
0.2
```

Input Arguments

Object — Object whose parameter value to return

character vector

Object whose parameter value to return, specified as a character vector giving the object full path name. Possible objects are:

- Software node
- Hardware node
- Periodic trigger
- Aperiodic trigger
- Task

ParamName — Parameter whose value to return

character vector

Name of a parameter for which `Simulink.architecture.get_param` returns a value.

The following are the possible `ParamName` values:

For a model:

- 'ArchitectureName'
- 'Type'

For a software node:

- 'Name'
- 'Type'

For a hardware node

- 'Name'
- 'ClockFrequency'
- 'Color'
- 'Type'

For a periodic trigger:

- 'Name'
- 'Period'
- 'Color'
- 'Type'

For an aperiodic trigger:

- 'Name'
- 'Color'
- 'EventHandlerType'
- 'SignalNumber'
- 'EventName'
- 'Type'

For a task:

- 'Name'
- 'Period'
- 'Color'
- 'Type'

See Also

`Simulink.architecture.set_param` | `Simulink.architecture.add` |
`Simulink.architecture.delete` | `Simulink.architecture.find_system` |
`Simulink.architecture.importAndSelect` | `Simulink.architecture.profile` |
`Simulink.architecture.register`

Introduced in R2014a

Simulink.architecture.importAndSelect

Import and select target architecture for concurrent execution environment for model

Syntax

```
Simulink.architecture.importAndSelect(model,Architecture)
```

```
Simulink.architecture.importAndSelect(model,  
CustomArchitectureDescriptionFile)
```

Description

`Simulink.architecture.importAndSelect(model,Architecture)` imports and selects the built-in target architecture for the concurrent execution environment for the model.

Importing and selecting target architectures requires that the associated support packages or hardware is installed on your computer.

`Simulink.architecture.importAndSelect(model,CustomArchitectureDescriptionFile)` imports and selects the architecture from an XML-based architecture description file.

Importing and selecting target architectures requires that the associated support packages or hardware is installed on your computer.

Examples

Import and select a different architecture

Import and select the sample architecture to the model `slexMulticoreExample`.

```
slexMulticoreExample  
Simulink.architecture.importAndSelect('slexMulticoreExample','Sample Architecture')
```

Import and select a custom architecture

Import and select the custom architecture defined in the XML file `custom_arch.xml`. This example requires you to create a `custom_arch.xml` file first.

```
slexMulticoreExample  
Simulink.architecture.importAndSelect('slexMulticoreExample','custom_arch.xml')
```

Input Arguments

model — Model

character vector

Model to import architecture to, specified as a character vector.

Data Types: char

Architecture — Target architecture name

character vector

Target architecture name to import into the concurrent execution environment for the model. Possible target names are:

| Property | Description |
|------------------------------------|---|
| 'Multicore' | Single CPU with multiple cores |
| 'Sample Architecture' | Example architecture consisting of single CPU with multiple cores and two FPGAs. You can use this architecture to model for concurrent execution. |
| 'Simulink Real-Time' | Simulink Real-Time™ target |
| 'Xilinx Zynq ZC702 evaluation kit' | Xilinx® Zynq® ZC702 evaluation kit target |
| 'Xilinx Zynq ZC706 evaluation kit' | Xilinx Zynq ZC706 evaluation kit target |
| 'Xilinx Zynq Zedboard' | Xilinx Zynq ZedBoard™ target |

Data Types: char

CustomArchitectureDescriptionFile — Custom target architecture file

XML file

Custom target architecture file name, in XML format, that describes a custom target for the concurrent execution environment for the model, specified as a character vector giving the XML file name.

Example: `custom_arch.xml`

See Also

`Simulink.architecture.set_param` | `Simulink.architecture.add` |
`Simulink.architecture.delete` | `Simulink.architecture.find_system` |
`Simulink.architecture.profile` | `Simulink.architecture.register`

Topics

“Define a Custom Architecture File”

Introduced in R2014a

Simulink.architecture.profile

Generate profile report for model configured for concurrent execution

Syntax

```
Simulink.architecture.profile(model)
Simulink.architecture.profile(model,numSamples)
```

Description

`Simulink.architecture.profile(model)` generates a profile report for a model configured for concurrent execution. Subsequent calls to the command for the same model name overwrite the existing profile report.

`Simulink.architecture.profile(model,numSamples)` specifies the number of samples to generate a profile report.

Examples

Generate profile report

Generate profile report for the model `slexMulticoreExample`.

```
slexMulticoreExample;
Simulink.architecture.profile('slexMulticoreExample');
```

The command creates the file `slexMulticoreExample_ProfileReport.html` in the current folder and opens it.

Generate profile report for 120 time steps

Generate profile report for the model `slexMulticoreExample` with data for 120 time steps.

```
slexMulticoreExample;
Simulink.architecture.profile('slexMulticoreExample',120);
```

The command creates the file `slexMulticoreExample_ProfileReport.html` in the current folder.

Input Arguments

model — Model to profile

character vector

Model to profile, specified as a character vector. Specify a model that is configured for concurrent execution.

Data Types: char

numSamples — Number of time steps

100 (default) | real, positive integer

Number of time steps, specified as a real, positive integer. This value determines the number of steps to collect data for in the profiled model.

Data Types: single | double | int8 | int16 | int32 | int64 | uint8 | uint16 | uint32 | uint64

See Also

`Simulink.architecture.get_param` | `Simulink.architecture.set_param` |
`Simulink.architecture.add` | `Simulink.architecture.delete` |
`Simulink.architecture.find_system` | `Simulink.architecture.importAndSelect` |
`Simulink.architecture.register`

Topics

“Profile and Evaluate Explicitly Partitioned Models on a Desktop”

Introduced in R2014a

Simulink.architecture.register

Add custom target architecture to concurrent execution target architecture selector

Syntax

```
Simulink.architecture.register(CustomArchFile)
```

Description

`Simulink.architecture.register(CustomArchFile)` adds an XML-format custom target architecture file `CustomArchFile` to the concurrent execution target architecture selector. To access this selector, click the **Select** button on the Concurrent Execution pane of the Concurrent Execution dialog box.

Examples

Add custom target architecture

Add custom target architecture defined in the XML file `custom_arch.xml` to the concurrent execution target architecture selector. This example requires you to create a `custom_arch.xml` first.

```
slexMulticoreExample  
Simulink.architecture.register('custom_arch.xml')
```

Input Arguments

CustomArchFile — Custom target architecture file

XML file

Custom target architecture file that describes a custom target for concurrent execution, specified as an XML file.

See Also

`Simulink.architecture.set_param` | `Simulink.architecture.add` |
`Simulink.architecture.delete` | `Simulink.architecture.find_system` |
`Simulink.architecture.profile` | `Simulink.architecture.importAndSelect`

Introduced in R2014a

Simulink.architecture.set_param

Set architecture object properties

Syntax

```
Simulink.architecture.set_param(Object, ParamName, ParamValue)
```

Description

`Simulink.architecture.set_param(Object, ParamName, ParamValue)` sets the specified parameter of `Object` to the specified value. Parameter name and value character vectors are case sensitive.

Examples

Set software node name

Set the software node name from `MulticoreProcessor` to `MyCPUNewName`.

```
slexMulticoreExample
Simulink.architecture.set_param([bdroot '/MulticoreProcessor'], 'Name', 'MyCPUNewName');
```

Change Periodic

Set `Core2` trigger period to `.01`.

```
slexMulticoreExample
Simulink.architecture.set_param([bdroot '/MyCPUNewName/Core2'], 'Period', '.01')
```

Input Arguments

Object — Object whose parameter value to set

character vector

Object whose parameter value to set, specified as a character vector giving the object full path name. Possible objects are:

- Software node
- Hardware node
- Periodic trigger
- Aperiodic trigger
- Task

ParamName — Name of the parameter to set

character vector

Name of parameter whose value to set.

These are the possible parameters whose values you can set for each of the object types:

For software node:

- 'Name' — Name of the software node.

For hardware node:

- 'Name' — Name of the hardware node.
- 'ClockFrequency' — Frequency of the hardware node clock.
- 'Color' — Color of the trigger icon, specified as an RGB triplet (vector).

For a periodic trigger:

- 'Name' — Name of the trigger.
- 'Period' — Period of the trigger.
- 'Color' — Color of the trigger icon, specified as an RGB triplet (vector).

For an aperiodic trigger:

- 'Name' — Name of the trigger.
- 'Color' — Color of the trigger icon, specified as an RGB triplet (vector).
- 'EventHandlerType' — Trigger source for the interrupt-driven task. Possible values:
 - 'Event (Windows)'
 - 'Posix Signal (Linux/VxWorks 6.x)'
- 'SignalNumber' — Signal number for the trigger. You can set this value only if EventHandlerType is set to Event (Windows).
- 'EventName' — Event name for the trigger. You can set this value only if EventHandlerType is set to Posix Signal (Linux/VxWorks 6.x).

For task:

- 'Name' — Name of the task.
- 'Period' — Period of the task.
- 'Color' — Color of the task icon, specified as an RGB triplet (vector).

Data Types: char

ParamValue — Value to set the parameter to

character vector | vector

Value to set the parameter to, specified as a character vector, scalar, or vector. The possible values depend on the parameter.

Example: 'MyCPUNewName'

See Also

Simulink.architecture.get_param | Simulink.architecture.add |
 Simulink.architecture.delete | Simulink.architecture.find_system |
 Simulink.architecture.importAndSelect | Simulink.architecture.profile |
 Simulink.architecture.register

Introduced in R2014a

Simulink.Block.getSampleTimes

Return sample time information for a block

Syntax

```
ts = Simulink.Block.getSampleTimes(block)
```

Input Arguments

block

Full name or handle of a Simulink block

Output Arguments

ts

The command returns *ts* which is a 1xn array of Simulink.SampleTime objects associated with the model passed to Simulink.Block.getSampleTimes. Here *n* is the number of sample times associated with the block. The format of the returns is:

```
1xn Simulink.SampleTime
Package: Simulink
value: [1x2 double]
Description: [char string]
ColorRGBValue: [1x3 double]
Annotation: [char string]
OwnerBlock: [char string]
ComponentSampleTimes: [1x2 struct]
Methods
```

- *value* — A two-element array of doubles that contains the sample time period and offset
- *Description* — A character vector or string that describes the sample time type
- *ColorRGBValue* — A 1x3 array of doubles that contains the red, green and blue (RGB) values of the sample time color
- *Annotation* — A character vector or string that represents the annotation of a specific sample time (e.g., 'D1')
- *OwnerBlock* — For asynchronous and variable sample times, a character vector or string containing the full path to the block that controls the sample time. For all other types of sample times, an empty character vector or string.
- *ComponentSampleTimes* — A structure array of elements of the same type as Simulink.BlockDiagram.getSampleTimes if the sample time is an async union or if the sample time is hybrid and the component sample times are available.

Description

`ts = Simulink.Block.getSampleTimes(block)` performs an update diagram and then returns the sample times of the block connected to the input argument *mdl/signal*. This method performs an update diagram to ensure that the sample time information returned is up-to-date. If the model is already in the compiled state via a call to the model API, then an update diagram is not necessary.

Using this method allows you to access all information in the Sample Time Legend programmatically.

See Also

`Simulink.BlockDiagram.getSampleTimes`

Introduced in R2009a

Simulink.BlockDiagram.addBusToVector

Convert virtual bus signals into vector signals by adding Bus to Vector blocks

Syntax

```
[destBlocks, busToVectorBlocks, ignoredBlocks] =
Simulink.BlockDiagram.addBusToVector(model)
[destBlocks, busToVectorBlocks, ignoredBlocks] =
Simulink.BlockDiagram.addBusToVector(model, includeLibs)
[destBlocks, busToVectorBlocks, ignoredBlocks] =
Simulink.BlockDiagram.addBusToVector(model, includeLibs, reportOnly)
[destBlocks, busToVectorBlocks, ignoredBlocks] =
Simulink.BlockDiagram.addBusToVector(model, includeLibs, reportOnly, strictOnly)
```

Description

[destBlocks, busToVectorBlocks, ignoredBlocks] = Simulink.BlockDiagram.addBusToVector(model) searches a model, excluding any library blocks, for bus signals used implicitly as vectors, and returns the results of the search.

[destBlocks, busToVectorBlocks, ignoredBlocks] = Simulink.BlockDiagram.addBusToVector(model, includeLibs) searches a model, and if includeLibs is true, includes in the search library blocks for bus signals used implicitly as vectors.

[destBlocks, busToVectorBlocks, ignoredBlocks] = Simulink.BlockDiagram.addBusToVector(model, includeLibs, reportOnly) searches a model, and if reportOnly is set to false, then the function inserts a Bus to Vector block into each bus that is used as a vector in any block that it searches. The insertion replaces the implicit use of a bus as a vector with an explicit conversion of the bus to a vector. The source and destination blocks of the signal do not change.

If Simulink.BlockDiagram.addBusToVector adds Bus to Vector blocks to the model or any library, the function changes the saved copy of the diagram.

If Simulink.BlockDiagram.addBusToVector changes a library block, the change affects every instance of that block in every model that uses the library.

[destBlocks, busToVectorBlocks, ignoredBlocks] = Simulink.BlockDiagram.addBusToVector(model, includeLibs, reportOnly, strictOnly) searches a model, and if strictOnly is true, the function checks for input bus signals used implicitly as vectors that are fed into one of these blocks. These blocks cannot take virtual bus signals, but they can accept nonvirtual bus signals:

- Delay
- Selector
- Assignment
- Vector Concatenate
- Reshape

- Permute Dimensions

Examples

Identify Bus-To-Vector Conversions

Model `ex_bus_to_vector` simulates correctly, but the input to the Gain block is a bus, while the output is a vector. The Gain block implicitly converts the bus to a vector.

Open the model.

```
open_system(fullfile(matlabroot, 'examples', 'simulink', 'main', ...
    'ex_bus_to_vector'))
```

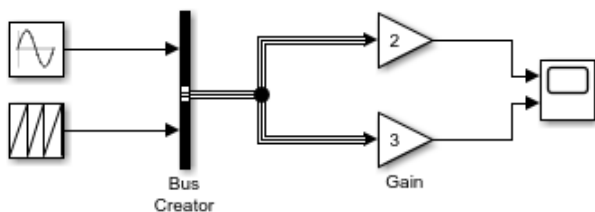

Identify buses treated as vectors.

```
[blocks] = Simulink.BlockDiagram.addBusToVector(...
    'ex_bus_to_vector')

### Processing block diagram 'ex_bus_to_vector'
### Number of blocks left that are connected to a bus being used as a vector: 2
### Done processing block diagram 'ex_bus_to_vector'

blocks =

    1x2 struct array with fields:

        BlockPath
        InputPort
        LibPath
```

To understand the relationship between `Simulink.BlockDiagram.addBusToVector` and the **Bus signal treated as vector** configuration parameter, see “Manage Bus-to-Vector Conversions” on page 12-6.

Add Bus to Vector Blocks

Model `ex_bus_to_vector` simulates correctly, but the input to the Gain block is a bus, while the output is a vector. The Gain block implicitly converts the bus to a vector.

Open the model.

```
open_system(fullfile(matlabroot, 'examples', 'simulink', 'main', ...
    'ex_bus_to_vector'))
```

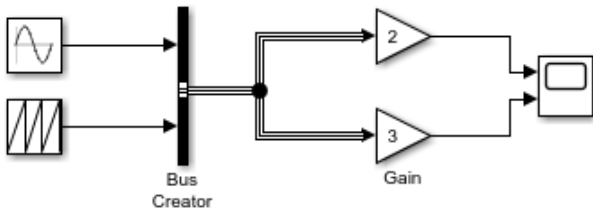

Insert Bus to Vector blocks.

When you use function `Simulink.BlockDiagram.addBusToVector` with `reportOnly` set to `false`, the function saves the model. To create a writable copy of model `ex_bus_to_vector`, this example uses the `save_system` function.

```
save_system('ex_bus_to_vector','ex_bus_to_vector_blocks');
[blocks,busToVectors] = Simulink.BlockDiagram.addBusToVector(...
'ex_bus_to_vector_blocks',true,false);
```

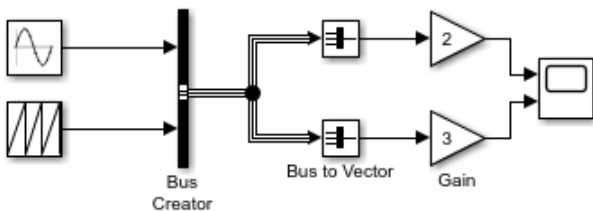

The Gain block no longer implicitly converts the bus to a vector. The inserted Bus to Vector block performs the conversion explicitly. The Bus to Vector block is virtual and does not affect simulation results, code generation, or performance.

To understand the relationship between `Simulink.BlockDiagram.addBusToVector` and the **Bus signal treated as vector** configuration parameter, see “Manage Bus-to-Vector Conversions” on page 12-6.

Input Arguments

model — Model name or handle

character vector | string scalar | numeric scalar

Model name or handle, specified as a character vector, string scalar, or numeric scalar.

Data Types: `double` | `char` | `string`

includeLibs — Search library blocks

`false` (default) | `true`

Search library blocks, specified as `false` or `true`.

- `false` — Search only the blocks in the model.
- `true` — Search library blocks for bus signals used implicitly as vectors.

Specify as the second argument.

Data Types: `logical`

reportOnly — Report results without changing model

`true` (default) | `false`

Choice to report results without changing the model, specified as `false` or `true`.

- `false` — Update the model by inserting Bus to Vector blocks for bus signals that are implicitly used as vectors.
- `true` — Report search results, but do not change the model.

Specify as the third argument. Also specify the `model` and `includeLibs` arguments.

Data Types: `logical`

strictOnly — Check input bus signals used implicitly as vectors that feed blocks that can accept nonvirtual, but not virtual, bus signals

`false` (default) | `true`

Check input bus signals used implicitly as vectors that feed blocks that can accept nonvirtual, but not virtual, bus signals, specified as `false` or `true`. If `strictOnly` is `true`, the function checks for input bus signals used implicitly as vectors that are fed into one of these blocks. These blocks cannot take virtual bus signals, but they can accept nonvirtual bus signals.

- Delay
- Selector
- Assignment
- Vector Concatenate
- Reshape
- Permute Dimensions

Specify as the fourth argument. You must also specify the `model`, `includeLibs`, and `reportOnly` arguments.

Data Types: `logical`

Output Arguments

destBlocks — Blocks connected to buses but that treat buses as vectors

array of structures

Blocks connected to buses that treat buses as vectors, returned as an array of structures. Each structure in the array contains these fields:

- `BlockPath` — Character vector specifying the path to the block to which the bus connects.
- `InputPort` — Integer specifying the input port to which the bus connects.
- `LibPath` — If the block is a library block instance, and if `includeLibs` is `true`, the field value is the path to the source library block. Otherwise, `LibPath` is empty (`[]`).

busToVectorBlocks — Bus to Vector blocks added by function

cell array

Bus to Vector blocks added by function, specified as a cell array. If `reportOnly` is set to `false`, the cell array contains the paths to each Bus to Vector block that the function added to replace buses used as vectors. Otherwise, `busToVectorBlocks` is empty (`[]`).

ignoredBlocks — Cases where function cannot insert Bus to Vector block

array of structures

Cases where function cannot insert Bus to Vector block, specified as an array of structures. Each structure in the array contains these fields:

- `BlockPath` — Character vector specifying the path to the block to which the bus connects.
- `InputPort` — Integer specifying the input port to which the bus connects.

These cases occur when a Bus to Vector cannot be inserted because the input virtual bus signal consists of elements with mixed attributes.

Tips

- Before you execute this function:
 - 1 Ensure that the model compiles without error.
 - 2 Save the model.
- Back up the model and any libraries before calling the function with `reportOnly` set to `false`.
- To preview the effects of the change on blocks in all models, call `Simulink.BlockDiagram.addBusToVector` with `includeLibs` set to `true` and `reportOnly` set to `true`. Then, examine the information returned in the `destBlocks` output argument.

See Also

Bus to Vector

Introduced in R2007a

Simulink.BlockDiagram.arrangeSystem

Improve layout of block diagram

Syntax

```
Simulink.BlockDiagram.arrangeSystem(bd)  
Simulink.BlockDiagram.arrangeSystem(bd,FullLayout=tf)
```

Description

`Simulink.BlockDiagram.arrangeSystem(bd)` improves the layout of the specified block diagram by realigning, resizing, and moving blocks and straightening signal lines.

`Simulink.BlockDiagram.arrangeSystem(bd,FullLayout=tf)` specifies whether to apply the automated layout even when the automated layout might not improve upon the original layout.

Examples

Arrange Programmatically Populated Model

You can use `Simulink.BlockDiagram.arrangeSystem` with any open model, and it is particularly useful with models you populate programmatically.

Blocks in the model `ex_arrange_system` are poorly arranged.

```
open_system('ex_arrange_system')
```

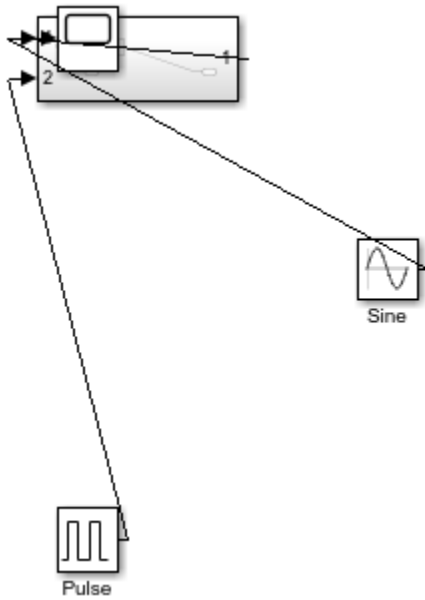

Blocks in its subsystem are also poorly arranged.

```
open_system('ex_arrange_system/Subsystem')
```

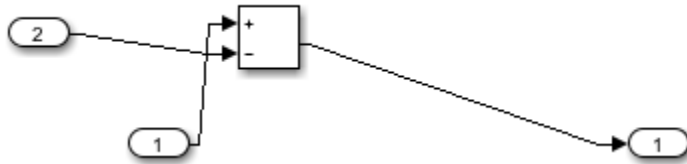

Programmatically arrange blocks in the top layer of the specified system.

```
Simulink.BlockDiagram.arrangeSystem('ex_arrange_system')
```

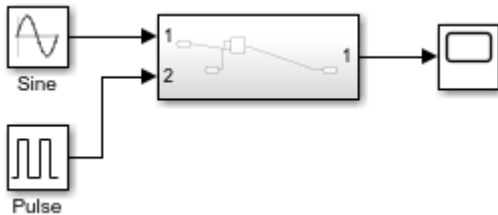

```
Simulink.BlockDiagram.arrangeSystem('ex_arrange_system/Subsystem')
```

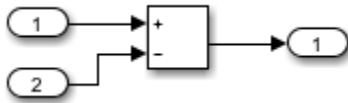

Force Automated Layout

By default, `Simulink.BlockDiagram.arrangeSystem` applies an automated layout only when the automated layout is expected to improve upon the original layout. You can force this function to apply the layout even when the automated layout might not improve upon the original layout.

Blocks in the model `ForceArrangeSystem` are arranged well.

```
open_system('ex_arrange_system2')
```

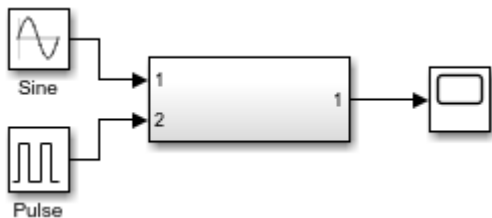

The automated layout might not improve upon the original layout because the blocks are already arranged well.

Suppose you want to apply the automated layout regardless of whether the automated layout is an improvement. To force the automated layout, set `FullLayout` to `true`.

```
Simulink.BlockDiagram.arrangeSystem('ex_arrange_system2',FullLayout='true')
```

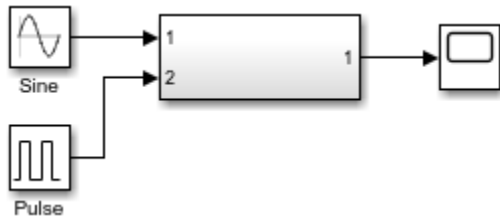

Input Arguments

bd — Block diagram of system

character vector | string scalar | numeric scalar

Block diagram of system, specified as a character vector, string scalar, or numeric scalar.

Specify one of the following options:

- System name (must not include a path or extension)
- System handle
- Subsystem block path

Data Types: double | char | string

tf — Option to force automated layout

'false' (default) | 'true'

Option to force automated layout, specified as 'true' or 'false'.

- 'true' — Applies the automated layout even when the automated layout might not improve upon the original layout
- 'false' — Applies the automated layout only when the automated layout is expected to improve upon the original layout.

See Also

add_block | add_line | Simulink.BlockDiagram.routeLine

Topics

“Programmatic Modeling Basics”

“Format a Model”

Introduced in R2018a

Simulink.BlockDiagram.buildRapidAcceleratorTarget

Build Rapid Accelerator target for model and return run-time parameter set

Syntax

```
rtp = Simulink.BlockDiagram.buildRapidAcceleratorTarget mdl)
```

Description

`rtp = Simulink.BlockDiagram.buildRapidAcceleratorTarget(mdl)` builds a Rapid Accelerator target for model, `mdl`, and returns run-time parameter set, `rtp`.

Input Arguments

`mdl`

Name or handle of a Simulink model

Output Arguments

`rtp`

Run-time parameter set that contains two elements:

| Element | Description | | | | | | | | | | | | | | | | | | | | |
|----------------------------|--|-------|-------------|---------------------------|--|-------------------------|--|----------------------|--|-------------------------|--|---------------------|--|------------------|---|--|---|-------|-------------|-------------------------|-------------------------|
| <code>modelChecksum</code> | 1x4 vector that encodes the structure of the model. | | | | | | | | | | | | | | | | | | | | |
| <code>parameters</code> | A structure of the tunable parameters in the model. This structure contains the following fields. | | | | | | | | | | | | | | | | | | | | |
| | <table border="1"> <thead> <tr> <th>Field</th> <th>Description</th> </tr> </thead> <tbody> <tr> <td><code>dataTypeName</code></td> <td>The data type name, for example, <code>double</code>.</td> </tr> <tr> <td><code>dataTypeId</code></td> <td>Internal data type identifier for use by Simulink Coder.</td> </tr> <tr> <td><code>complex</code></td> <td>Complex type or real type specification. Value is 0 if real, 1 if complex.</td> </tr> <tr> <td><code>dtTransIdx</code></td> <td>Internal data type identifier for use by Simulink Coder.</td> </tr> <tr> <td><code>values</code></td> <td>All values associated with this entry in the <code>parameters</code> substructure.</td> </tr> <tr> <td><code>map</code></td> <td>Mapping structure information that correlates the values to the model tunable parameters. This structure contains the following fields.</td> </tr> <tr> <td></td> <td> <table border="1"> <thead> <tr> <th>Field</th> <th>Description</th> </tr> </thead> <tbody> <tr> <td><code>Identifier</code></td> <td>Tunable parameter name.</td> </tr> </tbody> </table> </td> </tr> </tbody> </table> | Field | Description | <code>dataTypeName</code> | The data type name, for example, <code>double</code> . | <code>dataTypeId</code> | Internal data type identifier for use by Simulink Coder. | <code>complex</code> | Complex type or real type specification. Value is 0 if real, 1 if complex. | <code>dtTransIdx</code> | Internal data type identifier for use by Simulink Coder. | <code>values</code> | All values associated with this entry in the <code>parameters</code> substructure. | <code>map</code> | Mapping structure information that correlates the values to the model tunable parameters. This structure contains the following fields. | | <table border="1"> <thead> <tr> <th>Field</th> <th>Description</th> </tr> </thead> <tbody> <tr> <td><code>Identifier</code></td> <td>Tunable parameter name.</td> </tr> </tbody> </table> | Field | Description | <code>Identifier</code> | Tunable parameter name. |
| Field | Description | | | | | | | | | | | | | | | | | | | | |
| <code>dataTypeName</code> | The data type name, for example, <code>double</code> . | | | | | | | | | | | | | | | | | | | | |
| <code>dataTypeId</code> | Internal data type identifier for use by Simulink Coder. | | | | | | | | | | | | | | | | | | | | |
| <code>complex</code> | Complex type or real type specification. Value is 0 if real, 1 if complex. | | | | | | | | | | | | | | | | | | | | |
| <code>dtTransIdx</code> | Internal data type identifier for use by Simulink Coder. | | | | | | | | | | | | | | | | | | | | |
| <code>values</code> | All values associated with this entry in the <code>parameters</code> substructure. | | | | | | | | | | | | | | | | | | | | |
| <code>map</code> | Mapping structure information that correlates the values to the model tunable parameters. This structure contains the following fields. | | | | | | | | | | | | | | | | | | | | |
| | <table border="1"> <thead> <tr> <th>Field</th> <th>Description</th> </tr> </thead> <tbody> <tr> <td><code>Identifier</code></td> <td>Tunable parameter name.</td> </tr> </tbody> </table> | Field | Description | <code>Identifier</code> | Tunable parameter name. | | | | | | | | | | | | | | | | |
| Field | Description | | | | | | | | | | | | | | | | | | | | |
| <code>Identifier</code> | Tunable parameter name. | | | | | | | | | | | | | | | | | | | | |

| Element | Description | | |
|---------|-------------|--------------|---|
| | | ValueIndices | Start and end indices into the values field, [startIdx, endIdx]. |
| | | Dimensions | Dimension of this tunable parameter (matrices are generally stored in column-major format). |

Examples

Build Rapid Accelerator Target for Model

In the MATLAB Command Window, type:

```

rtp = Simulink.BlockDiagram.buildRapidAcceleratorTarget('f14')
### Building the rapid accelerator target for model: f14
### Successfully built the rapid accelerator target for model: f14

rtp =
    modelChecksum: [2.6812e+09 2.7198e+09 589261472 4.0180e+09]
    parameters: [1x1 struct]

```

See Also

Topics

“How Acceleration Modes Work”

“Choosing a Simulation Mode”

“Design Your Model for Effective Acceleration”

Introduced in R2012b

Simulink.BlockDiagram.copyContentsToSubsystem

Copy graphical contents from system to empty subsystem

Syntax

```
Simulink.BlockDiagram.copyContentsToSubsystem(sys, subsystem)
```

Description

`Simulink.BlockDiagram.copyContentsToSubsystem(sys, subsystem)` copies the blocks, lines, and annotations of the specified system to the specified subsystem. It does not affect nongraphical information such as configuration sets.

Use this function to convert a referenced model derived from an atomic subsystem into an atomic subsystem that is equivalent to the original subsystem.

To use this function:

- The specified system must be loaded in memory.
- The specified subsystem must be loaded in memory.
- The specified system must not contain the specified subsystem.
- The specified subsystem must not contain any blocks or lines. Other types of information can exist in the subsystem and are unaffected by the function. To delete the graphical content of the destination subsystem, use `Simulink.SubSystem.deleteContents`.

Examples

Copy Block Diagram of Model to Subsystem

Copy the contents of a referenced model to an empty subsystem.

Open the `sldemo_mdref_basic` model.

```
open_system('sldemo_mdref_basic')
```

Add an empty subsystem to the model.

```
add_block('built-in/Subsystem', 'sldemo_mdref_basic/Subsystem')
```

Load the `sldemo_mdref_counter` referenced model that contains the contents to copy.

```
load_system('sldemo_mdref_counter')
```

Copy the graphical contents from the `sldemo_mdref_counter` referenced model to the empty subsystem.

```
Simulink.BlockDiagram.copyContentsToSubsystem...  
( 'sldemo_mdref_counter', 'sldemo_mdref_basic/Subsystem' )
```

Input Arguments

sys — System name or handle

numeric scalar | character vector | string scalar

System name or handle, specified as a numeric scalar, character vector, or string scalar.

The system name must not include a path or extension.

Example: 'model1'

Data Types: double | char | string

subsys — Subsystem block path or handle

numeric scalar | character vector | string scalar

Subsystem block path or handle, specified as a numeric scalar, character vector, or string scalar.

Example: 'model2/Subsystem'

Data Types: double | char | string

See Also

Simulink.BlockDiagram.deleteContents |
Simulink.SubSystem.convertToModelReference |
Simulink.SubSystem.copyContentsToBlockDiagram |
Simulink.SubSystem.deleteContents

Topics

“Nonvirtual Blocks” on page 11-8

“Create Subsystems”

Introduced in R2007a

Simulink.BlockDiagram.createSubsystem

Create subsystem containing specified set of blocks

Syntax

```
Simulink.BlockDiagram.createSubsystem(blocks)
Simulink.BlockDiagram.createSubsystem()
Simulink.BlockDiagram.createSubsystem( ____,Name,Value)
```

Description

`Simulink.BlockDiagram.createSubsystem(blocks)` creates a subsystem and moves the specified blocks into it. All of the specified blocks must originally reside in the same block diagram.

If any of the blocks have unconnected ports, the function creates and connects Inport and Outport blocks to them inside the subsystem.

If any of the blocks are input or output port blocks, the function creates Inport and Outport blocks in the parent system to connect to the corresponding ports on the new Subsystem block.

`Simulink.BlockDiagram.createSubsystem()` replaces the currently selected blocks with a new subsystem that contains those blocks.

`Simulink.BlockDiagram.createSubsystem(____,Name,Value)` specifies options using one or more name-value pair arguments in addition to the input arguments in previous syntaxes. For example, 'Name', 'MySubsystem' names the new subsystem 'MySubsystem'.

Examples

Create Subsystem from Model

Open or load the example model.

```
CreateSubsystemModel
```

Get the block handles for all blocks at the top level of the model by using the `Simulink.findBlocks` function.

```
bh = Simulink.findBlocks('CreateSubsystemModel');
```

Replace the contents of the model with a subsystem that contains the model contents.

```
Simulink.BlockDiagram.createSubsystem(bh);
```

Create Named Subsystem from Model

Open or load the example model.

CreateSubsystemModel

Get the block handles for all blocks at the top level of the model by using the `Simulink.findBlocks` function.

```
bh = Simulink.findBlocks('CreateSubsystemModel');
```

Replace the contents of the model with a subsystem named `ss1` that contains the model contents.

```
Simulink.BlockDiagram.createSubsystem(bh, 'Name', 'ss1');
```

Input Arguments

blocks — Block handles

numeric array

Block handles, specified as a numeric array. To get block handles, use the `Simulink.findBlocks` or `gcbh` functions.

Data Types: `double`

Name-Value Pair Arguments

Specify optional comma-separated pairs of `Name`, `Value` arguments. `Name` is the argument name and `Value` is the corresponding value. `Name` must appear inside quotes. You can specify several name and value pair arguments in any order as `Name1, Value1, ..., NameN, ValueN`.

Example: `Simulink.BlockDiagram.createSubsystem(blocks, 'Name', 'MySubsystemName')`

Name — Name of new subsystem

character vector | string scalar

Name of the new subsystem, specified as the comma-separated pair consisting of `'Name'` and a character vector or string scalar.

Data Types: `char` | `string`

MakeNameUnique — Option to make subsystem name unique

`'on'` (default) | `'off'`

Option to make the subsystem name unique, specified as the comma-separated pair consisting of `'MakeNameUnique'` and `'on'` or `'off'`.

If the value that you specify for `Name` is already used in the diagram:

- `'on'` — Uses the next available increment of the name. For example, if `Name` is set to `'Controller'` and the diagram already contains a block named `'Controller'`, the function names the new subsystem `'Controller1'`.
- `'off'` — Returns an error.

Dependencies

To use this parameter, specify a value for the `Name` argument.

Data Types: `char` | `string`

See Also

[Simulink.BlockDiagram.copyContentsToSubsystem](#) |

[Simulink.BlockDiagram.deleteContents](#) |

[Simulink.SubSystem.convertToModelReference](#) |

[Simulink.SubSystem.copyContentsToBlockDiagram](#)

Topics

[“Create Subsystems”](#)

[“Simulink Models”](#) on page 11-6

Introduced in R2009a

Simulink.BlockDiagram.deleteContents

Delete graphical contents of system

Syntax

```
Simulink.BlockDiagram.deleteContents(sys)
```

Description

`Simulink.BlockDiagram.deleteContents(sys)` deletes the blocks, lines, and annotations in the specified system, which must be loaded in memory.

Examples

Delete Graphical Content from Model

Open the f14 model.

```
open_system('f14')
```

Delete the graphical content of the model, including all subsystems.

```
Simulink.BlockDiagram.deleteContents('f14')
```

Input Arguments

sys — System name or handle

character vector | string scalar | numeric scalar

System name or handle, specified as a character vector, string scalar, or numeric scalar.

A system name must not include a path or extension.

Example: 'mymodel'

Data Types: double | char | string

Tips

To delete the contents of a Subsystem block, use the `Simulink.SubSystem.deleteContents` function.

See Also

`Simulink.BlockDiagram.copyContentsToSubsystem` |
`Simulink.SubSystem.convertToModelReference` |
`Simulink.SubSystem.copyContentsToBlockDiagram` |
`Simulink.SubSystem.deleteContents`

Topics

“Modeling”

“Create Subsystems”

Introduced in R2007a

Simulink.BlockDiagram.getAlgebraicLoops

Show algebraic loops in a model

Syntax

```
Simulink.BlockDiagram.getAlgebraicLoops(model)
[loops,h] = Simulink.BlockDiagram.getAlgebraicLoops(model)
```

Description

`Simulink.BlockDiagram.getAlgebraicLoops(model)` returns a list of algebraic loops in a model as a vector of `AlgebraicLoops` objects.

The Algebraic Loops viewer provides a tabular list of all algebraic loops in the model. Use the Algebraic Loops viewer to control the display of algebraic loops in your model.

```
[loops,h] = Simulink.BlockDiagram.getAlgebraicLoops(model)
```

Examples

Highlight all algebraic loops in model

Open the `ex_sl_demo_hydcyl` model.

In the **Diagnostics** pane of Model Configuration Parameters, set **Algebraic loop** to none or warning. Setting this parameter to error prevents the model from compiling.

Compile the model without any errors. The model must compile before you can highlight any algebraic loops.

At the MATLAB command prompt, enter:

```
mdl = 'ex_sl_demo_hydcyl';
load_system(mdl);
Simulink.BlockDiagram.getAlgebraicLoops(bdroot)
```

AlgebraicLoop with properties:

```

        Model: [1x1 Simulink.BlockDiagram]
           Id: [0 1]
VariableBlockHandles: [198.0001 145.0001]
      BlockHandles: [9x1 double]
      IsArtificial: 0
```

The resulting output shows that the model has one algebraic loop, which contains three blocks.

Running the `getAlgebraicLoops` function also opens the Algebraic Loop viewer. Use the Algebraic loop viewer to highlight specific algebraic loops in your model or all the loops.

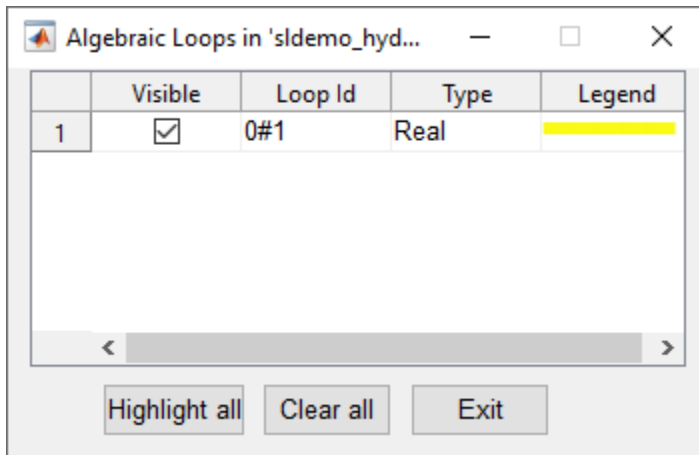

The selected loops are highlighted in the corresponding model, in.

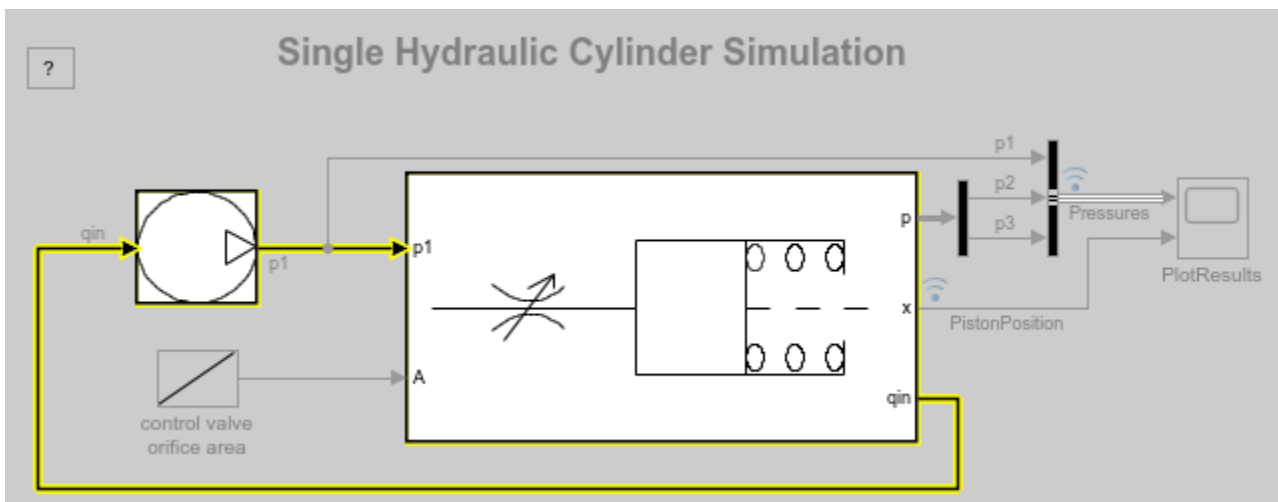

Input Arguments

model – Model to highlight

string scalar | character vector

Name of the model being tested, specified as a string scalar or character vector. You can also pass the most recently opened model using `bdroot`.

Note The model must be loaded into memory using either `open_system` or `load_system`.

Data Types: char | string

Output Arguments

Loops – Algebraic loops

vector of AlgebraicLoop objects

Every algebraic loop in the model returned as an `AlgebraicLoop` object that contains the following information:

- `Model`— `Simulink.BlockDiagram` object representing the model
- `Id`— Index of the algebraic loop in the model
- `VariableBlockHandles`: Handles to blocks that have been assigned algebraic variables
- `BlockHandles`—Handles to all the blocks contained in the algebraic loop
- `IsArtificial`— Boolean value indicating whether the loop is an artificial algebraic loop.

h — Handle to control UI

`matlab.ui.Figure` handle

The control UI is a MATLAB figure window. Use the UI's handle `h` to control it programmatically. For more information, see [Figure Properties](#).

See Also

`ashow`

Topics

“Identify Algebraic Loops in Your Model”

“Remove Algebraic Loops”

Introduced before R2006a

Simulink.BlockDiagram.expandSubsystem

Replace subsystem with subsystem contents

Syntax

```
Simulink.BlockDiagram.expandSubsystem(subsys)
Simulink.BlockDiagram.expandSubsystem(subsys, 'CreateArea', specifier)
```

Description

`Simulink.BlockDiagram.expandSubsystem(subsys)` replaces the specified subsystem with its contents in the block diagram that contains it. The file that contains the subsystem must be open or loaded.

You can expand virtual subsystems that are not masked, linked, or commented. For details, see “What Subsystems Can You Expand?”.

`Simulink.BlockDiagram.expandSubsystem(subsys, 'CreateArea', specifier)` provides the option of not creating an area around the expanded subsystem contents.

Examples

Expand Subsystem

Replace a subsystem with its contents.

Open the example model, which contains a subsystem that separates functionally related blocks.

```
open_system('SubsystemExpansionModel')
```

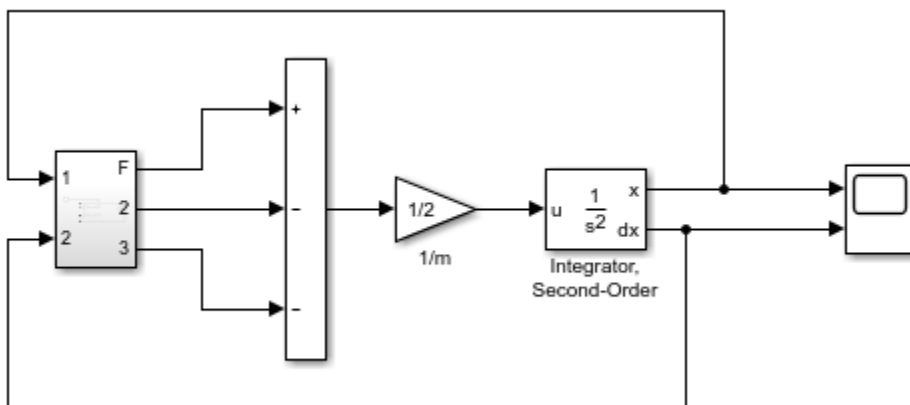

Expand the subsystem.

```
Simulink.BlockDiagram.expandSubsystem('SubsystemExpansionModel/Subsystem')
```

An area that contains the subsystem contents replaces the Subsystem block.

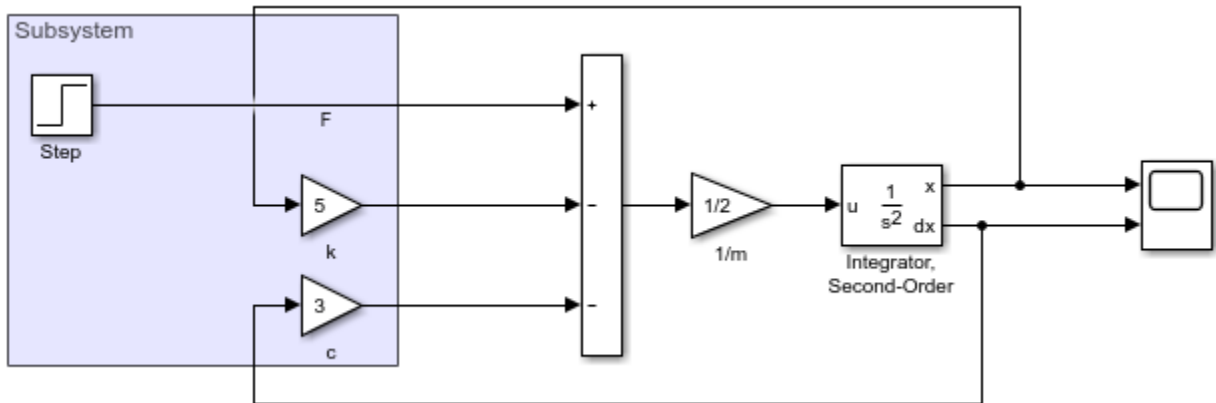

Expand Subsystem Without Creating Area

Replace a subsystem with its contents without creating an area that surround the contents.

Open the example model, which contains a subsystem that separates functionally related blocks.

```
open_system('SubsystemExpansionModel')
```

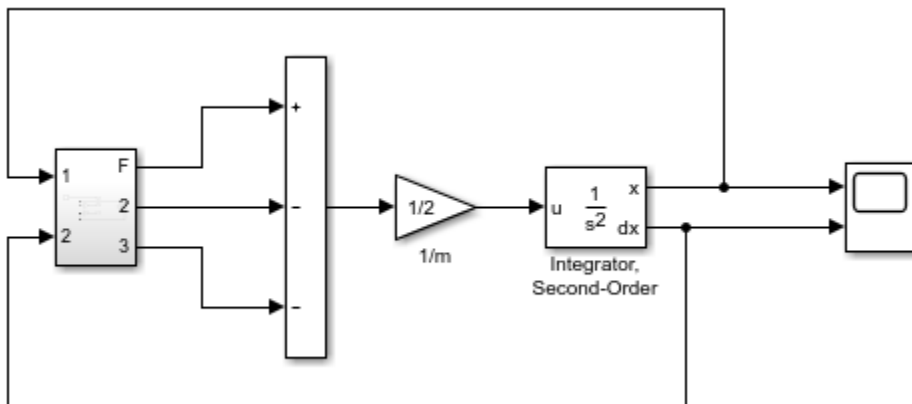

Expand the subsystem.

```
Simulink.BlockDiagram.expandSubsystem(...  
    'SubsystemExpansionModel/Subsystem', 'CreateArea', 'Off')
```

The subsystem contents replace the Subsystem block.

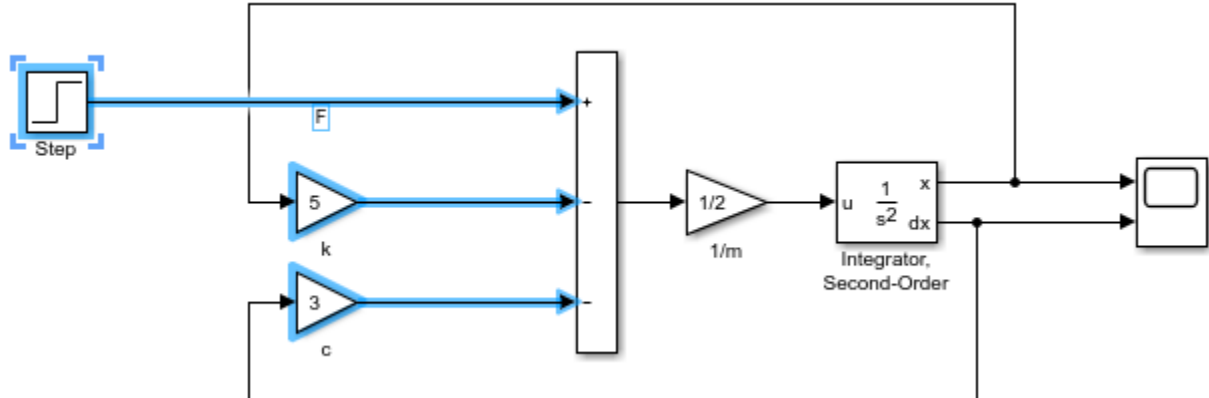

Input Arguments

subsys — Subsystem block path or handle

character vector | string scalar | numeric scalar

Subsystem block path or handle, specified as a character vector, string scalar, or numeric scalar.

Data Types: double | char | string

specifier — Option to create area around contents

'on' (default) | 'off'

Option to create area around contents, specified as 'on' to create the area or 'off' to not create the area.

Data Types: char | string

See Also

Simulink.BlockDiagram.copyContentsToSubsystem |
 Simulink.BlockDiagram.createSubsystem | Simulink.BlockDiagram.deleteContents |
 Simulink.SubSystem.convertToModelReference |
 Simulink.SubSystem.copyContentsToBlockDiagram

Topics

“Expand Subsystem Contents”

“Nonvirtual Blocks” on page 11-8

Introduced in R2014a

Simulink.BlockDiagram.getChecksum

Return checksum of model

Syntax

```
[checksum,details] = Simulink.BlockDiagram.getChecksum('model')
```

Description

[*checksum,details*] = Simulink.BlockDiagram.getChecksum('model') returns the checksum of the specified model. Simulink software computes the checksum based on attributes of the model and the blocks the model contains.

One use of this command is to determine why the Accelerator mode in Simulink software regenerates code. For an example, see `slAccelDemoWhyRebuild`.

Note Simulink.BlockDiagram.getChecksum compiles the specified model, if the model is not already in a compiled state.

This command accepts the argument *model*, which is the full name or handle of the model for which you are returning checksum data.

This command returns the following output:

- *checksum* — Array of four 32-bit integers that represents the model's 128-bit checksum.
- *details* — Structure of the form

```
ContentsChecksum: [1x1 struct]
InterfaceChecksum: [1x1 struct]
ContentsChecksumItems: [nx1 struct]
InterfaceChecksumItems: [mx1 struct]
```

- **ContentsChecksum** — Structure of the following form that represents a checksum that provides information about all blocks in the model.

```
Value: [4x1 uint32]
MarkedUnique: [bool]
```

- **Value** — Array of four 32-bit integers that represents the model's 128-bit checksum.
- **MarkedUnique** — True if any blocks in the model have a property that prevents code reuse.
- **InterfaceChecksum** — Structure of the following form that represents a checksum that provides information about the model.

```
Value: [4x1 uint32]
MarkedUnique: [bool]
```

- **Value** — Array of four 32-bit integers that represents the model's 128-bit checksum.
- **MarkedUnique** — Always true. Present for consistency with **ContentsChecksum** structure.

- `ContentsChecksumItems` and `InterfaceChecksumItems` — Structure arrays of the following form that contain information that Simulink software uses to compute the checksum for `ContentsChecksum` and `InterfaceChecksum`, respectively:

Handle: [char array]
 Identifier: [char array]
 Value: [type]

- `Handle` — Object for which Simulink software added an item to the checksum. For a block, the handle is a full block path. For a block port, the handle is the full block path and a character vector that identifies the port.
- `Identifier` — Descriptor of the item Simulink software added to the checksum. If the item is a documented parameter, the identifier is the parameter name.
- `Value` — Value of the item Simulink software added to the checksum. If the item is a parameter, `Value` is the value returned by

`get_param(handle, identifier)`

`Simulink.BlockDiagram.getChecksum` returns a checksum that depends on why and how you compiled the model. This function also compiles the model if it is not in a compiled state. The model compiles for:

- Simulation— if the simulation mode is Accelerator or you have not installed Simulink Coder
- Code generation— in all other cases

To compile the model before calling `Simulink.BlockDiagram.getChecksum`, use this command:

```
modelName([], [], [], 'compile')
```

Note The checksum that `Simulink.BlockDiagram.getChecksum` returns can vary from the checksum returned if you first compile the model at the command line (using the `model` command) before running `Simulink.BlockDiagram.getChecksum`.

Tip

The structural checksum reflects changes to the model that can affect the simulation results, including:

- Changing the solver type, for example from `Variable-step` to `Fixed-step`
- Adding or deleting blocks or connections between blocks
- Changing the values of nontunable block parameters, for example, the **Seed** parameter of the Random Number block
- Changing the number of inputs or outputs of blocks, even if the connectivity is vectorized
- Changing the number of states or the initial states in the model
- Selecting a different function in the Trigonometric Function block
- Changing signs used in a Sum block
- Adding a Target Language Compiler (TLC) file to inline an S-function

Examples of model changes that do not affect the structural checksum include:

- Changing the position of a block
- Changing the position of a line
- Resizing a block
- Adding, removing, or changing a model annotation

See Also

`Simulink.SubSystem.getChecksum` | `Simulink.getFileChecksum`

Introduced in R2006b

Simulink.BlockDiagram.getInitialState

Return initial state data of block diagram

Syntax

```
x0 = Simulink.BlockDiagram.getInitialState('model')
```

Description

`x0 = Simulink.BlockDiagram.getInitialState('model')` returns the initial state data of the block diagram specified by the input argument *model*. You can use this initial state data as the initial state for simulating a model or to provide an initial state condition to the linearization commands. To specify the initial state for a simulation, use the `LoadInitialState` model argument or the **Data Import/Export > Initial state** configuration parameter.

To specify the format for the initial state data, use the `SaveFormat` model argument. The default format is 'Dataset'. Other formats 'Array', 'Structure', and 'StructureWithTime'. Alternatively, you can set the initial state format using the **Data Import/Export > Format** configuration parameter.

- If format is 'Dataset', then the `Simulink.BlockDiagram.getInitialState` function returns a `Simulink.SimulationData.Dataset` object.
- For other format settings, the function returns a structure of the form:

```
time: 0
signals: [1xn struct]
```

where *n* is the number of states contained in the model, including any models referenced by Model blocks. The `signals` field is a structure of the form:

```
values: [1xm double]
dimensions: [1x1 double]
label: [char array]
blockName: [char array]
inReferencedModel: [bool]
sampleTime: [1x2 double]
```

- `values` — Numeric array of length *m*, where *m* is the number of states in the signal
- `dimensions` — Length of the `values` vector
- `label` — Indication of whether the state is continuous (CSTATE) or discrete. If the state is discrete:

The name of the discrete state is shown for S-function blocks.

The name of the discrete state is shown for those built-in blocks that assign their own names to discrete states.

DSTATE is used in all other cases.

- `blockName` — Full path to block associated with this state

- `inReferencedModel` — Indication of whether the state originates in a model referenced by a Model block (1) or in the top model (0)
- `sampleTime` — Array containing the sample time and offset of the block that owns the state

Using this function to return the initial state data simplifies specifying initial state values for models with multiple states. Each state is associated with the full path to its parent block.

See Also

`linmod`

Topics

“Initial state”

“Format”

Introduced in R2006b

Simulink.BlockDiagram.getSampleTimes

Return all sample times associated with model

Syntax

```
ts = Simulink.BlockDiagram.getSampleTimes('model')
```

Description

`ts = Simulink.BlockDiagram.getSampleTimes('model')` performs an update diagram and then returns the sample times associated with the block diagram *model*. The update diagram ensures that the sample time information returned is up to date. If the model is already in the compiled state via a call to the model API, then an update diagram is not necessary.

Using this method allows you to access all information in the Sample Time Legend programmatically.

Input Arguments

model

Name or handle of a Simulink model

Output Arguments

ts

The command returns a $1 \times n$ array of `Simulink.SampleTime` objects associated with the model passed to `Simulink.BlockDiagram.getSampleTimes`. Here n is the number of sample times associated with the block diagram. The format of the returns is as follows:

```
1xn Simulink.SampleTime
Package: Simulink
value: [1x2 double]
Description: [char string]
ColorRGBValue: [1x3 double]
Annotation: [char string]
OwnerBlock: [char string]
ComponentSampleTimes: [1x2 struct]
Methods
```

- **value** — A two-element array of doubles that contains the sample time period and offset.
- **Description** — A character vector or string that describes the sample time type.
- **ColorRGBValue** — A 1×3 array of doubles that contains the red, green, and blue (RGB) values of the sample time color.
- **Annotation** — A character vector or string that represents the annotation of a specific sample time (e.g., 'D1').
- **OwnerBlock** — For asynchronous and variable sample times, a character vector or string containing the full path to the block that controls the sample time. For all other types of sample times, an empty character vector or string.

- `ComponentSampleTimes` — A structure array of elements of the same type as `Simulink.BlockDiagram.getSampleTimes` if the sample time is an async union or if the sample time is hybrid and the component sample times are available.

See Also

`Simulink.Block.getSampleTimes`

Introduced in R2009a

Simulink.BlockDiagram.propagateConfigSet

Propagate top model configuration reference to referenced models

Syntax

```
[isPropagated, convertedModels] = Simulink.BlockDiagram.propagateConfigSet(model)
[isPropagated, convertedModels] = Simulink.BlockDiagram.propagateConfigSet(model, 'include', refModels)
[isPropagated, convertedModels] = Simulink.BlockDiagram.propagateConfigSet(model, 'exclude', refModels)
handle = Simulink.BlockDiagram.propagateConfigSet(model, 'gui')
```

Description

`[isPropagated, convertedModels] = Simulink.BlockDiagram.propagateConfigSet(model)` propagates the configuration reference for `model` to all referenced models. Execute the function from a writable folder.

`[isPropagated, convertedModels] = Simulink.BlockDiagram.propagateConfigSet(model, 'include', refModels)` propagates the configuration reference for `model` to the models in the `refModels` list. Execute the function from a writable folder.

`[isPropagated, convertedModels] = Simulink.BlockDiagram.propagateConfigSet(model, 'exclude', refModels)` propagates the configuration reference for `model` to all referenced models in the hierarchy except for the models in the `refModels` list. Execute the function from a writable folder.

`handle = Simulink.BlockDiagram.propagateConfigSet(model, 'gui')` opens the **Configuration Reference Propagation to Referenced Models** dialog box.

Examples

Propagate a Configuration Reference to All Referenced Models

```
[isPropagated, convertedModels] = ...
Simulink.BlockDiagram.propagateConfigSet('sldemo_mdref_depgraph')
```

Propagate a Configuration Reference to Listed Referenced Models

```
[isPropagated, convertedModels] = ...
Simulink.BlockDiagram.propagateConfigSet(...
'sldemo_mdref_depgraph', 'include', ...
{'sldemo_mdref_heater', 'sldemo_mdref_house'})
```

Propagate a Configuration Reference to Referenced Models with Exclusions

```
[isPropagated,convertedModels] = ...  
Simulink.BlockDiagram.propagateConfigSet(...  
'sldemo_mdhref_depgraph','exclude',...  
{'sldemo_mdhref_heater','sldemo_mdhref_house'})
```

Open the Configuration Reference Propagation to Referenced Models Dialog Box for a Model

```
Simulink.BlockDiagram.propagateConfigSet(...  
'sldemo_mdhref_depgraph','gui')
```

Input Arguments

model — Top model

character vector | string scalar

Top model with configuration reference to propagate, specified as a character vector or string scalar.

Example: 'mdl'

refModels — Referenced models

cell array of character vectors | string array

List of referenced models to be included or excluded in propagation, specified as a cell array of character vectors or string array.

Example: {'mdl1','mdl2','mdl3'}

Output Arguments

isPropagated — Success of propagation

false (default) | true

Indication of whether configuration reference propagation is successful, specified as a Boolean.

convertedModels — Converted models

cell array of character vectors

List of converted model names, specified as a cell array of character vectors.

handle — Handle to dialog box

handle

Handle to the **Configuration Reference Propagation to Referenced Models** dialog box. Returned when you specify the 'gui' argument to the function.

See Also

Simulink.BlockDiagram.restoreConfigSet

Topics

"Share a Configuration Across Referenced Models"

“Share a Configuration with Multiple Models”

Introduced in R2012b

Simulink.BlockDiagram.restoreConfigSet

Restore model configuration for converted models

Syntax

```
[isRestored, restoredModels] = Simulink.BlockDiagram.restoreConfigSet(model)
```

Description

`[isRestored, restoredModels] = Simulink.BlockDiagram.restoreConfigSet(model)` restores the model configuration for all converted models after propagating a configuration reference from a top model to the referenced models. Execute the function from a writable folder.

Examples

Restore the Model Configuration for Converted Models

```
[isRestored, restoredModels] = ...  
Simulink.BlockDiagram.restoreConfigSet('sldemo_mdIref_depgraph');
```

Input Arguments

model — Top model

character vector | string scalar

Name of top model, specified as a character vector or string scalar.

Example: 'mdl'

Output Arguments

isRestored — Success of restoration

false (default) | true

Indication of whether configuration reference propagation is successful, specified as a Boolean.

restoredModels — Restored models

cell array of character vectors

List of restored model names, specified as a cell array of character vectors.

See Also

`Simulink.BlockDiagram.propagateConfigSet`

Topics

“Share a Configuration Across Referenced Models”

“Share a Configuration with Multiple Models”

Introduced in R2012b

Simulink.BlockDiagram.loadActiveConfigSet

Package: Simulink.BlockDiagram

Load, associate, and activate configuration set with model

Syntax

```
Simulink.BlockDiagram.loadActiveConfigSet(model, file)
```

Description

`Simulink.BlockDiagram.loadActiveConfigSet(model, file)` loads a configuration set, attaches it to a model, and makes it the active configuration set for the model.

Examples

Load and Activate a Configuration Set

Load a saved configuration set to a model and activate it.

Open the model `sldemo_fuelsys` and save the active configuration set to a file.

```
sldemo_fuelsys  
Simulink.BlockDiagram.saveActiveConfigSet('sldemo_fuelsys', 'fuelsys_config_set.m')
```

Open the `vdp` model. Load the saved configuration set to `vdp` and activate it.

```
vdp  
Simulink.BlockDiagram.loadActiveConfigSet('vdp', 'fuelsys_config_set.m')
```

Input Arguments

model — Target model

character vector | string scalar

Name or handle of the target model for which you want to use the configuration set, specified as a character vector or string scalar.

Example: `'my_model'`

file — Name of file

character vector | string scalar

Name of the file that contains the configuration set, specified as a character vector or string scalar.

Example: `'configset.m'`

Tips

- If you load a configuration set with the same name as the active configuration set, Simulink overwrites the active configuration set.

- If you load a configuration set with the same name as an inactive configuration set associated with the model, Simulink detaches the inactive configuration from the model.
- If you load a configuration set object that contains an invalid custom target, Simulink sets the “System target file” (Simulink Coder) parameter to `ert.tlc`.

See Also

`Simulink.BlockDiagram.saveActiveConfigSet` | `Simulink.ConfigSet` | `attachConfigSet`
| `setActiveConfigSet`

Topics

“Load a Saved Configuration Set”

Introduced in R2010b

Simulink.BlockDiagram.saveActiveConfigSet

Package: Simulink.BlockDiagram

Save active configuration set of model

Syntax

```
Simulink.BlockDiagram.saveActiveConfigSet(model, file)
```

Description

`Simulink.BlockDiagram.saveActiveConfigSet(model, file)` saves the active configuration set of a model to an `.m` file or MAT-file.

Examples

Save a Configuration Set

Save the configuration set from the `sldemo_fuelsys` model as a `ConfigSet` object in the file `my_config_set.mat`.

Open the model.

```
sldemo_fuelsys
```

Save the active configuration set.

```
Simulink.BlockDiagram.saveActiveConfigSet('sldemo_fuelsys', 'my_config_set.mat')
```

Input Arguments

model — Model using configuration set

character vector | string scalar

Name or handle of the model that uses the configuration set that you want to save, specified as a character vector or string scalar.

Example: `'my_model'`

file — Name of file

character vector | string scalar

Name of the file to save the configuration set, specified as a character vector or string scalar. If you specify an `.m` extension, the file contains a function that creates a configuration set object. If you specify a `.mat` extension, the file contains a configuration set object. If you do not provide a file extension, the active configuration set is saved to a file with a `.m` extension. Do not specify `filename` to be the same as a model name; otherwise, the software cannot determine which file contains the configuration set object when loading the file.

Note If you specify a `.mat` extension when you save the active configuration set, all of the parameters are preserved. If you specify a `.m` extension, the `.m` file does not include hidden or disabled parameters.

Example: `'configset.m'`

See Also

[Simulink.BlockDiagram.loadActiveConfigSet](#) | [Simulink.ConfigSet](#)

Topics

“Save a Configuration Set”

Introduced in R2010b

Simulink.BlockDiagram.routeLine

Route existing lines of model

Syntax

```
Simulink.BlockDiagram.routeLine(lines)  
Simulink.BlockDiagram.routeLine('DeferredLines')
```

Description

`Simulink.BlockDiagram.routeLine(lines)` takes an array of existing line handles as input and routes the corresponding lines. Routing existing lines improves line route quality and avoids overlaps with other lines and obstacles in the model.

To find the line handles in the model you want to route, use the `find_system` or `get_param` function.

`Simulink.BlockDiagram.routeLine('DeferredLines')` performs all line updates that the `LineUpdate` model parameter defers while a script runs. For this command to route lines, all of these conditions must apply:

- The `LineUpdate` model parameter is set to 'deferred'.
- The script that contains this command affects line routing before using this command.
- If the script saves models, the script affects line routing after using the `save_system` function and before using this command.

Examples

Route Existing Lines of Model

Route existing lines of a model that overlap with other lines and blocks in the model.

Open the model `ex_route_lines`.

```
open_system('ex_route_lines');
```

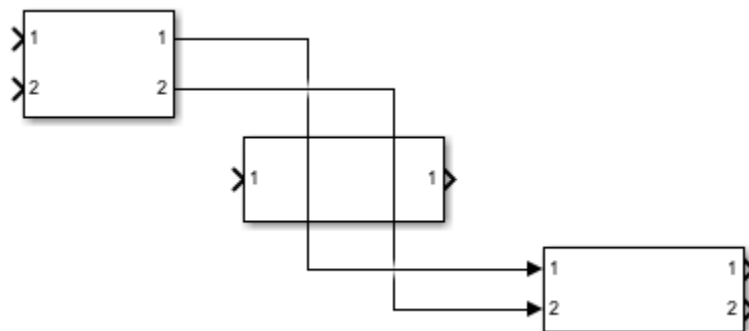

The two lines in the top-level system overlap with each other and with a block. To route these lines, create an array of line handles by using `find_system`. Then, call `Simulink.BlockDiagram.routeLine` with this array as input.

```
lineHandles = find_system(gcs,'FindAll','On','SearchDepth',1,'Type','Line');
Simulink.BlockDiagram.routeLine(lineHandles);
```

The updated model has no overlaps.

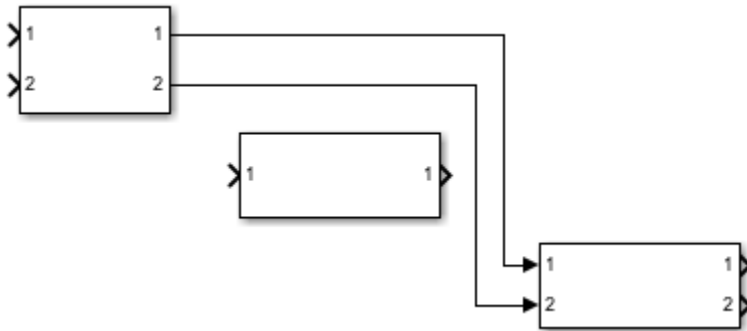

Route Lines Affected by Script

When the `LineUpdate` model parameter is set to `'deferred'`, scripts postpone line routing until they pause, complete, or run the `Simulink.BlockDiagram.routeLine('DeferredLines')` command.

Model `ex_route_deferred_lines` contains virtual subsystems with numerous signal lines connecting them.

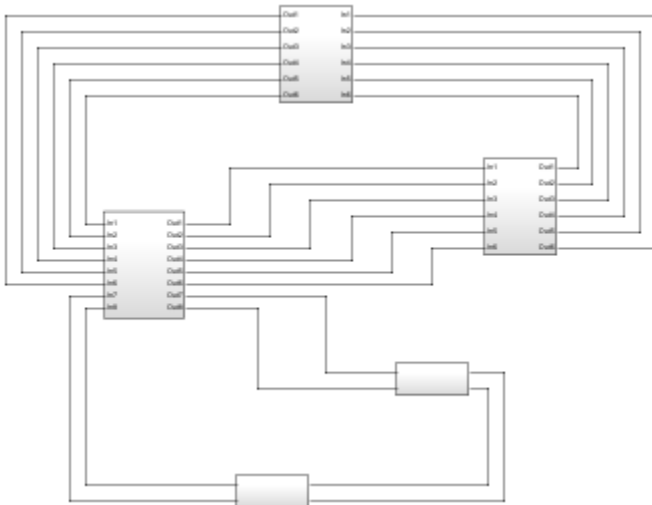

To see how the `Simulink.BlockDiagram.routeline('DeferredLines')` command works with the `LineUpdate` model parameter, set this parameter to `'deferred'`.

```
set_param(0,'LineUpdate','deferred');
```

Capture Image Before Routing Deferred Lines

Run a MATLAB® script that loads the model, moves blocks within the model, and saves an image of the model.

```
load_system('ex_route_deferred_lines');
set_param([gcs '/Subsystem2'],'Position',[765 -370 855 -330]);
set_param([gcs '/Subsystem3'],'Position',[300 215 390 335]);
set_param([gcs '/Subsystem4'],'Position',[270 -135 360 -95]);
print('-s','deferred_lines_unrouted','-dpng');
```

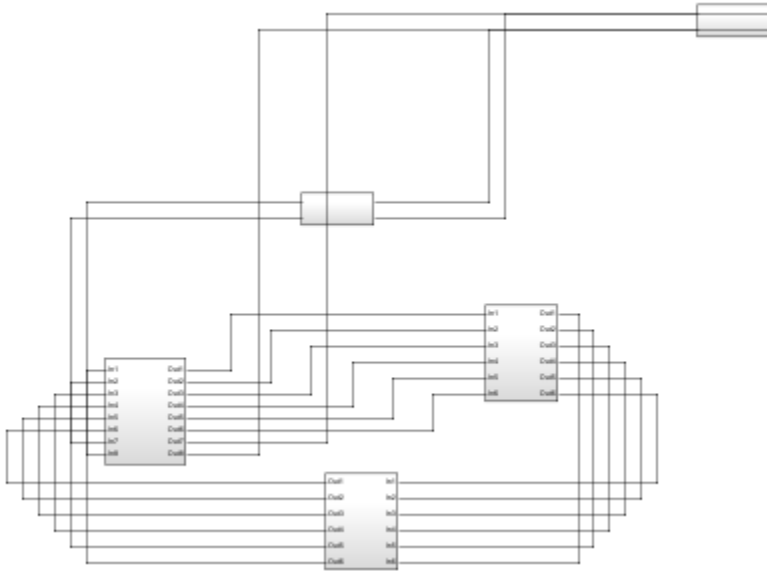

Because the script saves an image of the model before the deferred lines are routed, lines overlap other lines and obstacles in the model.

Capture Image After Routing Deferred Lines

Run a MATLAB script that loads the original model, moves blocks within the model, updates affected line routing, and saves an image of the model.

```
load_system('ex_route_deferred_lines');
set_param([gcs '/Subsystem2'],'Position',[765 -370 855 -330]);
set_param([gcs '/Subsystem3'],'Position',[300 215 390 335]);
set_param([gcs '/Subsystem4'],'Position',[270 -135 360 -95]);
Simulink.BlockDiagram.routeLine('DeferredLines');
print('-s','deferred_lines_routed','-dpng');
```

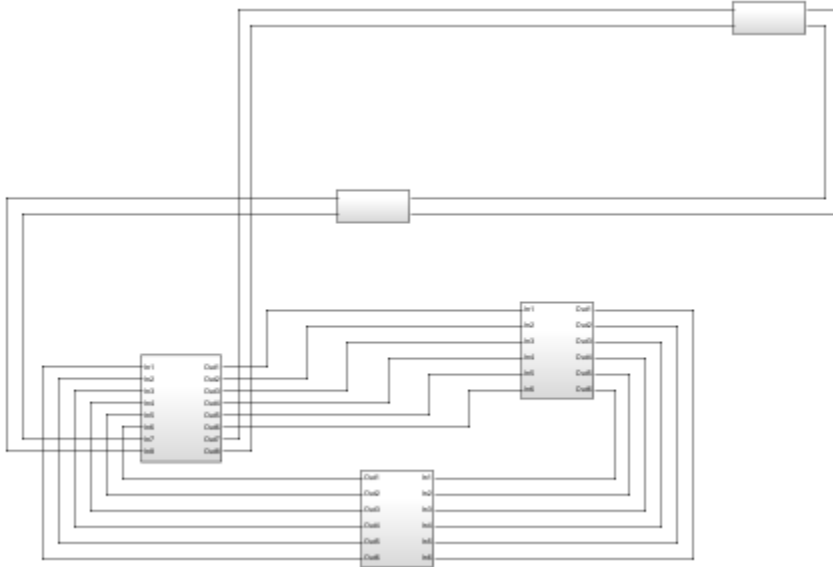

Adding command `Simulink.BlockDiagram.routeLine('DeferredLines')` before the print function improves line routing in the saved image.

Input Arguments

Lines — Handles of lines to route

numeric array

Handles of lines to route, specified as a numeric array. To find the line handles in your model, use the `find_system` or `get_param` function.

Data Types: double

Limitations

- Line routing can require additional empty space on the Simulink canvas. If the canvas does not have the required empty space, using `Simulink.BlockDiagram.routeLine` might not improve line route quality.
- For large models with many lines to route, `Simulink.BlockDiagram.routeLine` can take several minutes to execute.

See Also

`Simulink.BlockDiagram.arrangeSystem` | `find_system` | `get_param`

Topics

“Programmatic Modeling Basics”

“Format a Model”

Introduced in R2019a

convertToCell

Package: Simulink

Convert block path to cell array of character vectors

Syntax

```
cellarray = convertToCell(bp)
```

Description

`cellarray = convertToCell(bp)` converts a block path to a cell array of character vectors.

Examples

Create Cell Array that Represents Block Path

Open the example model, which references multiple models.

```
sldemo_mdhref_depgraph
```

Create a `Simulink.BlockPath` object.

```
bp = Simulink.BlockPath({'sldemo_mdhref_depgraph/thermostat', ...  
'sldemo_mdhref_heater/Fahrenheit to Celsius', ...  
'sldemo_mdhref_F2C/Gain1'});
```

Create a cell array that represents the elements of the block path.

```
cellarray = convertToCell(bp)
```

```
cellarray =
```

```
3x1 cell array
```

```
    {'sldemo_mdhref_depgraph/thermostat'      }  
    {'sldemo_mdhref_heater/Fahrenheit to Celsius'}  
    {'sldemo_mdhref_F2C/Gain1'                }
```

Input Arguments

bp — Fully specified block path

`Simulink.BlockPath` object

Fully specified block path, specified as a `Simulink.BlockPath` object. This block path uniquely identifies a block within a model hierarchy, even when the model hierarchy references the same model multiple times.

Output Arguments

cellarray — Block path elements

cell array of character vectors

Block path elements, returned as a cell array of character vectors.

See Also

Objects

Simulink.BlockPath

Functions

getBlock | getLength | open | validate

Introduced in R2010b

getBlock

Package: Simulink

Get single block path in model reference hierarchy

Syntax

```
block = getBlock(bp,index)
```

Description

`block = getBlock(bp,index)` returns the block path of the block at the level of the model reference hierarchy specified by the `index` argument.

Examples

Get Block Path for Specified Model Hierarchy Level

Open the example model, which references multiple models.

```
sldemo_mdhref_depgraph
```

Create a `Simulink.BlockPath` object.

```
bp = Simulink.BlockPath({'sldemo_mdhref_depgraph/thermostat', ...  
'sldemo_mdhref_heater/Fahrenheit to Celsius', ...  
'sldemo_mdhref_F2C/Gain1'});
```

Get the block for the second level in the model reference hierarchy.

```
blockpath = getBlock(bp,2)
```

```
blockpath =
```

```
    'sldemo_mdhref_heater/Fahrenheit to Celsius'
```

Get the block for the third level in the model reference hierarchy.

```
blockpath = getBlock(bp,3)
```

```
blockpath =
```

```
    'sldemo_mdhref_F2C/Gain1'
```

Input Arguments

bp — Fully specified block path

`Simulink.BlockPath` object

Fully specified block path, specified as a `Simulink.BlockPath` object. This block path uniquely identifies a block within a model hierarchy, even when the model hierarchy references the same model multiple times.

index — Index of block

integer

Index of the block for which you want to get the block path, specified as an integer. The index reflects the level in the model reference hierarchy. For example:

- An index of 1 represents a block in the top model.
- An index of 2 represents a block in the model that is referenced by the Model block of index 1.
- An index of n represents a block in the model that is referenced by the Model block of index n - 1.

Data Types: `single` | `double` | `int8` | `int16` | `int32` | `int64` | `uint8` | `uint16` | `uint32` | `uint64`

Output Arguments**block — Block path of block**

character vector

Block path of the block at the level of the model reference hierarchy specified by the `index` argument, returned as a character vector.

See Also**Objects**

`Simulink.BlockPath`

Functions

`convertToCell` | `getLength` | `open` | `validate`

Introduced in R2010b

getLength

Package: Simulink

Get number of hierarchy levels in block path

Syntax

```
length = getLength(bp)
```

Description

`length = getLength(bp)` returns a numeric value that corresponds to the number of levels in the model reference hierarchy for the block path.

Examples

Get Number of Hierarchy Levels in Block Path

Create a `Simulink.BlockPath` object that represents a referenced model within a model hierarchy.

```
load_system('sldemo_mdhref_depgraph')  
bp = Simulink.BlockPath({'sldemo_mdhref_depgraph/thermostat', ...  
    'sldemo_mdhref_heater/Fahrenheit to Celsius'});
```

Get the number of hierarchy levels in the block path for the `Simulink.BlockPath` object.

```
length = getLength(bp)
```

```
length =
```

```
    2
```

Input Arguments

bp — Fully specified block path

`Simulink.BlockPath` object

Fully specified block path, specified as a `Simulink.BlockPath` object. This block path uniquely identifies a block within a model hierarchy, even when the model hierarchy references the same model multiple times.

Output Arguments

length — Length of block path

integer

Length of the block path, returned as an integer. The length is the number of levels in the model reference hierarchy.

See Also

Objects

Simulink.BlockPath

Functions

convertToCell | getBlock | open | validate

Introduced in R2010b

open

Package: Simulink

Open specified model, library, subsystem, or block

Syntax

```
open(bp)  
open(bp, Name, Value)
```

Description

`open(bp)` opens the specified model, library, subsystem, or block. This is equivalent to double-clicking the model or library in the Current Folder browser or the subsystem or block in the Simulink Editor.

`open(bp, Name, Value)` opens the specified model, library, subsystem, or block with additional options.

Examples

Open Referenced Model in Context of Model Hierarchy

Create a `Simulink.BlockPath` object that represents a referenced model within a model hierarchy.

```
load_system('sldemo_mdref_depgraph')  
bp = Simulink.BlockPath({'sldemo_mdref_depgraph/thermostat', ...  
    'sldemo_mdref_heater/Fahrenheit to Celsius'});
```

Open the referenced model specified by `bp` in the context of the model hierarchy.

```
open(bp)
```

Open Referenced Model in New Window

Open the `sldemo_mdref_depgraph` model.

```
sldemo_mdref_depgraph
```

Create a `Simulink.BlockPath` object that represents a referenced model within a model hierarchy.

```
bp = Simulink.BlockPath({'sldemo_mdref_depgraph/thermostat', ...  
    'sldemo_mdref_heater/Fahrenheit to Celsius'})
```

Open the referenced model specified by `bp` in a new window.

```
open(bp, 'OpenType', 'new-window')
```

Input Arguments

bp — Fully specified block path

Simulink.BlockPath object

Fully specified block path, specified as a Simulink.BlockPath object. This block path uniquely identifies a block within a model hierarchy, even when the model hierarchy references the same model multiple times.

Name-Value Pair Arguments

Specify optional comma-separated pairs of Name, Value arguments. Name is the argument name and Value is the corresponding value. Name must appear inside quotes. You can specify several name and value pair arguments in any order as Name1, Value1, ..., NameN, ValueN.

Example: `open(bp, 'OpenType', 'new-window')`

OpenType — Option to open object in new tab or window

'current-tab' (default) | 'new-tab' | 'new-window'

Option to open object in a new tab or window, specified as the comma-separated pair consisting of 'OpenType' and 'current-tab', 'new-tab', or 'new-window'. This option determines whether the subsystem or model specified by a Simulink.BlockPath object opens in the current window and tab, a new tab, or a new window, respectively.

Data Types: char | string

Force — Option to open object under block mask

'off' (default) | 'on'

Option to open the object under the block mask, specified as the comma-separated pair consisting of 'Force' and 'off' or 'on'. When this argument is set to 'off', the function opens the block mask. When this argument is set to 'on', the function opens the dialog box of the block under the mask or opens the masked system in a new tab, which is equivalent to the **Look Under Mask** menu item. It forces the Simulink.BlockPath object to open, regardless of the block mask.

Data Types: char | string

See Also

Objects

Simulink.BlockPath

Functions

open_system | validate

Introduced in R2019a

validate

Package: Simulink

Determine whether block path represents valid block hierarchy

Syntax

```
validate(bp)
```

Description

`validate(bp)` determines whether the block path represents a valid block hierarchy. If the block path is invalid, the function returns an error. The function checks that:

- All elements in the block path represent valid blocks
- Each element except the last is a valid Model block and references the model of the following element

Examples

Validate Block Path

Create a `Simulink.BlockPath` object that incorrectly represents a referenced model within a model hierarchy.

```
load_system('sldemo_mdref_depgraph')
bp = Simulink.BlockPath({'sldemo_mdref_depgraph/thermostat', ...
'sldemo_mdref_heater/F2C'});
```

Check whether the block path is valid.

```
validate(bp);
```

The function returns an error because the block path is invalid. It does not specify the name of a block in the `sldemo_mdref_heater` model.

Create a `Simulink.BlockPath` object that correctly represents the referenced model within a model hierarchy.

```
bp = Simulink.BlockPath({'sldemo_mdref_depgraph/thermostat', ...
'sldemo_mdref_heater/Fahrenheit to Celsius'});
```

Check whether the block path is valid.

```
validate(bp);
```

The block path is valid, so the function does not return an error.

Input Arguments

bp — Fully specified block path

`Simulink.BlockPath` object

Fully specified block path, specified as a `Simulink.BlockPath` object. This block path uniquely identifies a block within a model hierarchy, even when the model hierarchy references the same model multiple times.

See Also

Objects

`Simulink.BlockPath`

Functions

`convertToCell` | `getBlock` | `getLength` | `open`

Introduced in R2010b

Simulink.Bus.cellToObject

Convert cell array containing bus information to Simulink.Bus objects

Syntax

```
Simulink.Bus.cellToObject(busCell)
Simulink.Bus.cellToObject(busCell,scope)
```

Description

`Simulink.Bus.cellToObject(busCell)` creates a set of `Simulink.Bus` objects in the MATLAB base workspace from a cell array of bus information.

`Simulink.Bus.cellToObject(busCell,scope)` creates a set of `Simulink.Bus` objects in the data dictionary specified by `scope` from a cell array of bus information.

Examples

Create Simulink.Bus Object from Cell Array of Bus Information

This example shows how to create and use a cell array to generate `Simulink.Bus` objects in the base workspace.

To define the elements that the Bus object contains, create an array of `Simulink.BusElement` objects or a cell array of the property values for the `BusElement` objects.

When you define the elements in an array of `BusElement` objects, you must specify the values that differ from the default.

```
elementsArray(1) = Simulink.BusElement;

elementsArray(2) = Simulink.BusElement;
elementsArray(2).Name = 'b';
elementsArray(2).Min = -3;
elementsArray(2).Max = 3;
elementsArray(2).Unit = 'm';
elementsArray(2).Description = 'b is distance from the origin.';
```

When you define the elements in a cell array of property values, you must specify the element name, dimensions, data type, complexity, and sampling mode. You can also specify the dimensions mode, minimum, maximum, units, and description.

```
elementsCellArray = {{ 'a', 1, 'double', -1, 'real', 'Sample' }; ...
                    { 'b', 1, 'double', 'real', 'Sample', ...
                      'Fixed', -3, 3, 'm', 'b is distance from the origin' }};
```

In this example, `elementsArray` and `elementsCellArray` create the same `BusElement` objects in the Bus objects.

Create a cell array with two subordinate cell arrays that define Bus objects. For each Bus object, specify the bus name, header file, description, data scope, alignment, preserve element dimensions,

and elements. For the first Bus object, specify the elements using `elementsArray`. For the second Bus object, specify the elements using `elementsCellArray`.

```
busCells = { ...
    { ...
        'myBusObjArray', ...
        'MyHeader.h', ...
        'My description', ...
        'Exported', ...
        '-1', ...
        '0', ...
        elementsArray,...
    }, ...
    { ...
        'myBusObjCellArray', ...
        'MyHeader.h', ...
        'My description', ...
        'Exported', ...
        '-1', ...
        '0', ...
        elementsCellArray,...
    }, ...
};
```

Generate the Bus objects in the base workspace from the cell array of cell arrays.

```
Simulink.Bus.cellToObject(busCells)
```

Compare the generated Bus objects in the **Bus Editor**.

```
buseditor
```

The Bus objects are identical other than their names.

Input Arguments

busCell — Simulink.Bus object information

cell array of cell arrays

Bus object information, specified as a cell array of cell arrays. Each subordinate cell array must contain this Bus object information:

- 1 Bus name
- 2 Header file
- 3 Description
- 4 Data scope
- 5 Alignment
- 6 Preserve Element Dimensions
- 7 Elements

The `elements` field is a cell array that contains this information for each of the `Simulink.BusElement` objects that the Bus object references:

The `elements` field must contain arrays or cell arrays with this information for each of the `Simulink.BusElement` objects that the `Bus` object references:

- 1 Element name
- 2 Dimensions
- 3 Data type
- 4 Sample time (optional) — If you specify a sample time, specify an inherited sample time (-1). A noninherited sample time causes an error during model compilation. For more information, see “`Simulink.BusElement` objects no longer support the `SampleTime` property” on page 2-538.
- 5 Complexity
- 6 Sampling mode

The `elements` field arrays or cell arrays can also contain this information:

- 1 Dimensions mode
- 2 Minimum
- 3 Maximum
- 4 Units
- 5 Description

Example: `Simulink.Bus.cellToObject(busCell);`

scope — Data dictionary to contain Simulink.Bus objects

`Simulink.data.Dictionary` object

Data dictionary, specified as a `Simulink.data.Dictionary` object. Before you use this argument, represent the dictionary with a `Simulink.data.Dictionary` object by using, for example, the `Simulink.data.dictionary.create` or `Simulink.data.dictionary.open` function.

If `scope` is empty, the function uses the MATLAB base workspace as the source of the `Bus` objects.

Example: `Simulink.Bus.cellToObject(busCell,dataDictionaryObject);`

Tips

The inverse function is `Simulink.Bus.objectToCell`.

Compatibility Considerations

Simulink.BusElement objects no longer support the SampleTime property

Errors starting in R2020b

The `SampleTime` property of `Simulink.BusElement` objects is no longer supported.

`BusElement` objects that specify a sample time cause an error during compile. To remove the sample time specification from a `BusElement` object, set its `SampleTime` to -1.

`Simulink.Bus.cellToObject` continues to accept cell arrays that specify sample time for bus elements. `Simulink.Bus.objectToCell`, `Simulink.Bus.save`, and `Simulink.Bus.createObject` continue to return cell arrays or arrays that include the sample time

when it is noninherited. When the sample time is inherited (-1), they omit it. Similarly, the **Bus Editor** and **Model Explorer** omit the sample time when it is inherited.

To specify the sample time for an element of a bus, use the `SampleTime` block parameter of corresponding blocks. For example, you can use `In Bus Element`, `Out Bus Element`, and `Signal Specification` blocks to specify sample time.

Simulink.BusElement objects will no longer support the SamplingMode property

Not recommended starting in R2016b

In R2016b, the `SamplingMode` property of `Simulink.BusElement` objects was removed. Scripts that use the `SamplingMode` property of `Simulink.BusElement` objects continue to work. `Simulink.Bus.cellToObject` continues to require the `SamplingMode` field and `Simulink.Bus.objectToCell` continues to include the sampling mode in the output cell arrays.

In a future release, support for the `SamplingMode` property will be removed.

To specify whether a signal is sample-based or frame-based, define the sampling mode of input signals at the block level instead of at the signal level.

See Also

Classes

`Simulink.Bus` | `Simulink.BusElement`

Functions

`Simulink.Bus.objectToCell` | `Simulink.Bus.createObject` | `Simulink.Bus.save`

Topics

“Specify Bus Properties with `Simulink.Bus` Object Data Types”

“Create Bus Objects Programmatically”

“Create and Specify `Simulink.Bus` Objects”

“Save `Simulink.Bus` Objects”

Introduced before R2006a

Simulink.Bus.createMATLABStruct

Create MATLAB structures that use the same hierarchy and attributes as buses

Syntax

```
structs = Simulink.Bus.createMATLABStruct(buses)
structs = Simulink.Bus.createMATLABStruct(buses,values)
structs = Simulink.Bus.createMATLABStruct(buses,values,dims)
structs = Simulink.Bus.createMATLABStruct(buses,values,dims,scope)
```

Description

`structs = Simulink.Bus.createMATLABStruct(buses)` creates one or more MATLAB structures that have the same hierarchy and attributes as the specified buses. The resulting structures use the ground values of the buses. Use this syntax to create initialization structures for multiple bus ports.

`structs = Simulink.Bus.createMATLABStruct(buses,values)` creates one or more structures that use the specified values.

`structs = Simulink.Bus.createMATLABStruct(buses,values,dims)` creates one or more structures that have the specified dimensions. To create a structure for an array of buses, include the `dims` argument.

`structs = Simulink.Bus.createMATLABStruct(buses,values,dims,scope)` creates one or more structures in the data dictionary specified by `scope`.

Examples

Create MATLAB Structure from Bus Object

Open and simulate model `ex_bus_initial_conditions`.

```
open_system('ex_bus_initial_conditions')
sim('ex_bus_initial_conditions');
```

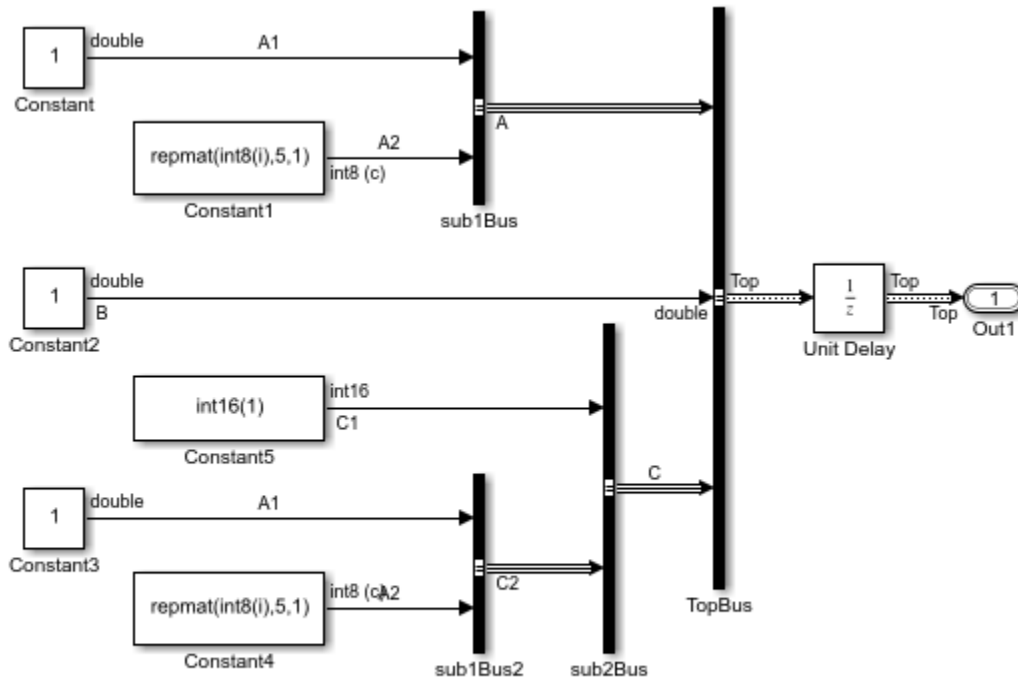

Copyright 2004-2018 The MathWorks, Inc.

Create a MATLAB structure using bus object Top, which model `ex_bus_initial_conditions` loads.

```
mStruct = Simulink.Bus.createMATLABStruct('Top');
```

Set a value for the field of the `mStruct` structure that corresponds to bus element A1 of bus A.

```
mStruct.A.A1 = 3;
mStruct.A
```

```
ans =
```

```
struct with fields:
```

```
A1: 3
A2: [5x1 int8]
```

Simulink sets the other fields in the structure to the ground values of the corresponding bus elements.

You can use `mStruct` as the initial condition structure for the Unit Delay block.

Initialize Signal Elements that Use a Data Type Other than Double

Create a MATLAB structure for a bus whose signal elements use a data type other than `double`. Use a partial structure to specify initialization values for a subset of the elements. When you create the

partial structure, match the data types of the fields with the data types of the corresponding elements.

Open and simulate model `ex_bus_initial_conditions`.

```
open_system('ex_bus_initial_conditions')
sim('ex_bus_initial_conditions');
```

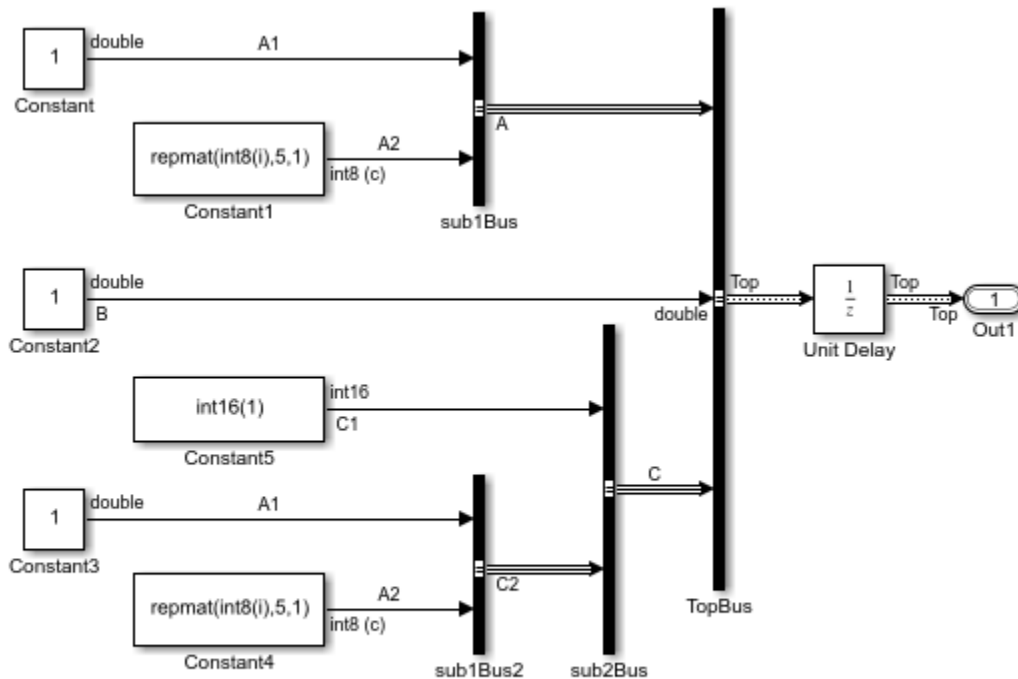

Copyright 2004-2018 The MathWorks, Inc.

The C1 signal element that the block labeled Constant5 produces uses the data type `int16`.

Find the port handle for the Bus Creator block port that produces the Top bus signal.

```
ph = get_param('ex_bus_initial_conditions/TopBus', 'PortHandles');
```

Create a partial structure that specifies values for a subset of the elements in the bus signal created by the TopBus block. To set the value of the `C.C1` field, use a typed expression. Match the data type in the expression with the data type of the signal element in the model (`int16`).

```
PartialstructForK = struct('B',3,'C',struct('C1',int16(5)));
```

Create a full structure by using the port handle (`ph`) for the TopBus block. Override the ground values for the `C.C1` and `B` elements.

```
outPort = ph.Outport;
mStruct = Simulink.Bus.createMATLABStruct(outPort,PartialstructForK);
```

The field `C.C1` in the output structure continues to use the data type `int16`.

Create MATLAB Structure with Specified Dimensions

Open and simulate model `ex_bus_initial_conditions`.

```
open_system('ex_bus_initial_conditions')
sim('ex_bus_initial_conditions');
```

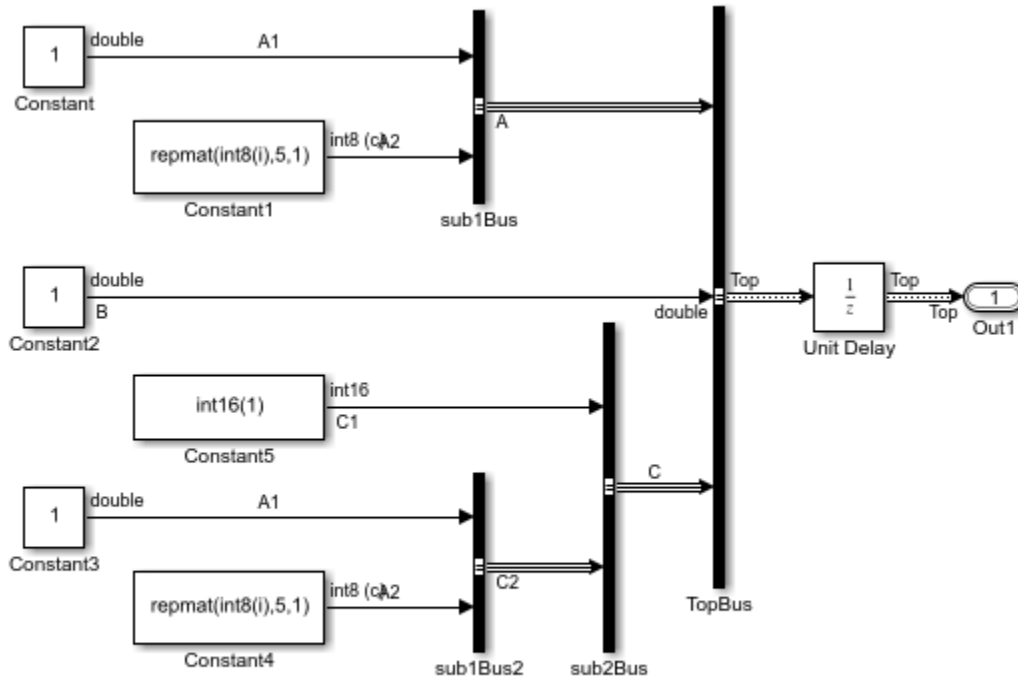

Copyright 2004-2018 The MathWorks, Inc.

Create a partial structure for a subset of bus elements in the bus created by the TopBus block.

```
PartialStructFork = struct('A',struct('A1',4),'B',3)
```

```
PartialStructFork =
```

```
struct with fields:
```

```
A: [1x1 struct]
B: 3
```

Create a MATLAB structure using bus object Top, a partial structure, and dimensions for the resulting structure.

```
structFromBus = Simulink.Bus.createMATLABStruct...
('Top',PartialStructFork,[2 3])
```

```
structFromBus =
```

2x3 struct array with fields:

```
A
B
C
```

Create Cell Array of MATLAB Structures

To create initialization structures for multiple bus ports, specify port handles as arguments for `Simulink.Bus.createMATLABStruct`. The resulting cell array of structures uses ground values.

Open and simulate model `ex_two_outports_create_struct`.

```
open_system('ex_two_outports_create_struct')
sim('ex_two_outports_create_struct');
```

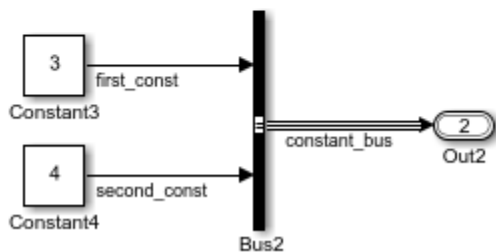
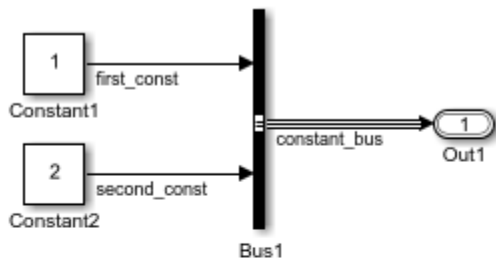

Find the port handles for the Bus Creator blocks Bus1 and Bus2.

```
ph_1 = get_param...
    ('ex_two_outports_create_struct/Bus Creator', 'PortHandles');
ph_2 = get_param...
    ('ex_two_outports_create_struct/Bus Creator1', 'PortHandles');
```

Create a MATLAB® structure using an array of port handles.

```
mStruct = Simulink.Bus.createMATLABStruct([ph_1.Outport ph_2.Outport])
```

```
mStruct =
    2x1 cell array
    {1x1 struct}
```

```
{1x1 struct}
```

Create MATLAB Structure from Bus Port and Partial Structure

Create a MATLAB structure based on a port that connects to a bus signal. Use a partial structure to specify values for a subset of the bus elements in the bus that connects to the port.

Open and simulate model `ex_bus_initial_conditions`.

```
open_system('ex_bus_initial_conditions')
sim('ex_bus_initial_conditions');
```

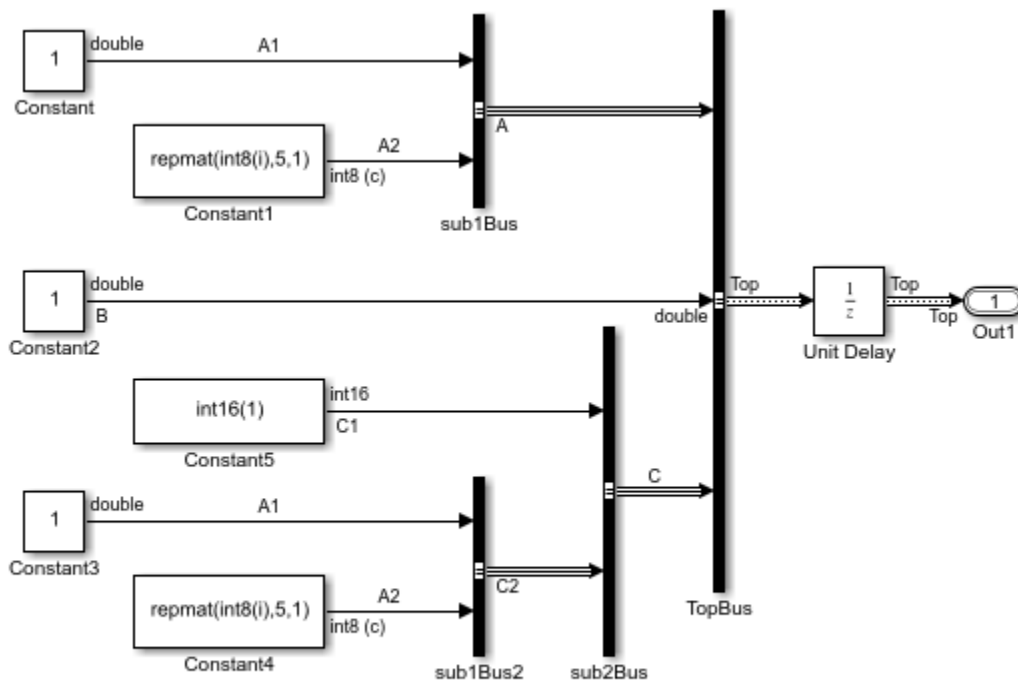

Copyright 2004-2018 The MathWorks, Inc.

Find the port handle for the Bus Creator block port that produces the Top bus signal. The Output handle is the handle that you need.

```
ph = get_param('ex_bus_initial_conditions/TopBus', 'PortHandles')
```

```
ph =
```

```
struct with fields:
```

```
Inport: [29.0138 31.0138 37.0138]
Output: 40.0138
Enable: []
Trigger: []
```

```

State: []
LConn: []
RConn: []
Ifaction: []
Reset: []

```

Create a partial structure for the bus signal created by the TopBus block. You can use a partial structure to specify values for a subset of bus elements.

```
PartialstructFork = struct('A',struct('A1',4), 'B',3)
```

```

PartialstructFork =
  struct with fields:
    A: [1x1 struct]
    B: 3

```

Bus elements represented by structure fields `Top.B` and `Top.A` are at the same level in the bus hierarchy. You can use this partial structure to override the ground values for the B and A bus signal elements.

When you create a structure from a bus object or from a bus port, you can use a partial structure as an optional argument.

Create a MATLAB structure by using the port handle (ph) for the TopBus block. Override the ground values for the A.A1 and B bus elements.

```

outPort = ph.Outputport;
mStruct = Simulink.Bus.createMATLABStruct(outPort,PartialstructFork)

```

```

mStruct =
  struct with fields:
    A: [1x1 struct]
    B: 3
    C: [1x1 struct]

```

Input Arguments

buses — Source of bus information

Simulink.Bus object name | port handle | cell array of Simulink.Bus object names | array of port handles

Source of the bus information, specified as a Bus object name, port handle, cell array of Bus object names, or array of port handles.

- If you use a Bus object name, then the Bus object must be in the MATLAB base workspace or the data dictionary used by the model. The data type for a Bus object name is `char` or `string`.
- If you use a port handle, then the model must compile successfully before you use this function. The data type for a port handle is `double`.

- For an array of buses, you cannot use a port handle.
- If you use the `dims` argument, then for the `buses` argument, use a `Bus` object or cell array of `Bus` objects.

Specifying a cell array of `Bus` object names or an array of port handles creates multiple structures with one `Simulink.Bus.createMATLABStruct` call and provides better performance than using separate `Simulink.Bus.createMATLABStruct` calls to create the structures.

Example: `struct = Simulink.Bus.createMATLABStruct('BusObject')`

Example: `structs = Simulink.Bus.createMATLABStruct({'BusObject', 'BusObject1'})`

Example: `struct = Simulink.Bus.createMATLABStruct(portHandle)`

Example: `structs = Simulink.Bus.createMATLABStruct([portHandle, portHandle1])`

Data Types: `double` | `char` | `string` | `struct` | `cell`

values — Values for subset of elements in resulting structure

`[]` | partial structure | cell array

Values for a subset of elements in the resulting structure, specified as an empty matrix (`[]`), partial structure, or cell array. The cell array must contain a partial structure or empty matrix for each specified source of bus information.

For information on creating partial structures, see “Create Partial Structures for Initialization”.

To use ground values, use an empty matrix.

Example: `struct = Simulink.Bus.createMATLABStruct('BusObject', PartialStruct)`

Data Types: `struct` | `cell`

dims — Dimensions of resulting structure

scalar | vector | cell array

Dimensions of the resulting structure, specified as a vector.

Each dimension element must be an integer that is greater than or equal to 1. If you specify a partial structure for the `values` argument, each dimension element must be greater than or equal to its corresponding dimension element in the partial structure.

Example: `struct = Simulink.Bus.createMATLABStruct('BusObject', PartialStruct, [2 3])`

Example: `structs = Simulink.Bus.createMATLABStruct({'Bus', 'Bus1', 'Bus2'}, {[[], [], []], {1, 2, 3}})`

Data Types: `double` | `cell`

scope — Data dictionary to contain MATLAB structure

`Simulink.data.Dictionary` object

Data dictionary, specified as a `Simulink.data.Dictionary` object. Before you use this argument, represent the dictionary with a `Simulink.data.Dictionary` object by using, for example, the `Simulink.data.dictionary.create` or `Simulink.data.dictionary.open` function.

If `scope` is empty, the function uses the MATLAB base workspace as the source of the `Bus` objects.

```
Example: structs = Simulink.Bus.createMATLABStruct({'Bus', 'Bus1', 'Bus2'},{[],
[], []}, {1,1,1}, dataDictionaryObject)
```

Output Arguments

structs — Structures with same signal hierarchy and attributes as buses

MATLAB structure | cell array of MATLAB structures

Structures with the same signal hierarchy and attributes as buses, returned as a MATLAB structure or a cell array of MATLAB structures.

The structure dimensions depend on the input arguments you specify:

- If you specify only the `buses` argument, then the dimension is 1.
- If you also specify the `values` argument, then the dimensions match the dimensions of `values`.
- If you specify the `dims` argument, then the dimensions match the dimensions of `dims`.

Tips

- If you use the `Simulink.Bus.createMATLABStruct` function repeatedly for the same model (for example, in a loop in a script), you can improve performance by avoiding multiple model compilations. For improved speed, put the model in compile before using the function multiple times. For example, to put the `vdp` model in compile, use this command:

```
vdp([], [], [], 'compile')
```

After you create the MATLAB structure, terminate the compile by using this command:

```
vdp([], [], [], 'term')
```

- You can use the **Bus Editor** to invoke the `Simulink.Bus.createMATLABStruct` function by using one of these approaches:
 - Select the **File > Create a MATLAB structure** menu item.
 - Select the Bus object for which you want to create a full MATLAB structure. Then, in the toolbar, click the **Create a MATLAB structure** button .

You can then edit the MATLAB structure in the MATLAB Editor and evaluate the code to create or update the values in this structure.

- You can use the `Simulink.Bus.createMATLABStruct` function to specify the initial value of the output of a referenced model. For details, see the “Referenced Model: Setting Initial Value for Bus Output” section of the Detailed Workflow for Managing Data with Model Reference example.

See Also

Blocks

Bus Assignment | Bus Creator | Bus to Vector

Classes

Simulink.Bus | Simulink.BusElement

Functions

Simulink.Bus.cellToObject | Simulink.Bus.createObject |
Simulink.Bus.objectToCell | Simulink.SimulationData.createStructOfTimeseries

Topics

“Types of Composite Signals”
“Specify Initial Conditions for Bus Elements”

Introduced in R2010a

Simulink.Bus.createObject

Create `Simulink.Bus` objects from blocks or MATLAB structures

Syntax

```
busInfo = Simulink.Bus.createObject(model,blocks)
busInfo = Simulink.Bus.createObject(struct)
busInfo = Simulink.Bus.createObject( ___,file)
busInfo = Simulink.Bus.createObject( ___,file,format)
busInfo = Simulink.Bus.createObject(struct,file,format,scope)
```

Description

`busInfo = Simulink.Bus.createObject(model,blocks)` creates `Simulink.Bus` objects for the specified blocks and returns information about the created Bus objects.

If you specify a block that corresponds to a bus hierarchy, this function creates Bus objects for each bus in the hierarchy.

If the model uses a data dictionary, the Bus objects are created in the data dictionary. Otherwise, they are created in the base workspace.

`busInfo = Simulink.Bus.createObject(struct)` creates Bus objects from a structure that can contain MATLAB timeseries, MATLAB timetable, and `matlab.io.datastore.SimulationDatastore` objects or a numeric structure.

If you specify a structure with hierarchy, this function creates Bus objects for each structure in the hierarchy.

The Bus objects are created in the base workspace.

`busInfo = Simulink.Bus.createObject(___,file)` saves Bus objects in a function that defines object properties in a cell array of cell arrays, then creates the Bus objects by calling `Simulink.Bus.cellToObject`.

Specify any of the input argument combinations in the previous syntaxes followed by the `file` argument.

`busInfo = Simulink.Bus.createObject(___,file,format)` saves Bus objects in a function with the specified format. The function can define object properties using cell arrays or arrays.

`busInfo = Simulink.Bus.createObject(struct,file,format,scope)` creates the Bus objects in the data dictionary specified by `scope`.

Examples

Create Simulink.Bus Object from Bus Creator Block

Open the example model.

```
open_system('BusObjectCreationModel')
```

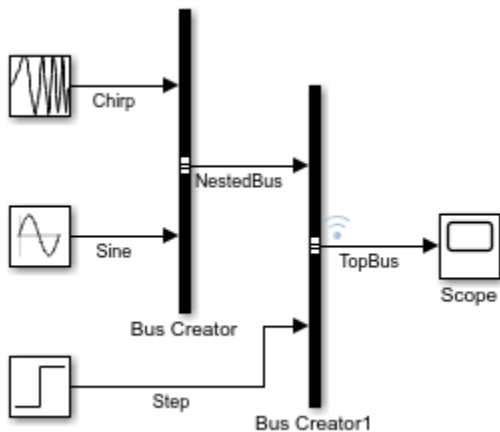

Create a Bus object that corresponds with the bus created by the Bus Creator block.

```
busInfo = Simulink.Bus.createObject('BusObjectCreationModel',...
    'BusObjectCreationModel/Bus Creator');
```

Create and Save Simulink.Bus Objects in a Function

Create Bus objects from two Bus Creator blocks and save the Bus object definition in a function.

Open the example model.

```
open_system('BusObjectCreationModel');
```

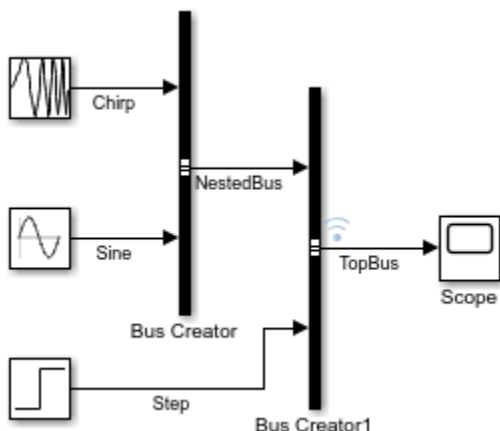

Assign the block handle for the Bus Creator block to a variable with the `getSimulinkBlockHandle` function.

```
bc = getSimulinkBlockHandle('BusObjectCreationModel/Bus Creator');
```

Alternatively, you can select a Bus Creator block in the model then use the `gcbh` function to get its block handle.

Assign the block handle for the Bus Creator1 block to a variable.

```
bc1 = getSimulinkBlockHandle('BusObjectCreationModel/Bus Creator1');
```

To create a Bus object, specify the block handle variables in a vector. To save the Bus object definition, also specify a file name.

```
busInfo = Simulink.Bus.createObject('BusObjectCreationModel',...  
    [bc bc1], 'BusObjectFunction');
```

Since these Bus Creator blocks create a bus hierarchy, specifying only the Bus Creator1 block creates both Bus objects in the Workspace and in the function.

Compare the BusObjectFunction against the function created by this command.

```
topBusInfo = Simulink.Bus.createObject('BusObjectCreationModel',...  
    bc1, 'BusObjectFunctionFromHierarchy');
```

For a function that is formatted to be easier to read, specify the function format as object.

```
topBusInfo1 = Simulink.Bus.createObject('BusObjectCreationModel',...  
    bc1, 'BusObjectFunctionFormatted','object');
```

Create Simulink.Bus Objects from MATLAB Structures

When you create a nonvirtual bus with a Constant block, you must specify a MATLAB structure for **Constant value** and a Simulink.Bus object as the **Output data type**.

For this example, create a structure that contains other structures.

```
bus_struct.A.A1 = 0;  
bus_struct.A.A2 = [0 + 0i;0 + 0i;0 + 0i;0 + 0i;0 + 0i];  
bus_struct.B = 5;  
bus_struct.C.C1 = 0;  
bus_struct.C.C2.A1 = 0;  
bus_struct.C.C2.A2 = [0 + 0i;0 + 0i;0 + 0i;0 + 0i;0 + 0i];
```

Create the Bus objects that correspond with the structure.

```
busInfo = Simulink.Bus.createObject(bus_struct);
```

The function creates four Bus objects. The Bus object named `s1Bus1` corresponds to the top-level structure and uses a default Bus object name. The Bus objects named A, C, and C2 correspond to the nested structures.

To view the Bus objects, open the Bus Editor.

```
buseditor
```

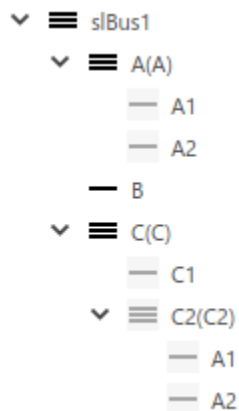

Input Arguments

model — Model name or handle

character vector

Model name or handle, specified as a character vector.

The model you specify must compile successfully.

blocks — Blocks associated with buses

character vector | cell array of block path names | vector of block handles

Blocks associated with buses, specified as a character vector, cell array of block path names, or vector of block handles. For one block, specify the full path name of the block. For multiple blocks, specify either a cell array of block path names or a vector of block handles.

This function can create Bus objects from these blocks:

- Bus Creator blocks
- Subsystem Inport blocks
- Subsystem Outport blocks

If you specify a block associated with a bus hierarchy, the function also creates Bus objects for all nested buses in the hierarchy.

struct — Structure of objects or numeric structure

structure of MATLAB timeseries, MATLAB timetable, and matlab.io.datastore.SimulationDatastore objects | numeric structure

Structure of objects or numeric structure, specified as a structure that can contain MATLAB timeseries, MATLAB timetable, and matlab.io.datastore.SimulationDatastore objects or a numeric structure.

file — Name of function being generated

character vector

Name of function being generated, specified as a character vector. The file name must be unique.

format — Format of function being generated`'cell' (default) | 'object'`

Format of function being generated, specified as either `'cell'` or `'object'`. The `'cell'` format is more compact, but the `'object'` format is easier to read.

The `'cell'` format saves the Bus object definitions in a cell array of cell arrays and creates the Bus objects by calling `Simulink.Bus.cellToObject`. Each subordinate cell array represents a Bus object and contains these properties:

- 1 Bus name
- 2 Header file
- 3 Description
- 4 Data scope
- 5 Alignment
- 6 Preserve Element Dimensions
- 7 Elements

The `elements` field is a cell array that contains this information for each of the `Simulink.BusElement` objects that the Bus object references:

- 1 Element name
- 2 Dimensions
- 3 Data type
- 4 Sample time — The cell array contains this field when the sample time is not inherited. A noninherited sample time causes an error during model compilation. For more information, see “Simulink.BusElement objects no longer support the SampleTime property” on page 2-555.
- 5 Complexity
- 6 Dimensions mode
- 7 Minimum
- 8 Maximum
- 9 Units
- 10 Description

The `'object'` format saves the Bus object definitions as arrays. The function uses array indexing to access elements of the array and dot notation to assign property values.

scope — Data dictionary to contain Simulink.Bus objects`Simulink.data.Dictionary` object

Data dictionary, specified as a `Simulink.data.Dictionary` object. Before you use this argument, represent the dictionary with a `Simulink.data.Dictionary` object by using, for example, the `Simulink.data.dictionary.create` or `Simulink.data.dictionary.open` function.

If `scope` is empty, the function uses the MATLAB base workspace as the source of the Bus objects.

Output Arguments

busInfo — Bus object information

structure array

Bus object information, returned as a structure array.

When you specify blocks, each element of the `busInfo` structure array corresponds to one block and contains these fields:

- `block` — Handle of the block
- `busName` — Name of the Bus object associated with the block

When you use specify a `struct`, the `busInfo` structure contains these fields:

- `block` — Empty matrix (`[]`)
- `busName` — Name of the Bus object that corresponds to the structure

Compatibility Considerations

Simulink.BusElement objects no longer support the SampleTime property

Errors starting in R2020b

The `SampleTime` property of `Simulink.BusElement` objects is no longer supported.

`BusElement` objects that specify a sample time cause an error during compile. To remove the sample time specification from a `BusElement` object, set its `SampleTime` to `-1`.

`Simulink.Bus.cellToObject` continues to accept cell arrays that specify sample time for bus elements. `Simulink.Bus.objectToCell`, `Simulink.Bus.save`, and `Simulink.Bus.createObject` continue to return cell arrays or arrays that include the sample time when it is noninherited. When the sample time is inherited (`-1`), they omit it. Similarly, the **Bus Editor** and **Model Explorer** omit the sample time when it is inherited.

To specify the sample time for an element of a bus, use the `SampleTime` block parameter of corresponding blocks. For example, you can use `In Bus Element`, `Out Bus Element`, and `Signal Specification` blocks to specify sample time.

See Also

Tools

Bus Editor

Objects

`Simulink.Bus` | `Simulink.BusElement`

Functions

`Simulink.Bus.cellToObject` | `Simulink.Bus.createMATLABStruct`

Blocks

Bus Creator

Topics

“Specify Bus Properties with Simulink.Bus Object Data Types”

“Create Bus Objects Programmatically”

Introduced before R2006a

Simulink.Bus.objectToCell

Use Simulink.Bus objects to create cell array containing bus information

Syntax

```
cells = Simulink.Bus.objectToCell(busNames)
cells = Simulink.Bus.objectToCell(busNames,scope)
```

Description

`cells = Simulink.Bus.objectToCell(busNames)` creates a cell array of bus information from a set of Simulink.Bus objects in the MATLAB base workspace. The cell array contains subordinate cell arrays that define each Bus object. The order of elements in the output cell array corresponds to the order of names in the input cell array.

`cells = Simulink.Bus.objectToCell(busNames,scope)` creates a cell array of bus information from a set of Bus objects in the data dictionary specified by `scope`. The cell array contains subordinate cell arrays that define each Bus object. The order of elements in the output cell array corresponds to the order of names in the input cell array.

Examples

Create Cell Array Containing Bus Object Information

Use the Simulink.Bus.objectToCell function to create a cell array of information about Simulink.Bus objects in the base workspace.

Open a model that has two Bus objects defined, CONTROL and MAIN.

```
open_system('ex_bus_object_tutorial_using_objects')
```

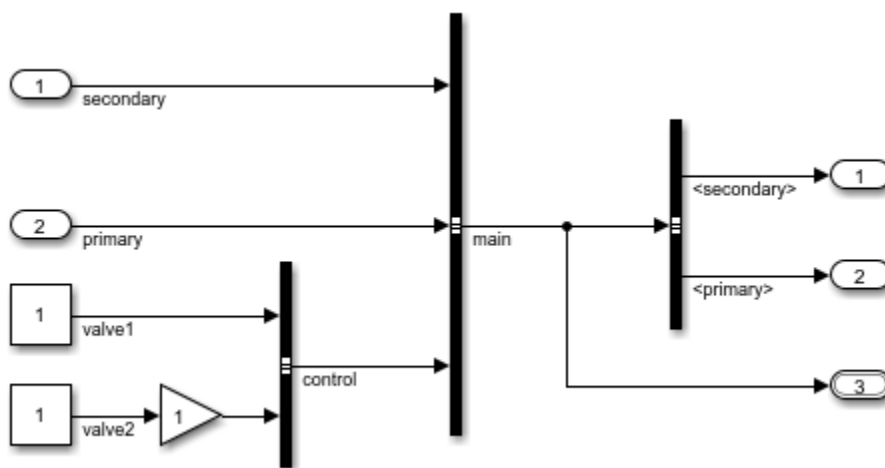

Create a cell array of information about the CONTROL Bus object.

```

cells = Simulink.Bus.objectToCell({'CONTROL'});
cells{1}

ans=1x7 cell array
  Columns 1 through 6
    {'CONTROL'}    {0x0 char}    {0x0 char}    {'Auto'}    {'-1'}    {'0'}

  Column 7
    {2x1 cell}

```

Input Arguments

busNames — Names of Simulink.Bus objects

cell array of Bus object names

Bus objects for which to create cell arrays of Bus object information, specified as a cell array. Specify the Bus object names as character vectors. If `busNames` is empty, the function converts all Bus objects in the base workspace or data dictionary.

Example: `cells = Simulink.Bus.objectToCell({'busObject'})`

scope — Data dictionary that contains Simulink.Bus objects

`Simulink.data.Dictionary` object

Data dictionary, specified as a `Simulink.data.Dictionary` object. Before you use this argument, represent the dictionary with a `Simulink.data.Dictionary` object by using, for example, the `Simulink.data.dictionary.create` or `Simulink.data.dictionary.open` function.

If `scope` is empty, the function uses the MATLAB base workspace as the source of the Bus objects.

Example: `cells = Simulink.Bus.objectToCell({'busObject'},dataDictionaryObject)`

Output Arguments

cells — Bus object information

cell array of cell arrays

Bus object information, specified as a cell array of cell arrays. Each subordinate cell array contains these Bus object properties:

- 1 Bus name
- 2 Header file
- 3 Description
- 4 Data scope
- 5 Alignment
- 6 Preserve Element Dimensions
- 7 Elements

The `elements` field is a cell array that contains this information for each of the `Simulink.BusElement` objects that the Bus object references:

- 1 Bus element name
- 2 Dimensions
- 3 Data type
- 4 Sample time — The cell array contains this field when the sample time is not inherited. A noninherited sample time causes an error during model compilation. For more information, see “Simulink.BusElement objects no longer support the SampleTime property” on page 2-559.
- 5 Complexity
- 6 Sampling mode
- 7 Dimensions mode
- 8 Minimum
- 9 Maximum
- 10 Units
- 11 Description

Tips

The inverse function is `Simulink.Bus.cellToObject`.

Compatibility Considerations

Simulink.BusElement objects no longer support the SampleTime property

Errors starting in R2020b

The `SampleTime` property of `Simulink.BusElement` objects is no longer supported.

`BusElement` objects that specify a sample time cause an error during compile. To remove the sample time specification from a `BusElement` object, set its `SampleTime` to `-1`.

`Simulink.Bus.cellToObject` continues to accept cell arrays that specify sample time for bus elements. `Simulink.Bus.objectToCell`, `Simulink.Bus.save`, and `Simulink.Bus.createObject` continue to return cell arrays or arrays that include the sample time when it is noninherited. When the sample time is inherited (`-1`), they omit it. Similarly, the **Bus Editor** and **Model Explorer** omit the sample time when it is inherited.

To specify the sample time for an element of a bus, use the `SampleTime` block parameter of corresponding blocks. For example, you can use `In Bus Element`, `Out Bus Element`, and `Signal Specification` blocks to specify sample time.

Simulink.BusElement objects will no longer support the SamplingMode property

Not recommended starting in R2016b

In R2016b, the `SamplingMode` property of `Simulink.BusElement` objects was removed. Scripts that use the `SamplingMode` property of `Simulink.BusElement` objects continue to work. `Simulink.Bus.cellToObject` continues to require the `SamplingMode` field and `Simulink.Bus.objectToCell` continues to include the sampling mode in the output cell arrays.

In a future release, support for the `SamplingMode` property will be removed.

To specify whether a signal is sample-based or frame-based, define the sampling mode of input signals at the block level instead of at the signal level.

See Also

Classes

Simulink.Bus | Simulink.BusElement

Functions

Simulink.Bus.cellToObject

Topics

“Specify Bus Properties with Simulink.Bus Object Data Types”

“Create Bus Objects Programmatically”

Introduced in R2007a

Simulink.Bus.save

Save Simulink.Bus objects in function

Syntax

```
Simulink.Bus.save(fileName)
Simulink.Bus.save(fileName,format)
Simulink.Bus.save(fileName,format,busNames)
Simulink.Bus.save(fileName,format,busNames,scope)
```

Description

`Simulink.Bus.save(fileName)` saves all `Simulink.Bus` objects from the MATLAB base workspace in a function. The generated function defines object properties in a cell array of cell arrays, then creates the `Bus` objects by calling `Simulink.Bus.cellToObject`.

`Simulink.Bus.save(fileName,format)` saves the `Bus` objects in a function with the specified format. The function can define object properties using cell arrays or arrays.

`Simulink.Bus.save(fileName,format,busNames)` saves only the specified `Bus` objects in a function.

`Simulink.Bus.save(fileName,format,busNames,scope)` saves the `Bus` objects from the data dictionary specified by `scope` in a function.

Examples

Save a Simulink.Bus Object

Use the `Simulink.Bus.save` function to save a `Bus` object.

Create a cell array of `Bus` object information.

```
busCell = { ...
    { ...
        'myBusObj', ...
        'MyHeader.h', ...
        'My description', ...
        'Exported', ...
        '-1', ...
        '0', ...
        {'a',1,'double','real','Sample'}; ...
        {'b',1,'double','real','Sample', ...
        'Fixed',-3,3,'m','b is distance from the origin'}}, ...
    } ...
    { ...
        'myBusObj1', ...
        'MyHeader1.h', ...
        'My description', ...
        'Exported', ...
```

```

        '-1', ...
        '0', ...
        {'c',1,'double','real','Sample'}; ...
        {'d',1,'double','real','Sample'}}, ...
    } ...
};

```

Generate Bus objects in the base workspace from the cell array.

```
Simulink.Bus.cellToObject(busCell);
```

Save the Bus objects in a function, using the default format.

```
Simulink.Bus.save('BusObjectFunctionCellFormat');
```

For a function that is formatted to be easier to read, specify the function format as 'object'.

```
Simulink.Bus.save('BusObjectFunctionObjectFormat','object');
```

To save only one of the Bus objects in a function, specify the Bus object name.

```
Simulink.Bus.save('BusObjectFunctionSubset','cell',{'myBusObj'});
```

Input Arguments

fileName — Name of function to generate

character vector

Name of function to generate, specified as a character vector. The file name must be unique.

Example: `Simulink.Bus.save('BusObjectFunction');`

format — Format of function to generate

'cell' (default) | 'object'

Format of function to generate, specified as either 'cell' or 'object'. The 'cell' format is more compact, but the 'object' format is easier to read.

The 'cell' format saves the Bus object definitions in a cell array of cell arrays and creates the Bus objects by calling `Simulink.Bus.cellToObject`. Each subordinate cell array represents a Bus object and contains these properties:

- 1 Bus name
- 2 Header file
- 3 Description
- 4 Data scope
- 5 Alignment
- 6 Preserve Element Dimensions
- 7 Elements

The elements field is a cell array that contains this information for each of the `Simulink.BusElement` objects that the Bus object references:

- 1 Element name
- 2 Dimensions
- 3 Data type
- 4 Sample time — The cell array contains this field when the sample time is not inherited. A noninherited sample time causes an error during model compilation. For more information, see “Simulink.BusElement objects no longer support the SampleTime property” on page 2-563.
- 5 Complexity
- 6 Dimensions mode
- 7 Minimum
- 8 Maximum
- 9 Units
- 10 Description

The 'object' format saves the Bus object definitions as arrays. The function uses array indexing to access elements of the array and dot notation to assign property values.

Example: `Simulink.Bus.save('BusObjectFunction','object');`

busNames — Bus objects to save

empty cell array | cell array of bus objects

Bus objects to save, specified as an empty cell array ({}) or a cell array of Bus object names.

When you specify a cell array of Bus object names, only the specified Bus objects are saved.

When you specify an empty cell array, all Bus objects are saved. Use an empty cell array to save all Bus objects in the data dictionary specified by scope.

Example: `Simulink.Bus.save('BusObjectFunction','cell',{'myBusObj'});`

scope — Data dictionary that contains Bus objects

`Simulink.data.Dictionary` object

Data dictionary, specified as a `Simulink.data.Dictionary` object. Before you use this argument, represent the dictionary with a `Simulink.data.Dictionary` object by using, for example, the `Simulink.data.dictionary.create` or `Simulink.data.dictionary.open` function.

If scope is empty, the function uses the MATLAB base workspace as the source of the Bus objects.

Example: `Simulink.Bus.save('BusObjectFunction','cell',{},dataDictionaryObject);`

Compatibility Considerations

Simulink.BusElement objects no longer support the SampleTime property

Errors starting in R2020b

The `SampleTime` property of `Simulink.BusElement` objects is no longer supported.

`BusElement` objects that specify a sample time cause an error during compile. To remove the sample time specification from a `BusElement` object, set its `SampleTime` to `-1`.

`Simulink.Bus.cellToObject` continues to accept cell arrays that specify sample time for bus elements. `Simulink.Bus.objectToCell`, `Simulink.Bus.save`, and

`Simulink.Bus.createObject` continue to return cell arrays or arrays that include the sample time when it is noninherited. When the sample time is inherited (-1), they omit it. Similarly, the **Bus Editor** and **Model Explorer** omit the sample time when it is inherited.

To specify the sample time for an element of a bus, use the `SampleTime` block parameter of corresponding blocks. For example, you can use `In Bus Element`, `Out Bus Element`, and `Signal Specification` blocks to specify sample time.

See Also

Tools

Bus Editor

Objects

`Simulink.Bus` | `Simulink.BusElement`

Functions

`Simulink.Bus.cellToObject` | `Simulink.Bus.createObject`

Topics

“Specify Bus Properties with `Simulink.Bus` Object Data Types”

“Create Bus Objects Programmatically”

Introduced before R2006a

Simulink.clearIntEnumType

Delete enumeration classes defined by `Simulink.defineIntEnumType`

Syntax

```
Simulink.clearIntEnumType(typeName)  
Simulink.clearIntEnumType()
```

Description

`Simulink.clearIntEnumType(typeName)` deletes a specific enumeration class that is defined by `Simulink.defineIntEnumType`. The function generates a warning if the class name is invalid or if a class cannot be deleted because instances of the class exist.

`Simulink.clearIntEnumType()` deletes all enumeration classes that are defined by `Simulink.defineIntEnumType`. The function generates a warning if a class cannot be deleted because instances of the class exist.

Examples

Delete a Specific Dynamic Enumerated Data Type

Define an enumeration type and confirm that it has been created.

```
Simulink.defineIntEnumType('myEnumType', {'e1', 'e2'}, [1 2]);  
myResult = Simulink.findIntEnumType('myEnumType')
```

Delete the enumeration type that you created and confirm that it is no longer there.

```
Simulink.clearIntEnumType('myEnumType');  
myResult = Simulink.findIntEnumType('myEnumType')
```

Delete All Dynamic Enumerated Data Types

Define two enumeration types and confirm that they have been created.

```
Simulink.defineIntEnumType('myEnumType1', {'e1', 'e2'}, [1 2]);  
Simulink.defineIntEnumType('myEnumType2', {'e3', 'e4'}, [3 4]);  
myResult = Simulink.findIntEnumType()
```

Delete all enumeration types and confirm that no enumeration types exist.

```
Simulink.clearIntEnumType();  
myResult = Simulink.findIntEnumType()
```

Input Arguments

typeName — Name of enumeration class

character vector or string

Name of a specific enumeration class that is defined by `Simulink.defineIntEnumType`, specified as a character vector or string.

Example: 'myEnumType'

Data Types: char | string

See Also

[enumeration](#) | [Simulink.defineIntEnumType](#) | [Simulink.findIntEnumType](#)

Introduced in R2018b

addSymbol

Package: Simulink.CFunctionBlock

Add a symbol object definition to a C Function block

Syntax

```
mySymbol = addSymbol(mySymbolSpec)
mySymbol = addSymbol(mySymbolSpec, name)
```

Description

`mySymbol = addSymbol(mySymbolSpec)` creates a `Symbol` object, `mySymbol`, and adds the symbol to the `SymbolSpec` object, `mySymbolSpec`.

`mySymbol = addSymbol(mySymbolSpec, name)` creates a `Symbol` object, `mySymbol`, with the `Name` property specified by `name` and adds the symbol to the `SymbolSpec` object `mySymbolSpec`.

Examples

Specify and Edit Symbol Attributes Used in a C Function Block

Access and edit the properties of a symbol used in a C Function block.

Obtain the `SymbolSpec` object of the C Function block in your model using `get_param`. For example, select the C Function block in the model canvas and enter the following at the command line.

```
mySymbolSpec = get_param(gcb, 'SymbolSpec');
```

Use the `addSymbol` function to specify a new parameter symbol, `myParam`, in your C Function block code.

```
myParam = addSymbol(mySymbolSpec, 'myParam')
```

The `Symbol` object, `myParam`, uses default properties. Specify the scope of the symbol using the `Scope` property.

```
myParam.Scope = 'Parameter';
```

You can use the `getSymbol` function to access symbols specified for the block. For example, access the parameter symbol you added.

```
myParam = getSymbol(mySymbolSpec, 'myParam');
```

Edit the label of the parameter in the Block Parameters dialog using the `Label` property.

```
myParam.Label = 'Amplitude';
```

To delete a symbol from the `SymbolSpec` object, use the `deleteSymbol` function.

```
deleteSymbol(mySymbolSpec, 'myParam');
```

Input Arguments

mySymbolSpec — Symbol specifications of C Function block

SymbolSpec object

Symbol specifications of C Function block, specified as a SymbolSpec object.

name — Name of symbol

character vector

Name of the symbol, specified as a character vector.

Data Types: character

Output Arguments

mySymbol — Symbol

Symbol object

Symbol added to the C Function block, returned as a Symbol object. The Symbol object has default properties, except when you specify a name for the symbol in the input arguments. You can edit the properties of the Symbol object after creation.

See Also

Functions

getSymbol | deleteSymbol

Objects

SymbolSpec | Symbol

Blocks

C Function

Topics

“Call and Integrate External C Algorithms into Simulink Using C Function Blocks”

Introduced in R2020a

getSymbol

Package: Simulink.CFunctionBlock

Get a symbol object definition of a C Function block

Syntax

```
mySymbol = getSymbol(mySymbolSpec, name)
```

Description

`mySymbol = getSymbol(mySymbolSpec, name)` returns the `Symbol` object with the `Name` property specified by `name` associated with the `SymbolSpec` object.

Examples

Specify and Edit Symbol Attributes Used in a C Function Block

Access and edit the properties of a symbol used in a C Function block.

Obtain the `SymbolSpec` object of the C Function block in your model using `get_param`. For example, select the C Function block in the model canvas and enter the following at the command line.

```
mySymbolSpec = get_param(gcf, 'SymbolSpec');
```

Use the `addSymbol` function to specify a new parameter symbol, `myParam`, in your C Function block code.

```
myParam = addSymbol(mySymbolSpec, 'myParam')
```

The `Symbol` object, `myParam`, uses default properties. Specify the scope of the symbol using the `Scope` property.

```
myParam.Scope = 'Parameter';
```

You can use the `getSymbol` function to access symbols specified for the block. For example, access the parameter symbol you added.

```
myParam = getSymbol(mySymbolSpec, 'myParam');
```

Edit the label of the parameter in the Block Parameters dialog using the `Label` property.

```
myParam.Label = 'Amplitude';
```

To delete a symbol from the `SymbolSpec` object, use the `deleteSymbol` function.

```
deleteSymbol(mySymbolSpec, 'myParam');
```

Input Arguments

mySymbolSpec — Symbol specifications of C Function block

SymbolSpec object

Symbol specifications of C Function block, specified as a SymbolSpec object.

name — Name of symbol

character vector

Name of the symbol, specified as a character vector.

Data Types: character

Output Arguments

mySymbol — Symbol

Symbol object

Symbol associated with the C Function block, returned as a Symbol object.

See Also

Functions

addSymbol | deleteSymbol

Objects

SymbolSpec | Symbol

Blocks

C Function

Topics

“Call and Integrate External C Algorithms into Simulink Using C Function Blocks”

Introduced in R2020a

deleteSymbol

Package: Simulink.CFunctionBlock

Delete a symbol object definition from a C Function block

Syntax

```
deleteSymbol(mySymbolSpec, name)
```

Description

`deleteSymbol(mySymbolSpec, name)` deletes the `Symbol` object with the `Name` property specified by `name` from the `SymbolSpec` object.

Examples

Specify and Edit Symbol Attributes Used in a C Function Block

Access and edit the properties of a symbol used in a C Function block.

Obtain the `SymbolSpec` object of the C Function block in your model using `get_param`. For example, select the C Function block in the model canvas and enter the following at the command line.

```
mySymbolSpec = get_param(gcf, 'SymbolSpec');
```

Use the `addSymbol` function to specify a new parameter symbol, `myParam`, in your C Function block code.

```
myParam = addSymbol(mySymbolSpec, 'myParam')
```

The `Symbol` object, `myParam`, uses default properties. Specify the scope of the symbol using the `Scope` property.

```
myParam.Scope = 'Parameter';
```

You can use the `getSymbol` function to access symbols specified for the block. For example, access the parameter symbol you added.

```
myParam = getSymbol(mySymbolSpec, 'myParam');
```

Edit the label of the parameter in the Block Parameters dialog using the `Label` property.

```
myParam.Label = 'Amplitude';
```

To delete a symbol from the `SymbolSpec` object, use the `deleteSymbol` function.

```
deleteSymbol(mySymbolSpec, 'myParam');
```

Input Arguments

mySymbolSpec — Symbol specifications of C Function block

SymbolSpec object

Symbol specifications of C Function block, specified as a SymbolSpec object.

name — Name of symbol

character vector

Name of the symbol to delete, specified as a character vector.

Data Types: character

See Also

Functions

addSymbol | getSymbol

Objects

SymbolSpec | Symbol

Blocks

C Function

Topics

“Call and Integrate External C Algorithms into Simulink Using C Function Blocks”

Introduced in R2020a

Simulink.createFromTemplate

Create model or project from template

Syntax

```
Simulink.createFromTemplate(templatename)
h = Simulink.createFromTemplate(templatename)
h = Simulink.createFromTemplate(templatename,Name,Value)
```

Description

`Simulink.createFromTemplate(templatename)` creates a model or a project from the template file specified by `templatename`. The new project is created in the default project folder.

`h = Simulink.createFromTemplate(templatename)` creates a model or a project from the template file and returns `h`, either a numeric model handle or a `simulinkproject` object.

`h = Simulink.createFromTemplate(templatename,Name,Value)` specifies additional options as one or more `Name, Value` pair arguments.

Examples

Create a Model From a Template

```
Simulink.createFromTemplate('simple_simulation.sltx')
```

Create a Project From a Template and Get the Handle

Create a project from a template, specify the name and root folder, and return the handle to the new project (a `simulinkproject` object) for manipulating it programmatically.

```
proj = Simulink.createFromTemplate('code_generation_example.sltx','Name','myProject','Folder','C
```

Input Arguments

templatename — Template file name

character vector

Template file name, specified as a character vector. If the template is not on the MATLAB path, specify the fully-qualified path to the template file and `*.sltx` extension.

Example:

Data Types: char

Name-Value Pair Arguments

Specify optional comma-separated pairs of `Name`, `Value` arguments. `Name` is the argument name and `Value` is the corresponding value. `Name` must appear inside quotes. You can specify several name and value pair arguments in any order as `Name1, Value1, . . . , NameN, ValueN`.

Example:

Folder — Project root folder

character vector

Project root folder, if creating a new project, specified as a character vector.

Data Types: `char`

Name — New model or project name

character vector

New model or project name, specified as a character vector.

Data Types: `char`

Output Arguments

h — Handle

numeric handle | `simulinkproject`

Handle to the new model project, returned either as a numeric model handle or a `simulinkproject` object.

See Also

`Simulink.exportToTemplate` | `Simulink.findTemplates` |
`Simulink.defaultModelTemplate`

Topics

“Build and Edit a Model Interactively”

“Create Template from Model”

“Using Templates to Create Standard Project Settings”

Introduced in R2016a

Simulink.data.assigninGlobal

Modify variable values in context of Simulink model

Syntax

```
Simulink.data.assigninGlobal(modelName,varName,varValue)
```

Description

`Simulink.data.assigninGlobal(modelName,varName,varValue)` assigns the value `varValue` to the variable or data dictionary entry `varName` in the context of the Simulink model `modelName`. `assigninGlobal` creates the variable or data dictionary entry if it does not already exist. The function operates in the Design Data section of the data dictionary that is linked to the target model or in the MATLAB base workspace if the target model is not linked to any data dictionary.

If the target model is linked to a data dictionary that references other dictionaries, `assigninGlobal` searches for `varName` in the entire dictionary hierarchy. If `assigninGlobal` does not find a matching entry, the function creates an entry in the dictionary that is linked to the target model.

Examples

Modify Variable in Model With or Without Data Dictionary

Create a variable `myNewVariable` with value 237 in the context of the Simulink model `vdp.slx`, which is not linked to any data dictionary. `myNewVariable` appears as a variable in the MATLAB base workspace.

```
Simulink.data.assigninGlobal('vdp','myNewVariable',237)
```

Create a variable `myNewEntry` with value `true` in the context of the Simulink model `sldemo_fuelsys_dd_controller.slx`, which is linked to the data dictionary `sldemo_fuelsys_dd_controller.sldd`. The entry `myNewEntry` appears in the Design Data section of the dictionary.

```
Simulink.data.assigninGlobal('sldemo_fuelsys_dd_controller',...
    'myNewEntry',true)
```

Confirm the addition of `myNewEntry` to the data dictionary `sldemo_fuelsys_dd_controller.sldd` by viewing the dictionary in Model Explorer.

```
myDictionaryObj = Simulink.data.dictionary.open(...
    'sldemo_fuelsys_dd_controller.sldd');
show(myDictionaryObj)
```

Input Arguments

modelName — Name of target Simulink model

character vector

Name of target Simulink model, specified as a character vector.

Example: 'myTestModel'

Data Types: char

varName — Name of target variable or data dictionary entry

character vector

Name of target variable or data dictionary entry, specified as a character vector.

Example: 'myTargetVariable'

Data Types: char

varValue — Value to assign to variable or data dictionary entry

MATLAB expression

Value to assign to variable or data dictionary entry, specified as a MATLAB expression that returns any valid data type or data dictionary content.

Example: 27.5

Example: myBaseWorkspaceVariable

Example: Simulink.Parameter

Tips

- `assignInGlobal` helps you transition Simulink models to using data dictionaries. You can use the function to assign values to model variables before and after linking a model to a data dictionary.

See Also

`Simulink.data.evalInGlobal` | `Simulink.data.existsInGlobal` | `Simulink.data.dictionary.open`

Topics

“Store Data in Dictionary Programmatically”

“What Is a Data Dictionary?”

“Considerations before Migrating to Data Dictionary”

Introduced in R2015a

addDataSource

Package: Simulink.data

Add reference data dictionary to parent data dictionary

Syntax

```
addDataSource(dictionaryObj, refDictionaryFile)
```

Description

`addDataSource(dictionaryObj, refDictionaryFile)` adds a data dictionary, `refDictionaryFile`, as a reference dictionary to a parent dictionary `dictionaryObj`, a `Simulink.data.Dictionary` object.

The parent dictionary contains all the entries that are defined in the referenced dictionary until the referenced dictionary is removed from the parent dictionary. The `DataSource` property of an entry indicates the dictionary that defines the entry.

Examples

Add a Reference Data Dictionary to a Parent Data Dictionary

Open the data dictionary `myDictionary_ex_API.sldd` and represent it with a `Simulink.data.Dictionary` object named `myDictionaryObj`.

```
myDictionaryObj = Simulink.data.dictionary.open('myDictionary_ex_API.sldd');
```

Add the data dictionary `mySubDictionary_ex_API.sldd` as a reference dictionary to `myDictionary_ex_API.sldd`.

```
addDataSource(myDictionaryObj, 'mySubDictionary_ex_API.sldd');
```

Confirm the addition by viewing the `DataSources` property of variable `myDictionaryObj`. The property returns the name of the newly referenced dictionary.

```
myDictionaryObj.DataSources
```

```
ans =
```

```
    'myRefDictionary_ex_API.sldd'  
    'mySubDictionary_ex_API.sldd'
```

Input Arguments

dictionaryObj — Parent data dictionary

`Simulink.data.Dictionary` object

Parent data dictionary, specified as a `Simulink.data.Dictionary` object. Before you use this function, represent the target dictionary with a `Simulink.data.Dictionary` object by using, for

example, the `Simulink.data.dictionary.create` or `Simulink.data.dictionary.open` function.

refDictionaryFile — File name of data dictionary to reference

character vector

File name of data dictionary to reference, specified as a character vector that includes the `.sldd` extension. The data dictionary file must be on your MATLAB path.

Example: `'mySubDictionary_ex_API.sldd'`

Data Types: `char`

Alternatives

You can use the Model Explorer window to manage reference dictionaries. See “Partition Dictionary Data Using Referenced Dictionaries” for more information.

See Also

`Simulink.data.Dictionary` | `removeDataSource`

Topics

“Store Data in Dictionary Programmatically”

Introduced in R2015a

Simulink.data.dictionary.cleanupWorkerCache

Restore defaults after parallel simulation with data dictionary

Syntax

```
Simulink.data.dictionary.cleanupWorkerCache
```

Description

`Simulink.data.dictionary.cleanupWorkerCache` restores default settings after you have finished parallel simulation of a model that is linked to a data dictionary. Use this function in a `spmd` block, after you finish parallel simulation using `parfor` blocks, to restore default settings that were altered by the `Simulink.data.dictionary.setupWorkerCache` function.

During parallel simulation of a model that is linked to a data dictionary, you can allow each worker to access and modify the data in the dictionary independently of other workers. The function `Simulink.data.dictionary.setupWorkerCache` grants each worker a unique dictionary cache to allow independent access to the data, and the function `Simulink.data.dictionary.cleanupWorkerCache` restores cache settings to their default values.

You must have a Parallel Computing Toolbox license to perform parallel simulation using a `parfor` block.

Examples

Sweep Variant Control Using Parallel Simulation

To use parallel simulation to sweep a variant control (a `Simulink.Parameter` object whose value influences the variant condition of a `Simulink.Variant` object) that you store in a data dictionary, use this code as a template. Change the names and values of the model, data dictionary, and variant control to match your application.

To sweep block parameter values or the values of workspace variables that you use to set block parameters, use `Simulink.SimulationInput` objects instead of the programmatic interface to the data dictionary. See “Optimize, Estimate, and Sweep Block Parameter Values”.

You must have a Parallel Computing Toolbox license to perform parallel simulation.

```
% For convenience, define names of model and data dictionary
model = 'mySweepMdl';
dd = 'mySweepDD.slidd';

% Define the sweeping values for the variant control
CtrlValues = [1 2 3 4];

% Grant each worker in the parallel pool an independent data dictionary
% so they can use the data without interference
spmd
    Simulink.data.dictionary.setupWorkerCache
```

```

end

% Determine the number of times to simulate
numberOfSims = length(CtrlValues);

% Prepare a nondistributed array to contain simulation output
simOut = cell(1,numberOfSims);

parfor index = 1:numberOfSims
    % Create objects to interact with dictionary data
    % You must create these objects for every iteration of the parfor-loop
    dictObj = Simulink.data.dictionary.open(dd);
    sectObj = getSection(dictObj, 'Design Data');
    entryObj = getEntry(sectObj, 'MODE');
    % Suppose MODE is a Simulink.Parameter object stored in the data dictionary

    % Modify the value of MODE
    temp = getValue(entryObj);
    temp.Value = CtrlValues(index);
    setValue(entryObj,temp);

    % Simulate and store simulation output in the nondistributed array
    simOut{index} = sim(model);

    % Each worker must discard all changes to the data dictionary and
    % close the dictionary when finished with an iteration of the parfor-loop
    discardChanges(dictObj);
    close(dictObj);
end

% Restore default settings that were changed by the function
% Simulink.data.dictionary.setupWorkerCache
% Prior to calling cleanupWorkerCache, close the model

spmd
    bdclose(model)
    Simulink.data.dictionary.cleanupWorkerCache
end

```

Note If data dictionaries are open, you cannot use the command `Simulink.data.dictionary.cleanupWorkerCache`. To identify open data dictionaries, use `Simulink.data.dictionary.getOpenDictionaryPaths`.

See Also

`spmd` | `parfor` | `Simulink.data.dictionary.setupWorkerCache` |
`Simulink.data.dictionary.getOpenDictionaryPaths` |
`Simulink.data.dictionary.closeAll`

Topics

“Store Data in Dictionary Programmatically”
 “What Is a Data Dictionary?”
 “Run Code on Parallel Pools” (Parallel Computing Toolbox)

Introduced in R2015a

close

Package: Simulink.data

Close connection between data dictionary and Simulink.data.Dictionary object

Syntax

```
close(dictionaryObj)
```

Description

`close(dictionaryObj)` closes the connection between the Simulink.data.Dictionary object `dictionaryObj` and the data dictionary it represents. `dictionaryObj` remains as a Simulink.data.Dictionary object but no longer represents any data dictionary.

Examples

Close Connection Between Data Dictionary Object and Data Dictionary

Open the data dictionary `myDictionary_ex_API.sldd` and represent it with a Simulink.data.Dictionary object named `myDictionaryObj`.

```
myDictionaryObj = Simulink.data.dictionary.open('myDictionary_ex_API.sldd');
```

Remove connection between `myDictionaryObj` and `myDictionary_ex_API.sldd`.

```
close(myDictionaryObj);
```

Input Arguments

dictionaryObj — Target Simulink.data.Dictionary object

handle to Simulink.data.Dictionary object

Target Simulink.data.Dictionary object, specified as a handle to the object.

Tips

- Use the `close` function in a custom MATLAB function to disassociate a Simulink.data.Dictionary object from a data dictionary. Custom MATLAB functions can create and store variables and objects in function workspaces but cannot delete those variables and objects.
- The `close` function does not affect the content or the state of the represented data dictionary. The function does not discard unsaved changes to the represented dictionary or entries. You can save or discard them later.

See Also

Simulink.data.Dictionary

Topics

“Store Data in Dictionary Programmatically”

Introduced in R2015a

Simulink.data.dictionary.closeAll

Close all connections to all open data dictionaries

Syntax

```
Simulink.data.dictionary.closeAll
Simulink.data.dictionary.closeAll(dictFileName)
Simulink.data.dictionary.closeAll( ____,unsavedAction)
```

Description

`Simulink.data.dictionary.closeAll` attempts to close all connections to all data dictionaries that are open. For example, if you create objects, such as `Simulink.data.Dictionary`, that refer to a dictionary, that dictionary is open.

Some commands and functions, such as `Simulink.data.dictionary.cleanupWorkerCache`, cannot operate when dictionaries are open. It is a best practice to close each connection individually by using functions and methods such as the `close` method of a `Simulink.data.Dictionary` object. To find dictionaries that are open, use `Simulink.data.dictionary.getOpenDictionaryPaths`. However, you can use this function to close all connections to all dictionaries.

You can also use this function to close dictionaries in a shutdown script that is part of a project.

`Simulink.data.dictionary.closeAll(dictFileName)` closes all connections to the dictionary named `dictFileName`. If you open multiple dictionaries that use this file name (for example, if the dictionaries have different file paths), the function closes all connections to all of the dictionaries.

You cannot specify `dictFileName` as a full file path such as `'C:\temp\myDict.sldd'`.

`Simulink.data.dictionary.closeAll(____,unsavedAction)` closes all connections to the target dictionaries by discarding or saving unsaved changes. You can choose whether to save or discard all changes to all of the target dictionaries.

Examples

Close All Connections to All Open Dictionaries

Discard any unsaved changes. All of the entries in the dictionaries revert to the last saved state.

```
Simulink.data.dictionary.closeAll('-discard')
```

Close All Connections to Single Data Dictionary

Open multiple connections to a data dictionary, make a change, and close all of the connections by discarding the unsaved change.

At the command prompt, open a data dictionary by creating a `Simulink.data.Dictionary` object that refers to the dictionary.

```
dictObj = Simulink.data.dictionary.open('sldemo_fuelsys_dd.sldd');
```

Display the dictionary in the Model Explorer

```
show(dictObj)
```

You now have two connections to this dictionary: The `Simulink.data.Dictionary` object and the Model Explorer.

Make a change to the dictionary by adding an entry.

```
dDataSectObj = getSection(dictObj, 'Design Data');  
addEntry(dDataSectObj, 'myEntry', 5.2);
```

The `Simulink.data.dictionary.Section` object `dDataSectObj` is a third connection to the dictionary.

Close the connections to the dictionary. Discard the unsaved change.

```
Simulink.data.dictionary.closeAll('sldemo_fuelsys_dd.sldd', '-discard')
```

The dictionary no longer appears as a node in the **Model Hierarchy** pane of the Model Explorer. The `Simulink.data.Dictionary` object `dictObj` is disconnected from the dictionary. You cannot interact with the dictionary by using the `Simulink.data.dictionary.Section` object `dDataSectObj`.

Clear the objects that referred to the dictionary.

```
clear dictObj dDataSectObj
```

Input Arguments

dictFileName — File name of target data dictionary or dictionaries

character vector

File name of target data dictionary or dictionaries, specified as a character vector. Use the file extension `sldd`.

Example: `'myDict.sldd'`

Data Types: `char`

unsavedAction — Action for unsaved changes

`'-discard'` | `'-save'`

Action for unsaved changes, specified as `'-discard'` (to discard changes) or `'-save'` (to save changes).

Tips

A data dictionary is open if any of these conditions are true:

- The dictionary appears as a node in the **Model Hierarchy** pane of the Model Explorer. To close this connection to the dictionary, right-click the node in Model Explorer and select **Close**. Alternatively, use the `hide` method of a `Simulink.data.Dictionary` object.
- You created an object of any of these classes that refer to the dictionary:
 - `Simulink.data.Dictionary`
 - `Simulink.data.dictionary.Section`
 - `Simulink.data.dictionary.Entry`

To close these connections to the dictionary, use the `close` method of the `Simulink.data.Dictionary` object or clear the object. Clear the `Simulink.data.dictionary.Section` and `Simulink.data.dictionary.Entry` objects.

- A model that is linked to the dictionary is open. To close this connection to the dictionary, close the model.

See Also

`Simulink.data.Dictionary` | `Simulink.data.dictionary.setupWorkerCache` |
`Simulink.data.dictionary.cleanupWorkerCache` |
`Simulink.data.dictionary.getOpenDictionaryPaths`

Topics

“Store Data in Dictionary Programmatically”

Introduced in R2016a

Simulink.data.dictionary.create

Create new data dictionary and create Simulink.data.Dictionary object

Syntax

```
dictionaryObj = Simulink.data.dictionary.create(dictionaryFile)
```

Description

`dictionaryObj = Simulink.data.dictionary.create(dictionaryFile)` creates a data dictionary file in your current working folder or in a file path you can specify in `dictionaryFile`. The function returns a `Simulink.data.Dictionary` object representing the new data dictionary.

Examples

Create New Data Dictionary and Data Dictionary Object

Create a data dictionary `myNewDictionary.sldd` in your current working folder and a `Simulink.data.Dictionary` object representing the new data dictionary. Assign the object to the variable `myDictionaryObj`.

```
myDictionaryObj = Simulink.data.dictionary.create('myNewDictionary.sldd')
```

```
myDictionaryObj =
```

```
Dictionary with properties:
```

```
        DataSourcees: {0x1 cell}
    HasAccessToBaseWorkspace: 0
EnableAccessToBaseWorkspace: 0
        HasUnsavedChanges: 0
        NumberOfEntries: 0
```

Input Arguments

dictionaryFile — Name of new data dictionary

character vector

Name of new data dictionary, specified as a character vector containing the file name and, optionally, path of the dictionary to create. If you do not specify a path, `Simulink.data.dictionary.create` creates the new data dictionary file in your working MATLAB folder.

`Simulink.data.dictionary.create` also supports file paths specified relative to your working folder.

Example: `'myDictionary.sldd'`

Example: `'C:\Users\jsmith\myDictionary.sldd'`

Example: `'..\myOtherDictionary.sldd'`

Data Types: char

Output Arguments

dictionaryObj — Newly created data dictionary

`Simulink.data.Dictionary` object

Newly created data dictionary, returned as a `Simulink.data.Dictionary` object.

Alternatives

You can use the Simulink Editor to create a data dictionary and link it to a model. See “Migrate Single Model to Use Dictionary” for more information.

See Also

`Simulink.data.Dictionary` | `Simulink.data.dictionary.open`

Topics

“Store Data in Dictionary Programmatically”

“What Is a Data Dictionary?”

Introduced in R2015a

discardChanges

Package: Simulink.data

Discard changes to data dictionary

Syntax

```
discardChanges(dictionaryObj)
```

Description

`discardChanges(dictionaryObj)` discards all changes made to the specified data dictionary since the last time changes to the dictionary were saved using the `saveChanges` function. `discardChanges` also discards changes made to referenced data dictionaries. The changes to the target dictionary and its referenced dictionaries are permanently lost.

Examples

Discard Changes to Data Dictionary

Create a `Simulink.data.Dictionary` object representing the data dictionary `myDictionary_ex_API.sldd` and assign the object to variable `myDictionaryObj`.

```
myDictionaryObj = Simulink.data.dictionary.open('myDictionary_ex_API.sldd')
```

```
myDictionaryObj =
```

```
Dictionary with properties:
```

```
    DataSources: {'myRefDictionary_ex_API.sldd'}  
    HasUnsavedChanges: 0  
    NumberOfEntries: 4
```

Make a change to `myDictionary_ex_API.sldd` by adding an entry named `myNewEntry` with value 237. View the `HasUnsavedChanges` property of `myDictionaryObj` to confirm a change was made.

```
addEntry(dDataSectObj, 'myNewEntry', 237);
```

```
myDictionaryObj
```

```
myDictionaryObj =
```

```
Dictionary with properties:
```

```
    DataSources: {'myRefDictionary_ex_API.sldd'}  
    HasUnsavedChanges: 1  
    NumberOfEntries: 5
```

Discard all changes to `myDictionary_ex_API.sldd`. The `HasUnsavedChanges` property of `myDictionaryObj` indicates changes were discarded.

```
discardChanges(myDictionaryObj)  
myDictionaryObj
```

```
myDictionaryObj =  
    Dictionary with properties:  
        DataSourcees: {'myRefDictionary_ex_API.sldd'}  
        HasUnsavedChanges: 0  
        NumberOfEntries: 4
```

Input Arguments

dictionaryObj — Target data dictionary

`Simulink.data.Dictionary` object

Target data dictionary, specified as a `Simulink.data.Dictionary` object. Before you use this function, represent the target dictionary with a `Simulink.data.Dictionary` object by using, for example, the `Simulink.data.dictionary.create` or `Simulink.data.dictionary.open` function.

Alternatives

You can use the Model Explorer window to discard changes to data dictionaries. See “View and Revert Changes to Dictionary Entries” for more information.

See Also

`saveChanges` | `Simulink.data.Dictionary`

Topics

“Store Data in Dictionary Programmatically”

“What Is a Data Dictionary?”

Introduced in R2015a

deleteEntry

Package: Simulink.data.dictionary

Delete data dictionary entry

Syntax

```
deleteEntry(entryObj)
```

Description

`deleteEntry(entryObj)` deletes the data dictionary entry represented by `entryObj`, a `Simulink.data.dictionary.Entry` object. The represented entry no longer exists in the data dictionary that defined it.

The function sets the `Status` properties of any `Simulink.data.dictionary.Entry` objects representing the deleted entry to `'Deleted'`. You can access only the `Status` properties of the objects.

Examples

Delete Data Dictionary Entry

Represent the data dictionary entry `fuelFlow` with a `Simulink.data.dictionary.Entry` object named `fuelFlowObj`. `fuelFlow` is defined in the data dictionary `myDictionary_ex_API.sldd`.

```
myDictionaryObj = Simulink.data.dictionary.open('myDictionary_ex_API.sldd');  
dDataSectObj = getSection(myDictionaryObj, 'Design Data');  
fuelFlowObj = getEntry(dDataSectObj, 'fuelFlow');
```

Delete the entry `fuelFlow` from the data dictionary `myDictionary_ex_API.sldd`. `myDictionary_ex_API.sldd` no longer contains the `fuelFlow` entry.

```
deleteEntry(fuelFlowObj)
```

Input Arguments

entryObj — Target data dictionary entry

`Simulink.data.dictionary.Entry` object

Target data dictionary entry, specified as a `Simulink.data.dictionary.Entry` object. Before you use this function, represent the target entry with a `Simulink.data.dictionary.Entry` object by using, for example, the `getEntry` function.

Alternatives

You can use the Model Explorer window to view the contents of a data dictionary and delete entries.

See Also

`Simulink.data.dictionary.Entry | addEntry`

Topics

“Store Data in Dictionary Programmatically”

Introduced in R2015a

discardChanges

Package: Simulink.data.dictionary

Discard changes to data dictionary entry

Syntax

```
discardChanges(entryObj)
```

Description

`discardChanges(entryObj)` discards all changes made to the data dictionary entry `entryObj`, a `Simulink.data.dictionary.Entry` object, since the last time the containing data dictionary was saved using the `saveChanges` function. The changes to the entry are permanently lost.

Examples

Discard Changes to Data Dictionary Entry

Represent the data dictionary entry `fuelFlow` with a `Simulink.data.dictionary.Entry` object named `fuelFlowObj`. `fuelFlow` is defined in the data dictionary `myDictionary_ex_API.sldd`.

```
myDictionaryObj = Simulink.data.dictionary.open('myDictionary_ex_API.sldd');
dDataSectObj = getSection(myDictionaryObj, 'Design Data');
fuelFlowObj = getEntry(dDataSectObj, 'fuelFlow');
```

Change the entry `fuelFlow` by assigning it the new value 493. Confirm a change was made by viewing the `Status` property of `fuelFlowObj`.

```
setValue(fuelFlowObj, 493);
fuelFlowObj
```

```
fuelFlowObj =
```

```
Entry with properties:
```

```
    Name: 'fuelFlow'
    Value: 493
    DataSource: 'myDictionary_ex_API.sldd'
    LastModified: '2014-Sep-05 13:14:30.661978'
    LastModifiedBy: 'jsmith'
    Status: 'Modified'
```

Discard all changes to the entry `fuelFlow`. The `Status` property of `fuelFlowObj` shows that changes were discarded.

```
discardChanges(fuelFlowObj)
fuelFlowObj
```

```
fuelFlowObj =
```

```
Entry with properties:
```

```
Name: 'fuelFlow'  
Value: 237  
DataSource: 'myDictionary_ex_API.sldd'  
LastModified: '2014-Sep-05 13:12:06.099278'  
LastModifiedBy: 'jsmith'  
Status: 'Unchanged'
```

Input Arguments

entryObj — Target data dictionary entry

`Simulink.data.dictionary.Entry` object

Target data dictionary entry, specified as a `Simulink.data.dictionary.Entry` object. Before you use this function, represent the target entry with a `Simulink.data.dictionary.Entry` object by using, for example, the `getEntry` function.

Tips

- You can use the `discardChanges` function or the `saveChanges` function with an entire data dictionary, discarding or saving changes to all entries in the dictionary at once. However, only the `discardChanges` function can additionally operate on individual entries. You cannot use the `saveChanges` function to save changes to individual entries.

Alternatives

You can use Model Explorer and the Comparison Tool to discard changes to data dictionary entries. See “View and Revert Changes to Dictionary Entries” for more information.

See Also

`Simulink.data.dictionary.Entry` | `saveChanges`

Topics

“Store Data in Dictionary Programmatically”

Introduced in R2015a

exportToVersion

Package: Simulink.data

Export a Simulink.data.Dictionary object to a previous version

Syntax

```
Simulink.data.Dictionary.exportToVersion(dictionaryObj, target_folder, version)
```

Description

Simulink.data.Dictionary.exportToVersion(dictionaryObj, target_folder, version) exports the data dictionary dictionaryObj to the folder target_folder in a format that the specified previous Simulink version can load. The function also exports references to the specified folder. The file names of the dictionary and its references are preserved.

Examples

Export a Data Dictionary to a Previous Version

Represent the data dictionary sldemo_fuelsys_dd_controller.sldd with a Simulink.data.Dictionary object named myDictionaryObj.

```
myDictionaryObj = Simulink.data.dictionary.open('sldemo_fuelsys_dd_controller.sldd');
```

Export the data dictionary to a previous version of Simulink.

```
exportToVersion(myDictionaryObj, 'myR2018aFolder', 'R2018a');
```

Input Arguments

dictionaryObj — Data dictionary

Simulink.data.Dictionary object

Data dictionary, specified as a Simulink.data.Dictionary object. Before you use this function, represent the target dictionary with a Simulink.data.Dictionary object by using, for example, the Simulink.data.dictionary.create or Simulink.data.dictionary.open function.

target_folder — Folder for dictionary

string scalar | character vector

Target folder for the new version of the dictionary, specified as a character vector or string scalar.

Example: 'myR2018aFolder'

Data Types: char | string

version — MATLAB release name

string scalar | character vector

MATLAB release name, specified as a character vector or string scalar, which specifies a previous Simulink version. The release name is not case sensitive.

`Simulink.data.Dictionary.exportToVersion` exports the data dictionary to a format that the specified previous Simulink version can load. You cannot export to your current version.

Example: 'R2018a'

Data Types: `char` | `string`

See Also

`Simulink.data.Dictionary`

Topics

"What Is a Data Dictionary?"

Introduced in R2018b

find

Package: Simulink.data.dictionary

Search in array of data dictionary entries

Syntax

```
foundEntries = find(targetEntries,PName1,PValue1,...,PNameN,PValueN)
foundEntries = find(targetEntries,PName1,PValue1,...,PNameN,PValueN,options)
```

Description

`foundEntries = find(targetEntries,PName1,PValue1,...,PNameN,PValueN)` searches the array of data dictionary entries `targetEntries` using search criteria `PName1,PValue1,...,PNameN,PValueN`, and returns an array of entries matching the criteria. This syntax matches the search criteria with the properties of the target entries, which are `Simulink.data.dictionary.Entry` objects, but not with the properties of their values. See `Simulink.data.dictionary.Entry` for a list of data dictionary entry properties.

`foundEntries = find(targetEntries,PName1,PValue1,...,PNameN,PValueN,options)` searches for data dictionary entries using additional search options. For example, you can match the search criteria with the values of the target entries.

Examples

Search Data Dictionary Entry Values for Specific Class

Search in an array of data dictionary entries `myEntryObjs` for entries whose values are objects of the class `Simulink.Parameter`.

```
foundEntries = find(myEntryObjs,'-value','-class','Simulink.Parameter')
```

Search Data Dictionary Entries for Modifying User

Search in an array of data dictionary entries `myEntryObjs` for entries that were last modified by the user `jsmith`.

```
foundEntries = find(myEntryObjs,'LastModifiedBy','jsmith')
```

Search Data Dictionary Entries Using Multiple Criteria

Search in an array of data dictionary entries `myEntryObjs` for entries that were last modified by the user `jsmith` or whose names begin with `fuel`.

```
foundEntries = find(myEntryObjs, 'LastModifiedBy', 'jsmith', '-or', ...
'-regexp', 'Name', 'fuel*')
```

Search Data Dictionary Entries Using Regular Expressions

Search in an array of data dictionary entries `myEntryObjs` for entries whose names begin with `Press`.

```
foundEntries = find(myEntryObjs, '-regexp', 'Name', 'Press*')
```

Search Data Dictionary Entries for Specific Value

Search in an array of data dictionary entries `myEntryObjs` for entries whose values are 273. If you find more than one entry, store the entries in an array called `foundEntries`.

```
foundEntries = [];
for i = 1:length(myEntryObjs)
    if getValue(myEntryObjs(i)) == 237
        foundEntries = [foundEntries myEntryObjs(i)];
    end
end
```

Search Data Dictionary Entry Values for Specific Property

Search in an array of data dictionary entries `myEntryObjs` for entries whose values have a property `DataType`.

```
foundEntries = find(myEntryObjs, '-value', '-property', 'DataType')
```

Input Arguments

targetEntries — Data dictionary entries to search

array of `Simulink.data.dictionary.Entry` objects

Data dictionary entries to search, specified as an array `Simulink.data.dictionary.Entry` objects. Before you use this function, represent the target entries with `Simulink.data.dictionary.Entry` objects by using, for example, the `getEntry` function.

Example: `[myEntryObj1, myEntryObj2, myEntryObj3]`

PName1, PValue1, ..., PNameN, PValueN — Search criteria

name-value pairs representing properties

Search criteria, specified as one or more name-value pairs representing names and values of properties of the target data dictionary entries. For a list of the properties of a data dictionary entry, see `Simulink.data.dictionary.Entry`. If you specify more than one name-value pair, the returned entries meet all of the criteria.

If you include the `'-value'` option to search in the values of the target entries, the search criteria apply to the values of the entries rather than to the entries themselves.

Example: 'LastModifiedBy','jsmith'

Example: 'DataSource','myRefDictionary_ex_API.sldd'

options — Additional search options

supported option codes

Additional search options, specified as one or more of the following supported option codes.

| | |
|---|--|
| '-value' | This option causes <code>find</code> to search only in the values of the target data dictionary entries. Specify this option before any other search criteria or <code>options</code> arguments. |
| '-and', '-or', '-xor', or '-not' logical operators | These options modify or combine multiple search criteria or other option codes. |
| '-property',propertyName | This name-value pair causes <code>find</code> to search for entries or values that have the property <code>propertyName</code> regardless of the value of the property. Specify <code>propertyName</code> as a character vector. |
| '-class',className | This name-value pair causes <code>find</code> to search for entries or values that are objects of the class <code>className</code> . Specify <code>className</code> as a character vector. |
| '-isa',className | This name-value pair causes <code>find</code> to search for entries or values that are objects of the class or of any subclass derived from the class <code>className</code> . Specify <code>className</code> as a character vector. |
| '-regexp' | This option allows you to use regular expressions in your search criteria. This option affects only search criteria that follow '-regexp'. |

Example: '-value'

Example: '-value','-property','CoderInfo'

Example: '-value','-class','Simulink.Parameter'

Output Arguments

foundEntries — Data dictionary entries matching search criteria

array of `Simulink.data.dictionary.Entry` objects

Data dictionary entries matching the specified search criteria, returned as an array of `Simulink.data.dictionary.Entry` objects.

See Also

`Simulink.data.dictionary.Entry` | `find`

Topics

“Store Data in Dictionary Programmatically”

Introduced in R2015a

getValue

Package: Simulink.data.dictionary

Return value of data dictionary entry

Syntax

```
entryValue = getValue(entryObj)
```

Description

`entryValue = getValue(entryObj)` returns the value of the data dictionary entry `entryObj`, a `Simulink.data.dictionary.Entry` object.

To programmatically access variables for the purpose of sweeping block parameter values, consider using `Simulink.SimulationInput` objects instead of modifying the variables through the programmatic interface of the data dictionary. See “Optimize, Estimate, and Sweep Block Parameter Values”.

Examples

Return Value of Data Dictionary Entry

Represent the data dictionary entry `fuelFlow` with a `Simulink.data.dictionary.Entry` object named `fuelFlowObj`. `fuelFlow` is defined in the data dictionary `myDictionary_ex_API.sldd`.

```
myDictionaryObj = Simulink.data.dictionary.open('myDictionary_ex_API.sldd');
dDataSectObj = getSection(myDictionaryObj, 'Design Data');
fuelFlowObj = getEntry(dDataSectObj, 'fuelFlow');
```

Return the value of the entry `fuelFlow` and assign the value to variable `fuelFlowValue`.

```
fuelFlowValue = getValue(fuelFlowObj)
```

```
fuelFlowValue =
```

```
    237
```

Input Arguments

entryObj — Target data dictionary entry

`Simulink.data.dictionary.Entry` object

Target data dictionary entry, specified as a `Simulink.data.dictionary.Entry` object. Before you use this function, represent the target entry with a `Simulink.data.dictionary.Entry` object by using, for example, the `getEntry` function.

See Also

`Simulink.data.dictionary.Entry` | `setValue`

Topics

“Store Data in Dictionary Programmatically”

Introduced in R2015a

setValue

Package: Simulink.data.dictionary

Set value of data dictionary entry

Syntax

```
setValue(entryObj, newValue)
```

Description

`setValue(entryObj, newValue)` assigns the value `newValue` to the data dictionary entry `entryObj`, a `Simulink.data.dictionary.Entry` object.

To programmatically access variables for the purpose of sweeping block parameter values, consider using `Simulink.SimulationInput` objects instead of modifying the variables through the programmatic interface of the data dictionary. See “Optimize, Estimate, and Sweep Block Parameter Values”.

Examples

Set Value of Data Dictionary Entry

Represent the data dictionary entry `fuelFlow` with a `Simulink.data.dictionary.Entry` object named `fuelFlowObj`. `fuelFlow` is defined in the data dictionary `myDictionary_ex_API.slidd`.

```
myDictionaryObj = Simulink.data.dictionary.open('myDictionary_ex_API.slidd');
dDataSectObj = getSection(myDictionaryObj, 'Design Data');
fuelFlowObj = getEntry(dDataSectObj, 'fuelFlow');
```

Set the value of the entry `fuelFlow` to 493. Then, view the `Value` property of `fuelFlowObj` to observe the change.

```
setValue(fuelFlowObj, 493)
fuelFlowObj
```

```
fuelFlowObj =
```

```
Entry with properties:
```

```
    Name: 'fuelFlow'
    Value: 493
    DataSource: 'myDictionary_ex_API.slidd'
    LastModified: '2014-Sep-05 13:37:22.161124'
    LastModifiedBy: 'jsmith'
    Status: 'Modified'
```

Input Arguments

entryObj — Target data dictionary entry

`Simulink.data.dictionary.Entry` object

Target data dictionary entry, specified as a `Simulink.data.dictionary.Entry` object. Before you use this function, represent the target entry with a `Simulink.data.dictionary.Entry` object by using, for example, the `getEntry` function.

newValue — Value to assign to data dictionary entry

MATLAB expression

Value to assign to data dictionary entry, specified as a MATLAB expression. The expression must return a value that is supported by the data dictionary section that contains the entry.

Example: 27.5

Example: myBaseWorkspaceVariable

Example: Simulink.Parameter

Alternatives

You can use the Model Explorer window to view and change the values of data dictionary entries.

See Also

`Simulink.data.dictionary.Entry | getValue`

Topics

“Store Data in Dictionary Programmatically”

Introduced in R2015a

showChanges

Package: Simulink.data.dictionary

Display changes made to data dictionary entry

Syntax

```
showChanges(entryObj)
```

Description

showChanges(entryObj) opens the Comparison Tool to show changes made to the data dictionary entry entryObj, a Simulink.data.dictionary.Entry object. The Comparison Tool displays the properties of entryObj as they were when the data dictionary was last saved and as they were when the showChanges function was called.

Examples

View Unsaved Changes to Data Dictionary Entry

Represent the data dictionary entry fuelFlow with a Simulink.data.dictionary.Entry object named fuelFlowObj. fuelFlow is defined in the data dictionary myDictionary_ex_API.sldd.

```
myDictionaryObj = Simulink.data.dictionary.open('myDictionary_ex_API.sldd');
dDataSectObj = getSection(myDictionaryObj, 'Design Data');
fuelFlowObj = getEntry(dDataSectObj, 'fuelFlow');
```

Make a change to the entry fuelFlow by assigning it the new value 494.

```
setValue(fuelFlowObj, 494);
```

Observe the unsaved change to the entry fuelFlow. The Comparison Tool opens and compares side by side the current state of the entry with its most recently saved state.

```
showChanges(fuelFlowObj)
```

Input Arguments

entryObj — Target data dictionary entry

Simulink.data.dictionary.Entry object

Target data dictionary entry, specified as a Simulink.data.dictionary.Entry object. Before you use this function, represent the target entry with a Simulink.data.dictionary.Entry object by using, for example, the getEntry function.

Alternatives

You can use Model Explorer and the Comparison Tool to view changes to data dictionary entries. See “View and Revert Changes to Dictionary Entries” for more information.

See Also

`Simulink.data.dictionary.Entry` | `discardChanges`

Topics

“Store Data in Dictionary Programmatically”

Introduced in R2015a

appendEnumeral

Package: Simulink.data.dictionary

Add enumeration member to enumerated data type definition in data dictionary

Syntax

```
appendEnumeral(typeObj,memberName,memberValue,memberDesc)
```

Description

`appendEnumeral(typeObj,memberName,memberValue,memberDesc)` adds an enumeration member to the enumerated type definition stored by `typeObj`, a `Simulink.data.dictionary.EnumTypeDefinition` object.

Examples

Programmatically Create Enumerated Type Definition in Data Dictionary

Create an object that can store the definition of an enumerated type. By default, the new type defines a single enumeration member `enum1` with underlying integer value 0.

```
myColors = Simulink.data.dictionary.EnumTypeDefinition
```

```
myColors =
```

```
    Simulink.data.dictionary.EnumTypeDefinition
        enum1
```

Add some enumeration members to the definition of the type.

```
appendEnumeral(myColors,'Orange',1,'')
```

```
appendEnumeral(myColors,'Black',2,'')
```

```
appendEnumeral(myColors,'Cyan',3,'')
```

```
myColors
```

```
myColors =
```

```
    Simulink.data.dictionary.EnumTypeDefinition
        enum1
        Orange
        Black
        Cyan
```

Remove the default enumeration member `enum1`. Since `enum1` is the first enumeration member in the list, identify it with index 1.

```
removeEnumeral(myColors,1)
```

```
myColors
```

```
myColors =
```

```
Simulink.data.dictionary.EnumTypeDefinition
    Orange
    Black
    Cyan
```

Customize the enumerated type by configuring the properties of the object representing it.

```
myColors.Description = 'These are my favorite colors.';
myColors.DefaultValue = 'Cyan';
myColors.HeaderFile = 'colorsType.h';
```

Open the data dictionary `myDictionary_ex_API.sldd` and represent it with a `Simulink.data.Dictionary` object named `myDictionaryObj`.

```
myDictionaryObj = Simulink.data.dictionary.open('myDictionary_ex_API.sldd');
```

Import the object that defines the enumerated type `myColors` to the dictionary.

```
importFromBaseWorkspace(myDictionaryObj, 'varList', {'myColors'});
```

Input Arguments

typeObj — Target enumerated type definition

`Simulink.data.dictionary.EnumTypeDefinition` object

Target enumerated type definition, specified as a `Simulink.data.dictionary.EnumTypeDefinition` object.

memberName — Name of new enumeration member

character vector

Name of the new enumeration member, specified as a character vector.

Example: 'myNewEnumMember'

Data Types: char

memberValue — Integer value underlying new enumeration member

integer

Integer value underlying the new enumeration member, specified as an integer.

The definition of the enumeration class determines the integer data type used in generated code to store the underlying values of enumeration members.

Example: 3

Data Types: single | int8 | int16 | int32 | int64 | uint8 | uint16 | uint32 | uint64 | double

memberDesc — Description of new enumeration member

character vector

Description of the new enumeration member, specified as a character vector.

If you do not want to supply a description for the enumeration member, use an empty character vector.

Example: 'Enumeration member number 1.'

Example: ''

Data Types: char

Alternatives

You can use Model Explorer to add enumeration members to the enumerated data type represented by a `Simulink.data.dictionary.EnumTypeDefinition` object.

See Also

`Simulink.data.dictionary.EnumTypeDefinition` | `removeEnumeral`

Topics

“Store Data in Dictionary Programmatically”

“Use Enumerated Data in Simulink Models”

Introduced in R2015a

removeEnumeral

Package: Simulink.data.dictionary

Remove enumeration member from enumerated data type definition in data dictionary

Syntax

```
removeEnumeral(typeObj,memberNum)
```

Description

`removeEnumeral(typeObj,memberNum)` removes an enumeration member from the enumerated type definition stored by `typeObj`, a `Simulink.data.dictionary.EnumTypeDefinition` object.

Examples

Programmatically Create Enumerated Type Definition in Data Dictionary

Create an object that can store the definition of an enumerated type. By default, the new type defines a single enumeration member `enum1` with underlying integer value 0.

```
myColors = Simulink.data.dictionary.EnumTypeDefinition
myColors =
    Simulink.data.dictionary.EnumTypeDefinition
        enum1
```

Add some enumeration members to the definition of the type.

```
appendEnumeral(myColors,'Orange',1,'')
appendEnumeral(myColors,'Black',2,'')
appendEnumeral(myColors,'Cyan',3,'')
myColors
myColors =
    Simulink.data.dictionary.EnumTypeDefinition
        enum1
        Orange
        Black
        Cyan
```

Remove the default enumeration member `enum1`. Since `enum1` is the first enumeration member in the list, identify it with index 1.

```
removeEnumeral(myColors,1)
myColors
myColors =
```

```
Simulink.data.dictionary.EnumTypeDefinition
    Orange
    Black
    Cyan
```

Customize the enumerated type by configuring the properties of the object representing it.

```
myColors.Description = 'These are my favorite colors.';
myColors.DefaultValue = 'Cyan';
myColors.HeaderFile = 'colorsType.h';
```

Open the data dictionary `myDictionary_ex_API.sldd` and represent it with a `Simulink.data.Dictionary` object named `myDictionaryObj`.

```
myDictionaryObj = Simulink.data.dictionary.open('myDictionary_ex_API.sldd');
```

Import the object that defines the enumerated type `myColors` to the dictionary.

```
importFromBaseWorkspace(myDictionaryObj, 'varList', {'myColors'});
```

Input Arguments

typeObj — Target enumerated type definition

`Simulink.data.dictionary.EnumTypeDefinition` object

Target enumerated type definition, specified as a `Simulink.data.dictionary.EnumTypeDefinition` object.

memberNum — Index of target enumeration member

integer

Index of target enumeration member, specified as an integer.

The first enumeration member in an enumerated type definition has index 1. For example, suppose an enumerated type `BasicColors` has this definition:

```
myColors =
    Simulink.data.dictionary.EnumTypeDefinition
        Orange
        Black
        Cyan
```

To remove the enumeration member `Black`, specify `memberNum` as 2. To remove the enumeration member `Cyan`, specify 3.

Do not specify `memberNum` using the integer value underlying an enumeration member. The integer value underlying the member is not equivalent to the index of the member.

Example: 3

```
Data Types: single | int8 | int16 | int32 | int64 | uint8 | uint16 | uint32 | uint64 | double
```

Alternatives

You can use Model Explorer to remove enumeration members from the enumerated data type represented by a `Simulink.data.dictionary.EnumTypeDefinition` object.

See Also

`Simulink.data.dictionary.EnumTypeDefinition | appendEnumeral`

Topics

“Store Data in Dictionary Programmatically”

“Use Enumerated Data in Simulink Models”

Introduced in R2015a

filepath

Package: Simulink.data

Full path and file name of data dictionary

Syntax

```
dictionaryFilePath = filepath(dictionaryObj)
```

Description

`dictionaryFilePath = filepath(dictionaryObj)` returns the full path and file name of the data dictionary `dictionaryObj`, a `Simulink.data.Dictionary` object.

Examples

Return Path of Data Dictionary File

Open the data dictionary `myDictionary_ex_API.sldd` and represent it with a `Simulink.data.Dictionary` object named `myDictionaryObj`.

```
myDictionaryObj = Simulink.data.dictionary.open('myDictionary_ex_API.sldd');
```

Return the full path of `myDictionary_ex_API.sldd` and assign it to variable `myDictionaryFilePath`.

```
myDictionaryFilePath = filepath(myDictionaryObj)
```

```
myDictionaryFilePath =
```

```
C:\Users\jsmith\myDictionary_ex_API.sldd
```

Input Arguments

dictionaryObj — Target data dictionary

`Simulink.data.Dictionary` object

Target data dictionary, specified as a `Simulink.data.Dictionary` object. Before you use this function, represent the target dictionary with a `Simulink.data.Dictionary` object by using, for example, the `Simulink.data.dictionary.create` or `Simulink.data.dictionary.open` function.

See Also

`Simulink.data.Dictionary`

Topics

“Store Data in Dictionary Programmatically”

Introduced in R2015a

Simulink.data.dictionary.getOpenDictionaryPaths

Return file names and paths of open data dictionaries

Syntax

```
openDDs = Simulink.data.dictionary.getOpenDictionaryPaths  
openDDs = Simulink.data.dictionary.getOpenDictionaryPaths(dictFileName)
```

Description

`openDDs = Simulink.data.dictionary.getOpenDictionaryPaths` returns the file names and paths of all data dictionaries that are open. For example, a data dictionary is open if you create objects, such as `Simulink.data.Dictionary`, that refer to the dictionary. If you open two or more dictionaries that have the same file name but different file paths, this function returns multiple file paths.

Before executing commands and functions that cannot operate when dictionaries are open, use this function to identify open dictionaries so that you can close them. For example, when you run parallel simulations as described in “Sweep Variant Control Using Parallel Simulation”, this function helps you identify open dictionaries before executing the command `Simulink.data.dictionary.cleanupWorkerCache`.

`openDDs = Simulink.data.dictionary.getOpenDictionaryPaths(dictFileName)` returns the file paths of data dictionaries that have the file name `dictFileName`. If you open two or more dictionaries that have the same file name but different file paths, you can use this syntax to return all of the file paths.

Examples

Identify and Close All Open Data Dictionaries

Open, identify, and close a data dictionary. After you close the connections to the dictionary, you can use commands and functions, such as `Simulink.data.dictionary.cleanupWorkerCache`, that cannot operate when dictionaries are open.

At the command prompt, open a data dictionary by creating a `Simulink.data.Dictionary` object that refers to the dictionary.

```
dictObj = Simulink.data.dictionary.open('sldemo_fuelsys_dd.sldd');
```

Display the dictionary in the Model Explorer

```
show(dictObj)
```

Identify all of the dictionaries that are open.

```
openDDs = Simulink.data.dictionary.getOpenDictionaryPaths;
```

The file path of the dictionary that you opened, `sldemo_fuelsys_dd.sldd`, appears in the cell array of character vectors `openDDs`.

Close the connection from the Model Explorer to the dictionary.

```
hide(dictObj)
```

The dictionary no longer appears as a node in the **Model Hierarchy** pane of the Model Explorer.

Close the connection from the `Simulink.data.Dictionary` object to the dictionary.

```
close(dictObj)  
clear dictObj
```

Input Arguments

dictFileName — File name of target data dictionary or dictionaries

character vector

File name of target data dictionary or dictionaries, specified as a character vector. Use the file extension `sldd`.

Example: `'myDict.sldd'`

Data Types: `char`

Output Arguments

openDDs — File names and paths of open data dictionaries

cell array of character vectors

File names and paths of open data dictionaries, returned as a cell array of character vectors.

Tips

A data dictionary is open if any of these conditions are true:

- The dictionary appears as a node in the **Model Hierarchy** pane of the Model Explorer. To close this connection to the dictionary, right-click the node in Model Explorer and select **Close**. Alternatively, use the `hide` method of a `Simulink.data.Dictionary` object.
- You created an object of any of these classes that refer to the dictionary:
 - `Simulink.data.Dictionary`
 - `Simulink.data.dictionary.Section`
 - `Simulink.data.dictionary.Entry`

To close these connections to the dictionary, use the `close` method of the `Simulink.data.Dictionary` object or clear the object. Clear the `Simulink.data.dictionary.Section` and `Simulink.data.dictionary.Entry` objects.

- A model that is linked to the dictionary is open. To close this connection to the dictionary, close the model.

See Also

`Simulink.data.Dictionary` | `Simulink.data.dictionary.setupWorkerCache` | `Simulink.data.dictionary.cleanupWorkerCache` | `Simulink.data.dictionary.closeAll`

Topics

“Store Data in Dictionary Programmatically”

Introduced in R2016a

getSection

Package: Simulink.data

Return Simulink.data.dictionary.Section object to represent data dictionary section

Syntax

```
sectionObj = getSection(dictionaryObj,sectionName)
```

Description

sectionObj = getSection(dictionaryObj,sectionName) returns a Simulink.data.dictionary.Section object representing one section, sectionName, of a data dictionary dictionaryObj, a Simulink.data.Dictionary object.

When you access the **Embedded Coder** section of a data dictionary, getSection returns a coder.Dictionary object representing the Embedded Coder Dictionary in the data dictionary.

Examples

Create New Data Dictionary Section Object

Open the data dictionary myDictionary_ex_API.sldd and represent it with a Simulink.data.Dictionary object named myDictionaryObj.

```
myDictionaryObj = Simulink.data.dictionary.open('myDictionary_ex_API.sldd');
```

Represent the Design Data section of the data dictionary myDictionary_ex_API.sldd with a Simulink.data.dictionary.Section object named dDataSectObj.

```
dDataSectObj = getSection(myDictionaryObj, 'Design Data')
```

```
dDataSectObj =
```

```
    Section with properties:
```

```
        Name: 'Design Data'
```

Input Arguments

dictionaryObj — Data dictionary containing target section

Simulink.data.Dictionary object

Data dictionary containing target section, specified as a Simulink.data.Dictionary object. Before you use this function, represent the dictionary with a Simulink.data.Dictionary object by using, for example, the Simulink.data.dictionary.create or Simulink.data.dictionary.open function.

sectionName — Name of target data dictionary section

character vector

Name of target data dictionary section, specified as a character vector.

Example: 'Design Data'

Example: 'Configurations'

Example: 'EmbeddedCoder'

Data Types: char

See Also

`Simulink.data.Dictionary` | `Simulink.data.dictionary.Section`

Topics

“Store Data in Dictionary Programmatically”

Introduced in R2015a

hide

Package: Simulink.data

Remove data dictionary from Model Explorer

Syntax

```
hide(dictionaryObj)
```

Description

`hide(dictionaryObj)` removes the data dictionary `dictionaryObj` from the **Model Hierarchy** pane of Model Explorer. The target dictionary no longer appears as a node in the model hierarchy tree. Use this function when you are finished working with a data dictionary and want to reduce clutter in the Model Explorer.

Examples

Hide Data Dictionary from Model Explorer

Open the data dictionary `myDictionary_ex_API.sldd` and represent it with a `Simulink.data.Dictionary` object named `myDictionaryObj`.

```
myDictionaryObj = Simulink.data.dictionary.open('myDictionary_ex_API.sldd');
```

Open Model Explorer and display the new data dictionary as the selected tree node in the **Model Hierarchy** pane.

```
show(myDictionaryObj)
```

With Model Explorer open, at the MATLAB command prompt, call the `hide` function to observe the removal of `myDictionary_ex_API.sldd` from the model hierarchy tree.

```
hide(myDictionaryObj)
```

Input Arguments

dictionaryObj — Target data dictionary

`Simulink.data.Dictionary` object

Target data dictionary, specified as a `Simulink.data.Dictionary` object. Before you use this function, represent the target dictionary with a `Simulink.data.Dictionary` object by using, for example, the `Simulink.data.dictionary.create` or `Simulink.data.dictionary.open` function.

Tips

- To add a data dictionary as a node in the model hierarchy tree in Model Explorer, use the `show` function or use the interface to open and view the dictionary in Model Explorer.

- The hide function does not affect the content of the target dictionary.

Alternatives

You can remove a data dictionary from the **Model Hierarchy** pane of Model Explorer by right-clicking the dictionary tree node and selecting **Close**.

See Also

`Simulink.data.Dictionary` | show

Topics

“Store Data in Dictionary Programmatically”

Introduced in R2015a

importEnumTypes

Package: Simulink.data

Import enumerated type definitions to data dictionary

Syntax

```
importedTypes = importEnumTypes(dictionaryObj,targetTypes)
[importedTypes,importFailures] = importEnumTypes(dictionaryObj,targetTypes)
```

Description

`importedTypes = importEnumTypes(dictionaryObj,targetTypes)` imports to the data dictionary `dictionaryObj` the definitions of one or more enumerated types `targetTypes`. `importEnumTypes` does not import MATLAB variables created using enumerated types but instead, in support of those variables, imports the definitions of the types. The target data dictionary stores the definition of a successfully imported type as an entry. This syntax returns a list of the names of successfully imported types. `importEnumTypes` saves changes made to the target dictionary, so before you use `importEnumTypes`, confirm that unsaved changes are acceptable.

`[importedTypes,importFailures] = importEnumTypes(dictionaryObj,targetTypes)` additionally returns a list of any target types that were not successfully imported. You can inspect the list to determine the reason for each failure.

Examples

Import Enumerated Data to Data Dictionary

Create a data dictionary `myNewDictionary.sldd` in your current working folder and a `Simulink.data.Dictionary` object representing the new data dictionary. Assign the object to the variable `myDictionaryObj`.

```
myDictionaryObj = Simulink.data.dictionary.create('myNewDictionary.sldd');
```

Run the script in the MATLAB file `myDataEnum_ex_API.m`. The file defines an enumerated type named `InstrumentTypes` using the `Simulink.defineIntEnumType` function and creates three variables based on the new type. Then, import the new variables from the base workspace to `myDictionary_ex_API.sldd`.

```
myDataEnum_ex_API
importFromBaseWorkspace(myDictionaryObj,'varList',...
{'firstEnumVariable','secondEnumVariable','thirdEnumVariable'});
```

Clear the imported variables from the base workspace. Before you can import an enumerated data type definition to the target data dictionary, you must clear the base workspace of any variables created using the target type.

```
clear firstEnumVariable
clear secondEnumVariable
clear thirdEnumVariable
```

Import the data type definition to `myDictionary_ex_API.slidd`.

```
importEnumTypes(myDictionaryObj, {'InstrumentTypes'})

ans =

    className: 'InstrumentTypes'
    renamedFiles: {}
```

Input Arguments

dictionaryObj — Target data dictionary

`Simulink.data.Dictionary` object

Target data dictionary, specified as a `Simulink.data.Dictionary` object. Before you use this function, represent the target dictionary with a `Simulink.data.Dictionary` object by using, for example, the `Simulink.data.dictionary.create` or `Simulink.data.dictionary.open` function.

targetTypes — Enumerated type definitions to import

cell array of character vectors | string array

Enumerated type definitions to import, specified as a cell array of character vectors or a string array. If any target types are defined using `classdef` blocks in MATLAB files or P-files, the files must be available on your MATLAB path so that `importEnumTypes` can disable them.

Example: `{'myEnumType'}`

Example: `{'myFirstEnumType', 'mySecondEnumType', 'myThirdEnumType'}`

Data Types: `cell`

Output Arguments

importedTypes — Target types successfully imported

array of structures

Target enumerated type definitions successfully imported, returned as an array of structures. Each structure in the array represents one imported type. The `className` field of each structure identifies a type by name and the `renamedFiles` field identifies any renamed MATLAB files or P-files.

importFailures — Target types not imported

array of structures

Enumerated type definitions targeted but not imported, returned as an array of structures. Each structure in the array represents one type not imported. The `className` field of each structure identifies a type by name and the `reason` field explains the failure.

Tips

- Before you can import an enumerated data type definition to a data dictionary, you must clear the base workspace of any variables created using the target type.
- You can define an enumerated type using a `classdef` block in a MATLAB file or a P-file. `importEnumTypes` imports type definitions directly from these files if you specify the names of

the types to import using the input argument `targetTypes` and if the files defining the types are on your MATLAB path.

- To avoid conflicting definitions for imported types, `importEnumTypes` renders MATLAB files or P-files ineffective by appending `.save` to their names. The `.save` extensions cause variables to rely on the definitions in the target data dictionary and not on the definitions in the files. You can remove the `.save` extensions to restore the files to their original state.
- You can use `importEnumTypes` to import enumerated types defined using the `Simulink.defineIntEnumType` function. Because such types are not defined using MATLAB files or P-files, `importEnumTypes` does not rename any files.
- Use the function `Simulink.findVars` to generate a list of the enumerated types that are used by a model. Then, use the list with `importEnumTypes` to import the definitions of the types to a data dictionary. See “Enumerations in Data Dictionary” for more information.

See Also

`Simulink.data.Dictionary` | `importFromBaseWorkspace`

Topics

“Enumerations in Data Dictionary”

“Store Data in Dictionary Programmatically”

Introduced in R2015a

importFromBaseWorkspace

Package: Simulink.data

Import base workspace variables to data dictionary

Syntax

```
importedVars = importFromBaseWorkspace(dictionaryObj)
importedVars = importFromBaseWorkspace(dictionaryObj,Name,Value)
[importedVars,existingVars] = importFromBaseWorkspace(____)
```

Description

`importedVars = importFromBaseWorkspace(dictionaryObj)` imports all variables from the MATLAB base workspace to the data dictionary `dictionaryObj` without overwriting existing entries in the dictionary. If any base workspace variables are already in the dictionary, the function present a warning and a list.

This syntax returns a list of names of the successfully imported variables. A variable is considered successfully imported only if `importFromBaseWorkspace` assigns the value of the variable to the corresponding entry in the target data dictionary.

`importedVars = importFromBaseWorkspace(dictionaryObj,Name,Value)` imports base workspace variables to a data dictionary, with additional options specified by one or more `Name,Value` pair arguments.

`[importedVars,existingVars] = importFromBaseWorkspace(____)` additionally returns a list of variables that were not overwritten. Use this syntax if `existingVarsAction` is set to 'none', the default value, which prevents existing dictionary entries from being overwritten.

Examples

Import All Base Workspace Variables to Data Dictionary

In the MATLAB base workspace, create variables to import.

```
a = 'Char Variable';
myVariable = true;
fuelFlow = 324;
```

Open the data dictionary `myDictionary_ex_API.sldd` and represent it with a `Simulink.data.Dictionary` object named `myDictionaryObj`.

```
myDictionaryObj = Simulink.data.dictionary.open('myDictionary_ex_API.sldd');
```

Import all base workspace variables to the data dictionary and return a list of successfully imported variables. If any base workspace variables are already in `myDictionary_ex_API.sldd`, `importFromBaseWorkspace` presents a warning and a list of the affected variables.

```
importFromBaseWorkspace(myDictionaryObj);
```

```
Warning: The following variables were not imported because
they already exist in the dictionary:
    fuelFlow
```

Specify Variables to Import to Data Dictionary from Base Workspace

In the MATLAB base workspace, create variables to import.

```
b = 'Char Variable';
mySecondVariable = true;
airFlow = 324;
```

Open the data dictionary `myDictionary_ex_API.sldd` and represent it with a `Simulink.data.Dictionary` object named `myDictionaryObj`.

```
myDictionaryObj = Simulink.data.dictionary.open('myDictionary_ex_API.sldd');
```

Import only the new base workspace variables to the data dictionary.

```
importFromBaseWorkspace(myDictionaryObj, 'varList', ...
{'b', 'mySecondVariable', 'airFlow'});
```

Import Variables from Base Workspace and Overwrite Conflicts

In the MATLAB base workspace, create a variable to import.

```
fuelFlow = 324;
```

Open the data dictionary `myDictionary_ex_API.sldd` and represent it with a `Simulink.data.Dictionary` object named `myDictionaryObj`. `myDictionary_ex_API.sldd` already contains an entry called `fuelFlow`.

```
myDictionaryObj = Simulink.data.dictionary.open('myDictionary_ex_API.sldd');
```

Import the variable `fuelFlow` and overwrite the corresponding entry in `myDictionary_ex_API.sldd`.

```
importFromBaseWorkspace(myDictionaryObj, 'varList', {'fuelFlow'}, ...
'existingVarsAction', 'overwrite');
```

`importFromBaseWorkspace` assigns the value of the base workspace variable `fuelFlow` to the value of the corresponding entry in `myDictionary_ex_API.sldd`.

Return Variables Not Imported to Data Dictionary from Base Workspace

Return a list of variables that are not imported from the MATLAB base workspace because they are already in the target data dictionary.

In the MATLAB base workspace, create variables to import.

```
fuelFlow = 324;
myNewVariable = 'This is a character vector.'
```

Open the data dictionary `myDictionary_ex_API.sldd` and represent it with a `Simulink.data.Dictionary` object named `myDictionaryObj`. `myDictionary_ex_API.sldd` already contains an entry called `fuelFlow`.

```
myDictionaryObj = Simulink.data.dictionary.open('myDictionary_ex_API.sldd');
```

Import the variables `fuelFlow` and `myNewVariable` to the data dictionary. Specify names for the output arguments of `importFromBaseWorkspace` to return the names of successfully and unsuccessfully imported variables.

```
[importedVars,existingVars] = importFromBaseWorkspace(myDictionaryObj,...
'varList',{'fuelFlow','myNewVariable'})
```

```
importedVars =
```

```
    'myNewVariable'
```

```
existingVars =
```

```
    'fuelFlow'
```

`importFromBaseWorkspace` does not import the variable `fuelFlow` because it is already in the target data dictionary.

Input Arguments

dictionaryObj — Target data dictionary

`Simulink.data.Dictionary` object

Target data dictionary, specified as a `Simulink.data.Dictionary` object. Before you use this function, represent the target dictionary with a `Simulink.data.Dictionary` object by using, for example, the `Simulink.data.dictionary.create` or `Simulink.data.dictionary.open` function.

Name-Value Pair Arguments

Specify optional comma-separated pairs of `Name`, `Value` arguments. `Name` is the argument name and `Value` is the corresponding value. `Name` must appear inside quotes. You can specify several name and value pair arguments in any order as `Name1,Value1,...,NameN,ValueN`.

Example: `'varList',{'fuelFlow'}, 'existingVarsAction','overwrite'` imports the variable `fuelFlow` and overwrites the corresponding entry in the data dictionary.

clearWorkspaceVars — Flag to clear base workspace of imported variables

`false` (default) | `true`

Flag to clear the base workspace of any successfully imported variables, specified as the comma-separated pair consisting of `'clearWorkspaceVars'` and `true` or `false`.

Example: `'clearWorkspaceVars',true`

Data Types: `logical`

existingVarsAction — Action to take for existing dictionary variables

`'none'` (default) | `'error'` | `'overwrite'`

Action to take for existing dictionary variables, specified as the comma-separated pair consisting of 'existingVarsAction' and 'none', 'error', or 'overwrite'.

If you specify 'none', `importFromBaseWorkspace` attempts to import target variables but does not import or make any changes to variables that are already in the data dictionary.

If you specify 'error', `importFromBaseWorkspace` returns an error, without importing any variables, if any target variables are already in the data dictionary.

If you specify 'overwrite', `importFromBaseWorkspace` imports all target variables and overwrites any variables that are already in the data dictionary.

Example: 'existingVarsAction','error'

Data Types: char

varList — Variables to import

cell array of character vectors | string array

Names of specific base workspace variables to import, specified as the comma-separated pair consisting of 'varList' and a cell array of character vectors or a string array. If you want to import only one variable, specify the name inside a cell array. If you do not specify 'varList', `importFromBaseWorkspace` imports all variables from the MATLAB base workspace.

Example: 'varList',{'a','myVariable','fuelFlow'}

Example: 'varList',{'fuelFlow'}

Data Types: cell

Output Arguments

importedVars — Successfully imported variables

cell array of character vectors

Names of successfully imported variables, returned as a cell array of character vectors. A variable is considered successfully imported only if `importFromBaseWorkspace` assigns the value of the variable to the corresponding entry in the target data dictionary.

existingVars — Existing variables that were not imported

cell array of character vectors

Names of target variables that were not imported due to their existence in the target data dictionary, returned as a cell array of character vectors. `existingVars` has content only if 'existingVarsAction' is set to 'none' which is also the default. In that case `importFromBaseWorkspace` imports only variables that are not already in the target data dictionary.

Tips

- `importFromBaseWorkspace` can import MATLAB variables created from enumerated data types but cannot import the definitions of the enumerated types. Use the `importEnumTypes` function to import enumerated data type definitions to a data dictionary. If you import variables of enumerated data types to a data dictionary but do not import the enumerated type definitions, the dictionary is less portable and might not function properly if used by someone else.

- If the value of a variable is a `timeseries` object (which a data dictionary cannot store) or a structure with fields identical to a `timeseries` object, `importFromBaseWorkspace` cannot import the variable.

Alternatives

- When you use the Simulink Editor to link a model to a data dictionary, you can choose to import model variables from the base workspace. See “Migrate Single Model to Use Dictionary” for more information.
- You can also use the Model Explorer window to drag-and-drop variables from the base workspace into a data dictionary.

See Also

`Simulink.data.Dictionary` | `importEnumTypes`

Topics

“Store Data in Dictionary Programmatically”

Introduced in R2015a

listEntry

Package: Simulink.data

List data dictionary entries

Syntax

```
listEntry(dictionaryObj)
listEntry(dictionaryObj,Name,Value)
```

Description

`listEntry(dictionaryObj)` displays in the MATLAB Command Window a table of information about all the entries in the data dictionary `dictionaryObj`, a `Simulink.data.Dictionary` object. The displayed information includes the name of each entry, the name of the section containing each entry, the status of each entry, the date and time each entry was last modified, the last user name to modify each entry, and the class of the value each entry contains. By default, the function sorts the list of entries alphabetically by entry name.

`listEntry(dictionaryObj,Name,Value)` displays the entries in a data dictionary with additional options specified by one or more `Name,Value` pair arguments.

To return the value of a data dictionary entry at the command prompt, use the `getValue` method of a `Simulink.data.dictionary.Entry` object. See “Store Data in Dictionary Programmatically”.

Examples

List All Entries in Data Dictionary

Represent the data dictionary `sldemo_fuelsys_dd_controller.sldd` with a `Simulink.data.Dictionary` object named `myDictionaryObj`.

```
myDictionaryObj = Simulink.data.dictionary.open('sldemo_fuelsys_dd_controller.sldd');
```

List all the entries in the data dictionary.

```
listEntry(myDictionaryObj)
```

Sort List of Data Dictionary Entries in Descending Order

Represent the data dictionary `sldemo_fuelsys_dd_controller.sldd` with a `Simulink.data.Dictionary` object named `myDictionaryObj`.

```
myDictionaryObj = Simulink.data.dictionary.open('sldemo_fuelsys_dd_controller.sldd');
```

List all the entries in the data dictionary and sort the list in descending order by entry name.

```
listEntry(myDictionaryObj, 'Ascending', false)
```

Filter List of Data Dictionary Entries by Name

Represent the data dictionary `sldemo_fuelsys_dd_controller.sldd` with a `Simulink.data.Dictionary` object named `myDictionaryObj`.

```
myDictionaryObj = Simulink.data.dictionary.open('sldemo_fuelsys_dd_controller.sldd');
```

List only the entries in the data dictionary whose names begin with `max`.

```
listEntry(myDictionaryObj, 'Name', 'max*')
```

Sort List of Data Dictionary Entries by Time of Modification

Represent the data dictionary `sldemo_fuelsys_dd_controller.sldd` with a `Simulink.data.Dictionary` object named `myDictionaryObj`.

```
myDictionaryObj = Simulink.data.dictionary.open('sldemo_fuelsys_dd_controller.sldd');
```

List all the entries in the dictionary and sort the list by the date and time each entry was last modified.

```
listEntry(myDictionaryObj, 'SortBy', 'LastModified')
```

Input Arguments

`dictionaryObj` — Target data dictionary

`Simulink.data.Dictionary` object

Target data dictionary, specified as a `Simulink.data.Dictionary` object. Before you use this function, represent the target dictionary with a `Simulink.data.Dictionary` object by using, for example, the `Simulink.data.dictionary.create` or `Simulink.data.dictionary.open` function.

Name-Value Pair Arguments

Specify optional comma-separated pairs of `Name`, `Value` arguments. `Name` is the argument name and `Value` is the corresponding value. `Name` must appear inside quotes. You can specify several name and value pair arguments in any order as `Name1, Value1, ..., NameN, ValueN`.

Example: `'SortBy', 'LastModified'` sorts the entries in the data dictionary by the date and time each entry was last modified.

Ascending — Sort order of list

`true` (default) | `false`

Sort order of the list of data dictionary entries, specified as the comma-separated pair consisting of `'Ascending'` and `true` or `false`. If you specify `false`, `listEntry` sorts the list in descending order.

Example: `'Ascending', false`

Data Types: `logical`

Class — Criteria to filter list by class

character vector

Criteria to filter the list of data dictionary entries by class, specified as the comma-separated pair consisting of 'Class' and a character vector identifying a valid class. The function lists only entries whose values are of the specified class.

Example: 'Class', 'Simulink.Parameter'

Data Types: char

LastModifiedBy – Criteria to filter list by user name of last modifier

character vector

Criteria to filter the list of data dictionary entries by the user name of the last user to modify each entry, specified as the comma-separated pair consisting of 'LastModifiedBy' and a character vector identifying the specified user name. The function lists only entries that were last modified by the specified user name.

Example: 'LastModifiedBy', 'jsmith'

Data Types: char

Limit – Maximum number of entries to list

integer

Maximum number of entries to list, specified as the comma-separated pair consisting of 'Limit' and an integer. The function lists up to the specified number of entries starting from the top of the sorted and filtered list.

Example: 'Limit', 9

Data Types: double

Name – Criteria to filter list by entry name

character vector

Criteria to filter the list of data dictionary entries by entry name, specified as the comma-separated pair consisting of 'Name' and a character vector defining the filter criteria. You can use an asterisk character, *, as a wildcard to represent any number of characters. The function lists only entries whose names match the filter criteria.

Example: 'Name', 'fuelFlow'

Example: 'Name', 'fuel*'

Data Types: char

Section – Criteria to filter list by data dictionary section

character vector

Criteria to filter the list of data dictionary entries by section, specified as the comma-separated pair consisting of 'Section' and a character vector identifying the target section. The function lists only entries that are contained in the target section.

Example: 'Section', 'Design Data'

SortBy – Flag to sort list by specific property

'Name' (default) | 'Section' | 'LastModified' | 'LastModifiedBy'

Flag to sort the list of data dictionary entries by a specific property, specified as the comma-separated pair consisting of 'SortBy' and a character vector identifying a property in the list of entries. Valid properties include 'Name', 'Section', 'LastModified', and 'LastModifiedBy'.

Example: 'SortBy','LastModifiedBy'

See Also

`Simulink.data.Dictionary` | `Simulink.data.dictionary.Entry` | `evalin`

Topics

“Store Data in Dictionary Programmatically”

“What Is a Data Dictionary?”

Introduced in R2015a

Simulink.data.dictionary.open

Open data dictionary for editing

Syntax

```
dictionaryObj = Simulink.data.dictionary.open(dictionaryFile)
```

Description

`dictionaryObj = Simulink.data.dictionary.open(dictionaryFile)` opens the specified data dictionary and returns a `Simulink.data.Dictionary` object representing an existing data dictionary identified by its file name and, optionally, file path with `dictionaryFile`.

Make sure any dictionaries referenced by the target dictionary are on the MATLAB path.

Examples

Open Existing Data Dictionary

Open the data dictionary `myDictionary_ex_API.sldd` and represent it with a `Simulink.data.Dictionary` object named `myDictionaryObj`.

```
myDictionaryObj = Simulink.data.dictionary.open('myDictionary_ex_API.sldd')
```

```
myDictionaryObj =
```

```
Dictionary with properties:
```

```
    DataSources: {'myRefDictionary_ex_API.sldd'}  
    HasUnsavedChanges: 0  
    NumberOfEntries: 4
```

Input Arguments

dictionaryFile — Target data dictionary

character vector

Target data dictionary, specified as a character vector containing the file name and, optionally, path of the dictionary. If you do not specify a path, `Simulink.data.dictionary.open` searches the MATLAB path for the specified file. `Simulink.data.dictionary.open` also supports paths specified relative to the MATLAB working folder.

Example: `'myDictionary_ex_API.sldd'`

Example: `'C:\Users\jsmith\myDictionary_ex_API.sldd'`

Example: `'..\myOtherDictionary.sldd'`

Data Types: char

See Also

`Simulink.data.Dictionary` | `Simulink.data.dictionary.create` | `show`

Topics

“Store Data in Dictionary Programmatically”

Introduced in R2015a

removeDataSource

Package: Simulink.data

Remove reference data dictionary from parent data dictionary

Syntax

```
removeDataSource(dictionaryObj, refDictionaryFile)
```

Description

`removeDataSource(dictionaryObj, refDictionaryFile)` removes a referenced data dictionary, `refDictionaryFile`, from a parent dictionary `dictionaryObj`, a `Simulink.data.Dictionary` object.

The parent dictionary no longer contains the entries that are defined in the referenced dictionary.

Examples

Remove Referenced Data Dictionary from Parent Data Dictionary

Open the data dictionary `myDictionary_ex_API.sldd` and represent it with a `Simulink.data.Dictionary` object named `myDictionaryObj`. The `DataSources` property of `myDictionaryObj` indicates `myDictionary_ex_API.sldd` references `myRefDictionary_ex_API.sldd`.

```
myDictionaryObj = Simulink.data.dictionary.open('myDictionary_ex_API.sldd')
```

```
myDictionaryObj =
```

```
Dictionary with properties:
```

```
    DataSources: {'myRefDictionary_ex_API.sldd'}
    HasUnsavedChanges: 0
    NumberOfEntries: 4
```

Remove `myRefDictionary_ex_API.sldd` from `myDictionary_ex_API.sldd`.

```
removeDataSource(myDictionaryObj, 'myRefDictionary_ex_API.sldd');
```

View the properties of the `Simulink.data.Dictionary` object `myDictionaryObj`, which represents the parent data dictionary. The `DataSources` property confirms the removal of `myRefDictionary_ex_API.sldd`.

```
myDictionaryObj
```

```
myDictionaryObj =
```

```
Dictionary with properties:
```

```
    DataSources: {0x1 cell}
```

```
HasUnsavedChanges: 1  
NumberOfEntries: 3
```

Input Arguments

dictionaryObj — Parent data dictionary

Simulink.data.Dictionary object

Parent data dictionary, specified as a Simulink.data.Dictionary object. Before you use this function, represent the target dictionary with a Simulink.data.Dictionary object by using, for example, the Simulink.data.dictionary.create or Simulink.data.dictionary.open function.

refDictionaryFile — File name of referenced data dictionary

character vector

File name of referenced data dictionary, specified as a character vector that includes the .sldd extension. The data dictionary file must be on your MATLAB path.

Example: 'myRefDictionary_ex_API.sldd'

Data Types: char

Alternatives

You can use Model Explorer to manage reference dictionaries. See “Partition Dictionary Data Using Referenced Dictionaries” for more information.

See Also

Simulink.data.Dictionary | addDataSource

Topics

“Store Data in Dictionary Programmatically”

Introduced in R2015a

saveChanges

Package: Simulink.data

Save changes to data dictionary

Syntax

```
saveChanges(dictionaryObj)
```

Description

`saveChanges(dictionaryObj)` saves all changes made to a data dictionary `dictionaryObj`, a `Simulink.data.Dictionary` object. `saveChanges` also saves changes made to referenced data dictionaries. The previous states of the target dictionary and its referenced dictionaries are permanently lost.

Examples

Save Changes to Data Dictionary

Create a new data dictionary `myNewDictionary.sldd` and represent the Design Data section with a `Simulink.data.dictionary.Section` object named `dDataSectObj`.

```
myDictionaryObj = Simulink.data.dictionary.create('myNewDictionary.sldd')  
dDataSectObj = getSection(myDictionaryObj, 'Design Data');
```

```
myDictionaryObj =
```

```
data dictionary with properties:
```

```
    DataSources: {0x1 cell}  
    HasUnsavedChanges: 0  
    NumberOfEntries: 0
```

Change `myNewDictionary.sldd` by adding an entry named `myNewEntry` with value 237. View the `HasUnsavedChanges` property of `myDictionaryObj` to confirm a change was made.

```
addEntry(dDataSectObj, 'myNewEntry', 237);  
myDictionaryObj
```

```
myDictionaryObj =
```

```
Dictionary with properties:
```

```
    DataSources: {0x1 cell}  
    HasUnsavedChanges: 1  
    NumberOfEntries: 1
```

Save all changes to `myNewDictionary.sldd`. The `HasUnsavedChanges` property of `myDictionaryObj` indicates changes were saved.

```
saveChanges(myDictionaryObj)
myDictionaryObj

myDictionaryObj =

    Dictionary with properties:
        DataSources: {0x1 cell}
        HasUnsavedChanges: 0
        NumberOfEntries: 1
```

Input Arguments

dictionaryObj — Target data dictionary

Simulink.data.Dictionary object

Target data dictionary, specified as a Simulink.data.Dictionary object. Before you use this function, represent the target dictionary with a Simulink.data.Dictionary object by using, for example, the Simulink.data.dictionary.create or Simulink.data.dictionary.open function.

Alternatives

You can use Model Explorer to save changes to a data dictionary by right-clicking on the dictionary tree node in the **Model Hierarchy** pane and selecting **Save Changes**.

See Also

Simulink.data.Dictionary | discardChanges

Topics

“Store Data in Dictionary Programmatically”

Introduced in R2015a

addEntry

Package: Simulink.data.dictionary

Add new entry to data dictionary section

Syntax

```
addEntry(sectionObj,entryName,entryValue)
entryObj = addEntry(sectionObj,entryName,entryValue)
```

Description

`addEntry(sectionObj,entryName,entryValue)` adds an entry, with name `entryName` and value `entryValue`, to the data dictionary section `sectionObj`, a `Simulink.data.dictionary.Section` object.

`entryObj = addEntry(sectionObj,entryName,entryValue)` returns a `Simulink.data.dictionary.Entry` object representing the newly added data dictionary entry.

Examples

Add Entry to Design Data Section of Data Dictionary

Represent the Design Data section of the data dictionary `myDictionary_ex_API.sldd` with a `Simulink.data.dictionary.Section` object named `dDataSectObj`.

```
myDictionaryObj = Simulink.data.dictionary.open('myDictionary_ex_API.sldd');
dDataSectObj = getSection(myDictionaryObj,'Design Data');
```

Add an entry to the Design Data section of `myDictionary_ex_API.sldd` an entry `myNewEntry` with value 237.

```
addEntry(dDataSectObj,'myNewEntry',237)
```

Add New Simulink.Parameter Object to Data Dictionary

Represent the Design Data section of the data dictionary `myDictionary_ex_API.sldd` with a `Simulink.data.dictionary.Section` object named `dDataSectObj`.

```
myDictionaryObj = Simulink.data.dictionary.open('myDictionary_ex_API.sldd');
dDataSectObj = getSection(myDictionaryObj,'Design Data');
```

Add an entry to the Design Data section of `myDictionary_ex_API.sldd`. Name the new entry `myNewParam` and assign a `Simulink.Parameter` object to the value.

```
addEntry(dDataSectObj,'myNewParam',Simulink.Parameter)
```

The expression `Simulink.Parameter` constructs a new `Simulink.Parameter` object, and the `addEntry` function assigns the object to the value of the new data dictionary entry `myNewParam`.

Input Arguments

sectionObj — Target data dictionary section

`Simulink.data.dictionary.Section` object

Target data dictionary section, specified as a `Simulink.data.dictionary.Section` object. Before you use this function, represent the target section with a `Simulink.data.dictionary.Section` object by using, for example, the `getSection` function.

entryName — Name of new data dictionary entry

character vector

Name of new data dictionary entry, specified as a character vector.

Example: `'myNewEntry'`

Data Types: `char`

entryValue — Value of new data dictionary entry

MATLAB expression

Value of new data dictionary entry, specified as a MATLAB expression that returns any valid data dictionary content.

Example: `27.5`

Example: `myBaseWorkspaceVariable`

Example: `Simulink.Parameter`

Tips

- `addEntry` returns an error if the entry name you specify with `entryName` is already the name of an entry in the target data dictionary section or in the same section of any referenced dictionaries.

Alternatives

You can use Model Explorer to add entries to a data dictionary in the same way you can use it to add variables to a model workspace or the base workspace.

See Also

`Simulink.data.dictionary.Section` | `Simulink.data.dictionary.Entry` | `assignin`

Topics

“Store Data in Dictionary Programmatically”

Introduced in R2015a

assignin

Package: Simulink.data.dictionary

Assign value to data dictionary entry

Syntax

```
assignin(sectionObj,entryName,entryValue)
```

Description

`assignin(sectionObj,entryName,entryValue)` assigns the value `entryValue` to the data dictionary entry `entryName` in the data dictionary section `sectionObj`, a `Simulink.data.dictionary.Section` object. If an entry with the specified name is not in the target section, `assignin` creates the entry with the specified name and value.

If an entry with the name specified by input argument `entryName` is not defined in the target data dictionary section but is defined in a referenced dictionary, `assignin` does not create a new entry in the target section but operates on the entry in the referenced dictionary.

To programmatically access variables for the purpose of sweeping block parameter values, consider using `Simulink.SimulationInput` objects instead of modifying the variables through the programmatic interface of the data dictionary. See “Optimize, Estimate, and Sweep Block Parameter Values”.

Examples

Assign Value to Data Dictionary Entry

Assign a value to a data dictionary entry by operating on a `Simulink.data.dictionary.Section` object.

Represent the Design Data section of the data dictionary `myDictionary_ex_API.slidd` with a `Simulink.data.dictionary.Section` object named `dDataSectObj`.

```
myDictionaryObj = Simulink.data.dictionary.open('myDictionary_ex_API.slidd');  
dDataSectObj = getSection(myDictionaryObj,'Design Data');
```

Assign the value 237 to an entry `myAssignedEntry` in the data dictionary `myDictionary_ex_API.slidd`. If an entry named `myAssignedEntry` is not in `myDictionary_ex_API.slidd`, create it.

```
assignin(dDataSectObj,'myAssignedEntry',237)
```

Input Arguments

sectionObj — Target data dictionary section

`Simulink.data.dictionary.Section` object

Target data dictionary section, specified as a `Simulink.data.dictionary.Section` object. Before you use this function, represent the target section with a `Simulink.data.dictionary.Section` object by using, for example, the `getSection` function.

entryName — Name of target data dictionary entry

character vector

Name of target data dictionary entry, specified as a character vector. If a matching entry does not already exist, the function creates a new entry using the specified name.

Example: 'myEntry'

Data Types: char

entryValue — Value to assign to data dictionary entry

MATLAB expression

Value to assign to data dictionary entry, specified as a MATLAB expression that returns any valid data dictionary content.

Example: 27.5

Example: myBaseWorkspaceVariable

Example: Simulink.Parameter

Alternatives

You can use the Model Explorer window to view and change the values of data dictionary entries.

See Also

`Simulink.data.dictionary.Section | setValue`

Topics

“Store Data in Dictionary Programmatically”

Introduced in R2015a

deleteEntry

Package: Simulink.data.dictionary

Delete data dictionary entry

Syntax

```
deleteEntry(sectionObj,entryName)
deleteEntry(sectionObj,entryName,'DataSource',dictionaryName)
```

Description

`deleteEntry(sectionObj,entryName)` deletes a data dictionary entry `entryName` from the data dictionary section `sectionObj`, a `Simulink.data.dictionary.Section` object. If there are multiple entries with the specified name in a hierarchy of reference dictionaries, the function deletes all the entries. If you represent a data dictionary entry with one or more `Simulink.data.dictionary.Entry` objects and later delete the entry using the `deleteEntry` function, the objects remain with their `Status` property set to 'Deleted'.

`deleteEntry(sectionObj,entryName,'DataSource',dictionaryName)` deletes an entry that is defined in the data dictionary `DictionaryName`. Use this syntax to uniquely identify an entry that is defined more than once in a hierarchy of referenced data dictionaries.

Examples

Delete Entry from Data Dictionary Section

Represent the Design Data section of the data dictionary `myDictionary_ex_API.sldd` with a `Simulink.data.dictionary.Section` object named `dDataSectObj`. The Design Data section of `myDictionary_ex_API.sldd` already contains an entry named `fuelFlow`.

```
myDictionaryObj = Simulink.data.dictionary.open('myDictionary_ex_API.sldd');
dDataSectObj = getSection(myDictionaryObj,'Design Data');
```

Delete the entry `fuelFlow` from the data dictionary `myDictionary_ex_API.sldd`. `myDictionary_ex_API.sldd` no longer contains the `fuelFlow` entry.

```
deleteEntry(dDataSectObj,'fuelFlow')
```

Delete Entry from Reference Data Dictionary

Represent the Design Data section of the data dictionary `myDictionary_ex_API.sldd` with a `Simulink.data.dictionary.Section` object named `dDataSectObj`.

```
myDictionaryObj = Simulink.data.dictionary.open('myDictionary_ex_API.sldd');
dDataSectObj = getSection(myDictionaryObj,'Design Data');
```

Delete the entry `myRefEntry` from the data dictionary `myRefDictionary_ex_API.sldd`. `myDictionary_ex_API.sldd` references `myRefDictionary_ex_API.sldd`, and `myRefDictionary_ex_API.sldd` defines an entry `myRefEntry`.

```
deleteEntry(dDataSectObj, 'myRefEntry', 'DataSource', ...  
'myRefDictionary_ex_API.sldd')
```

Input Arguments

sectionObj — Target data dictionary section

Simulink.data.dictionary.Section object

Target data dictionary section, specified as a Simulink.data.dictionary.Section object. Before you use this function, represent the target section with a Simulink.data.dictionary.Section object by using, for example, the getSection function.

entryName — Name of target data dictionary entry

character vector

Name of target data dictionary entry, specified as a character vector.

Example: 'myEntry'

Data Types: char

dictionaryName — Name of data dictionary that defines target entry

character vector

File name of data dictionary that defines the target entry, specified as a character vector including the .sldd extension.

Example: 'mySubDictionary_ex_API.sldd'

Data Types: char

Alternatives

You can use the Model Explorer window to delete entries from a data dictionary in the same way you can delete variables from a model workspace or the base workspace.

See Also

Simulink.data.dictionary.Section | addEntry | Simulink.data.dictionary.Entry

Topics

“Store Data in Dictionary Programmatically”

Introduced in R2015a

evalin

Package: Simulink.data.dictionary

Evaluate MATLAB expression in data dictionary section

Syntax

```
returnValue = evalin(sectionObj,expression)
```

Description

`returnValue = evalin(sectionObj,expression)` evaluates a MATLAB expression in the data dictionary section `sectionObj` and returns the values returned by `expression`.

To programmatically access variables for the purpose of sweeping block parameter values, consider using `Simulink.SimulationInput` objects instead of modifying the variables through the programmatic interface of the data dictionary. See “Optimize, Estimate, and Sweep Block Parameter Values”.

Examples

List All Entries in Data Dictionary Section

Represent the Design Data section of the data dictionary `myDictionary_ex_API.sldd` with a `Simulink.data.dictionary.Section` object named `dDataSectObj`.

```
myDictionaryObj = Simulink.data.dictionary.open('myDictionary_ex_API.sldd');
dDataSectObj = getSection(myDictionaryObj,'Design Data');
```

Execute the `whos` command in the Design Data section of `myDictionary_ex_API.sldd`.

```
evalin(dDataSectObj,'whos')
```

| Name | Size | Bytes | Class | Attributes |
|-----------------|------|-------|--------------------|------------|
| fuelFlow | 1x1 | 8 | double | |
| myRefEntry | 1x1 | 1 | logical | |
| parameterGain37 | 1x1 | 112 | Simulink.Parameter | |

Input Arguments

sectionObj — Target data dictionary section

`Simulink.data.dictionary.Section` object

Target data dictionary section, specified as a `Simulink.data.dictionary.Section` object. Before you use this function, represent the target section with a `Simulink.data.dictionary.Section` object by using, for example, the `getSection` function.

expression — MATLAB expression to evaluate

character vector

MATLAB expression to evaluate, specified as a character vector.

Example: 'a = 5.3'

Example: 'whos'

Example: 'CurrentSpeed.Value = 290.73'

Data Types: char

Tips

- `evalin` allows you to treat a data dictionary section as a MATLAB workspace. You can think of entries contained in the section as workspace variables you can manipulate with MATLAB expressions.

See Also

`Simulink.data.dictionary.Section` | `Simulink.data.evalinGlobal`

Topics

“Store Data in Dictionary Programmatically”

Introduced in R2015a

exist

Package: Simulink.data.dictionary

Check existence of data dictionary entry

Syntax

```
doesExist = exist(sectionObj,entryName)
```

Description

`doesExist = exist(sectionObj,entryName)` determines if the data dictionary section `sectionObj` contains an entry by the name of `entryName` and returns an indication.

Examples

Determine if Data Dictionary Entry Exists

Determine if an entry exists in a data dictionary by searching for the name of the entry

Represent the Design Data section of the data dictionary `myDictionary_ex_API.sldd` with a `Simulink.data.dictionary.Section` object named `dDataSectObj`.

```
myDictionaryObj = Simulink.data.dictionary.open('myDictionary_ex_API.sldd');  
dDataSectObj = getSection(myDictionaryObj,'Design Data');
```

Determine if an entry `fuelFlow` exists in the Design Data section of `myDictionary_ex_API.sldd`.

```
exist(dDataSectObj,'fuelFlow')
```

```
ans =
```

```
1
```

Determine if an entry `myEntry` exists in the Design Data section of `myDictionary_ex_API.sldd`.

```
exist(dDataSectObj,'myEntry')
```

```
ans =
```

```
0
```

Input Arguments

sectionObj — Target data dictionary section

`Simulink.data.dictionary.Section` object

Target data dictionary section, specified as a `Simulink.data.dictionary.Section` object. Before you use this function, represent the target section with a `Simulink.data.dictionary.Section` object by using, for example, the `getSection` function.

entryName — Name of target entry

character vector

Name of target entry, specified as a character vector.

Example: 'myEntry'

Data Types: char

Output Arguments**doesExist — Indication of entry existence**

0 | 1

Indication of entry existence, returned as 0 if false and 1 if true.

Tips

- `exist` also determines if a matching entry exists in the same section of any referenced data dictionaries. For example, if `sectionObj` represents the Design Data section of a data dictionary `myDictionary_ex_API.sldd`, `exist` searches the Design Data section of `myDictionary_ex_API.sldd` and the Design Data sections of any dictionaries referenced by `myDictionary_ex_API.sldd`.

Alternatives

You can use Model Explorer to search a data dictionary for an entry.

See Also

`Simulink.data.dictionary.Section | find | Simulink.data.existsInGlobal`

Topics

“Store Data in Dictionary Programmatically”

Introduced in R2015a

exportToFile

Package: Simulink.data.dictionary

Export data dictionary entries from section to MAT-file or MATLAB file

Syntax

```
exportToFile(sectionObj, fileName)
```

Description

`exportToFile(sectionObj, fileName)` exports to a MAT or MATLAB file all the values of the entries contained in the data dictionary section `sectionObj`, a `Simulink.data.dictionary.Section` object. `exportToFile` exports the values of all entries, including those defined in referenced dictionaries.

Examples

Export Data Dictionary Entries to MAT or MATLAB Files

Represent the Design Data section of the data dictionary `myDictionary_ex_API.sldd` with a `Simulink.data.dictionary.Section` object named `dDataSectObj`. Represent the Configurations section of `myDictionary_ex_API.sldd` with an object named `configSectObj`.

```
myDictionaryObj = Simulink.data.dictionary.open('myDictionary_ex_API.sldd');  
dDataSectObj = getSection(myDictionaryObj, 'Design Data');  
configSectObj = getSection(myDictionaryObj, 'Configurations');
```

Export the entries from the Design Data section of `myDictionary_ex_API.sldd` to a MATLAB file in your current working folder.

```
exportToFile(dDataSectObj, 'myDictionaryDesignData.m')
```

Export the entries from the Configurations section of `myDictionary_ex_API.sldd` to a MAT-file in your current working folder.

```
exportToFile(configSectObj, 'myDictionaryConfigurations.mat')
```

```
Exported 1 entries from scope 'Configurations'  
to MAT-file myDictionaryConfigurations.mat.
```

Input Arguments

sectionObj — Target data dictionary section

`Simulink.data.dictionary.Section` object

Target data dictionary section, specified as a `Simulink.data.dictionary.Section` object. Before you use this function, represent the target section with a `Simulink.data.dictionary.Section` object by using, for example, the `getSection` function.

fileName — Name of MAT or MATLAB file

character vector

Name of target MAT or MATLAB file, specified as a character vector. `exportToFile` supplies a file extension `.mat` if you do not specify an extension.

Example: `'myNewFile.mat'`

Example: `'myNewFile.m'`

Data Types: `char`

Limitation

The `exportToFile` method does not export enumerated data types (which are stored as `Simulink.data.dictionary.EnumTypeDefinition` objects). To transfer or copy an enumerated type from one dictionary to another, use the `getEntry` and `addEntry` methods of `Simulink.data.dictionary.Section` objects.

Alternatives

You can use Model Explorer to export data dictionary entries to a file. See “Export Design Data from Dictionary” for more information.

See Also

`Simulink.data.dictionary.Section` | `importFromFile`

Topics

“Store Data in Dictionary Programmatically”

Introduced in R2015a

find

Package: Simulink.data.dictionary

Search in data dictionary section

Syntax

```
foundEntries = find(sectionObj,PName1,PValue1,...,PNameN,PValueN)
foundEntries = find(sectionObj,PName1,PValue1,...,PNameN,PValueN,options)
```

Description

`foundEntries = find(sectionObj,PName1,PValue1,...,PNameN,PValueN)` searches the data dictionary section `sectionObj` using search criteria `PName1,PValue1,...,PNameN,PValueN`, and returns an array of matching entries that were found in the target section. This syntax matches the search criteria with the properties of the entries in the target section but not with the properties of their values. See `Simulink.data.dictionary.Entry` for a list of data dictionary entry properties.

`foundEntries = find(sectionObj,PName1,PValue1,...,PNameN,PValueN,options)` searches for data dictionary entries using additional search options. For example, you can match the search criteria with the values of the entries in the target section.

Examples

Return Array of All Entries in Data Dictionary Section

Represent the Design Data section of the data dictionary `myDictionary_ex_API.sldd` with a `Simulink.data.dictionary.Section` object named `dDataSectObj`.

```
myDictionaryObj = Simulink.data.dictionary.open('myDictionary_ex_API.sldd');
dDataSectObj = getSection(myDictionaryObj,'Design Data');
```

Return all of the entries stored in the Design Data section of the data dictionary `myDictionary_ex_API.sldd`.

```
allEntries = find(dDataSectObj)
```

Search Data Dictionary Section for Specific Class

Represent the Design Data section of the data dictionary `myDictionary_ex_API.sldd` with a `Simulink.data.dictionary.Section` object named `dDataSectObj`.

```
myDictionaryObj = Simulink.data.dictionary.open('myDictionary_ex_API.sldd');
dDataSectObj = getSection(myDictionaryObj,'Design Data');
```

Search in the Design Data section of `myDictionary_ex_API.sldd` for entries whose values are objects of the `Simulink.Parameter` class.

```
foundEntries = find(dDataSectObj, '-value', '-class', 'Simulink.Parameter')
```

Search Data Dictionary Section for Modifying User

Represent the Design Data section of the data dictionary `myDictionary_ex_API.sldd` with a `Simulink.data.dictionary.Section` object named `dDataSectObj`.

```
myDictionaryObj = Simulink.data.dictionary.open('myDictionary_ex_API.sldd');
dDataSectObj = getSection(myDictionaryObj, 'Design Data');
```

Search in the Design Data section of `myDictionary_ex_API.sldd` for entries that were last modified by the user `jsmith`.

```
foundEntries = find(dDataSectObj, 'LastModifiedBy', 'jsmith')
```

Search Data Dictionary Section Using Multiple Criteria

Represent the Design Data section of the data dictionary `myDictionary_ex_API.sldd` with a `Simulink.data.dictionary.Section` object named `dDataSectObj`.

```
myDictionaryObj = Simulink.data.dictionary.open('myDictionary_ex_API.sldd');
dDataSectObj = getSection(myDictionaryObj, 'Design Data');
```

Search in the Design Data section of `myDictionary_ex_API.sldd` for entries that were last modified by the user `jsmith` or whose names begin with `fuel`.

```
foundEntries = find(dDataSectObj, 'LastModifiedBy', 'jsmith', '-or', ...
'-regexp', 'Name', 'fuel*')
```

Search Data Dictionary Section Using Regular Expressions

Represent the Design Data section of the data dictionary `myDictionary_ex_API.sldd` with a `Simulink.data.dictionary.Section` object named `dDataSectObj`.

```
myDictionaryObj = Simulink.data.dictionary.open('myDictionary_ex_API.sldd');
dDataSectObj = getSection(myDictionaryObj, 'Design Data');
```

Search in the Design Data section of `myDictionary_ex_API.sldd` for entries whose names begin with `fuel`.

```
foundEntries = find(dDataSectObj, '-regexp', 'Name', 'fuel*')
```

Search Data Dictionary Section for Specific Value

Represent the Design Data section of the data dictionary `myDictionary_ex_API.sldd` with a `Simulink.data.dictionary.Section` object named `dDataSectObj`.

```
myDictionaryObj = Simulink.data.dictionary.open('myDictionary_ex_API.sldd');
dDataSectObj = getSection(myDictionaryObj, 'Design Data');
```

Return all of the entries stored in the Design Data section of the data dictionary `myDictionary_ex_API.sldd`.

```
allEntries = find(dDataSectObj);
```

Find the entries with value 237. If you find more than one entry, store the entries in an array called `foundEntries`.

```
foundEntries = [];
for i = 1:length(allEntries)
    if getValue(allEntries(i)) == 237
        foundEntries = [foundEntries allEntries(i)];
    end
end
```

Search Data Dictionary Section for Specific Property

Represent the Design Data section of the data dictionary `myDictionary_ex_API.sldd` with a `Simulink.data.dictionary.Section` object named `dDataSectObj`.

```
myDictionaryObj = Simulink.data.dictionary.open('myDictionary_ex_API.sldd');
dDataSectObj = getSection(myDictionaryObj, 'Design Data');
```

Search in the Design Data section of `myDictionary_ex_API.sldd` for entries whose values have a property `DataType`.

```
foundEntries = find(dDataSectObj, '-value', '-property', 'DataType')
```

Input Arguments

`sectionObj` — Data dictionary section to search

`Simulink.data.dictionary.Section` object

Data dictionary section to search, specified as a `Simulink.data.dictionary.Section` object. Before you use this function, represent the target section with a `Simulink.data.dictionary.Section` object by using, for example, the `getSection` function.

`PName1, PValue1, . . . , PNameN, PValueN` — Search criteria

name-value pairs representing properties

Search criteria, specified as one or more name-value pairs representing names and values of properties of the entries in the target data dictionary section. For a list of the properties of a data dictionary entry, see `Simulink.data.dictionary.Entry`. If you specify more than one name-value pair, the returned entries meet all of the criteria.

If you include the `'-value'` option to search in the values of the entries, the search criteria apply to the values of the entries rather than to the entries themselves.

Example: `'LastModifiedBy', 'jsmith'`

Example: `'DataSource', 'myRefDictionary_ex_API.sldd'`

`options` — Additional search options

supported option codes

Additional search options, specified as one or more of the following supported option codes.

| | |
|---|--|
| '-value' | This option causes <code>find</code> to search only in the values of the entries in the target data dictionary section. Specify this option before any other search criteria or options arguments. |
| '-and', '-or', '-xor', '-not' logical operators | These options modify or combine multiple search criteria or other option codes. |
| '-property', <code>propertyName</code> | This name-value pair causes <code>find</code> to search for entries or values that have the property <code>propertyName</code> regardless of the value of the property. Specify <code>propertyName</code> as a character vector. |
| '-class', <code>className</code> | This name-value pair causes <code>find</code> to search for entries or values that are objects of the class <code>className</code> . Specify <code>className</code> as a character vector. |
| '-isa', <code>className</code> | This name-value pair causes <code>find</code> to search for entries or values that are objects of the class or of any subclass derived from the class <code>className</code> . Specify <code>className</code> as a character vector. |
| '-regexp' | This option allows you to use regular expressions in your search criteria. This option affects only search criteria that follow '-regexp'. |

Example: '-value'

Example: '-value', '-property', 'CoderInfo'

Example: '-value', '-class', 'Simulink.Parameter'

Output Arguments

foundEntries — Data dictionary entries matching search criteria

array of `Simulink.data.dictionary.Entry` objects

Data dictionary entries matching the specified search criteria, returned as an array of `Simulink.data.dictionary.Entry` objects.

Alternatives

You can use Model Explorer to search a data dictionary for entries using arbitrary criteria.

See Also

`Simulink.data.dictionary.Section` | `exist` | `Simulink.data.dictionary.Entry` | `find`

Topics

“Store Data in Dictionary Programmatically”

Introduced in R2015a

getEntry

Package: Simulink.data.dictionary

Create Simulink.data.dictionary.Entry object to represent data dictionary entry

Syntax

```
entryObj = getEntry(sectionObj,entryName)
entryObj = getEntry(sectionObj,entryName,'DataSource',dictionaryName)
```

Description

entryObj = getEntry(sectionObj,entryName) returns an array of Simulink.data.dictionary.Entry objects representing data dictionary entries entryName found in the data dictionary section sectionObj, a Simulinkdata.dictionary.Section object. getEntry returns multiple objects if multiple entries have the specified name in a reference hierarchy of data dictionaries.

entryObj = getEntry(sectionObj,entryName,'DataSource',dictionaryName) returns an object representing a data dictionary entry that is defined in the data dictionary dictionaryName. Use this syntax to uniquely identify an entry that is defined more than once in a hierarchy of referenced data dictionaries.

Examples

Set Value of Data Dictionary Entry

Represent the Design Data section of the data dictionary myDictionary_ex_API.sldd with a Simulink.data.dictionary.Section object named dDataSectObj.

```
myDictionaryObj = Simulink.data.dictionary.open('myDictionary_ex_API.sldd');
dDataSectObj = getSection(myDictionaryObj,'Design Data');
```

Represent the data dictionary entry fuelFlow with a Simulink.data.dictionary.Entry object named fuelFlowObj. fuelFlow is defined in the data dictionary myDictionary_ex_API.sldd.

```
fuelFlowObj = getEntry(dDataSectObj,'fuelFlow');
```

Set the value of the entry fuelFlow to 493.

```
setValue(fuelFlowObj,493)
```

Set Value of Entry in Reference Dictionary

Represent the Design Data section of the data dictionary myDictionary_ex_API.sldd with a Simulink.data.dictionary.Section object named dDataSectObj.

```
myDictionaryObj = Simulink.data.dictionary.open('myDictionary_ex_API.sldd');
dDataSectObj = getSection(myDictionaryObj,'Design Data');
```

Represent the data dictionary entry `myRefEntry` with a `Simulink.data.dictionary.Entry` object named `refEntryObj`. `myDictionary_ex_API.sldd` references `myRefDictionary_ex_API.sldd`, and `myRefDictionary_ex_API.sldd` defines an entry `myRefEntry`.

```
refEntryObj = getEntry(dDataSectObj, 'myRefEntry', 'DataSource', ...
    'myRefDictionary_ex_API.sldd');
```

Set the value of the entry `myRefEntry` to 493.

```
setValue(refEntryObj, 493)
```

Input Arguments

sectionObj — Target data dictionary section

`Simulink.data.dictionary.Section` object

Target data dictionary section, specified as a `Simulink.data.dictionary.Section` object. Before you use this function, represent the target section with a `Simulink.data.dictionary.Section` object by using, for example, the `getSection` function.

entryName — Name of target data dictionary entry

character vector

Name of target data dictionary entry, specified as a character vector.

Example: `'myEntry'`

Data Types: `char`

dictionaryName — Name of data dictionary containing target entry

character vector

File name of data dictionary containing the target entry, specified as a character vector including the `.sldd` extension.

Example: `'mySubDictionary_ex_API.sldd'`

Data Types: `char`

Output Arguments

entryObj — Target data dictionary entry

`Simulink.data.dictionary.Entry` object

Target data dictionary entry, returned as one or more `Simulink.data.dictionary.Entry` objects.

See Also

`Simulink.data.dictionary.Section` | `addEntry` | `Simulink.data.dictionary.Entry` | `getValue`

Topics

“Store Data in Dictionary Programmatically”

Introduced in R2015a

importFromFile

Package: Simulink.data.dictionary

Import variables from MAT-file or MATLAB file to data dictionary section

Syntax

```
importedVars = importFromFile(sectionObj,fileName)
importedVars = importFromFile(sectionObj,fileName,'existingVarsAction',
existAction)
[importedVars,existingVars] = importFromFile( __ )
```

Description

`importedVars = importFromFile(sectionObj,fileName)` imports variables defined in the MAT-file or MATLAB file `fileName` to the data dictionary section `sectionObj` without overwriting any variables that are already in the target section. If any variables are already in the target section, the function displays a warning and a list in the MATLAB Command Window. This syntax returns a list of variables that were successfully imported. A variable is considered successfully imported only if `importFromFile` assigns the value of the variable to the corresponding entry in the target data dictionary.

`importedVars = importFromFile(sectionObj,fileName,'existingVarsAction',existAction)` imports variables that are already in the target section by taking a specified action `existAction`. For example, you can choose to use the variable values in the target file to overwrite the corresponding values in the target section.

`[importedVars,existingVars] = importFromFile(__)` returns a list of variables in the target section that were not overwritten. Use this syntax if `existingVarsAction` is set to 'none', the default value, which prevents existing dictionary entries from being overwritten.

Examples

Import to Data Dictionary from File

Represent the Design Data section of the data dictionary `myDictionary_ex_API.sldd` with a `Simulink.data.dictionary.Section` object named `dDataSectObj`.

```
myDictionaryObj = Simulink.data.dictionary.open('myDictionary_ex_API.sldd');
dDataSectObj = getSection(myDictionaryObj,'Design Data');
```

Import all variables contained in the file `myData_ex_API.m` to the data dictionary and return a list of successfully imported variables. If any variables are already in `myDictionary_ex_API.sldd`, `importFromFile` returns a warning and a list of the affected variables.

```
importFromFile(dDataSectObj,'myData_ex_API.m')
```

```
Warning: The following variables were not imported because
they already exist in the dictionary:
    fuelFlow
```

```
ans =  
  
    'myFirstEntry'  
    'mySecondEntry'  
    'myThirdEntry'
```

Import Variables from File and Overwrite Conflicts

Represent the Design Data section of the data dictionary `myDictionary_ex_API.sldd` with a `Simulink.data.dictionary.Section` object named `dDataSectObj`.

```
myDictionaryObj = Simulink.data.dictionary.open('myDictionary_ex_API.sldd');  
dDataSectObj = getSection(myDictionaryObj,'Design Data');
```

Import all variables contained in the file `myData_ex_API.m` to the data dictionary, overwrite any variables that are already in the dictionary, and return a list of successfully imported variables.

```
importFromFile(dDataSectObj,'myData_ex_API.m','existingVarsAction','overwrite')  
  
ans =  
  
    'fuelFlow'  
    'myFirstEntry'  
    'mySecondEntry'  
    'myThirdEntry'
```

Return Variables Not Imported to Data Dictionary from File

Return a list of variables that are not imported from a file because they are already in the target data dictionary

Represent the Design Data section of the data dictionary `myDictionary_ex_API.sldd` with a `Simulink.data.dictionary.Section` object named `dDataSectObj`.

```
myDictionaryObj = Simulink.data.dictionary.open('myDictionary_ex_API.sldd');  
dDataSectObj = getSection(myDictionaryObj,'Design Data');
```

Import all variables contained in the file `myData_ex_API.m` to the data dictionary. Specify names for the output arguments of `importFromFile` to return the names of successfully and unsuccessfully imported variables.

```
[importedVars,existingVars] = importFromFile(dDataSectObj,'myData_ex_API.m')  
  
importedVars =  
  
    'myFirstEntry'  
    'mySecondEntry'  
    'myThirdEntry'  
  
existingVars =  
  
    'fuelFlow'
```

`importFromFile` does not import the variable `fuelFlow` because it is already in the target data dictionary.

Input Arguments

sectionObj — Target data dictionary section

`Simulink.data.dictionary.Section` object

Target data dictionary section, specified as a `Simulink.data.dictionary.Section` object. Before you use this function, represent the target section with a `Simulink.data.dictionary.Section` object by using, for example, the `getSection` function.

fileName — Name of MAT or MATLAB file

character vector

Name of target MAT or MATLAB file, specified as a character vector. `importFromFile` automatically supplies a file extension `.mat` if you do not specify an extension.

Example: `'myFile.mat'`

Example: `'myFile.m'`

Data Types: `char`

existAction — Action to take for existing dictionary variables

`'none'` (default) | `'overwrite'` | `'error'`

Action to take for existing dictionary variables, specified as `'none'`, `'overwrite'`, or `'error'`.

If you specify `'none'`, `importFromFile` attempts to import target variables but does not import or make any changes to variables that are already in the data dictionary section.

If you specify `'overwrite'`, `importFromFile` imports all target variables and overwrites any variables that are already in the data dictionary section.

If you specify `'error'`, `importFromFile` returns an error, without importing any variables, if any target variables are already in the data dictionary section.

Example: `'overwrite'`

Data Types: `char`

Output Arguments

importedVars — Successfully imported variables

cell array of character vectors

Names of successfully imported variables, returned as a cell array of character vectors. A variable is considered successfully imported only if `importFromFile` assigns its value to the corresponding entry in the target data dictionary.

existingVars — Variables that were not imported

cell array of character vectors

Names of target variables that were not imported due to their existence in the target data dictionary, returned as a cell array of character vectors. `existingVars` has content only if `existAction` is set

to 'none', which is also the default. In that case `importFromFile` imports only variables that are not already in the target data dictionary.

Tips

- `importFromFile` can import MATLAB variables created from enumerated data types but cannot import the definitions of the enumerated types. Use the `importEnumTypes` function to import enumerated data type definitions to a data dictionary. If you import variables of enumerated data types to a data dictionary but do not import the enumerated type definitions, the dictionary is less portable and might not function properly if used by someone else.

Alternatives

You can use the Model Explorer to import variables to a data dictionary from a file. See “Import Data to Dictionary from File” for more information.

See Also

`Simulink.data.dictionary.Section` | `exportToFile` | `importEnumTypes`

Topics

“Store Data in Dictionary Programmatically”

Introduced in R2015a

Simulink.data.dictionary.setupWorkerCache

Enable parallel simulation with data dictionary

Syntax

```
Simulink.data.dictionary.setupWorkerCache
```

Description

`Simulink.data.dictionary.setupWorkerCache` prepares the workers in a parallel pool for simulating a model that is linked to a data dictionary. Use this function in a `spmd` block, prior to starting a `parfor` block, to provide the workers in a parallel pool a way to safely interact with a single data dictionary.

During parallel simulation of a model that is linked to a data dictionary, you can allow each worker to access and modify the data in the dictionary independently of other workers.

`Simulink.data.dictionary.setupWorkerCache` temporarily provides each worker in the pool with its own data dictionary cache, allowing the workers to use the data in the dictionary without permanently changing it.

You must have a Parallel Computing Toolbox license to perform parallel simulation using a `parfor` block.

Examples

Sweep Variant Control Using Parallel Simulation

To use parallel simulation to sweep a variant control (a `Simulink.Parameter` object whose value influences the variant condition of a `Simulink.Variant` object) that you store in a data dictionary, use this code as a template. Change the names and values of the model, data dictionary, and variant control to match your application.

To sweep block parameter values or the values of workspace variables that you use to set block parameters, use `Simulink.SimulationInput` objects instead of the programmatic interface to the data dictionary. See “Optimize, Estimate, and Sweep Block Parameter Values”.

You must have a Parallel Computing Toolbox license to perform parallel simulation.

```
% For convenience, define names of model and data dictionary
model = 'mySweepMdl';
dd = 'mySweepDD.sldd';

% Define the sweeping values for the variant control
CtrlValues = [1 2 3 4];

% Grant each worker in the parallel pool an independent data dictionary
% so they can use the data without interference
spmd
    Simulink.data.dictionary.setupWorkerCache
end
```

```
% Determine the number of times to simulate
numberOfSims = length(CtrlValues);

% Prepare a nondistributed array to contain simulation output
simOut = cell(1,numberOfSims);

parfor index = 1:numberOfSims
    % Create objects to interact with dictionary data
    % You must create these objects for every iteration of the parfor-loop
    dictObj = Simulink.data.dictionary.open(dd);
    sectObj = getSection(dictObj,'Design Data');
    entryObj = getEntry(sectObj,'MODE');
    % Suppose MODE is a Simulink.Parameter object stored in the data dictionary

    % Modify the value of MODE
    temp = getValue(entryObj);
    temp.Value = CtrlValues(index);
    setValue(entryObj,temp);

    % Simulate and store simulation output in the nondistributed array
    simOut{index} = sim(model);

    % Each worker must discard all changes to the data dictionary and
    % close the dictionary when finished with an iteration of the parfor-loop
    discardChanges(dictObj);
    close(dictObj);
end

% Restore default settings that were changed by the function
% Simulink.data.dictionary.setupWorkerCache
% Prior to calling cleanupWorkerCache, close the model

spmd
    bdclose(model)
    Simulink.data.dictionary.cleanupWorkerCache
end
```

Note If data dictionaries are open, you cannot use the command `Simulink.data.dictionary.cleanupWorkerCache`. To identify open data dictionaries, use `Simulink.data.dictionary.getOpenDictionaryPaths`.

See Also

`spmd` | `parfor` | `Simulink.data.dictionary.cleanupWorkerCache`

Topics

“Store Data in Dictionary Programmatically”

“What Is a Data Dictionary?”

“Run Code on Parallel Pools” (Parallel Computing Toolbox)

Introduced in R2015a

show

Package: Simulink.data

Show data dictionary in Model Explorer

Syntax

```
show(dictionaryObj)
show(dictionaryObj, openModelExplorer)
```

Description

`show(dictionaryObj)` opens Model Explorer and displays the data dictionary `dictionaryObj` as the selected tree node in the **Model Hierarchy** pane.

`show(dictionaryObj, openModelExplorer)` enables you to add the target dictionary to the **Model Hierarchy** pane without opening Model Explorer.

Examples

Show Data Dictionary in Model Explorer

Open the data dictionary `myDictionary_ex_API.sldd` and represent it with a `Simulink.data.Dictionary` object named `myDictionaryObj`.

```
myDictionaryObj = Simulink.data.dictionary.open('myDictionary_ex_API.sldd');
```

Open Model Explorer and display `myDictionary_ex_API` as the selected node of the model hierarchy tree in the **Model Hierarchy** pane.

```
show(myDictionaryObj)
```

Add Data Dictionary to Model Hierarchy Tree

Open the data dictionary `myDictionary_ex_API.sldd` and represent it with a `Simulink.data.Dictionary` object named `myDictionaryObj`.

```
myDictionaryObj = Simulink.data.dictionary.open('myDictionary_ex_API.sldd');
```

Add `myDictionary_ex_API.sldd` to the model hierarchy tree without opening Model Explorer.

```
show(myDictionaryObj, false)
```

You can confirm the addition of `myDictionary_ex_API` to the model hierarchy tree by manually opening Model Explorer.

Input Arguments

dictionaryObj — Target data dictionary

`Simulink.data.Dictionary` object

Target data dictionary, specified as a `Simulink.data.Dictionary` object. Before you use this function, represent the target dictionary with a `Simulink.data.Dictionary` object by using, for example, the `Simulink.data.dictionary.create` or `Simulink.data.dictionary.open` function.

openModelExplorer — Flag to open Model Explorer

`true` (default) | `false`

Flag to open Model Explorer, specified as `true` or `false`.

Data Types: `logical`

Tips

- Use the `hide` function to remove a data dictionary from the tree in the **Model Hierarchy** pane of Model Explorer. The dictionary does not appear in the hierarchy again until you use the `show` function or you open and view the dictionary in the Model Explorer using the interface.

See Also

`Simulink.data.Dictionary` | `hide`

Topics

“Store Data in Dictionary Programmatically”

Introduced in R2015a

Simulink.data.evalinGlobal

Evaluate MATLAB expression in context of Simulink model

Syntax

```
returnValue = Simulink.data.evalinGlobal(modelName,expression)
```

Description

`returnValue = Simulink.data.evalinGlobal(modelName,expression)` evaluates the MATLAB expression `expression` in the context of the Simulink model `modelName` and returns the values returned by `expression`. `evalinGlobal` evaluates `expression` in the Design Data section of the data dictionary that is linked to the target model or in the MATLAB base workspace if the target model is not linked to any data dictionary.

Examples

Evaluate MATLAB Expression in Model With or Without Data Dictionary

Evaluate the MATLAB expression `myNewVariable = 237;` in the context of the model `vdp`, which is not linked to any data dictionary. `myNewVariable` appears as a variable in the MATLAB base workspace.

```
Simulink.data.evalinGlobal('vdp','myNewVariable = 237;')
```

Evaluate the MATLAB expression `myNewEntry = true;` in the context of the model `sldemo_fuelsys_dd_controller`, which is linked to the data dictionary `sldemo_fuelsys_dd_controller.sldd`. `myNewEntry` appears as an entry in the Design Data section of the dictionary.

```
Simulink.data.evalinGlobal('sldemo_fuelsys_dd_controller',...
'myNewEntry = true;')
```

Confirm the creation of the entry `myNewEntry` in the data dictionary `sldemo_fuelsys_dd_controller.sldd` by viewing the dictionary in Model Explorer.

```
myDictionaryObj = Simulink.data.dictionary.open(...
'sldemo_fuelsys_dd_controller.sldd');
show(myDictionaryObj)
```

Input Arguments

modelName — Name of target Simulink model

character vector

Name of target Simulink model, specified as a character vector.

Example: `'myTestModel'`

Data Types: `char`

expression — MATLAB expression to evaluate

character vector

MATLAB expression to evaluate, specified as a character vector.

Example: 'a = 5.3'

Example: 'whos'

Example: 'CurrentSpeed.Value = 290.73'

Data Types: char

Output Arguments**returnValue — Value returned by specified expression**

valid entry or variable value

Value returned by the specified MATLAB expression.

Tips

- `evalinGlobal` helps you transition Simulink models to the use of data dictionaries. You can use the function to manipulate model variables before and after linking a model to a data dictionary.

See Also`evalin` | `Simulink.data.assigninGlobal` | `Simulink.data.existsInGlobal`**Topics**

“Store Data in Dictionary Programmatically”

Introduced in R2015a

Simulink.data.existsInGlobal

Check existence of variable in context of Simulink model

Syntax

```
varExists = Simulink.data.existsInGlobal(modelName,varName)
```

Description

`varExists = Simulink.data.existsInGlobal(modelName,varName)` returns an indication of the existence of a variable or data dictionary entry `varName` in the context of the Simulink model `modelName`. `Simulink.data.existsInGlobal` searches the Design Data section of the data dictionary that is linked to the target model or the MATLAB base workspace if the target model is not linked to any data dictionary.

Examples

Determine Existence of Variable in Model With or Without Data Dictionary

Determine the existence of a variable `PressVect` in the context of the Simulink model `vdp.slx`, which is not linked to any data dictionary.

```
Simulink.data.existsInGlobal('vdp','PressVect')
```

```
ans =  
     0
```

Because `vdp.slx` is not linked to any data dictionary, `existsInGlobal` searches only in the MATLAB base workspace for `PressVect`.

Determine the existence of a variable `PressVect` in the context of the Simulink model `sldemo_fuelsys_dd_controller.slx`, which is linked to the data dictionary `sldemo_fuelsys_dd_controller.sldd`.

```
Simulink.data.existsInGlobal('sldemo_fuelsys_dd_controller','PressVect')
```

```
ans =  
     1
```

Because `sldemo_fuelsys_dd_controller.slx` is linked to the data dictionary `sldemo_fuelsys_dd_controller.sldd`, `existsInGlobal` searches for `PressVect` only in the Design Data section of the dictionary.

Input Arguments

modelName — Name of target Simulink model

character vector

Name of target Simulink model, specified as a character vector.

Example: 'myTestModel'

Data Types: char

varName — Name of target variable or data dictionary entry

character vector

Name of target variable or data dictionary entry, specified as a character vector.

Example: 'myTargetVariable'

Data Types: char

Output Arguments

varExists — Indication of existence of target variable or data dictionary entry

1 | 0

Indication of existence of target variable or data dictionary entry, returned as 1 to indicate existence or 0 to indicate absence.

Tips

- `existsInGlobal` helps you transition Simulink models to the use of data dictionaries. You can use the function to find model variables before and after linking a model to a data dictionary.

Alternatives

You can use Model Explorer to search a data dictionary or any workspace for entries or variables.

See Also

`exist` | `Simulink.data.assignInGlobal` | `Simulink.data.evalInGlobal`

Topics

“Store Data in Dictionary Programmatically”

Introduced in R2015a

Simulink.data.getEnumTypeInfo

Get information about enumerated data type

Syntax

```
information = Simulink.data.getEnumTypeInfo(enumTypeName,infoRequest)
```

Description

`information = Simulink.data.getEnumTypeInfo(enumTypeName,infoRequest)` returns information about an enumerated data type `enumTypeName`.

Use this function only to return information about an enumerated data type. To customize an enumerated data type, for example, by specifying a default enumeration member or by controlling the scope of the type definition in generated code, see “Customize Simulink Enumeration”.

Examples

Return Default Value of Enumerated Data Type

Get the default enumeration member of an enumerated data type `LEDcolor`. Suppose `LEDcolor` defines two enumeration members, `GREEN` and `RED`, and uses `GREEN` as the default member.

```
Simulink.data.getEnumTypeInfo('LEDcolor','DefaultValue')
```

```
ans =  
    GREEN
```

Get Scope of Enumerated Data Type Definition in Generated Code

For an enumerated data type `LEDcolor`, find out if generated code exports or imports the definition of the type to or from a header file.

```
Simulink.data.getEnumTypeInfo('LEDcolor','DataScope')  
Simulink.data.getEnumTypeInfo('LEDcolor','HeaderFile')
```

```
ans =  
Auto  
  
ans =  
''
```

Because `DataScope` is 'Auto' and `HeaderFile` is empty, generated code defines the enumerated data type `LEDcolor` in the header file `model_types.h` where `model` is the name of the model used to generate code.

Input Arguments

enumTypeName — Name of target enumerated data type

character vector

Name of the target enumerated data type, specified as a character vector.

Example: 'myFirstEnumType'

Data Types: char

infoRequest — Information to return

valid character vector

Information to return, specified as one of the character vector options in the table.

| Specified value | Information returned | Example return value |
|-----------------|--|-----------------------|
| 'DefaultValue' | The default enumeration member, returned as an instance of the enumerated data type. | enumMember1 |
| 'Description' | The custom description of this data type, returned as a character vector. Returns an empty character vector if a description was not specified for the type. | 'My first enum type.' |
| 'HeaderFile' | The name of the custom header file that defines the data type in generated code, returned as a character vector. Returns an empty character vector if a header file was not specified for the type. | 'myEnumType.h' |
| 'DataScope' | Indication whether generated code imports or exports the definition of the data type. A return value of 'Auto' indicates generated code defines the type in the header file <code>model_types.h</code> or imports the definition from the header file identified by <code>HeaderFile</code> . A return value of 'Exported' or 'Imported' indicates generated code exports or imports the definition to or from the header file identified by <code>HeaderFile</code> . | 'Exported' |
| 'StorageType' | The integer data type used by generated code to store the numeric values of the enumeration members, returned as a character vector. Returns 'int' if you did not specify a storage type for the enumerated type, in which case generated code uses the native integer type of the hardware target. | 'int32' |

| Specified value | Information returned | Example return value |
|----------------------------|--|----------------------|
| 'AddClassNameToEnumNames ' | Indication whether generated code prefixes the names of enumeration members with the name of the data type. Returned as true or false. | true |

See Also

Simulink.defineIntEnumType

Topics

“Customize Simulink Enumeration”

“Simulink Enumerations”

Introduced in R2014b

Simulink.data.isSupportedEnumClass

Determine whether an enumeration class is valid for Simulink

Syntax

```
valid = Simulink.data.isSupportedEnumClass(enumClass)
```

Description

`valid = Simulink.data.isSupportedEnumClass(enumClass)` returns true if `enumClass` is a valid enumeration class for Simulink.

Examples

Determine if Enumeration Class is Valid

Define an enumeration class of basic colors, then confirm that it is valid.

```
Simulink.defineIntEnumType('BasicColors', ...  
    {'Red', 'Yellow', 'Blue'}, ...  
    [0;1;2]);  
Simulink.data.isSupportedEnumClass('BasicColors')
```

```
ans =  
  
    logical  
  
     1
```

Perform the same validity check by using the `meta.class` object as the input.

```
Simulink.data.isSupportedEnumClass(?BasicColors)
```

```
ans =  
  
    logical  
  
     1
```

Check if `Simulink.NumericType` is a valid enumeration class by using the `meta.class` object as the input.

```
Simulink.data.isSupportedEnumClass(?Simulink.NumericType)
```

```
ans =  
  
    logical
```

0

Input Arguments

enumClass — Enumeration class

character vector | `meta.class`

Enumeration class, specified as a character vector or as `meta.class` object.

Example: `'myEnumClass'` or `?myEnumClass`

Output Arguments

valid — Whether enumeration class is valid

logical

If the input value refers to a valid enumeration class for Simulink, `valid` is `true`, otherwise `valid` is `false`.

See Also

`Simulink.defineIntEnumType` | `Simulink.data.getEnumTypeInfo` |
`Simulink.data.isSupportedEnumObject` | `Simulink.clearIntEnumType` |
`Simulink.findIntEnumType`

Topics

“Simulink Enumerations”

Introduced in R2014b

Simulink.data.isSupportedEnumObject

Determine whether an enumeration object is valid for Simulink

Syntax

```
valid = Simulink.data.isSupportedEnumObject(enumObject)
```

Description

`valid = Simulink.data.isSupportedEnumObject(enumObject)` returns true if `enumObject` is a valid enumeration object for Simulink.

Examples

Determine if Enumeration Object is Valid

Define an enumeration class of basic colors.

```
Simulink.defineIntEnumType('BasicColors', ...  
    {'Red', 'Yellow', 'Blue'}, ...  
    [0;1;2]);
```

Confirm that an instance of the enumeration class is valid.

```
Simulink.data.isSupportedEnumObject(BasicColors.Yellow)
```

```
ans =  
  
    logical  
  
     1
```

Call the function with input that is not an enumeration object.

```
Simulink.data.isSupportedEnumObject(5)
```

```
ans =  
  
    logical  
  
     0
```

Input Arguments

enumObject — Enumeration object

enumeration object

Instance of a defined enumeration, specified as an enumeration object.

Example: `myEnumObject`

Output Arguments

valid — Whether enumeration class is valid

logical

If the input value refers to a valid enumeration object for Simulink, `valid` is `true`, otherwise `valid` is `false`.

See Also

`Simulink.defineIntEnumType` | `Simulink.data.getEnumTypeInfo` |
`Simulink.data.isSupportedEnumClass` | `Simulink.clearIntEnumType` |
`Simulink.findIntEnumType`

Topics

“Simulink Enumerations”

Introduced in R2014b

Simulink.defineIntEnumType

Define enumerated data type

Syntax

```
Simulink.defineIntEnumType(ClassName, CellofEnums,IntValues)
Simulink.defineIntEnumType( __ , 'Description',ClassDesc)
Simulink.defineIntEnumType( __ , 'DefaultValue',DefValue)
Simulink.defineIntEnumType( __ , 'DataScope',ScopeSelection)
Simulink.defineIntEnumType( __ , 'HeaderFile',FileName)
Simulink.defineIntEnumType( __ , 'AddClassNameToEnumNames',Flag)
Simulink.defineIntEnumType( __ , 'StorageType',DataType)
```

Description

`Simulink.defineIntEnumType(ClassName, CellofEnums,IntValues)` defines an enumeration named `ClassName` with enumeration values specified with `CellofEnums` and underlying numeric values specified by `IntValues`.

`Simulink.defineIntEnumType(__ , 'Description',ClassDesc)` defines the enumeration with a description.

`Simulink.defineIntEnumType(__ , 'DefaultValue',DefValue)` defines a default value for the enumeration, which is one of the character vectors you specify for `CellofEnums`.

`Simulink.defineIntEnumType(__ , 'DataScope',ScopeSelection)` specifies whether the data type definition should be imported from, or exported to, a header file during code generation.

`Simulink.defineIntEnumType(__ , 'HeaderFile',FileName)` specifies the name of a header file containing the enumeration class definition for use in code generated from a model.

`Simulink.defineIntEnumType(__ , 'AddClassNameToEnumNames',Flag)` specifies whether the code generator applies the class name as a prefix to the enumeration values that you specify for `CellofEnums`. For `Flag`, specify `true` or `false`. For example, if you specify `true`, the code generator would use `BasicColors.Red` instead of `Red` to represent an enumerated value.

`Simulink.defineIntEnumType(__ , 'StorageType',DataType)` specifies the data type used to store the enumerations' underlying integer values in code generated from a model.

Examples

Import Enumeration Class Definition Into Workspace

Assume an external data dictionary includes the following enumeration:

```
BasicColors.Red(0), BasicColors.Yellow(1), BasicColors.Blue(2)
```

Import the enumeration class definition into the MATLAB workspace while specifying `int16` as the underlying integer data type for generated code:

```
Simulink.defineIntEnumType('BasicColors', ...
    {'Red', 'Yellow', 'Blue'}, ...
    [0;1;2], ...
    'Description', 'Basic colors', ...
    'DefaultValue', 'Blue', ...
    'HeaderFile', 'mybasiccolors.h', ...
    'DataScope', 'Exported', ...
    'AddClassNameToEnumNames', true, ...
    'StorageType', 'int16');
```

Input Arguments

ClassName — Name of enumerated data type

character vector | string

The name of the enumerated data type, specified as a character vector or string.

Example: 'BasicColors'

CellOfEnums — Enumerations for data type

cell array of character vectors

Enumerations for the data type, specified as a cell array of character vectors.

Example: {'Red', 'Yellow', 'Blue'}

IntValues — Numeric enumeration values

array of numeric values

Numeric enumeration values, specified as an array.

Example: [0;1;2]

ClassDesc — Description of enumeration data type

character vector

Description of the enumeration data type, specified as a character vector.

Example: 'Basic colors'

DefValue — Default enumeration value

character vector

The default enumeration value, specified as a character vector. The value is one of the character vectors specified for CellOfEnums.

Example: 'Blue'

FileName — Header file

character vector

That header file that is to contain the data type definition, specified as a character vector. By default, the generated `#include` directive uses the preprocessor delimiter `"` instead of `<` and `>`. To generate the directive `#include <mytypes.h>`, specify FileName as `'<myTypes.h>'`.

Example: 'mybasiccolors.h'

ScopeSelection — Action for data type definition`'Auto'` (default) | `'Exported'` | `'Imported'`

Action to take for the data type definition during code generation , specified as one of these values:

- `'Auto'` — If no value is specified for `HeaderFile`, export the type definition to `model_types.h` where `model` is the model name. If a value is specified for `HeaderFile`, import the data type definition from the specified header file.
- `'Exported'` — Export the data type definition to a header file. If no value is specified for `HeaderFile`, the header file name defaults to `type.h`, where `type` is the data type name.
- `'Imported'` — Import the data type definition from a header file. If no value is specified for `HeaderFile`, the header file name defaults to `type.h`, where `type` is the data type name.

Flag — Whether class name is a prefix to enumeration`false` or `0` (default) | `true` or `1`

Whether the code generator applies the class name as a prefix to the enumerations, specified as a numeric or logical `1` (true) or `0` (false).

Example: `true`

DataType — Data type used to store enumeration values`'int8'` | `'int16'` | `'int32'` | `'uint8'` | `'uint16'`

Data type used to store the enumerations' underlying integer values in generated code, specified as a character vector.

Example: `'int16'`

See Also`enumeration`**Topics**

“Import Enumerations Defined Externally to MATLAB”

“Define Simulink Enumerations”

Introduced in R2010b

Simulink.defaultModelTemplate

Set or get default model template

Syntax

```
Simulink.defaultModelTemplate(templatename)  
templatepath = Simulink.defaultModelTemplate
```

Description

`Simulink.defaultModelTemplate(templatename)` sets the template file specified by `templatename` as the default model template to use for new models. This setting is persistent between Simulink sessions.

`templatepath = Simulink.defaultModelTemplate` gets the full path to the current default model template.

Examples

Set the default model template

```
Simulink.defaultModelTemplate('simple_simulation.sltx')
```

Get the default model template

```
mydefaulttemplate = Simulink.defaultModelTemplate
```

Clear and restore the default model template

Use `set_param` to set a root block diagram parameter. This clears the default template so that new models will inherit this property of the root block diagram, and warns.

```
set_param(0, 'StopTime', '99');
```

Restore the default template.

```
Simulink.defaultModelTemplate('$restore');
```

Input Arguments

templatename — Template file name

character vector

Template file name, specified as a character vector. If the template is not on the MATLAB path, specify the fully-qualified path to the template file and `*.sltx` extension.

Example: \\Home\username\Documents\MATLAB\template.sltx

Data Types: char

Output Arguments

templatepath — Template path

character vector

Template path, specified as a character vector, showing the full path to the current default model template.

See Also

`new_system` | `Simulink.createFromTemplate` | `Simulink.exportToTemplate` | `Simulink.findTemplates`

Topics

“Build and Edit a Model Interactively”

“Create Template from Model”

“Using Templates to Create Standard Project Settings”

Introduced in R2016b

Simulink.exportToTemplate

Create template from model or project

Syntax

```
templatefile = Simulink.exportToTemplate(obj,templatename)
templatefile = Simulink.exportToTemplate(obj,templatename,Name,Value)
```

Description

`templatefile = Simulink.exportToTemplate(obj,templatename)` creates a template file (*templatename*.sltx) from a model or project specified by `obj`.

If you have project templates created in R2014a or earlier (.zip files), use `Simulink.exportToTemplate` to upgrade them to .sltx files, then you can use them in the start page.

`templatefile = Simulink.exportToTemplate(obj,templatename,Name,Value)` specifies additional template options as one or more Name, Value pair arguments.

Examples

Create a Template From a Model

Open the vdp model and create a template from it.

```
vdp
myvdptemplate = Simulink.exportToTemplate(bdroot,'vdptemplate')
```

Create a Template From a Model and Specify Description

Open the vdp model and create a template from it, specifying a description.

```
vdp
myvdptemplate = Simulink.exportToTemplate(bdroot,'vdptemplate','Description','Use this template')
```

Input Arguments

obj — Model, library, or project

character vector | numeric handle | `slproject.ProjectManager`

Model, library, or project, specified by name or numeric handle, or a `slproject.ProjectManager` object returned by the `currentProject` function.

Data Types: `double` | `char`

templatename — Template file name

character vector

Template file name, specified as a character vector that can optionally include the fully-qualified path to a template file and *.sltx extension.

Data Types: char

Name-Value Pair Arguments

Specify optional comma-separated pairs of `Name`, `Value` arguments. `Name` is the argument name and `Value` is the corresponding value. `Name` must appear inside quotes. You can specify several name and value pair arguments in any order as `Name1, Value1, ..., NameN, ValueN`.

Example: `Title, 'My Project Template'`

Group — Group of template

character vector

Group of template, specified as a character vector. On the Start Page, templates are shown under group headings.

Example: `'My Templates'`

Data Types: char

Author — Author of template

character vector

Author of template, specified as a character vector.

Data Types: char

Description — Description of template

character vector

Description of template, specified as a character vector.

Data Types: char

ThumbnailFile — Thumbnail image file name

character vector

Thumbnail image file name, specified as a character vector.

Data Types: char

Title — Title of model or project template

character vector

Title of template, specified as a character vector. On the Start Page, the templates titles are shown on the tiles. The title can be different from the file name, and you can use any characters in the title. The default value is the name of the model or project.

Example: `'My Project Template'`

Data Types: char

Output Arguments

templatefile — Template file

character vector

Template file, returned as *templatename.sltx* file.

See Also

[Simulink.createFromTemplate](#) | [Simulink.findTemplates](#) | [Simulink.defaultModelTemplate](#)

Topics

[“Build and Edit a Model Interactively”](#)

[“Create Template from Model”](#)

[“Using Templates to Create Standard Project Settings”](#)

Introduced in R2016a

Simulink.exportToVersion

Export model, library, or project for use in previous version of Simulink

Syntax

```
exported_file = Simulink.exportToVersion(modelname, target_filename, version)
exported_file = Simulink.exportToVersion(modelname, target_filename, version,
Name, Value)
exported_project = Simulink.exportToVersion(proj, zipfilename, version)
```

Description

`exported_file = Simulink.exportToVersion(modelname, target_filename, version)` exports the model or library `modelname` to a file named `target_filename` in a format that the specified previous Simulink version can load.

If the system contains functionality not supported by the specified Simulink software version, the command removes the functionality and replaces any unsupported blocks with empty masked subsystem blocks colored yellow. As a result, the converted system may generate different results.

The `save_system` `ExportToVersion` option is a legacy option for this functionality that is also supported.

`exported_file = Simulink.exportToVersion(modelname, target_filename, version, Name, Value)` specifies additional options as one or more name-value pair arguments.

`exported_project = Simulink.exportToVersion(proj, zipfilename, version)` exports the project `proj` to a ZIP file `zipfilename` in a format that the specified previous Simulink version can load.

Examples

Export a Model to a Previous Version

Get the current top-level system and export it.

```
Simulink.exportToVersion(bdroot, 'mymodel.slx', 'R2014b');
```

Export a Model to a Previous Version and Break Links

Get the current top-level system and export it, replacing links to library blocks with copies of the library blocks in the saved file.

```
Simulink.exportToVersion(bdroot, 'mymodel.slx', 'R2014b', 'BreakUserLinks', true);
```

Export a Project to a Previous Version

Get the current top-level project and export it.

```
sldemo_slproject_airframe;
proj = currentProject;
Simulink.exportToVersion(proj, 'myzipfilename', 'R2019a');
```

Input Arguments

modelName — Model to export

character vector | string scalar

Model to export, specified as a character vector or string scalar, without any file extension. The model must be loaded and unmodified. The target file must not be the same as the model file.

Data Types: char | string

target_filename — Exported file name

character vector | string scalar

Exported file name, specified as a character vector or string scalar. The target file must not be the same as the model file.

Example: 'mymodel.slx'

Data Types: char | string

proj — Project to export

matlab.project.Project object

Project to export, specified as a matlab.project.Project object. Use currentProject to create a project object from the currently loaded project.

zipfilename — Exported ZIP file name

character vector | string scalar

ZIP file name containing the exported project, specified as a character vector or string scalar.

Example: 'myzipfile.zip'

Data Types: char | string

version — MATLAB release name

'R2013B' | 'R2014A_MDL' | 'R2016B_SLX' | ...

MATLAB release name, specified as a character vector or string scalar, which specifies a previous Simulink version. Simulink.exportToVersion exports the system to a format that the specified previous Simulink version can load. You cannot export to your current version. These version names are not case sensitive.

You can specify model file format as SLX or MDL using the suffix `_MDL` or `_SLX`. If you do not specify a format, you export your default model file format.

If you use the Export to Previous Version dialog box instead of Simulink.exportToVersion, then the **Save as type** list supports 7 years of previous releases.

Example: 'R2015B'

Data Types: `char` | `string`

Name-Value Pair Arguments

Specify optional comma-separated pairs of `Name`, `Value` arguments. `Name` is the argument name and `Value` is the corresponding value. `Name` must appear inside quotes. You can specify several name and value pair arguments in any order as `Name1, Value1, . . . , NameN, ValueN`.

Example:

AllowPrompt — Allow prompt or message dialog box

`false` (default) | `true` | `'on'` | `'off'`

Allow prompt or message dialog box, specified by a logical value that indicates whether to display any output prompt or message in a dialog box or only messages at the command line. For example, prompts to make files writable, or messages about exported versions. If you want to allow prompts, then set to `true`. or `on`.

BreakUserLinks — Break user-defined links

`false` (default) | `true` | `'on'` | `'off'`

Break user-defined links, specified by a logical value that indicates whether the function replaces links to user-defined library blocks with copies of the library blocks in the saved file.

BreakToolboxLinks — Break all toolbox links

`false` (default) | `true` | `'on'` | `'off'`

Break all toolbox links, specified by a logical value that indicates whether the function replaces links to built-in MathWorks library blocks with copies of the library blocks in the saved file. The `'BreakToolboxLinks'` option affects Simulink library blocks and blocks from any other libraries supplied with MathWorks toolboxes or blocksets.

Note The `'BreakToolboxLinks'` option can result in compatibility issues when upgrading to newer versions of Simulink software. For example:

- Any masks on top of library links to Simulink S-functions will not upgrade to the new version of the S-function.
- Any library links to masked subsystems in a Simulink library will not upgrade to the new subsystem behavior.
- Any broken links prevent the automatic library forwarding mechanism from upgrading the link.

If you have saved a model with broken links to built-in libraries, use the Upgrade Advisor to scan the model for out-of-date blocks and upgrade the Simulink blocks to their current versions.

Output Arguments

exported_file — Exported file

character vector

Path of the exported file, returned in the format that the specified previous Simulink version can load.

exported_project — Exported project in a ZIP file

character vector

Path of the ZIP file containing the exported project, returned in the format that the specified previous Simulink version can load.

Limitations

Simulink.exportToVersion does not support exporting external test harnesses to previous releases.

- For models with external test harnesses, Simulink.exportToVersion automatically converts them to internal test harnesses.
- For projects containing models with external test harnesses, Simulink.exportToVersion exports the projects and reports the test harnesses as missing files.

See Also

save_system

Topics

"Save the Model"

Introduced in R2016a

Simulink.history.clear

Clear the Simulink start page and editor history

Syntax

```
Simulink.history.clear
```

Description

`Simulink.history.clear` clears the list of favorites and the list of recent models and projects in the Simulink start page and editor.

Examples

Clear All Simulink History

To clear all Simulink history, in the Command Window, type:

```
Simulink.history.clear()
```

See Also

Topics

“Open a Model”

Introduced in R2020b

Simulink.fileGenControl

Specify root folders for files generated by diagram updates and model builds

Syntax

```
cfg = Simulink.fileGenControl('getConfig')  
Simulink.fileGenControl(Action,Name,Value)
```

Description

`cfg = Simulink.fileGenControl('getConfig')` returns a handle to an instance of the `Simulink.FileGenConfig` object, which contains the current values of these file generation control parameters:

- `CacheFolder` - Specifies the root folder for model build artifacts that are used for simulation, including Simulink® cache files.
- `CodeGenFolder` - Specifies the root folder for code generation files.
- `CodeGenFolderStructure` - Controls the folder structure within the code generation folder.

To get or set the parameter values, use the `Simulink.FileGenConfig` object.

These Simulink preferences determine the initial parameter values for the MATLAB session:

- Simulation cache folder - `CacheFolder`
- Code generation folder - `CodeGenFolder`
- Code generation folder structure - `CodeGenFolderStructure`

`Simulink.fileGenControl(Action,Name,Value)` performs an action that uses the file generation control parameters of the current MATLAB session. Specify additional options with one or more `name,value` pair arguments.

Examples

Get File Generation Control Parameter Values

To obtain the file generation control parameter values for the current MATLAB session, use `getConfig`.

```
cfg = Simulink.fileGenControl('getConfig');  
  
myCacheFolder = cfg.CacheFolder;  
myCodeGenFolder = cfg.CodeGenFolder;  
myCodeGenFolderStructure = cfg.CodeGenFolderStructure;
```

Set File Generation Control Parameters by Using Simulink.FileGenConfig Object

To set the file generation control parameter values for the current MATLAB session, use the `setConfig` action. First, set values in an instance of the `Simulink.FileGenConfig` object. Then,

pass the object instance. This example assumes that your system has `aNonDefaultCacheFolder` and `aNonDefaultCodeGenFolder` folders.

```
% Get the current configuration
cfg = Simulink.fileGenControl('getConfig');

% Change the parameters to non-default locations
% for the cache and code generation folders
cfg.CacheFolder = fullfile('C:', 'aNonDefaultCacheFolder');
cfg.CodeGenFolder = fullfile('C:', 'aNonDefaultCodeGenFolder');
cfg.CodeGenFolderStructure = 'TargetEnvironmentSubfolder';

Simulink.fileGenControl('setConfig', 'config', cfg);
```

Set File Generation Control Parameters Directly

You can set file generation control parameter values for the current MATLAB session without creating an instance of the `Simulink.FileGenConfig` object. This example assumes that your system has `aNonDefaultCacheFolder` and `aNonDefaultCodeGenFolder` folders.

```
myCacheFolder = fullfile('C:', 'aNonDefaultCacheFolder');
myCodeGenFolder = fullfile('C:', 'aNonDefaultCodeGenFolder');

Simulink.fileGenControl('set', 'CacheFolder', myCacheFolder, ...
    'CodeGenFolder', myCodeGenFolder, ...
    'CodeGenFolderStructure', ...
    Simulink.filegen.CodeGenFolderStructure.TargetEnvironmentSubfolder);
```

If you do not want to generate code for different target environments in separate folders, for `'CodeGenFolderStructure'`, specify the value `Simulink.filegen.CodeGenFolderStructure.ModelSpecific`.

Reset File Generation Control Parameters

You can reset the file generation control parameters to values from Simulink preferences.

```
Simulink.fileGenControl('reset');
```

Create Simulation Cache and Code Generation Folders

To create file generation folders, use the `set` action with the `'createDir'` option. You can keep previous file generation folders on the MATLAB path through the `'keepPreviousPath'` option.

```
%
myCacheFolder = fullfile('C:', 'aNonDefaultCacheFolder');
myCodeGenFolder = fullfile('C:', 'aNonDefaultCodeGenFolder');

Simulink.fileGenControl('set', ...
    'CacheFolder', myCacheFolder, ...
    'CodeGenFolder', myCodeGenFolder, ...
    'createDir', true, ...
    'keepPreviousPath', true);
```

```
'keepPreviousPath',true, ...
'createDir',true);
```

Input Arguments

Action — Specify action

'reset' | 'set' | 'setConfig'

Specify an action that uses the file generation control parameters of the current MATLAB session:

- 'reset' - Reset file generation control parameters to values from Simulink preferences.
- 'set' - Set file generation control parameters for the current MATLAB session by directly passing values.
- 'setConfig' - Set file generation control parameters for the current MATLAB session by using an instance of a `Simulink.FileGenConfig` object.

Name-Value Pair Arguments

Specify optional comma-separated pairs of `Name`, `Value` arguments. `Name` is the argument name and `Value` is the corresponding value. `Name` must appear inside quotes. You can specify several name and value pair arguments in any order as `Name1, Value1, ..., NameN, ValueN`.

Example: `Simulink.fileGenControl(Action, Name, Value)`;

config — Specify instance of Simulink.FileGenConfig

object handle

Specify the `Simulink.FileGenConfig` object instance containing file generation control parameters that you want to set.

Option for `setConfig`.

Example: `Simulink.fileGenControl('setConfig', 'config', cfg)`;

CacheFolder — Specify simulation cache folder

character vector

Specify a simulation cache folder path value for the `CacheFolder` parameter.

Option for `set`.

Example: `Simulink.fileGenControl('set', 'CacheFolder', myCacheFolder)`;

CodeGenFolder — Specify code generation folder

character vector

Specify a code generation folder path value for the `CodeGenFolder` parameter. You can specify an absolute path or a path relative to build folders. For example:

- 'C:\Work\mymodelsimcache' and '/mywork/mymodelgencode' specify absolute paths.
- 'mymodelsimcache' is a path relative to the current working folder (`pwd`). The software converts a relative path to a fully qualified path at the time the `CacheFolder` or `CodeGenFolder` parameter is set. For example, if `pwd` is '/mywork', the result is '/mywork/mymodelsimcache'.

- `'../test/myModelgenCode'` is a path relative to `pwd`. If `pwd` is `'/mywork'`, the result is `'/test/myModelgenCode'`.

Option for `set`.

Example: `Simulink.fileGenControl('set', 'CodeGenFolder', myCodeGenFolder);`

CodeGenFolderStructure — Specify generated code folder structure

`Simulink.filegen.CodeGenFolderStructure.ModelSpecific` (default) |
`Simulink.filegen.CodeGenFolderStructure.TargetEnvironmentSubfolder`

Specify the layout of subfolders within the generated code folder:

- `Simulink.filegen.CodeGenFolderStructure.ModelSpecific` (default) - Place generated code in subfolders within a model-specific folder.
- `Simulink.filegen.CodeGenFolderStructure.TargetEnvironmentSubfolder` - If models are configured for different target environments, place generated code for each model in a separate subfolder. The name of the subfolder corresponds to the target environment.

Option for `set`.

Example: `Simulink.fileGenControl('set', 'CacheFolder', myCacheFolder, ...
'CodeGenFolder', myCodeGenFolder, ... 'CodeGenFolderStructure', ...
Simulink.filegen.CodeGenFolderStructure.TargetEnvironmentSubfolder);`

keepPreviousPath — Keep previous folder paths on MATLAB path

`false` (default) | `true`

Specify whether to keep the previous values of `CacheFolder` and `CodeGenFolder` on the MATLAB path:

- `true` - Keep previous folder path values on MATLAB path.
- `false` (default) - Remove previous folder path values from MATLAB path.

Option for `reset`, `set`, or `setConfig`.

Example: `Simulink.fileGenControl('reset', 'keepPreviousPath', true);`

createDir — Create folders for file generation

`false` (default) | `true`

Specify whether to create folders for file generation if the folders do not exist:

- `true` - Create folders for file generation.
- `false` (default) - Do not create folders for file generation.

Option for `set` or `setConfig`.

Example: `Simulink.fileGenControl('set', 'CacheFolder', myCacheFolder,
'CodeGenFolder', myCodeGenFolder, 'keepPreviousPath', true,
'createDir', true);`

Avoid Naming Conflicts

Using `Simulink.fileGenControl` to set `CacheFolder` and `CodeGenFolder` adds the specified folders to your MATLAB search path. This function has the same potential for introducing a naming

conflict as using `addpath` to add folders to the search path. For example, a naming conflict occurs if the folder that you specify for `CacheFolder` or `CodeGenFolder` contains a model file with the same name as an open model. For more information, see “What Is the MATLAB Search Path?” and “Files and Folders that MATLAB Accesses”.

To use a nondefault location for the simulation cache folder or code generation folder:

- 1 Delete any potentially conflicting artifacts that exist in:
 - The current working folder, `pwd`.
 - The nondefault simulation cache and code generation folders that you intend to use.
- 2 Specify the nondefault locations for the simulation cache and code generation folders by using `Simulink.fileGenControl` or Simulink preferences.

Output Arguments

cfg — Current values of file generation control parameters

object handle

Instance of a `Simulink.FileGenConfig` object, which contains the current values of file generation control parameters.

See Also

“Simulation cache folder” | “Code generation folder” | Code generation folder structure

Topics

“Manage Build Process Folders” (Simulink Coder)

“Share Simulink Cache Files for Faster Simulation”

Introduced in R2010b

Simulink.findBlocks

Find blocks in Simulink models

Syntax

```
bl = Simulink.findBlocks(sys)
bl = Simulink.findBlocks(sys,options)
bl = Simulink.findBlocks(sys,Param1,Value1,...,ParamN,ValueN)
bl = Simulink.findBlocks(sys,Param1,Value1,...,ParamN,ValueN,options)
```

Description

`bl = Simulink.findBlocks(sys)` returns handles to all blocks in the model or subsystem `sys`.

`bl = Simulink.findBlocks(sys,options)` finds blocks that match the criteria specified by a `Simulink.FindOptions` object.

`bl = Simulink.findBlocks(sys,Param1,Value1,...,ParamN,ValueN)` finds blocks whose block parameters have the specified values.

`bl = Simulink.findBlocks(sys,Param1,Value1,...,ParamN,ValueN,options)` finds blocks whose parameters have the specified values and that match the criteria specified by a `FindOptions` object.

Examples

Find Blocks in a Model

Return handles for all blocks in the model `vdp`.

```
load_system('vdp');
bl = Simulink.findBlocks('vdp')
```

```
bl =
```

```
1.0e+03 *
```

```
9.4450
9.4460
9.4470
9.4480
9.4490
9.4500
9.4510
9.4520
9.4530
9.4540
9.4550
9.4560
9.4570
9.4580
```

Return block names.

```
bl = getfullname(Simulink.findBlocks('vdp'))
```

```
bl =
```

```
14x1 cell array
```

```
{'vdp/Constant'      }
{'vdp/More Info'    }
{'vdp/More Info/Model Info'}
{'vdp/Mu'           }
{'vdp/Mux'          }
{'vdp/Product'      }
{'vdp/Scope'        }
{'vdp/Square'       }
{'vdp/Sum'          }
{'vdp/Sum1'         }
{'vdp/x1'           }
{'vdp/x2'           }
{'vdp/Out1'         }
{'vdp/Out2'         }
```

Return block handles for the block whose name is Mu.

```
Simulink.findBlocks('vdp', 'Name', 'Mu')
```

```
ans =
```

```
9.4480e+03
```

Input Arguments

sys — Model or subsystem to find blocks in

character vector | string array

Model or subsystem to find blocks in, specified as a character vector or string array.

Example: 'vdp' "f14/Aircraft Dynamics Model"

options — Search constraints

Simulink.FindOptions object

Search constraints, specified as a Simulink.FindOptions object.

Output Arguments

bl — Search results

array of handles

Search results, returned as an array of handles.

See Also

Simulink.FindOptions | Simulink.findBlocksOfType | Simulink.allBlockDiagrams

Topics

“Block-Specific Parameters” on page 6-26

Introduced in R2018a

Simulink.findBlocksOfType

Find specified type of block in Simulink models

Syntax

```
bl = Simulink.findBlocksOfType(sys,type)
bl = Simulink.findBlocksOfType(sys,type,options)
bl = Simulink.findBlocksOfType(sys,type,Param1,Value1,...,ParamN,ValueN)
bl = Simulink.findBlocksofType(sys,type,Param1,Value1,...,ParamN,ValueN,
options)
```

Description

`bl = Simulink.findBlocksOfType(sys,type)` returns handles to all blocks of the specified type in the model or subsystem `sys`.

`bl = Simulink.findBlocksOfType(sys,type,options)` matches the criteria specified by a `FindOptions` object.

`bl = Simulink.findBlocksOfType(sys,type,Param1,Value1,...,ParamN,ValueN)` finds blocks whose parameters have the specified values.

`bl = Simulink.findBlocksofType(sys,type,Param1,Value1,...,ParamN,ValueN,options)` finds blocks whose parameters have the specified values and that match the criteria specified by a `FindOptions` object.

Examples

Find Blocks of a Type in Model

Find all blocks of type Gain in the model `vdp`.

```
load_system('vdp');
Simulink.findBlocksOfType('vdp','Gain')
```

```
ans =
    7.0001
```

To return block names instead of handles, use `getfullname`.

```
getfullname(Simulink.findBlocksOfType('vdp','Gain'))
```

```
ans =
    'vdp/Mu'
```

Find Blocks of a Type Using Search Options

Load the model `sldemo_clutch`. Then, create a `FindOptions` object and use it to constrain the search of `GoTo` blocks in the model to the Unlocked system.

```
openExample('sldemo_clutch');
f = Simulink.FindOptions('SearchDepth',1);
bl = Simulink.findBlocksOfType('sldemo_clutch/Unlocked','Goto',f)

bl =

    166.0001
    167.0001
```

Input Arguments

sys — Model or subsystem to find blocks in

character vector | string array

Model or subsystem to find blocks in, specified as a character vector or string array.

Example: `'vdp' "f14/Aircraft Dynamics Model"`

type — Block type

character vector | string scalar

Block type, specified as a character vector or string scalar. Use `get_param` with the `'BlockType'` parameter to get the block type.

options — Search constraints

`simulink.FindOptions` object

Search constraints, specified as a `Simulink.FindOptions` object.

Example: `Simulink.FindOptions('SearchDepth',1)`

Output Arguments

bl — Search results

array of handles

Search results, returned as an array of handles.

See Also

`Simulink.FindOptions` | `Simulink.findBlocks` | `Simulink.allBlockDiagrams`

Topics

“Block-Specific Parameters” on page 6-26

Introduced in R2018a

Simulink.findIntEnumType

Find enumeration classes defined by `Simulink.defineIntEnumType`

Syntax

```
result = Simulink.findIntEnumType(typeName)
result = Simulink.findIntEnumType()
```

Description

`result = Simulink.findIntEnumType(typeName)` returns the `meta.class` object for class `type` that is defined by `Simulink.defineIntEnumType`. Use the returned `meta.class` object to query attributes of the enumeration class. If the class does not exist, the function returns an empty `meta.class` object.

`result = Simulink.findIntEnumType()` returns `meta.class` objects for all enumeration classes that are defined by `Simulink.defineIntEnumType`. Use the returned `meta.class` objects to query attributes of the enumeration classes.

Examples

Find a Specific Dynamic Enumerated Data Type

Define an enumeration type.

```
Simulink.defineIntEnumType('myEnumType', {'e1', 'e2'}, [1 2]);
```

Check for the enumeration type that you have created.

```
myResult = Simulink.findIntEnumType('myEnumType')
```

```
myResult =
```

```
class with properties:
```

```

        Name: 'myEnumType'
      Description: ''
DetailedDescription: ''
        Hidden: 0
        Sealed: 0
        Abstract: 0
      Enumeration: 1
ConstructOnLoad: 0
HandleCompatible: 0
InferiorClasses: {[1x1 meta.class]}
ContainingPackage: [0x0 meta.package]
RestrictsSubclassing: 0
      PropertyList: [0x1 meta.property]
      MethodList: [150x1 meta.method]
      EventList: [0x1 meta.event]
```

```
EnumerationMemberList: [2×1 meta.EnumeratedValue]  
SuperclassList: [1×1 meta.class]
```

Find All Dynamic Enumerated Data Types

Define two enumeration types.

```
Simulink.defineIntEnumType('myEnumType1', {'e1', 'e2'}, [1 2]);  
Simulink.defineIntEnumType('myEnumType2', {'e3', 'e4'}, [3 4]);
```

Check for the enumeration types that you have created.

```
myResult = Simulink.findIntEnumType()
```

Input Arguments

typeName — Name of enumeration class

character vector or string

Name of a specific enumeration class that is defined by `Simulink.defineIntEnumType`, specified as a character vector or string.

Example: 'myEnumType'

Data Types: char | string

Output Arguments

result — Search results

array of `meta.class` objects

Search result, returned as an array of `meta.class` objects. If there are no enumeration classes, the array is empty.

See Also

[enumeration](#) | [Simulink.clearIntEnumType](#) | [Simulink.defineIntEnumType](#)

Introduced in R2018b

Simulink.findTemplates

Find model or project templates with specified properties

Syntax

```
filename = Simulink.findTemplates(templatename)
filename = Simulink.findTemplates(templatename,Name,Value)
[filename,info] = Simulink.findTemplates(templatename)
```

Description

`filename = Simulink.findTemplates(templatename)` returns the names and `TemplateInfo` objects for all matching templates that include `templatename`.

`filename = Simulink.findTemplates(templatename,Name,Value)` also specifies additional template properties as one or more `Name, Value` pair arguments.

`[filename,info] = Simulink.findTemplates(templatename)` returns the names and `TemplateInfo` objects for all matching templates.

Examples

Find a Particular Template

Get the full path to the default model template.

```
filename = Simulink.findTemplates('factory_default_model');
```

Find All Templates With Specified Folders or Authors

Get all templates inside folders called `work`.

```
filename = Simulink.findTemplates('work/')
```

Get all templates for which the `Author` property includes the character vector `Smith`.

```
filename = Simulink.findTemplates('*', 'Author', 'Smith')
```

Find All DSP Templates and Get TemplateInfo Objects

Get the paths to all DSP model templates, and `sltemplate.TemplateInfo` objects for each of them.

```
[filename,info] = Simulink.findTemplates('dsp*', 'Type', 'Model');
```

Input Arguments

templatename — Template name

character vector

Template name, specified as a character vector containing a portion of a file name, which can contain the wildcard asterisk character “*”.

Example:

Data Types: char

Name-Value Pair Arguments

Specify optional comma-separated pairs of `Name`, `Value` arguments. `Name` is the argument name and `Value` is the corresponding value. `Name` must appear inside quotes. You can specify several name and value pair arguments in any order as `Name1, Value1, . . . , NameN, ValueN`.

You can specify regular expressions for any of the `Value` character vectors, e.g., including the wildcard asterisk character “*”.

Example: 'Author', '*son'

Type — Model, library, or project

'Model' | 'Library' | 'Project'

Model, library, or project template type, specified as a character vector for model, library, or project.

Example: 'Simscape'

Data Types: char

Title — Title of template

character vector

Title of template, specified as a character vector.

Example: 'Simscape'

Data Types: char

Group — Group of template

character vector

Group of template, specified as a character vector. On the Start Page, templates are shown under group headings.

Example: 'Simscape'

Data Types: char

Author — Author of template

character vector

Author of template, specified as a character vector.

Data Types: char

Description — Description of template

character vector

Description of template, specified as a character vector.

Data Types: char

Output Arguments**filename — Template name**

character vector | cell array of character vectors

Template names of matching templates, returned as character vectors.

info — Template information

template info objects | array of template info objects

Template information of matching templates, returned as `sltemplate.TemplateInfo` objects.

See Also

`Simulink.createFromTemplate` | `Simulink.exportToTemplate`

Topics

“Build and Edit a Model Interactively”

“Create Template from Model”

“Using Templates to Create Standard Project Settings”

Introduced in R2016a

Simulink.findVars

Analyze relationship between variables and blocks in models

Syntax

```
[variables] = Simulink.findVars(context)
[variables] = Simulink.findVars(context,variablefilter)
[variables] = Simulink.findVars( ____,Name,Value)
```

Description

`[variables] = Simulink.findVars(context)` finds and returns variables that are used in the blocks and models specified by `context`, including subsystems and referenced models. The function returns an empty vector if `context` does not use any variables.

`[variables] = Simulink.findVars(context,variablefilter)` finds only the variables or enumerated types that are specified by `variablefilter`. For example, use this syntax to determine where a variable is used in a model.

`[variables] = Simulink.findVars(____,Name,Value)` finds variables with additional options specified by one or more `Name,Value` pair arguments. For example, you can search for unused variables. You can also search for enumerated data types that are used in `context`, in addition to variables.

Examples

Variables in Use in a Model

Find variables used by `MyModel`.

```
variables = Simulink.findVars('MyModel');
```

Specific Variable in Use in a Model

Find all uses of the base workspace variable `k` by `MyModel`. Use the cached results to avoid compiling `MyModel`.

```
variables = Simulink.findVars('MyModel','Name','k',
'SearchMethod','cached','SourceType','base workspace');
```

Regular Expression Matching

Find all uses of a variable whose name matches the regular expression `^trans`.

```
variables = Simulink.findVars('MyModel', 'Regex', 'on',  
'Name', '^trans');
```

Variables Common to Two Models

Given two models, find the variables used by the first model, the second, and both

```
model1Vars = Simulink.findVars('model1');  
model2Vars = Simulink.findVars('model2');  
commonVars = intersect(model1Vars,model2Vars);
```

Variables Not Used in a Model

Find the variables that are defined in the model workspace of MyModel but that are not used by the model.

```
unusedVars = Simulink.findVars('MyModel', 'FindUsedVars', 'off',  
'SourceType', 'model workspace');
```

Specific Variable Not Used in a Model

Determine if the base workspace variable k is not used by MyModel.

```
varObj = Simulink.VariableUsage('k', 'base workspace');  
unusedVar = Simulink.findVars('MyModel', varObj,  
'FindUsedVars', 'off');
```

Variables Used by a Block

Find the variables that are used by the block Gain1 in MyModel.

```
variables = Simulink.findVars('MyModel',  
'Users', 'MyModel/Gain1');
```

Variables Used in a Model Reference Hierarchy

Find the variables that are used in a model reference hierarchy. Begin the search with the model MyNestedModel, and search the entire hierarchy below MyNestedModel.

```
variables = Simulink.findVars('MyNestedModel', 'SearchReferencedModels', 'on');
```

Variables and Enumerated Types Used in a Model

Find variables and enumerated types that are used in MyModel.

```
varsAndEnumTypes = Simulink.findVars('MyModel','IncludeEnumTypes','on');
```

Input Arguments

context — Models and blocks to search

character vector | string | cell array of character vectors | string array

Models and blocks to search, specified as a character vector, string, cell array of character vectors, or a string array. You can specify `context` in one of the following ways:

- The name of a model. For example, ('vdp') specifies the model `vdp.slx`.
- The name or path of a block or masked block. For example, ('vdp/Gain1') specifies a block named `Gain1` at the root level of the model `vdp.slx`.
- A cell array of model or block names.

Data Types: `char` | `cell`

variablefilter — Specific variables to find

array of `Simulink.VariableUsage` objects

Specific variables to find, specified as an array of `Simulink.VariableUsage` objects. Each `Simulink.VariableUsage` object identifies a variable to find.

Name-Value Pair Arguments

Specify optional comma-separated pairs of `Name`, `Value` arguments. `Name` is the argument name and `Value` is the corresponding value. `Name` must appear inside quotes. You can specify several name and value pair arguments in any order as `Name1, Value1, ..., NameN, ValueN`.

Example: 'FindUsedVars', 'off'

FindUsedVars — Find variables that are used or not used

'on' (default) | 'off'

Flag to find variables that are explicitly used or not used, specified as the comma-separated pair consisting of 'FindUsedVars' and 'on' or 'off'. If you specify `FindUsedVars` as 'off', the function finds variables that are not used in context but that are defined in the workspace specified by `SourceType`.

Example: 'FindUsedVars', 'off'

IncludeEnumTypes — Find enumerated types that are used

'off' (default) | 'on'

Flag to find enumerated data types that are used, specified as the comma-separated pair consisting of 'IncludeEnumTypes' and 'on' or 'off'. The function finds enumerated types that are used explicitly in context as well as types that define variables that are used in context.

The function does not report details about which blocks or objects are using the enumerated types.

If you specify `SourceType` as 'base workspace', 'model workspace', or 'mask workspace', the function does not report enumerated types because those sources cannot define enumerated types.

You cannot find unused enumerated types by specifying `FindUsedVars` as 'off'.

Example: 'IncludeEnumTypes', 'on'

RegExp — Enable regular expression matching

'off' (default) | 'on'

Flag to enable regular expression matching for input arguments, specified as the comma-separated pair consisting of 'RegExp' and 'on'. You can match only input arguments that have character vector values.

Example: 'RegExp', 'on'

SearchMethod — Compile status

'compiled' (default) | 'cached'

Compile status, specified as the comma-separated pair consisting of 'SearchMethod' and one of these values:

- 'compiled' — Return up-to-date results by compiling every model in the search context before search.
- 'cached' — Return quicker results by using results cached during the previous compile.

Example: 'SearchMethod', 'compiled'

SearchReferencedModels — Enable search in referenced models

'off' (default) | 'on'

Flag to enable search in referenced models, specified as the comma-separated pair consisting of 'SearchReferencedModels' and 'on'.

If a referenced model uses a global variable, such as a variable stored in a data dictionary, the function returns this global variable when called on the parent model. If SearchReferencedModels is set to 'on', the Simulink.VariableUsage object returned by the function specifies a block in the referenced model as the variable user. Otherwise, the object specifies the Model block as the user.

Example: 'SearchReferencedModels', 'on'

Name — Name of a variable or enumerated type to search for

character vector | string

Name of a variable or enumerated data type to search for, specified as the comma-separated pair consisting of 'Name' and a character vector or string.

Example: 'Name', 'trans'

Data Types: char

SourceType — Workspace or source defining the variables or enumerated types

character vector | string

Workspace or source defining the variables, specified as the comma-separated pair of 'SourceType' and one of these options:

- 'base workspace'
- 'model workspace'
- 'mask workspace'

- 'data dictionary'

The function filters results for variables that are defined in the specified source.

Example: 'SourceType', 'base workspace'

If you search for enumerated data types by specifying 'IncludeEnumTypes' as 'on', 'SourceType' represents the way an enumerated type is defined. You can specify one of these options:

- 'MATLAB file'
- 'dynamic class'
- 'data dictionary'

The function filters results for enumerated types that are defined in the specified source.

Example: 'SourceType', 'MATLAB file'

If you do not specify SourceType, the function does not filter results by source.

Users — Name of block to search for variables

character vector | string

Name of specific block to search for variables, specified as the comma-separated pair consisting of 'Users' and a character vector or string.

To search a set of specific blocks, enable regular expression matching by specifying RegExp as 'on' and use regular expressions in the character vector. For example, you can specify 'Users', 'MyModel/Gain*' to search all blocks in MyModel whose names begin with Gain.

Example: 'Users', 'MyModel/Gain1'

Example: 'Users', 'MyModel/mySubsystem/Gain2'

Example: 'Users', 'MyModel/Gain*'

Limitations

Simulink.findVars does not work with these constructs:

- MATLAB code in scripts and initialization and callback functions
- Libraries and blocks in libraries
- Variables in MATLAB Function blocks, except for input arguments

However, Simulink.findVars can find enumerated types anywhere they are used in MATLAB Function blocks.

- Calls directly to MATLAB from the Stateflow action language
- S-functions that use data type variables registered using ssRegisterDataType

To make the variables searchable, use ssRegisterTypeFromNamedObject instead.

- Variables referenced by machine-parented data in Stateflow.
- Variables inside a string.
- Field in a struct.

- Top models configured for parallel model reference builds. In this case, `Simulink.findVars` does not work when called with either of these name-value arguments:
 - `'SearchMethod'` specified as `'cached'`.
 - `'SearchReferencedModels'` specified as `'on'`.

`Simulink.findVars` discovers variable usage in inactive subsystem variants only if you set the **Variant activation time** parameter to `code compile` in the Variant Subsystem block dialog box. If you do not select this check box, the function does not discover variable usage in inactive variants.

See Also

`Simulink.VariableUsage` | `find_system` | `intersect`

Topics

Model Explorer

“Manage Design Data”

Introduced in R2010a

Simulink.fmuexport.ExportSimulinkProjectToFMU

Export project as Functional Mockup Unit (FMU)

Syntax

```
Simulink.fmuexport.ExportSimulinkProjectToFMU(project,model,Name,Value)
```

Description

`Simulink.fmuexport.ExportSimulinkProjectToFMU(project,model,Name,Value)` exports a project as a Functional Mockup Unit (FMU) and sets the `model` as the main interface model.

Examples

Export Model and Set FMU Icon

If the Simulink model `EngineGasDynamics.slx` exists in the `project root/models/` folder, use the following command to export the FMU from project root:

```
project = slproject.getCurrentProject;...
Simulink.fmuexport.ExportSimulinkProjectToFMU(project,'models/EngineGasDynamics.slx','-fmuname',fullfile(project.RootFolder,'EngineGasDynamics.slx'))
```

Input Arguments

project — Project to export

scalar (default)

Project to export, specified as a string.

Data Types: `string`

model — Model that defines main interface

scalar (default)

Model that defines the main interface, specified as a string.

Data Types: `string`

Name-Value Pair Arguments

Specify optional comma-separated pairs of `Name`, `Value` arguments. `Name` is the argument name and `Value` is the corresponding value. `Name` must appear inside quotes. You can specify several name and value pair arguments in any order as `Name1,Value1,...,NameN,ValueN`.

Example:

-fmuname — The location and name of the generated FMU relative to the current working folder

`string`

If not specified, FMU is saved to current directory folder with the same name as the main model.

Data Types: `string`

-description — The description of the generated FMU

string (default)

The information is saved in modelDescription.xml inside FMU.

Data Types: string

-author — The author of the generated FMU

string (default)

The information is saved in modelDescription.xml inside FMU.

Data Types: string

-copyright — The copyright of the generated FMU

string (default)

The information is saved in modelDescription.xml inside FMU.

Data Types: string

-license — The license of the generated FMU

string (default)

The information is saved in modelDescription.xml inside FMU.

Data Types: string

-fmuicon — An icon file for the generated FMU

string (default)

The icon file must be in PNG format. If not specified, generated FMU has no icon file.

Data Types: string

See Also**Functions**

slproject.create

Topics

“Export a Model as a Tool-Coupling FMU”

Introduced in R2018b

Simulink.getFileChecksum

Checksum of file

Syntax

```
checksum = Simulink.getFileChecksum(filename)
```

Description

`checksum = Simulink.getFileChecksum(filename)` returns the checksum of the specified file, using the MD5 checksum algorithm. Use the checksum to see if the file has changed compared to a previous checksum. You can use checksums as part of an audit trail.

Use `Simulink.getFileChecksum` to get a checksum for any file. If the file contents do not change from one checksum to the next, the checksum from `Simulink.getFileChecksum` stays the same. Otherwise, the checksum is different with each change to the file contents.

For functional information on a model, use `Simulink.BlockDiagram.getChecksum` instead. `Simulink.BlockDiagram.getChecksum` looks at the functional aspect of the model. If the functional aspect doesn't change, then `Simulink.BlockDiagram.getChecksum` returns the same checksum.

For example, if you moved a block, the file contents are different (measured by `Simulink.getFileChecksum`) but the function of the model is unchanged (measured by `Simulink.BlockDiagram.getChecksum`).

Examples

Get Checksum of a File

Use `fullfile` to specify a full path to a file and get the checksum.

```
filechecksum = Simulink.getFileChecksum(fullfile(matlabroot, 'toolbox', ...  
'matlab', 'demos', 'gatlin.mat'));
```

Input Arguments

filename — File name to get checksum for

file of any type

File name to get checksum for, with file extension and optional full path. Use `fullfile` to specify a full path to a file, or use the form `'C:\Work\filename.mat'`.

Example: `'lengthoffline.m'`

Data Types: char

Output Arguments

checksum — Checksum value

character vector

Checksum value in a 32-character vector.

See Also

`Simulink.BlockDiagram.getChecksum` | `Simulink.SubSystem.getChecksum`

Introduced in R2014b

Simulink.getOutputInheritsInitialValue

Determine if conditional subsystem Output block inherits initial output value

Syntax

```
tf = Simulink.getOutputInheritsInitialValue(outblock)
```

Description

`tf = Simulink.getOutputInheritsInitialValue(outblock)` evaluates whether `outblock` is a conditional subsystem Output block that inherits its initial output value from an input signal connected to the conditional subsystem. If so, it returns `true`. If not, it returns `false`. The return value is `true` under the same circumstances as the  badge is displayed next to the Output block on the Simulink canvas, as described in “Conditional Subsystem Initial Output Values”.

For the return value to be accurate, update or run the model before calling this function.

The value returned by this function is meaningful only if the model is using simplified initialization mode. See “Simplified Initialization Mode”. If the model is using classic initialization mode, the return value is always `false`.

Examples

Determine If Output Block Inherits Initial Output Value

The model `my_model` contains the enabled subsystem `EnabledSub1`, which contains Output blocks `Out1` and `Out2`.

```
set_param('my_model/EnabledSub1/Out1','InitialOutput','0'); % Explicit initial output value
set_param('my_model','SimulationCommand','Update'); % Update model
inherits = Simulink.getOutputInheritsinitialValue('my_model/EnabledSub1/Out1')
```

```
inherits =
```

```
logical
```

```
0
```

```
set_param('my_model/EnabledSub1/Out2','InitialOutput','[]'); % Inherit initial output value
set_param('my_model','SimulationCommand','Update'); % Update model
inherits = Simulink.getOutputInheritsinitialValue('my_model/EnabledSub1/Out2')
```

```
inherits =
```

```
logical
```

```
1
```

```
inherits = Simulink.getOutputInheritsinitialValue({'my_model/EnabledSub1/Out1','my_model/EnabledSub1/Out2'})
```

```
inherits =  
  
    2×1 logical array  
  
    0  
    1
```

Input Arguments

outblock — Identifier of conditional subsystem Output block

character vector | string scalar | numeric handle

Identifier of conditional subsystem Output block, specified as a character vector, string scalar, or numeric handle. Multiple block identifiers may be specified as a vector or a 1-dimensional cell array.

Example: 'my_model/EnabledSub1/Out1'

Data Types: character vector | string scalar | handle | vector | cell array

Output Arguments

tf — Whether block inherits its initial output value

logical

Whether block inherits its initial output value, returned as a logical `true` or `false`. If the input value refers to an Output block connected to a conditional subsystem and the block inherits its initial output value from that subsystem's input signal, `tf` is `true`. Otherwise, `tf` is `false`. If the input value is a vector or a cell array, `tf` is a logical column vector.

For the return value to be accurate, update or run the model before calling this function.

Data Types: logical | logical vector

See Also

“Conditional Subsystem Initial Output Values” | Output

Introduced in R2021a

Simulink.getSuppressedDiagnostics

Return `Simulink.SuppressedDiagnostic` objects associated with a block, subsystem, or model

Syntax

```
suppressed_diagnostics = Simulink.getSuppressedDiagnostics(source)
```

Description

`suppressed_diagnostics = Simulink.getSuppressedDiagnostics(source)` returns an array of `Simulink.SuppressedDiagnostic` objects that are associated with the specified source.

Examples

Get All `Simulink.SuppressedDiagnostic` Objects on a Specific Block

Using the model from “Suppress Diagnostic Messages Programmatically”, get all suppressed diagnostics associated with a specified block.

Use the `Simulink.suppressDiagnostic` function to suppress the parameter precision loss warning thrown by the Constant block, one.

```
Simulink.suppressDiagnostic('Suppressor_CLI_Demo/one', ...
    'SimulinkFixedPoint:util:fxpParameterPrecisionLoss');
```

Get the `Simulink.SuppressedDiagnostic` objects associated with the block.

```
suppressed_diagnostic = Simulink.getSuppressedDiagnostics('Suppressor_CLI_Demo/one')
```

```
suppressed_diagnostic =
```

```
    SuppressedDiagnostic with properties:
```

```
        Source: 'Suppressor_CLI_Demo/one'
           Id: 'SimulinkFixedPoint:util:fxpParameterPrecis...'
LastModifiedBy: ''
        Comments: ''
        LastModified: '2016-Jul-04 14:12:24'
```

Input Arguments

source — System, block, or model object throwing warning

model | subsystem | block path | block handle

The source of the diagnostic, specified as a model, subsystem, block path, block handle, cell array of block paths, or cell array of block handles.

To get the block path, use the `gcb` function.

To get the block handle, use the `getSimulinkBlockHandle` function.

Data Types: char | cell

Output Arguments

suppressed_diagnostics — Suppressed diagnostics

array

Suppressed diagnostics, returned as an array of `Simulink.SuppressedDiagnostic` objects.

See Also

`Simulink.getSuppressedDiagnostics` | `Simulink.suppressDiagnostic` |
`Simulink.restoreDiagnostic` | `restore` | `Simulink.SuppressedDiagnostic`

Topics

“Suppress Diagnostic Messages Programmatically”

Introduced in R2016b

Simulink.ID.getHandle

Get handle of block, annotation, or Stateflow object

Note Simulink.ID.getHandle is not recommended. Use getSimulinkBlockHandle instead.

Syntax

```
hdl = Simulink.ID.getHandle(simulinkID)
```

Description

`hdl = Simulink.ID.getHandle(simulinkID)` returns the handle of the block, annotation, or Stateflow object that has the Simulink Identifier `simulinkID`.

Examples

Get Handle of Model Block

Open the model vdp.

```
vdp
```

Get the SID of the Sum block.

```
Simulink.ID.getSID('vdp/Sum')
```

```
ans =
```

```
'vdp:8'
```

Get the handle of the Sum block using the SID.

```
hdl = Simulink.ID.getHandle('vdp:8')
```

Input Arguments

simulinkID — Simulink Identifier

character vector | string scalar

Simulink Identifier of a block, annotation, or Stateflow object, specified as a character vector or string scalar.

Example: 'vdp:4'

Output Arguments

hdl — handle

double | object handle

Handle of a block, annotation, or Stateflow object, returned as a double or a Stateflow object handle.

See Also

[getSimulinkBlockHandle](#) | [hilite_system](#) | [Simulink.ID.getSID](#) | [Simulink.ID.hilite](#)

Topics

“Simulink Identifiers”

Introduced in R2009b

Simulink.ID.getSID

Get Simulink Identifier of block, annotation, or Stateflow object

Note Simulink.ID.getSID is not recommended. Use `find_system` instead.

Syntax

```
simulinkID = Simulink.ID.getSID(obj)
```

Description

`simulinkID = Simulink.ID.getSID(obj)` returns the Simulink Identifier (SID) of the block, annotation, or Stateflow object `obj`.

A Simulink Identifier (SID) is a unique and unmodifiable identifier. Use the SID to identify an object throughout its lifetime, even if the name of the object changes.

Examples

Get SID of Model Block

Open the model `vdp`.

```
vdp
```

Get the SID of the Mu block.

```
simulinkID = Simulink.ID.getSID('vdp/Mu')
```

Get SID of Annotation

Open the model `vdp`.

```
vdp
```

Select the annotation at the top of the diagram. To get the annotation object, use the function `getCurrentAnnotation`.

```
ann = getCurrentAnnotation
```

Get the SID of the annotation.

```
simulinkID = Simulink.ID.getSID(ann)
```

Get SID of Model Block Using Handle

Open the model vdp.

```
vdp
```

Get the handle of the Product block.

```
hdl = getSimulinkBlockHandle('vdp/Product')
```

Get the SID of the Product block using the handle as the input argument.

```
simulinkID = Simulink.ID.getSID(hdl)
```

Input Arguments

obj — Name or handle of block, annotation, or Stateflow object

character vector | string scalar | handle

Name or handle of a block, annotation, or Stateflow object, specified as a handle, character vector, or string scalar.

Example: 'vdp/Mu'

Output Arguments

simulinkID — Simulink Identifier

string scalar

Simulink Identifier (SID), returned as a string scalar.

See Also

[find_system](#) | [Simulink.ID.getHandle](#) | [Simulink.ID.hilite](#)

Topics

“Simulink Identifiers”

Introduced in R2009b

Simulink.ID.hilite

Highlight block, annotation, or Stateflow object

Note Simulink.ID.hilite is not recommended. Use `hilite_system` instead.

Syntax

```
Simulink.ID.hilite(simulinkID)
Simulink.ID.hilite(simulinkID,style)
```

Description

`Simulink.ID.hilite(simulinkID)` highlights the block, annotation, or Stateflow object that has the Simulink Identifier `simulinkID`.

`Simulink.ID.hilite(simulinkID,style)` uses the specified highlighting style.

Examples

Highlight Block

Open the model `vdp`.

```
vdp
```

Get the Simulink Identifier of the Mu block.

```
muSID = Simulink.ID.getSID('vdp/Mu')
```

Highlight the Mu block.

```
Simulink.ID.hilite(muSID)
```

Highlight Block Using a Highlight Style

Open the model `vdp`.

```
vdp
```

Get the Simulink Identifier of the Mu block.

```
muSID = Simulink.ID.getSID('vdp/Mu')
```

Highlight the Mu block using the style `'fade'`.

```
Simulink.ID.hilite(muSID, 'fade')
```

Input Arguments

simulinkID — Simulink Identifier

character vector | string scalar

Simulink Identifier of a block, annotation, or Stateflow object, specified as a character vector or string scalar.

Example: 'vdp:4'

style — Highlighting style

'find' (default) | character vector | string scalar

Highlighting style, specified as one of these values. You can customize the appearance of any of the styles. See “Customize a Highlighting Style” on page 2-315.

- 'default' — Default color scheme: red outline, yellow fill.
- 'none' — Clears the highlight.

To clear all highlighting, on the **Debug** tab, in the **Trace Signal** button group, click the **Remove trace** button.

- 'debug' — Uses default color scheme.
- 'different' — Applies red outline, white fill.
- 'error' — Uses default color scheme.
- 'fade' — Applies gray outline, white fill.
- 'find' — Applies dark blue outline, blue fill.
- 'lineTrace' — Applies red outline, blue fill.
- 'unique' — Dark blue outline, white fill.
- 'user1', 'user2', 'user3', 'user4', 'user5' — Applies custom highlight: black outline, white fill by default (that is, no highlight).

In addition, you can use these color schemes. The first word is the outline and the second is the fill color.

- 'orangeWhite'
- 'blackWhite'
- 'redWhite'
- 'blueWhite'
- 'greenWhite'

See Also

hilite_system | Simulink.ID.getSID | Simulink.ID.getHandle

Topics

“Simulink Identifiers”

Introduced in R2009b

Simulink.importExternalCTypes

Generate Simulink representations of custom data types defined by C or C++ code

Syntax

```
importInfo = Simulink.importExternalCTypes(headerFiles)
importInfo = Simulink.importExternalCTypes(modelName)
importInfo = Simulink.importExternalCTypes( ___,Name,Value)
```

Description

`importInfo = Simulink.importExternalCTypes(headerFiles)` parses the C or C++ header files (.h or .hpp) identified by `headerFiles` for `typedef`, `struct`, and `enum` type definitions, and generates Simulink representations of the types. The output, `importInfo`, identifies the successfully and unsuccessfully imported types.

You can use the Simulink representations to:

- Reuse your existing algorithmic C code and, through simulation, test its interaction with your Simulink control algorithm. For an example that shows how to use the Legacy Code Tool, see “Integrate C Function Whose Arguments Are Pointers to Structures”.
- Generate code (Simulink Coder) that reuses the types and data that your existing code defines. You can then integrate and compile the generated and existing code into a single application. For an example, see “Exchange Structured and Enumerated Data Between Generated and External Code” (Embedded Coder).
- Create and organize data (signals, parameters, and states) in a model by using standard data types that your organization defines in C code.
 - To create structures of signals in Simulink, use nonvirtual buses. See “Group Signal Lines into Virtual Buses”.
 - To create structures of parameters, use MATLAB structures and `Simulink.Parameter` objects. See “Organize Related Block Parameter Definitions in Structures”.
 - To create enumerated data, see “Use Enumerated Data in Simulink Models”.
 - To match a primitive `typedef` statement, use a `Simulink.AliasType` object to set parameter and signal data types in a model.

By default, the function:

- Imports an enumerated type by generating a script file that derives an enumeration class from `Simulink.IntEnumType`, as described in “Define Simulink Enumerations”. If necessary, you can then edit the class definition to customize it (for example, by implementing the `addClassNameToEnumNames` method).
- Imports a structure type by generating a `Simulink.Bus` object in the base workspace.
- Imports a primitive `typedef` statement by generating a `Simulink.AliasType` object in the base workspace.

- Interprets generic C data types, such as `int` or `short`, according to the word lengths of your host computer. For example, for most modern machines, `int` has a 32-bit word length, so the function represents an `int` structure field as a bus element that uses the Simulink data type `int32`.

To override this default behavior, identify your target hardware board by using the `HardwareImplementation` pair argument.

For additional information about default behavior, see “Tips” on page 2-739.

`importInfo = Simulink.importExternalCTypes(modelName)` generates Simulink representations of custom C data types by analyzing a model that you identify with `modelName`. When you use the **Simulation Target** configuration parameters in a model to identify header files for inclusion during simulation, use this syntax to import types for the purpose of simulating the model on your host computer. The function interprets generic C data types according to the word lengths of your host computer.

When you use this syntax, do not use pair arguments, such as `HardwareImplementation`, that can conflict with the configuration parameters of the target model. When you use such pair arguments with this syntax, the function generates a warning.

`importInfo = Simulink.importExternalCTypes(____, Name, Value)` specifies additional options using one or more name-value pair arguments. You can use this syntax to:

- Specify the names of types to import by using the `Names` pair argument.
- Control the way that Simulink stores the imported types, for example, by generating the types in a Simulink data dictionary. Use the `MATFile` and `DataDictionary` pair arguments.
- Control the way that the function interprets generic C data types. Use the `HardwareImplementation` pair argument.
- Maintain synchrony between the C-code definitions and the Simulink representations by attempting to import the updated C-code definitions again. You can choose whether to overwrite the existing Simulink representations. Use the `Overwrite` and `Verbose` pair arguments.

Examples

Import Simple Structure and Enumerated Types

This example shows how to generate Simulink representations of a C structure type (`struct`) and an enumerated (`enum`) data type from a header file.

- 1 In your current folder, create the file `ex_cc_simpleTypes.h`.

```
typedef enum {
    PWR_LOSS = 0,           /* Default value */
    OVERSPD,
    PRESS_LOW,
} fault_T;

typedef struct {
    double coeff;
    double init;
} params_T;
```

- 2 Generate Simulink representations of the types by calling `Simulink.importExternalCTypes`.

```
Simulink.importExternalCTypes('ex_cc_simpleTypes.h');
```

The function creates a `Simulink.Bus` object, `params_T`, in the base workspace.

- 3 To inspect the properties of the object, open the Bus Editor.

```
buseditor
```

Each bus element uses a name and a data type (`double`) that match the corresponding structure field in `ex_cc_simpleTypes.h`.

- 4 In your current folder, inspect the generated file, `fault_T.m`, which defines the enumerated type `fault_T` as an enumeration class.

You can use the bus object and the enumeration class to set signal and parameter data types in Simulink models.

Import Structure Type Whose Fields Use Custom Data Types

This example shows how to generate a Simulink representation of a structure type whose fields use custom data types (`typedef`).

Create the file `ex_integer_aliases.h` in your current folder.

```
typedef int sint_32;
typedef unsigned short uint_16;
```

Create the file `ex_cc_struct_alias.h` in your current folder.

```
#include "ex_integer_aliases.h"
typedef struct {
    sint_32 accum;
    uint_16 index;
} my_ints_T;
```

Import the structure type into Simulink as a `Simulink.Bus` object in the base workspace. Import the `typedef` statements as `Simulink.AliasType` objects.

```
Simulink.importExternalCTypes('ex_cc_struct_alias.h');
```

Inspect the data types of the bus elements in the bus object. For example, inspect the `DataType` property of the first bus element, which corresponds to the structure field `accum`.

```
my_ints_T.Elements(1)
```

```
ans =
```

```
    BusElement with properties:
```

```
        Name: 'accum'
    Complexity: 'real'
    Dimensions: 1
        DataType: 'sint_32'
```

```
        Min: []
        Max: []
DimensionsMode: 'Fixed'
    SampleTime: -1
        Unit: ''
Description: ''
```

The `Simulink.importExternalCTypes` function uses the generated `Simulink.AliasType` objects to set the data types of the bus elements.

Inspect the `Simulink.AliasType` objects in the base workspace. For example, the object named `sint_32` corresponds to one of the `typedef` statements in `ex_integer_aliases.h`.

```
sint_32
```

```
sint_32 =
```

```
AliasType with properties:
```

```
Description: ''
DataScope: 'Imported'
HeaderFile: 'ex_integer_aliases.h'
BaseType: 'int32'
```

For most host computers (which the function targets by default), the word length of `int` is 32 bits and the word length of `unsigned short` is 16 bits. The function maps `int` and `unsigned short` to the Simulink types `int32` and `uint16`.

If you have Embedded Coder, the code that you generate from the model can use `sint_32` and `uint_16` instead of the standard data type names, `int32_T` and `uint16_T`.

Store Imported Types in Data Dictionary

This example shows how to store the imported data types in a Simulink data dictionary. A data dictionary stores data specifications (such as for signals and block parameter values), data types, and other design data for one or more Simulink models.

In your current folder, create the file `ex_cc_simpleTypes.h`.

```
typedef enum {
    PWR_LOSS = 0,          /* Default value */
    OVERSPD,
    PRESS_LOW,
} fault_T;

typedef struct {
    double coeff;
    double init;
} params_T;
```

Create a subfolder called `myDictionaries`.

```
mkdir('myDictionaries')
```

Generate Simulink representations of the types by calling `Simulink.importExternalCTypes`. Permanently store the type definitions by creating a new data dictionary, `ex_cc_myTypes.sldd`, in the new subfolder.

```
Simulink.importExternalCTypes('ex_cc_simpleTypes.h',...
    'DataDictionary','ex_cc_myTypes.sldd',...
    'OutputDir','myDictionaries');
```

To inspect the contents of the dictionary, set your current folder to `myDictionaries` and double-click the dictionary file.

To use the Simulink representations in the dictionary, you must link a model or models to the dictionary. See “Migrate Models to Use Simulink Data Dictionary”.

Import Only Specified Types

This example shows how to generate Simulink representations only for enumerated and structure data types that you identify by name.

In your current folder, create the file `ex_cc_manySimpleTypes.h`. The file defines three structure types: `params_T`, `signals_T`, and `states_T`.

```
typedef struct {
    double coeff;
    double init;
} params_T;

typedef struct {
    double flow_rate;
    double steam_press;
} signals_T;

typedef struct {
    double accum;
    double error;
} states_T;
```

Generate Simulink representations only for `params_T` and `signals_T`.

```
Simulink.importExternalCTypes('ex_cc_manySimpleTypes.h',...
    'Names',{'params_T','signals_T'});
```

The `Simulink.Bus` objects, `params_T` and `signals_T`, appear in the base workspace.

Import Types for 16-Bit Hardware

By default, `Simulink.importExternalCTypes` represents an enumerated data type by creating an enumeration class that derives from the built-in class `Simulink.IntEnumType`. When you simulate or generate code from a model that uses the generated class, configuration parameters that you select for the model (for example, on the **Hardware Implementation** pane) determine the specific integer length that `Simulink.IntEnumType` and the enumeration class employ.

By default, the function interprets generic, primitive C data types, such as `short` and `int`, according to the word lengths of your host computer. For example, to represent an `int` structure field, the function typically applies the 32-bit data type `int32` to the corresponding bus element. When you want to simulate and generate code for hardware other than your host computer, use the `HardwareImplementation` pair argument to identify the target hardware and, by extension, the word lengths of the hardware.

This example shows how to import data types from code that you intend to use on 16-bit hardware. For this board, `int` has a 16-bit length, and each item of enumerated data (`enum`) consumes 16 bits.

In your current folder, create the file `ex_cc_intTypes.h`.

```
typedef enum {
    PWR_LOSS = 0,          /* Default value */
    OVERSPD,
    PRESS_LOW,
} fault_T;

typedef struct {
    int coeff;
    int init;
} params_T;
```

The code defines an enumerated data type and a structure type whose fields use the generic C data type `int`.

To generate an accurate Simulink representation of the structure type, first open an existing model or create a new model. For this example, create a new model named `ex_hdwImpl_16bit`.

In the new model, set **Configuration Parameters > Hardware Implementation > Device vendor** to `Atmel`. Set **Device type** to `AVR`.

Alternatively, at the command prompt, use these commands to create and configure the model:

```
new_system('ex_hdwImpl_16bit','Model');
set_param('ex_hdwImpl_16bit','ProdHWDeviceType','Atmel->AVR')
```

Generate Simulink representations of the types. To specify the word lengths of the target 16-bit hardware, extract the model configuration parameters (which include the **Hardware Implementation** settings) as a `Simulink.ConfigSet` object.

```
configSet = getActiveConfigSet('ex_hdwImpl_16bit');
Simulink.importExternalCTypes('ex_cc_intTypes.h','HardwareImplementation',configSet);
```

The `Simulink.Bus` object `params_T` appears in the base workspace. The bus elements, such as `coeff`, use the Simulink data type `int16`.

```
params_T.Elements(1)
```

```
ans =
```

```
    BusElement with properties:
```

```
        Name: 'coeff'
    Complexity: 'real'
```

```

Dimensions: 1
  DataType: 'int16'
    Min: []
    Max: []
DimensionsMode: 'Fixed'
  Unit: ''
Description: ''

```

In your current folder, the file `fault_T.m` defines the enumeration class `fault_T`. The class derives from `Simulink.IntEnumType`, so you must use model configuration parameters to identify the target hardware and, by extension, the correct native integer length.

Import Structure Type Whose Fields Use 16-Bit Fixed-Point Data Types

Create the file `ex_cc_fixpt_struct.h` in your current folder.

```

typedef struct {
    int coeff; /* Word length 16,
               binary fraction length 7 */

    int init; /* Word length 16,
              binary fraction length 3 */
} params_T;

```

The file defines a structure type whose fields use fixed-point data types. For example, the structure stores the field `coeff` in a signed, 16-bit integer data type. A binary fraction length of 7 relates the stored integer value to the real-world value.

Suppose that this code operates on 16-bit hardware (such that the generic C data type `int` has a 16-bit word length). To generate a Simulink representation of the type, first create a `coder.HardwareImplementation` object that identifies the hardware.

```

hdw = coder.HardwareImplementation;
hdw.ProdHWDeviceType = 'Atmel->AVR';

```

Generate a Simulink representation of the structure type.

```

Simulink.importExternalCTypes('ex_cc_fixpt_struct.h',...
    'HardwareImplementation',hdw);

```

The `Simulink.Bus` object, `params_T`, appears in the base workspace. Each bus element, such as `coeff`, uses the data type `int16`.

```
params_T.Elements(1)
```

```
ans =
```

```

BusElement with properties:
    Name: 'coeff'
Complexity: 'real'

```

```

Dimensions: 1
  DataType: 'int16'
    Min: []
    Max: []
DimensionsMode: 'Fixed'
  Unit: ''
Description: ''

```

`Simulink.importExternalCTypes` cannot infer the fixed-point scaling (binary fraction length) from the C code. You must manually specify the data types of the bus elements. To specify the data types at the command prompt, use the `fixdt` function.

```

params_T.Elements(1).DataType = 'fixdt(1,16,7)';
params_T.Elements(2).DataType = 'fixdt(1,16,3)';

```

To specify the data types interactively (by using the Data Type Assistant), use the Bus Editor.

```
buseditor
```

Manually Synchronize Simulink Representations with C-Code Definitions

This example shows how to maintain the Simulink representations of C data types whose definitions you modify during the life of a modeling project.

Import Custom C Types

Create the file `ex_cc_myTypes_rec.h` in your current folder. The file defines a custom structure type.

```

typedef struct {
    double flow;
    double pres;
    double tqe;
} sigStructType;

```

Generate a `Simulink.Bus` object that represents the type.

```
Simulink.importExternalCTypes('ex_cc_myTypes_rec.h');
```

Modify Type Definition in C Code

In `ex_cc_myTypes_rec.h`, add a field named `spd` to `sigStructType`.

In the same file, create a new structure type, `stateStructType`.

```

typedef struct {
    double flow;
    double pres;
    double tqe;
    double spd;
} sigStructType;

typedef struct {

```

```

    double err;
    double read;
    double write;
} sigStructType;

```

Attempt to Import Types Again

Attempt to generate bus objects that represent the types.

```
importInfo = Simulink.importExternalCTypes('ex_cc_myTypes_rec.h');
```

The function generates warnings at the command prompt. Instead of relying on the warnings, you can inspect the output, `importInfo`, to determine whether the function failed to import any types.

```
importInfo.failedToImport.Bus
```

```
ans =
```

```

1x1 cell array

{'sigStructType'}

```

The function did not import `sigStructType`. The corresponding bus object in the base workspace still has only three bus elements. To determine the reason that the function did not import `sigStructType`, inspect the `report` field of `importInfo`.

Import `sigStructType` again. This time, overwrite the existing bus object.

```
importInfo = Simulink.importExternalCTypes('ex_cc_myTypes_rec.h', ...
    'Names', importInfo.failedToImport.Bus, 'Overwrite', 'on');
```

When you overwrite existing Simulink representations, any customizations that you made to the Simulink representations (such as the application of fixed-point data types to bus elements) are overwritten.

Input Arguments

headerFiles — Names and paths of header files to parse

character vector | cell array of character vectors | string scalar | string array

Names and paths of header files to parse, specified as a character vector, cell array of character vectors, string, or string array. Include the `.h` or `.hpp` file extension.

If you use a hierarchy of included (`#include`) header files to define your types, when you specify `HeaderFiles`, you need to identify only the entry-point files. The function parses the included files as well as the identified entry-point files. If the included files are not in the same folder as the corresponding entry-point file, use the `IncludeDirs` pair argument to identify the additional folders.

Example: `'myHeader.h'`

Example: `{'thisHeader.hpp', 'thatHeader.hpp'}`

Data Types: `char` | `cell` | `string`

modelName — Name of loaded Simulink model for which to import types

character vector | string scalar

Name of a loaded Simulink model for which to import types, specified as a character vector or string scalar. A model is loaded if, for example, you open the model or use the `load_system` function. When you use this argument, the function:

- Searches the model configuration parameters for custom header files and parses those header files for data types to import. Only the configuration parameters on the **Simulation Target** pane affect this search.

For example, if in the model you set **Configuration Parameters > Simulation Target > Insert custom C code in generated > Header file** to `#include "myTypes.h"`, the function parses `myTypes.h` for types to import.

- Interprets generic C data types such as `int` or `short` according to the word lengths of your host computer. Do not use the `HardwareImplementation` pair argument to override this interpretation.

Example: `'myModel'`

Data Types: `char` | `string`

Name-Value Pair Arguments

Specify optional comma-separated pairs of `Name`, `Value` arguments. `Name` is the argument name and `Value` is the corresponding value. `Name` must appear inside quotes. You can specify several name and value pair arguments in any order as `Name1, Value1, ..., NameN, ValueN`.

Example:

```
Simulink.importExternalCTypes('myHdr.h', 'DataDictionary', 'myDictionary.slidd')
```

MATFile — Name and path of MAT-file to create for storing generated objects

`''` (empty) (default) | character vector | string scalar

Name and, optionally, path of the MAT-file to create for storing generated `Simulink.Bus` and `Simulink.AliasType` objects, specified as a character vector or string. If you do not use `MATFile`, by default, the function generates the objects in the base workspace.

The function does not generate enumeration definitions in MAT-files.

If you import some `struct` types and primitive `typedef` statements by using `MATFile` and later import some of the same types again by using `MATFile`, the function entirely replaces the old MAT-file with a new one. The function discards any changes that you made to the contents of the old MAT-file.

You cannot use the `MATFile` and `DataDictionary` pair arguments simultaneously.

Example: `'myMat.mat'`

Example: `'myMat'`

Example: `fullfile('subfolder', 'myMat')`

Data Types: `char` | `string`

DataDictionary — Name and path of Simulink data dictionary to use or create for storing types

`''` (default) | character vector | string scalar

Name and, optionally, path of the Simulink data dictionary to use or create for storing generated enumerations and objects, specified as a character vector or string. When you use this pair argument,

the function imports enumerated types as `Simulink.data.dictionary.EnumTypeDefinition` objects, and stores those objects (as well as `Simulink.Bus` objects and `Simulink.AliasType` objects) in the target dictionary.

For information about data dictionaries, see “What Is a Data Dictionary?”.

You can optionally specify a `.sldd` extension.

You cannot use the `DataDictionary` and `MATFile` pair arguments simultaneously.

Example: `'myDict.sldd'`

Example: `'myDict'`

Example: `fullfile('subfolder','myDict.sldd')`

Data Types: `char` | `string`

Names — Names of types to import

`''` (default) | character vector | cell array of character vectors | string scalar | string array

Names of types to import, specified as a character vector, cell array of character vectors, string, or string array. By default, if you do not use `Names`, the function attempts to import all of the custom types that the identified header files define.

To match multiple type names with a single character vector, use an asterisk (*).

Example: `'myEnumType'`

Example: `{'myEnumType','myStructType'}`

Example: `'my*Type'`

Data Types: `char` | `cell` | `string`

Defines — Compiler options to define macros that influence type definitions

`''` (default) | character vector | string scalar

Compiler options to define macros that influence C type definitions, specified as a character vector, or string scalar. For example, a macro influences a type definition if you enclose the definition in an `#ifdef` block that checks whether the macro is defined.

Use `Defines` to specify macro definitions that you otherwise define through compiler options such as `-D`.

Example: `'SIGSTRUCT=1'`

Example: `'SIGSTRUCT=1 ENUM=1'`

Data Types: `char` | `string`

UnDefines — Compiler options to delete macros that influence type definitions

`''` (default) | character vector | string scalar

Compiler options to delete macros that influence C type definitions, specified as a character vector or string scalar. For example, a macro influences a type definition if you enclose the definition in an `#ifdef` block that checks whether the macro is defined.

Use `UnDefines` to specify macro deletions that you otherwise define through compiler options such as `-U`.

Example: 'SIGSTRUCT'

Example: 'SIGSTRUCT ENUM'

Data Types: char | string

IncludeDirs — Folders that contain subordinate, included header files

' ' (default) | character vector | cell array of character vectors | string scalar | string array

Folders that contain subordinate, included (`#include`) header files, specified as a character vector, cell array of character vectors, string, or string array. Use this pair argument to enable the function to locate and parse additional header files on which the primary header files (which you specify with the `headerFiles` argument) depend.

If you use the `modelName` syntax instead of the `headerFiles` syntax, in the target model, you can use the **Simulation Target** configuration parameters to specify include paths. In that case, you do not need to use the `IncludeDirs` pair argument.

Example: 'myHeaders'

Example: `fullfile('myProject','myHeaders')`

Example:

```
{fullfile('myProject','myHeaders'),fullfile('myProject','myOtherHeaders')}
```

Data Types: char | cell | string

OutputDir — Folder for storing generated files

' ' (default) | character vector | string scalar

Folder for storing generated files, specified as a character vector or string. The function places generated files, such as `classdef` script files and data dictionary files, in this folder.

The folder that you specify must exist before you use the function.

Example: 'myDictionaries'

Example: `fullfile('myProject','myDictionaries')`

Data Types: char | string

Language — Language to parse header files

'Auto' (default) | 'C' | 'C++'

Parse and import compatible data types from C and C++ header files. If specify header files that contain C++ features, specify the `Language` to 'C++' to import compatible C data types.

When data types are imported from a header file with `hpp` extension, if the `Language` setting is not specified or set to 'Auto', 'C++' is selected to parse your header files. C++ classes and C++ struct types are ignored. Empty structs are not imported.

If you import header files from a loaded model and the `Language` is not specified or set to 'Auto', the `Language` setting is inherited from the model's custom settings. If the imported model already has a `Language` setting in **Configuration Parameters > Simulation Target**, this setting is overshadowed by imported model's setting.

HardwareImplementation — Word lengths for interpreting generic, primitive C data types

' ' (default) | Simulink.ConfigSet object | coder.HardwareImplementation object

Word lengths for interpreting generic, primitive C data types, specified as a `Simulink.ConfigSet` or `coder.HardwareImplementation` object.

- To use a `Simulink.ConfigSet` object, you can extract a configuration set from a model by using functions such as `getConfigSet` and `getActiveConfigSet`. This technique enables you to use the Configuration Parameters dialog box to identify your target hardware (through the **Hardware Implementation** configuration parameters).
- To use a `coder.HardwareImplementation` object (which you create and configure programmatically), specify properties of the object, such as `ProdHWDeviceType`, to identify your target hardware. The object then sets other properties, such as `ProdBitPerInt`, that reflect the native integer size of the hardware.

The function inspects the object to determine which Simulink integer data types to employ when interpreting generic C data types such as `int`. For example, if you create a `coder.HardwareImplementation` object to identify 16-bit hardware and then use the function to import a structure type whose fields use the C data type `int`, the function generates a bus object whose bus elements use the Simulink data type `int16`. The function uses the production hardware settings, not the test hardware settings.

For more information about hardware implementation settings for Simulink models, see “Configure Run-Time Environment Options” (Simulink Coder).

Overwrite — Specification to overwrite existing Simulink representations

'off' (default) | 'on'

Specification to overwrite existing Simulink representations, specified as 'on' or 'off'. If an imported type already has a representation in Simulink:

- If you specify 'off' or if you do not specify `Overwrite`, the function does not import the type. In the output argument, `importInfo`, the `failedToImport` field identifies the type.
- If you specify 'on', the function overwrites the existing Simulink representation.

If you use the function to import some types into the base workspace or a data dictionary and later customize the generated Simulink representations, when you use the function again and set `Overwrite` to 'on', the function does not preserve your customizations. These customizations can include:

- In an enumeration class definition, implementing extra methods or modifying the generated methods such as `getDataScope` (see “Customize Simulink Enumeration”).
- Modifying the properties of a generated `Simulink.Bus` or `Simulink.AliasType` object (for example, manually setting the data types of bus elements to a fixed-point data type).

Verbose — Specification to generate messages for successful import operations

'off' (default) | 'on'

Specification to generate messages for successful import operations, specified as 'on' or 'off'.

- If you specify 'off' or if you do not specify `Verbose`, the function imports types silently. Messages do not appear in the Command Window unless the function cannot import a type.
- If you specify 'on', the function generates a message in the Command Window for each operation during the import process.

Output Arguments

importInfo — Information about types that were imported and not imported

structure

Information about types that were imported and not imported, returned as a structure with these fields.

report — Descriptions of types that were imported and not imported

character vector

Descriptions of types that were imported and not imported, returned as a character vector. Inspect the value of this field to determine the reason that the function could not import a type.

failedToImport — Types that were not imported

structure

Types that were not imported, returned as a structure with these fields.

| Field Name | Field Value | Purpose |
|------------|---------------------------------|--|
| Bus | Cell array of character vectors | Names of structure (<code>struct</code>) types that were not imported. |
| Enum | Cell array of character vectors | Names of enumerated types (<code>enum</code>) that were not imported. |
| AliasType | Cell array of character vectors | Names of primitive <code>typedef</code> statements that were not imported. |

importedTypes — Types that were successfully imported

structure

Types that were successfully imported, returned as a structure with these fields.

| Field Name | Field Value | Purpose |
|------------|---------------------------------|--|
| Bus | Cell array of character vectors | Names of structure (<code>struct</code>) types that were imported. The generated <code>Simulink.Bus</code> objects use these names. |
| Enum | Cell array of character vectors | Names of enumerated types (<code>enum</code>) that were imported. The generated enumeration classes or <code>Simulink.data.dictionary.EnumTypeDefinition</code> objects use these names. |
| AliasType | Cell array of character vectors | Names of primitive <code>typedef</code> statements that were imported. The generated <code>Simulink.AliasType</code> objects use these names. |

Limitations

- The function does not support:
 - C data types that do not correspond to a type that Simulink supports. For example, Simulink does not recognize an equivalent for `long double`. For information about data types that Simulink supports, see “Data Types Supported by Simulink”.
 - Pointer types, such as a structure that defines a field whose value is a pointer or a `typedef` statement whose base type is a pointer type.
 - Structures that define a field whose value has more than one dimension.

If a field value is a 1-D array, the function creates a bus element that represents a vector, not a matrix.
 - Unions.
- If a structure field represents fixed-point data, or if a `typedef` statement maps to a fixed-point base type, the function sets the data type of the corresponding bus element or `Simulink.AliasType` object to the relevant Simulink integer type (such as `int16`). The importer cannot determine the fixed-point scaling by parsing the C code. After using the function, you must manually specify the data type of the bus element or the base type of the `Simulink.AliasType` object by using the `fixdt` function.

Tips

- If a MATLAB Function block or Stateflow chart in your model uses an imported enumeration or structure type, configure the model configuration parameters to include (`#include`) the type definition from your external header file. See “Control Imported Bus and Enumeration Type Definitions” (for a MATLAB Function block) and “Access Custom Code Variables and Functions in Stateflow Charts” (Stateflow) and “Integrate Custom Structures in Stateflow Charts” (Stateflow) (for a chart).
- By default:
 - For an imported enumeration, because the Simulink enumeration class derives from `Simulink.IntEnumType`, when you simulate or generate code from a model, the enumeration uses the integer size that is native to your target hardware. You specify the characteristics of your target hardware by using model configuration parameters such as **Production device vendor and type** and **Native word size in production hardware**.
 - For an imported structure type:
 - The function imports a structure field as numerically complex only if the field uses one of the corresponding Simulink Coder structure types as the data type. For example, if a structure field in your external code uses the data type `cint8_T`, the function imports the field as a bus element (`Simulink.BusElement` object) whose data type is `int8` and whose `Complexity` property is set to `'complex'`.
 - For nested structures, the function generates a bus object for each unique structure type.
 - For an imported structure or enumeration type, if your external code uses a `typedef` statement to name the type, the name of the generated bus object or Simulink enumeration class matches the `typedef` name. If your code does not use a `typedef` statement to name the type, the name of the object or class is the tag name of the type, unless that name conflicts with a type name that is defined in a `typedef` statement elsewhere in your header files, in

which case the type is not imported into Simulink. If you do not specify a tag name or apply a typedef name, Simulink generates an arbitrary name for the object or class.

Note To import types that are not named in a typedef statement, the model configuration parameter **Import custom code** must be selected.

- The function configures the generated Simulink representations as imported for the purposes of simulation and code generation. For example, for bus objects, the function sets the `DataScope` property to 'Imported' and the `HeaderFile` property to the name of your external header file. To simulate or generate code from a model that uses one of these Simulink representations, you must make your header file available to the model.
- When you specify files for `Simulink.importExternalCTypes` to use or generate, for example, by using the `DataDictionary` pair argument:
 - If the existing files to use are in your current folder or on the MATLAB path, you do not need to specify a file path. You can specify the file name by itself.
 - To control the folder location of generated files, you can specify paths as well as file names. You can also use the `OutputDir` pair argument.

See Also

`Simulink.AliasType` | `Simulink.Bus` | enumeration

Topics

"Data Types Supported by Simulink"

"Data Types for Buses"

"Use Enumerated Data in Simulink Models"

"Control Data Type Names in Generated Code" (Embedded Coder)

"Control Data Types of Signals"

"Exchange Data Between External C/C++ Code and Simulink Model or Generated Code" (Simulink Coder)

Introduced in R2017a

Simulink.ModelDataLogs.convertToDataset

Convert logging data from `Simulink.ModelDataLogs` format to `Simulink.SimulationData.Dataset` format

Syntax

```
convertedDataset =  
sourceModelDataLogsObject.convertToDataset(convertedDatasetName)
```

Description

Note The `ModelDataLogs` class is supported for backwards compatibility. Starting in R2016a, you cannot log data in the `ModelDataLogs` format. Signal logging uses the `Dataset` format. In R2016a or later, when you open a model from an earlier release that had used `ModelDataLogs` format, the model simulated in use `Dataset` format.

You can convert signal logging data from `ModelDataLogs` to `Dataset` format. Converting to `Dataset` format makes it easier to post-process with other logged data (for example, logged states), which can also use `Dataset` format. For more information, see “Convert Logged Data to Dataset Format”.

If you have legacy code that uses the `ModelDataLogs` API, you can encounter situations that require updates to your code or model. See “Migrate Scripts That Use Legacy `ModelDataLogs` API”.

```
convertedDataset =  
sourceModelDataLogsObject.convertToDataset(convertedDatasetName)
```

converts the `sourceModelDataLogsObject` to a `Simulink.SimulationData.Dataset` object. The name of the converted object is based on `convertedDatasetName`.

The resulting `Simulink.SimulationData.Dataset` object is a flat list. This list has one element for each `Simulink.Timeseries` or `Simulink.TsArray` object in the `Simulink.ModelDataLogs` object.

Limitations

| Source of Simulink.ModelDataLogs Logged Data | Conversion Limitation |
|--|---|
| Referenced model | <p>Loads all ancestors of the referenced model not previously loaded. If any ancestor model does not appear on the MATLAB path, the conversion fails.</p> <p>If the model has changed, or the model ancestors have changed, after Simulink logged the data, the conversion can fail. For example, adding, deleting, or renaming a block after logging can cause conversion failure.</p> |

| Source of Simulink.ModelDataLogs Logged Data | Conversion Limitation |
|--|---|
| Variant model or subsystem | The current active variant must be the same one that was active when Simulink logged the data. Otherwise, the conversion fails. |
| Frame signal | The conversion fails. |
| Mux block | The conversion produces a different <code>Simulink.SimulationData.Dataset</code> object as the dataset than Simulink creates when you simulate the model using the <code>Dataset</code> format for the logged data. |
| Stateflow chart | Not supported. |

Input Arguments

`sourceModelDataLogsObject`

A `Simulink.ModelDataLogs` object that you want to convert to a `Simulink.SimulationData.Dataset` object.

`convertedDatasetName`

Name of the dataset that the conversion process creates.

Output Arguments

`convertedDataset`

The `Simulink.SimulationDataset` object that the `Simulink.ModelDataLogs.convertToDataset` function creates.

For details about the converted dataset, see `Simulink.SimulationData.Dataset`.

Example

In releases before R2016a, you could log signals using `ModelDataLogs` format. If you have a MAT-file with signal logging data that uses the `ModelDataLogs` format, here is how you can convert that data to `Dataset` format. This example assumes that the model that generated the logging data had the **Configuration Parameters > Data Import/Export > Signal logging** name set to `logout`.

- 1 Load the MAT-file.
- 2 Convert `logout` to a dataset called `myModel_dataset`. (The elements information will be different for your data.)

```
dataset = logout.convertToDataset('myModel_Dataset')
```

```
dataset =
  Simulink.SimulationData.Dataset
  Package: Simulink.SimulationData
```

```
Characteristics:
```

Name: 'myModel_Dataset'
Total Elements: 2

Elements:

1: 'x1'

2: 'x2'

-Use `get` or `getElement` to access elements by index or name.
-Use `addElement` or `setElement` to add or modify elements.

Methods, Superclasses

See Also

[Simulink.ModelDataLogs](#) | [Simulink.SimulationData.Dataset](#) |
[Simulink.SimulationData.updateDatasetFormatLogging](#)

Topics

“Migrate Scripts That Use Legacy ModelDataLogs API”

“Export Signal Data Using Signal Logging”

Introduced in R2011a

Simulink.io.getFileTypeDiagnostics

Return structure with NamespaceErrors field for Simulink.io.FileType objects

Syntax

```
diagnosticStruct = Simulink.io.getFileTypeDiagnostics()
```

Description

`diagnosticStruct = Simulink.io.getFileTypeDiagnostics()` returns a structure with field `NamespaceErrors` `diagnosticStruct` for `Simulink.io.FileType` objects.

Examples

Get Diagnostics for Simulink.io.FileType Objects

Get diagnostics for `Simulink.io.FileType` objects and return in `diagnosticStruct`.

```
diagnosticStruct = Simulink.io.getFileTypeDiagnostics()
```

```
diagnosticStruct =  
    struct with fields:  
        NamespaceErrors: {}
```

In this example, there are no diagnostics.

Output Arguments

diagnosticStruct — Structure of NamespaceErrors field for Simulink.io.FileType objects

structure with cell array

Structure of diagnostics for `Simulink.io.FileType` objects, returned as a structure with a cell array of `NamespaceErrors` fields. The first column in the cell array is the name of the name space plugin. In this example output, the name of the name space plugin is `not.here`.

```
diagnosticStruct =  
    struct with fields:  
        NamespaceErrors: { 'not.here' 'Unknown package name ' ' ' ' . ' }
```

See Also

`Simulink.io.FileType` | `Simulink.io.PluggableNamespace`

Introduced in R2021a

Simulink.MDLInfo.getDescription

Extract SLX, SLXP, or MDL file description without loading file

Syntax

```
d = Simulink.MDLInfo.getDescription(file)
```

Description

`d = Simulink.MDLInfo.getDescription(file)` returns the description of the specified SLX, SLXP, or MDL file without loading the file.

Examples

Get Model Description

Get the description of the vdp model without loading it or creating a `Simulink.MDLInfo` object for it.

```
d = Simulink.MDLInfo.getDescription('vdp')  
  
d =  
  
    'The van der Pol Equation  
  
    This is a simulation of a nonlinear second order system.'
```

Input Arguments

file — Name of SLX, SLXP, or MDL file

character vector | string scalar

Name of the SLX, SLXP, or MDL file, specified as a character vector or string scalar.

The file name can include a partial path, complete path, relative path, or no path. When you do not provide a path, the file extension is optional.

To avoid unexpected results caused by shadowed files that share a name, specify a fully qualified file name.

Example: `Simulink.MDLInfo('vdp')`

Example: `Simulink.MDLInfo('mymodel.slx')`

Example: `Simulink.MDLInfo('mydir/mymodel.slx')`

Example: `Simulink.MDLInfo('C:/mydir/mymodel.slx')`

Data Types: `char` | `string`

See Also

`Simulink.MDLInfo` | `Simulink.MDLInfo.getMetadata`

Introduced in R2009b

Simulink.MDLInfo.getMetadata

Extract SLX, SLXP, or MDL file metadata without loading file

Syntax

```
m = Simulink.MDLInfo.getMetadata(file)
```

Description

`m = Simulink.MDLInfo.getMetadata(file)` returns the metadata structure associated with the specified SLX, SLXP, or MDL file without loading the file.

The metadata structure contains the names and attributes of arbitrary data associated with the file. The structure fields can be character vectors, numeric matrices of type `double`, or more structures.

Examples

Add and Check File Metadata

Create a structure that contains metadata information.

```
m.TestStatus = 'untested';  
m.ExpectedCompletionDate = '01/01/2011';
```

Create a model, update the 'Metadata' parameter, and save the metadata in the model.

```
new_system('MDLInfoMetadataModel')  
set_param('MDLInfoMetadataModel','Metadata',m)  
save_system('MDLInfoMetadataModel')
```

Check the model for metadata without loading the model or creating a `Simulink.MDLInfo` object.

```
Simulink.MDLInfo.getMetadata('MDLInfoMetadataModel')
```

```
ans =
```

```
struct with fields:
```

```
TestStatus: 'untested'  
ExpectedCompletionDate: '01/01/2011'
```

Input Arguments

file — Name of SLX, SLXP, or MDL file

character vector | string scalar

Name of the SLX, SLXP, or MDL file, specified as a character vector or string scalar.

The file name can include a partial path, complete path, relative path, or no path. When you do not provide a path, the file extension is optional.

To avoid unexpected results caused by shadowed files that share a name, specify a fully qualified file name.

Example: `Simulink.MDLInfo('vdp')`

Example: `Simulink.MDLInfo('mymodel.slx')`

Example: `Simulink.MDLInfo('mydir/mymodel.slx')`

Example: `Simulink.MDLInfo('C:/mydir/mymodel.slx')`

Data Types: `char` | `string`

Tips

To add metadata to an SLX or MDL file, create a metadata structure that contains the information you require and use the `set_param` function to attach it to the file. To extract the information without loading the file, use `metadata` instead of adding custom data by using the `add_param` function.

See Also

`Simulink.MDLInfo` | `Simulink.MDLInfo.getDescription`

Introduced in R2009b

Simulink.LibraryDictionary.clear

Package: Simulink.LibraryDictionary

Clear library dictionary dependency analysis

Syntax

```
Simulink.LibraryDictionary.clear
```

Description

`Simulink.LibraryDictionary.clear` clears any previous library dependency analysis that has been performed on a library hierarchy with attached data dictionaries. When you first attach a dictionary to a library and save that library, Simulink opens and performs this analysis on each library in the current folder as well as in the folder of that library (if different than the current folder). Simulink stores the analysis in the user preference folder. Subsequent changes to a library in the hierarchy results in analysis of only relevant library changes.

Run this function only if you intend to reanalyze the entire library hierarchy.

Examples

Clear Library Dependency Analysis for Library Dictionaries

To perform a full reanalysis of dependencies for a library hierarchy with attached data dictionaries, clear any previously stored dependency analysis.

```
Simulink.LibraryDictionary.clear
```

See Also

```
Simulink.LibraryDictionary.refresh
```

Topics

“Link Data Dictionary to Custom Libraries”

“Create Custom Library”

“Design and Create a Custom Block”

Introduced in R2021a

Simulink.LibraryDictionary.refresh

Package: Simulink.LibraryDictionary

Update library dictionary dependencies

Syntax

```
Simulink.LibraryDictionary.refresh()  
Simulink.LibraryDictionary.refresh(libraryDir)  
Simulink.LibraryDictionary.refresh(model)
```

Description

`Simulink.LibraryDictionary.refresh()` performs a library dependency analysis on a library hierarchy with attached data dictionaries from the current folder. When you first attach a dictionary to a library and save that library, Simulink opens and performs this analysis on each library in the specified folder as well as in the folder of that library (if different than the current folder). Simulink stores the analysis in the user preference folder. Subsequent changes to a library in the hierarchy result in analysis of only relevant library changes.

Because performing this library dependency analysis can be an expensive operation, call the `Simulink.LibraryDictionary.refresh` function only when you have made changes to your library hierarchy and want to ensure that your library dictionary dependencies are current.

`Simulink.LibraryDictionary.refresh(libraryDir)` performs a library dependency analysis on a library hierarchy with attached data dictionaries from the specified library folder.

`Simulink.LibraryDictionary.refresh(model)` performs a library dependency analysis on a library hierarchy with attached data dictionaries for the specified model.

Examples

Refresh Library Dependency Analysis from the Current Folder

Perform a library dependency analysis on a library hierarchy with attached data dictionaries from the current folder.

```
Simulink.LibraryDictionary.refresh()
```

Refresh Library Dependency Analysis from a Specified Folder

Perform a library dependency analysis on a library hierarchy with attached data dictionaries from a specified library folder.

```
Simulink.LibraryDictionary.refresh('C:/Work/myLibraryDir/')
```

Refresh Library Dependency Analysis for a Specified Model

Perform a library dependency analysis on a library hierarchy with attached data dictionaries for a specified model.

```
Simulink.LibraryDictionary.refresh('myModel')
```

Input Arguments

libraryDir — Library folder

character vector

Library folder to use for dependency analysis, specified as a character vector.

Example: 'myLibraryDir'

Data Types: char

model — Model

character vector

Model to use for dependency analysis, specified as a character vector.

Example: 'myModel'

Data Types: char

See Also

`Simulink.LibraryDictionary.clear`

Topics

“Link Data Dictionary to Custom Libraries”

“Create Custom Library”

“Design and Create a Custom Block”

Introduced in R2021a

Simulink.ModelReference.refresh

Update Model blocks to reflect changes to referenced models

Syntax

```
Simulink.ModelReference.refresh(modelBlock)
```

Description

`Simulink.ModelReference.refresh(modelBlock)` updates the specified Model block to reflect changes to the referenced model.

Examples

Refresh Model Blocks Programmatically

Programmatically refresh a Model block in a parent model that has the **Port and parameter mismatch** configuration parameter set to error.

Load the example model, which contains two Model blocks that are out of date with the model they reference. The number of input and output ports in the referenced model has increased from one to two.

```
load_system('RefreshModelBlockModel');
```

```
Warning: Ports and parameters of Model block 'RefreshModelBlockModel/Model1' do not reflect changes to referenced model.
```

```
Warning: Number of input ports must match between Model block 'RefreshModelBlockModel/Model1' (1) and referenced model (2).
```

```
Warning: Ports and parameters of Model block 'RefreshModelBlockModel/Model' do not reflect changes to referenced model.
```

```
Warning: Number of input ports must match between Model block 'RefreshModelBlockModel/Model' (1) and referenced model (2).
```

Refresh one of the Model blocks.

```
Simulink.ModelReference.refresh('RefreshModelBlockModel/Model');
```

The number of ports on the refreshed Model block now matches the number of ports for the referenced model.

To see that the refreshed Model block displays all ports in the referenced model, while the other Model block does not, open the parent model.

```
open_system('RefreshModelBlockModel');
```

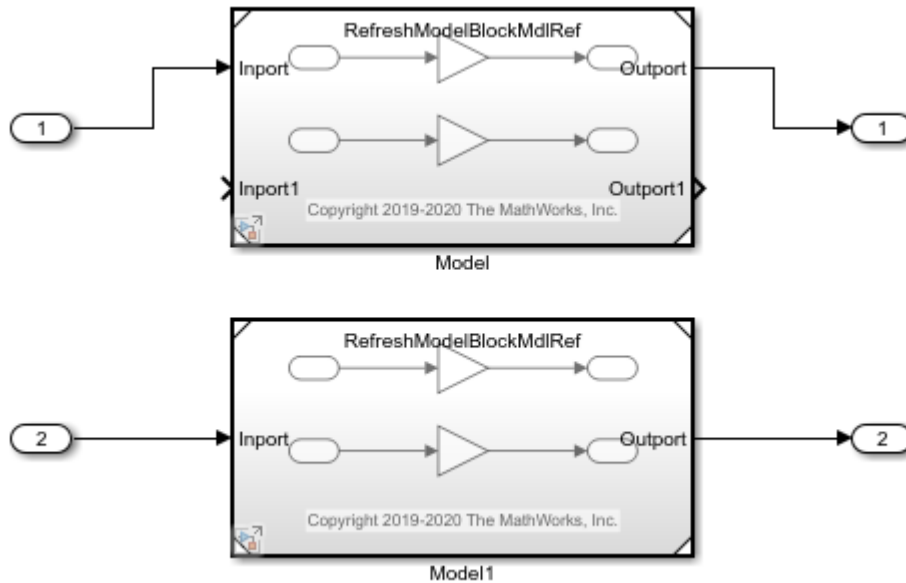

Input Arguments

modelBlock – Model block to refresh

character vector | handle

Model block to refresh, specified as a character vector or a handle.

Example: 'RefreshModelBlockModel/Model'

Data Types: char | string | double

See Also

Model block version mismatch | **Port and parameter mismatch**

Topics

“Model Reference Basics”

“Model Reference Interface and Boundary”

Introduced in R2020a

Simulink.ProtectedModel.createHarness

Create harness model that provides isolated environment for testing protected model

Syntax

```
h = Simulink.ProtectedModel.createHarness(pname)
h = Simulink.ProtectedModel.createHarness(pname,hname)
```

Description

`h = Simulink.ProtectedModel.createHarness(pname)` creates and opens a harness model for the specified protected model. The harness model provides an isolated environment for testing the protected model. The name of the harness model is the name of the protected model followed by `_harness`.

`h = Simulink.ProtectedModel.createHarness(pname,hname)` specifies the name or path of the harness model.

Examples

Create Harness Model for Protected Model

To test a protected model in an isolated environment, use the provided harness model or create a harness model for the protected model.

Suppose you receive a protected model named `sldemo_mdhref_counter.slxp` and do not receive a harness model for it. Using the same platform that was used to create the protected model, create a harness model for the protected model.

```
h = Simulink.ProtectedModel.createHarness('sldemo_mdhref_counter.slxp');
```

The harness model is set up for simulation of the protected model.

Input Arguments

pname — Name of protected model

character vector | string scalar

Name of protected model, specified as a character vector or string scalar.

You can specify the name with or without the `.slxp` extension, however, you cannot specify a full path or partial path. The file must be on the MATLAB path.

Example: `Simulink.ProtectedModel.createHarness('model.slxp')`

Data Types: `char` | `string`

hname — Name of harness model

character vector | string scalar

Name of harness model being created, specified as a character vector or string scalar.

You can specify the name with or without the `.slx` extension.

To save the model in a specific location, specify the full path or a partial path for the harness model, including the name and extension. Otherwise, the harness model is saved in the working directory.

Example: `Simulink.ProtectedModel.createHarness('model.slxp','harness.slx')`

Data Types: `char` | `string`

Output Arguments

h — Harness model

handle

Harness model, returned as a handle.

Data Types: `double`

Alternative Functionality

If you have a Simulink Coder or HDL Coder license, create a harness model as part of the model protection process by using one of these options:

- In the Create Protected Model dialog box, set **Contents** to Protected model (`.slxp`) and dependencies in a project, or select **Create harness model for protected model**.
- Using the `Simulink.ModelReference.protect`, set 'Project' or 'Harness' to true.

When you create the harness model as part of the model protection process, you have more information to provide the harness model. Without this information, you might not be able to create a harness model for the protected model.

See Also

`Simulink.ModelReference.protect`

Topics

“Protect Models to Conceal Contents” (Simulink Coder)

“Reference Protected Models from Third Parties”

Introduced in R2020b

Simulink.ProtectedModel.getPublisher

Return information about publisher that signed the protected model

Syntax

```
[publisher,tf] = Simulink.ProtectedModel.getPublisher(protectedModel)
```

Description

`[publisher,tf] = Simulink.ProtectedModel.getPublisher(protectedModel)` returns the name of the publisher that signed `protectedModel` and whether the certificate is verified by a trusted certificate authority. To verify the certificate, the corresponding certificate file must be in your computer's trusted certificate authority store.

Examples

Get Name of Publisher that Signed Protected Model

Get publisher information for the protected model `signed_model_name`.

```
Simulink.ProtectedModel.getPublisher('signed_model_name.slxp')
```

The function returns the name of the publisher that signed the protected model.

Get Publisher and Verification Status of Protected Model

Verify the publisher and status of the protected model `signed_model_name`.

```
[publisher, verified] = Simulink.ProtectedModel.getPublisher('signed_model_name.slxp');
```

The variable `publisher` represents the name of the publisher that signed the model. `verified` has a value of 1 if the signature is verified by a trusted certificate authority.

Input Arguments

protectedModel — Name of signed protected model

character vector | string scalar

Name of the signed protected model, specified as a character vector or a string scalar.

Example: `'my_model.slxp'`

Output Arguments

publisher — Name of publisher

character vector | string scalar

Name of publisher that signed the protected model, returned as a character vector or string scalar. If the signature is not verified by a trusted certificate authority, `publisher` returns empty.

tf — True or false result

1 | 0

True or false result, returned as a 1 or 0. `tf` returns 1 if the signature on the protected model is verified by a trusted certificate authority.

See Also**Topics**

“Reference Protected Models from Third Parties”

“Sign a Protected Model” (Simulink Coder)

Introduced in R2020a

Simulink.ProtectedModel.suppressSignatureVerification

Suppress digital signature verification of protected models

Syntax

```
Simulink.ProtectedModel.suppressSignatureVerification(protectedModel)  
Simulink.ProtectedModel.suppressSignatureVerification(protectedModel,  
suppressionSetting)
```

Description

`Simulink.ProtectedModel.suppressSignatureVerification(protectedModel)` suppresses the error that indicates whether the signature on the model `protectedModel` is unverified. Note that this does not suppress the error if the protected model was changed after it was signed. In this case, you cannot use the protected model.

`Simulink.ProtectedModel.suppressSignatureVerification(protectedModel, suppressionSetting)` disables or enables suppression for the model that you specify. To re-enable signature verification, specify `false` for the `suppressionSetting`. To enable signature verification for all protected models, specify `'All'` for the `model` argument. You cannot suppress verification for all models at once.

Examples

Suppress Signature Verification for Model

Suppress the verification of the digital signature for a protected model

Disable signature verification for a protected model named `myProtectedModel`.

```
Simulink.ProtectedModel.suppressSignatureVerification('myProtectedModel.slxp');
```

Enable Signature Verification for All Protected Models

Enable the verification of digital signatures on all protected models that you open.

```
Simulink.ProtectedModel.suppressSignatureVerification('All', false);
```

If you previously suppressed signature verification for individual protected models, verification is re-enabled for those models.

Input Arguments

protectedModel — Protected model
character vector | string scalar | `'All'`

Protected model for which you want to suppress digital signature verification, specified as a character vector or string scalar. To re-enable signature verification for all protected models, specify 'All' for this argument and `false` for the second argument. You cannot suppress signature verification for all protected models at once.

Example: `'myProtectedModel.slxp'`

Example: `'All'`

suppressionSetting — Whether to suppress signature verification

`true` or `1` (default) | `false` or `0`

Whether to suppress digital signature verification for the specified model, specified as a numeric or logical `1` (`true`) or `0` (`false`).

See Also

Topics

“Reference Protected Models from Third Parties”

Introduced in R2020b

Simulink.ProtectedModel.verifySignature

Verify digital signature on protected model

Syntax

```
Simulink.ProtectedModel.verifySignature(protectedModel)
```

Description

`Simulink.ProtectedModel.verifySignature(protectedModel)` verifies the digital signature on the protected model. If the signature is not valid, the function returns an error that indicates why the signature is invalid. A signature is invalid in the following cases:

- The protected model was changed after it was signed.
- The protected model was not signed.
- The protected model was signed with an expired certificate.
- The protected model was self-signed with a certificate issued by the publisher.
- The protected model was signed with a missing or invalid certificate.
- The certificate in your system certificate authority store is missing or invalid.
- The model was signed with an invalid key.

Examples

Verify Digital Signature of Protected Model

Verify the digital signature for the protected model `signed_model_name`.

```
Simulink.ProtectedModel.verifySignature('signed_model_name.slxp')
```

The function returns an error if the signature on the protected model cannot be verified.

Input Arguments

protectedModel — Name of signed protected model

character vector | string scalar

Name of the signed protected model, specified as a character vector or a string scalar.

Example: `'my_model.slxp'`

See Also

Topics

“Reference Protected Models from Third Parties”

“Sign a Protected Model” (Simulink Coder)

Introduced in R2020a

Simulink.restoreDiagnostic

Restore diagnostic warnings to a specific block, subsystem, or model

Syntax

```
Simulink.restoreDiagnostic(source)
Simulink.restoreDiagnostic(source, message_id)
Simulink.restoreDiagnostic(diagnostic)
Simulink.restoreDiagnostic(system, 'FindAll', 'on')
```

Description

`Simulink.restoreDiagnostic(source)` restores all suppressed diagnostics associated with the blocks specified by `source`.

`Simulink.restoreDiagnostic(source, message_id)` restores all instances of `message_id` on the blocks specified by `source`.

`Simulink.restoreDiagnostic(diagnostic)` restores the suppressed diagnostics associated with MSLDiagnostic object `diagnostic`.

`Simulink.restoreDiagnostic(system, 'FindAll', 'on')` restores all suppressed diagnostics associated with the system specified by `system`.

Examples

Restore All Diagnostics for a Specified Block

Using the model from “Suppress Diagnostic Messages Programmatically”, restore all suppressed diagnostics on a specified block.

Create a cell array of message identifiers. Use the `Simulink.suppressDiagnostic` function to suppress these multiple diagnostics from the Constant block, `one`.

```
diags = {'SimulinkFixedPoint:util:fxpParameterPrecisionLoss', ...
        'SimulinkFixedPoint:util:fxpParameterUnderflow'};
Simulink.suppressDiagnostic('Suppressor_CLI_Demo/one', diags);
```

Remove all suppressions and restore diagnostics to the block.

```
Simulink.restoreDiagnostic('Suppressor_CLI_Demo/one');
```

Restore a Diagnostic for a Specified Block

Using the model from “Suppress Diagnostic Messages Programmatically”, restore a suppressed diagnostic on a specified block.

Use the `Simulink.suppressDiagnostic` function to suppress the parameter precision loss warning thrown by the Constant block, one.

```
Simulink.suppressDiagnostic('Suppressor_CLI_Demo/one',...  
    'SimulinkFixedPoint:util:fxpParameterPrecisionLoss');
```

Remove the suppression and restore diagnostics to the block.

```
Simulink.restoreDiagnostic('Suppressor_CLI_Demo/one',...  
    'SimulinkFixedPoint:util:fxpParameterPrecisionLoss');
```

Restore All Diagnostics for a Specified System

Using the model from “Suppress Diagnostic Messages Programmatically”, restore all suppressed diagnostics on the specified subsystem.

To restore all diagnostics from a system, use `'FindAll'`, `'on'` to search within the system hierarchy. Specify the system or system handle within which to search.

```
Simulink.restoreDiagnostic('Suppressor_CLI_Demo/Convert',...  
    'FindAll', 'On');
```

Restore All Diagnostics for a Specified Model

Using the model from “Suppress Diagnostic Messages Programmatically”, restore all suppressed diagnostics on the model.

To restore all diagnostics from a model, specify the model name or model handle.

```
Simulink.restoreDiagnostic('Suppressor_CLI_Demo', 'FindAll', 'on');
```

Input Arguments

source — Block or model object throwing diagnostic

block path | block handle

The source of the diagnostic, specified as a block path, block handle, cell array of block paths, or cell array of block handles.

To get the block path, use the `gcb` function.

To get the block handle, use the `getSimulinkBlockHandle` function.

Data Types: `char` | `cell`

message_id — message identifier of diagnostic

message identifier | cell array of message identifiers

Message identifier of the diagnostic, specified as a character vector or a cell array of character vectors. You can find the message identifier of warnings and errors thrown during simulation by accessing the `ExecutionInfo` property of the `Simulink.SimulationMetadata` object associated with a simulation. You can also use the `lastwarn` function.

Data Types: char | cell

system — Name of subsystem or model

character vector

The subsystem name, subsystem handle, model name, or model handle specified as a character vector.

Data Types: char

diagnostic — Diagnostic object

MSLDiagnostic object

Diagnostic specified as an MSLDiagnostic object. Access the MSLDiagnostic object through the ExecutionInfo property of the Simulink.SimulationMetadata object.

Data Types: struct

See Also

Simulink.getSuppressedDiagnostics | Simulink.suppressDiagnostic | restore | Simulink.SuppressedDiagnostic

Topics

“Suppress Diagnostic Messages Programmatically”

Introduced in R2016b

getBlockSimState

Class: Simulink.SimState.ModelSimState

Package: Simulink.SimState

(Not recommended) Access SimState of individual Stateflow Chart, MATLAB Function, or S-function block

Note Simulink.SimState.ModelSimState.getBlockSimState is not recommended. Use `get` instead.

Syntax

```
blockSimState = getBlockSimState(x, 'blockpath')
```

Description

`blockSimState = getBlockSimState(x, 'blockpath')` returns the SimState of the block specified as `blockpath`. `blockpath` must be either a Stateflow Chart, MATLAB Function, or S-function block. For other types of blocks, see the `loggedStates` property of the Simulink.SimState.ModelSimState class.

Input Arguments

x

The `x` argument is a Simulink.SimState.ModelSimState object.

blockpath

The path to the block for which you are requesting the SimState values.

Output Arguments

blockSimState

The SimState of the block specified.

Examples

```
chartState = getBlockSimState(x, 'mymodel/chart')
```

To get the SimState of a block that is in a referenced model, specify the full path of the block relative to the root model.

```
rootModel = 'sldemo_fuelsys_dd';
opt = struct('SaveFinalState', 'on', 'SaveCompleteFinalSimState', 'on', 'StopTime', '1');
simOut = sim(rootModel, opt);
```



```
x = simOut.xFinal;  
blockPath = 'sldemo_fuelsys_dd/Fuel Rate Controller|sldemo_fuelsys_dd_controller/control_logic';  
chartState = getBlockSimState(x,blockPath)
```

See Also

setBlockSimState

setBlockSimState

Class: Simulink.SimState.ModelSimState

Package: Simulink.SimState

(Not recommended) Set SimState of individual Stateflow Chart, MATLAB Function, or S-function block

Note Simulink.SimState.ModelSimState.setBlockSimState is not recommended. Use set instead.

Syntax

```
setBlockSimState(x, 'blockpath', blockSimState)
```

Description

setBlockSimState(x, 'blockpath', blockSimState) sets the SimState of the block specified as *blockpath*. *blockpath* must be either a Stateflow Chart, MATLAB Function, or S-function block. For other types of blocks, see the `loggedStates` property of the Simulink.SimState.ModelSimState class.

Input Arguments

x

The argument *x* is a Simulink.SimState.ModelSimState object.

blockpath

The path to the block for which you are setting the SimState values

blockSimState

The SimState of the block specified.

Examples

```
newObj = setBlockSimState(obj, 'mymodel/chart', newChartState);
```

See Also

getBlockSimState

Simulink.saveVars

(Not recommended) Save workspace variables and their values in MATLAB code format

Note `Simulink.saveVars` is not recommended. Use `matlab.io.saveVariablesToScript` instead.

Syntax

```
Simulink.saveVars(filename)
Simulink.saveVars(filename, var1,...,varN)
Simulink.saveVars(filename, '-regex',RegExps)
Simulink.saveVars(filename, __, UpdateOption)
Simulink.saveVars(filename, __, Configuration)
Simulink.saveVars(filename, __, MatlabVer)
[r1, r2] = Simulink.saveVars(filename, __)
```

Description

`Simulink.saveVars(filename)` saves all variables in the current workspace for which MATLAB code can be generated to a MATLAB file named `filename.m`. If MATLAB code cannot be generated for a variable, the variable is saved into a companion MAT-file named `filename.mat`, and a warning is generated. If either file already exists, it is overwritten. The file name cannot match the name of any variable in the current workspace, and can optionally include the suffix `.m`. Using `Simulink.saveVars` has no effect on the contents of any workspace.

Executing the MATLAB file restores the variables saved in the file to the current workspace. If a companion MAT-file exists, code in the MATLAB file loads the MAT-file, restoring its variables also. When both a MATLAB file and a MAT-file exist, do not load the MATLAB file unless the MAT file is available, or an error will occur. Do not load a MAT-file directly, or incomplete data restoration will result. No warning occurs if loading a file overwrites any existing variables.

You can edit a MATLAB file that `Simulink.saveVars` creates. You can insert comments between or within the MATLAB code sections for saved variables. However, if you later use `Simulink.saveVars` to update or append to the file, only comments between MATLAB code sections will be preserved. Internal comments should therefore be used only in files that you do not expect to change any further.

You must not edit the header section in the MATLAB file, which comprises the first five comment lines. Simulink does not check that a manually edited MATLAB file is syntactically correct. Do not edit any MATLAB code in the file. You cannot edit a MAT-file and should never attempt to do so.

`Simulink.saveVars(filename, var1,...,varN)` saves only the variables specified by `var1,...,varN`. You can use the wildcard character `*` to save all variables that match a pattern. The `*` matches one or more characters, including non-alphanumeric characters.

`Simulink.saveVars(filename, '-regex',RegExps)` saves only variables whose names match one of the regular expressions in the comma-separated list of expressions `RegExps`. See “Regular Expressions” for more information. A call to the function can specify both `VarNames` and `'-regexps', RegExps`, in that order and comma-separated.

`Simulink.saveVars(filename, ___, UpdateOption)` saves the variables as directed by `UpdateOption`.

`Simulink.saveVars(filename, ___, Configuration)` saves the variables according to the specified configuration options.

`Simulink.saveVars(filename, ___, MatlabVer)` saves any MAT-file that it creates in the format required by the MATLAB version specified by `MatlabVer`.

`[r1, r2] = Simulink.saveVars(filename, ___)` returns the variables saved in `r1` and `r2`.

Examples

Explore Options for Saving Workspace Variables

Define some base workspace variables, then save them to a MATLAB file using a variety of input arguments.

Define some base workspace variables then save them to a new MATLAB file `myVars.m`.

```
a = 1;
b = 2.5;
c = 'A string';
d = {a,b,c};
Simulink.saveVars('myVars');
```

Define additional base workspace variables, then append them to the existing file `myVars.m` without changing the values previously saved in the file.

```
K = Simulink.Parameter;
myType = fixdt(1,16,3);
Simulink.saveVars('myVars', '-append', 'K', 'myType');
```

Update the variables `V1` and `V2` with their values in a MATLAB file, or for any whose value cannot be converted to MATLAB code, in a MAT-file. The file must already exist. Any array with more than 10 elements will be saved to a MAT-file that can be loaded on any version of MATLAB. The return argument `r1` lists the names of any variables saved to a MATLAB file; `r2` lists any saved to a MAT-file.

```
[r1, r2] = Simulink.saveVars('MyFile', 'V1', 'V2', '-update',
'-maxnumel', 10, '-v4');
```

Specify a 2-D slice for the output of the `my3Dtable` 3-D array. Specify that the 2-D slice expands along the first and third dimensions. Review the generated MATLAB code.

```
my3Dtable = zeros(3, 4, 2, 'single');
Simulink.saveVars('mfile.m', 'my3Dtable', '-2dslice', 1, 3);
```

```
my3Dtable = zeros(3, 4, 2, 'single');
my3Dtable(:,1,:) = single( ...
    [1 13;
     5 17;
     9 21]);
my3Dtable(:,2,:) = single( ...
    [2 14;
     6 18];
```

```

    10 22]);
my3DTable(:,3,:) = single( ...
    [3 15;
     7 19;
    11 23]);
my3DTable(:,4,:) = single( ...
    [4 16;
     8 20;
    12 24]);

```

Input Arguments

filename — Name of file to create or update

character vector | string scalar

Name of file that the function creates or updates, specified as a character vector or string scalar. The file name cannot match the name of any variable in the current workspace. The file name can have the suffix `.m`, but the function ignores it.

var1, ..., varN — Variables to save

character vector | string scalar

A variable or sequence of comma-separated variables, specified as a character vector or string scalar. The function saves only the specified variables to the output file. You can use the wildcard character `*` to save all variables that match a pattern. The `*` matches one or more characters, including non-alphanumeric characters.

Example: `Simulink.saveVars('myFile','A*')` saves all variables in the workspace whose names start with `A` with their values.

RegExps — Regular expression

character vector | string

A regular expression or sequence of comma-separated regular expressions, specified as a character vector or string. The function saves to the output file only those variables whose names match one of the expressions. See “Regular Expressions” for more information. A call to the function can specify both `VarNames` and `'-regexp', RegExps`, in that order and comma-separated.

Example: `Simulink.saveVars('myFile','-regexp','v*')`

UpdateOption — Function action

'-create' (default) | 'update' | '-append'

Keyword that controls the action of the function, specified as one of these values:

- `'-create'` — Create a new MATLAB file (and MAT-file if needed).
- `'-update'` — Update the existing MATLAB file (and MAT-file if needed) specified by `filename` by changing only the specified variables that already exist in the file or files. The order of the variables in the file or files is preserved.
- `'-append'` — Update the existing MATLAB file (and MAT-file if needed) specified by `filename` by:
 - Updating the specified variables that already exist in the file or files, preserving the existing order.

- Appending the specified variables that do not exist in the file or files.

Configuration — Configuration options

'-maxnumel' | '-maxlevels' | '-textwidth' | '-2dslice'

Configuration options for the function, specified as any or all of these values, in any order, separated by commas if more than one appears:

- '-maxnumel' MaxNum — Limits the number of elements saved for an array to MaxNum, which must be an integer between 0 and 10000. If an array is larger than that, the whole array appears in the MAT-file rather than the MATLAB script file, generating a warning. Default: 1000
- '-maxlevels' MaxLevels — Limits the number of levels saved for a structure or cell array to MaxLevels, which must be an integer between 0 and 200. If a structure or cell array is deeper than that, the whole entity appears in the MAT-file rather than the MATLAB script file, generating a warning. Default: 20
- '-textwidth' TextWidth — Sets the text wrap width in the MATLAB script file to TextWidth, which must be an integer between 32 and 256. Default: 76
- '-2dslice' — Sets two dimensions for 2-D slices that represent n-D (where n is greater than 2) arrays of char, logic, or numeric data. Using the '-2dslice' option produces more readable generated code that is consistent with how MATLAB displays n-D array data.

Simulink.saveVars uses the first two dimensions of the n-D array to specify the size of the 2-D slice, unless you supply two positive integer arguments after the -2dslice option. If you specify two integer arguments:

- The two integers must be positive.
- The two integers must be less than or equal to the number of dimensions of the n-D array.
- The second integer must be greater than the first.

Note You can use the MATLAB Preferences to change the defaults for the -maxnumel, -maxlevels, '-2dslice', and -textwidth configuration options. In the **Workspace** pane, use the options in the **Saving variables as MATLAB script files** group.

MatlabVer — MATLAB version

'-v7.3' | '-v7.0' | '-v6' | '-v4'

MATLAB version whose syntax will be used by any MAT-file saved by the function, specified by values including:

- '-v7.3' — 7.3 or later
- '-v7.0' — 7.0 or later
- '-v6' — Version 6 or later
- '-v4' — Any MATLAB version

Output Arguments

r1 — Variables saved to a MATLAB file

cell array of character vectors

Variables that were saved to a MATLAB file, specified as a cell array of character vectors.

r2 — Variables saved to a MAT- file

cell array of character vectors

Variables that were saved to a MAT-file, specified as a cell array of character vectors.

Limitations

The `Simulink.saveVars` function:

- Does not preserve shared references.
- Ignores dynamic properties of objects.
- Saves the following to the MAT-file although they could appear in the MATLAB file:
 - `Simulink.ConfigSet` objects with custom target components. (Use the `Simulink.ConfigSet` method `saveAs` instead.)
 - `Simulink.Timeseries` and `Simulink.ModelDataLogs` objects.

If you save many variables, the generated MATLAB file can contain many lines of code and take a long time to execute. To avoid the long execution time, consider these alternatives:

- Permanently store variables in a data dictionary instead of using `Simulink.saveVars`. A data dictionary also provides more tools for managing variables. See “Determine Where to Store Variables and Objects for Simulink Models”.
- Save variables in a MAT-file by using the `save` function.

Tips

- If you do not need to save variables in an easily-understood form, see the `save` function.
- If you need to save only bus objects, use the `Simulink.Bus.save` function.
- If you need to save only a configuration set, use the `Simulink.ConfigSet.saveAs` method.

See Also

`save` | `matlab.io.saveVariablesToScript` | `Simulink.Bus.save` | `Simulink.ConfigSet` | `Simulink.Bus.save`

Introduced in R2010a

Simulink.sdi.addToRun

Package: Simulink.sdi

Add one or more signals to existing run

Syntax

```
sigIDs = Simulink.sdi.addToRun(runID, 'vars', var, var2, ..., varn)  
sigIDs = Simulink.sdi.addToRun(runID, sourceNames, dataValues)
```

Description

`sigIDs = Simulink.sdi.addToRun(runID, 'vars', var, var2, ..., varn)` adds the data in the variables `var`, `var2`, ..., `varn` to the run corresponding to the `runID` and returns the signal IDs for the signals added to the run.

`sigIDs = Simulink.sdi.addToRun(runID, sourceNames, dataValues)` adds the data in the cell array `dataValues` to the run corresponding to the `runID` and returns the signal IDs for the signals added to the run. The `sourceNames` argument specifies names to use for the source of the data in `dataValues` in the signal metadata.

Examples

Add Workspace Data to Run

This example shows how to use `Simulink.sdi.addToRun` to add workspace data to a run in the Simulation Data Inspector.

Generate Workspace Data

Generate workspace data to add to a simulation run in place of measured data, input data, or any other data that you want to associate with the simulation.

```
time = linspace(0, 60, 201);  
cos_vals = 2*cos(2*pi/6.8*time);  
cos_ts = timeseries(cos_vals, time);  
cos_ts.Name = 'cosine';
```

Simulate Model

Simulate the `slexAircraftExample` model to create a run containing the simulation outputs.

```
load_system('slexAircraftExample');  
sim('slexAircraftExample', 'SaveFormat', 'Dataset');
```

Add Workspace Data to Simulation Run

Add the workspace data to the run. Then, view the results in the Simulation Data Inspector.

```
% Get run ID  
count = Simulink.sdi.getRunCount;
```



```
runID = Simulink.sdi.getRunIDByIndex(count);

% Add data to run
sigIDs = Simulink.sdi.addToRun(runID,'vars',cos_ts);

Simulink.sdi.view
```

Input Arguments

runID — Run ID to add data to

scalar

Run ID for the signal you want to add data to. The Simulation Data Inspector assigns a unique run ID when it creates a run. You can get the run ID for your run using `Simulink.sdi.getAllRunIDs` and `Simulink.sdi.getRunIDByIndex`.

var — Data to add to run

variable

Workspace data to add to the run. `Simulink.sdi.addToRun` supports all loading and logging data formats, including timeseries and `Simulink.SimulationData.Dataset`. Provide one or more `var` inputs when you specify `'vars'` as the second argument.

Example: `myData`

sourceNames — Cell array of names for signal metadata

cell array of character vectors

Names to use as the source of the data in the metadata for the added signals. Provide a `sourceNames` input when you specify `'namevalue'` as the second argument.

Example: `{'speed','position'}`

dataValues — Cell array of data to add to run

cell array

Cell array of data to add to the run. Provide a `dataValues` input when you specify `'namevalue'` as the second argument.

Example: `{sig1,sig2}`

Output Arguments

sigIDs — Matrix containing signal IDs for added signals

matrix

Matrix of signal IDs for signals added to the run.

See Also

`Simulink.sdi.createRun` | `Simulink.sdi.createRunOrAddToStreamedRun` | `Simulink.sdi.Run` | `add` | `Simulink.sdi.copyRun`

Topics

“Inspect and Compare Data Programmatically”

Introduced in R2011b

Simulink.sdi.addTrigger

Add trigger to signal to control display updates in the Simulation Data Inspector

Syntax

```
Simulink.sdi.addTrigger(sig)
Simulink.sdi.addTrigger(sig,Name,Value)
```

Description

`Simulink.sdi.addTrigger(sig)` adds a rising-edge trigger using normal mode and auto-level to the `Simulink.sdi.Signal` object, `sig`. The trigger determines when plots in the Simulation Data Inspector update to display new data for streaming signals.

`Simulink.sdi.addTrigger(sig,Name,Value)` adds trigger to the specified signal with trigger settings specified by one or more name-value pair arguments. For example, `'Mode','Normal'` configures normal mode behavior for the trigger. Triggers in the Simulation Data Inspector behave the same as triggers in the Scope block. For details regarding trigger types and settings, see “Scope Triggers Panel”.

Examples

Programmatically Configure Triggers in the Simulation Data Inspector

Add a trigger to a signal in the Simulation Data Inspector to specify criteria that determine when to update plots to display fresh data. Triggers can allow you to capture transient signal behavior and can help stabilize the display of periodic signals so you can take measurements.

Simulate the `Triggers` model. Data in the model logs to the Simulation Data Inspector.

```
open_system('Triggers');
out = sim('Triggers');
```

Then, add a trigger to the `Pulse` signal. Configure the trigger as a falling-edge trigger with a threshold of 0.5.

```
trigRun = Simulink.sdi.getCurrentSimulationRun('Triggers');
pulseSig = getSignalsByName(trigRun,'Pulse');
Simulink.sdi.addTrigger(pulseSig,'Type','Edge','Level',0.5);
```

You can verify that the trigger was added and configured correctly by opening the Simulation Data Inspector using `Simulink.sdi.view` and clicking the trigger icon next to the `Pulse` signal to check the configuration. You can also use the `Simulink.sdi.getTrigger` function to check which signal is used to generate trigger events and the trigger configuration.

```
[sig,trigOpts] = Simulink.sdi.getTrigger;
```

```
sig.Name
```

```
ans =
'Pulse'
```

```

trigOpts
trigOpts = struct with fields:
    Mode: 'Auto'
    Type: 'Edge'
    Position: 0.5000
    Delay: 0
    SourceChannelComplexity: 'Scalar'
    Polarity: 'Positive'
    AutoLevel: 1
    Level: 0.5000
    UpperLevel: 0
    LowerLevel: 0
    Hysteresis: 0
    MinTime: 0
    MaxTime: Inf
    Timeout: 0
    Holdoff: 0

```

When you do not want to use a trigger to control when the Simulation Data Inspector updates the plots with fresh data, you can remove the trigger using the `Simulink.sdi.removeTrigger` function.

```
Simulink.sdi.removeTrigger
```

You can verify that the trigger was removed in the Simulation Data Inspector UI or using the `Simulink.sdi.getTrigger` function. The `Simulink.sdi.getTrigger` function returns an empty array of `Simulink.sdi.Signal` objects when no trigger is configured in the Simulation Data Inspector.

```

sig = Simulink.sdi.getTrigger;
size(sig)

ans = 1×2

     0     0

```

Input Arguments

sig — Signal used to detect trigger events

`Simulink.sdi.Signal` object

Signal used to detect trigger events, specified as a `Simulink.sdi.Signal` object.

Name-Value Pair Arguments

Specify optional comma-separated pairs of `Name`, `Value` arguments. `Name` is the argument name and `Value` is the corresponding value. `Name` must appear inside quotes. You can specify several name and value pair arguments in any order as `Name1, Value1, ..., NameN, ValueN`.

Example: `'Type', 'PulseWidth', 'Polarity', 'Falling'` configures a falling-edge, auto-leveled trigger in auto mode.

Mode — When display updates in response to trigger event

Auto (default) | Normal | Once

When display updates in response to trigger event, specified as the comma-separated pair consisting of 'Mode' and one of these options:

- **Auto** — Plots update in response to each trigger event, and the plots update if no trigger event occurs for the duration of time range displayed.
- **Normal** — Plots update in response to each trigger event.
- **Once** — Plots update in response to the first trigger event. You can manually rearm the trigger using the Simulation Data Inspector.

Example: 'Mode', 'Normal' configures the trigger to use normal mode.

Position — Where trigger event appears in plot

50 (default) | numeric percentage

Where trigger event appears in plot, specified as the comma-separated pair consisting of 'Position' and a numeric percentage. By default, the trigger event appears in the middle of the plot, with a position of 0.5, or at the 50% position within the time span.

Example: 'Position', .3 positions the trigger event at the 30% point within the time span.

Type — Type of trigger to add to signal

Edge (default) | PulseWidth | Transition | Runt | Window | Timeout

Type of trigger to add to signal, specified as the comma-separated pair consisting of 'Type' and one of these options:

- **Edge** — Trigger when the signal crosses a threshold.
- **PulseWidth** — Trigger when the signal crosses twice between a low threshold and high threshold within a specified time.
- **Transition** — Trigger when the signal crosses a high threshold and a low threshold within a specified time.
- **Runt** — Trigger when a signal crosses a low threshold or a high threshold twice within a specified time.
- **Window** — Trigger when a signal stays within or outside a range defined by a high threshold and a low threshold for a specified time.
- **Timeout** — Trigger when a signal stays above or below a threshold longer than a specified time.

For details regarding options for each type of trigger, see “Scope Triggers Panel”.

Example: 'Type', 'PulseWidth' configures a pulse width trigger.

Polarity — Direction of signal value change that causes trigger event

valid polarity for trigger type

Direction of signal value change that causes trigger event, specified as the comma-separated pair consisting of 'Polarity' and a valid polarity for the trigger type.

| Trigger Type | Polarity Options |
|--------------|---|
| Edge | <ul style="list-style-type: none"> • Rising — Trigger when the signal crosses the threshold while increasing in value. • Falling — Trigger when the signal crosses the threshold while decreasing in value. • Either — Trigger when the signal crosses the threshold while increasing or decreasing in value. |
| PulseWidth | <ul style="list-style-type: none"> • Positive — Trigger on a rising pulse when the signal crosses the low threshold for a second time. • Negative — Trigger on a falling pulse when the signal crosses the high threshold for a second time. • Either — Trigger on both rising and falling pulses. |
| Transition | <ul style="list-style-type: none"> • RiseTime — Trigger when the signal increases to cross from the low to the high threshold within the specified time. • FallTime — Trigger when the signal decreases to cross from the high threshold to the low threshold within the specified time. • Either — Trigger when the signal increases or decreases to cross the low and high thresholds within the specified time. |
| Runt | <ul style="list-style-type: none"> • Positive — Trigger on a rising pulse when the signal crosses the low threshold for a second time without crossing the high threshold. • Negative — Trigger on a falling pulse when the signal crosses the high threshold for a second time without crossing the low threshold. • Either — Trigger on rising or falling pulses that stay within the specified value thresholds. |

| Trigger Type | Polarity Options |
|--------------|---|
| Window | <ul style="list-style-type: none"> • Inside — Trigger when a signal stays within the specified value range for a duration between the <code>MinTime</code> and <code>MaxTime</code>. The trigger event occurs when the signal exits the specified value range. • Outside — Trigger when a signal is outside the specified value range for a duration between the <code>MinTime</code> and the <code>MaxTime</code>. The trigger event occurs when the signal reenters the specified value range. • Either — Trigger when the signal is inside or outside of the specified value range for a duration between the <code>MinTime</code> and the <code>MaxTime</code>. |
| Timeout | <ul style="list-style-type: none"> • Rising — Trigger when the signal remains above the threshold for longer than the specified time. • Falling — Trigger when the signal remains below the threshold for longer than the specified time. • Either — Trigger when the signal remains either above or below the threshold for longer than the specified time. |

Example: `'Type', 'Edge', 'Polarity', 'Rising'` configures a rising-edge trigger.

AutoLevel — Whether to automatically determine trigger levels

`true` or `1` (default) | `false` or `0`

Whether to automatically determine trigger levels, specified as the comma-separated pair consisting of `'AutoLevel'` and `true` or `false`.

When you want to specify thresholds for the trigger, specify `'AutoLevel'` as `false`.

Example: `'AutoLevel', false` configures a trigger to use a user-specified level.

Level — Threshold for trigger events

numeric scalar

Threshold for trigger events, specified as the comma-separated pair consisting of `'Level'` and a numeric scalar.

You can only specify the `'Level'` name-value pair when you specify the `'Type'` name-value pair as `'Edge'` or `'Timeout'`.

Example: `'Type', 'Timeout', 'Level', '0.5'` configures a timeout trigger with a threshold of `0.5`.

Hysteresis — Signal value change required around threshold to cause trigger event

numeric scalar

Signal value change required around threshold to cause trigger event, specified as the comma-separated pair consisting of 'Hysteresis' and a numeric scalar. Specifying a hysteresis for the trigger results in noise rejection for trigger events.

You can only specify the 'Hysteresis' name-value pair when you specify the 'Type' name-value pair as 'Edge' or 'Timeout'.

Example: 'Type', 'Timeout', 'Hysteresis', '0.05' configures a timeout trigger that requires the signal value to change by more than 0.05 around the threshold to cause a trigger event.

UpperLevel — Upper threshold for trigger event

numeric scalar

Upper threshold for trigger event, specified as the comma-separated pair consisting of 'UpperLevel' and a numeric scalar.

You can only specify the 'UpperLevel' name-value pair when you specify the 'Type' name-value pair as 'PulseWidth', 'Transition', 'Runt', or 'Window'.

Example: 'Type', 'PulseWidth', 'UpperLevel', '0.9' configures a pulse width trigger with an upper threshold of 0.9.

LowerLevel — Lower threshold for trigger event

numeric scalar

Lower threshold for trigger event, specified as the comma-separated pair consisting of 'LowerLevel' and a numeric scalar.

You can only specify the 'LowerLevel' name-value pair when you specify the 'Type' name-value pair as 'PulseWidth', 'Transition', 'Runt', or 'Window'.

Example: 'Type', 'PulseWidth', 'LowerLevel', '0.1' configures a pulse width trigger with a lower threshold of 0.1.

MinTime — Lower time limit for trigger event

numeric scalar

Lower time limit for trigger event, specified as the comma-separated pair consisting of 'MinTime' and a numeric scalar. You can only specify the 'MinTime' name-value pair when you specify the 'Type' name-value pair as 'PulseWidth', 'Transition', 'Runt', or 'Window'. The significance of the lower time limit depends on the type of trigger.

- 'PulseWidth' — Minimum pulse width for trigger event.
- 'Transition' — Minimum rise or fall time for trigger event.
- 'Runt' — Minimum pulse width for trigger event.
- 'Window' — Minimum time spent within or outside value range for trigger event.

Example: 'Type', 'PulseWidth', 'MinTime', '0.1' configures a pulse width trigger with a minimum pulse width of 100ms.

MaxTime — Upper time limit for trigger event

numeric scalar

Upper time limit for trigger event, specified as the comma-separated pair consisting of 'MaxTime' and a numeric scalar. You can only specify the 'MaxTime' name-value pair when you specify the

'Type' name-value pair as 'PulseWidth', 'Transition', 'Runt', or 'Window'. The significance of the upper time limit depends on the type of trigger.

- 'PulseWidth' — Maximum pulse width for trigger event.
- 'Transition' — Maximum rise or fall time for trigger event.
- 'Runt' — Maximum pulse width for trigger event.
- 'Window' — Maximum time spent within or outside value range for trigger event.

Example: 'Type', 'PulseWidth', 'MaxTime', '0.5' configures a pulse width trigger with a maximum pulse width of 500ms.

Timeout — Time threshold for timeout trigger

numeric scalar

Time threshold for timeout trigger, specified as the comma-separated pair consisting of 'Timeout' and a numeric scalar.

You can only specify the 'Timeout' name-value pair when you specify the 'Type' name-value pair as 'Timeout'.

Example: 'Type', 'Timeout', 'Timeout', '0.5' configures a timeout trigger that causes an event when a signal is above or below the value threshold for longer than 500ms.

Delay — Trigger event offset from trigger position

numeric scalar

Trigger event offset from trigger position, specified as the comma-separated pair consisting of 'Delay' and a numeric scalar.

Example: 'Type', 'Edge', 'Delay', '0.1' configures an edge trigger where the trigger position marker is displayed 100ms after the trigger event.

Holdoff — Minimum time between trigger events

numeric scalar

Minimum time between trigger events, specified as the comma-separated pair consisting of 'Holdoff' and a numeric scalar. After a trigger event, the display does not update again for at least the holdoff time.

Example: 'Type', 'Edge', 'Holdoff', '1' configures an edge trigger with a holdoff of 1s. After a trigger event, the display does not update for at least 1s.

Alternative Functionality

You can add a trigger to a signal and configure the trigger options using the Simulation Data Inspector UI. For details, see “Control Display of Streaming Data Using Triggers”.

See Also

Objects

Simulink.sdi.Signal | Simulink.sdi.Run

Functions

`getSignalsByName` | `getSignalByIndex` | `Simulink.sdi.getSignal` |
`Simulink.sdi.getTrigger` | `Simulink.sdi.removeTrigger`

Topics

“Control Display of Streaming Data Using Triggers”
“Inspect and Compare Data Programmatically”
“Scope Triggers Panel”

Introduced in R2020b

Simulink.sdi.cleanupWorkerResources

Clean up worker repositories

Syntax

```
Simulink.sdi.cleanupWorkerResources
```

Description

`Simulink.sdi.cleanupWorkerResources` removes redundant data from each parallel worker repository file used by the Simulation Data Inspector. Call this function while worker pools are running. The Simulation Data Inspector automatically cleans up repository files when you close the worker pool.

Examples

Access Data from a Parallel Simulation

This example executes parallel simulations of the model `slexAircraftExample` with different input filter time constants and shows several ways to access the data using the Simulation Data Inspector programmatic interface.

Setup

Start by ensuring the Simulation Data Inspector is empty and Parallel Computing Toolbox support is configured to import runs created on local workers automatically. Then, create a vector of filter parameter values to use in each simulation.

```
% Make sure the Simulation Data Inspector is empty, and PCT support is
% enabled.
Simulink.sdi.clear
Simulink.sdi.enablePCTSupport('local')

% Define Ts values
Ts_vals = [0.01, 0.02, 0.05, 0.1, 0.2, 0.5, 1];
```

Initialize Parallel Workers

Use `gcp` to create a pool of local workers to run parallel simulations if you don't already have one. In an `spm` code block, load the `slexAircraftExample` model and select signals to log. To avoid data concurrency issues using `sim` in `parfor`, create a temporary directory for each worker to use during simulations.

```
p = gcp;
```

```
Starting parallel pool (parpool) using the 'local' profile ...
connected to 4 workers.
```

```
spm
```

```
    % Load system and select signals to log
```

```

load_system('slexAircraftExample')
Simulink.sdi.markSignalForStreaming('slexAircraftExample/Pilot', 1, 'on')
Simulink.sdi.markSignalForStreaming('slexAircraftExample/Aircraft Dynamics Model', 4, 'on')

% Create temporary directory on each worker
workDir = pwd;
addpath(workDir)
tempDir = tempname;
mkdir(tempDir)
cd(tempDir)

```

end

Run Parallel Simulations

Use `parfor` to run the seven simulations in parallel. Select the value for `Ts` for each simulation, and modify the value of `Ts` in the model workspace. Then, run the simulation and build an array of `Simulink.sdi.WorkerRun` objects to access the data with the Simulation Data Inspector. After the `parfor` loop, use another `spmd` segment to remove the temporary directories from the workers.

```

parfor index = 1:7

    % Select value for Ts
    Ts_val = Ts_vals(index);

    % Change the filter time constant and simulate
    modelWorkspace = get_param('slexAircraftExample','modelworkspace');
    modelWorkspace.assignin('Ts',Ts_val)
    sim('slexAircraftExample')

    % Create a worker run for each simulation
    workerRun(index) = Simulink.sdi.WorkerRun.getLatest

```

end

spmd

```

% Remove temporary directories
cd(workDir)
rmdir(tempDir, 's')
rmpath(workDir)

```

end

Get Dataset Objects from Parallel Simulation Output

The `getDataset` method puts the data from a `WorkerRun` into a `Dataset` object so you can easily post-process.

```

ds(7) = Simulink.SimulationData.Dataset;

for a = 1:7
    ds(a) = workerRun(a).getDataset;
end
ds(1)

ans =
Simulink.SimulationData.Dataset '' with 2 elements

```

| | Name | BlockPath |
|----------------|------------|--|
| 1 [1x1 Signal] | alpha, rad | ...rcraftExample/Aircraft Dynamics Model |
| 2 [1x1 Signal] | Stick | slexAircraftExample/Pilot |

- Use braces { } to access, modify, or add elements using index.

Get DatasetRef Objects from Parallel Simulation Output

For big data workflows, use the `getDatasetRef` method to reference the data associated with the `WorkerRun`.

```
for b = 1:7
    datasetRef(b) = workerRun(b).getDatasetRef;
end
```

```
datasetRef(1)
```

```
ans =
    DatasetRef with properties:

        Name: 'Run 3: slexAircraftExample'
         Run: [1x1 Simulink.sdi.Run]
    numElements: 2
```

Process Parallel Simulation Data in the Simulation Data Inspector

You can also create local Run objects to analyze and visualize your data using the Simulation Data Inspector API. This example adds a tag indicating the filter time constant value for each run.

```
for c = 1:7

    Runs(c) = workerRun(c).getLocalRun;
    Ts_val_str = num2str(Ts_vals(c));
    desc = strcat('Ts = ', Ts_val_str);
    Runs(c).Description = desc;
    Runs(c).Name = strcat('slexAircraftExample run Ts=', Ts_val_str);

end
```

Clean Up Worker Repositories

Clean up the files used by the workers to free up disk space for other simulations you want to run on your worker pool.

```
Simulink.sdi.cleanupWorkerResources
```

See Also

[Simulink.sdi.isPCTSupportEnabled](#) | [Simulink.sdi.WorkerRun](#)

Topics

“Inspect and Compare Data Programmatically”

Introduced in R2017b

Simulink.sdi.clear

Package: Simulink.sdi

Clear all data from the Simulation Data Inspector

Syntax

```
Simulink.sdi.clear
```

Description

`Simulink.sdi.clear` clears all plotted signals and deletes all data from the Simulation Data Inspector. The `Simulink.sdi.clear` function does not affect preferences or settings you have configured in the Simulation Data Inspector. Use the `Simulink.sdi.clearPreferences` function to reset the Simulation Data Inspector preferences to their default values. Use the `Simulink.sdi.clearAllSubPlots` function to clear all plotted signals without deleting any data from the Simulation Data Inspector.

Examples

Save a Simulation Data Inspector Session

This example creates, saves, and loads a Simulation Data Inspector session. The example logs data in the model `slexAircraftExample` and visualizes the logged data in a Simulation Data Inspector session. Each time you use the Simulation Data Inspector, you create and modify a session. You can save the data and associated visualization settings for a session in an MLDATX file using the `Simulink.sdi.save` function. When you want to review the data later, you can load the session using the `Simulink.sdi.load` function.

Log Data to the Simulation Data Inspector

This example logs data from a simulation of the model `slexAircraftExample` to the Simulation Data Inspector. The model is not configured to log data. Load the model and mark the `Stick`, the `alpha`, `rad`, and the `q`, `rad/sec` signals for logging.

```
load_system('slexAircraftExample')

Simulink.sdi.markSignalForStreaming('slexAircraftExample/Pilot',1,'on')
Simulink.sdi.markSignalForStreaming('slexAircraftExample/Aircraft Dynamics Model',3,'on')
Simulink.sdi.markSignalForStreaming('slexAircraftExample/Aircraft Dynamics Model',4,'on')
```

For this example, run two simulations of the model. In the first simulation, use the sine wave output from the `Pilot` block, and in the second, use the square wave output.

```
set_param('slexAircraftExample/Pilot','WaveForm','sine')
sim('slexAircraftExample')

set_param('slexAircraftExample/Pilot','WaveForm','square')
sim('slexAircraftExample')
```

Visualize the Logged Data

You can use the Simulation Data Inspector programmatic interface to access the logged data from the simulations. When you access data using the Simulation Data Inspector programmatic interface, you can use functions to create plots in the Simulation Data Inspector.

To start, access the run IDs for the most recent two runs and then get the corresponding `Simulink.sdi.Run` object. The Run objects allow you to access the logged data for the simulations.

```
runIDs = Simulink.sdi.getAllRunIDs;
sineRunID = runIDs(end-1);
squareRunID = runIDs(end);

sineRun = Simulink.sdi.getRun(sineRunID);
squareRun = Simulink.sdi.getRun(squareRunID);
```

Suppose you want to analyze the relationship between the input and output for the model. Get the `Simulink.sdi.Signal` objects for the input and output signals from the two simulation runs.

```
sineOut = getSignalByIndex(sineRun,1);
sineIn = getSignalByIndex(sineRun,3);

squareOut = getSignalByIndex(squareRun,1);
squareIn = getSignalByIndex(squareRun,3);
```

Change the subplot layout in the Simulation Data Inspector to 2-by-1 and plot the signals from the first simulation run on the top plot and the signals from the second run on the bottom plot.

```
Simulink.sdi.setSubPlotLayout(2,1)

plotOnSubPlot(sineIn,1,1,true)
plotOnSubPlot(sineOut,1,1,true)

plotOnSubPlot(squareIn,2,1,true)
plotOnSubPlot(squareOut,2,1,true)
```

Save the Simulation Data Inspector Session

To view the plotted data in the Simulation Data Inspector, enter `Simulink.sdi.view` in the command window.

Then, save the Simulation Data Inspector session as an MLDATX file.

```
Simulink.sdi.save('myData.mldatx')
```

Load the Simulation Data Inspector Session

To mimic a scenario where you want to return to looking at the same data at a later point, clear the data from the Simulation Data Inspector and reset the subplot layout to 1-by-1.

```
Simulink.sdi.clear
Simulink.sdi.setSubPlotLayout(1,1)
```

Load the session file and resume working with the data. You can open the Simulation Data Inspector and view the results using the `Simulink.sdi.view` function.

```
Simulink.sdi.load('myData.mldatx');
```

See Also

[Simulink.sdi.clearPreferences](#) | [Simulink.sdi.deleteRun](#) |
[Simulink.sdi.deleteSignal](#) | [Simulink.sdi.clearAllSubPlots](#)

Topics

“Inspect and Compare Data Programmatically”

Introduced in R2011b

Simulink.sdi.clearAllSubPlots

Clear plotted signals from all subplots in the Simulation Data Inspector

Syntax

```
Simulink.sdi.clearAllSubPlots
```

Description

`Simulink.sdi.clearAllSubPlots` clears plotted signals from all subplots in the Simulation Data Inspector, including any subplots with plotted data that are not visible in the current layout. Clearing plotted signals using the `Simulink.sdi.clearAllSubPlots` function does not delete data from the Simulation Data Inspector. To clear plotted signals and delete data from the Simulation Data Inspector, use the `Simulink.sdi.clear` function.

Examples

Clear Plotted Signals from All Subplots

You can programmatically clear plotted signals from all subplots in the Simulation Data Inspector. For example, clear plotted data at the start of a script that creates plots.

```
Simulink.sdi.clearAllSubPlots
```

Plot Signals from Simulation Run

This example demonstrates how to access the `Simulink.sdi.Run` object for a Simulation Data Inspector run created by logging signals. From the `Simulink.sdi.Run` object you can get `Simulink.sdi.Signal` objects that contain the logged signal data and metadata. You can use the `Signal` objects and the `plotOnSubPlot` function to plot the data in the Simulation Data Inspector.

Create a Simulation Run and Access the Run Object

The `ex_vdp` model logs two signals. To create a simulation run containing the logged data, simulate the model.

```
sim('ex_vdp');
```

The Simulation Data Inspector keeps track of runs by assigning a unique numeric run ID to each run created by simulation, importing data, or opening a session. To access the run object for the simulation you just performed, use the `Simulink.sdi.getAllRunIDs` function and take the last run ID in the returned vector.

```
runIDs = Simulink.sdi.getAllRunIDs;  
runID = runIDs(end);
```

Once you have the run ID for the run, you can use the `Simulink.sdi.getRun` function to get the `Simulink.sdi.Run` object that corresponds to the run. You can use the Run object to check the metadata associated with the run, including the number of signals in the run.

```
vdpRun = Simulink.sdi.getRun(runID);  
  
vdpRun.SignalCount  
ans = int32  
     2
```

Plot Data Using Signal Objects

Use the `getSignalByIndex` function to access signals from the Run object, `fuelRun`.

```
signal1 = getSignalByIndex(vdpRun,1);  
signal2 = getSignalByIndex(vdpRun,2);
```

Use the `Simulink.sdi.setSubPlotLayout` function to specify a 3-by-1 layout.

```
Simulink.sdi.setSubPlotLayout(2,1)
```

Before plotting the data, use the `Simulink.sdi.clearAllSubPlots` function to clear any data that is already plotted.

```
Simulink.sdi.clearAllSubPlots
```

Plot one signal on each subplot. To plot signals on the first subplot, you can set the `checked` property for the signal. To plot signals on subplots other than the first subplot, use the `plotOnSubPlot` function.

```
signal1.Checked = true;  
plotOnSubPlot(signal2,2,1,true);
```

View the Plotted Data

To view the plots you just created, open the Simulation Data Inspector using the `Simulink.sdi.view` function.

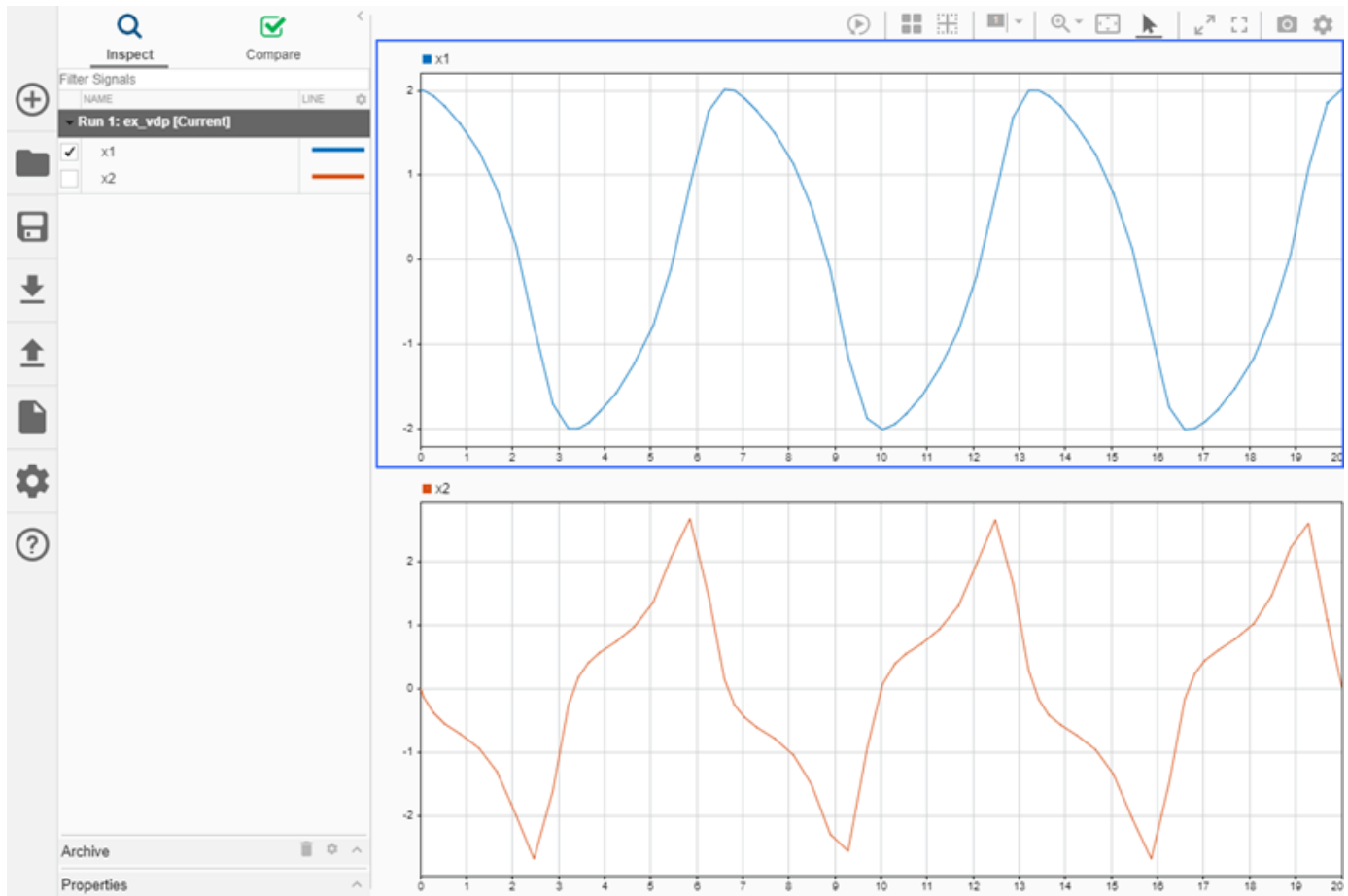

See Also

[Simulink.sdi.clear](#) | [Simulink.sdi.clearPreferences](#) | [plotOnSubPlot](#) | [Simulink.sdi.setSubPlotLayout](#) | [Simulink.sdi.Signal](#)

Topics

“Create Plots Using the Simulation Data Inspector”

Introduced in R2019b

Simulink.sdi.clearPreferences

Restore Simulation Data Inspector preferences to default settings

Syntax

```
Simulink.sdi.clearPreferences
```

Description

`Simulink.sdi.clearPreferences` restores all Simulation Data Inspector preferences to their default values.

You can configure these preferences in the Simulation Data Inspector programmatically:

- Preferences:
 - Run naming rule — `Simulink.sdi.setRunNamingRule`
 - Subplot layout — `Simulink.sdi.setSubPlotLayout`
 - Signal grouping within a run — `Simulink.sdi.setTableGrouping`
- Time plot settings:
 - Border display — `Simulink.sdi.setBorderOn`
 - Grid display — `Simulink.sdi.setGridOn`
 - Data markers display — `Simulink.sdi.setMarkersOn`
 - Tick mark labels display — `Simulink.sdi.setTickLabelsDisplay`
 - Tick mark position — `Simulink.sdi.setTicksPosition`
- Archive preferences:
 - Archive behavior — `Simulink.sdi.setAutoArchiveMode`
 - Archive size limit — `Simulink.sdi.setArchiveRunLimit`

Examples

Restore All Simulation Data Inspector Preferences to Default Values

You can restore default values to all Simulation Data Inspector preferences programmatically using the `Simulink.sdi.clearPreferences` function.

```
Simulink.sdi.clearPreferences
```

Modify Run Naming Rule Then Restore Default

This example shows how to use the Simulation Data Inspector API to modify the Simulation Data Inspector run naming rule, check a run's name, restore default preferences, and check the run naming rule.

```
% Load model
load_system('sldemo_fuelsys')

% Modify run naming rule
Simulink.sdi.setRunNamingRule('<model_name> Run <run_index>')

% Simulate system
sim('sldemo_fuelsys')

% Check run name
runIDs = Simulink.sdi.getAllRunIDs;
runID = runIDs(end);
fuelRun = Simulink.sdi.getRun(runID);
fuelRun.name

ans =
'sldemo_fuelsys Run 1'

% Clear preferences to reset the run naming rule
Simulink.sdi.clearPreferences

% Check run naming rule
Simulink.sdi.getRunNamingRule

ans =
'Run <run_index>: <model_name>'
```

See Also

[Simulink.sdi.clear](#) | [Simulink.sdi.clearAllSubPlots](#)

Topics

“Configure the Simulation Data Inspector”

“Inspect and Compare Data Programmatically”

Introduced in R2017a

Simulink.sdi.close

Package: Simulink.sdi

Close the Simulation Data Inspector

Syntax

```
Simulink.sdi.close  
Simulink.sdi.close('filename')
```

Description

`Simulink.sdi.close` closes the **Simulation Data Inspector**.

`Simulink.sdi.close('filename')` closes the Simulation Data Inspector and saves the data in the file, `filename`.

Examples

Close the Simulation Data Inspector from the Command Line

You can close the Simulation Data Inspector from the MATLAB command line when you have finished inspecting and analyzing your data.

```
Simulink.sdi.close
```

Create a Run and View the Data

This example shows how to create a run, add data to it, and then view the data in the Simulation Data Inspector.

Create Data for the Run

Create `timeseries` objects to contain data for a sine signal and a cosine signal. Give each `timeseries` object a descriptive name.

```
time = linspace(0,20,100);  
  
sine_vals = sin(2*pi/5*time);  
sine_ts = timeseries(sine_vals,time);  
sine_ts.Name = 'Sine, T=5';  
  
cos_vals = cos(2*pi/8*time);  
cos_ts = timeseries(cos_vals,time);  
cos_ts.Name = 'Cosine, T=8';
```

Create a Run and Add Data

Use the `Simulink.sdi.view` function to open the Simulation Data Inspector.

```
Simulink.sdi.view
```

To import data into the Simulation Data Inspector from the workspace, create a `Simulink.sdi.Run` object using the `Simulink.sdi.Run.create` function. Add information about the run to its metadata using the `Name` and `Description` properties of the `Run` object.

```
sinusoidsRun = Simulink.sdi.Run.create;  
sinusoidsRun.Name = 'Sinusoids';  
sinusoidsRun.Description = 'Sine and cosine signals with different frequencies';
```

Use the `add` function to add the data you created in the workspace to the empty run.

```
add(sinusoidsRun, 'vars', sine_ts, cos_ts);
```

Plot the Data in the Simulation Data Inspector

Use the `getSignalByIndex` function to access `Simulink.sdi.Signal` objects that contain the signal data. You can use the `Simulink.sdi.Signal` object properties to specify the line style and color for the signal and plot it in the Simulation Data Inspector. Specify the `LineColor` and `LineDashed` properties for each signal.

```
sine_sig = getSignalByIndex(sinusoidsRun,1);  
sine_sig.LineColor = [0 0 1];  
sine_sig.LineDashed = '-.';  
  
cos_sig = sinusoidsRun.getSignalByIndex(2);  
cos_sig.LineColor = [0 1 0];  
cos_sig.LineDashed = '--';
```

Use the `Simulink.sdi.setSubPlotLayout` function to configure a 2-by-1 subplot layout in the Simulation Data Inspector plotting area. Then use the `plotOnSubplot` function to plot the sine signal on the top subplot and the cosine signal on the lower subplot.

```
Simulink.sdi.setSubPlotLayout(2,1);  
  
plotOnSubPlot(sine_sig,1,1,true);  
plotOnSubPlot(cos_sig,2,1,true);
```

Close the Simulation Data Inspector and Save Your Data

When you have finished inspecting the plotted signal data, you can close the Simulation Data Inspector and save the session to an `MLDATX` file.

```
Simulink.sdi.close('sinusoids.mldatx')
```

See Also

Functions

`Simulink.sdi.save` | `Simulink.sdi.view` | `Simulink.sdi.clear` | `Simulink.sdi.clearPreferences`

Tools

Simulation Data Inspector

Topics

“Inspect and Compare Data Programmatically”

“Save and Share Simulation Data Inspector Data and Views”

Introduced in R2013b

Simulink.sdi.compareRuns

Package: Simulink.sdi

Compare data in two simulation runs

Syntax

```
diffResult = Simulink.sdi.compareRuns(runID1,runID2)
diffResult = Simulink.sdi.compareRuns(runID1,runID2,Name,Value)
```

Description

`diffResult = Simulink.sdi.compareRuns(runID1,runID2)` compares the data in the runs that correspond to `runID1` and `runID2` and returns the result in the `Simulink.sdi.DiffRunResult` object `diffResult`. The comparison uses the Simulation Data Inspector comparison algorithm. For more information about the algorithm, see “How the Simulation Data Inspector Compares Data”.

`diffResult = Simulink.sdi.compareRuns(runID1,runID2,Name,Value)` compares the simulation runs that correspond to `runID1` and `runID2` using the options specified by one or more `Name,Value` pair arguments. For more information about how the options can affect the comparison, see “How the Simulation Data Inspector Compares Data”.

Examples

Compare Runs with Global Tolerance

You can specify global tolerance values to use when comparing two simulation runs. Global tolerance values are applied to all signals within the run. This example shows how to specify global tolerance values for a run comparison and how to analyze and save the comparison results.

First, load the session file that contains the data to compare. The session file contains data for four simulations of an aircraft longitudinal controller. This example compares data from two runs that use different input filter time constants.

```
Simulink.sdi.load('AircraftExample.mldatx');
```

To access the run data to compare, use the `Simulink.sdi.getAllRunIDs` function to get the run IDs that correspond to the last two simulation runs.

```
runIDs = Simulink.sdi.getAllRunIDs;
runID1 = runIDs(end - 1);
runID2 = runIDs(end);
```

Use the `Simulink.sdi.compareRuns` function to compare the runs. Specify a global relative tolerance value of 0.2 and a global time tolerance value of 0.5.

```
runResult = Simulink.sdi.compareRuns(runID1,runID2,'reltol',0.2,'timetol',0.5);
```

Check the `Summary` property of the returned `Simulink.sdi.DiffRunResult` object to see whether signals were within the tolerance values or out of tolerance.

```
runResult.Summary
ans = struct with fields:
    OutOfTolerance: 0
    WithinTolerance: 3
    Unaligned: 0
    UnitsMismatch: 0
    Empty: 0
    Canceled: 0
    EmptySynced: 0
    DataTypeMismatch: 0
    TimeMismatch: 0
    StartStopMismatch: 0
    Unsupported: 0
```

All three signal comparison results fell within the specified global tolerance.

You can save the comparison results to an MLDATX file using the `saveResult` function.

```
saveResult(runResult, 'InputFilterComparison');
```

Analyze Simulation Data Using Signal Tolerances

You can programmatically specify signal tolerance values to use in comparisons performed using the Simulation Data Inspector. In this example, you compare data collected by simulating a model of an aircraft longitudinal flight control system. Each simulation uses a different value for the input filter time constant and logs the input and output signals. You analyze the effect of the time constant change by comparing results using the Simulation Data Inspector and signal tolerances.

First, load the session file that contains the simulation data.

```
Simulink.sdi.load('AircraftExample.mldatx');
```

The session file contains four runs. In this example, you compare data from the first two runs in the file. Access the `Simulink.sdi.Run` objects for the first two runs loaded from the file.

```
runIDs = Simulink.sdi.getAllRunIDs;
runIDTs1 = runIDs(end-3);
runIDTs2 = runIDs(end-2);
```

Now, compare the two runs without specifying any tolerances.

```
noTolDiffResult = Simulink.sdi.compareRuns(runIDTs1, runIDTs2);
```

Use the `getResultByIndex` function to access the comparison results for the `q` and `alpha` signals.

```
qResult = getResultByIndex(noTolDiffResult, 1);
alphaResult = getResultByIndex(noTolDiffResult, 2);
```

Check the `Status` of each signal result to see whether the comparison result fell within our out of tolerance.

```
qResult.Status  
ans =  
    ComparisonSignalStatus enumeration  
    OutOfTolerance
```

```
alphaResult.Status  
ans =  
    ComparisonSignalStatus enumeration  
    OutOfTolerance
```

The comparison used a value of 0 for all tolerances, so the `OutOfTolerance` result means the signals are not identical.

You can further analyze the effect of the time constant by specifying tolerance values for the signals. Specify the tolerances by setting the properties for the `Simulink.sdi.Signal` objects that correspond to the signals being compared. Comparisons use tolerances specified for the baseline signals. This example specifies a time tolerance and an absolute tolerance.

To specify a tolerance, first access the `Signal` objects from the baseline run.

```
runTs1 = Simulink.sdi.getRun(runIDTs1);  
qSig = getSignalsByName(runTs1, 'q, rad/sec');  
alphaSig = getSignalsByName(runTs1, 'alpha, rad');
```

Specify an absolute tolerance of 0.1 and a time tolerance of 0.6 for the `q` signal using the `AbsTol` and `TimeTol` properties.

```
qSig.AbsTol = 0.1;  
qSig.TimeTol = 0.6;
```

Specify an absolute tolerance of 0.2 and a time tolerance of 0.8 for the `alpha` signal.

```
alphaSig.AbsTol = 0.2;  
alphaSig.TimeTol = 0.8;
```

Compare the results again. Access the results from the comparison and check the `Status` property for each signal.

```
tolDiffResult = Simulink.sdi.compareRuns(runIDTs1, runIDTs2);  
qResult2 = getResultByIndex(tolDiffResult, 1);  
alphaResult2 = getResultByIndex(tolDiffResult, 2);
```

```
qResult2.Status  
ans =  
    ComparisonSignalStatus enumeration  
    WithinTolerance
```

```
alphaResult2.Status  
ans =  
    ComparisonSignalStatus enumeration
```

WithinTolerance

Configure Comparisons to Check Metadata

You can use the `Simulink.sdi.compareRuns` function to compare signal data and metadata, including data type and start and stop times. A single comparison may check for mismatches in one or more pieces of metadata. When you check for mismatches in signal metadata, the `Summary` property of the `Simulink.sdi.DiffRunResult` object may differ from a basic comparison because the `Status` property for a `Simulink.sdi.DiffSignalResult` object can indicate the metadata mismatch. You can configure comparisons using the `Simulink.sdi.compareRuns` function for imported data and for data logged from a simulation.

This example configures a comparison of runs created from workspace data three ways to show how the `Summary` of the `DiffSignalResult` object can provide specific information about signal mismatches.

Create Workspace Data

The `Simulink.sdi.compareRuns` function compares time series data. Create data for a sine wave to use as the baseline signal, using the `timeseries` format. Give the `timeseries` the name `Wave Data`.

```
time = 0:0.1:20;
sig1vals = sin(2*pi/5*time);
sig1_ts = timeseries(sig1vals,time);
sig1_ts.Name = 'Wave Data';
```

Create a second sine wave to compare against the baseline signal. Use a slightly different time vector and attenuate the signal so the two signals are not identical. Cast the signal data to the `single` data type. Also name this `timeseries` object `Wave Data`. The Simulation Data Inspector comparison algorithm will align these signals for comparison using the name.

```
time2 = 0:0.1:22;
sig2vals = single(0.98*sin(2*pi/5*time2));
sig2_ts = timeseries(sig2vals,time2);
sig2_ts.Name = 'Wave Data';
```

Create and Compare Runs in the Simulation Data Inspector

The `Simulink.sdi.compareRuns` function compares data contained in `Simulink.sdi.Run` objects. Use the `Simulink.sdi.createRun` function to create runs in the Simulation Data Inspector for the data. The `Simulink.sdi.createRun` function returns the run ID for each created run.

```
runID1 = Simulink.sdi.createRun('Baseline Run','vars',sig1_ts);
runID2 = Simulink.sdi.createRun('Compare to Run','vars',sig2_ts);
```

You can use the `Simulink.sdi.compareRuns` function to compare the runs. The comparison algorithm converts the signal data to the `double` data type and synchronizes the signal data before computing the difference signal.

```
basic_DRR = Simulink.sdi.compareRuns(runID1,runID2);
```

Check the `Summary` property of the returned `Simulink.sdi.DiffRunResult` object to see the result of the comparison.

```
basic_DRR.Summary  
  
ans = struct with fields:  
    OutOfTolerance: 1  
    WithinTolerance: 0  
    Unaligned: 0  
    UnitsMismatch: 0  
    Empty: 0  
    Canceled: 0  
    EmptySynced: 0  
    DataTypeMismatch: 0  
    TimeMismatch: 0  
    StartStopMismatch: 0  
    Unsupported: 0
```

The difference between the signals is out of tolerance.

Compare Runs and Check for Data Type Match

Depending on your system requirements, you may want the data types for signals you compare to match. You can use the `Simulink.sdi.compareRuns` function to configure the comparison algorithm to check for and report data type mismatches.

```
dataType_DRR = Simulink.sdi.compareRuns(runID1,runID2,'DataType','MustMatch');  
dataType_DRR.Summary
```

```
ans = struct with fields:  
    OutOfTolerance: 0  
    WithinTolerance: 0  
    Unaligned: 0  
    UnitsMismatch: 0  
    Empty: 0  
    Canceled: 0  
    EmptySynced: 0  
    DataTypeMismatch: 1  
    TimeMismatch: 0  
    StartStopMismatch: 0  
    Unsupported: 0
```

The result of the signal comparison is now `DataTypeMismatch` because the data for the baseline signal is double data type, while the data for the signal compared to the baseline is single data type.

Compare Runs and Check for Start and Stop Time Match

You can use the `Simulink.sdi.compareRuns` function to configure the comparison algorithm to check whether the aligned signals have the same start and stop times.

```
startStop_DRR = Simulink.sdi.compareRuns(runID1,runID2,'StartStop','MustMatch');  
startStop_DRR.Summary
```

```
ans = struct with fields:  
    OutOfTolerance: 0
```

```

    WithinTolerance: 0
      Unaligned: 0
    UnitsMismatch: 0
      Empty: 0
    Canceled: 0
    EmptySynced: 0
  DataTypeMismatch: 0
    TimeMismatch: 0
  StartStopMismatch: 1
    Unsupported: 0

```

The signal comparison result is now `StartStopMismatch` because the signals created in the workspace have different stop times.

Compare Runs with Alignment Criteria

When you compare runs using the Simulation Data Inspector, you can specify alignment criteria that determine how signals are paired with each other for comparison. This example compares data from simulations of a model of an aircraft longitudinal control system. The simulations used a square wave input. The first simulation used an input filter time constant of `0.1s` and the second simulation used an input filter time constant of `0.5s`.

First, load the simulation data from the session file that contains the data for this example.

```
Simulink.sdi.load('AircraftExample.mldatx');
```

The session file contains data for four simulations. This example compares data from the first two runs. Access the run IDs for the first two runs loaded from the session file.

```
runIDs = Simulink.sdi.getAllRunIDs;
runIDTs1 = runIDs(end-3);
runIDTs2 = runIDs(end-2);
```

Before running the comparison, define how you want the Simulation Data Inspector to align the signals between the runs. This example aligns signals by their name, then by their block path, and then by their Simulink identifier.

```
alignMethods = [Simulink.sdi.AlignType.SignalName
                Simulink.sdi.AlignType.BlockPath
                Simulink.sdi.AlignType.SID];
```

Compare the simulation data in your two runs, using the alignment criteria you specified. The comparison uses a small time tolerance to account for the effect of differences in the step size used by the solver on the transition of the square wave input.

```
diffResults = Simulink.sdi.compareRuns(runIDTs1,runIDTs2,'align',alignMethods,...
    'timetol',0.005);
```

You can use the `getResultByIndex` function to access the comparison results for the aligned signals in the runs you compared. You can use the `Count` property of the `Simulink.sdi.DiffRunResult` object to set up a `for` loop to check the `Status` property for each `Simulink.sdi.DiffSignalResult` object.

```
numComparisons = diffResults.count;
```

```

for k = 1:numComparisons
    resultAtIdx = getResultByIndex(diffResults,k);

    sigID1 = resultAtIdx.signalID1;
    sigID2 = resultAtIdx.signalID2;

    sig1 = Simulink.sdi.getSignal(sigID1);
    sig2 = Simulink.sdi.getSignal(sigID2);

    displayStr = 'Signals %s and %s: %s \n';
    fprintf(displayStr,sig1.Name,sig2.Name,resultAtIdx.Status);
end

```

```

Signals q, rad/sec and q, rad/sec: OutOfTolerance
Signals alpha, rad and alpha, rad: OutOfTolerance
Signals Stick and Stick: WithinTolerance

```

Input Arguments

runID1 — Baseline run identifier

integer

Numeric identifier for the baseline run in the comparison, specified as a run ID that corresponds to a run in the Simulation Data Inspector. The Simulation Data Inspector assigns run IDs when runs are created. You can get the run ID for a run by using the ID property of the `Simulink.sdi.Run` object, the `Simulink.sdi.getAllRunIDs` function, or the `Simulink.sdi.getRunIDByIndex` function.

runID2 — Identifier for run to compare

integer

Numeric identifier for the run to compare, specified as a run ID that corresponds to a run in the Simulation Data Inspector. The Simulation Data Inspector assigns run IDs when runs are created. You can get the run ID for a run by using the ID property of the `Simulink.sdi.Run` object, the `Simulink.sdi.getAllRunIDs` function, or the `Simulink.sdi.getRunIDByIndex` function.

Name-Value Pair Arguments

Specify optional comma-separated pairs of `Name, Value` arguments. `Name` is the argument name and `Value` is the corresponding value. `Name` must appear inside quotes. You can specify several name and value pair arguments in any order as `Name1, Value1, ..., NameN, ValueN`.

Example: `'abstol',x,'align',alignOpts`

Align — Signal alignment options

string array | character vector array

Signal alignment options, specified as the comma-separated pair consisting of `'Align'` and a string array or array of character vectors.

Array specifying alignment options to use for pairing signals from the runs being compared. The Simulation Data Inspector aligns signals first by the first element in the array, then by the second element in the array, and so on. For more information, see “Signal Alignment”.

| Value | Aligns By |
|--|--|
| <code>Simulink.sdi.AlignType.BlockPath</code> | Path to the source block for the signal |
| <code>Simulink.sdi.AlignType.SID</code> | Simulink identifier “Simulink Identifiers” |
| <code>Simulink.sdi.AlignType.SignalName</code> | Signal name |
| <code>Simulink.sdi.AlignType.DataSource</code> | Path of the variable in the MATLAB workspace |

Example: `[Simulink.sdi.AlignType.SignalName, Simulink.sdi.AlignType.SID]` specifies signal alignment by name and then by SID.

AbsTol — Absolute tolerance for comparison

0 (default) | scalar

Positive-valued global absolute tolerance used for all signals in the run comparison, specified as the comma-separated pair consisting of 'AbsTol' and a scalar. For more information about how tolerances are used in comparisons, see “Tolerance Specification”.

Example: 0.5

Data Types: double

RelTol — Relative tolerance for comparison

0 (default) | scalar

Positive-valued global relative tolerance used for all signals in the run comparison, specified as the comma-separated pair consisting of 'RelTol' and a scalar. The relative tolerance is expressed as a fractional multiplier. For example, 0.1 specifies a 10 percent tolerance. For more information about how the relative tolerance is applied in the Simulation Data Inspector, see “Tolerance Specification”.

Example: 0.1

Data Types: double

TimeTol — Time tolerance for comparison

0 (default) | scalar

Positive-valued global time tolerance used for all signals in the run comparison, specified as the comma-separated pair consisting of 'TimeTol' and a scalar. Specify the time tolerance in units of seconds. For more information about tolerances in the Simulation Data Inspector, see “Tolerance Specification”.

Example: 0.2

Data Types: double

DataType — Comparison sensitivity to signal data types

'MustMatch'

Specify the name-value pair 'DataType', 'MustMatch' when you want the comparison to be sensitive to data type mismatches in compared signals. When you specify this name-value pair, the algorithm compares the data types for aligned signals before synchronizing and comparing the signal data.

The `Simulink.sdi.compareRuns` function does not compare the data types of aligned signals unless you specify this name-value pair. The comparison algorithm can compare signals with different data types.

When signal data types do not match, the `Status` property of the `Simulink.sdi.DiffSignalResult` object for the result is set to `DataTypeMismatch`.

When you specify that data types must match and configure the comparison to stop on the first mismatch, a data type mismatch stops the comparison. A stopped comparison may not compute results for all signals.

Time — Comparison sensitivity to signal time vectors

'MustMatch'

Specify the name-value pair 'Time', 'MustMatch' when you want the comparison to be sensitive to mismatches in the time vectors of compared signals. When you specify this name-value pair, the algorithm compares the time vectors of aligned signals before synchronizing and comparing the signal data.

Comparisons are not sensitive to differences in signal time vectors unless you specify this name-value pair. For comparisons that are not sensitive to differences in the time vectors, the comparison algorithm synchronizes the signals prior to the comparison. For more information about how synchronization works, see “How the Simulation Data Inspector Compares Data”.

When the time vectors for signals do not match, the `Status` property of the `Simulink.sdi.DiffSignalResult` object for the result is set to `TimeMismatch`.

When you specify that time vectors must match and configure the comparison to stop on the first mismatch, a time vector mismatch stops the comparison. A stopped comparison may not compute results for all signals.

StartStop — Comparison sensitivity to signal start and stop times

'MustMatch'

Specify the name-value pair 'StartStop', 'MustMatch' when you want the comparison to be sensitive to mismatches in signal start and stop times. When you specify this name-value pair, the algorithm compares the start and stop times for aligned signals before synchronizing and comparing the signal data.

When the start times and stop times do not match, the `Status` property of the `Simulink.sdi.DiffSignalResult` object for the result is set to `StartStopMismatch`.

When you specify that start and stop times must match and configure the comparison to stop on the first mismatch, a start or stop time mismatch stops the comparison. A stopped comparison may not compute results for all signals.

StopOnFirstMismatch — Whether comparison stops on first detected mismatch

'Metadata' | 'Any'

Whether the comparison stops without comparing remaining signals on the first detected mismatch, specified as the comma-separated pair consisting of 'StopOnFirstMismatch' and 'Metadata' or 'Any'. A stopped comparison may not compute results for all signals, and can return a mismatched result more quickly.

- **Metadata** — A mismatch in metadata for aligned signals causes the comparison to stop. Metadata comparisons happen before comparing signal data.

The Simulation Data Inspector always aligns signals and compares signal units. When you configure the comparison to stop on the first mismatch, an unaligned signal or mismatched units

always causes the comparison to stop. You can specify additional name-value pairs to configure the comparison to check and stop on the first mismatch for additional metadata, such as signal data type, start and stop times, and time vectors.

- Any — A mismatch in metadata or signal data for aligned signals causes the comparison to stop.

ExpandChannels — Whether to compute comparison results for each channel in multidimensional signals

true or 1 (default) | false or 0

Whether to compute comparison results for each channel in multidimensional signals, specified as the comma-separated pair consisting of 'ExpandChannels' and a logical true (1) or false (0).

- true or 1 — Comparison expands multidimensional signals represented as a single signal with nonscalar sample values to a set of signals with scalar sample values and computes a comparison result for each of these signals.

The representation of the multidimensional signal in the Simulation Data Inspector as a single signal with nonscalar sample values does not change.

- false or 0 — Comparison does not compute results for multidimensional signals represented as a single signal with nonscalar sample values.

Output Arguments

diffResult — Comparison results

Simulink.sdi.DiffRunResult

Comparison results, returned as a Simulink.sdi.DiffRunResult object.

Limitations

The Simulation Data Inspector does not support comparing:

- Signals of data types int64 or uint64.
- Variable-size signals.

See Also

Simulink.sdi.compareSignals | Simulink.sdi.getRunIDByIndex |
 Simulink.sdi.getRunCount | Simulink.sdi.DiffRunResult | getResultByIndex |
 Simulink.sdi.DiffSignalResult

Topics

“Inspect and Compare Data Programmatically”

“Compare Simulation Data”

“How the Simulation Data Inspector Compares Data”

Introduced in R2011b

Simulink.sdi.compareSignals

Package: Simulink.sdi

Compare data in two Simulink.sdi.Signal objects

Syntax

```
diff = Simulink.sdi.compareSignals(sigID1,sigID2)
```

Description

`diff = Simulink.sdi.compareSignals(sigID1,sigID2)` compares the signals that correspond to the signal IDs `sigID1` and `sigID2` and returns the results in a `Simulink.sdi.DiffSignalResult` object. For more information on how the comparison results are computed, see “How the Simulation Data Inspector Compares Data”.

Examples

Compare Two Signals in the Same Run

You can use the Simulation Data Inspector programmatic interface to compare signals within a single run. This example compares the input and output signals of an aircraft longitudinal controller.

First, load the session that contains the data.

```
Simulink.sdi.load('AircraftExample.mldatx');
```

Use the `Simulink.sdi.Run.getLatest` function to access the latest run in the data.

```
aircraftRun = Simulink.sdi.Run.getLatest;
```

Then, you can use the `Simulink.sdi.getSignalsByName` function to access the `Stick` signal, which represents the input to the controller, and the `alpha, rad` signal that represents the output.

```
stick = getSignalsByName(aircraftRun,'Stick');
alpha = getSignalsByName(aircraftRun,'alpha, rad');
```

Before you compare the signals, you can specify a tolerance value to use for the comparison. Comparisons use tolerance values specified for the baseline signal in the comparison, so set an absolute tolerance value of `0.1` on the `Stick` signal.

```
stick.AbsTol = 0.1;
```

Now, compare the signals using the `Simulink.sdi.compareSignals` function. The `Stick` signal is the baseline, and the `alpha, rad` signal is the signal to compare against the baseline.

```
comparisonResults = Simulink.sdi.compareSignals(stick.ID,alpha.ID);
match = comparisonResults.Status
```

```
match =
    ComparisonSignalStatus enumeration
```

```
OutOfTolerance
```

The comparison result is out of tolerance. You can use the `Simulink.sdi.view` function to open the Simulation Data Inspector to view and analyze the comparison results.

Compare Signals from Different Runs

This example shows how to compare signals from different simulation runs using the Simulation Data Inspector's `Simulink.sdi.compareSignals` function. When you only have one signal of interest to compare, using a signal comparison returns the `Simulink.sdi.diffSignalResult` object with the comparison data directly.

Generate Simulation Data

Use the `slexAircraftExample` model to generate simulation runs. Between the runs, change the time constant of the input filter.

```
% Load example model
load_system('slexAircraftExample')

% Mark the alpha, rad signal for streaming
Simulink.sdi.markSignalForStreaming('slexAircraftExample/Aircraft Dynamics Model',4,'on')

% Simulate system
out_1 = sim('slexAircraftExample');

% Change input filter time constant
modelWorkspace = get_param('slexAircraftExample','modelworkspace');
assignin(modelWorkspace,'Ts',0.2)

% Simulate again
out_2 = sim('slexAircraftExample');
```

Get Signal IDs for the Signal Comparison

Create run objects using the run IDs, and then use `getSignalIDByIndex` to get the signal IDs to pass to `Simulink.sdi.compareSignals`.

```
% Get run data
runIDs = Simulink.sdi.getAllRunIDs;

runID1 = runIDs(end-1);
runID2 = runIDs(end);

run1 = Simulink.sdi.getRun(runID1);
run2 = Simulink.sdi.getRun(runID2);

sigID1 = getSignalIDByIndex(run1,1);
sigID2 = getSignalIDByIndex(run2,1);
```

Compare Signals

Compare the signals, and open the Simulation Data Inspector to view the results.

```
diffResult = Simulink.sdi.compareSignals(sigID1,sigID2);  
Simulink.sdi.view
```

Input Arguments

sigID1 — Signal ID of baseline signal

scalar

Signal ID for the baseline signal, specified as an integer. The Simulation Data Inspector assigns a signal ID to each signal when a run is created. You can get the signal ID for a signal using one of these functions:

- `getAllSignalIDs`
- `getSignalIDByIndex`
- `getSignalIDsByName`
- `Simulink.sdi.createRun`

sigID2 — Signal ID of signal to compare

scalar

Signal ID for the signal to compare, specified as an integer. The Simulation Data Inspector assigns a signal ID to each signal when a run is created. You can get the signal ID for a signal using one of these functions:

- `getAllSignalIDs`
- `getSignalIDByIndex`
- `getSignalIDsByName`
- `Simulink.sdi.createRun`

Output Arguments

diff — Signal comparison results

`Simulink.sdi.diffSignalResult` | array of `Simulink.sdi.diffSignalResult` objects

Signal comparison results, returned as a `Simulink.sdi.DiffSignalResult` object. Complex signal comparison results are returned as an array of two `DiffSignalResult` objects. One `DiffSignalResult` object contains the real data and the other contains the imaginary data. Check the `Name` property of the `DiffSignalResult` object to determine whether it contains real or imaginary data.

Limitations

The Simulation Data Inspector does not support comparing:

- Signals of data types `int64` or `uint64`.
- Variable-size signals.

See Also

Objects

`Simulink.sdi.DiffSignalResult` | `Simulink.sdi.Run`

Functions

`Simulink.sdi.compareRuns`

Tools

Simulation Data Inspector

Topics

“Inspect and Compare Data Programmatically”

“Compare Simulation Data”

“How the Simulation Data Inspector Compares Data”

Introduced in R2011b

Simulink.sdi.copyRun

Copy a Simulation Data Inspector run

Syntax

```
newRunID = Simulink.sdi.copyRun(runID)
[newRunID,runIndex] = Simulink.sdi.copyRun(runID)
[newRunID,runIndex,signalIDs] = Simulink.sdi.copyRun(runID)
```

Description

`newRunID = Simulink.sdi.copyRun(runID)` copies the run corresponding to `runID` and returns the run ID for the new run. The new run includes all the simulation data and metadata from the original run. You can modify the copy of the run by adding or deleting signals and metadata while still retaining the original run.

`[newRunID,runIndex] = Simulink.sdi.copyRun(runID)` copies the run corresponding to `runID` and returns the run ID and index in the Simulation Data Inspector repository for the new run. The new run includes all the simulation data and metadata from the original run.

`[newRunID,runIndex,signalIDs] = Simulink.sdi.copyRun(runID)` copies the run corresponding to `runID` and returns the signal IDs for the signals in the new run along with its run ID and index in the Simulation Data Inspector repository. The new run includes all the simulation data and metadata from the original run.

Examples

Compare a Subset of Signals

This example shows how to use `Simulink.sdi.copyRun` and `Simulink.sdi.deleteSignal` to create a copy of a run that contains a subset of the signals from the original run. You can use the copy to analyze and run comparisons on a subset of signals while still holding onto the original run that has all of the signals. For example, the model `sldemo_fuelsys` is configured to log ten signals. To compare the system's responses to different types of failures, you don't need to run the comparison on all of the logged signals. Deleting signals that do not represent the system's response before running the comparison saves processing time and simplifies the view of the results.

Create Runs

Load the model `sldemo_fuelsys` and run simulations to create runs in the Simulation Data Inspector. The first run simulates a failure of the throttle angle sensor, and the second run simulates a failure of the exhaust gas oxygen sensor.

```
load_system('sldemo_fuelsys')
modelWorkspace = get_param('sldemo_fuelsys','modelworkspace');
modelWorkspace.assignin('throttle_sw',0)
modelWorkspace.assignin('ego_sw',1)
sim('sldemo_fuelsys')
```



```
modelWorkspace.assignin('throttle_sw',1)
modelWorkspace.assignin('ego_sw',0)
sim('sldemo_fuelsys')
```

Copy the Run

Use the Simulation Data Inspector's programmatic interface to get `Simulink.sdi.Run` objects for the simulations, and then create copies of the runs.

```
% Get runs
runIDs = Simulink.sdi.getAllRunIDs;

runID1 = runIDs(end-1);
runID2 = runIDs(end);

run1 = Simulink.sdi.getRun(runID1);
run2 = Simulink.sdi.getRun(runID2);

% Create a copy of each run, truncRun
[truncRun1,runIndex1,signalIDs1] = Simulink.sdi.copyRun(runID1);
[truncRun2,runIndex2,signalIDs2] = Simulink.sdi.copyRun(runID2);
```

Delete Signals in Run Copy

The `sldemo_fuelsys` model is configured to log the values of the fault switches along with several signals representing the system's response. When you compare the system's response when a throttle angle sensor fails to its response when an exhaust gas oxygen sensor fails, comparing the fault switch states does not provide new information. Therefore, delete the switch signals before running the comparison to eliminate unnecessary computations.

```
Simulink.sdi.deleteSignal(signalIDs1(1))
Simulink.sdi.deleteSignal(signalIDs1(3))
Simulink.sdi.deleteSignal(signalIDs1(5))
Simulink.sdi.deleteSignal(signalIDs1(8))

Simulink.sdi.deleteSignal(signalIDs2(1))
Simulink.sdi.deleteSignal(signalIDs2(3))
Simulink.sdi.deleteSignal(signalIDs2(5))
Simulink.sdi.deleteSignal(signalIDs2(8))
```

Compare Truncated Runs

You can use the truncated runs you created with `Simulink.sdi.copyRun` and `Simulink.sdi.deleteSignal` to perform a comparison of the system's response to different types of failures. Then, open the Simulation Data Inspector to view the comparison results.

```
truncRunDiff = Simulink.sdi.compareRuns(truncRun1,truncRun2);

Simulink.sdi.view
```

Input Arguments

runID — Numeric run identifier

scalar

Run ID for the run you want to copy. The Simulation Data Inspector assigns run IDs when it creates runs. You can get the run ID for your run using `Simulink.sdi.getAllRunIDs` or `Simulink.sdi.getRunIDByIndex`.

Output Arguments

newRunID — Run ID for the copy

scalar

Run ID for the copy of the run.

runIndex — Run index for the copy

scalar

Index of the copy in the Simulation Data Inspector repository.

signalIDs — Numeric identifiers for the signals in the copy

matrix

Matrix containing the signal IDs for the copies of signals created in the copy of the run.

See Also

`Simulink.sdi.deleteSignal` | `Simulink.sdi.deleteRun` | `Simulink.sdi.createRun`

Topics

“Inspect and Compare Data Programmatically”

Introduced in R2011b

Simulink.sdi.copyRunViewSettings

Copy line style and color for signals from one run to another

Syntax

```
sigIDs = Simulink.sdi.copyRunViewSettings(run1,run2,plot)
```

Description

`sigIDs = Simulink.sdi.copyRunViewSettings(run1,run2,plot)` copies the line style and color specifications from `runID1` to `runID2` for matched signals. You can specify `run1` and `run2` with their run ID or as a `Simulink.sdi.Run` object. If `plot` is specified as `true`, `Simulink.sdi.copyRunViewSettings` also changes signal parameters in both runs so that aligned signals that are plotted come from the `run2`. The function returns an array of signal identifiers for the signals that the Simulation Data Inspector aligned between the two runs. To learn more about how the Simulation Data Inspector aligns signals between runs, see “How the Simulation Data Inspector Compares Data”.

Examples

Copy View Settings to a Run

This example shows how to copy view settings from one run to another and how to create figures using the `Simulink.sdi.CustomSnapshot` object.

Simulate Your Model and Get a Run Object

Configure the `vdp` model to save output data, and run a simulation to create data.

```
load_system('vdp')
set_param('vdp','SaveFormat','Dataset','SaveOutput','on')
set_param('vdp/Mu','Gain','1');
sim('vdp');
```

Use the Simulation Data Inspector programmatic interface to access the run data.

```
runIndex = Simulink.sdi.getRunCount;
runID = Simulink.sdi.getRunIDByIndex(runIndex);
vdpRun = Simulink.sdi.getRun(runID);
```

Modify Signal View Settings

Use the `Simulink.sdi.Run` object to access signals in the run. Then, modify the signal view settings. This example specifies the line color and style for each signal. The view settings for the run comprise the view settings for each signal and view settings specified for the plot area.

```
sig1 = vdpRun.getSignalByIndex(1);
sig2 = vdpRun.getSignalByIndex(2);

sig1.LineColor = [0 0 1];
```

```
sig1.LineDashed = '-.-';
sig2.LineColor = [1 0 0];
sig2.LineDashed = ':';
```

Capture a Snapshot from the Simulation Data Inspector

Create a `Simulink.sdi.CustomSnapshot` object and use the `Simulink.sdi.snapshot` function to programmatically capture a snapshot of the contents of the Simulation Data Inspector.

```
snap = Simulink.sdi.CustomSnapshot;
```

You can use properties of the `Simulink.sdi.CustomSnapshot` object to configure the plot settings, like the subplot layout and axis limits, and to plot signals. When you use a `Simulink.sdi.CustomSnapshot` object to create your figure, these plot settings do not affect the Simulation Data Inspector.

```
snap.Rows = 2;
snap.YRange = {[ -2.25 2.25], [ -3 3]};
snap.plotOnSubPlot(1,1,sig1,true)
snap.plotOnSubPlot(2,1,sig2,true)
```

Use `Simulink.sdi.snapshot` to generate the figure you specified in the properties of the `Simulink.sdi.CustomSnapshot` object.

```
fig = Simulink.sdi.snapshot("from", "custom", "to", "figure", "settings", snap);
```

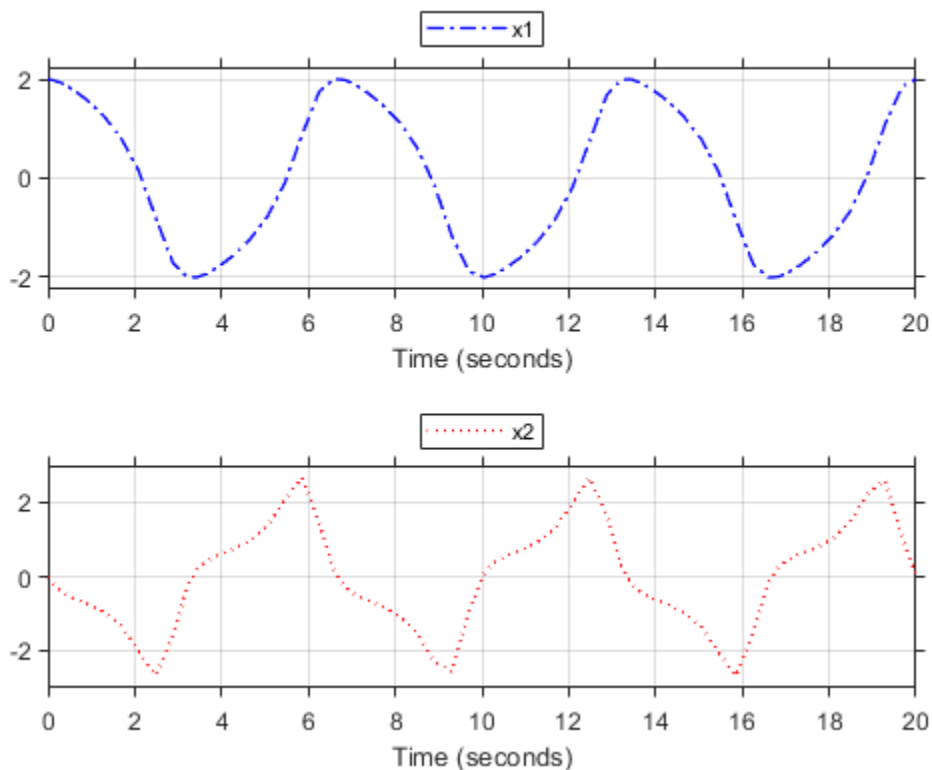

Copy the View Settings to a New Simulation Run

Simulate the model again, with a different Mu value. Use the Simulation Data Inspector programmatic interface to access the simulation data.

```
set_param('vdp/Mu', 'Gain', '5')
sim('vdp');

runIndex2 = Simulink.sdi.getRunCount;
runID2 = Simulink.sdi.getRunIDByIndex(runIndex2);
run2 = Simulink.sdi.getRun(runID2);
```

To create a plot of the new output data that looks like the one you created in the previous step, you can copy the view settings to the run in a single line of code using `Simulink.sdi.copyRunViewSettings`. The `Simulink.sdi.copyRunViewSettings` function does not automatically update plot settings in `Simulink.sdi.CustomSnapshot` objects, so specify the plot input as `false`.

```
sigIDs = Simulink.sdi.copyRunViewSettings(runID, runID2, false);
```

Capture a Snapshot of the New Simulation Run

Use the `Simulink.sdi.CustomSnapshot` object to capture a snapshot of the new simulation run. First, clear the signals from the subplots. Then, plot the signals from the new run and capture another snapshot.

```
snap.clearSignals
snap.YRange = {[ -2.25 2.25], [-8 8]};
snap.plotOnSubPlot(1,1,sigIDs(1),true)
snap.plotOnSubPlot(2,1,sigIDs(2),true)

fig = snap.snapshot("to", "figure");
```

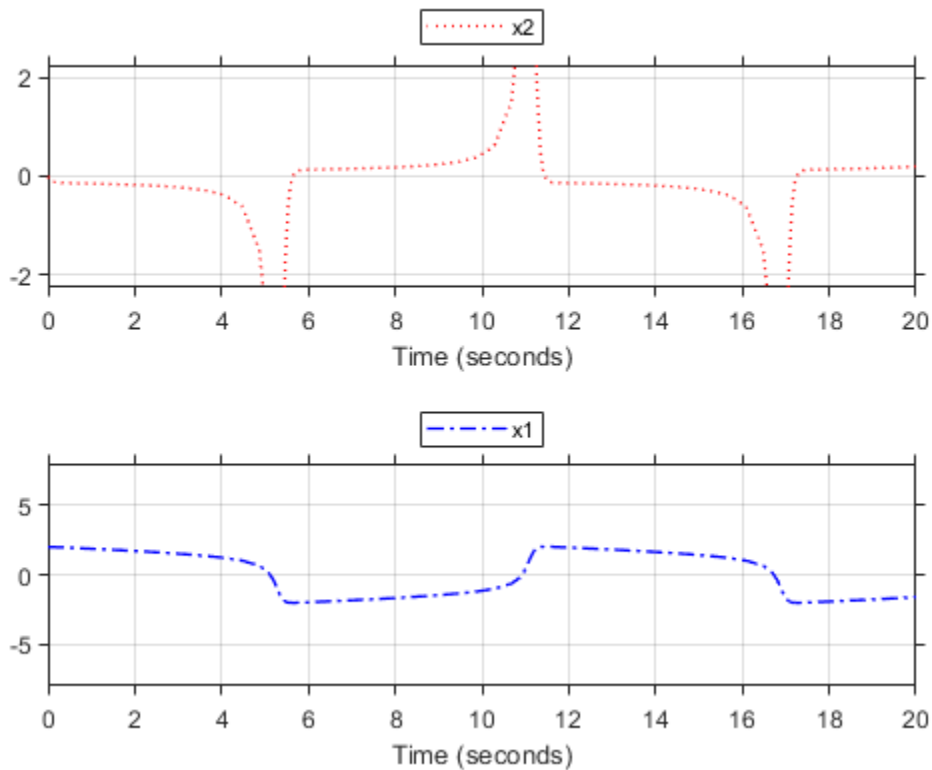

Input Arguments

run1 — Simulation Data Inspector run ID for source run

scalar | 'Simulink.sdi.Run' object

Run with the view settings you want to copy specified with its run ID or `Simulink.sdi.Run` object. The Simulation Data Inspector assigns run IDs when it creates runs. You can get the run ID for your run using `Simulink.sdi.getAllRunIDs` or `Simulink.sdi.getRunIDByIndex`.

run2 — Simulation Data Inspector run ID for destination run

scalar | 'Simulink.sdi.Run' object

Run you want to copy the view settings to, specified with its run ID or `Simulink.sdi.Run` object. The Simulation Data Inspector assigns run IDs when it creates runs. You can get the run ID for your run using `Simulink.sdi.getAllRunIDs` or `Simulink.sdi.getRunIDByIndex`.

plot — Specify whether to update plotted signals

true | false

Specifies whether the Simulation Data Inspector changes the plot settings in the runs corresponding to `run1` and `run2`.

- When `plot` is `true`, the Simulation Data Inspector modifies the signal parameters so that the aligned signals that are plotted come from `run2`.

- When `plot` is `false`, the Simulation Data Inspector does not change which signals are plotted.

Data Types: `logical`

Output Arguments

sigIDs — Signal IDs for aligned signals

matrix

Matrix containing the signal IDs for signals in `run2` that aligned with signals in `run1` and had view settings modified.

See Also

`Simulink.sdi.copyRun` | `Simulink.sdi.Signal` | `Simulink.sdi.Run` |
`Simulink.sdi.setMarkersOn` | `Simulink.sdi.view`

Topics

“Inspect and Compare Data Programmatically”

“Create Plots Using the Simulation Data Inspector”

Introduced in R2016a

Simulink.sdi.createRun

Import data into the Simulation Data Inspector

Syntax

```
runID = Simulink.sdi.createRun
runID = Simulink.sdi.createRun(runName)
runID = Simulink.sdi.createRun(var)
runID = Simulink.sdi.createRun(runName, 'vars', var, var2, ..., varn)
runID = Simulink.sdi.createRun(runName, 'namevalue', sourceNames, sigValues)
runID = Simulink.sdi.createRun(runName, 'file', filename)
runID = Simulink.sdi.createRun(runName, 'file', filename, Name=Value)
[runID, runIndex] = Simulink.sdi.createRun( ___ )
[runID, runIndex, signalIDs] = Simulink.sdi.createRun( ___ )
```

Description

`runID = Simulink.sdi.createRun` creates an empty, unnamed run in the Simulation Data Inspector and returns the run ID.

You can use `Simulink.sdi.getRun` to access the `Simulink.sdi.Run` object that corresponds to the run. Set the properties on the Run object to add metadata to the run. Use the `Simulink.sdi.addToRun` function or the `add` function to add data to the run.

`runID = Simulink.sdi.createRun(runName)` creates an empty run named `runName`.

`runID = Simulink.sdi.createRun(var)` creates a run that contains the data in the scalar workspace variable `var`. The run is named according to the input variable. For example, when `var` is a `timeseries` object, the run name comes from the `Name` property of the `timeseries` object.

`runID = Simulink.sdi.createRun(runName, 'vars', var, var2, ..., varn)` creates a run named `runName` that contains data from one or more variables in the base workspace. Use this syntax to import data from multiple variables or from a variable that represents an array of objects, such as an array of `Simulink.SimulationOutput` or `Simulink.SimulationData.Dataset` objects.

`runID = Simulink.sdi.createRun(runName, 'namevalue', sourceNames, sigValues)` creates a run that contains the data in the cell array `sigValues`. The cell array `sourceNames` specifies the source names used to set the `RootSource`, `TimeSource`, and `DataSource` properties for the signals imported from the `sigValues` cell array.

`runID = Simulink.sdi.createRun(runName, 'file', filename)` creates a run that contains the data in the file specified by `filename`. You can use a built-in file reader to import data from a MAT file, CSV file, Microsoft Excel file, or an MDF file.

When you need to import data from a file that the built-in readers do not support, you can write your own reader using the `io.reader` class.

`runID = Simulink.sdi.createRun(runName, 'file', filename, Name=Value)` imports data into a run in the Simulation Data Inspector from a file according to options specified using one or

more name-value arguments. For example, `sheets=["sheet1" "sheet2"]` specifies which sheets to import data from when importing data from an Excel file.

`[runID,runIndex] = Simulink.sdi.createRun(___)` returns the run ID and run index for the run created in the Simulation Data Inspector.

`[runID,runIndex,signalIDs] = Simulink.sdi.createRun(___)` returns the run ID, the index of the run in the Simulation Data Inspector, and the signal IDs for the signals in the run.

Examples

Create a Run in the Simulation Data Inspector

You can programmatically import data into the Simulation Data Inspector by creating a run from data in the base workspace or a file. This example creates data in the workspace and then illustrates several methods of creating a Simulation Data Inspector run containing the data.

Create Data

Create data in the workspace. The Simulation Data Inspector supports time series data in many formats. This example creates data using the `timeseries` and `Simulink.SimulationData.Dataset` formats and saves the data in a MAT-file.

Create a sine signal and a cosine signal. Store the data for each signal in a `timeseries` object with a descriptive name.

```
time = 0:0.2:20;

sine_vals = sin(2*pi/5*time);
sine_ts = timeseries(sine_vals,time);
sine_ts.Name = 'Sine, T=5';

cos_vals = cos(2*pi/8*time);
cos_ts = timeseries(cos_vals,time);
cos_ts.Name = 'Cosine, T=8';
```

You can use the `Dataset` format to group related signal data together in a single object. The `Dataset` format is the default format for logged data and is supported for loading simulation input data. Create a `Dataset` object that contains the sinusoid `timeseries` data.

```
sinusoids_ds = Simulink.SimulationData.Dataset;
sinusoids_ds = addElement(sinusoids_ds,cos_ts);
sinusoids_ds = addElement(sinusoids_ds,sine_ts);
```

Scale each signal by a factor of 2 and create a `Dataset` object to contain the signal data for the results.

```
doubSine = 2*sine_ts;
doubCos = 2*cos_ts;

doubSinusoids_ds = Simulink.SimulationData.Dataset;
doubSinusoids_ds = addElement(doubSinusoids_ds,doubSine);
doubSinusoids_ds = addElement(doubSinusoids_ds,doubCos);
```

Finally, save the `timeseries` data to a MAT-file.

```
save sinusoids.mat sine_ts cos_ts
```

Open the Simulation Data Inspector

To view the runs you create in each section, open the Simulation Data Inspector by entering `Simulink.sdi.view` in the MATLAB™ Command Window.

Create a Run Using a `Simulink.sdi.Run` Object

You can import your data into a run in the Simulation Data Inspector by creating an empty run and then adding data to the run from the workspace or a file. Depending on your task, you can use the `Simulink.sdi.Run.create` function or the `Simulink.sdi.createRun` function to create the empty run. The `Simulink.sdi.Run.create` function returns the `Simulink.sdi.Run` object for the new run, and the `Simulink.sdi.createRun` function returns the run ID for the new run.

This example creates an empty run using the `Simulink.sdi.Run.create` function, gives the run a meaningful name and description, and then adds the sine and cosine timeseries data using the `add` function.

```
sinusoidsRun = Simulink.sdi.Run.create;
sinusoidsRun.Name = 'Sinusoids';
sinusoidsRun.Description = 'Sine and cosine signals of different frequencies';

add(sinusoidsRun, 'vars', sine_ts, cos_ts)
```

This example uses the `Simulink.sdi.createRun` function to create a new run in the Simulation Data Inspector called `My Waves` and then uses the `Simulink.sdi.addToRun` function to add the sine and cosine timeseries data to the run.

```
runID = Simulink.sdi.createRun('My Waves');
signalID = Simulink.sdi.addToRun(runID, 'vars', sine_ts, cos_ts);
```

Create a Run from a Workspace Variable

You can create a run from a single variable in the workspace. After creating the run, you can add additional data, or you can create another run to contain your other data. The variable you use to create the run can be a timeseries object with data that corresponds to only one signal, or it can be a Dataset object that contains several signals.

When you use this syntax to create a run from a single workspace variable, the run takes the same name as the object used to create it.

```
runID = Simulink.sdi.createRun(sine_ts);
```

The `Simulink.sdi.createRun` function returns the run ID for the run it creates. You can use the `Simulink.sdi.getRun` function to access the Run object for the run.

```
sineRun = Simulink.sdi.getRun(runID);
sineRun.Name
```

```
ans =
'Sine, T=5'
```

Create a Run from Multiple Workspace Variables

When your data exists in multiple variables in your workspace, you can use the `Simulink.sdi.createRun` function with the `vars` option to import the data from multiple variables

into a single run in the Simulation Data Inspector. You can also use this syntax to create a run for a single variable that uses a name you specify.

This example creates a run called `My Sinusoids` that contains data for the sine and cosine timeseries objects.

```
runID = Simulink.sdi.createRun('My Sinusoids','vars',sine_ts,cos_ts);
```

Create a Run and Specify Source Names

You can use the `namevalue` option of the `Simulink.sdi.createRun` function to create a run and specify names for the signals in the run. This syntax can be particularly helpful when you import individual leaf signals from hierarchical data.

This example creates a run containing the data for both the `Dataset` objects. Each `Dataset` object contains data for more than one signal, so the imported run data has hierarchy. The name-value syntax in this example specifies a name for the hierarchical node that corresponds to each `Dataset` object.

```
runID = Simulink.sdi.createRun('Waves','namevalue',{'Sinusoids',...
    'BigSinusoids'},{sinusoids_ds,doubSinusoids_ds});
```

Create a Run from Data in a File

You can also use the `Simulink.sdi.createRun` function to import data into the Simulation Data Inspector from a file. Use the `file` option to import the data in the `sinusoids.mat` file.

```
runID = Simulink.sdi.createRun('Wave Data','file','sinusoids.mat');
```

Create a Simulation Data Inspector Run and Access Signal Data

This example shows how to access signal data when you create a run in the Simulation Data Inspector.

Generate Data for Run

For this example, create timeseries data for sine and cosine signals.

```
% Create timeseries workspace data
time = linspace(0, 20, 101);

sine_vals = sin(2*pi/5*time);
sine_ts = timeseries(sine_vals,time);
sine_ts.Name = 'Sine, T=5';

cos_vals = cos(2*pi/8*time);
cos_ts = timeseries(cos_vals,time);
cos_ts.Name = 'Cosine, T=8';
```

Create a Run and Return Signal IDs

You can use the `Simulink.sdi.createRun` syntax with multiple return arguments to get the signal IDs more directly instead of accessing the signal IDs through a `Simulink.sdi.Run` object.

```
[runID,runIndex,sigIDs] = Simulink.sdi.createRun('Sinusoids','vars',...
    sine_ts,cos_ts);
```

```
cosID = sigIDs(2);  
cosSig = Simulink.sdi.getSignal(cosID);
```

Modify Signal Properties and View in the Simulation Data Inspector

You can use the `Simulink.sdi.Signal` object to view and modify signal properties and to plot signals in the Simulation Data Inspector.

```
cosSig.Checked = true;  
cosSig.AbsTol = 0.05;  
Simulink.sdi.view  
cosSig.Name
```

Input Arguments

runName — Name for run

character vector | string

Name for run in the Simulation Data Inspector, specified as a character vector or string.

Example: 'Baseline Simulation'

var — Workspace variable

workspace variable

Variable in the base workspace that contains the data you want to import into a run in the Simulation Data Inspector. The Simulation Data Inspector supports time-based data in which sample values are associated with sample times. The Simulation Data Inspector supports all loading and logging data formats, including `timeseries` and `Simulink.SimulationData.Dataset`.

Example: `myData`

sourceNames — Source names for imported data

cell array of character vectors

Source names for imported data, specified as a cell array of character vectors. The source name is used to set the `RootSource`, `TimeSource`, and `DataSource` properties of the `Simulink.sdi.Signal` objects created from the data specified by the `sigValues` input.

Provide a `sourceNames` input when you specify 'namevalue' for the second argument.

Example: `{'sig1','sig2'}`

sigValues — Data to import

cell array of workspace variables

Data to import, specified as a cell array of workspace variables.

Provide a `sigValues` input when you specify 'namevalue' for the second argument.

Example: `{var1,var2}`

filename — Name of file with data to import

character vector

Name of file with data to import, specified as a character vector. Provide a `filename` input when you specify 'file' for the second argument.

You can create a run from these types of files using file readers built into the Simulation Data Inspector:

- MAT-file
- CSV file
- Microsoft Excel file that contains data formatted according to “Microsoft Excel Import, Export, and Logging Format”.
- MDF file with one of these extensions:
 - `.mdf`
 - `.mf4`
 - `.mf3`
 - `.data`
 - `.dat`

When you need to import data from a file that the built-in readers do not support, you can write your own reader using the `io.reader` class. You can also write a custom reader to use instead of the built-in reader for any file extension. For an example, see “Import Data Using a Custom File Reader”.

Example: `'simulation.mat'`

Name-Value Pair Arguments

Specify optional pairs of arguments as `Name1=Value1, ..., NameN=ValueN`, where `Name` is the argument name and `Value` is the corresponding value. Name-value arguments must appear after other arguments, but the order of the pairs does not matter.

Example: `sheets=["sheet1" "sheet2"]`

reader — File reader to use to import data

string | character vector

File reader to use to import data, specified as a string or character vector.

The Simulation Data Inspector prioritizes using a registered custom reader when one is available for the file. When you do not specify a reader, the Simulation Data Inspector uses the first custom reader registered for the file. If no custom readers are registered, the data is imported using the built-in reader.

Specify the reader input when:

- You want to use the built-in reader to import data for a file that is also supported by a custom reader.
- Multiple registered custom readers support the file.

To determine which readers are available to import your file, use the `io.reader.getSupportedReadersForFile` function.

Example: `"MyExcelReader"`

Example: `"built-in"`

sheets — Sheets in Excel file from which to import data

string array | cell array of character vectors

Sheets in Excel file from which to import data, specified as a string array or a cell array of character vectors. By default, the Simulation Data Inspector imports data from all sheets. Use the `sheets` name-value argument when you do not want to import data from all sheets in the Excel file.

When the data in the file does not include simulation numbers and source information, the data on each sheet is imported into a separate run. For more information about formatting data to import from an Excel file, see “Microsoft Excel Import, Export, and Logging Format”.

Example: ["sheet1" "sheet2"]

model — Model with definitions of user-defined data types

string | character vector

Model with definitions of user-defined data types, specified as a string or character vector.

When you load data from an Excel file that defines signal data types using user-defined data types such as enumerations, buses, or aliases, the Simulation Data Inspector needs access to the type definition to import the data. You can provide access to the type definitions by loading the associated object into the MATLAB workspace, or you can specify the `model` name-value argument to use type definitions saved in the model workspace or a data dictionary.

For more information on formatting data to import from an Excel file, see “Microsoft Excel Import, Export, and Logging Format”.

Example: "myModel.slx"

Output Arguments**runID — Run identifier**

scalar

Run identifier for the new run, returned as a scalar.

runIndex — Run index

scalar

Index of the new run in the Simulation Data Inspector, returned as a scalar.

signalIDs — Signal IDs for signals in run

vector

Signal IDs for the signals in the run, returned as a vector.

See Also**Objects**

Simulink.sdi.Run

Functions

Simulink.sdi.getRun | Simulink.sdi.addToRun |
Simulink.sdi.createRunOrAddToStreamedRun | io.reader.getRegisteredFileReaders |
io.reader.getSupportedReadersForFile | Simulink.sdi.Run.create

Classes

io.reader

Topics

“Inspect and Compare Data Programmatically”

“Microsoft Excel Import, Export, and Logging Format”

“View Data in the Simulation Data Inspector”

“Import Data Using a Custom File Reader”

Introduced in R2011b

Simulink.sdi.createRunOrAddToStreamedRun

Package: Simulink.sdi

Create a single run for all simulation outputs

Syntax

```
runID = Simulink.sdi.createRunOrAddToStreamedRun mdl, runName, varSources, varValues)
```

Description

`runID = Simulink.sdi.createRunOrAddToStreamedRun mdl, runName, varSources, varValues)` creates a run with the data `varValues` if no run exists in the Simulation Data Inspector repository for the model `mdl`. If one or more runs for the model `mdl` exist in the Simulation Data Inspector repository, the function adds `varValues` to the most recent run associated with `mdl`. The run is named according to `runName`, and the sources for the data in `varValues` are named according to `varSources`.

Examples

Add Signals to a Run

This example shows how to use `Simulink.sdi.createRunOrAddToStreamedRun` to add data to an existing run for a model. In this example, you add data logged using the `Structure with Time` format to a run that contains logged signal data.

Simulate the Model

Open the `slexAircraftExample` model and mark the output of the Pilot block for logging. The logged signal data uses the `Dataset` format and streams to the Simulation Data Inspector during simulation. The model is configured to log outputs, states, and time as well as signals. Simulate the model and return a single output in the workspace with all the logged data. Use the `Structure with Time` format for logged states and outputs.

```
load_system('slexAircraftExample')

Simulink.sdi.markSignalForStreaming('slexAircraftExample/Pilot',1,1)

out = sim('slexAircraftExample','ReturnWorkspaceOutputs','on',...
         'SaveFormat','StructureWithTime');
```

Add Logged States Data to Run

The Simulation Data Inspector automatically created a run for the logged signal data. Add the logged states and outputs data to the existing run using `Simulink.sdi.createRunOrAddToStreamedRun`.

```
Simulink.sdi.createRunOrAddToStreamedRun('slexAircraftExample','Run 1',...
                                         {'out'},{out});
```

Open the Simulation Data Inspector to View Results

Use the `Simulink.sdi.view` function to open the Simulation Data Inspector and view the results.

Using `Simulink.sdi.createRunOrAddToStreamedRun` avoids redundancy in the data shown in the Simulation Data Inspector. When you use the `Simulink.sdi.createRun` function to import the output and states data, the Simulation Data Inspector creates a second run. When you use the `Simulink.sdi.addToRun` function to add the logged states and output data to the run, the Simulation Data Inspector imports a duplicate of the Pilot block output signal. Using `Simulink.sdi.createRunOrAddToStreamedRun`, you can include all simulation data in a single run without duplicating any signals.

Input Arguments

mdl — Name of model that created simulation data

character vector

Name of the model the simulation data is from, specified as a character vector.

Example: `'my_model'`

runName — Name for the run

character vector

Name for the new or augmented run. If `Simulink.sdi.createRunOrAddToStreamedRun` adds data to an existing run, the run is renamed according to `runName`.

Example: `'Run 1'`

varSources — Names to use for the sources of data

cell array of character vectors

Names for the sources of the data in `varValues`.

Example: `{'sig1','sig2'}`

varValues — Data to add to run

cell array

Cell array of data to incorporate into the run. `Simulink.sdi.createRunOrAddToStreamedRun` supports data in all logging and loading formats, including timeseries and `Simulink.SimulationData.Dataset`.

Example: `{sig1,sig2}`

Output Arguments

runID — Run identifier

scalar

Run identifier for the new or augmented run.

See Also

`Simulink.sdi.addToRun` | `Simulink.sdi.createRun` | `Simulink.sdi.Run` |
`Simulink.sdi.getAllRunIDs` | `Simulink.sdi.getRun` | `Simulink.sdi.getRunCount` |
`Simulink.sdi.isValidRunID` | `Simulink.sdi.view`

Topics

“Inspect and Compare Data Programmatically”
“View Data in the Simulation Data Inspector”

Introduced in R2017a

Simulink.sdi.deleteRun

Package: Simulink.sdi

Delete a run from the Simulation Data Inspector repository

Syntax

```
Simulink.sdi.deleteRun(runID)
```

Description

`Simulink.sdi.deleteRun(runID)` deletes the run corresponding to `runID`. When you delete a run, the indices of all runs following the deleted run change to account for the change in the run count. Deleting a run does not change any run IDs.

Examples

Delete a Run

You can delete a run from the Simulation Data Inspector repository to free up memory space or to declutter your workspace from data you do not need.

```
% Load and simulate sldemo_fuelsys model
load_system('sldemo_fuelsys')
sim('sldemo_fuelsys')

% Get the run ID for the run
runIDs = Simulink.sdi.getAllRunIDs;
runID = runIDs(end);

% Delete the run
Simulink.sdi.deleteRun(runID)
```

Input Arguments

runID — Run identifier

scalar

Run ID for the run you want to delete. You can get the run ID for a run using `Simulink.sdi.getAllRunIDs` or `Simulink.sdi.getRunIDByIndex`.

See Also

`Simulink.sdi.clear` | `Simulink.sdi.copyRun` | `Simulink.sdi.deleteSignal` | `Simulink.sdi.getRunIDByIndex` | `Simulink.sdi.getAllRunIDs` | `Simulink.sdi.setArchiveRunLimit` | `Simulink.sdi.getArchiveRunLimit`

Topics

“Inspect and Compare Data Programmatically”

Introduced in R2011b

Simulink.sdi.deleteSignal

Package: Simulink.sdi

Delete signal in the Simulation Data Inspector

Syntax

```
Simulink.sdi.deleteSignal(sigID)
```

Description

`Simulink.sdi.deleteSignal(sigID)` deletes the specified signal or signals from the Simulation Data Inspector.

Examples

Compare a Subset of Signals

This example shows how to use `Simulink.sdi.copyRun` and `Simulink.sdi.deleteSignal` to create a copy of a run that contains a subset of the signals from the original run. You can use the copy to analyze and run comparisons on a subset of signals while still holding onto the original run that has all of the signals. For example, the model `sldemo_fuelsys` is configured to log ten signals. To compare the system's responses to different types of failures, you don't need to run the comparison on all of the logged signals. Deleting signals that do not represent the system's response before running the comparison saves processing time and simplifies the view of the results.

Create Runs

Load the model `sldemo_fuelsys` and run simulations to create runs in the Simulation Data Inspector. The first run simulates a failure of the throttle angle sensor, and the second run simulates a failure of the exhaust gas oxygen sensor.

```
load_system('sldemo_fuelsys')
modelWorkspace = get_param('sldemo_fuelsys','modelworkspace');
modelWorkspace.assignin('throttle_sw',0)
modelWorkspace.assignin('ego_sw',1)
sim('sldemo_fuelsys')

modelWorkspace.assignin('throttle_sw',1)
modelWorkspace.assignin('ego_sw',0)
sim('sldemo_fuelsys')
```

Copy the Run

Use the Simulation Data Inspector's programmatic interface to get `Simulink.sdi.Run` objects for the simulations, and then create copies of the runs.

```
% Get runs
runIDs = Simulink.sdi.getAllRunIDs;
```

```
runID1 = runIDs(end-1);
runID2 = runIDs(end);

run1 = Simulink.sdi.getRun(runID1);
run2 = Simulink.sdi.getRun(runID2);

% Create a copy of each run, truncRun
[truncRun1,runIndex1,signalIDs1] = Simulink.sdi.copyRun(runID1);
[truncRun2,runIndex2,signalIDs2] = Simulink.sdi.copyRun(runID2);
```

Delete Signals in Run Copy

The `sldemo_fuelsys` model is configured to log the values of the fault switches along with several signals representing the system's response. When you compare the system's response when a throttle angle sensor fails to its response when an exhaust gas oxygen sensor fails, comparing the fault switch states does not provide new information. Therefore, delete the switch signals before running the comparison to eliminate unnecessary computations.

```
Simulink.sdi.deleteSignal(signalIDs1(1))
Simulink.sdi.deleteSignal(signalIDs1(3))
Simulink.sdi.deleteSignal(signalIDs1(5))
Simulink.sdi.deleteSignal(signalIDs1(8))

Simulink.sdi.deleteSignal(signalIDs2(1))
Simulink.sdi.deleteSignal(signalIDs2(3))
Simulink.sdi.deleteSignal(signalIDs2(5))
Simulink.sdi.deleteSignal(signalIDs2(8))
```

Compare Truncated Runs

You can use the truncated runs you created with `Simulink.sdi.copyRun` and `Simulink.sdi.deleteSignal` to perform a comparison of the system's response to different types of failures. Then, open the Simulation Data Inspector to view the comparison results.

```
truncRunDiff = Simulink.sdi.compareRuns(truncRun1,truncRun2);

Simulink.sdi.view
```

Input Arguments

sigID — Signal or signals to delete

scalar | vector

Signal to delete, specified as a scalar signal ID or vector of signal IDs. The Simulation Data Inspector assigns a unique numeric signal ID to each signal when a run is created for logged or imported data.

You can get the signal ID for a signal using one of these functions:

- `getAllSignalIDs`
- `getSignalIDByIndex`
- `getSignalIDsByName`
- `Simulink.sdi.createRun`

See Also

Objects

`Simulink.sdi.Signal` | `Simulink.sdi.Run`

Functions

`Simulink.sdi.copyRun` | `Simulink.sdi.createRun`

Topics

“Configure the Simulation Data Inspector”

“Inspect and Compare Data Programmatically”

Introduced in R2016a

getResultByIndex

Package: Simulink.sdi

Return signal comparison result

Syntax

```
diffSig = getResultByIndex(diffRes,index)
```

Description

`diffSig = getResultByIndex(diffRes,index)` returns the `Simulink.sdi.DiffSignalResult` object `diffSig` at the specified index in the `Simulink.sdi.DiffRunResult` object, `diffRes`.

Examples

Analyze Simulation Data Using Signal Tolerances

You can programmatically specify signal tolerance values to use in comparisons performed using the Simulation Data Inspector. In this example, you compare data collected by simulating a model of an aircraft longitudinal flight control system. Each simulation uses a different value for the input filter time constant and logs the input and output signals. You analyze the effect of the time constant change by comparing results using the Simulation Data Inspector and signal tolerances.

First, load the session file that contains the simulation data.

```
Simulink.sdi.load('AircraftExample.mldatx');
```

The session file contains four runs. In this example, you compare data from the first two runs in the file. Access the `Simulink.sdi.Run` objects for the first two runs loaded from the file.

```
runIDs = Simulink.sdi.getAllRunIDs;
runIDs1 = runIDs(end-3);
runIDs2 = runIDs(end-2);
```

Now, compare the two runs without specifying any tolerances.

```
noTolDiffResult = Simulink.sdi.compareRuns(runIDs1,runIDs2);
```

Use the `getResultByIndex` function to access the comparison results for the `q` and `alpha` signals.

```
qResult = getResultByIndex(noTolDiffResult,1);
alphaResult = getResultByIndex(noTolDiffResult,2);
```

Check the `Status` of each signal result to see whether the comparison result fell within our out of tolerance.

```
qResult.Status
```

```
ans =
    ComparisonSignalStatus enumeration
```



```
    OutOfTolerance
```

```
alphaResult.Status
```

```
ans =
    ComparisonSignalStatus enumeration

    OutOfTolerance
```

The comparison used a value of 0 for all tolerances, so the `OutOfTolerance` result means the signals are not identical.

You can further analyze the effect of the time constant by specifying tolerance values for the signals. Specify the tolerances by setting the properties for the `Simulink.sdi.Signal` objects that correspond to the signals being compared. Comparisons use tolerances specified for the baseline signals. This example specifies a time tolerance and an absolute tolerance.

To specify a tolerance, first access the `Signal` objects from the baseline run.

```
runTs1 = Simulink.sdi.getRun(runIDTs1);
qSig = getSignalsByName(runTs1,'q, rad/sec');
alphaSig = getSignalsByName(runTs1,'alpha, rad');
```

Specify an absolute tolerance of 0.1 and a time tolerance of 0.6 for the `q` signal using the `AbsTol` and `TimeTol` properties.

```
qSig.AbsTol = 0.1;
qSig.TimeTol = 0.6;
```

Specify an absolute tolerance of 0.2 and a time tolerance of 0.8 for the `alpha` signal.

```
alphaSig.AbsTol = 0.2;
alphaSig.TimeTol = 0.8;
```

Compare the results again. Access the results from the comparison and check the `Status` property for each signal.

```
tolDiffResult = Simulink.sdi.compareRuns(runIDTs1,runIDTs2);
qResult2 = getResultByIndex(tolDiffResult,1);
alphaResult2 = getResultByIndex(tolDiffResult,2);
```

```
qResult2.Status
```

```
ans =
    ComparisonSignalStatus enumeration

    WithinTolerance
```

```
alphaResult2.Status
```

```
ans =
    ComparisonSignalStatus enumeration

    WithinTolerance
```

Input Arguments

diffRes — Run comparison results

`Simulink.sdi.DiffRunResult` object

Run comparison results containing the signal result you want to access, specified as a `Simulink.sdi.DiffRunResult` object.

index — Index of signal in run comparison results

integer

Index of the signal in the `Simulink.sdi.DiffRunResult` object, specified as an integer.

Example: 2

Output Arguments

diffSig — Comparison results for signal at specified index

`Simulink.sdi.DiffSignalResult` object

Comparison results for the signal at the specified index, returned as a `Simulink.sdi.DiffSignalResult` object.

See Also

`Simulink.sdi.DiffRunResult` | `Simulink.sdi.DiffSignalResult`

Topics

“Inspect and Compare Data Programmatically”

Introduced in R2012b

Simulink.sdi.DiffRunResult.getLatest

Access results from most recent comparison

Syntax

```
diffRes = Simulink.sdi.DiffRunResult.getLatest
```

Description

`diffRes = Simulink.sdi.DiffRunResult.getLatest` returns the `Simulink.sdi.DiffRunResult` object `diffRes` for the most recent comparison performed using the Simulation Data Inspector UI or programmatic interface.

Tip When you compare data using the Simulation Data Inspector UI, results are not returned in the workspace. You can use the `Simulink.sdi.DiffRunResult.getLatest` function to access results for comparisons performed using the Simulation Data Inspector UI. When you compare data using the `Simulink.sdi.compareRuns` or `Simulink.sdi.compareSignals` functions, the function returns the data in a `Simulink.sdi.DiffRunResult` object or a `Simulink.sdi.DiffSignalResult` object.

Examples

Access Results for a UI Comparison

Use the `Simulink.sdi.DiffRunResult.getLatest` function to access the results of the most recent comparison to save or process further. For more information about how to compare data using the Simulation Data Inspector UI, see “Compare Simulation Data”.

```
compResults = Simulink.sdi.DiffRunResult.getLatest;
```

Retrieve Comparison Results in a Workspace Variable

You can use the `Simulink.sdi.getCurrentComparison` function or the `Simulink.sdi.DiffRunResult.getResult` function to retrieve the results for the most recent comparison if you accidentally delete the returned results from the workspace using the `clear` function.

If you delete the contents of the Simulation Data Inspector using the `Simulink.sdi.clear` function, you cannot recover the results.

Compare Simulation Data

This example creates runs to compare by running two simulations of the model `ex_vdp` with different values for `Mu`.

```
load_system('ex_vdp')
```

```
set_param('ex_vdp/Mu', 'Gain', '2');  
out1 = sim('ex_vdp');
```

```
set_param('ex_vdp/Mu', 'Gain', '5');  
out2 = sim('ex_vdp');
```

Use the `Simulink.sdi.getAllRunIDs` function to access the run IDs for the runs created from the simulations. Then use the `Simulink.sdi.compareRuns` function to compare the data.

```
IDs = Simulink.sdi.getAllRunIDs;  
runID1 = IDs(end-1);  
runID2 = IDs(end);
```

```
diffRun = Simulink.sdi.compareRuns(runID1, runID2);
```

Suppose you clear the workspace and lose the `diffRun` variable with the comparison results.

```
clear diffRun
```

Retrieve Comparison Data in the Workspace

Use the `Simulink.sdi.getCurrentComparison` function to recover the comparison results.

```
diffRun = Simulink.sdi.getCurrentComparison
```

```
diffRun =  
  DiffRunResult with properties:  
  
    MatlabVersion: '9.11.0.1751886 (R2021b)'  
        RunID1: 111390  
        RunID2: 111411  
  BaselineRunName: 'Run 1: ex_vdp'  
  CompareToRunName: 'Run 2: ex_vdp'  
        Count: 2  
  DateCreated: 01-Sep-2021 18:23:32  
  GlobalTolerance: [1x1 struct]  
        Summary: [1x1 struct]  
        Options: {'Units' 'MustMatch'}  
        Status: Completed  
  StopReason: []
```

You could also use the `Simulink.sdi.DiffRunResult.getLatest` function to recover the results.

```
clear diffRun
```

```
diffRun = Simulink.sdi.DiffRunResult.getLatest
```

```
diffRun =  
  DiffRunResult with properties:  
  
    MatlabVersion: '9.11.0.1751886 (R2021b)'  
        RunID1: 111390  
        RunID2: 111411  
  BaselineRunName: 'Run 1: ex_vdp'  
  CompareToRunName: 'Run 2: ex_vdp'  
        Count: 2  
  DateCreated: 01-Sep-2021 18:23:32  
  GlobalTolerance: [1x1 struct]
```

```
Summary: [1x1 struct]
Options: {'Units' 'MustMatch'}
Status: Completed
StopReason: []
```

Output Arguments

diffRes — Results of most recent comparison

`Simulink.sdi.DiffRunResult` object

Results of the most recent comparison, returned as a `Simulink.sdi.DiffRunResult` object.

See Also

`Simulink.sdi.DiffRunResult` | `Simulink.sdi.DiffSignalResult` |
`Simulink.sdi.compareRuns`

Topics

“Compare Simulation Data”

Introduced in R2020a

saveResult

Package: Simulink.sdi

Save comparison results to an MLDATX file

Syntax

```
saveResult(DiffRes, fileName)
saveResult(DiffRes, fileName, saveRuns)
```

Description

`saveResult(DiffRes, fileName)` saves the comparison results in the `Simulink.sdi.DiffRunResult` object, `DiffRes`, and original run data to the MLDATX file, `fileName`. You can load the MLDATX file containing the runs and comparison results into the Simulation Data Inspector using the `Simulink.sdi.load` or `open` functions.

`saveResult(DiffRes, fileName, saveRuns)` saves the comparison results with or without the original run data, depending on the specified value for `saveRuns`.

Examples

Compare Runs with Global Tolerance

You can specify global tolerance values to use when comparing two simulation runs. Global tolerance values are applied to all signals within the run. This example shows how to specify global tolerance values for a run comparison and how to analyze and save the comparison results.

First, load the session file that contains the data to compare. The session file contains data for four simulations of an aircraft longitudinal controller. This example compares data from two runs that use different input filter time constants.

```
Simulink.sdi.load('AircraftExample.mldatx');
```

To access the run data to compare, use the `Simulink.sdi.getAllRunIDs` function to get the run IDs that correspond to the last two simulation runs.

```
runIDs = Simulink.sdi.getAllRunIDs;
runID1 = runIDs(end - 1);
runID2 = runIDs(end);
```

Use the `Simulink.sdi.compareRuns` function to compare the runs. Specify a global relative tolerance value of 0.2 and a global time tolerance value of 0.5.

```
runResult = Simulink.sdi.compareRuns(runID1, runID2, 'reltol', 0.2, 'timetol', 0.5);
```

Check the `Summary` property of the returned `Simulink.sdi.DiffRunResult` object to see whether signals were within the tolerance values or out of tolerance.

```
runResult.Summary
```

```
ans = struct with fields:
    OutOfTolerance: 0
    WithinTolerance: 3
    Unaligned: 0
    UnitsMismatch: 0
    Empty: 0
    Canceled: 0
    EmptySynced: 0
    DataTypeMismatch: 0
    TimeMismatch: 0
    StartStopMismatch: 0
    Unsupported: 0
```

All three signal comparison results fell within the specified global tolerance.

You can save the comparison results to an MLDATX file using the `saveResult` function.

```
saveResult(runResult, 'InputFilterComparison');
```

Input Arguments

DiffRes — Run comparison results

`Simulink.sdi.DiffRunResult` object

Run comparison results that contain the data you want to save, specified as a `Simulink.sdi.DiffRunResult` object.

fileName — MLDATX file name

string | character vector

Name of the MLDATX file where you want to save the results, specified as a string or character array.

Example: 'ComparisonResults'

saveRuns — Whether to save original run data

1 or true (default) | 0 or false

Whether to save the original run data for the compared runs, specified as a logical 1 (true) or 0 (false). By default, the `saveResult` function saves the original run data along with the comparison results.

See Also

`Simulink.sdi.compareRuns` | `Simulink.sdi.DiffRunResult` | `Simulink.sdi.load` | `Simulink.sdi.Run` | `Simulink.sdi.save` | `Simulink.sdi.view`

Topics

“Compare Simulation Data”

“Save and Share Simulation Data Inspector Data and Views”

Introduced in R2020a

Simulink.sdi.enablePCTSupport

Control when to import data from parallel simulations into the Simulation Data Inspector

Syntax

```
Simulink.sdi.enablePCTSupport(mode)
```

Description

`Simulink.sdi.enablePCTSupport(mode)` configures data import into the Simulation Data Inspector from parallel workers according to the mode specified by `mode`. You can configure the Simulation Data Inspector to import only data from local workers, or data from local and remote workers. You can also set the mode to manual, which allows you to manually import runs into the Simulation Data Inspector using the `Simulink.sdi.sendWorkerRunToClient` function. By default, the Simulation Data Inspector is configured for the manual import mode.

Examples

Enable Automatic Data Import for All Parallel Workers

Configure Simulation Data Inspector parallel worker support to import the output automatically from both local and remote workers.

```
Simulink.sdi.enablePCTSupport('all')
```

Disable Automatic Data Import from Parallel Workers

To prevent the output from Parallel Computing Toolbox workers from automatically importing into the Simulation Data Inspector, specify the manual support mode.

```
Simulink.sdi.enablePCTSupport('manual')
```

Manually Send Runs from Parallel Workers to the Simulation Data Inspector

This example shows how to use `Simulink.sdi.sendWorkerRunToClient` to send runs created using parallel workers manually to the Simulation Data Inspector.

Setup

This example runs several simulations of the `vdp` model, varying the value of the gain, `Mu`. To set up for the parallel simulation, define a vector of `Mu` values and configure the Simulation Data Inspector for manual Parallel Computing Toolbox support.

```
% Enable manual Parallel Computing Toolbox support
Simulink.sdi.enablePCTSupport('manual');
```



```
% Choose several Mu values
MuVals = [1 2 3 4];
```

Initialize Parallel Workers

Use `parpool` (Parallel Computing Toolbox) to start a pool of four parallel workers. This example calls `parpool` inside an if statement so you only create a parallel pool if you don't already have one. You can use `spmd` (Parallel Computing Toolbox) to run initialization code common to all workers. For example, load the `vdp` model and select signals to log to runs that we can send to the Simulation Data Inspector on the client MATLAB. To avoid data concurrency issues when simulating with `sim` in `parfor`, create a temporary directory on each worker. After the simulations complete, another `spmd` block deletes the temporary directories.

```
p = gcp('nocreate');
```

```
if isempty(p)
```

```
    parpool(4);
```

```
end
```

```
Starting parallel pool (parpool) using the 'local' profile ...
connected to 4 workers.
```

```
spmd
```

```
    % Load system and select signals to log
    load_system('vdp')
    Simulink.sdi.markSignalForStreaming('vdp/x1',1,'on')
    Simulink.sdi.markSignalForStreaming('vdp/x2',1,'on')

    % Create temporary directory for simulation on worker
    workDir = pwd;
    addpath(workDir)
    tempDir = tempname;
    mkdir(tempDir)
    cd(tempDir)
```

```
end
```

Run Parallel Simulations with parfor

To stream data from parallel workers to the Simulation Data Inspector, you have to run parallel simulations using `parfor` (Parallel Computing Toolbox). Each worker runs a `vdp` simulation with a different value of `Mu`. Simulink cannot access the contents of the `parfor` loop, so the variable `MuVal` is defined in the worker's workspace, where the `vdp` model can see it, using `assignin`.

```
parfor (index = 1:4)
```

```
    % Set value of Mu in the worker's base workspace
    assignin('base','MuVal',MuVals(index));

    % Modify the value of Mu in the model and simulate
    set_param('vdp/Mu','Gain','MuVal')
    sim('vdp')
```

Access Data and Send Run to Client MATLAB

You can use the Simulation Data Inspector programmatic interface on the worker the same way you would in the client MATLAB. This example creates a `Simulink.sdi.Run` object and attaches the value of `Mu` used in the simulation with the `Tag` property.

```
% Attach metadata to the run
IDs = Simulink.sdi.getAllRunIDs;
lastIndex = length(IDs);
runID = Simulink.sdi.getRunIDByIndex(lastIndex);
parRun = Simulink.sdi.getRun(runID);
parRun.Tag = strcat('Mu = ', num2str(MuVals(index)));

% Send the run to the Simulation Data Inspector on the client MATLAB
Simulink.sdi.sendWorkerRunToClient
```

```
end
```

Close Temporary Directories and View Runs in the Simulation Data Inspector

Use another `spm` section to delete the temporary directories created on the workers once the simulations complete. In each simulation, `Simulink.sdi.sendWorkerRunToClient` imported runs from all the workers into the Simulation Data Inspector. You can view the data and check the run properties to see the value of `Mu` used during simulation.

```
spmd
```

```
% Remove temporary directories
cd(workDir)
rmdir(tempDir, 's')
rmpath(workDir)
```

```
end
```

```
Simulink.sdi.view
```

Access Data from a Parallel Simulation

This example executes parallel simulations of the model `slexAircraftExample` with different input filter time constants and shows several ways to access the data using the Simulation Data Inspector programmatic interface.

Setup

Start by ensuring the Simulation Data Inspector is empty and Parallel Computing Toolbox support is configured to import runs created on local workers automatically. Then, create a vector of filter parameter values to use in each simulation.

```
% Make sure the Simulation Data Inspector is empty, and PCT support is
% enabled.
Simulink.sdi.clear
Simulink.sdi.enablePCTSupport('local')

% Define Ts values
Ts_vals = [0.01, 0.02, 0.05, 0.1, 0.2, 0.5, 1];
```

Initialize Parallel Workers

Use `gcp` to create a pool of local workers to run parallel simulations if you don't already have one. In an `spmd` code block, load the `slexAircraftExample` model and select signals to log. To avoid data concurrency issues using `sim` in `parfor`, create a temporary directory for each worker to use during simulations.

```
p = gcp;
```

```
Starting parallel pool (parpool) using the 'local' profile ...
connected to 4 workers.
```

```
spmd
```

```
% Load system and select signals to log
load_system('slexAircraftExample')
Simulink.sdi.markSignalForStreaming('slexAircraftExample/Pilot', 1, 'on')
Simulink.sdi.markSignalForStreaming('slexAircraftExample/Aircraft Dynamics Model', 4, 'on')

% Create temporary directory on each worker
workDir = pwd;
addpath(workDir)
tempDir = tempname;
mkdir(tempDir)
cd(tempDir)
```

```
end
```

Run Parallel Simulations

Use `parfor` to run the seven simulations in parallel. Select the value for `Ts` for each simulation, and modify the value of `Ts` in the model workspace. Then, run the simulation and build an array of `Simulink.sdi.WorkerRun` objects to access the data with the Simulation Data Inspector. After the `parfor` loop, use another `spmd` segment to remove the temporary directories from the workers.

```
parfor index = 1:7
```

```
% Select value for Ts
Ts_val = Ts_vals(index);

% Change the filter time constant and simulate
modelWorkspace = get_param('slexAircraftExample', 'modelworkspace');
modelWorkspace.assignin('Ts', Ts_val)
sim('slexAircraftExample')

% Create a worker run for each simulation
workerRun(index) = Simulink.sdi.WorkerRun.getLatest
```

```
end
```

```
spmd
```

```
% Remove temporary directories
cd(workDir)
rmdir(tempDir, 's')
rmpath(workDir)
```

```
end
```

Get Dataset Objects from Parallel Simulation Output

The `getDataset` method puts the data from a `WorkerRun` into a `Dataset` object so you can easily post-process.

```
ds(7) = Simulink.SimulationData.Dataset;

for a = 1:7
    ds(a) = workerRun(a).getDataset;
end
ds(1)

ans =
Simulink.SimulationData.Dataset '' with 2 elements
```

| | Name | BlockPath |
|----------------|------------|--|
| 1 [1x1 Signal] | alpha, rad | ...rcraftExample/Aircraft Dynamics Model |
| 2 [1x1 Signal] | Stick | slexAircraftExample/Pilot |

- Use braces { } to access, modify, or add elements using index.

Get DatasetRef Objects from Parallel Simulation Output

For big data workflows, use the `getDatasetRef` method to reference the data associated with the `WorkerRun`.

```
for b = 1:7
    datasetRef(b) = workerRun(b).getDatasetRef;
end

datasetRef(1)

ans =
DatasetRef with properties:
    Name: 'Run 3: slexAircraftExample'
    Run: [1x1 Simulink.sdi.Run]
    numElements: 2
```

Process Parallel Simulation Data in the Simulation Data Inspector

You can also create local `Run` objects to analyze and visualize your data using the Simulation Data Inspector API. This example adds a tag indicating the filter time constant value for each run.

```
for c = 1:7

    Runs(c) = workerRun(c).getLocalRun;
    Ts_val_str = num2str(Ts_vals(c));
    desc = strcat('Ts = ', Ts_val_str);
    Runs(c).Description = desc;
    Runs(c).Name = strcat('slexAircraftExample run Ts=', Ts_val_str);

end
```

Clean Up Worker Repositories

Clean up the files used by the workers to free up disk space for other simulations you want to run on your worker pool.

`Simulink.sdi.cleanupWorkerResources`

Input Arguments

mode — Parallel worker data import mode

'manual' (default) | 'local' | 'all'

Simulation Data Inspector data import mode for data logged on parallel workers, specified as one of these options:

- 'manual' — Do not automatically import runs created on parallel workers. You can manually import runs created on parallel workers using the `Simulink.sdi.sendWorkerRunToClient` function.
- 'local' — Automatically import runs created on local workers.
- 'all' — Automatically import runs created on local and remote workers.

Data Types: char | string

Alternative Functionality

You can modify the parallel computing support mode in the Simulation Data Inspector by selecting **Preferences > Parallel**.

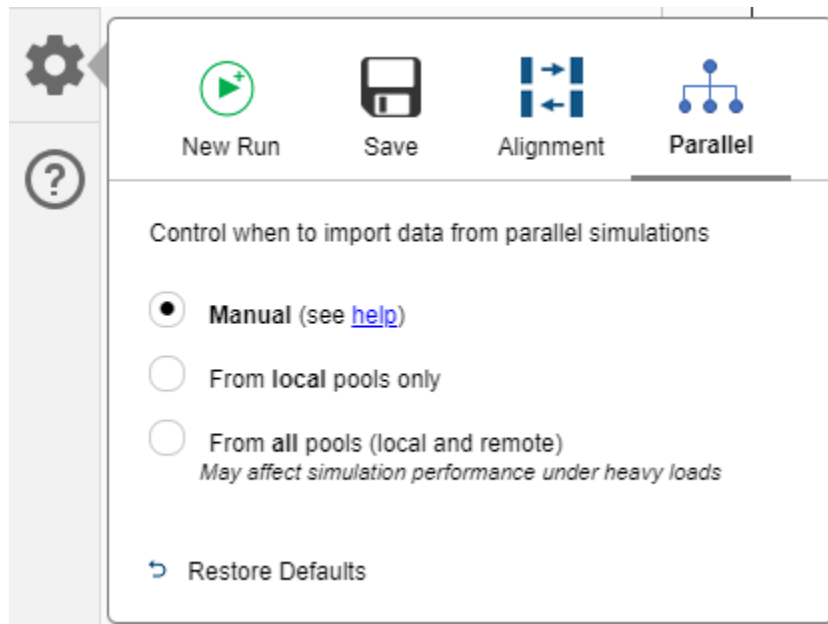

Compatibility Considerations

'none' input is no longer supported

Errors starting in R2020a

Starting in R2020a, the `Simulink.sdi.enablePCTSupport` function no longer supports the 'none' input option. To disable automatic import of data logged on parallel workers into the Simulation Data Inspector, use the 'manual' option.

Logical inputs are ignored

Behavior changed in R2020a

Starting in R2020a, the `Simulink.sdi.enablePCTSupport` function ignores logical inputs. In scripts that specify a logical input for the `Simulink.sdi.enablePCTSupport` function, replace a `0` or `false` input with the 'manual' input option and a `1` or `true` input with the 'all' option to achieve equivalent behavior.

Input values have changed

Behavior changed in R2018a

Starting in R2018a, the `Simulink.sdi.enablePCTSupport` input values changed to:

- 'local'
- 'none'
- 'all'
- 'manual'

In R2017b, the `Simulink.sdi.enablePCTSupport` function accepted a logical input to enable or disable Simulation Data Inspector support for data logged in parallel simulations.

- `true` or `1` enables support for automatically importing data from all parallel workers into the Simulation Data Inspector.

In R2018a, use the 'all' option for the same behavior. You can also use the new 'local' input when you want to automatically import data only from local workers.

- `false` or `0` disables all support for importing data logged on parallel workers.

In R2018a, use the 'none' option for the same behavior. You can also use the new 'manual' option when you want to analyze data on the worker to determine whether you want to import individual runs into the Simulation Data Inspector from a parallel worker.

See Also

`Simulink.sdi.isPCTSupportEnabled` | `Simulink.sdi.WorkerRun` | `Simulink.sdi.sendWorkerRunToClient`

Topics

"Inspect and Compare Data Programmatically"

Introduced in R2017b

Simulink.sdi.exportRun

Export Simulation Data Inspector run data to the workspace or a file

Syntax

```
dataset = Simulink.sdi.exportRun(runID)
Simulink.sdi.exportRun(runID,Name,Value)
```

Description

`dataset = Simulink.sdi.exportRun(runID)` creates a `Simulink.SimulationData.Dataset` object in the base workspace with the data in the Simulation Data Inspector run identified by `runID`.

`Simulink.sdi.exportRun(runID,Name,Value)` exports the data in the run corresponding to `runID` to the base workspace or a file according to the options specified by one or more name-value pair arguments. You can export data for one or more runs to a MAT, MLDATX, or Microsoft Excel file. To export data for multiple runs to a file, you can specify the `runIDs` input as a vector of run IDs.

Examples

Export Run Data

This example shows how to export data from a run in the Simulation Data Inspector to a `Simulink.SimulationData.Dataset` object in the base workspace that you can use to further process your data. The method you choose to export your run depends on the processing you do in your script. If you have a run object for the run, you can use the `export` method to create a `Simulink.SimulationData.Dataset` object with the run data in the base workspace. If you do not have a run object, use the `Simulink.sdi.exportRun` function to export the run to the workspace.

Export Run Using `Simulink.sdi.exportRun`

Use the `Simulink.sdi.export` function to export run data to the workspace or a file when your workflow does not include creating a run object.

To create a run of simulation data, open the `vdp` model, mark signals for logging, and run a simulation.

```
load_system('vdp')

SignalHandles = get_param('vdp', 'Lines');

Simulink.sdi.markSignalForStreaming(SignalHandles(5).Handle, 'on')
Simulink.sdi.markSignalForStreaming(SignalHandles(6).Handle, 'on')

out = sim('vdp');
```

Use the `Simulink.sdi.getAllRunIDs` function to access the most recently created run.

```
runIDs = Simulink.sdi.getAllRunIDs;  
runID = runIDs(end);
```

Use the `Simulink.sdi.exportRun` function to export the run data to a `Dataset` object in the workspace.

```
simDataset = Simulink.sdi.exportRun(runID);
```

Export Run Using the export Function

When your task involves creating a Run object, you can use the `export` function to create a `Simulink.SimulationData.Dataset` object in the base workspace to further process the run data. For example, suppose you need to access Run objects for simulation runs with signal data you want to compare using the `Simulink.sdi.compareSignals` function.

Load a model and mark signals for logging. Then simulate the model to create run data.

```
load_system('vdp')  
  
SignalHandles = get_param('vdp', 'Lines');  
  
Simulink.sdi.markSignalForStreaming(SignalHandles(5).Handle, 'on')  
Simulink.sdi.markSignalForStreaming(SignalHandles(6).Handle, 'on')  
  
sim('vdp');
```

Use the `Simulink.sdi.getAllRunIDs` function to access the run ID for the most recently created run. Then, use the `Simulink.sdi.getRun` function to access the Run object corresponding to the run.

```
runIDs = Simulink.sdi.getAllRunIDs;  
runID = runIDs(end);  
vdpRun = Simulink.sdi.getRun(runID);
```

Use the `export` function to export the run data to a `Dataset` object in the workspace.

```
simDataset = export(vdpRun);
```

Input Arguments

runID — Run identifier

scalar | vector

Run identifier for the run you want to export to the workspace or a file. When you export data to a file, you can export more than one run by specifying the `runID` input as a vector of Simulation Data Inspector run IDs.

The Simulation Data Inspector assigns a unique run ID to each run. You can get the run ID for one or more runs using `Simulink.sdi.getAllRunIDs` and `Simulink.sdi.getRunIDByIndex`.

Name-Value Pair Arguments

Specify optional comma-separated pairs of `Name, Value` arguments. `Name` is the argument name and `Value` is the corresponding value. `Name` must appear inside quotes. You can specify several name and value pair arguments in any order as `Name1, Value1, ..., NameN, ValueN`.

Example: `'to', 'file'`

to — Where to export data

'variable' (default) | 'file'

Where to export data, specified as the comma-separated pair consisting of 'to' and 'variable' or 'file'.

When you export data to a file, you must also specify a file name using the 'filename' name-value pair argument. You can specify a file name with a .mat, .mlatx, or .xlsx extension.

When you export a run to a MAT-file, the data is saved in a `Simulink.SimulationData.Dataset` object. When you export more than one run to a MAT-file using the `Simulink.sdi.exportRun` function, the data is saved in a `Dataset` object, where each element is a `Dataset` object that contains the data for one exported run.

Data exported to a Microsoft Excel file is saved using the format described in “Microsoft Excel Import, Export, and Logging Format”.

When you export data to a Microsoft Excel file, you can specify additional options using the 'overwrite', 'metadata', and 'sharetimecolumn' name-value pairs.

Example: 'to', 'file'

filename — Name of file to contain exported data

string | character array

Name of the file to contain the exported data, specified as the comma-separated pair consisting of 'filename' and a string or character array. Include a .mat, .mlatx, or .xlsx extension in the file name to specify whether to export the data to a MAT-file, MLDATX file, or a Microsoft Excel file. When you do not specify an extension with a file name, the data exports to a MAT-file.

Use the 'filename' name-value pair argument when you specify the 'to' name-value pair argument with the value 'file'.

When you export data to a Microsoft Excel file, you can specify additional options using the 'overwrite', 'metadata', and 'sharetimecolumn' name-value pair arguments.

Example: 'filename', 'mySpreadsheet.xlsx'

overwrite — Data to overwrite in existing Microsoft Excel file

'file' (default) | 'sheetonly'

Data to overwrite in existing Microsoft Excel file, specified as the comma-separated pair consisting of 'overwrite' and 'file' or 'sheetonly'.

- 'file' — Overwrite the entire file with the exported data.
- 'sheetonly' — Only overwrite sheets of the Microsoft Excel file with data that corresponds to the exported data.

When you export data to an existing MAT-file or MLDATX file, the exported data overwrites the entire file.

Example: 'overwrite', 'sheetonly'

metadata — Metadata to include in exported Microsoft Excel file

[] (default) | string array

Metadata to include in the exported Microsoft Excel file, specified as the comma-separated pair consisting of 'metadata' and a string array. By default, the export operation does not include any metadata. You can export this metadata to the Microsoft Excel file:

- `dataType` — Signal data type
- `units` — Signal units
- `blockPath` — Path to the source block for logged signals
- `interp` — Signal interpolation method
- `portIndex` — Index of the port on the source block for logged signals

You can specify the desired metadata in any order you choose in the string array. The order of the metadata in the string array does not affect the format in the exported file, which always matches the description in “Microsoft Excel Import, Export, and Logging Format”.

Example: `'metadata', ["units", "dataType"]`

sharetimecolumn — Whether signals share time columns in exported Microsoft Excel file
'on' (default) | 'off'

Whether signals that have identical time data share time columns in the exported Microsoft Excel file, specified as the comma-separated pair consisting of 'sharetimecolumn' and 'on' or 'off'. By default, signals with the same time data share a time column in the exported file. When you specify the value as 'off', each signal in the exported file has its own time column.

Example: `'sharetimecolumn', 'off'`

Output Arguments

dataset — Dataset containing run data

`Simulink.SimulationData.Dataset`

`Simulink.SimulationData.Dataset` object containing the data from the run identified by `runID`.

See Also

`Simulink.SimulationData.Dataset` | `Simulink.sdi.Run` | `Simulink.sdi.getAllRunIDs` | `Simulink.sdi.getRunIDByIndex` | `Simulink.sdi.save`

Topics

“Inspect and Compare Data Programmatically”

“Save and Share Simulation Data Inspector Data and Views”

Introduced in R2017a

Simulink.sdi.getAllRunIDs

Package: Simulink.sdi

Get all Simulation Data Inspector run identifiers

Syntax

```
runIDs = Simulink.sdi.getAllRunIDs
```

Description

`runIDs = Simulink.sdi.getAllRunIDs` returns a matrix of the run identifiers for all runs in the Simulation Data Inspector repository.

Examples

Get Simulation Data Inspector Run IDs

Many tasks performed using the Simulation Data Inspector programmatic interface start with obtaining the run ID for a simulation run. This example illustrates several methods to get the run ID for a run. You can use the run ID to access the `Simulink.sdi.Run` object that contains the run data and metadata and perform run comparisons using the `Simulink.sdi.compareRuns` function.

Create a Run

The model `sldemo_fuelsys` is already configured for logging. When you simulate the model, the Simulation Data Inspector automatically creates a run and assigns it a run ID.

```
load_system('sldemo_fuelsys')
sim('sldemo_fuelsys')
```

Get Run ID Using Simulink.sdi.getAllRunIDs

The `Simulink.sdi.getAllRunIDs` function returns an array of all run IDs for the runs in the Simulation Data Inspector repository, in order, with the most recently created run at the end.

```
runIDs = Simulink.sdi.getAllRunIDs;
runID = runIDs(end);
```

Get Run ID Using Simulink.sdi.getRunIDByIndex

You can also use the `Simulink.sdi.getRunCount` and `Simulink.sdi.getRunIDByIndex` functions to get the run ID for a run. This method is useful if you also want to use `count` as a counting variable to index through the runs in the Simulation Data Inspector repository.

```
count = Simulink.sdi.getRunCount;
runID = Simulink.sdi.getRunIDByIndex(count);
```

Get Run ID from a Simulink.sdi.Run Object

You can also get the run ID from the `Simulink.sdi.Run` object that corresponds to the run. This example uses the `Simulink.sdi.getCurrentSimulationRun` function to get the Run object that

corresponds to the most recent simulation of the `sldemo_fuelsys` model. You can also use the `Simulink.sdi.Run.getLatest` function to access the most recently created Run object.

```
fuelsysRun = Simulink.sdi.getCurrentSimulationRun('sldemo_fuelsys');  
runID = fuelsysRun.ID;
```

Output Arguments

runIDs — Matrix of Simulation Data Inspector run IDs

matrix

Matrix of run IDs in the Simulation Data Inspector repository.

See Also

[Simulink.sdi.getRun](#) | [Simulink.sdi.Run](#) | [Simulink.sdi.compareRuns](#) |
[Simulink.sdi.copyRun](#) | [Simulink.sdi.copyRunViewSettings](#) | [Simulink.sdi.deleteRun](#)
| [Simulink.sdi.exportRun](#) | [Simulink.sdi.getRunCount](#) | [Simulink.sdi.isValidRunID](#)

Topics

“Inspect and Compare Data Programmatically”

Introduced in R2017a

Simulink.sdi.getArchiveRunLimit

Package: Simulink.sdi

Determine configured run limit for Simulation Data Inspector archive

Syntax

```
limit = Simulink.sdi.getArchiveRunLimit
```

Description

`limit = Simulink.sdi.getArchiveRunLimit` returns the limit configured for the number of runs the Simulation Data Inspector stores in the archive. When the number of runs in the archive reaches the limit, the Simulation Data Inspector starts to delete runs from the archive on a first-in, first-out basis. When another run enters the archive, the Simulation Data Inspector deletes the run that has been in the archive the longest. A `limit` of `-1` indicates the archive has no limit for the number of runs it stores. A `limit` of `0` means that the archive cannot contain any runs.

Tip To retain data for only the current run, configure the Simulation Data Inspector to automatically archive runs and set the archive run limit to `0`.

Examples

Configure the Simulation Data Inspector Archive

You can configure the Simulation Data Inspector to retain only the logged data for your current simulation. In iterative design and debugging workflows, this configuration helps prevent accumulation of unwanted logged data on disk. First, check the configuration of the Simulation Data Inspector archive. You can save the parameters to restore your preferences after you finish designing or debugging.

```
limit = Simulink.sdi.getArchiveRunLimit;  
mode = Simulink.sdi.getAutoArchiveMode;
```

Set the archive limit to `0` and configure the Simulation Data Inspector to automatically archive simulation runs.

```
Simulink.sdi.setArchiveRunLimit(0)  
Simulink.sdi.setAutoArchiveMode(true)
```

When you simulate your model, the Simulation Data Inspector deletes the previous run and updates the view to show signals in the current simulation.

When you finish designing or debugging your model, you can restore the Simulation Data Inspector archive back to its previous configuration.

```
Simulink.sdi.setArchiveRunLimit(limit)  
Simulink.sdi.setAutoArchiveMode(mode)
```

Output Arguments

Limit — Maximum number of runs to store in the Simulation Data Inspector archive

scalar

Limit for the number of runs stored in the Simulation Data Inspector archive. When the number of runs in the archive reaches the limit, the Simulation Data Inspector starts to delete runs from the archive, on a first-in, first-out basis. A `limit` of `-1` indicates there is no limit on the runs stored in the archive. A `limit` of `0` indicates that the archive cannot contain any runs.

See Also

`Simulink.sdi.setArchiveRunLimit` | `Simulink.sdi.getAutoArchiveMode` | `Simulink.sdi.setAutoArchiveMode`

Topics

“Iterate Model Design Using the Simulation Data Inspector”

Introduced in R2018b

Simulink.sdi.getAutoArchiveMode

Package: Simulink.sdi

Determine if the Simulation Data Inspector is configured to automatically archive

Syntax

```
mode = Simulink.sdi.getAutoArchiveMode
```

Description

`mode = Simulink.sdi.getAutoArchiveMode` returns a logical value that indicates whether the Simulation Data Inspector is configured to automatically archive simulation runs. When `mode` is `true`, the Simulation Data Inspector automatically archives simulation runs. When `mode` is `false`, the Simulation Data Inspector does not automatically archive.

Examples

Configure the Simulation Data Inspector Archive

You can configure the Simulation Data Inspector to retain only the logged data for your current simulation. In iterative design and debugging workflows, this configuration helps prevent accumulation of unwanted logged data on disk. First, check the configuration of the Simulation Data Inspector archive. You can save the parameters to restore your preferences after you finish designing or debugging.

```
limit = Simulink.sdi.getArchiveRunLimit;  
mode = Simulink.sdi.getAutoArchiveMode;
```

Set the archive limit to 0 and configure the Simulation Data Inspector to automatically archive simulation runs.

```
Simulink.sdi.setArchiveRunLimit(0)  
Simulink.sdi.setAutoArchiveMode(true)
```

When you simulate your model, the Simulation Data Inspector deletes the previous run and updates the view to show signals in the current simulation.

When you finish designing or debugging your model, you can restore the Simulation Data Inspector archive back to its previous configuration.

```
Simulink.sdi.setArchiveRunLimit(limit)  
Simulink.sdi.setAutoArchiveMode(mode)
```

Output Arguments

mode — Logical indication of Simulation Data Inspector automatic archive configuration

logical

Logical value that indicates whether the Simulation Data Inspector is configured to automatically archive simulation runs.

- `true` — The Simulation Data Inspector automatically archives simulation runs.
- `false` — The Simulation Data Inspector does not automatically archive simulation runs.

See Also

`Simulink.sdi.setAutoArchiveMode` | `Simulink.sdi.getArchiveRunLimit` | `Simulink.sdi.setArchiveRunLimit`

Topics

“Iterate Model Design Using the Simulation Data Inspector”

Introduced in R2018b

Simulink.sdi.getBorderOn

Get border display setting for time plots

Syntax

```
border = Simulink.sdi.getBorderOn
```

Description

`border = Simulink.sdi.getBorderOn` returns the current setting for whether borders are displayed on time plots in the Simulation Data Inspector. The return value corresponds to the value of the **Show border** setting on the **Time Plot** section of the **Visualization Settings** in the Simulation Data Inspector. The setting applies to all time plots in the layout. By default, the Simulation Data Inspector displays the border on time plots.

Examples

Configure Time Plot Border Display

You can use the `Simulink.sdi.setBorderOn` function to show or hide the border on time plots in the Simulation Data Inspector. By default, the Simulation Data Inspector shows the border on time plots.

This example starts by showing how to use the `Simulink.sdi.getBorderOn` function to determine whether the border is currently displayed. Subsequent sections show the code to hide and show the border. To show the result, the example generates an image using the `Simulink.sdi.snapshot` function with settings specified by a `Simulink.sdi.CustomSnapshot` object.

```
snapSettings = Simulink.sdi.CustomSnapshot;  
snapSettings.Width = 300;  
snapSettings.Height = 300;
```

Get Current Border Display Setting

Before modifying the border display setting for time plots, you can save the current setting to a variable in the workspace in case you want to restore the preference later.

```
border = Simulink.sdi.getBorderOn;
```

Hide the Border on Time Plots

```
Simulink.sdi.setBorderOn(false)  
Simulink.sdi.snapshot('from', 'custom', 'settings', snapSettings);
```

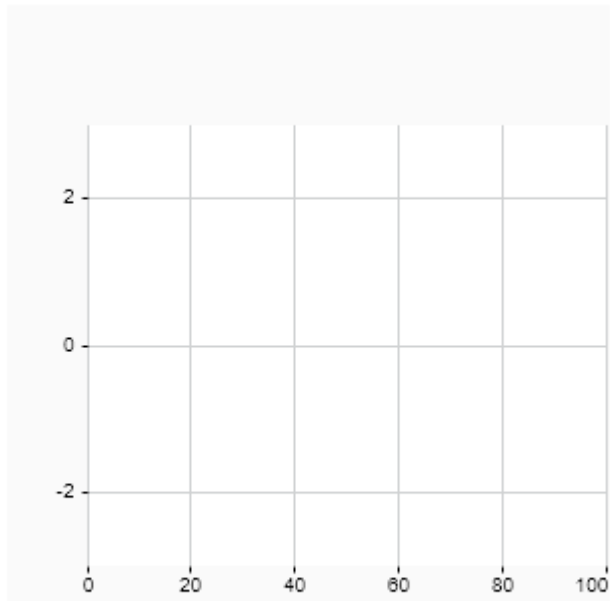

Show the Border on Time Plots

```
Simulink.sdi.setBorderOn(true)  
Simulink.sdi.snapshot('from', 'custom', 'settings', snapSettings);
```

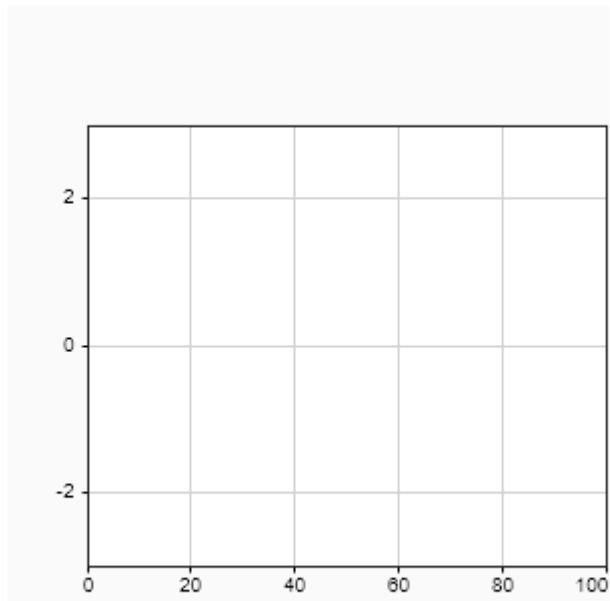

Output Arguments

border — Border display setting for time plots

true or 1 | false or 0

Border display setting for time plots in the Simulation Data Inspector, returned as true (1) or false (0).

- true or 1 — Border displayed for time plots.
- false or 0 — Border hidden for time plots.

See Also

[Simulink.sdi.setBorderOn](#) | [Simulink.sdi.getGridOn](#) | [Simulink.sdi.getMarkersOn](#) | [Simulink.sdi.getTickLabelsDisplay](#) | [Simulink.sdi.getTicksPosition](#) | [Simulink.sdi.saveView](#) | [Simulink.sdi.save](#)

Topics

“Create Plots Using the Simulation Data Inspector”

Introduced in R2019b

Simulink.sdi.getCurrentComparison

Access results from most recent comparison

Syntax

```
diffRes = Simulink.sdi.getCurrentComparison
```

Description

`diffRes = Simulink.sdi.getCurrentComparison` returns the `Simulink.sdi.DiffRunResult` object `diffRes` for the most recent comparison performed using the Simulation Data Inspector UI or programmatic interface.

Tip When you compare data using the Simulation Data Inspector UI, results are not returned in the workspace. You can use the `Simulink.sdi.getCurrentComparison` function to access results for comparisons performed using the Simulation Data Inspector UI. When you compare data using the `Simulink.sdi.compareRuns` or `Simulink.sdi.compareSignals` functions, the function returns the data in a `Simulink.sdi.DiffRunResult` object or a `Simulink.sdi.DiffSignalResult` object.

Examples

Access Results for a UI Comparison

Use the `Simulink.sdi.getCurrentComparison` function to access the results of the most recent comparison to save or process further. For more information about how to compare data using the Simulation Data Inspector UI, see “Compare Simulation Data”.

```
compResults = Simulink.sdi.getCurrentComparison;
```

Retrieve Comparison Results in a Workspace Variable

You can use the `Simulink.sdi.getCurrentComparison` function or the `Simulink.sdi.DiffRunResult.getResult` function to retrieve the results for the most recent comparison if you accidentally delete the returned results from the workspace using the `clear` function.

If you delete the contents of the Simulation Data Inspector using the `Simulink.sdi.clear` function, you cannot recover the results.

Compare Simulation Data

This example creates runs to compare by running two simulations of the model `ex_vdp` with different values for `Mu`.

```
load_system('ex_vdp')
```

```
set_param('ex_vdp/Mu', 'Gain', '2');
out1 = sim('ex_vdp');
```

```
set_param('ex_vdp/Mu', 'Gain', '5');
out2 = sim('ex_vdp');
```

Use the `Simulink.sdi.getAllRunIDs` function to access the run IDs for the runs created from the simulations. Then use the `Simulink.sdi.compareRuns` function to compare the data.

```
IDs = Simulink.sdi.getAllRunIDs;
runID1 = IDs(end-1);
runID2 = IDs(end);
```

```
diffRun = Simulink.sdi.compareRuns(runID1, runID2);
```

Suppose you clear the workspace and lose the `diffRun` variable with the comparison results.

```
clear diffRun
```

Retrieve Comparison Data in the Workspace

Use the `Simulink.sdi.getCurrentComparison` function to recover the comparison results.

```
diffRun = Simulink.sdi.getCurrentComparison
```

```
diffRun =
  DiffRunResult with properties:

    MatlabVersion: '9.11.0.1751886 (R2021b)'
    RunID1: 111390
    RunID2: 111411
    BaselineRunName: 'Run 1: ex_vdp'
    CompareToRunName: 'Run 2: ex_vdp'
    Count: 2
    DateCreated: 01-Sep-2021 18:23:32
    GlobalTolerance: [1x1 struct]
    Summary: [1x1 struct]
    Options: {'Units' 'MustMatch'}
    Status: Completed
    StopReason: []
```

You could also use the `Simulink.sdi.DiffRunResult.getLatest` function to recover the results.

```
clear diffRun
```

```
diffRun = Simulink.sdi.DiffRunResult.getLatest
```

```
diffRun =
  DiffRunResult with properties:

    MatlabVersion: '9.11.0.1751886 (R2021b)'
    RunID1: 111390
    RunID2: 111411
    BaselineRunName: 'Run 1: ex_vdp'
    CompareToRunName: 'Run 2: ex_vdp'
    Count: 2
    DateCreated: 01-Sep-2021 18:23:32
    GlobalTolerance: [1x1 struct]
```

```
Summary: [1x1 struct]
Options: {'Units' 'MustMatch'}
Status: Completed
StopReason: []
```

Output Arguments

diffRes — Results of most recent comparison

`Simulink.sdi.DiffRunResult` object

Results of the most recent comparison, returned as a `Simulink.sdi.DiffRunResult` object.

See Also

`Simulink.sdi.DiffRunResult` | `Simulink.sdi.DiffSignalResult` |
`Simulink.sdi.compareRuns`

Topics

“Compare Simulation Data”

Introduced in R2020a

Simulink.sdi.getCurrentSimulationRun

Access data for in-progress or most recently completed simulation

Syntax

```
runObj = Simulink.sdi.getCurrentSimulationRun mdl
```

Description

`runObj = Simulink.sdi.getCurrentSimulationRun mdl` returns the `Simulink.sdi.Run` object that corresponds to the in-progress or most recently completed simulation of the model specified by `mdl`. If you delete the Run object that corresponds to the most recently completed simulation, the `Simulink.sdi.getCurrentSimulationRun` function returns empty.

Examples

Access Simulation Data Inspector Runs

Many tasks performed using the Simulation Data Inspector programmatic interface start by accessing the `Simulink.sdi.Run` object that corresponds to the logged or imported data you want to analyze. For example, you can use the Run object to access the `Simulink.sdi.Signal` objects that correspond to individual signals in the run.

This example shows how to access Run objects by using the `Simulink.sdi.Run.getLatest` function, the `Simulink.sdi.getCurrentSimulationRun` function, or the `Simulink.sdi.getRun` function.

Create a Run

The model `sldemo_fuelsys` is already configured for logging. When you simulate the model, the Simulation Data Inspector automatically creates a run and assigns it a run ID.

```
load_system('sldemo_fuelsys')
sim('sldemo_fuelsys')
```

Get Run Object Using `Simulink.sdi.Run.getLatest`

In this example, the run created when you simulated the model is the most recently created run in the Simulation Data Inspector. When you want to access the most recently created run, use the `Simulink.sdi.Run.getLatest` function.

```
fuelsysRun = Simulink.sdi.Run.getLatest;
```

Get Run Object Using `Simulink.sdi.getCurrentSimulationRun`

The run you want to access may not be the most recently created run in the Simulation Data Inspector. If the run corresponds to the most recent simulation of a model, you can use the `Simulink.sdi.getCurrentSimulationRun` function to access the Run object. You can also use the `Simulink.sdi.getCurrentSimulationRun` function to access data for an in-progress

simulation when the simulation streams data to the Simulation Data Inspector. This function can be useful when you are working with multiple models.

In this example, the run created when you simulated the model is the current simulation run for the `sldemo_fuelsys` model.

```
fuelsysRun = Simulink.sdi.getCurrentSimulationRun('sldemo_fuelsys');
```

Get Run Object from a Run ID

When your task also requires the run ID, you can use the `Simulink.sdi.getRun` function to get the corresponding `Simulink.sdi.Run` object that contains the run data and metadata.

```
runIDs = Simulink.sdi.getAllRunIDs;  
runID = runIDs(end);  
fuelsysRun = Simulink.sdi.getRun(runID);
```

Input Arguments

mdl — Model name

string | character vector

Name of the model that created the simulation data you want to access, specified as a string or character array.

Example: `'vdp'`

Data Types: `char` | `string`

Output Arguments

runObj — `Simulink.sdi.Run` object for the in-progress or most recently completed simulation

`Simulink.sdi.Run` object

`Simulink.sdi.Run` object that corresponds to the in-progress or most recently completed simulation.

Tips

- You can use the `Simulink.sdi.getCurrentSimulationRun` function to access logged data in a `StopFcn` model callback function. Workspace variable data is not available when the `StopFcn` callback executes, but the `Run` object is available because data streams to the Simulation Data Inspector.
- You can use the `Simulink.sdi.getCurrentSimulationRun` function to analyze run data on parallel workers to determine whether to send the run data to the Simulation Data Inspector.

See Also

`Simulink.sdi.getAllRunIDs` | `Simulink.sdi.Run` | `Simulink.sdi.getRun` |
`Simulink.sdi.getRunCount` | `Simulink.sdi.getRunIDByIndex` |
`Simulink.sdi.Run.getLatest`

Topics

“Inspect and Compare Data Programmatically”

Introduced in R2020a

Simulink.sdi.getCursorPositions

Get position for active cursors in the Simulation Data Inspector

Syntax

```
t1 = Simulink.sdi.getCursorPositions
t1 = Simulink.sdi.getCursorPositions(view)
[t1,t2] = Simulink.sdi.getCursorPositions
[t1,t2] = Simulink.sdi.getCursorPositions(view)
```

Description

`t1 = Simulink.sdi.getCursorPositions` returns the value of the leftmost active cursor in the **Inspect** pane of the Simulation Data Inspector. Assign the return to a single output when one cursor is active.

`t1 = Simulink.sdi.getCursorPositions(view)` returns the value of the leftmost active cursor in the **Inspect** or **Compare** pane of the Simulation Data Inspector according to `view`. Assign the return to a single output when one cursor is active.

`[t1,t2] = Simulink.sdi.getCursorPositions` returns the positions of the active cursors in the **Inspect** pane of the Simulation Data Inspector.

`[t1,t2] = Simulink.sdi.getCursorPositions(view)` returns the positions of the active cursors in the **Inspect** or **Compare** pane of the Simulation Data Inspector according to `view`.

Examples

Programmatically Interact with Cursors in the Simulation Data Inspector

You can use the Simulation Data Inspector programmatic interface to specify the position of cursors on time plots or sparklines and to access the time that corresponds to the current cursor position.

Open the session file `vdp_mu.mldatx` to add and plot data in the Simulation Data Inspector. The session file contains data for a 20-second simulation of a model of the Van Der Pol equation, with signals `x1` and `x2` plotted on separate subplots in a 2-by-1 subplot layout.

```
open vdp_mu.mldatx;
```

Use the `Simulink.sdi.setNumCursors` function to add one cursor to the plot.

```
Simulink.sdi.setNumCursors(1);
```

Suppose you want to know the signal values 5 seconds into the simulation. Use the `Simulink.sdi.setCursorPositions` function to move the cursor to `t=5s` and read the signal values off from the cursor on each subplot. The asterisk next to the value in the cursor label indicates that the value is interpolated because the simulation did not include a calculation for a simulation time of exactly 5s.

```
Simulink.sdi.setCursorPositions('left',5);
```

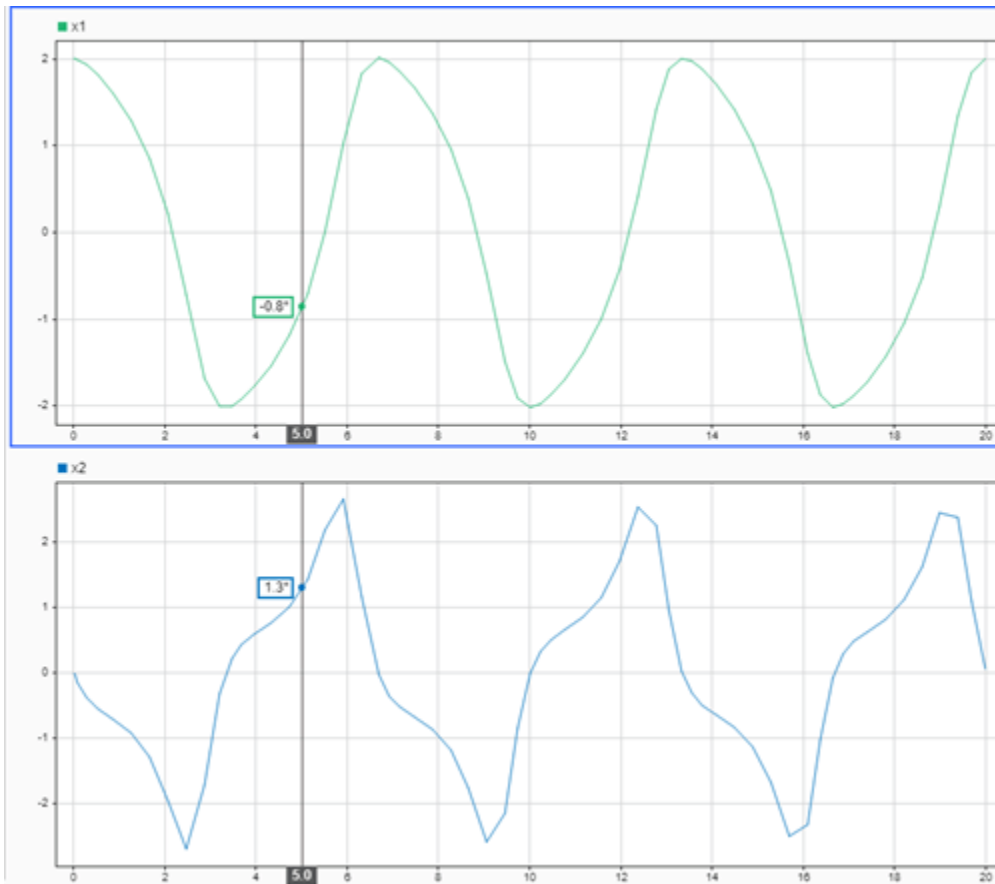

Suppose you want to calculate the time between two peaks in the x2 signal. Add a second cursor using the `Simulink.sdi.setNumCursors` function or using the **Show/hide data cursors** button in the Simulation Data Inspector.

```
numCursors = Simulink.sdi.getNumCursors;
if(numCursors < 2)
    Simulink.sdi.setNumCursors(2);
end
```

Drag the cursors so the left cursor is positioned at the first peak in the x2 signal and the right cursor is positioned at the second peak. Alternatively, run this code that positions the cursors for you.

```
Simulink.sdi.setCursorPositions('left',5.921998549931304,'right',12.378442136906246);
```

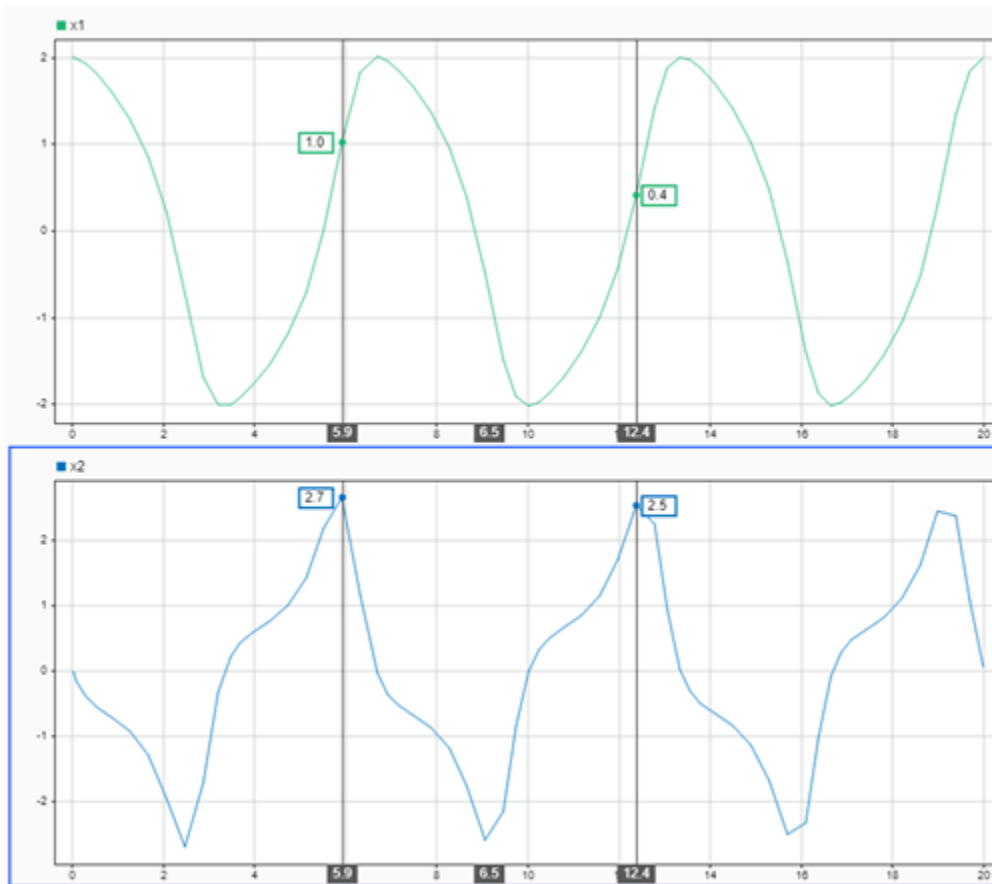

The Simulation Data Inspector displays the difference between the two cursors in seconds. However, the cursor position and difference values are both rounded. Use the `Simulink.sdi.getCursorPosition` function to programmatically retrieve the exact time values that correspond to the cursor positions. Then, compute the difference between the times.

```
[t1,t2] = Simulink.sdi.getCursorPosition;
T = t2 - t1
```

```
T = NaN
```

Input Arguments

view — Plot area on which to return cursor positions

'inspect' (default) | 'compare'

Plot area for which to return cursor positions, specified as 'inspect' or 'compare'.

Example: `[t1,t2] = Simulink.sdi.getCursorPosition('compare')` returns the positions of two cursors on the **Compare** pane of the Simulation Data Inspector.

Data Types: char | string

Output Arguments

t1 — Left cursor position

scalar

Left cursor position, returned as a scalar. When no cursors are active in the plot area specified by `view`, the value for `t1` is returned as `NaN`.

Cursor identities are relative, not absolute. If the left cursor moves to the right of the right cursor, the left cursor becomes the right cursor and vice versa.

t2 — Right cursor position

scalar

Right cursor position, returned as a scalar. When fewer than two cursors are active in the plot area specified by `view`, the value for `t1` is returned as `NaN`.

Cursor identities are relative, not absolute. If the left cursor moves to the right of the right cursor, the left cursor becomes the right cursor and vice versa.

See Also

Functions

`Simulink.sdi.getNumCursors` | `Simulink.sdi.setCursorPositions`

Topics

“Inspect Simulation Data”

“Create Plots Using the Simulation Data Inspector”

Introduced in R2021a

Simulink.sdi.getDeleteRunsOnLowSpace

Get configured behavior when size of logged data approaches configured limits

Syntax

```
deleteRuns = Simulink.sdi.getDeleteRunsOnLowSpace
```

Description

`deleteRuns = Simulink.sdi.getDeleteRunsOnLowSpace` returns the configured behavior for when the size of logged data approaches a configured size limit or free disk space requirement. When `deleteRuns` is `true`, logged data from prior simulations is deleted first to free space for continued logging in the current simulation. If deleting prior simulation data does not free enough disk space to continue logging through the end of the current simulation, recording data is disabled. When `deleteRuns` is `false`, recording data from the current simulation is disabled and no logged data from prior simulations is deleted.

Examples

Get Configured Logging Size Limits

You can limit the size of logged data by specifying a maximum size for the data or a minimum amount of disk space to leave empty. This example uses several functions to get the current configuration of logging size limits.

Use the `Simulink.sdi.getRequiredFreeSpace` function to get the configured minimum free disk space requirement. The returned value uses units of GB.

```
minDiskSpace = Simulink.sdi.getRequiredFreeSpace;
```

Use the `Simulink.sdi.getMaxDiskUsage` function to get the configured maximum size for data logged to disk. The returned value uses units of GB.

```
maxSize = Simulink.sdi.getMaxDiskUsage;
```

Use the `Simulink.sdi.getDeleteRunsOnLowSpace` function to get the configured behavior when approaching the logging limits. When `deleteRuns` is `true`, data from prior simulations is deleted first to free disk space for continued logging in the current simulation. If deleting runs does not free up enough space, recording logged data is disabled for the current simulation. When `deleteRuns` is `false`, recording logged data is disabled for the current simulation and data from prior simulations is retained.

```
deleteRuns = Simulink.sdi.getDeleteRunsOnLowSpace;
```

Output Arguments

deleteRuns — Behavior when logged data size approaches configured limits

1 | 0

Behavior when logged data size approaches configured limits, returned as 1 (`true`) or 0 (`false`).

- `true` — First delete data logged from prior simulations. If deleting prior simulation data does not free enough space, disable recording data.
- `false` — Disable recording data for current simulation. Do not delete prior simulation data.

When recording is disabled due to configured disk space requirements or logged data size limits, you need to enable recording again to log data in subsequent simulations. You can configure the record mode in the Simulation Data Inspector preferences or by using the `Simulink.sdi.setRecordData` function.

See Also

Functions

`Simulink.sdi.setDeleteRunsOnLowSpace` | `Simulink.sdi.setMaxDiskUsage` |
`Simulink.sdi.getMaxDiskUsage` | `Simulink.sdi.setRequiredFreeSpace` |
`Simulink.sdi.getRequiredFreeSpace` | `Simulink.sdi.setRecordData` |
`Simulink.sdi.getRecordData`

Topics

“Limit the Size of Logged Data”

“Configure the Simulation Data Inspector”

Introduced in R2021a

Simulink.sdi.getGridOn

Package: Simulink.sdi

Determine grid configuration for time plots

Syntax

```
grid = Simulink.sdi.getGridOn
```

Description

`grid = Simulink.sdi.getGridOn` returns the grid configuration for time plots in the Simulation Data Inspector. By default, the Simulation Data Inspector shows horizontal and vertical grid lines.

Examples

Configure Grid for Time Plots in the Simulation Data Inspector

You can use `Simulink.sdi.setGridOn` to configure the appearance of the grid for time plots in the Simulation Data Inspector. By default, the Simulation Data Inspector shows horizontal and vertical grid lines.

This example starts by showing how to use `Simulink.sdi.getGridOn` to access the current grid configuration. The subsequent sections show the code for each configuration option for time plot grid in the Simulation Data Inspector. To see the result, the example uses a `Simulink.sdi.CustomSnapshot` object to specify settings for the output of the `Simulink.sdi.snapshot` function.

```
snapSettings = Simulink.sdi.CustomSnapshot;  
snapSettings.Width = 300;  
snapSettings.Height = 300;
```

Get Initial Grid Setting

Before modifying the grid display preferences, you can save the current configuration to a variable in the workspace in case you want to restore the preferences later.

```
gridInit = Simulink.sdi.getGridOn;
```

Configure Horizontal Grid Lines

Show only horizontal grid lines in the Simulation Data Inspector.

```
Simulink.sdi.setGridOn('horizontal')  
Simulink.sdi.snapshot('from','custom','settings',snapSettings);
```

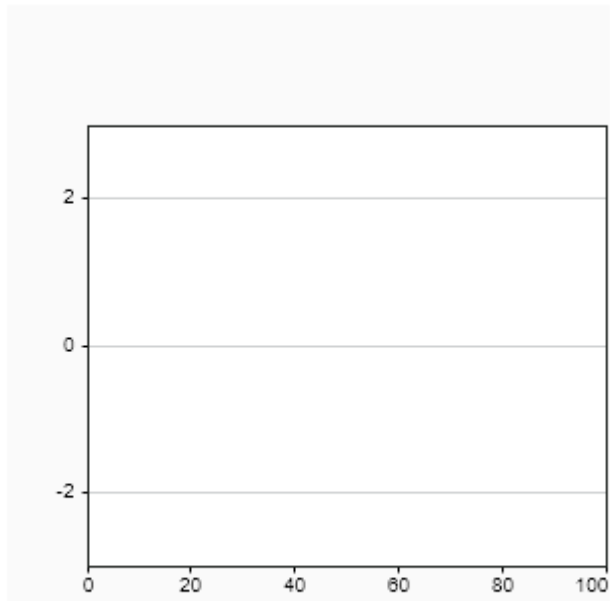
Configure Vertical Grid Lines

Show only vertical grid lines in the Simulation Data Inspector.

```
Simulink.sdi.setGridOn('vertical')  
Simulink.sdi.snapshot('from', 'custom', 'settings', snapSettings);
```

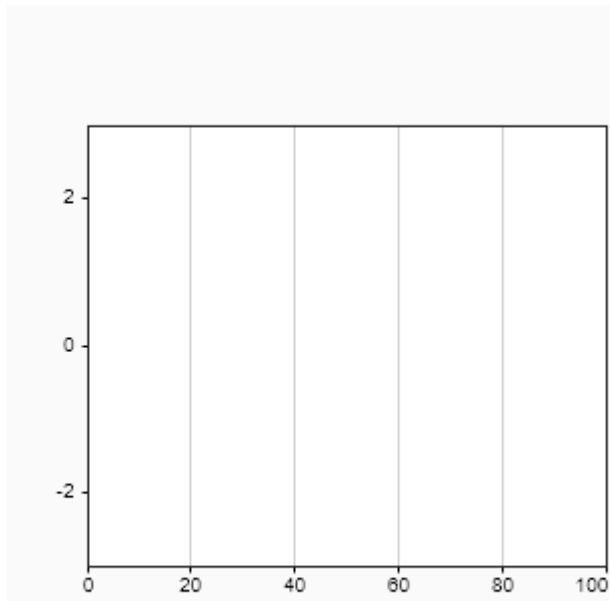

Configure No Grid Lines

Show no grid lines in the Simulation Data Inspector.

```
Simulink.sdi.setGridOn('off')  
Simulink.sdi.snapshot('from','custom','settings',snapSettings);
```

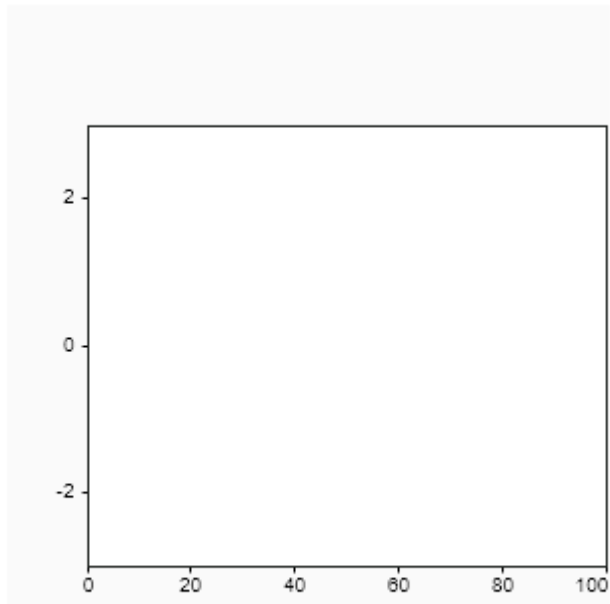

Configure Horizontal and Vertical Grid Lines

Show horizontal and vertical grid lines in the Simulation Data Inspector.

```
Simulink.sdi.setGridOn('on')  
Simulink.sdi.snapshot('from', 'custom', 'settings', snapSettings);
```

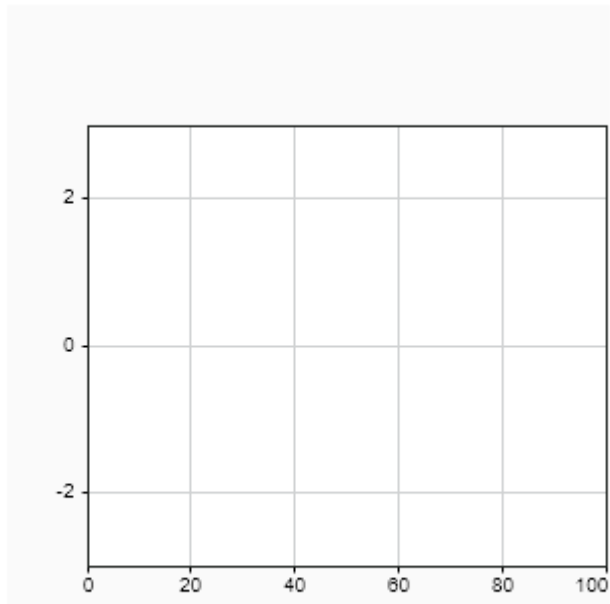

Output Arguments

grid — Time plot grid configuration

'on' (default) | 'horizontal' | 'vertical' | 'off'

Grid configuration for time plots in the Simulation Data Inspector.

- 'on' — Horizontal and vertical grid lines are shown on time plots in the Simulation Data Inspector.
- 'horizontal' — Only horizontal grid lines are shown on time plots in the Simulation Data Inspector.
- 'vertical' — Only vertical grid lines are shown on time plots in the Simulation Data Inspector.
- 'off' — No grid lines are shown on time plots in the Simulation Data Inspector.

Compatibility Considerations

Simulink.sdi.getGridOn return values have changed

Behavior changed in R2019b

Starting in R2019b, the `Simulink.sdi.getGridOn` return values changed to:

- 'on'
- 'horizontal'
- 'vertical'

- 'off'

In R2019a, the `Simulink.sdi.getGridOn` returned a logical value:

- `true` or `1` — Horizontal and vertical grid lines are shown on time plots in the Simulation Data Inspector.
- `false` or `0` — Horizontal and vertical grid lines are hidden on time plots in the Simulation Data Inspector.

Starting in R2019b, the 'on' return value is equivalent to the `true` or `1` return, and the 'off' return value is equivalent to the `false` or `0` return.

See Also

`Simulink.sdi.setGridOn` | `Simulink.sdi.getBorderOn` | `Simulink.sdi.getMarkersOn` | `Simulink.sdi.getTicksPosition` | `Simulink.sdi.getTickLabelsDisplay` | `Simulink.sdi.clearPreferences` | `Simulink.sdi.saveView` | `Simulink.sdi.save`

Topics

“Create Plots Using the Simulation Data Inspector”

“View Data in the Simulation Data Inspector”

Introduced in R2019a

Simulink.sdi.getMarkersOn

Package: Simulink.sdi

Determine if data markers are shown in the Simulation Data Inspector

Syntax

```
markersOn = Simulink.sdi.getMarkersOn
```

Description

`markersOn = Simulink.sdi.getMarkersOn` returns a logical value indicating whether data markers are displayed on plots in the Simulation Data Inspector.

Examples

Store Marker State

You can check and store the value of the **Show markers** setting in the Simulation Data Inspector from the command window or in a script.

```
markersOn = Simulink.sdi.getMarkersOn;
```

Output Arguments

markersOn — Logical indication of marker state

false or 0 (default) | true or 1

Logical indication of whether markers are displayed on plots in the Simulation Data Inspector.

- true or 1 indicates that markers are displayed.
- false or 0 indicates that markers are not displayed.

See Also

[Simulink.sdi.setMarkersOn](#) | [Simulink.sdi.getBorderOn](#) | [Simulink.sdi.getGridOn](#) | [Simulink.sdi.getTicksPosition](#) | [Simulink.sdi.getTickLabelsDisplay](#) | [Simulink.sdi.clearPreferences](#) | [Simulink.sdi.saveView](#) | [Simulink.sdi.save](#)

Topics

“Inspect and Compare Data Programmatically”

Introduced in R2017b

Simulink.sdi.getMaxDiskUsage

Get configured maximum size for data logged to disk

Syntax

```
maxSize = Simulink.sdi.getMaxDiskUsage
```

Description

`maxSize = Simulink.sdi.getMaxDiskUsage` returns the maximum size configured for data logged to disk, in units of GB.

Examples

Get Configured Logging Size Limits

You can limit the size of logged data by specifying a maximum size for the data or a minimum amount of disk space to leave empty. This example uses several functions to get the current configuration of logging size limits.

Use the `Simulink.sdi.getRequiredFreeSpace` function to get the configured minimum free disk space requirement. The returned value uses units of GB.

```
minDiskSpace = Simulink.sdi.getRequiredFreeSpace;
```

Use the `Simulink.sdi.getMaxDiskUsage` function to get the configured maximum size for data logged to disk. The returned value uses units of GB.

```
maxSize = Simulink.sdi.getMaxDiskUsage;
```

Use the `Simulink.sdi.deleteRunsOnLowSpace` function to get the configured behavior when approaching the logging limits. When `deleteRuns` is true, data from prior simulations is deleted first to free disk space for continued logging in the current simulation. If deleting runs does not free up enough space, recording logged data is disabled for the current simulation. When `deleteRuns` is false, recording logged data is disabled for the current simulation and data from prior simulations is retained.

```
deleteRuns = Simulink.sdi.deleteRunsOnLowSpace;
```

Output Arguments

maxSize — Maximum size configured for data logged to disk

scalar

Maximum size configured for data logged to disk, returned as a scalar, in units of GB.

See Also

Functions

[Simulink.sdi.setMaxDiskUsage](#) | [Simulink.sdi.setRequiredFreeSpace](#) |
[Simulink.sdi.getRequiredFreeSpace](#) | [Simulink.sdi.setDeleteRunsOnLowSpace](#) |
[Simulink.sdi.getDeleteRunsOnLowSpace](#) | [Simulink.sdi.setRecordData](#) |
[Simulink.sdi.getRecordData](#)

Topics

[“Limit the Size of Logged Data”](#)
[“Configure the Simulation Data Inspector”](#)

Introduced in R2021a

Simulink.sdi.getNumCursors

Check number of cursors active in the Simulation Data Inspector

Syntax

```
num = Simulink.sdi.getNumCursors
num = Simulink.sdi.getNumCursors(view)
```

Description

`num = Simulink.sdi.getNumCursors` returns the number of active cursors in the **Inspect** pane of the Simulation Data Inspector.

`num = Simulink.sdi.getNumCursors(view)` returns the number of active cursors in the **Inspect** or **Compare** pane of the Simulation Data Inspector, as specified by `view`.

Examples

Programmatically Interact with Cursors in the Simulation Data Inspector

You can use the Simulation Data Inspector programmatic interface to specify the position of cursors on time plots or sparklines and to access the time that corresponds to the current cursor position.

Open the session file `vdp_mu.mldatx` to add and plot data in the Simulation Data Inspector. The session file contains data for a 20-second simulation of a model of the Van Der Pol equation, with signals `x1` and `x2` plotted on separate subplots in a 2-by-1 subplot layout.

```
open vdp_mu.mldatx;
```

Use the `Simulink.sdi.setNumCursors` function to add one cursor to the plot.

```
Simulink.sdi.setNumCursors(1);
```

Suppose you want to know the signal values 5 seconds into the simulation. Use the `Simulink.sdi.setCursorPositions` function to move the cursor to `t=5s` and read the signal values off from the cursor on each subplot. The asterisk next to the value in the cursor label indicates that the value is interpolated because the simulation did not include a calculation for a simulation time of exactly 5s.

```
Simulink.sdi.setCursorPositions('left',5);
```

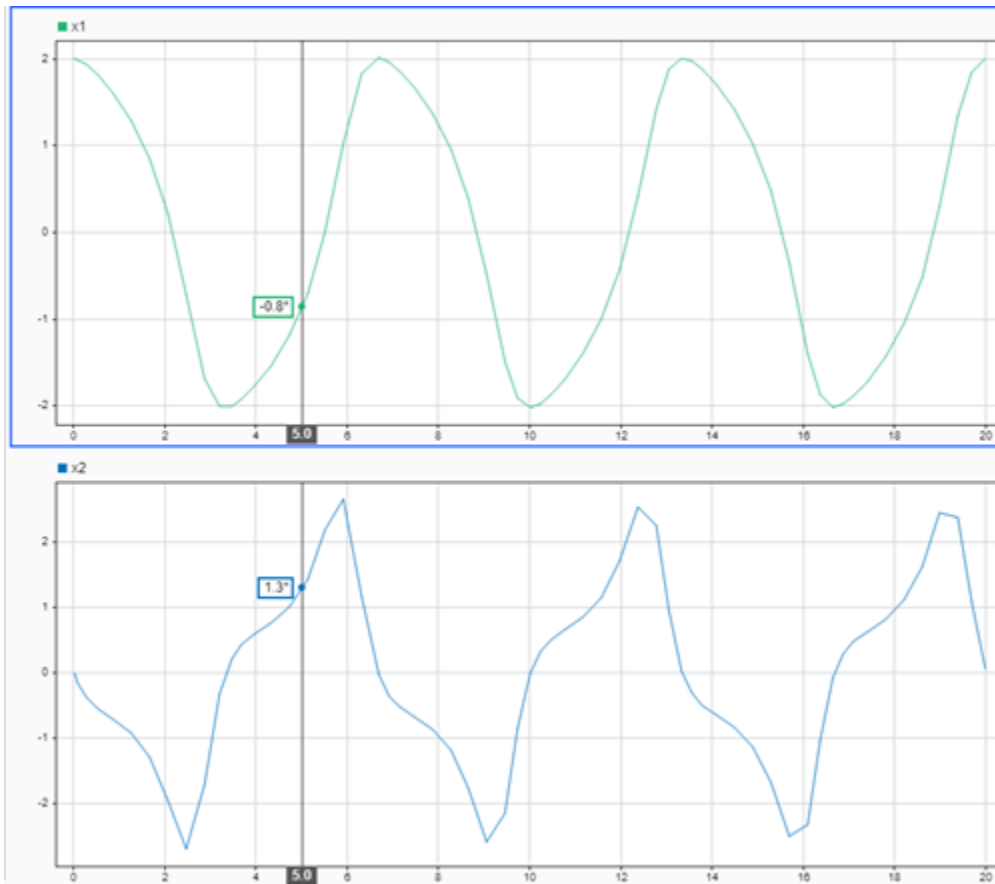

Suppose you want to calculate the time between two peaks in the x2 signal. Add a second cursor using the `Simulink.sdi.setNumCursors` function or using the **Show/hide data cursors** button in the Simulation Data Inspector.

```
numCursors = Simulink.sdi.getNumCursors;
if(numCursors < 2)
    Simulink.sdi.setNumCursors(2);
end
```

Drag the cursors so the left cursor is positioned at the first peak in the x2 signal and the right cursor is positioned at the second peak. Alternatively, run this code that positions the cursors for you.

```
Simulink.sdi.setCursorPositions('left',5.921998549931304,'right',12.378442136906246);
```

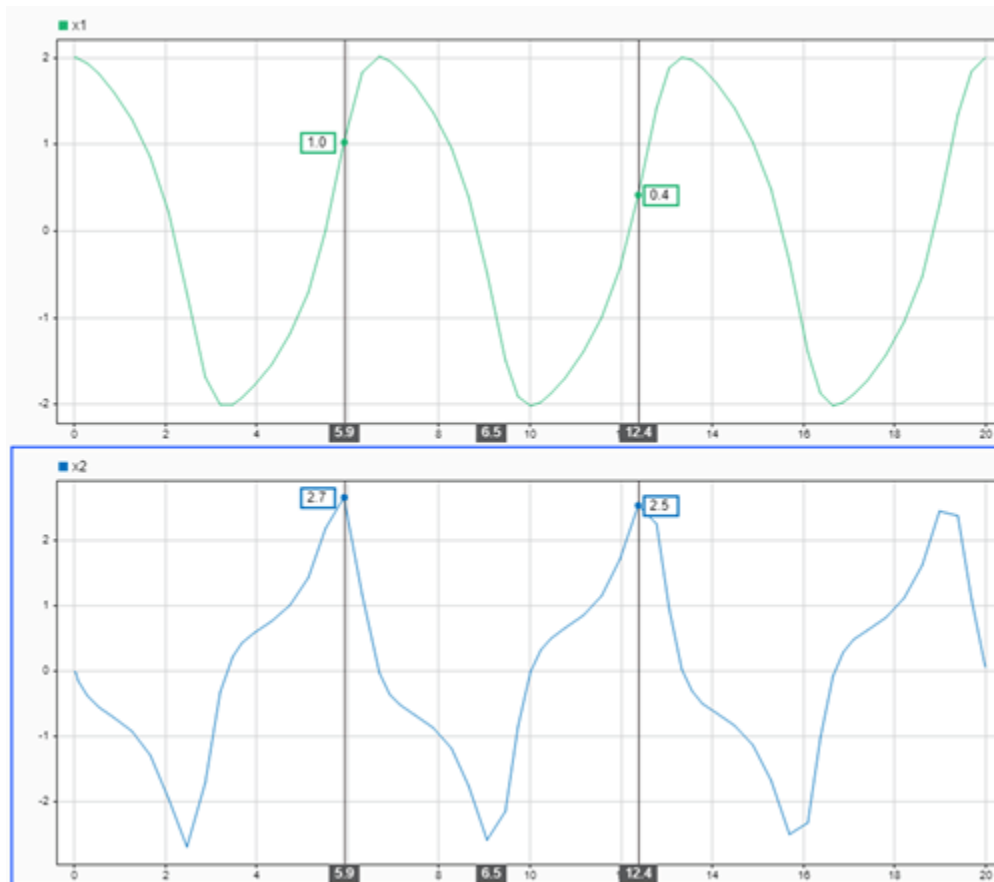

The Simulation Data Inspector displays the difference between the two cursors in seconds. However, the cursor position and difference values are both rounded. Use the `Simulink.sdi.getCursorPosition` function to programmatically retrieve the exact time values that correspond to the cursor positions. Then, compute the difference between the times.

```
[t1,t2] = Simulink.sdi.getCursorPosition;
T = t2 - t1
```

```
T = NaN
```

Input Arguments

view — Plot area for which to return number of active cursors

'inspect' (default) | 'compare'

Plot area for which to return number of active cursors, specified as 'inspect' or 'compare'.

Data Types: char | string

Output Arguments

num — Number of active cursors

0 | 1 | 2

Number of active cursors, returned as 0, 1, or 2.

See Also

Functions

`Simulink.sdi.getCursorPosition` | `Simulink.sdi.setNumCursors`

Topics

“Inspect Simulation Data”

“Create Plots Using the Simulation Data Inspector”

Introduced in R2021a

Simulink.sdi.getRecordData

Check record mode for logging

Syntax

```
record = Simulink.sdi.getRecordData
```

Description

`record = Simulink.sdi.getRecordData` returns the currently configured value for the **Record mode** in the Simulation Data Inspector preferences. When `record` is `true` or `1`, logged data is available to view during simulation and is recorded to the Simulation Data Inspector and workspace for analysis after simulation. When `record` is `false` or `0`, logged data is not recorded and is only available to view during simulation.

Examples

Check Record Mode for Logging

You can use the `Simulink.sdi.getRecordData` function to check the configuration before starting a simulation to ensure you record data you want to save.

```
record = Simulink.sdi.getRecordData
```

```
record =  
    logical  
     1
```

The **Record mode** setting is restored to **View and record data** at the start of each MATLAB session.

Output Arguments

`record` — Record mode

1 | 0

Record mode, returned as 1 (true) or 0 (false).

- 1 — Logged data is stored on disk and available in the workspace and Simulation Data Inspector after simulation.
- 0 — Logged data is not stored on disk and is only available to view during simulation. After simulation, no logged data is available in the Simulation Data Inspector or workspace. For more information, see “View Data Only During Simulation”.

See Also

Functions

`Simulink.sdi.setRecordData`

Topics

“Configure the Simulation Data Inspector”

“Specify Signal Values to Log”

Introduced in R2021a

Simulink.sdi.getRequiredFreeSpace

Get configured minimum disk space requirement for logging

Syntax

```
minDiskSpace = Simulink.sdi.getRequiredFreeSpace
```

Description

`minDiskSpace = Simulink.sdi.getRequiredFreeSpace` returns the minimum free disk space requirement configured for logging, in units of GB.

Examples

Get Configured Logging Size Limits

You can limit the size of logged data by specifying a maximum size for the data or a minimum amount of disk space to leave empty. This example uses several functions to get the current configuration of logging size limits.

Use the `Simulink.sdi.getRequiredFreeSpace` function to get the configured minimum free disk space requirement. The returned value uses units of GB.

```
minDiskSpace = Simulink.sdi.getRequiredFreeSpace;
```

Use the `Simulink.sdi.getMaxDiskUsage` function to get the configured maximum size for data logged to disk. The returned value uses units of GB.

```
maxSize = Simulink.sdi.getMaxDiskUsage;
```

Use the `Simulink.sdi.deleteRunsOnLowSpace` function to get the configured behavior when approaching the logging limits. When `deleteRuns` is true, data from prior simulations is deleted first to free disk space for continued logging in the current simulation. If deleting runs does not free up enough space, recording logged data is disabled for the current simulation. When `deleteRuns` is false, recording logged data is disabled for the current simulation and data from prior simulations is retained.

```
deleteRuns = Simulink.sdi.deleteRunsOnLowSpace;
```

Output Arguments

minDiskSpace — Minimum free disk space requirement for logging

scalar

Minimum free disk space requirement for logging, returned as a scalar, in units of GB.

See Also

Functions

`Simulink.sdi.setRequiredFreeSpace` | `Simulink.sdi.setMaxDiskUsage` |
`Simulink.sdi.getMaxDiskUsage` | `Simulink.sdi.setDeleteRunsOnLowSpace` |
`Simulink.sdi.getDeleteRunsOnLowSpace` | `Simulink.sdi.setRecordData` |
`Simulink.sdi.getRecordData`

Topics

“Limit the Size of Logged Data”
“Configure the Simulation Data Inspector”

Introduced in R2021a

Simulink.sdi.getRun

Package: Simulink.sdi

Access data for a Simulation Data Inspector run

Syntax

```
run = Simulink.sdi.getRun(runID)
```

Description

`run = Simulink.sdi.getRun(runID)` returns a `Simulink.sdi.Run` object that provides access to the data in the run corresponding to the `runID`. The Simulation Data Inspector assigns run IDs when it creates a run. You can get the run ID for your run using `Simulink.sdi.getAllRunIDs` or `Simulink.sdi.getRunIDByIndex`.

Examples

Access Simulation Data Inspector Runs

Many tasks performed using the Simulation Data Inspector programmatic interface start by accessing the `Simulink.sdi.Run` object that corresponds to the logged or imported data you want to analyze. For example, you can use the Run object to access the `Simulink.sdi.Signal` objects that correspond to individual signals in the run.

This example shows how to access Run objects by using the `Simulink.sdi.Run.getLatest` function, the `Simulink.sdi.getCurrentSimulationRun` function, or the `Simulink.sdi.getRun` function.

Create a Run

The model `sldemo_fuelsys` is already configured for logging. When you simulate the model, the Simulation Data Inspector automatically creates a run and assigns it a run ID.

```
load_system('sldemo_fuelsys')
sim('sldemo_fuelsys')
```

Get Run Object Using Simulink.sdi.Run.getLatest

In this example, the run created when you simulated the model is the most recently created run in the Simulation Data Inspector. When you want to access the most recently created run, use the `Simulink.sdi.Run.getLatest` function.

```
fuelsysRun = Simulink.sdi.Run.getLatest;
```

Get Run Object Using Simulink.sdi.getCurrentSimulationRun

The run you want to access may not be the most recently created run in the Simulation Data Inspector. If the run corresponds to the most recent simulation of a model, you can use the `Simulink.sdi.getCurrentSimulationRun` function to access the Run object. You can also use

the `Simulink.sdi.getCurrentSimulationRun` function to access data for an in-progress simulation when the simulation streams data to the Simulation Data Inspector. This function can be useful when you are working with multiple models.

In this example, the run created when you simulated the model is the current simulation run for the `sldemo_fuelsys` model.

```
fuelsysRun = Simulink.sdi.getCurrentSimulationRun('sldemo_fuelsys');
```

Get Run Object from a Run ID

When your task also requires the run ID, you can use the `Simulink.sdi.getRun` function to get the corresponding `Simulink.sdi.Run` object that contains the run data and metadata.

```
runIDs = Simulink.sdi.getAllRunIDs;  
runID = runIDs(end);  
fuelsysRun = Simulink.sdi.getRun(runID);
```

Plot Signals from Simulation Run

This example demonstrates how to access the `Simulink.sdi.Run` object for a Simulation Data Inspector run created by logging signals. From the `Simulink.sdi.Run` object you can get `Simulink.sdi.Signal` objects that contain the logged signal data and metadata. You can use the `Signal` objects and the `plotOnSubPlot` function to plot the data in the Simulation Data Inspector.

Create a Simulation Run and Access the Run Object

The `ex_vdp` model logs two signals. To create a simulation run containing the logged data, simulate the model.

```
sim('ex_vdp');
```

The Simulation Data Inspector keeps track of runs by assigning a unique numeric run ID to each run created by simulation, importing data, or opening a session. To access the run object for the simulation you just performed, use the `Simulink.sdi.getAllRunIDs` function and take the last run ID in the returned vector.

```
runIDs = Simulink.sdi.getAllRunIDs;  
runID = runIDs(end);
```

Once you have the run ID for the run, you can use the `Simulink.sdi.getRun` function to get the `Simulink.sdi.Run` object that corresponds to the run. You can use the `Run` object to check the metadata associated with the run, including the number of signals in the run.

```
vdpRun = Simulink.sdi.getRun(runID);
```

```
vdpRun.SignalCount
```

```
ans = int32  
     2
```

Plot Data Using Signal Objects

Use the `getSignalByIndex` function to access signals from the `Run` object, `fuelRun`.

```
signal1 = getSignalByIndex(vdpRun,1);  
signal2 = getSignalByIndex(vdpRun,2);
```

Use the `Simulink.sdi.setSubPlotLayout` function to specify a 3-by-1 layout.

```
Simulink.sdi.setSubPlotLayout(2,1)
```

Before plotting the data, use the `Simulink.sdi.clearAllSubPlots` function to clear any data that is already plotted.

```
Simulink.sdi.clearAllSubPlots
```

Plot one signal on each subplot. To plot signals on the first subplot, you can set the checked property for the signal. To plot signals on subplots other than the first subplot, use the `plotOnSubPlot` function.

```
signal1.Checked = true;  
plotOnSubPlot(signal2,2,1,true);
```

View the Plotted Data

To view the plots you just created, open the Simulation Data Inspector using the `Simulink.sdi.view` function.

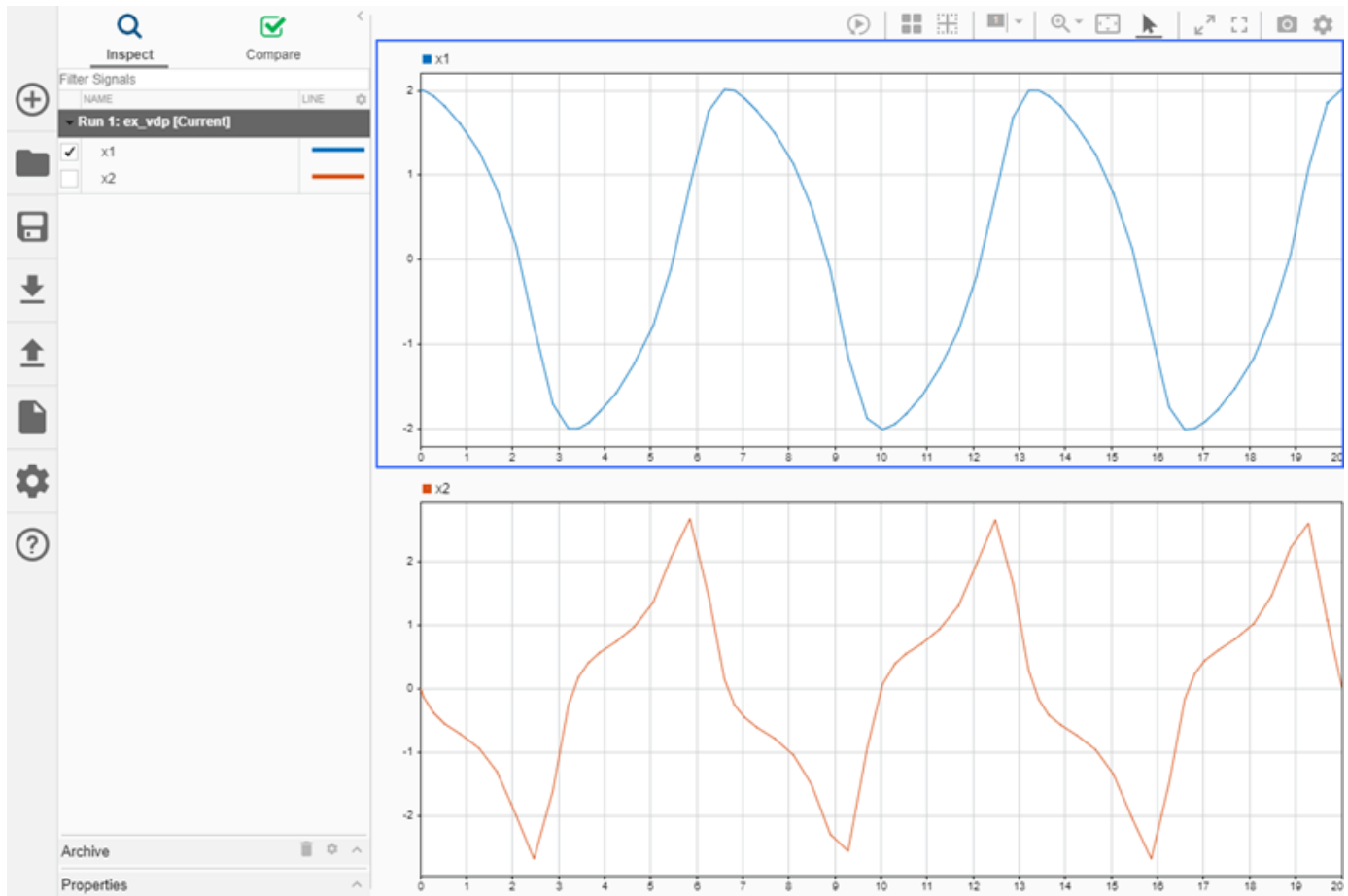

Input Arguments

runID — Numeric run identifier

scalar

Run ID for the run you want a `Simulink.sdi.Run` object for. The Simulation Data Inspector assigns run IDs when it creates runs. You can get the run ID for a run using `Simulink.sdi.getAllRunIDs` or `Simulink.sdi.getRunIDByIndex`.

Output Arguments

run — `Simulink.sdi.Run` object

'`Simulink.sdi.Run`'

`Simulink.sdi.Run` object for the run corresponding to the run ID.

See Also

`Simulink.sdi.getCurrentSimulationRun` | `Simulink.sdi.Run.getLatest` |
`Simulink.sdi.Run` | `Simulink.sdi.getAllRunIDs` | `Simulink.sdi.getRunIDByIndex` |
`Simulink.sdi.createRun`

Topics

“Inspect and Compare Data Programmatically”

Introduced in R2011b

Simulink.sdi.getRunCount

Package: Simulink.sdi

Get number of runs in Simulation Data Inspector repository

Syntax

```
count = Simulink.sdi.getRunCount
```

Description

`count = Simulink.sdi.getRunCount` returns the number of runs in the Simulation Data Inspector repository. You can use the run count to loop over all runs in the Simulation Data Inspector repository to modify run or signal properties. For example, you could add an absolute tolerance to a signal in every run.

Examples

Apply a Tolerance to a Signal in Multiple Runs

You can use the Simulation Data Inspector programmatic interface to modify a parameter for the same signal in multiple runs. This example adds an absolute tolerance of 0.1 to a signal in all four runs of data.

First, clear the workspace and load the Simulation Data Inspector session with the data. The session includes logged data from four simulations of a Simulink® model of a longitudinal controller for an aircraft.

```
Simulink.sdi.clear  
Simulink.sdi.load('AircraftExample.mldatx');
```

Use the `Simulink.sdi.getRunCount` function to get the number of runs in the Simulation Data Inspector. You can use this number as the index for a for loop that operates on each run.

```
count = Simulink.sdi.getRunCount;
```

Then, use a for loop to assign the absolute tolerance of 0.1 to the first signal in each run.

```
for a = 1:count  
    runID = Simulink.sdi.getRunIDByIndex(a);  
    aircraftRun = Simulink.sdi.getRun(runID);  
    sig = getSignalByIndex(aircraftRun,1);  
    sig.AbsTol = 0.1;  
end
```

Output Arguments

count — Number of runs

scalar

Number of runs in the Simulation Data Inspector repository.

See Also

[Simulink.sdi.getRunIDByIndex](#) | [Simulink.sdi.getAllRunIDs](#) | [Simulink.sdi.getRun](#) | [Simulink.sdi.Run](#) | [Simulink.sdi.Signal](#)

Topics

[“Inspect and Compare Data Programmatically”](#)

Introduced in R2011b

Simulink.sdi.getRunIDByIndex

Package: Simulink.sdi

Use Simulation Data Inspector run index to get run ID

Syntax

```
runID = Simulink.sdi.getRunIDByIndex(index)
```

Description

`runID = Simulink.sdi.getRunIDByIndex(index)` returns the run ID for the run with the specified index in the Simulation Data Inspector repository.

Examples

Get Simulation Data Inspector Run IDs

Many tasks performed using the Simulation Data Inspector programmatic interface start with obtaining the run ID for a simulation run. This example illustrates several methods to get the run ID for a run. You can use the run ID to access the `Simulink.sdi.Run` object that contains the run data and metadata and perform run comparisons using the `Simulink.sdi.compareRuns` function.

Create a Run

The model `sldemo_fuelsys` is already configured for logging. When you simulate the model, the Simulation Data Inspector automatically creates a run and assigns it a run ID.

```
load_system('sldemo_fuelsys')  
sim('sldemo_fuelsys')
```

Get Run ID Using Simulink.sdi.getAllRunIDs

The `Simulink.sdi.getAllRunIDs` function returns an array of all run IDs for the runs in the Simulation Data Inspector repository, in order, with the most recently created run at the end.

```
runIDs = Simulink.sdi.getAllRunIDs;  
runID = runIDs(end);
```

Get Run ID Using Simulink.sdi.getRunIDByIndex

You can also use the `Simulink.sdi.getRunCount` and `Simulink.sdi.getRunIDByIndex` functions to get the run ID for a run. This method is useful if you also want to use `count` as a counting variable to index through the runs in the Simulation Data Inspector repository.

```
count = Simulink.sdi.getRunCount;  
runID = Simulink.sdi.getRunIDByIndex(count);
```

Get Run ID from a Simulink.sdi.Run Object

You can also get the run ID from the `Simulink.sdi.Run` object that corresponds to the run. This example uses the `Simulink.sdi.getCurrentSimulationRun` function to get the Run object that

corresponds to the most recent simulation of the `sldemo_fuelsys` model. You can also use the `Simulink.sdi.Run.getLatest` function to access the most recently created Run object.

```
fuelsysRun = Simulink.sdi.getCurrentSimulationRun('sldemo_fuelsys');  
runID = fuelsysRun.ID;
```

Input Arguments

index — Run index in Simulation Data Inspector

integer

Positive, whole number index of the run in the Simulation Data Inspector repository.

Example: 3

Output Arguments

runID — Numeric run identifier

scalar

Numeric run identification assigned by the Simulation Data Inspector.

See Also

`Simulink.sdi.getRun` | `Simulink.sdi.compareRuns` | `Simulink.sdi.Run` |
`Simulink.sdi.copyRun` | `Simulink.sdi.deleteRun` | `Simulink.sdi.getRunCount` |
`Simulink.sdi.isValidRunID`

Topics

“Inspect and Compare Data Programmatically”

Introduced in R2011b

Simulink.sdi.getRunNamingRule

Package: Simulink.sdi

Get the Simulation Data Inspector rule for naming runs

Syntax

```
namingRule = Simulink.sdi.getRunNamingRule
```

Description

`namingRule = Simulink.sdi.getRunNamingRule` returns the run naming rule as a character vector. The run naming rule can contain one or more tokens that update for each run, for example, `<run_index>`. The run naming rule applies to runs automatically created through simulating a model in Simulink.

Examples

Modify Run Naming Rule Then Restore Default

This example shows how to use the Simulation Data Inspector API to modify the Simulation Data Inspector run naming rule, check a run's name, restore default preferences, and check the run naming rule.

```
% Load model
load_system('sldemo_fuelsys')

% Modify run naming rule
Simulink.sdi.setRunNamingRule('<model_name> Run <run_index>')

% Simulate system
sim('sldemo_fuelsys')

% Check run name
runIDs = Simulink.sdi.getAllRunIDs;
runID = runIDs(end);
fuelRun = Simulink.sdi.getRun(runID);
fuelRun.name

ans =
'sldemo_fuelsys Run 1'

% Clear preferences to reset the run naming rule
Simulink.sdi.clearPreferences

% Check run naming rule
Simulink.sdi.getRunNamingRule

ans =
'Run <run_index>: <model_name>'
```

Output Arguments

namingRule — Naming rule for Simulation Data Inspector runs

character vector

Character vector that specifies the naming rule the Simulation Data Inspector uses to name the runs automatically created through simulating a Simulink model. The run naming rule can contain any of the following tokens that represent information pulled for each run:

- `<run_index>` - Run's index in the Simulation Data Inspector repository.
- `<model_name>` - Name of the model simulated to create the run.
- `<time_stamp>` - Start time for the simulation that created the run.
- `<sim_mode>` - Simulation mode used for the simulation that created the run.

Alternatives

You can view the run naming rule using the Simulation Data Inspector UI. You can find the **New Run** options under the Simulation Data Inspector **Preferences** menu.

See Also

[Simulink.sdi.setRunNamingRule](#) | [Simulink.sdi.resetRunNamingRule](#) | [Simulink.sdi.Run](#) | [Simulink.sdi.clearPreferences](#)

Topics

“Inspect and Compare Data Programmatically”

Introduced in R2015a

Simulink.sdi.getSignal

Package: Simulink.sdi

Get Simulink.sdi.Signal object for a signal

Syntax

```
signalObj = Simulink.sdi.getSignal(sigID)
```

Description

`signalObj = Simulink.sdi.getSignal(sigID)` returns a `Simulink.sdi.Signal` object for the signal in the Simulation Data Inspector that corresponds to the signal ID, `sigID`.

Examples

Create a Simulation Data Inspector Run and Access Signal Data

This example shows how to access signal data when you create a run in the Simulation Data Inspector.

Generate Data for Run

For this example, create timeseries data for sine and cosine signals.

```
% Create timeseries workspace data
time = linspace(0, 20, 101);

sine_vals = sin(2*pi/5*time);
sine_ts = timeseries(sine_vals,time);
sine_ts.Name = 'Sine, T=5';

cos_vals = cos(2*pi/8*time);
cos_ts = timeseries(cos_vals,time);
cos_ts.Name = 'Cosine, T=8';
```

Create a Run and Return Signal IDs

You can use the `Simulink.sdi.createRun` syntax with multiple return arguments to get the signal IDs more directly instead of accessing the signal IDs through a `Simulink.sdi.Run` object.

```
[runID,runIndex,sigIDs] = Simulink.sdi.createRun('Sinusoids','vars',...
    sine_ts,cos_ts);

cosID = sigIDs(2);
cosSig = Simulink.sdi.getSignal(cosID);
```

Modify Signal Properties and View in the Simulation Data Inspector

You can use the `Simulink.sdi.Signal` object to view and modify signal properties and to plot signals in the Simulation Data Inspector.

```
cosSig.Checked = true;  
cosSig.AbsTol = 0.05;  
Simulink.sdi.view  
cosSig.Name
```

Input Arguments

sigID — Signal ID

scalar

Unique, numeric signal identifier, specified as an integer. The Simulation Data Inspector assigns a signal ID to each signal when a run is created. You can get the signal ID for a signal using one of these functions:

- `getAllSignalIDs`
- `getSignalIDByIndex`
- `getSignalIDsByName`
- `Simulink.sdi.createRun`

Output Arguments

signalObj — `Simulink.sdi.Signal` object

`Simulink.sdi.Signal` object

Signal that corresponds to the signal ID, `sigID`, returned as a `Simulink.sdi.Signal` object.

See Also

Objects

`Simulink.sdi.Signal` | `Simulink.sdi.Run`

Functions

`getSignalIDByIndex` | `Simulink.sdi.createRun`

Topics

“Inspect and Compare Data Programmatically”

Introduced in R2011b

Simulink.sdi.getSignalInputProcessingMode

Get setting of Input Processing signal property

Syntax

```
inputMode = Simulink.sdi.getSignalInputProcessingMode(blkPath,port)
inputMode = Simulink.sdi.getSignalInputProcessingMode(h)
```

Description

`inputMode = Simulink.sdi.getSignalInputProcessingMode(blkPath,port)` returns the setting for the **Input Processing** property for the signal at the specified block and port.

The **Input Processing** setting affects the format of the logged data and how the Simulation Data Inspector and dashboard blocks display the signal. You can configure a signal for frame-based or sample-based input processing.

`inputMode = Simulink.sdi.getSignalInputProcessingMode(h)` returns the setting for the **Input Processing** property for the signal corresponding to the specified line handle, `h`.

Examples

Check Signal Input Processing Setting Using Block Path

Check the setting for the **Input Processing** property of a signal using the block path and output port number for the block that produces the signal.

```
open_system('vdp')
MuInputProc = Simulink.sdi.getSignalInputProcessingMode('vdp/Mu');
```

Check Signal Input Processing Setting Using Line Handle

Check the setting for the **Input Processing** property of a signal using the line handle for the signal.

```
open_system('vdp')
MuLineHandles = get_param('vdp/Mu','LineHandles');
MuOutputHandle = MuLineHandles.Outputport;
MuInputProc = Simulink.sdi.getSignalInputProcessingMode(MuOutputHandle);
```

Input Arguments

blkPath — Block path for block that produces signal

string | character array

Block path for the block that produces the signal, specified as a string or character array.

Example: "vdp/Mu"

port — Number of block output port connected to signal

scalar

Block output port number for the port that produces the signal.

Example: 1

h — Signal line handle

handle

Line handle for the signal, specified as a handle to the signal line. You can get the line handle for a signal using the `get_param` function with the 'LineHandles' option. For example, to access the line handle for the output of the Mu block in the model vdp, use:

```
MuLineHandles = get_param('vdp/Mu','LineHandles');
MuOutputLineHandle = MuLineHandles.Outputport;
```

Example: MuOutputLineHandle

Output Arguments**inputMode — Input processing setting of the signal**

"sample" | "frame"

Signal **Input Processing** setting.

- `sample` — Sample-based input processing, where each element in a sample is treated as a channel.
- `frame` — Frame-based input processing, where each column in a sample is treated as a channel.

See Also

`get_param` | `Simulink.sdi.markSignalForStreaming` | `Simulink.sdi.setSignalInputProcessingMode`

Introduced in R2020a

Simulink.sdi.getStorageLocation

Get path to custom storage location for data logged to disk

Syntax

```
storagePath = Simulink.sdi.getStorageLocation
```

Description

`storagePath = Simulink.sdi.getStorageLocation` returns the configured custom location to store data logged to disk. When data logs to the temporary directory on your computer, the `Simulink.sdi.getStorageLocation` function returns an empty character array.

Note The location returned by the `Simulink.sdi.getStorageLocation` function applies for data logged to the workspace and Simulation Data Inspector and is *not* the location of the file created for data logged to a file.

Examples

Check Custom Storage Location

By default, data logged to the workspace and the Simulation Data Inspector is stored in the temporary directory on your computer. You may want to change the location of logged data when you need to log large amounts of data and a secondary drive provides more storage capacity. When you specify a custom storage location for logged data, you can use the `Simulink.sdi.getStorageLocation` function to access the path to the temporary file that contains the logged data.

```
storagePath = Simulink.sdi.getStorageLocation;  
storagePath =  
    'C:\Users\username\LoggedData'
```

Output Arguments

storagePath — Location of data logged to disk

character vector

Location of data logged to disk, returned as a character vector. An empty character vector indicates that the data is logged to the temporary directory on your computer.

See Also

Functions

`Simulink.sdi.setStorageLocation` | `Simulink.sdi.setStorageMode` | `Simulink.sdi.getStorageMode`

Topics

“Configure the Simulation Data Inspector”

Introduced in R2021a

Simulink.sdi.getStorageMode

Check if logging is configured to log data to disk or memory

Syntax

```
storageMode = Simulink.sdi.getStorageMode
```

Description

`storageMode = Simulink.sdi.getStorageMode` returns the configured logging storage mode as 'disk' or 'memory'. By default, data logged to the workspace and the Simulation Data Inspector is logged to disk.

Examples

Check Whether Data Logs to Disk or Memory

You can configure whether data logged in simulation logs to memory or to disk. By default, data is logged to disk and brought into memory on demand. If your machine has more RAM than disk space, you may want to log data to memory instead.

Use the `Simulink.sdi.getStorageMode` function to check whether logging is configured to store logged data on disk or in memory.

```
storageMode = Simulink.sdi.getStorageMode
```

```
storageMode =  
    'disk'
```

Output Arguments

storageMode — Where logged simulation data is stored on your machine

'disk' | 'memory'

Where logged simulation data is stored on your machine, returned as 'disk' or 'memory'.

See Also

Functions

`Simulink.sdi.setStorageMode` | `Simulink.sdi.setStorageLocation` | `Simulink.sdi.getStorageLocation`

Topics

“Configure the Simulation Data Inspector”

Introduced in R2021a

Simulink.sdi.getSubplotLimits

Get t - and y -axis limits for time plot in the Simulation Data Inspector

Syntax

```
[tMin,tMax,yMin,yMax] = Simulink.sdi.getSubplotLimits(r,c)
```

Description

`[tMin,tMax,yMin,yMax] = Simulink.sdi.getSubplotLimits(r,c)` returns the t - and y -axis limits for the subplot at the specified location in the Simulation Data Inspector subplot layout.

Examples

Copy y -Axis Range from One Subplot to Another

You can use the `Simulink.sdi.getSubplotLimits` and `Simulink.sdi.setSubplotLimits` functions to copy the axis limits from one subplot to another. For example, you can specify the same y -axis limits for two subplots that display the same signal from simulations that used different values of a model parameter. This example copies the y -axis settings from one subplot to another to analyze the effect of changing the value of μ in the model `vdp`.

Create the data in the Simulation Data Inspector by simulating the model `vdp` twice. The first time, specify the value of μ as 1. For the second simulation, set the value of μ to 2. The model logs data for the signals `x1` and `x2`.

```
open_system('ex_vdp');  
set_param('ex_vdp/Mu', 'Gain', '1')  
sim('ex_vdp');  
  
set_param('ex_vdp/Mu', 'Gain', '2');  
sim('ex_vdp');
```

Create plots in the Simulation Data Inspector to show the results from each simulation. Configure a 2x2 subplot layout so you can plot one signal on each plot, side by side.

```
Simulink.sdi.setSubPlotLayout(2,2)
```

Get the `Simulink.sdi.Signal` objects that correspond to each signal from each run, and plot one signal on each subplot. Plot the signals from the first simulation on the subplots in the first column and the signals from the second simulation on the subplots in the second column.

```
runIDs = Simulink.sdi.getAllRunIDs;  
runID1 = runIDs(end-1);  
runID2 = runIDs(end);  
  
runMu1 = Simulink.sdi.getRun(runID1);  
runMu2 = Simulink.sdi.getRun(runID2);  
  
sig1 = getSignalByIndex(runMu1,1);
```

```
sig2 = getSignalByIndex(runMu1,2);
sig3 = getSignalByIndex(runMu2,1);
sig4 = getSignalByIndex(runMu2,2);
```

```
plotOnSubPlot(sig1,1,1,true);
plotOnSubPlot(sig2,2,1,true);
plotOnSubPlot(sig3,1,2,true);
plotOnSubPlot(sig4,2,2,true);
```

The signals in the first column of plots look similar to those in the second column. However, the y-axis limits for the plots of the x2 signal are different.

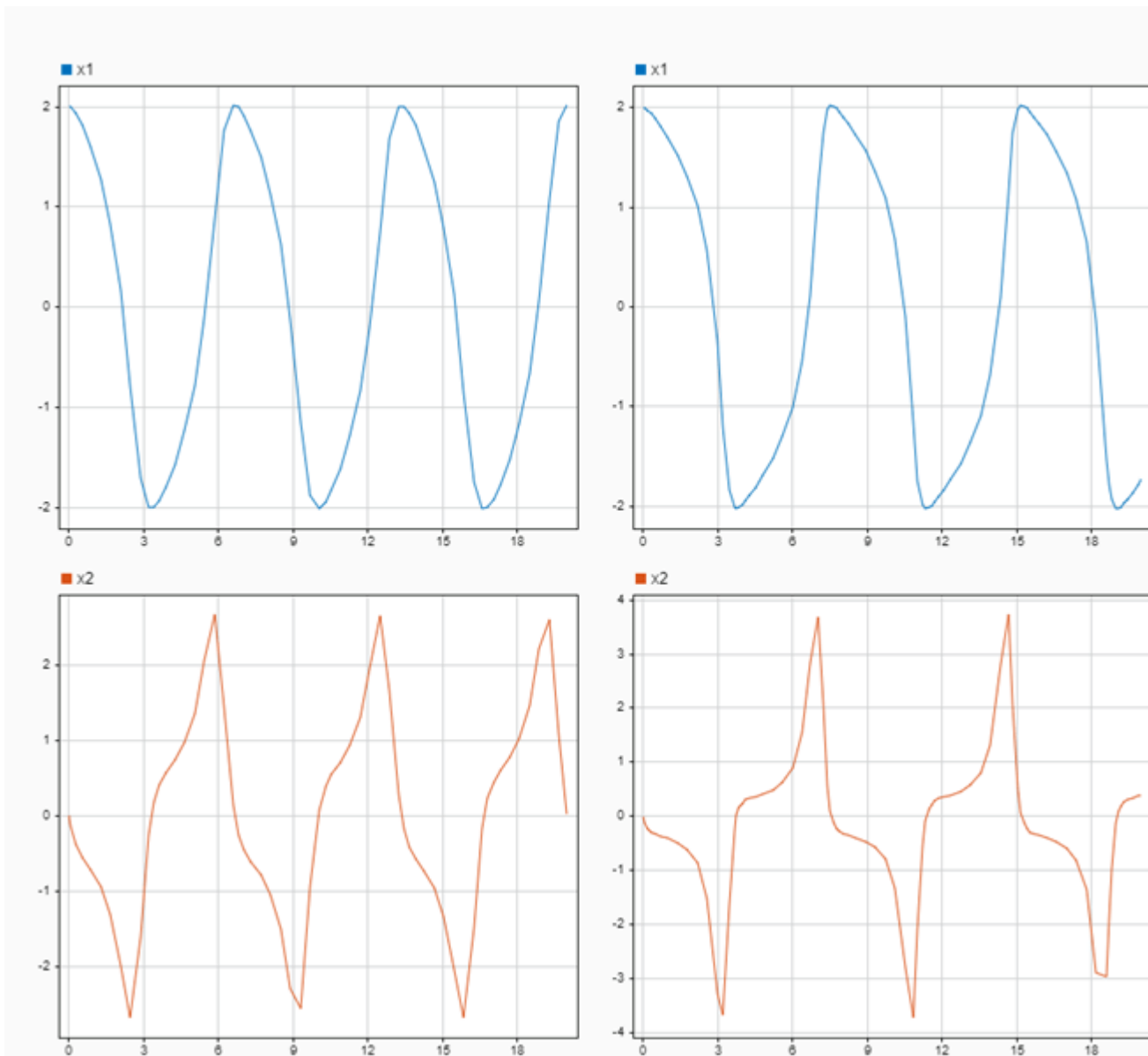

Use the `Simulink.sdi.getSubplotLimits` function to copy the limits used for the subplot with the x2 signal from the second simulation.

```
[~,~,ymin,ymax] = Simulink.sdi.getSubplotLimits(2,2);
```

Use the `Simulink.sdi.setSubplotLimits` function to apply the same y-axis limits to the subplot with the `x2` signal from the first run.

```
Simulink.sdi.setSubplotLimits(2,1,'yRange',[ymin,ymax]);
```

With the updated y-axis limits, the difference in the `x2` signal is more apparent.

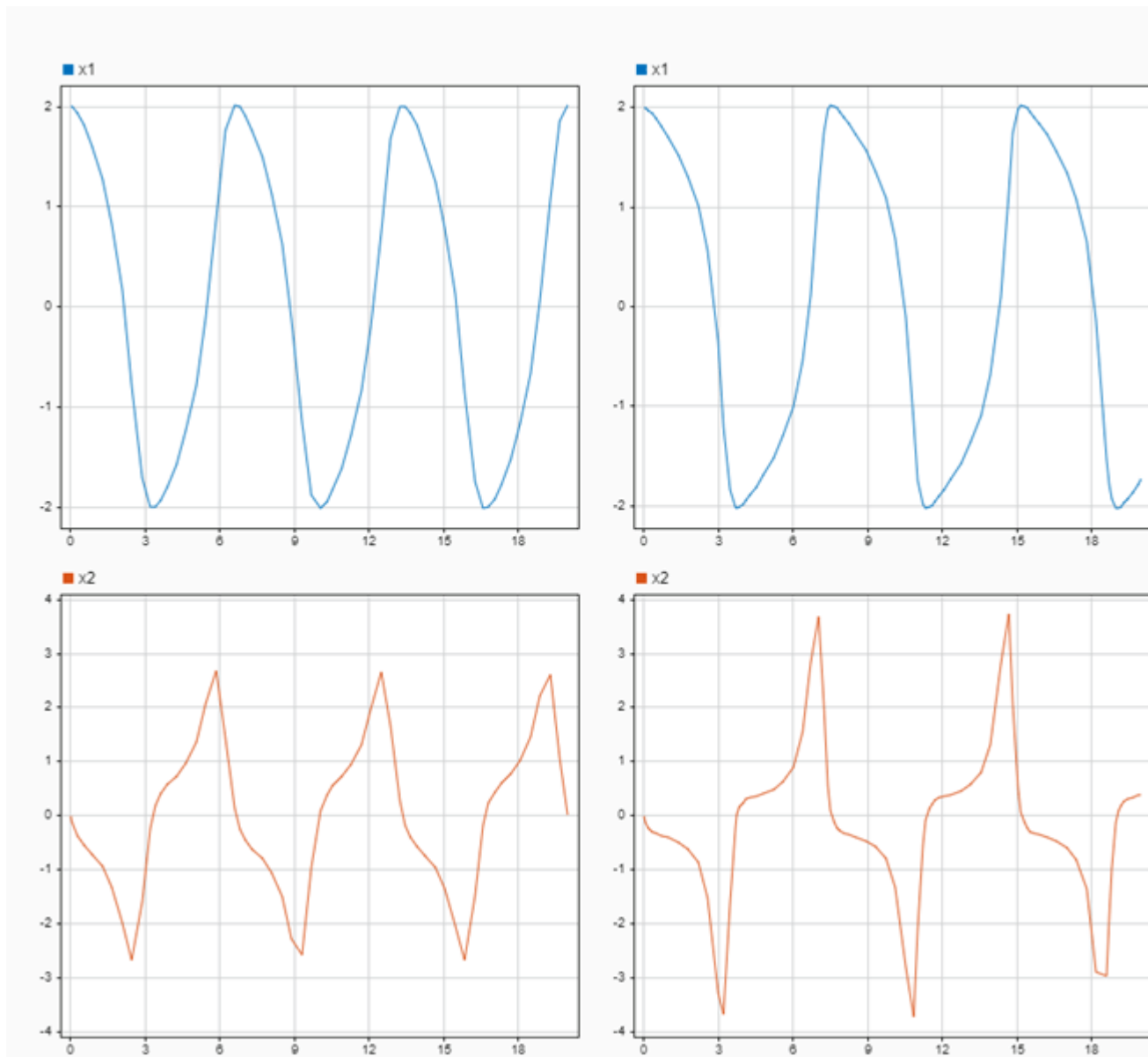

Input Arguments

r — Subplot row index
integer

Subplot row index, specified as an integer between 1 and 8, inclusive. Use the `r` and `c` inputs together to specify the location of the subplot for which you want the axis limits.

Example: `[~,~,yMin,yMax] = Simulink.sdi.setSubplotLimits(2,2)` returns `y`-axis limits for the time plot in the second row of the second column of the subplot layout in the Simulation Data Inspector.

c — Subplot column index

integer

Subplot column index, specified as an integer value between 1 and 8, inclusive. Use the `r` and `c` inputs together to specify the location of the subplot for which you want the axis limits.

Example: `[~,~,yMin,yMax] = Simulink.sdi.setSubplotLimits(2,2)` returns the `y`-axis limits for the time plot in the second row of the second column of the subplot layout in the Simulation Data Inspector.

Output Arguments

tMin — t-axis minimum

double

`t`-axis minimum, returned as a double and the first element in a 1-by-4 vector of the form `[tMin, tMax, yMin, yMax]`.

tMax — t-axis maximum

double

`t`-axis maximum, returned as a double and the second element in a 1-by-4 vector of the form `[tMin, tMax, yMin, yMax]`.

yMin — y-axis minimum

double

`y`-axis minimum, returned as a double and the third element in a 1-by-4 vector of the form `[tMin, tMax, yMin, yMax]`.

yMax — y-axis maximum

double

`y`-axis maximum, returned as a double and the last element in a 1-by-4 vector of the form `[tMin, tMax, yMin, yMax]`.

See Also

Functions

[Simulink.sdi.setSubplotLimits](#) | [Simulink.sdi.setSubPlotLayout](#) | [Simulink.sdi.getBorderOn](#) | [Simulink.sdi.getGridOn](#) | [Simulink.sdi.getMarkersOn](#) | [Simulink.sdi.getTickLabelsDisplay](#) | [Simulink.sdi.getTicksPosition](#)

Objects

[Simulink.sdi.Run](#) | [Simulink.sdi.Signal](#)

Topics

“Create Plots Using the Simulation Data Inspector”

“Inspect Simulation Data”

Introduced in R2021a

Simulink.sdi.getTickLabelsDisplay

Get tick mark label setting for time plots

Syntax

```
tickLabels = Simulink.sdi.getTickLabelsDisplay
```

Description

`tickLabels = Simulink.sdi.getTickLabelsDisplay` returns the current setting for displayed tick mark labels on time plots in the Simulation Data Inspector. The return value corresponds to the value of the **Tick labels** setting on the **Time Plot** section of the **Visualization Settings** in the Simulation Data Inspector. The setting applies to all time plots in the layout. By default, the Simulation Data Inspector displays tick mark labels for both axes on time plots.

Examples

Configure Tick Mark Label Visibility for Time Plots

You can use the `Simulink.sdi.setTickLabelsDisplay` function to configure the visibility of tick mark labels for the t - and y -axes on time plots in the Simulation Data Inspector. By default, the Simulation Data Inspector displays tick marks for both axes.

This example starts by showing how to use the `Simulink.sdi.getTickLabelsDisplay` function to access the current tick mark label visibility. Subsequent sections show the code to specify each available option for tick mark label visibility on time plots in the Simulation Data Inspector. To see the result of each configuration, the example generates an image using the `Simulink.sdi.snapshot` function with settings specified by a `Simulink.sdi.CustomSnapshot` object.

```
snapSettings = Simulink.sdi.CustomSnapshot;  
snapSettings.Width = 300;  
snapSettings.Height = 300;
```

Get Current Tick Mark Label Visibility

Before modifying the visibility of the tick mark labels on time plots, you can save the current configuration to a variable in the workspace in case you want to restore the preference later.

```
initTickLabels = Simulink.sdi.getTickLabelsDisplay;
```

Show Only t -Axis Tick Mark Labels

Show the tick mark labels for the t -Axis.

```
Simulink.sdi.setTickLabelsDisplay('t-axis')  
Simulink.sdi.snapshot('from','custom','settings',snapSettings);
```

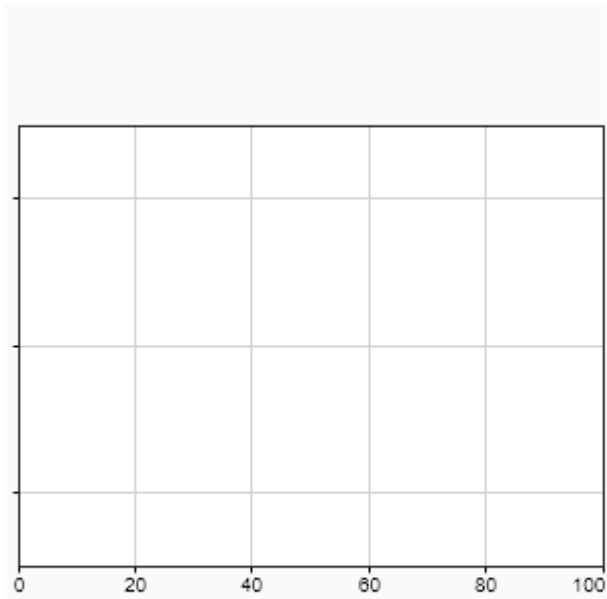

Show Only y-Axis Tick Mark Labels

Show the tick mark labels for the y-axis.

```
Simulink.sdi.setTickLabelsDisplay('y-axis')  
Simulink.sdi.snapshot('from', 'custom', 'settings', snapSettings);
```

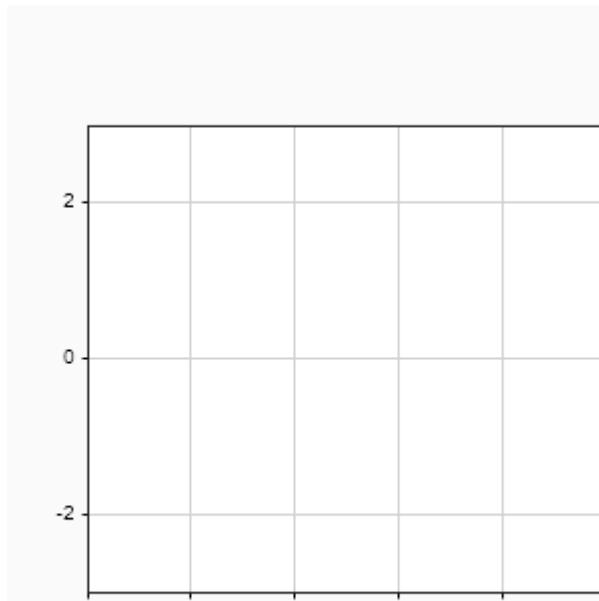

Hide Tick Mark Labels

You can hide the tick mark labels for both axes.

```
Simulink.sdi.setTickLabelsDisplay('none')  
Simulink.sdi.snapshot('from', 'custom', 'settings', snapSettings);
```

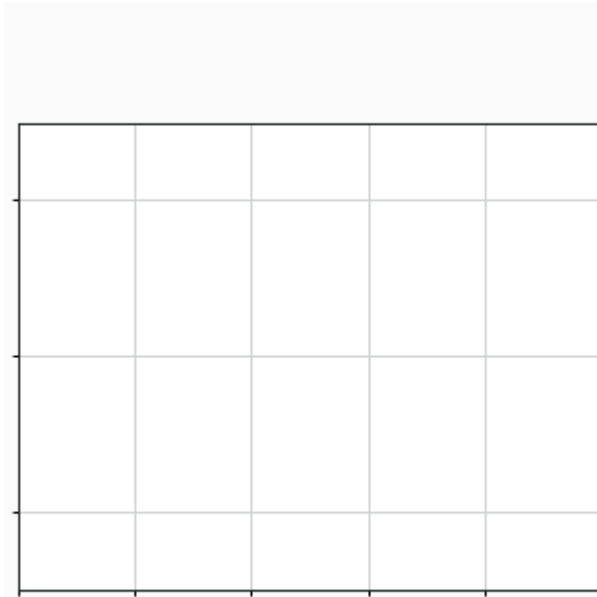

Show All Tick Mark Labels

By default, the Simulation Data Inspector shows tick mark labels for both axes on time plots.

```
Simulink.sdi.setTickLabelsDisplay('all')  
Simulink.sdi.snapshot('from', 'custom', 'settings', snapSettings);
```

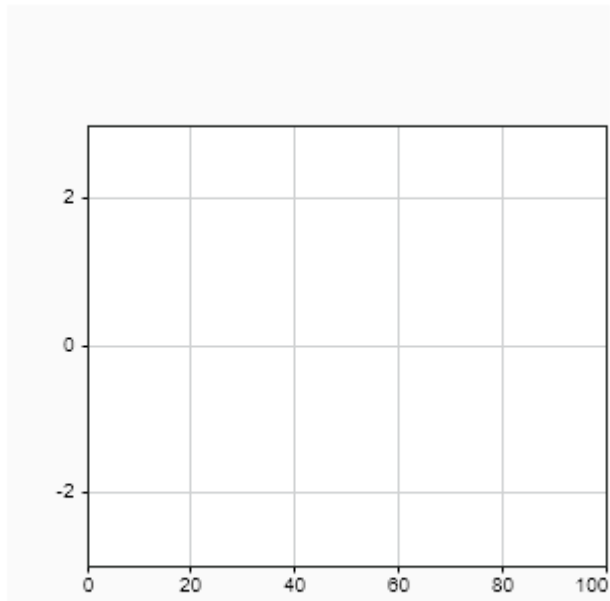

Output Arguments

tickLabels — Time plot axes that display tick mark labels

'all' | 't-axis' | 'y-axis' | 'none'

Time plot axes that display tick mark labels in the Simulation Data Inspector, returned as one of these options:

- 'all' — Tick mark labels displayed for both time plot axes.
- 't-axis' — Tick mark labels displayed only on the *t*-axis for time plots.
- 'y-axis' — Tick mark labels displayed only on the *y*-axis for time plots.
- 'none' — No tick mark labels displayed on time plots.

See Also

[Simulink.sdi.setTickLabelsDisplay](#) | [Simulink.sdi.setBorderOn](#) | [Simulink.sdi.getGridOn](#) | [Simulink.sdi.getMarkersOn](#) | [Simulink.sdi.getTicksPosition](#) | [Simulink.sdi.clearPreferences](#) | [Simulink.sdi.saveView](#) | [Simulink.sdi.save](#)

Topics

“Create Plots Using the Simulation Data Inspector”

Introduced in R2019b

Simulink.sdi.getTicksPosition

Get tick mark position setting for time plots

Syntax

```
ticksPos = Simulink.sdi.getTicksPosition
```

Description

`ticksPos = Simulink.sdi.getTicksPosition` returns the current setting for the position of tick marks on time plots in the Simulation Data Inspector. The return value corresponds to the value of the **Ticks** setting on the **Time Plot** section of the **Visualization Settings** in the Simulation Data Inspector. The setting applies to all time plots in the layout. By default, the Simulation Data Inspector displays tick marks on the outside of the plot area for time plots.

Examples

Configure Position for Tick Marks on Time Plots

You can use `Simulink.sdi.setTicksPosition` function to specify the position for tick marks on time plots in the Simulation Data Inspector. By default, the Simulation Data Inspector displays tick marks outside of the plot area for time plots.

This example starts by showing how to use the `Simulink.sdi.getTicksPosition` function to access the current position of tick marks. Subsequent sections show the code to specify each configuration option for the position of tick marks on time plots in the Simulation Data Inspector. To see the result, the example generates an image using `Simulink.sdi.snapshot` with settings specified by a `Simulink.sdi.CustomSnapshot` object.

```
snapSettings = Simulink.sdi.CustomSnapshot;  
snapSettings.Width = 300;  
snapSettings.Height = 300;
```

Get Current Tick Mark Position

Before modifying the position of tick marks on time plots, you can save the current configuration to a variable in the workspace in case you want to restore the preference later.

```
initTickPos = Simulink.sdi.getTicksPosition;
```

Position Tick Marks Inside Plot Area

Position the tick marks inside the plot area to increase the amount of space used by the plot area.

```
Simulink.sdi.setTicksPosition('inside')  
Simulink.sdi.snapshot('from', 'custom', 'settings', snapSettings);
```

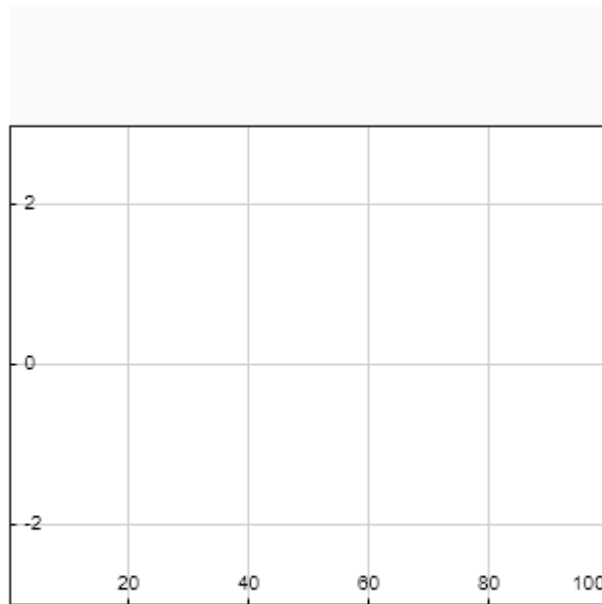

Hide Tick Marks on Time Plots

You can hide the tick marks for time plots in the Simulation Data Inspector. Hiding the tick marks expands the plot area.

```
Simulink.sdi.setTicksPosition('none')  
Simulink.sdi.snapshot('from', 'custom', 'settings', snapSettings);
```

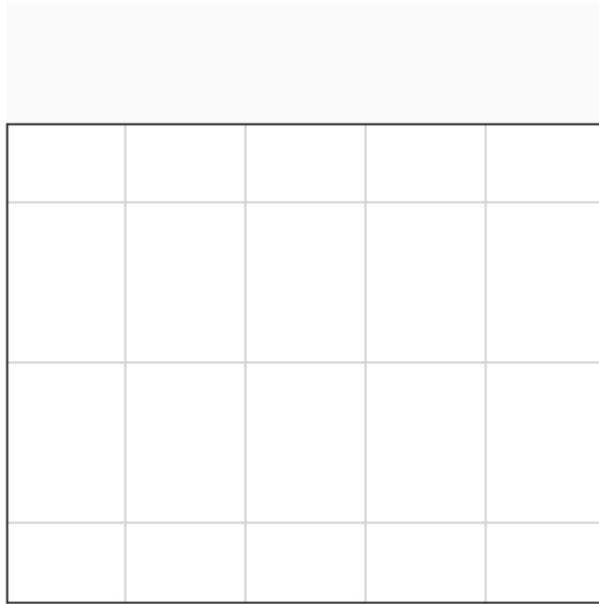

Position Tick Marks Outside Plot Area

By default, the Simulation Data Inspector displays tick marks outside of the plot area for time plots.

```
Simulink.sdi.setTicksPosition('outside')  
Simulink.sdi.snapshot('from', 'custom', 'settings', snapSettings);
```

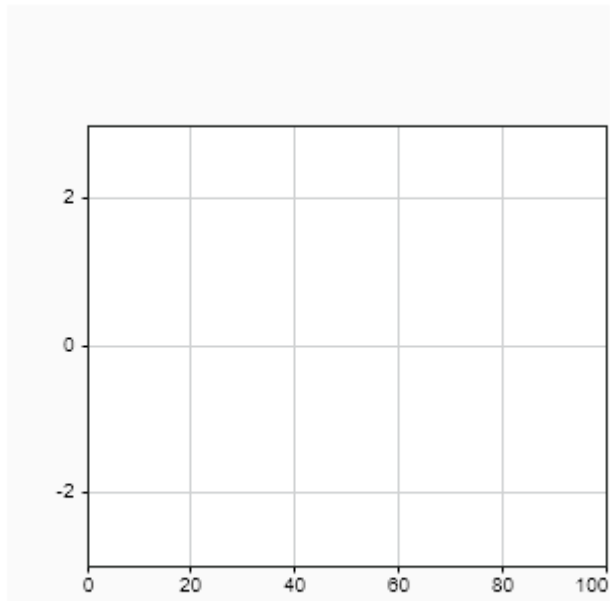
Output Arguments

ticksPos — Current setting for tick mark position on time plots

'outside' | 'inside' | 'none'

Current setting for the position of tick marks on time plots in the Simulation Data Inspector, returned as 'inside' or 'outside'.

See Also

[Simulink.sdi.setTicksPosition](#) | [Simulink.sdi.getBorderOn](#) |
[Simulink.sdi.getTickLabelsDisplay](#) | [Simulink.sdi.getGridOn](#) |
[Simulink.sdi.getMarkersOn](#) | [Simulink.sdi.clearPreferences](#) |
[Simulink.sdi.saveView](#) | [Simulink.sdi.save](#)

Topics

“Create Plots Using the Simulation Data Inspector”

Introduced in R2019b

Simulink.sdi.getTrigger

Get signal and trigger options for trigger configured in the Simulation Data Inspector

Syntax

```
sig = Simulink.sdi.getTrigger
[sig,opts] = Simulink.sdi.getTrigger
```

Description

`sig = Simulink.sdi.getTrigger` returns the `Simulink.sdi.Signal` object for the signal used to trigger display updates in the Simulation Data Inspector.

`[sig,opts] = Simulink.sdi.getTrigger` returns the trigger options configured for the trigger in the Simulation Data Inspector.

Examples

Programmatically Configure Triggers in the Simulation Data Inspector

Add a trigger to a signal in the Simulation Data Inspector to specify criteria that determine when to update plots to display fresh data. Triggers can allow you to capture transient signal behavior and can help stabilize the display of periodic signals so you can take measurements.

Simulate the `Triggers` model. Data in the model logs to the Simulation Data Inspector.

```
open_system('Triggers');
out = sim('Triggers');
```

Then, add a trigger to the `Pulse` signal. Configure the trigger as a falling-edge trigger with a threshold of 0.5.

```
trigRun = Simulink.sdi.getCurrentSimulationRun('Triggers');
pulseSig = getSignalsByName(trigRun,'Pulse');
Simulink.sdi.addTrigger(pulseSig,'Type','Edge','Level',0.5);
```

You can verify that the trigger was added and configured correctly by opening the Simulation Data Inspector using `Simulink.sdi.view` and clicking the trigger icon next to the `Pulse` signal to check the configuration. You can also use the `Simulink.sdi.getTrigger` function to check which signal is used to generate trigger events and the trigger configuration.

```
[sig,trigOpts] = Simulink.sdi.getTrigger;
```

```
sig.Name
```

```
ans =
'Pulse'
```

```
trigOpts
```

```
trigOpts = struct with fields:
    Mode: 'Auto'
```

```

        Type: 'Edge'
        Position: 0.5000
        Delay: 0
SourceChannelComplexity: 'Scalar'
        Polarity: 'Positive'
        AutoLevel: 1
        Level: 0.5000
        UpperLevel: 0
        LowerLevel: 0
        Hysteresis: 0
        MinTime: 0
        MaxTime: Inf
        Timeout: 0
        Holdoff: 0

```

When you do not want to use a trigger to control when the Simulation Data Inspector updates the plots with fresh data, you can remove the trigger using the `Simulink.sdi.removeTrigger` function.

```
Simulink.sdi.removeTrigger
```

You can verify that the trigger was removed in the Simulation Data Inspector UI or using the `Simulink.sdi.getTrigger` function. The `Simulink.sdi.getTrigger` function returns an empty array of `Simulink.sdi.Signal` objects when no trigger is configured in the Simulation Data Inspector.

```
sig = Simulink.sdi.getTrigger;
size(sig)
```

```
ans = 1x2
     0     0
```

Output Arguments

sig — Signal used to trigger display updates in the Simulation Data Inspector

`Simulink.sdi.Signal` object

Signal used to trigger display updates in the Simulation Data Inspector, returned as a `Simulink.sdi.Signal` object.

opts — Configuration of trigger in the Simulation Data Inspector

structure

Configuration of trigger in the Simulation Data Inspector, returned as a structure that contains these fields:

- Mode
- Type
- Position
- Delay

- SourceChannelComplexity
- Polarity
- AutoLevel
- Level
- UpperLevel
- LowerLevel
- Hysteresis
- MinTime
- MaxTime
- Timeout
- Holdoff

For details on trigger configuration, see “Scope Triggers Panel” and `Simulink.sdi.addTrigger`.

See Also

Objects

`Simulink.sdi.Signal` | `Simulink.sdi.Run`

Functions

`getSignalByIndex` | `getSignalsByName` | `Simulink.sdi.getSignal` |
`Simulink.sdi.addTrigger` | `Simulink.sdi.removeTrigger`

Topics

“Control Display of Streaming Data Using Triggers”
“Inspect and Compare Data Programmatically”
“Scope Triggers Panel”

Introduced in R2020b

Simulink.sdi.getUnitSystem

Get current unit system configured in Simulation Data Inspector preferences

Syntax

```
unitSystem = Simulink.sdi.getUnitSystem
[unitSystem,overrideUnits] = Simulink.sdi.getUnitSystem
```

Description

`unitSystem = Simulink.sdi.getUnitSystem` returns the unit system configured in the Simulation Data Inspector preferences. For more information about unit preferences, see “Signal Display Units”. To specify unit preferences for the Simulation Data Inspector, use the `Simulink.sdi.setUnitSystem` function.

`[unitSystem,overrideUnits] = Simulink.sdi.getUnitSystem` returns the unit system and override units configured in the Simulation Data Inspector preferences.

Examples

Configure Unit Preferences in the Simulation Data Inspector

To specify a system of units to use for plotting signals in the Simulation Data Inspector, use the `Simulink.sdi.setUnitSystem` function. When you choose to display signals using the SI or US Customary unit system, the Simulation Data Inspector automatically changes the **Display Units** property for logged or imported signals that use units that are not part of the specified unit system. The signal data stored on disk does not change. Signals also have a **Stored Units** property, and the Simulation Data Inspector converts the data to plot the signal when the **Stored Units** and **Display Units** differ.

Specify a System of Units

By default, the Simulation Data Inspector displays signals using the units assigned to the signal during simulation or in the imported data. To facilitate analyzing multiple signals and data sets together, you can specify a system of units as a preference. The Simulation Data Inspector automatically updates the **Display Units** for logged or imported signals that use units that are invalid in the specified unit system. For example, a signal logged in a model using units of ft could be updated to use units of m when the system of units is specified as SI.

Use the `Simulink.sdi.setUnitSystem` function to configure the Simulation Data Inspector to display signals using units in the US Customary unit system.

```
Simulink.sdi.setUnitSystem('USCustomary');
```

Specify Override Units

When you want all signals that represent the same type of measurement to use the same **Display Units**, you can also specify override units. For example, to plot all signals that represent length using units of ft, specify ft as an override unit.

```
Simulink.sdi.setUnitSystem('USCustomary','Overrides','ft');
```

Check Unit Configuration

Use the `Simulink.sdi.getUnitSystem` function to check the current unit preferences configured in the Simulation Data Inspector.

```
[unitSystem,overrideUnits] = Simulink.sdi.getUnitSystem
```

```
unitSystem =  
'USCustomary'
```

```
overrideUnits =  
"ft"
```

Output Arguments

unitSystem — System of units used to define signal display units

character vector

System of units used to define signal display units, returned as a character vector.

overrideUnits — Units to override signal display units

string | string array

Units to override signal display units, returned as a string or string array. The Simulation Data Inspector displays all signals that represent a measurement type using specified override units. For example, if override units of `in` are specified, the Simulation Data Inspector displays all signals that represent length using units of `in`.

See Also

Objects

`Simulink.sdi.Signal`

Functions

`convertUnits` | `Simulink.sdi.clearPreferences` | `Simulink.sdi.setUnitSystem`

Topics

“Configure the Simulation Data Inspector”

“Modify Signal Properties in the Simulation Data Inspector”

Introduced in R2020b

Simulink.sdi.isPCTSupportEnabled

Determine status and mode for Parallel Computing Toolbox support

Syntax

```
[enabled,mode] = Simulink.sdi.isPCTSupportEnabled
```

Description

`[enabled,mode] = Simulink.sdi.isPCTSupportEnabled` returns `enabled`, a logical indication of whether support for the Parallel Computing Toolbox is enabled, and `mode`, the mode of support enabled.

Examples

Check Status of Parallel Worker Support

Before running code that depends on whether automatic import of runs created by parallel workers is enabled, you can use the `Simulink.sdi.isPCTSupportEnabled` function to check the support status. The default behavior for the Simulation Data Inspector enables parallel worker support in `local` mode. In `local` mode, only runs created on local workers automatically import into the Simulation Data Inspector.

```
[enabled, mode] = Simulink.sdi.isPCTSupportEnabled
```

```
enabled =
```

```
    logical
```

```
    1
```

```
mode =
```

```
    'local'
```

Output Arguments

enabled — Logical indicator of parallel worker support

logical

Logical indication of parallel worker support.

- 1 indicates that support for parallel workers is enabled.
- 0 indicates that support for parallel workers is not enabled.

mode — Parallel worker support mode

local (default)

Mode of Parallel Computing Toolbox support.

- 'local' — Runs generated on local workers automatically import to the Simulation Data Inspector.
- 'none' — Parallel worker support is disabled.
- 'all' — Runs created from local and remote workers automatically import to the Simulation Data Inspector.
- 'manual' — Support for manual import of runs created by parallel workers using the `Simulink.sdi.sendWorkerRunToClient` function.

See Also

`Simulink.sdi.enablePCTSupport` | `Simulink.sdi.WorkerRun` | `Simulink.sdi.sendWorkerRunToClient`

Topics

“Inspect and Compare Data Programmatically”

Introduced in R2017b

Simulink.sdi.isValidRunID

Package: Simulink.sdi

Determine whether a run ID is valid

Syntax

```
valid = Simulink.sdi.isValidRunID(runID)
```

Description

`valid = Simulink.sdi.isValidRunID(runID)` returns `true` if `runID` corresponds to a run in the Simulation Data Inspector repository.

Examples

Check Run ID Validity

This example shows how to check whether a run ID is valid. You can use `Simulink.sdi.isValidRunID` to ensure you have valid data throughout your script.

Create a Simulation Run

Simulate the model `sldemo_fuelsys` to create a run in the Simulation Data Inspector, and use `Simulink.sdi.getAllRunIDs` to get its run ID.

```
% Simulate model
load_system('sldemo_fuelsys')
sim('sldemo_fuelsys')

% Get run ID
runIDs = Simulink.sdi.getAllRunIDs;
runID = runIDs(end);
```

Check Run ID Validity

Check to verify that the Simulation Data Inspector has a run corresponding to the run ID.

```
Simulink.sdi.isValidRunID(runID)

ans = logical
     1
```

Delete the Run and Check Validity

You can delete runs to clear out memory space or clean up the Simulation Data Inspector UI. When you delete a run, the run ID for that run becomes invalid.

```
Simulink.sdi.deleteRun(runID)

Simulink.sdi.isValidRunID(runID)
```

```
ans = logical  
     0
```

Input Arguments

runID — Simulation Data Inspector run identifier

scalar

Unique numeric identification for the run. The Simulation Data Inspector assigns run IDs when it creates runs. You can get the run ID for your run using `Simulink.sdi.getAllRunIDs` or `Simulink.sdi.getRunIDByIndex`.

Output Arguments

valid — Run validity indicator

logical

Run validity indicator. When `valid` is `true`, the `runID` is valid. When `valid` is `false`, the `runID` is invalid.

See Also

`Simulink.sdi.getAllRunIDs` | `Simulink.sdi.getRunIDByIndex` |
`Simulink.sdi.createRun` | `Simulink.sdi.deleteRun` | `Simulink.sdi.compareRuns`

Topics

“Inspect and Compare Data Programmatically”

Introduced in R2011b

Simulink.sdi.load

Package: Simulink.sdi

Load a Simulation Data Inspector session or view

Syntax

```
valid = Simulink.sdi.load(fileName)
```

Description

`valid = Simulink.sdi.load(fileName)` loads the data and visualization settings in the Simulation Data Inspector session file or MAT file specified by `fileName` and returns 1 when `fileName` is a valid session file or a MAT file that contains data the Simulation Data Inspector supports.

Simulation Data Inspector views are also saved as MLDATX files. To load a view file, use the `Simulink.sdi.loadView` function.

Examples

Save a Simulation Data Inspector Session

This example creates, saves, and loads a Simulation Data Inspector session. The example logs data in the model `slexAircraftExample` and visualizes the logged data in a Simulation Data Inspector session. Each time you use the Simulation Data Inspector, you create and modify a session. You can save the data and associated visualization settings for a session in an MLDATX file using the `Simulink.sdi.save` function. When you want to review the data later, you can load the session using the `Simulink.sdi.load` function.

Log Data to the Simulation Data Inspector

This example logs data from a simulation of the model `slexAircraftExample` to the Simulation Data Inspector. The model is not configured to log data. Load the model and mark the `Stick`, the `alpha`, `rad`, and the `q`, `rad/sec` signals for logging.

```
load_system('slexAircraftExample')

Simulink.sdi.markSignalForStreaming('slexAircraftExample/Pilot',1,'on')
Simulink.sdi.markSignalForStreaming('slexAircraftExample/Aircraft Dynamics Model',3,'on')
Simulink.sdi.markSignalForStreaming('slexAircraftExample/Aircraft Dynamics Model',4,'on')
```

For this example, run two simulations of the model. In the first simulation, use the sine wave output from the `Pilot` block, and in the second, use the square wave output.

```
set_param('slexAircraftExample/Pilot','WaveForm','sine')
sim('slexAircraftExample')

set_param('slexAircraftExample/Pilot','WaveForm','square')
sim('slexAircraftExample')
```

Visualize the Logged Data

You can use the Simulation Data Inspector programmatic interface to access the logged data from the simulations. When you access data using the Simulation Data Inspector programmatic interface, you can use functions to create plots in the Simulation Data Inspector.

To start, access the run IDs for the most recent two runs and then get the corresponding `Simulink.sdi.Run` object. The Run objects allow you to access the logged data for the simulations.

```
runIDs = Simulink.sdi.getAllRunIDs;
sineRunID = runIDs(end-1);
squareRunID = runIDs(end);

sineRun = Simulink.sdi.getRun(sineRunID);
squareRun = Simulink.sdi.getRun(squareRunID);
```

Suppose you want to analyze the relationship between the input and output for the model. Get the `Simulink.sdi.Signal` objects for the input and output signals from the two simulation runs.

```
sineOut = getSignalByIndex(sineRun,1);
sineIn = getSignalByIndex(sineRun,3);

squareOut = getSignalByIndex(squareRun,1);
squareIn = getSignalByIndex(squareRun,3);
```

Change the subplot layout in the Simulation Data Inspector to 2-by-1 and plot the signals from the first simulation run on the top plot and the signals from the second run on the bottom plot.

```
Simulink.sdi.setSubPlotLayout(2,1)

plotOnSubPlot(sineIn,1,1,true)
plotOnSubPlot(sineOut,1,1,true)

plotOnSubPlot(squareIn,2,1,true)
plotOnSubPlot(squareOut,2,1,true)
```

Save the Simulation Data Inspector Session

To view the plotted data in the Simulation Data Inspector, enter `Simulink.sdi.view` in the command window.

Then, save the Simulation Data Inspector session as an MLDATX file.

```
Simulink.sdi.save('myData.mldatx')
```

Load the Simulation Data Inspector Session

To mimic a scenario where you want to return to looking at the same data at a later point, clear the data from the Simulation Data Inspector and reset the subplot layout to 1-by-1.

```
Simulink.sdi.clear
Simulink.sdi.setSubPlotLayout(1,1)
```

Load the session file and resume working with the data. You can open the Simulation Data Inspector and view the results using the `Simulink.sdi.view` function.

```
Simulink.sdi.load('myData.mldatx');
```

Input Arguments

fileName — Name of session file or MAT file

string | character vector

Name of the session file or MAT file to load, specified as a string or character vector. You must specify the file extension to load data from an MLDATX file.

Example: 'myData.mldatx'

Example: 'myData.mat'

Output Arguments

valid — File validity indicator

logical

File validity indicator, returned as 1 (true) or 0 (false). A return value of 0 indicates that the Simulation Data Inspector did not load the session file or did not import data from the MAT file.

See Also

[Simulink.sdi.save](#) | [Simulink.sdi.close](#) | [Simulink.sdi.saveView](#) | [Simulink.sdi.loadView](#)

Topics

“Inspect and Compare Data Programmatically”

“View Data in the Simulation Data Inspector”

Introduced in R2011b

Simulink.sdi.loadView

Load a view file to visualize data in the Simulation Data Inspector

Syntax

```
Simulink.sdi.loadView(filename)
```

Description

`Simulink.sdi.loadView(filename)` applies the visualization information in the view file, `filename`, to the data in the Simulation Data Inspector.

A view contains information about the layout and plots in the graphical viewing area as well as properties of plotted signals. When you load a view, the Simulation Data Inspector uses the properties and preferences in the file to display data currently in the Simulation Data Inspector. Signals in the Simulation Data Inspector that align with the signals in the view are plotted in the graphical viewing area. Use a view to apply a consistent set of visualization settings to multiple sets of similar data.

The view file includes the following information:

- Subplot layout and visualization type
- Settings for each visualization type in the layout
- Signal selection mode
- Replay controls visibility
- Metadata displayed in the work area
- Settings for signal grouping in the work area
- Plotted signals and the line style and color for each plotted signal

A view file does not contain data. To load a session file that contains data and visualization information, use the `Simulink.sdi.load` function.

Examples

Save and Use a View

This example visualizes the output from the `ex_vdp` model, saves the configuration as a view, and then uses the view to visualize the output from another simulation of the same model.

To generate data to plot in the Simulation Data Inspector, simulate the model.

```
open_system('ex_vdp')
set_param('ex_vdp/Mu', 'Gain', '1')
sim('ex_vdp');
```

Programmatically Configure and Save a View

The `ex_vdp` model is configured to log two signals, `x1` and `x2`. Plot each signal on a subplot in a 2-by-1 layout.

```
Simulink.sdi.setSubPlotLayout(2,1)
```

To plot one signal on each subplot, first access the `Simulink.sdi.Run` object for the simulation.

```
runIDs = Simulink.sdi.getAllRunIDs;
ex_vdpRunID = runIDs(end);
ex_vdpRun = Simulink.sdi.getRun(ex_vdpRunID);
```

Then, you can access the data for each signal in a `Simulink.sdi.Signal` object and use the `plotOnSubPlot` function to specify where to plot each signal.

```
x1 = getSignalByIndex(ex_vdpRun,1);
x2 = getSignalByIndex(ex_vdpRun,2);
```

```
plotOnSubPlot(x1,1,1,true)
plotOnSubPlot(x2,2,1,true)
```

To view the result in the Simulation Data Inspector, enter `Simulink.sdi.view` in the command window.

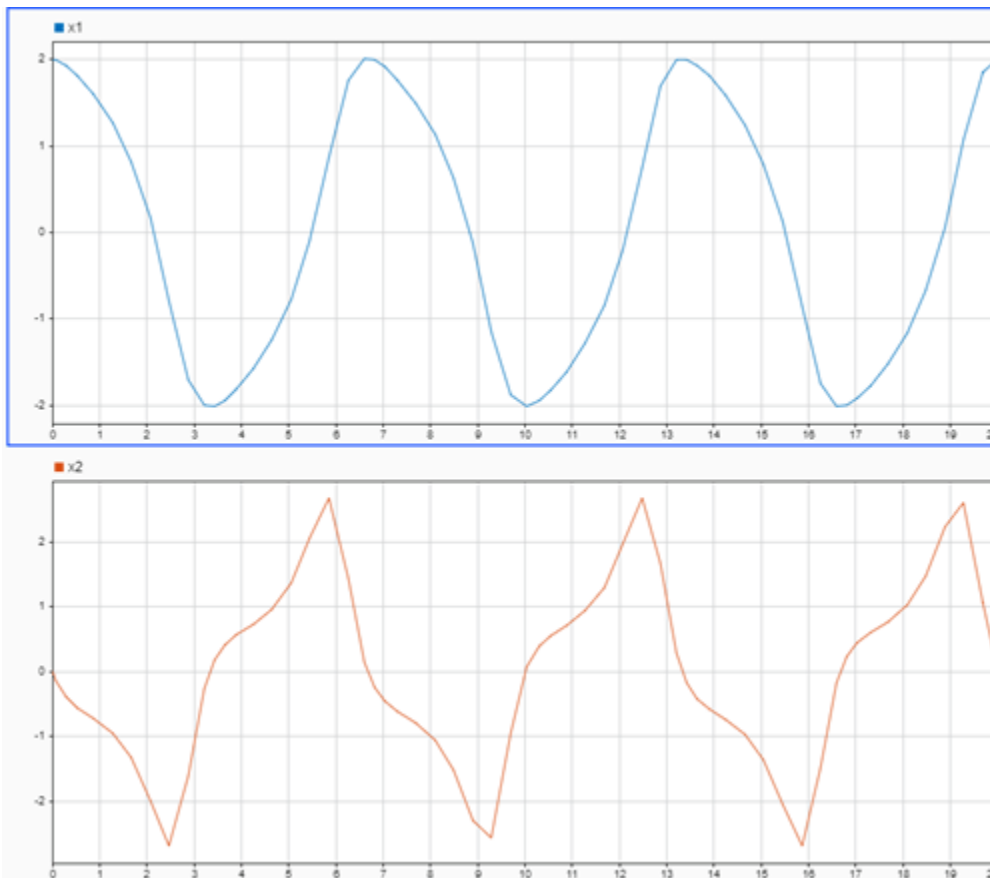

Then, save the view.

```
Simulink.sdi.saveView('ex_vdpView.mldatx')
```

Use the View

To mimic a situation where the Simulation Data Inspector is configured differently and contains data from another simulation, this example clears data from the Simulation Data Inspector, loads a view that represents the default visualization configuration, and runs another simulation of the `ex_vdp` model.

```
Simulink.sdi.clear
Simulink.sdi.loadView('default.mldatx');
set_param('ex_vdp/Mu', 'Gain', '2')
sim('ex_vdp');
```

Use the `Simulink.sdi.loadView` function to apply the saved view from the previous simulation.

```
Simulink.sdi.loadView('ex_vdpView.mldatx')
```

You can open the Simulation Data Inspector to view the results using the `Simulink.sdi.view` function. The saved view includes information regarding the axes limits. When you use a view to apply visualization settings, you may need to adjust axes limits or zoom levels to fit data from a modified simulation.

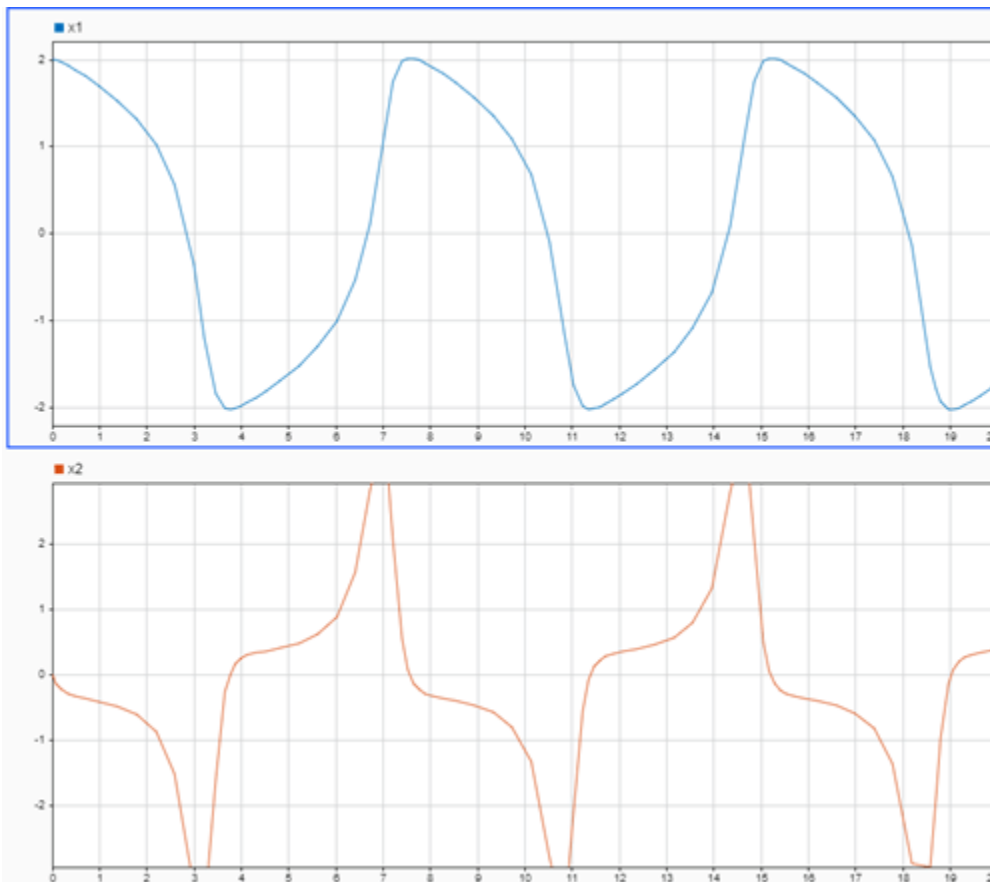

Input Arguments

filename — Name of the view file
string | character vector

Name of the view file, specified as a string or character vector. You can specify `filename` as only the file name when the file is on the MATLAB path, or you can specify a full path to the file.

Example: `'myView.mldatx'`

Data Types: `char` | `string`

See Also

[Simulink.sdi.setBorderOn](#) | [Simulink.sdi.setGridOn](#) | [Simulink.sdi.setMarkersOn](#) | [Simulink.sdi.setSubPlotLayout](#) | [Simulink.sdi.setTableGrouping](#) | [Simulink.sdi.setTickLabelsDisplay](#) | [Simulink.sdi.setTicksPosition](#) | [Simulink.sdi.copyRunViewSettings](#) | [Simulink.sdi.saveView](#)

Topics

“Save and Share Simulation Data Inspector Data and Views”

Introduced in R2019b

Simulink.sdi.markSignalForStreaming

Package: Simulink.sdi

Turn logging on or off for a signal

Syntax

```
Simulink.sdi.markSignalForStreaming(block,portIndex,log)
Simulink.sdi.markSignalForStreaming(portHandle,log)
Simulink.sdi.markSignalForStreaming(lineHandle,log)
```

Description

`Simulink.sdi.markSignalForStreaming(block,portIndex,log)` marks the signal on the specified `portIndex` of the specified block for logging when you specify `log` as 'on'. To stop logging a signal, specify `log` as 'off'.

`Simulink.sdi.markSignalForStreaming(portHandle,log)` marks the signal on the port specified by `portHandle` for logging when you specify `log` as 'on'. To stop logging a signal, specify `log` as 'off'.

`Simulink.sdi.markSignalForStreaming(lineHandle,log)` marks the signal with the specified `lineHandle` for logging when you specify `log` as 'on'. To stop logging a signal, specify `log` as 'off'.

Examples

Mark Signals for Logging with Port Handles

This example shows how to mark signals for logging using port handles.

Load Model and Mark Signals for Streaming

User `get_param` to get the port handles for the blocks with your signals of interest. Then, use the handle to mark the desired signals for logging.

```
load_system('vdp')

% Get port handles
x1_handles = get_param('vdp/x1','PortHandles');
x1 = x1_handles.Outputport(1);
x2_handles = get_param('vdp/x2','PortHandles');
x2 = x2_handles.Outputport(1);

% Mark signals for streaming
Simulink.sdi.markSignalForStreaming(x1,'on');
Simulink.sdi.markSignalForStreaming(x2,'on');
```

Simulate Model and View Signals in the Simulation Data Inspector

Simulate the model and then open the Simulation Data Inspector to view the logged signals.

```
sim('vdp');
Simulink.sdi.view
```

Mark Signals for Logging with Line Handles

This example shows how to mark signals for logging using their line handles.

Load System and Mark Signals for Logging

Load a model and use `get_param` to get handles for the signals in the model. Then, use the line handles to mark signals of interest for logging.

```
load_system('slexAircraftExample')
lines = get_param('slexAircraftExample','Lines');
sig1handle = lines(1).Handle;
sig2handle = lines(2).Handle;
Simulink.sdi.markSignalForStreaming(sig1handle,'on')
Simulink.sdi.markSignalForStreaming(sig2handle,'on')
```

Simulate Model and View Signals

Simulate the model and view the signals marked for logging in the Simulation Data Inspector.

```
sim('slexAircraftExample')
Simulink.sdi.view
```

Input Arguments

block — Source block path or handle

character vector

Block path for the block with the desired signal connected to one of its outputs.

Example: 'slexAircraftExample/Pilot'

portIndex — Source block output port index

integer

Index of the port connected to the signal you want to mark for streaming.

Example: 1

log — Logging state

'on' | 'off'

Logging state desired for signal.

- 'on' -- Turn logging on for a signal.
- 'off' -- Turn logging off for a signal.

portHandle — Source block output port handle

handle

Port handle for the source block's output port that connects to the signal.

Example: `x1_handles.Outputport(1)`

lineHandle — Signal line handle

handle

Line handle for the signal.

Example: `lines(1).Handle`

See Also

[Simulink.HMI.InstrumentedSignals](#) | [Simulink.sdi.createRunOrAddToStreamedRun](#) | [Simulink.sdi.getAllRunIDs](#) | [Simulink.sdi.getRunIDByIndex](#)

Topics

“Inspect and Compare Data Programmatically”

“View Data in the Simulation Data Inspector”

Introduced in R2015b

Simulink.sdi.registerCursorCallback

Register callback for cursor movements in the Simulation Data Inspector

Syntax

```
callbackID = Simulink.sdi.registerCursorCallback(func)
callbackID = Simulink.sdi.registerCursorCallback(func,view)
```

Description

`callbackID = Simulink.sdi.registerCursorCallback(func)` registers the callback function associated with the function handle `func` with the Simulation Data Inspector. The Simulation Data Inspector executes the callback when you move a cursor or change the number of cursors displayed on the **Inspect** pane.

`callbackID = Simulink.sdi.registerCursorCallback(func,view)` registers the callback function associated with the function handle `func` with the Simulation Data Inspector. The Simulation Data Inspector executes the callback when you move a cursor or change the number of cursors displayed on the pane specified by `view`.

Examples

Use Simulation Data Inspector Cursor Callback in App Designer App

You can use a Simulation Data Inspector cursor callback function to send cursor position data to an app you build using the App Designer. This example shows how to add a property to the app to store the callback ID and where to register and unregister the cursor callback. For an example of an App Designer app that uses a cursor callback, see “Synchronize Cursors in the Simulation Data Inspector with an App Designer App”.

Add a `callbackID` property to the app object.

```
properties (Access = private)
    callbackID
end
```

Define the behavior of the cursor callback function.

```
methods (Access = public)
    function myCursorCallback(app,~,~)
        if isValid(app)
            ...
        end
    end
end
```

Register the cursor callback in the app `startupFcn`. This example registers the same callback on the **Inspect** pane and the **Compare** pane.

```
function startupFcn(app)
    app.callbackID = Simulink.sdi.registerCursorCallback(...
```

```

    @(t1,t2)myCursorCallback(app,t1,t2));
    app.callbackID(2) = Simulink.sdi.registerCursorCallback(...
        @(t1,t2)myCursorCallback(app,t1,t2), 'compare');
    ...
end

```

Unregister the cursor callback in the app `UIFigureCloseRequest` function.

```

function myAppUIFigureCloseRequest(app, event)
    Simulink.sdi.unregisterCursorCallback(app.callbackID(1));
    Simulink.sdi.unregisterCursorCallback(app.callbackID(2));
end

```

Input Arguments

func — Cursor callback to register

function handle

Cursor callback to register, specified as a function handle. The function that corresponds to the function handle must accept two input arguments, `t1` and `t2`, that correspond to the left and right cursor positions. When no cursors are displayed, `t1` and `t2` are `NaN`. When only one cursor is displayed, `t2` is `NaN`.

Example: `id = Simulink.sdi.registerCursorCallback(@(t1,t2)myFunc(t1,t2))` registers the function `myFunc` as the callback for cursor events on the **Inspect** pane of the Simulation Data Inspector.

Data Types: `function_handle`

view — Cursor event source

'inspect' (default) | 'compare'

Cursor event source, specified as 'inspect' or 'compare'.

- 'inspect' — Register callback for cursor events on the **Inspect** pane.
- 'compare' — Register callback for cursor events on the **Compare** pane.

The registered cursor callback executes for each cursor event. Cursor events occur when you move cursors or change the number of visible cursors.

Data Types: `char` | `string`

Output Arguments

callbackID — Registered callback ID

scalar

Registered callback ID, returned as a scalar. Use the callback ID to unregister the callback.

See Also

Functions

[Simulink.sdi.unregisterCursorCallback](#) | [Simulink.sdi.setCursorPositions](#) | [Simulink.sdi.getCursorPositions](#) | [Simulink.sdi.setNumCursors](#) | [Simulink.sdi.getNumCursors](#)

Topics

[“Synchronize Cursors in the Simulation Data Inspector with an App Designer App”](#)

Introduced in R2021a

Simulink.sdi.removeTrigger

Remove trigger from signal in the Simulation Data Inspector

Syntax

```
Simulink.sdi.removeTrigger
```

Description

`Simulink.sdi.removeTrigger` removes the trigger from a signal in the Simulation Data Inspector. If a trigger exists in the Simulation Data Inspector, adding a trigger to a different signal also removes the existing trigger.

Examples

Programmatically Configure Triggers in the Simulation Data Inspector

Add a trigger to a signal in the Simulation Data Inspector to specify criteria that determine when to update plots to display fresh data. Triggers can allow you to capture transient signal behavior and can help stabilize the display of periodic signals so you can take measurements.

Simulate the Triggers model. Data in the model logs to the Simulation Data Inspector.

```
open_system('Triggers');  
out = sim('Triggers');
```

Then, add a trigger to the Pulse signal. Configure the trigger as a falling-edge trigger with a threshold of 0.5.

```
trigRun = Simulink.sdi.getCurrentSimulationRun('Triggers');  
pulseSig = getSignalsByName(trigRun,'Pulse');  
Simulink.sdi.addTrigger(pulseSig,'Type','Edge','Level',0.5);
```

You can verify that the trigger was added and configured correctly by opening the Simulation Data Inspector using `Simulink.sdi.view` and clicking the trigger icon next to the Pulse signal to check the configuration. You can also use the `Simulink.sdi.getTrigger` function to check which signal is used to generate trigger events and the trigger configuration.

```
[sig,trigOpts] = Simulink.sdi.getTrigger;
```

```
sig.Name
```

```
ans =  
'Pulse'
```

```
trigOpts
```

```
trigOpts = struct with fields:  
    Mode: 'Auto'  
    Type: 'Edge'  
    Position: 0.5000
```



```
        Delay: 0
SourceChannelComplexity: 'Scalar'
        Polarity: 'Positive'
        AutoLevel: 1
            Level: 0.5000
        UpperLevel: 0
        LowerLevel: 0
        Hysteresis: 0
        MinTime: 0
        MaxTime: Inf
        Timeout: 0
        Holdoff: 0
```

When you do not want to use a trigger to control when the Simulation Data Inspector updates the plots with fresh data, you can remove the trigger using the `Simulink.sdi.removeTrigger` function.

```
Simulink.sdi.removeTrigger
```

You can verify that the trigger was removed in the Simulation Data Inspector UI or using the `Simulink.sdi.getTrigger` function. The `Simulink.sdi.getTrigger` function returns an empty array of `Simulink.sdi.Signal` objects when no trigger is configured in the Simulation Data Inspector.

```
sig = Simulink.sdi.getTrigger;
size(sig)
```

```
ans = 1×2
```

```
    0    0
```

Alternative Functionality

To remove a trigger from a signal using the Simulation Data Inspector UI, click the trigger symbol next to the signal, then click **Remove**.

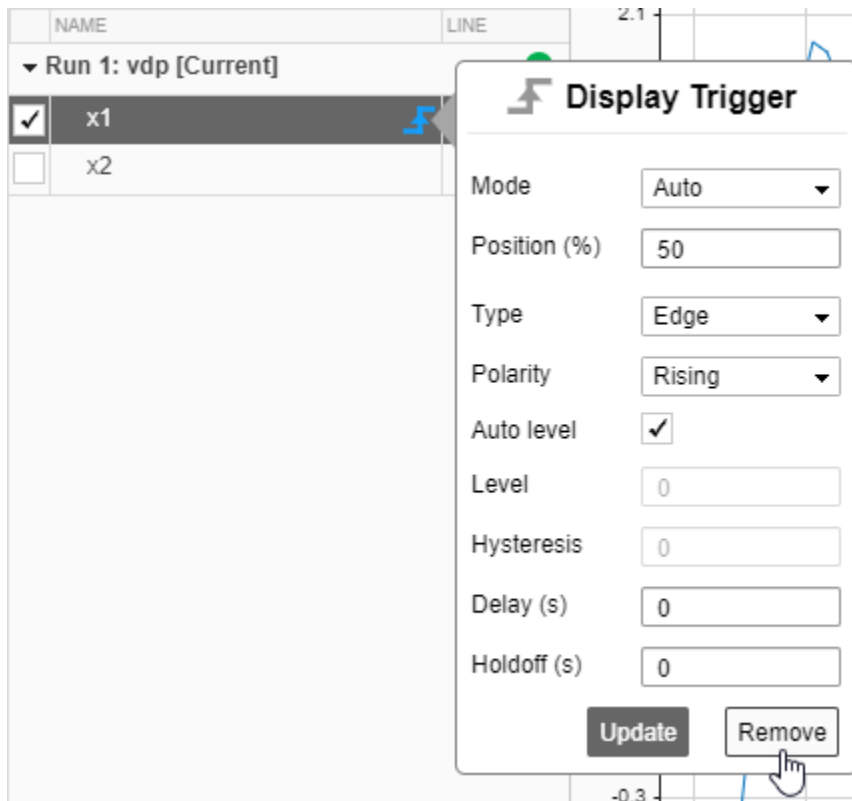

See Also

Functions

`Simulink.sdi.getTrigger` | `Simulink.sdi.addTrigger`

Topics

“Control Display of Streaming Data Using Triggers”

“Inspect and Compare Data Programmatically”

Introduced in R2020b

Simulink.sdi.report

Package: Simulink.sdi

Generate a Simulation Data Inspector report

Syntax

```
Simulink.sdi.report  
Simulink.sdi.report(Name,Value)
```

Description

`Simulink.sdi.report` creates a report that contains plot snapshots and metadata for signals plotted in the **Inspect** pane of the Simulation Data Inspector.

`Simulink.sdi.report(Name,Value)` creates a report as specified by one or more `Name,Value` pair arguments. Using this syntax, you can create a report of data plotted in the **Inspect** pane or a report of comparison results. You can specify details for each report.

Examples

Create a Report for Plotted Signals

Create a report that contains information about and plots of the signals plotted in the **Inspect** pane of the Simulation Data Inspector. By default, the report contains the metadata displayed for signals in the table on the **Inspect** pane. This example shows how to specify which metadata to include in the report.

Load the Session File

This example populates the Simulation Data Inspector with data and plotted signals by loading a saved session file. A session file contains the signal data as well as information about plotted signals and plot layout. Load the session file.

```
Simulink.sdi.load('ex_sl-demo_absbrake_slp_Ww.mldatx');
```

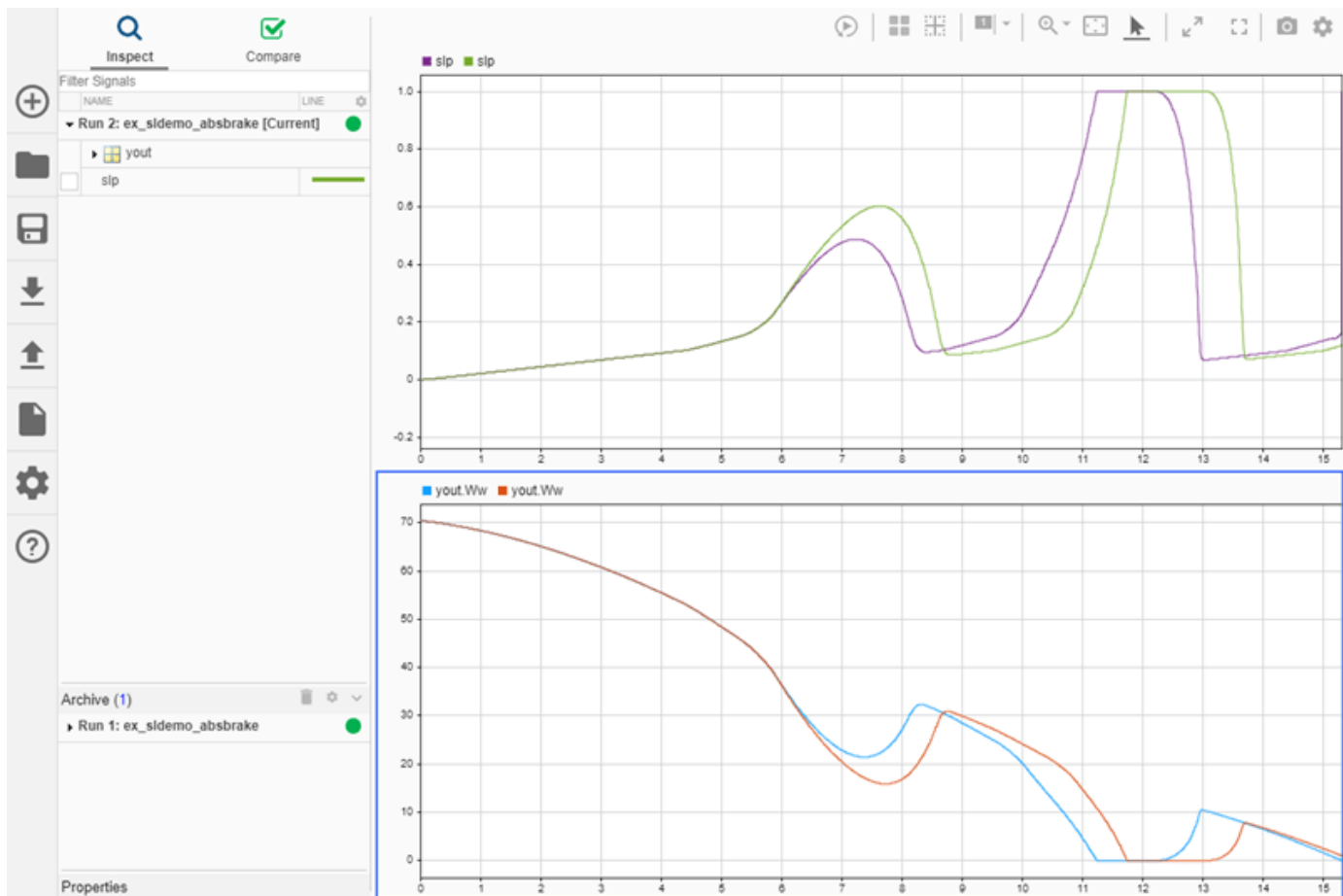

Create a Report for Plotted Signals

The report includes plots and metadata for the plotted signals. By default, the report includes the metadata that corresponds to the columns displayed in the signals table on the **Inspect** pane. You can include more data in the report by displaying more columns in the **Inspect** pane. You can also specify the information you want in the report programmatically using the 'ColumnsToReport' name-value pair and the enumeration class `Simulink.sdi.SignalMetaData`.

```
signalMetadata = [Simulink.sdi.SignalMetaData.Run, ...
                  Simulink.sdi.SignalMetaData.Line, ...
                  Simulink.sdi.SignalMetaData.BlockName, ...
                  Simulink.sdi.SignalMetaData.SignalName];

Simulink.sdi.report('ReportType','Inspect', 'ReportOutputFile', ...
                  'absbrake_slp_report.html', 'ColumnsToReport', signalMetadata);
```

The report shows tables of the metadata for plotted signals, organized by run, above a snapshot of the plot.

Create a Report for Comparison Results

Use the `Simulink.sdi.report` function to create a report of comparison results. The report is web-based and interactive, and you can switch between the interactive view and a printable view.

Load Comparison Results

This example loads previously computed comparison results that were saved in an MLDATX file using the `saveResult` function. The data came from two simulations of the `slexAircraftExample` model that used different time constant values for the input filter.

```
Simulink.sdi.load('slexAircraftExampleTsComparison.mldatx');
```

Create Comparison Report

Create a report that contains the comparison results using the `Simulink.sdi.report` function. You can specify a title and author for the report that display in the report header.

```
Simulink.sdi.report('ReportType','Compare', 'ReportTitle',...
    'Compare: Ts = 0.1 vs Ts = 1','ReportAuthor', 'Jane Smith');
```

The report opens in the system browser once it is generated. Select signals to see the results displayed in the plot and the metadata for the signals in the **Properties** pane. The report HTML file is in the `sdireports` folder in the working directory.

Input Arguments

Name-Value Pair Arguments

Specify optional comma-separated pairs of `Name`, `Value` arguments. `Name` is the argument name and `Value` is the corresponding value. `Name` must appear inside quotes. You can specify several name and value pair arguments in any order as `Name1, Value1, . . . , NameN, ValueN`.

Example: `'ReportType', 'Compare', 'ShortenBlockPath', true`

ReportType — Type of report to create

`'Inspect'` (default) | `'Compare'`

Type of report to create, specified as the comma-separated pair consisting of `'ReportType'` and `'Inspect'` or `'Compare'`.

- `'Inspect'` -- Create a report that contains plot snapshots and metadata for signals plotted in the **Inspect** pane of the Simulation Data Inspector.
- `'Compare'` -- Create a report that summarizes comparison results. The comparison report is interactive and includes plot snapshots of comparison results as well as metadata for the compared signals.

Example: `'ReportType', 'Compare'`

ReportTitle — Report title displayed in header for comparison report

`'Compare: <Baseline Run> vs. <Compare To Run>'` (default) | character vector

Report title displayed in header for comparison report, specified as the comma-separated pair consisting of `'ReportTitle'` and a character vector.

You can only specify a report title for a comparison report.

Example: `'ReportTitle', 'Trial 1 vs. Trial 2'`

ReportAuthor — Report author displayed in header for comparison report

`'<username>'` (default) | character vector

Report author displayed in header for comparison report, specified as the comma-separated pair consisting of 'ReportAuthor' and a character vector.

You can only specify a report author for a comparison report.

Example: 'ReportAuthor','John Smith'

ReportOutputFolder — Folder where report is saved

'<current working folder>/sdireports' (default) | path

Folder where report is saved, specified as the comma-separated pair consisting of 'ReportOutputFolder' and a character vector.

Example: 'ReportOutputFolder','C:\Users\user1\Desktop'

ReportOutputFile — Report file name

'SDI_report.html' (default) | character vector

Report file name, specified as the comma-separated pair consisting of 'ReportOutputFile' and a character vector.

Example: 'ReportOutputFile','MyReport.html'

PreventOverwritingFile — Whether to prevent overwriting report files

true (default) | false

Whether to prevent overwriting report files, specified as the comma-separated pair consisting of 'PreventOverwritingFile' and true or false.

- true enables file overwrite protection.
- false disables file overwrite protection.

File overwrite protection prevents the Simulation Data Inspector from overwriting an existing file by appending the file name with a number that increments each time you generate a report. When you disable file overwrite protection, the Simulation Data Inspector overwrites the existing report file unless you specify a unique file name.

Example: 'PreventOverwritingFile',false

ColumnsToReport — Signal metadata to include in report for plotted signals

array

Signal metadata to include in the report of signals plotted in the **Inspect** pane of the Simulation Data Inspector, specified as the comma-separated pair consisting of 'ColumnsToReport' and an array. By default, the **Inspect** report includes the block path, name, line style and color, and data source parameters for each plotted signal.

Note The `ColumnsToReport` input does not affect comparison reports. The comparison report always includes all signal metadata, and the summary at the top of the comparison report always includes the signal name, absolute tolerance, relative tolerance, maximum difference, and result for each signal comparison.

Specify metadata to include as an array, using the enumeration class `Simulink.sdi.SignalMetaData`. For example, to include the name of the simulation run and signal name:

```
signal_metadata = [Simulink.sdi.SignalMetaData.Run,...
                  Simulink.sdi.SignalMetaData.SignalName];
```

Then, specify `ColumnsToReport` as `signal_metadata` in the name-value pair:

```
Simulink.sdi.report('ColumnsToReport',signal_metadata)
```

The table summarizes the metadata available for Inspect report.

| Column Value | Description |
|----------------------|--|
| SignalName (default) | Signal name |
| Line (default) | Signal line style and color |
| SID | Simulink identifier For more information about SIDs, see “Simulink Identifiers” |
| Units | Signal measurement units |
| SigDataType | Signal data type |
| SigSampleTime | Method used to sample the signal |
| Model | Name of the model that generated the signal |
| BlockName | Name of the source block for the signal |
| BlockPath | Path to the source block for the signal |
| Port | Index of the signal on the output port of its block |
| Dimensions | Dimensions of the matrix containing the signal |
| Channel | Index of signal within matrix |
| Run | Name of the simulation run containing the signal |
| AbsTol | Absolute tolerance for the signal |
| RelTol | Relative tolerance for the signal |
| OverrideGlobalTol | Property that specifies whether signal tolerances take priority over global tolerances |
| TimeTol | Time tolerance for the signal |
| InterpMethod | Interpolation method |
| SyncMethod | Synchronization method used to coordinate signals for comparison |
| TimeSeriesRoot | Name of the variable associated with the signal for signals imported from the MATLAB workspace |
| TimeSource | Name of the array containing the time data for signals imported from the MATLAB workspace |
| DataSource | Name of the array containing the signal data for signals imported from the MATLAB workspace |

Example: 'ColumnsToReport',metadata

ShortenBlockPath — Whether to shorten block path in report

true (default) | false

Whether to shorten block path in report, specified as the comma-separated pair consisting of 'ShortenBlockPath' and true or false.

- `true` -- Use the shortened block path in the report.
- `false` -- Include the full block path in the report.

Example: 'ShortenBlockPath', false

LaunchReport — Whether to open report when created

true (default) | false

Whether to open the report when it is created, specified as the comma-separated pair consisting of 'LaunchReport' and true or false.

- `true` -- Open the report when it is created.
- `false` -- Do not open the report automatically.

Example: 'LaunchReport', false

SignalsToReport — Signals to include in comparison report

'ReportOnlyMismatchedSignals' (default) | 'ReportAllSignals'

Signals to include in a comparison report, specified as the comma-separated pair consisting of 'SignalsToReport' and 'ReportOnlyMismatchedSignals' or 'ReportAllSignals'.

- `ReportOnlyMismatchedSignals` -- Include only signals with out of tolerance comparison results.
- `ReportAllSignals` -- Include all signals.

Example: 'SignalsToReport', 'ReportAllSignals'

Compatibility Considerations

ReportStyle input ignored

Behavior changed in R2020b

Starting in R2020b, the `ReportStyle` name-value pair input is ignored.

In R2020a, you could use the `Simulink.sdi.report` function to create two separate types of comparison report, and you could use the `ReportStyle` name-value pair to indicate the type of report to create.

From R2020b, the Simulation Data Inspector only produces one comparison report. You can switch between the interactive and printable view within the report.

See Also

`Simulink.sdi.createRun` | `Simulink.sdi.compareSignals` | `Simulink.sdi.compareRuns` | `Simulink.sdi.Signal`

Topics

“Create an Interactive Comparison Report”
“Inspect and Compare Data Programmatically”
“Create Plots Using the Simulation Data Inspector”

“Save and Share Simulation Data Inspector Data and Views”

Introduced in R2011b

Simulink.sdi.resetRunNamingRule

Package: Simulink.sdi

Revert the Simulation Data Inspector run naming rule to default

Syntax

```
Simulink.sdi.resetRunNamingRule
```

Description

`Simulink.sdi.resetRunNamingRule` resets the run naming rule the Simulation Data Inspector uses to assign a name to runs created through simulating a Simulink model to its default 'Run <run_index>: <model_name>'.

Examples

Modify then Reset Run Naming Rule

This example shows how to use the Simulation Data Inspector API to modify the Simulation Data Inspector run naming rule, check a run's name, reset the run naming rule to its default, and check the run naming rule.

```
% Load model
load_system('sldemo_fuelsys')

% Modify run naming rule
Simulink.sdi.setRunNamingRule('<model_name> Run <run_index>')

% Simulate system
sim('sldemo_fuelsys')

% Check run name
runIDs = Simulink.sdi.getAllRunIDs;
runID = runIDs(end);
run = Simulink.sdi.getRun(runID);
run.name

ans =
'sldemo_fuelsys Run 1'

% Reset the run naming rule
Simulink.sdi.resetRunNamingRule

% Check run naming rule
Simulink.sdi.getRunNamingRule

ans =
'Run <run_index>: <model_name>'
```

Alternatives

You can reset the run naming rule to its default using the Simulation Data Inspector UI. Use the **Restore Defaults** button on the **New Run** tab under Simulation Data Inspector **Preferences**.

`Simulink.sdi.clearPreferences` restores the run naming rule, along with all other Simulation Data Inspector preferences.

See Also

`Simulink.sdi.clearPreferences` | `Simulink.sdi.setRunNamingRule` |
`Simulink.sdi.getRunNamingRule`

Topics

“Configure the Simulation Data Inspector”

“Inspect and Compare Data Programmatically”

Introduced in R2015a

add

Package: Simulink.sdi

Add signals to Simulink.sdi.Run object

Syntax

```
add(runObj, sig)
add(runObj, 'file', filename)
add(runObj, 'vars', sig1, sig2)
```

Description

`add(runObj, sig)` adds the data in the workspace variable `sig` to the `Simulink.sdi.Run` object `runObj`.

`add(runObj, 'file', filename)` adds the data in the file `filename` to the `Simulink.sdi.Run` object, `runObj`.

`add(runObj, 'vars', sig1, sig2)` adds data from multiple workspace variables to the Run object `runObj`.

Examples

Create a Run and View the Data

This example shows how to create a run, add data to it, and then view the data in the Simulation Data Inspector.

Create Data for the Run

Create `timeseries` objects to contain data for a sine signal and a cosine signal. Give each `timeseries` object a descriptive name.

```
time = linspace(0,20,100);

sine_vals = sin(2*pi/5*time);
sine_ts = timeseries(sine_vals,time);
sine_ts.Name = 'Sine, T=5';

cos_vals = cos(2*pi/8*time);
cos_ts = timeseries(cos_vals,time);
cos_ts.Name = 'Cosine, T=8';
```

Create a Run and Add Data

Use the `Simulink.sdi.view` function to open the Simulation Data Inspector.

```
Simulink.sdi.view
```

To import data into the Simulation Data Inspector from the workspace, create a `Simulink.sdi.Run` object using the `Simulink.sdi.Run.create` function. Add information about the run to its metadata using the `Name` and `Description` properties of the Run object.

```
sinusoidsRun = Simulink.sdi.Run.create;
sinusoidsRun.Name = 'Sinusoids';
sinusoidsRun.Description = 'Sine and cosine signals with different frequencies';
```

Use the `add` function to add the data you created in the workspace to the empty run.

```
add(sinusoidsRun, 'vars', sine_ts, cos_ts);
```

Plot the Data in the Simulation Data Inspector

Use the `getSignalByIndex` function to access `Simulink.sdi.Signal` objects that contain the signal data. You can use the `Simulink.sdi.Signal` object properties to specify the line style and color for the signal and plot it in the Simulation Data Inspector. Specify the `LineColor` and `LineDashed` properties for each signal.

```
sine_sig = getSignalByIndex(sinusoidsRun,1);
sine_sig.LineColor = [0 0 1];
sine_sig.LineDashed = '-.';

cos_sig = sinusoidsRun.getSignalByIndex(2);
cos_sig.LineColor = [0 1 0];
cos_sig.LineDashed = '--';
```

Use the `Simulink.sdi.setSubPlotLayout` function to configure a 2-by-1 subplot layout in the Simulation Data Inspector plotting area. Then use the `plotOnSubplot` function to plot the sine signal on the top subplot and the cosine signal on the lower subplot.

```
Simulink.sdi.setSubPlotLayout(2,1);

plotOnSubPlot(sine_sig,1,1,true);
plotOnSubPlot(cos_sig,2,1,true);
```

Close the Simulation Data Inspector and Save Your Data

When you have finished inspecting the plotted signal data, you can close the Simulation Data Inspector and save the session to an MLDATX file.

```
Simulink.sdi.close('sinusoids.mldatx')
```

Input Arguments

runObj — Run in the Simulation Data Inspector

`Simulink.sdi.Run` object

Run in the Simulation Data Inspector that you want to add data to, specified as a `Simulink.sdi.Run` object.

sig — Data to add to run

time series

Signal to add to the run, specified as time series data. Data formats supported by the Simulation Data Inspector include:

- `timeseries`
- `Simulink.SimulationData.Dataset`
- `Simulink.SimulationOutput`
- `timetable`
- Data logged using the Structure with time format
- Simscape variables

filename – File containing data

character vector | string

File name or full path to a file that contains data to add to the run, specified as a character vector or string.

Example: `'data.mat'`

See Also

Objects

`Simulink.sdi.Run`

Functions

`Simulink.sdi.addToRun` | `Simulink.sdi.createRunOrAddToStreamedRun` |
`Simulink.sdi.Run.create`

Tools

Simulation Data Inspector

Topics

“View Data in the Simulation Data Inspector”

Introduced in R2017b

Simulink.sdi.Run.create

Import data into a run in the Simulation Data Inspector

Syntax

```
runObj = Simulink.sdi.Run.create
runObj = Simulink.sdi.Run.create(runName)
runObj = Simulink.sdi.Run.create(var)
runObj = Simulink.sdi.Run.create(runName, 'vars', var, var2, ..., varn)
runObj = Simulink.sdi.Run.create(runName, 'namevalue', sourceNames, sigValues)
runObj = Simulink.sdi.Run.create(runName, 'file', filename)
runObj = Simulink.sdi.Run.create(runName, 'file', filename, Name=Value)
```

Description

`runObj = Simulink.sdi.Run.create` creates the empty `Simulink.sdi.Run` object, `runObj`. You can add signals to the Run object using the `add` function or the `Simulink.sdi.addToRun` function.

`runObj = Simulink.sdi.Run.create(runName)` creates an empty run named `runName`.

`runObj = Simulink.sdi.Run.create(var)` creates a run that contains the data in the scalar workspace variable `var`. The run is named according to the input variable. For example, when `var` is a `timeseries` object, the run name comes from the `Name` property of the `timeseries` object.

`runObj = Simulink.sdi.Run.create(runName, 'vars', var, var2, ..., varn)` creates a run named `runName` that contains data from one or more variables in the base workspace. Use this syntax to import data from multiple variables or from a variable that represents an array of objects, such as an array of `Simulink.SimulationOutput` or `Simulink.SimulationData.Dataset` objects.

`runObj = Simulink.sdi.Run.create(runName, 'namevalue', sourceNames, sigValues)` creates a run that contains the data in the cell array `sigValues`. The cell array `sourceNames` specifies the source names used to set the `RootSource`, `TimeSource`, and `DataSource` properties for the signals imported from the `sigValues` cell array.

`runObj = Simulink.sdi.Run.create(runName, 'file', filename)` imports data into a run in the Simulation Data Inspector from the file specified by `filename`. You can use a built-in file reader to import data from a MAT file, CSV file, Microsoft Excel file, or an MDF file.

When you need to import data from a file that the built-in readers do not support, you can write your own reader using the `io.reader` class.

`runObj = Simulink.sdi.Run.create(runName, 'file', filename, Name=Value)` imports data into a run in the Simulation Data Inspector from a file according to options specified using one or more name-value arguments. For example, `sheets=["sheet1" "sheet2"]` specifies which sheets to import data from when importing data from an Excel file.

Examples

Create a Run in the Simulation Data Inspector

You can programmatically import data into the Simulation Data Inspector by creating a run from data in the base workspace or a file. This example creates data in the workspace and then illustrates several methods of creating a Simulation Data Inspector run containing the data.

Create Data

Create data in the workspace. The Simulation Data Inspector supports time series data in many formats. This example creates data using the `timeseries` and `Simulink.SimulationData.Dataset` formats and saves the data in a MAT-file.

Create a sine signal and a cosine signal. Store the data for each signal in a `timeseries` object with a descriptive name.

```
time = 0:0.2:20;

sine_vals = sin(2*pi/5*time);
sine_ts = timeseries(sine_vals,time);
sine_ts.Name = 'Sine, T=5';

cos_vals = cos(2*pi/8*time);
cos_ts = timeseries(cos_vals,time);
cos_ts.Name = 'Cosine, T=8';
```

You can use the `Dataset` format to group related signal data together in a single object. The `Dataset` format is the default format for logged data and is supported for loading simulation input data. Create a `Dataset` object that contains the sinusoid `timeseries` data.

```
sinusoids_ds = Simulink.SimulationData.Dataset;
sinusoids_ds = addElement(sinusoids_ds,cos_ts);
sinusoids_ds = addElement(sinusoids_ds,sine_ts);
```

Scale each signal by a factor of 2 and create a `Dataset` object to contain the signal data for the results.

```
doubSine = 2*sine_ts;
doubCos = 2*cos_ts;

doubSinusoids_ds = Simulink.SimulationData.Dataset;
doubSinusoids_ds = addElement(doubSinusoids_ds,doubSine);
doubSinusoids_ds = addElement(doubSinusoids_ds,doubCos);
```

Finally, save the `timeseries` data to a MAT-file.

```
save sinusoids.mat sine_ts cos_ts
```

Open the Simulation Data Inspector

To view the runs you create in each section, open the Simulation Data Inspector by entering `Simulink.sdi.view` in the MATLAB™ Command Window.

Create a Run Using a `Simulink.sdi.Run` Object

You can import your data into a run in the Simulation Data Inspector by creating an empty run and then adding data to the run from the workspace or a file. Depending on your task, you can use the `Simulink.sdi.Run.create` function or the `Simulink.sdi.createRun` function to create the

empty run. The `Simulink.sdi.Run.create` function returns the `Simulink.sdi.Run` object for the new run, and the `Simulink.sdi.createRun` function returns the run ID for the new run.

This example creates an empty run using the `Simulink.sdi.Run.create` function, gives the run a meaningful name and description, and then adds the sine and cosine `timeseries` data using the `add` function.

```
sinusoidsRun = Simulink.sdi.Run.create;
sinusoidsRun.Name = 'Sinusoids';
sinusoidsRun.Description = 'Sine and cosine signals of different frequencies';

add(sinusoidsRun,'vars',sine_ts,cos_ts)
```

This example uses the `Simulink.sdi.createRun` function to create a new run in the Simulation Data Inspector called `My Waves` and then uses the `Simulink.sdi.addToRun` function to add the sine and cosine `timeseries` data to the run.

```
runID = Simulink.sdi.createRun('My Waves');
signalID = Simulink.sdi.addToRun(runID,'vars',sine_ts,cos_ts);
```

Create a Run from a Workspace Variable

You can create a run from a single variable in the workspace. After creating the run, you can add additional data, or you can create another run to contain your other data. The variable you use to create the run can be a `timeseries` object with data that corresponds to only one signal, or it can be a `Dataset` object that contains several signals.

When you use this syntax to create a run from a single workspace variable, the run takes the same name as the object used to create it.

```
runID = Simulink.sdi.createRun(sine_ts);
```

The `Simulink.sdi.createRun` function returns the run ID for the run it creates. You can use the `Simulink.sdi.getRun` function to access the `Run` object for the run.

```
sineRun = Simulink.sdi.getRun(runID);
sineRun.Name
```

```
ans =
'Sine, T=5'
```

Create a Run from Multiple Workspace Variables

When your data exists in multiple variables in your workspace, you can use the `Simulink.sdi.createRun` function with the `vars` option to import the data from multiple variables into a single run in the Simulation Data Inspector. You can also use this syntax to create a run for a single variable that uses a name you specify.

This example creates a run called `My Sinusoids` that contains data for the sine and cosine `timeseries` objects.

```
runID = Simulink.sdi.createRun('My Sinusoids','vars',sine_ts,cos_ts);
```

Create a Run and Specify Source Names

You can use the `namevalue` option of the `Simulink.sdi.createRun` function to create a run and specify names for the signals in the run. This syntax can be particularly helpful when you import individual leaf signals from hierarchical data.

This example creates a run containing the data for both the Dataset objects. Each Dataset object contains data for more than one signal, so the imported run data has hierarchy. The name-value syntax in this example specifies a name for the hierarchical node that corresponds to each Dataset object.

```
runID = Simulink.sdi.createRun('Waves','namevalue',{'Sinusoids',...
    'BigSinusoids'},{sinusoids_ds,doubSinusoids_ds});
```

Create a Run from Data in a File

You can also use the `Simulink.sdi.createRun` function to import data into the Simulation Data Inspector from a file. Use the `file` option to import the data in the `sinusoids.mat` file.

```
runID = Simulink.sdi.createRun('Wave Data','file','sinusoids.mat');
```

Create a Run and View the Data

This example shows how to create a run, add data to it, and then view the data in the Simulation Data Inspector.

Create Data for the Run

Create `timeseries` objects to contain data for a sine signal and a cosine signal. Give each `timeseries` object a descriptive name.

```
time = linspace(0,20,100);

sine_vals = sin(2*pi/5*time);
sine_ts = timeseries(sine_vals,time);
sine_ts.Name = 'Sine, T=5';

cos_vals = cos(2*pi/8*time);
cos_ts = timeseries(cos_vals,time);
cos_ts.Name = 'Cosine, T=8';
```

Create a Run and Add Data

Use the `Simulink.sdi.view` function to open the Simulation Data Inspector.

```
Simulink.sdi.view
```

To import data into the Simulation Data Inspector from the workspace, create a `Simulink.sdi.Run` object using the `Simulink.sdi.Run.create` function. Add information about the run to its metadata using the `Name` and `Description` properties of the Run object.

```
sinusoidsRun = Simulink.sdi.Run.create;
sinusoidsRun.Name = 'Sinusoids';
sinusoidsRun.Description = 'Sine and cosine signals with different frequencies';
```

Use the `add` function to add the data you created in the workspace to the empty run.

```
add(sinusoidsRun,'vars',sine_ts,cos_ts);
```

Plot the Data in the Simulation Data Inspector

Use the `getSignalByIndex` function to access `Simulink.sdi.Signal` objects that contain the signal data. You can use the `Simulink.sdi.Signal` object properties to specify the line style and

color for the signal and plot it in the Simulation Data Inspector. Specify the `LineColor` and `LineDashed` properties for each signal.

```
sine_sig = getSignalByIndex(sinusoidsRun,1);
sine_sig.LineColor = [0 0 1];
sine_sig.LineDashed = '-.';

cos_sig = sinusoidsRun.getSignalByIndex(2);
cos_sig.LineColor = [0 1 0];
cos_sig.LineDashed = '--';
```

Use the `Simulink.sdi.setSubPlotLayout` function to configure a 2-by-1 subplot layout in the Simulation Data Inspector plotting area. Then use the `plotOnSubplot` function to plot the sine signal on the top subplot and the cosine signal on the lower subplot.

```
Simulink.sdi.setSubPlotLayout(2,1);

plotOnSubPlot(sine_sig,1,1,true);
plotOnSubPlot(cos_sig,2,1,true);
```

Close the Simulation Data Inspector and Save Your Data

When you have finished inspecting the plotted signal data, you can close the Simulation Data Inspector and save the session to an MLDATX file.

```
Simulink.sdi.close('sinusoids.mldatx')
```

Input Arguments

runName — Name for run

character vector | string

Name for run in the Simulation Data Inspector, specified as a character vector or string.

Example: 'Baseline Simulation'

var — Workspace variable

workspace variable

Variable in the base workspace that contains the data you want to import into a run in the Simulation Data Inspector. The Simulation Data Inspector supports time-based data in which sample values are associated with sample times. The Simulation Data Inspector supports all loading and logging data formats, including `timeseries` and `Simulink.SimulationData.Dataset`.

Example: `myData`

sourceNames — Source names for imported data

cell array of character vectors

Source names for imported data, specified as a cell array of character vectors. The source name is used to set the `RootSource`, `TimeSource`, and `DataSource` properties of the `Simulink.sdi.Signal` objects created from the data specified by the `sigValues` input.

Provide a `sourceNames` input when you specify 'namevalue' for the second argument.

Example: {'sig1','sig2'}

sigValues — Data to import

cell array of workspace variables

Data to import, specified as a cell array of workspace variables.

Provide a `sigValues` input when you specify 'namevalue' for the second argument.

Example: {var1,var2}

filename — Name of file with data to import

character vector

Name of file with data to import, specified as a character vector. Provide a `filename` input when you specify 'file' for the second argument.

You can create a run from these types of files using file readers built into the Simulation Data Inspector:

- MAT-file
- CSV file
- Microsoft Excel file that contains data formatted according to “Microsoft Excel Import, Export, and Logging Format”.
- MDF file with one of these extensions:
 - .mdf
 - .mf4
 - .mf3
 - .data
 - .dat

When you need to import data from a file that the built-in readers do not support, you can write your own reader using the `io.reader` class. You can also write a custom reader to use instead of the built-in reader for any file extension. For an example, see “Import Data Using a Custom File Reader”.

Example: 'simulation.mat'

Name-Value Pair Arguments

Specify optional pairs of arguments as `Name1=Value1, ..., NameN=ValueN`, where `Name` is the argument name and `Value` is the corresponding value. Name-value arguments must appear after other arguments, but the order of the pairs does not matter.

Example: `sheets=["sheet1" "sheet2"]`

reader — File reader to use to import data

string | character vector

File reader to use to import data, specified as a string or character vector.

The Simulation Data Inspector prioritizes using a registered custom reader when one is available for the file. When you do not specify a reader, the Simulation Data Inspector uses the first custom reader registered for the file. If no custom readers are registered, the data is imported using the built-in reader.

Specify the reader input when:

- You want to use the built-in reader to import data for a file that is also supported by a custom reader.
- Multiple registered custom readers support the file.

To determine which readers are available to import your file, use the `io.reader.getSupportedReadersForFile` function.

Example: "MyExcelReader"

Example: "built-in"

sheets — Sheets in Excel file from which to import data

string array | cell array of character vectors

Sheets in Excel file from which to import data, specified as a string array or a cell array of character vectors. By default, the Simulation Data Inspector imports data from all sheets. Use the `sheets` name-value argument when you do not want to import data from all sheets in the Excel file.

When the data in the file does not include simulation numbers and source information, the data on each sheet is imported into a separate run. For more information about formatting data to import from an Excel file, see "Microsoft Excel Import, Export, and Logging Format".

Example: ["sheet1" "sheet2"]

model — Model with definitions of user-defined data types

string | character vector

Model with definitions of user-defined data types, specified as a string or character vector.

When you load data from an Excel file that defines signal data types using user-defined data types such as enumerations, buses, or aliases, the Simulation Data Inspector needs access to the type definition to import the data. You can provide access to the type definitions by loading the associated object into the MATLAB workspace, or you can specify the `model` name-value argument to use type definitions saved in the model workspace or a data dictionary.

For more information on formatting data to import from an Excel file, see "Microsoft Excel Import, Export, and Logging Format".

Example: "myModel.slx"

Output Arguments

runObj — Imported data

Simulink.sdi.Run object

Imported data, returned as a `Simulink.sdi.Run` object. When you create an empty Run object, import data from the base workspace or a file using the `add` function or the `Simulink.sdi.addToRun` function.

See Also

Objects

Simulink.sdi.Run

Functions

Simulink.sdi.createRun | Simulink.sdi.createRunOrAddToStreamedRun | add |
io.reader.getRegisteredFileReaders | io.reader.getSupportedReadersForFile

Tools

Simulation Data Inspector

Classes

io.reader

Topics

“Inspect and Compare Data Programmatically”
“Microsoft Excel Import, Export, and Logging Format”
“View Data in the Simulation Data Inspector”
“Import Data Using a Custom File Reader”

Introduced in R2017b

export

Package: Simulink.sdi

Export run to base workspace or file

Syntax

```
ds = export(runObj)
export(runObj,Name,Value)
```

Description

`ds = export(runObj)` exports the `Simulink.sdi.Run` object `runObj` to the base workspace as the `Simulink.SimulationData.Dataset` object `ds`.

`export(runObj,Name,Value)` exports the `Simulink.sdi.Run` object `runObj` to the base workspace or a file according to the options specified by one or more name-value pair arguments.

Examples

Export Run Data

This example shows how to export data from a run in the Simulation Data Inspector to a `Simulink.SimulationData.Dataset` object in the base workspace that you can use to further process your data. The method you choose to export your run depends on the processing you do in your script. If you have a run object for the run, you can use the `export` method to create a `Simulink.SimulationData.Dataset` object with the run data in the base workspace. If you do not have a run object, use the `Simulink.sdi.exportRun` function to export the run to the workspace.

Export Run Using Simulink.sdi.exportRun

Use the `Simulink.sdi.export` function to export run data to the workspace or a file when your workflow does not include creating a run object.

To create a run of simulation data, open the vdp model, mark signals for logging, and run a simulation.

```
load_system('vdp')

SignalHandles = get_param('vdp', 'Lines');

Simulink.sdi.markSignalForStreaming(SignalHandles(5).Handle, 'on')
Simulink.sdi.markSignalForStreaming(SignalHandles(6).Handle, 'on')

out = sim('vdp');
```

Use the `Simulink.sdi.getAllRunIDs` function to access the most recently created run.

```
runIDs = Simulink.sdi.getAllRunIDs;
runID = runIDs(end);
```

Use the `Simulink.sdi.exportRun` function to export the run data to a `Dataset` object in the workspace.

```
simDataset = Simulink.sdi.exportRun(runID);
```

Export Run Using the export Function

When your task involves creating a Run object, you can use the `export` function to create a `Simulink.SimulationData.Dataset` object in the base workspace to further process the run data. For example, suppose you need to access Run objects for simulation runs with signal data you want to compare using the `Simulink.sdi.compareSignals` function.

Load a model and mark signals for logging. Then simulate the model to create run data.

```
load_system('vdp')

SignalHandles = get_param('vdp', 'Lines');

Simulink.sdi.markSignalForStreaming(SignalHandles(5).Handle, 'on')
Simulink.sdi.markSignalForStreaming(SignalHandles(6).Handle, 'on')

sim('vdp');
```

Use the `Simulink.sdi.getAllRunIDs` function to access the run ID for the most recently created run. Then, use the `Simulink.sdi.getRun` function to access the Run object corresponding to the run.

```
runIDs = Simulink.sdi.getAllRunIDs;
runID = runIDs(end);
vdpRun = Simulink.sdi.getRun(runID);
```

Use the `export` function to export the run data to a `Dataset` object in the workspace.

```
simDataset = export(vdpRun);
```

Input Arguments

runObj — Run with data to export

`Simulink.sdi.Run` object

Run with data to export, specified as a `Simulink.sdi.Run` object.

Name-Value Pair Arguments

Specify optional comma-separated pairs of `Name`, `Value` arguments. `Name` is the argument name and `Value` is the corresponding value. `Name` must appear inside quotes. You can specify several name and value pair arguments in any order as `Name1, Value1, ..., NameN, ValueN`.

Example: `'to', 'file'`

to — Where to export data

`'variable'` (default) | `'file'`

Where to export data, specified as the comma-separated pair consisting of `'to'` and `'variable'` or `'file'`.

When you export data to a file, you must also specify a file name using the `'filename'` name-value pair argument. You can specify a file name with a `.mat`, `.mlDATX`, or `.xlsx` extension.

When you export a run to a MAT-file, the data is saved in a `Simulink.SimulationData.Dataset` object. When you export more than one run to a MAT-file using the `Simulink.sdi.exportRun` function, the data is saved in a `Dataset` object, where each element is a `Dataset` object that contains the data for one exported run.

Data exported to a Microsoft Excel file is saved using the format described in “Microsoft Excel Import, Export, and Logging Format”.

When you export data to a Microsoft Excel file, you can specify additional options using the `'overwrite'`, `'metadata'`, and `'sharetimecolumn'` name-value pairs.

Example: `'to', 'file'`

filename — Name of file to contain exported data

string | character array

Name of the file to contain the exported data, specified as the comma-separated pair consisting of `'filename'` and a string or character array. Include a `.mat`, `.mlDATX`, or `.xlsx` extension in the file name to specify whether to export the data to a MAT-file, MLDATX file, or a Microsoft Excel file. When you do not specify an extension with a file name, the data exports to a MAT-file.

Use the `'filename'` name-value pair argument when you specify the `'to'` name-value pair argument with the value `'file'`.

When you export data to a Microsoft Excel file, you can specify additional options using the `'overwrite'`, `'metadata'`, and `'sharetimecolumn'` name-value pair arguments.

Example: `'filename', 'mySpreadsheet.xlsx'`

overwrite — Data to overwrite in existing Microsoft Excel file

`'file'` (default) | `'sheetonly'`

Data to overwrite in existing Microsoft Excel file, specified as the comma-separated pair consisting of `'overwrite'` and `'file'` or `'sheetonly'`.

- `'file'` — Overwrite the entire file with the exported data.
- `'sheetonly'` — Only overwrite sheets of the Microsoft Excel file with data that corresponds to the exported data.

When you export data to an existing MAT-file or MLDATX file, the exported data overwrites the entire file.

Example: `'overwrite', 'sheetonly'`

metadata — Metadata to include in exported Microsoft Excel file

`[]` (default) | string array

Metadata to include in the exported Microsoft Excel file, specified as the comma-separated pair consisting of `'metadata'` and a string array. By default, the export operation does not include any metadata. You can export this metadata to the Microsoft Excel file:

- `dataType` — Signal data type

- `units` — Signal units
- `blockPath` — Path to the source block for logged signals
- `interp` — Signal interpolation method
- `portIndex` — Index of the port on the source block for logged signals

You can specify the desired metadata in any order you choose in the string array. The order of the metadata in the string array does not affect the format in the exported file, which always matches the description in “Microsoft Excel Import, Export, and Logging Format”.

Example: `'metadata', ["units", "dataType"]`

sharetimecolumn — Whether signals share time columns in exported Microsoft Excel file
'on' (default) | 'off'

Whether signals that have identical time data share time columns in the exported Microsoft Excel file, specified as the comma-separated pair consisting of 'sharetimecolumn' and 'on' or 'off'. By default, signals with the same time data share a time column in the exported file. When you specify the value as 'off', each signal in the exported file has its own time column.

Example: `'sharetimecolumn', 'off'`

Output Arguments

ds — Exported run data

`Simulink.SimulationData.Dataset` object

Exported run data, returned as a `Simulink.SimulationData.Dataset` object.

Alternatives

You can export data programmatically for one or more runs using the `Simulink.sdi.exportRun` function, or you can use the Simulation Data Inspector UI. For more information, see “Save and Share Simulation Data Inspector Data and Views”.

See Also

`Simulink.sdi.Run` | `Simulink.sdi.getRun` | `Simulink.sdi.exportRun` | `Simulink.sdi.report`

Topics

“Inspect and Compare Data Programmatically”

“Save and Share Simulation Data Inspector Data and Views”

Introduced in R2017b

getAllSignalIDs

Package: Simulink.sdi

Get all signal IDs for signals in Simulink.sdi.Run object

Syntax

```
sigIDs = getAllSignalIDs(runObj)
```

Description

`sigIDs = getAllSignalIDs(runObj)` returns an array, `sigIDs`, that contains the signal IDs for all signals in the Simulink.sdi.Run object `runObj`. Use the `getAllSignalIDs` function when you need to work with many or all of the signals in the run. When you only need to analyze a specific signal, you can access the single `Signal` object using the `getSignalIDsByName` function or the `getSignalIDByIndex` function.

Examples

Get Signal IDs for All Signals in a Run

You can use the `getAllSignalIDs` function to access an array containing the signal IDs for all the signals in a run. This example simulates the `slexAircraftExample` model to create run data and then shows how to get the signal IDs for the signals in the run and use the IDs to compare the signals.

Create a Run

This example creates a run in the Simulation Data Inspector by simulating a model that logs data. Load the `slexAircraftExample` model and mark the `Stick` and `alpha, rad` signals for logging.

```
load_system('slexAircraftExample')
```

```
Simulink.sdi.markSignalForStreaming('slexAircraftExample/Pilot',1,'on')
```

```
Simulink.sdi.markSignalForStreaming('slexAircraftExample/Aircraft Dynamics Model',4,'on')
```

Simulate the model.

```
out = sim('slexAircraftExample');
```

Access Run Data and Signal IDs

Use the `Simulink.sdi.getCurrentSimulationRun` function to access the run created when you simulated the `slexAircraftExample` model.

```
airRun = Simulink.sdi.getCurrentSimulationRun('slexAircraftExample');
```

Get an array of the signal IDs for the logged signals using the `getAllSignalIDs` function.

```
sigIDs = getAllSignalIDs(airRun);
```

Compare Logged Signals

You can use the signal IDs to compare the logged signals. Use the `Simulink.sdi.getSignal` function to get the `Simulink.sdi.Signal` object with the first ID in the array `sigIDs`. Check the `Name` property for the returned `Signal` object.

```
sigID1 = sigIDs(1);  
sig1 = Simulink.sdi.getSignal(sigID1);  
sig1.Name
```

```
ans =  
'alpha, rad'
```

Use the input signal, `Stick`, as the baseline signal in the signal comparison.

```
sigID2 = sigIDs(2);  
DSR = Simulink.sdi.compareSignals(sigID2, sigID1);  
DSR.Status
```

```
ans =  
    ComparisonSignalStatus enumeration  
  
    OutOfTolerance
```

The signals do not match. You can use the tolerance properties of the `Signal` objects to programmatically analyze the data, or you can open the Simulation Data Inspector using the `Simulink.sdi.view` function to view and analyze the comparison results using the UI.

Input Arguments

runObj — Run containing signals you want to access

`Simulink.sdi.Run` object

Run containing the signals you want to access, specified as a `Simulink.sdi.Run` object.

Output Arguments

sigIDs — Signal IDs for signals in run

array

Signal IDs for the signals in the run, returned as an array.

See Also

`Simulink.sdi.Signal` | `Simulink.sdi.Run` | `getAllSignals` | `getSignalsByName` | `getSignalIDsByName` | `getSignalByIndex` | `getSignalIDByIndex` | `Simulink.sdi.getSignal` | `getSignal`

Topics

“Inspect and Compare Data Programmatically”

Introduced in R2020a

getAllSignals

Package: Simulink.sdi

Get all signals in Simulink.sdi.Run object

Syntax

```
sigs = getAllSignals(runObj)
```

Description

`sigs = getAllSignals(runObj)` returns an array of `Simulink.sdi.Signal` objects, `sigs`, that correspond to the signals contained in the `Simulink.sdi.Run` object `runObj`. Use the `getAllSignals` function when you need to work with many or all of the signals in the run. When you need to analyze a specific signal, you can access the single `Signal` object using the `getSignalsByName` function or the `getSignalByIndex` function.

Examples

Get All Signals in a Run

You can use the `getAllSignals` function to access `Simulink.sdi.Signal` objects for each signal in a `Simulink.sdi.Run` object when you want to analyze all the data in the run. This example shows how to access and inspect signal data logged in the `sldemo_autotrans` model.

Create a Run

This example creates a run in the Simulation Data Inspector by simulating a model that logs data.

```
out = sim('sldemo_autotrans');
```

Access Run and Signal Data

Access the run and signal data using the Simulation Data Inspector programmatic interface. Use the `Simulink.sdi.getCurrentSimulationRun` function to get the `Run` object created when you simulated the `sldemo_autotrans` model.

```
autoRun = Simulink.sdi.getCurrentSimulationRun('sldemo_autotrans');
```

Use the `getAllSignals` function to get an array of `Signal` objects containing the logged signal data.

```
autoSigs = getAllSignals(autoRun);
```

You can use a `for` loop to inspect or analyze the data in each `Signal` object in the array. For example, you could check the name of each signal.

```
count = length(autoSigs);  
for idx = 1:count  
    sig = autoSigs(idx);
```

```
name = sig.Name;  
formatSpec = "The signal at index %d is named %s\n";  
fprintf(formatSpec,idx,name)  
end
```

```
The signal at index 1 is named EngineRPM  
The signal at index 2 is named Throttle  
The signal at index 3 is named BrakeTorque  
The signal at index 4 is named ShiftLogic:1  
The signal at index 5 is named ImpellerTorque  
The signal at index 6 is named OutputTorque  
The signal at index 7 is named VehicleSpeed  
The signal at index 8 is named TransmissionRPM
```

Input Arguments

runObj — Run containing signals you want to access

Simulink.sdi.Run object

Run containing the signals you want to access, specified as a Simulink.sdi.Run object.

Output Arguments

sigs — Signals contained in run

array of Simulink.sdi.Signal objects

Signals contained in the run, returned as an array of Simulink.sdi.Signal objects.

See Also

Simulink.sdi.Signal | Simulink.sdi.Run | getAllSignalIDs | getSignalsByName |
getSignalIDsByName | getSignalByIndex | getSignalIDByIndex |
Simulink.sdi.getSignal | getSignal

Topics

“Inspect and Compare Data Programmatically”

Introduced in R2020a

Simulink.sdi.Run.getLatest

Get the most recently created Simulation Data Inspector run

Syntax

```
runObj = Simulink.sdi.Run.getLatest
```

Description

`runObj = Simulink.sdi.Run.getLatest` returns the most recently created run in the Simulation Data Inspector repository. A run is created when you simulate a model that logs data or when you import data into the Simulation Data Inspector.

Examples

Access Simulation Data Inspector Runs

Many tasks performed using the Simulation Data Inspector programmatic interface start by accessing the `Simulink.sdi.Run` object that corresponds to the logged or imported data you want to analyze. For example, you can use the Run object to access the `Simulink.sdi.Signal` objects that correspond to individual signals in the run.

This example shows how to access Run objects by using the `Simulink.sdi.Run.getLatest` function, the `Simulink.sdi.getCurrentSimulationRun` function, or the `Simulink.sdi.getRun` function.

Create a Run

The model `sldemo_fuelsys` is already configured for logging. When you simulate the model, the Simulation Data Inspector automatically creates a run and assigns it a run ID.

```
load_system('sldemo_fuelsys')  
sim('sldemo_fuelsys')
```

Get Run Object Using `Simulink.sdi.Run.getLatest`

In this example, the run created when you simulated the model is the most recently created run in the Simulation Data Inspector. When you want to access the most recently created run, use the `Simulink.sdi.Run.getLatest` function.

```
fuelsysRun = Simulink.sdi.Run.getLatest;
```

Get Run Object Using `Simulink.sdi.getCurrentSimulationRun`

The run you want to access may not be the most recently created run in the Simulation Data Inspector. If the run corresponds to the most recent simulation of a model, you can use the `Simulink.sdi.getCurrentSimulationRun` function to access the Run object. You can also use the `Simulink.sdi.getCurrentSimulationRun` function to access data for an in-progress simulation when the simulation streams data to the Simulation Data Inspector. This function can be useful when you are working with multiple models.

In this example, the run created when you simulated the model is the current simulation run for the `sldemo_fuelsys` model.

```
fuelsysRun = Simulink.sdi.getCurrentSimulationRun('sldemo_fuelsys');
```

Get Run Object from a Run ID

When your task also requires the run ID, you can use the `Simulink.sdi.getRun` function to get the corresponding `Simulink.sdi.Run` object that contains the run data and metadata.

```
runIDs = Simulink.sdi.getAllRunIDs;  
runID = runIDs(end);  
fuelsysRun = Simulink.sdi.getRun(runID);
```

Output Arguments

runObj — Simulink.sdi.Run object

`Simulink.sdi.Run` object

`Simulink.sdi.Run` object for the most recently created run in the Simulation Data Inspector.

See Also

[Simulink.sdi.Run](#) | [Simulink.sdi.getCurrentSimulationRun](#) | [Simulink.sdi.getRun](#) | [Simulink.sdi.getRunCount](#) | [Simulink.sdi.getRunIDByIndex](#) | [Simulink.sdi.getAllRunIDs](#)

Topics

“Inspect and Compare Data Programmatically”

Introduced in R2020a

getDatasetRef

Package: Simulink.sdi

Create a Simulink.sdi.DatasetRef object for a run

Syntax

```
sdiDSRef = getDatasetRef(runObj)
```

Description

`sdiDSRef = getDatasetRef(runObj)` creates a `Simulink.sdi.DatasetRef` object, `sdiDSRef`, that references the data in the `Simulink.sdi.Run` object `runObj`. Use a `DatasetRef` object to process your data when the data is too large to fit into memory.

Examples

Compare Runs with the Simulink.sdi.DatasetRef Object

This example shows how to work with the `Simulink.sdi.DatasetRef` object by comparing two runs of the `ex_sl-demo_absbrake` system with different desired slip ratios.

```
% Simulate model ex_sl-demo_absbrake to create a run of logged signals
load_system('ex_sl-demo_absbrake')
sim('ex_sl-demo_absbrake')

% Get the runID
runIDs = Simulink.sdi.getAllRunIDs;
runID = runIDs(end);

% Get the run object
brakeRun = Simulink.sdi.getRun(runID);

% Make a Simulink.sdi.DatasetRef object
run_DSRef = brakeRun.getDatasetRef;

% Get the names of the elements in the object
names = run_DSRef.getElementNames

names = 2x1 cell
    {'yout'}
    {'slp' }

% Get yout bus
[yout, name, index] = run_DSRef.getElement(1);

% View signals in outputs
outputs = yout.Values

outputs = struct with fields:
    Ww: [1x1 timeseries]
```

```
Vs: [1x1 timeseries]
Sd: [1x1 timeseries]

% Get slp signal
slp = run_DSRef.getSignal('slp');

% Plot signal
slp.Checked = 'true';

% Create another run for a different Desired relative slip
set_param('ex_sldemo_absbrake/Desired relative slip', 'Value', '0.25')
sim('ex_sldemo_absbrake')
DSR_Runs = Simulink.sdi.DatasetRef;

% Compare the results from the two runs
[matches, mismatches, diffResult] = run_DSRef.compare(DSR_Runs(2));

% Open the Simulation Data Inspector to view signals
run_DSRef.plot
```

Input Arguments

runObj — Run with data that does not fit in memory

Simulink.sdi.Run object

Run with data you want to process that does not fit into memory, specified as a `Simulink.sdi.Run` object.

Output Arguments

sdiDSRef — Reference to run data

Simulink.sdi.DatasetRef object

Reference to run data that you can use to process data that does not fit into memory, returned as a `Simulink.sdi.DatasetRef` object.

See Also

Simulink.sdi.Run | Simulink.sdi.DatasetRef

Topics

“Inspect and Compare Data Programmatically”

Introduced in R2017b

getSignalByIndex

Package: Simulink.sdi

Get signal in Simulink.sdi.Run object by index

Syntax

```
sig = getSignalByIndex(runObj,idx)
```

Description

`sig = getSignalByIndex(runObj,idx)` returns the Simulink.sdi.Signal object, `sig`, at the index specified by `idx` within the Simulink.sdi.Run object `runObj`.

Examples

Plot Signals from Simulation Run

This example demonstrates how to access the Simulink.sdi.Run object for a Simulation Data Inspector run created by logging signals. From the Simulink.sdi.Run object you can get Simulink.sdi.Signal objects that contain the logged signal data and metadata. You can use the Signal objects and the plotOnSubPlot function to plot the data in the Simulation Data Inspector.

Create a Simulation Run and Access the Run Object

The `ex_vdp` model logs two signals. To create a simulation run containing the logged data, simulate the model.

```
sim('ex_vdp');
```

The Simulation Data Inspector keeps track of runs by assigning a unique numeric run ID to each run created by simulation, importing data, or opening a session. To access the run object for the simulation you just performed, use the Simulink.sdi.getAllRunIDs function and take the last run ID in the returned vector.

```
runIDs = Simulink.sdi.getAllRunIDs;
runID = runIDs(end);
```

Once you have the run ID for the run, you can use the Simulink.sdi.getRun function to get the Simulink.sdi.Run object that corresponds to the run. You can use the Run object to check the metadata associated with the run, including the number of signals in the run.

```
vdpRun = Simulink.sdi.getRun(runID);
```

```
vdpRun.SignalCount
```

```
ans = int32
     2
```

Plot Data Using Signal Objects

Use the `getSignalByIndex` function to access signals from the Run object, `fuelRun`.

```
signal1 = getSignalByIndex(vdpRun,1);  
signal2 = getSignalByIndex(vdpRun,2);
```

Use the `Simulink.sdi.setSubPlotLayout` function to specify a 3-by-1 layout.

```
Simulink.sdi.setSubPlotLayout(2,1)
```

Before plotting the data, use the `Simulink.sdi.clearAllSubPlots` function to clear any data that is already plotted.

```
Simulink.sdi.clearAllSubPlots
```

Plot one signal on each subplot. To plot signals on the first subplot, you can set the checked property for the signal. To plot signals on subplots other than the first subplot, use the `plotOnSubPlot` function.

```
signal1.Checked = true;  
plotOnSubPlot(signal2,2,1,true);
```

View the Plotted Data

To view the plots you just created, open the Simulation Data Inspector using the `Simulink.sdi.view` function.

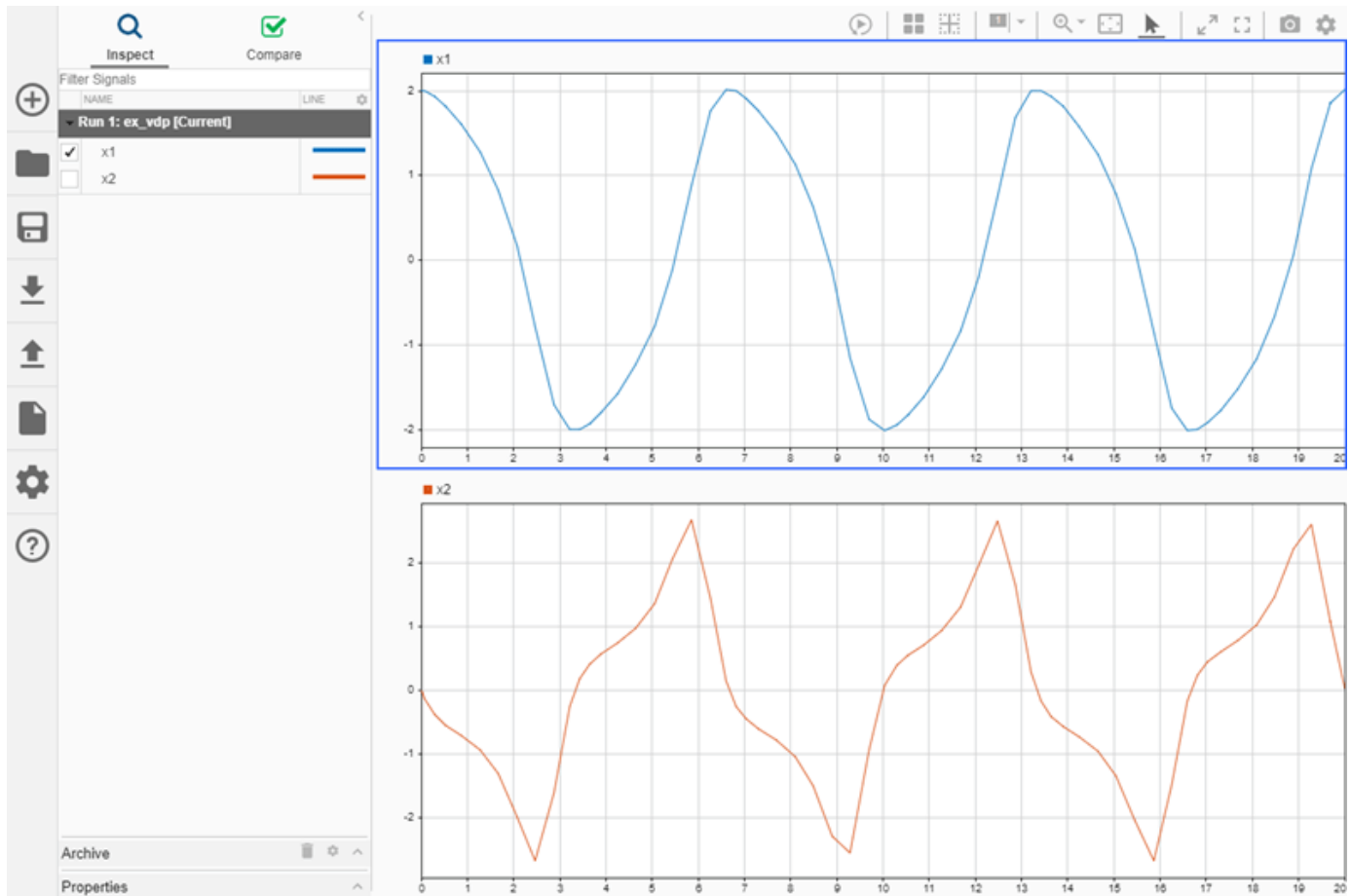

Input Arguments

runObj – Run that contains desired signal

Simulink.sdi.Run object

Run that contains the signal you want to access, specified as a Simulink.sdi.Run object.

idx – Index of signal in run

integer

Index of the signal within the run, specified as an integer.

Output Arguments

sig – Signal at specified index

Simulink.sdi.Signal object

Signal at the specified index in the Run object, returned as a Simulink.sdi.Signal object.

See Also

Simulink.sdi.Signal | Simulink.sdi.Run | getSignalIDByIndex | getSignalsByName | getSignalIDsByName | getAllSignals | getAllSignalIDs

Topics

“Inspect and Compare Data Programmatically”

Introduced in R2012b

getSignalIDByIndex

Package: Simulink.sdi

Get signal ID for signal at specified index in Simulink.sdi.Run object

Syntax

```
sigID = getSignalIDByIndex(runObj,idx)
```

Description

`sigID = getSignalIDByIndex(runObj,idx)` returns the signal ID `sigID` for the signal at the specified index `idx` in the `Simulink.sdi.Run` object `runObj`.

Tip You can use the signal ID to get the `Simulink.sdi.Signal` object that contains the signal data and metadata or perform a signal comparison using the `Simulink.sdi.compareSignals` function.

Examples

Compare Two Signals in the Same Run

You can use the Simulation Data Inspector programmatic interface to compare signals within a single run. This example compares the input and output signals of an aircraft longitudinal controller.

First, load the session that contains the data.

```
Simulink.sdi.load('AircraftExample.mldatx');
```

Use the `Simulink.sdi.Run.getLatest` function to access the latest run in the data.

```
aircraftRun = Simulink.sdi.Run.getLatest;
```

Then, you can use the `Simulink.sdi.getSignalsByName` function to access the `Stick` signal, which represents the input to the controller, and the `alpha, rad` signal that represents the output.

```
stick = getSignalsByName(aircraftRun,'Stick');
alpha = getSignalsByName(aircraftRun,'alpha, rad');
```

Before you compare the signals, you can specify a tolerance value to use for the comparison. Comparisons use tolerance values specified for the baseline signal in the comparison, so set an absolute tolerance value of 0.1 on the `Stick` signal.

```
stick.AbsTol = 0.1;
```

Now, compare the signals using the `Simulink.sdi.compareSignals` function. The `Stick` signal is the baseline, and the `alpha, rad` signal is the signal to compare against the baseline.

```
comparisonResults = Simulink.sdi.compareSignals(stick.ID,alpha.ID);
match = comparisonResults.Status
```

```
match =  
    ComparisonSignalStatus enumeration  
  
    OutOfTolerance
```

The comparison result is out of tolerance. You can use the `Simulink.sdi.view` function to open the Simulation Data Inspector to view and analyze the comparison results.

Input Arguments

runObj – Run that contains desired signal

`Simulink.sdi.Run` object

Run that contains the desired signal, specified as a `Simulink.sdi.Run` object.

idx – Index of signal in run

integer

Index of the signal within the run, specified as an integer.

Output Arguments

sigID – Signal ID

integer

Unique numeric signal identifier, returned as an integer.

See Also

Objects

`Simulink.sdi.Signal` | `Simulink.sdi.Run`

Functions

`Simulink.sdi.compareSignals` | `Simulink.sdi.getSignal` | `getSignalByIndex` | `getAllSignalIDs` | `getAllSignals` | `getSignalsByName` | `getSignalIDsByName`

Tools

Simulation Data Inspector

Topics

“Inspect and Compare Data Programmatically”

Introduced in R2012b

getSignalIDsByName

Package: Simulink.sdi

Get signal IDs for signals inside Simulink.sdi.Run object using signal name

Syntax

```
sigIDs = getSignalIDsByName(runObj,name)
```

Description

`sigIDs = getSignalIDsByName(runObj,name)` returns one or more signal IDs for signals in the Simulink.sdi.Run object with the specified name, name.

Examples

Get Signal IDs by Signal Name

You can access signal IDs for signals inside a Simulink.sdi.Run object by specifying the name of the signal for which you want the signal ID. You can use the signal ID to compare signals using the Simulink.sdi.compareSignals function, access the Simulink.sdi.Signal object for the signal using the Simulink.sdi.getSignal function, or delete the signal from the Simulation Data Inspector using the Simulink.sdi.deleteSignal function.

This example shows how to use the getSignalIDsByName function to access a signal using its name or its block path and how to access the signal ID for a signal contained inside a bus.

Create Data in the Simulation Data Inspector

This example uses a model of a pulse counter to create simulation data in the Simulation Data Inspector. The model has two input signals that define the upper and lower limits for the counter, and one input pulse signal with pulses to count. The model uses buses to send data into the Bus Counter subsystem and out of it to an Outport block. The model is configured to log the pulse signal, input, and the output signal, OUT, which is connected to the Outport block.

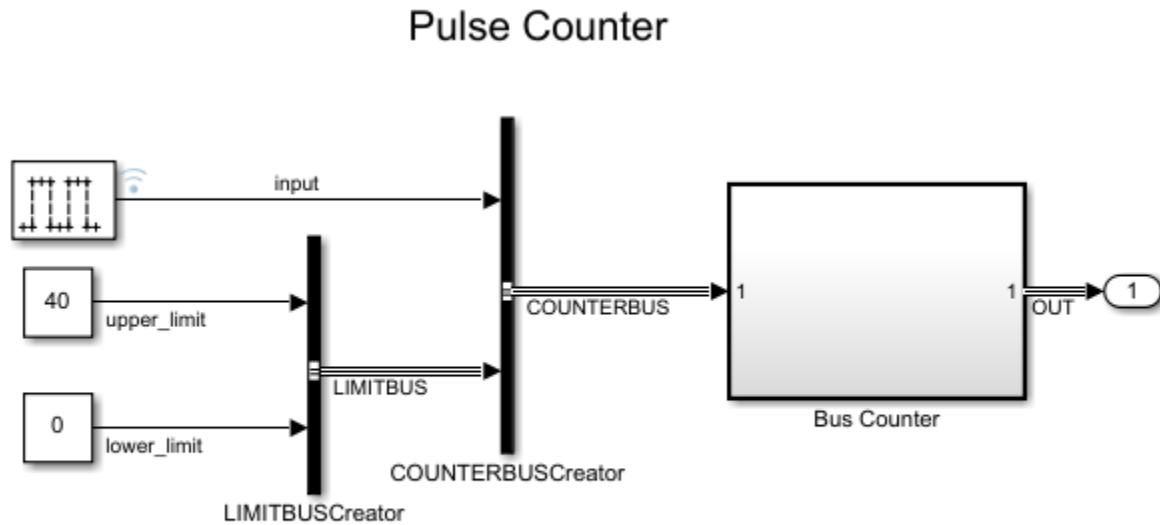

Copyright 1990-2014 The MathWorks, Inc.

Simulate the model to create a run that contains the logged data in the Simulation Data Inspector.

```
out = sim('ex_pulse_counter');
```

Access Signal IDs

Use the Simulation Data Inspector programmatic interface to access the logged data. The `Simulink.sdi.Run.getLatest` function returns the `Simulink.sdi.Run` object that corresponds to the most recently created run. You can access the signal IDs for logged signals from the `Simulink.sdi.Run` object.

```
countRun = Simulink.sdi.Run.getLatest;
```

Use the `getSignalIDsByName` function to access the signal ID for the input signal.

```
inSigID = getSignalIDsByName(countRun, 'input');
```

In a more complicated model, multiple signals might have the same name. In that case, using only the signal name with the `getSignalIDsByName` function results in an array of signal IDs for all logged signals in the model that use that name. To avoid duplicate results, you can specify the block path and signal name together. Use dots to separate elements of the block path instead of slashes. For example, to access the signal ID for the input signal, you could also specify the name as `'ex_pulse_counter.Pulse Generator.input'`.

```
inSigID = getSignalIDsByName(countRun, 'ex_pulse_counter.Pulse Generator.input');
```

Access Signal IDs for Signals Inside Composite Signals

The output logged in the `ex_pulse_counter` model is a bus signal. You can access the signal ID that corresponds to the top bus signal, `OUT`, the nested bus, `LIMITBUS`, and the individual signals in the bus: `output`, `upper_limit`, and `lower_limit`.

To access the signal ID for the top bus, specify the signal name, `OUT`.

```
OUTSigID = getSignalIDsByName(countRun, 'OUT');
```

To access the signal ID for the nested bus, specify the path to the signal in the bus hierarchy.

```
LIMITBUSSigID = getSignalIDsByName(countRun, 'OUT.LIMITBUS');
```

To access the signal ID for one of the individual signals, specify the path to the signal in the bus hierarchy. You cannot access the signal using only the signal name. The `Name` property of the `Signal` object includes the bus hierarchy.

```
upper_limitSigID = getSignalIDsByName(countRun, 'OUT.LIMITBUS.upper_limit');
upper_limitSig = Simulink.sdi.getSignal(upper_limitSigID);
upper_limitSig.Name
```

```
ans =
'OUT.LIMITBUS.upper_limit'
```

Input Arguments

runObj — Run containing signals with IDs you want to access

`Simulink.sdi.Run` object

Run containing the signals with the signal IDs you want to access, specified as a `Simulink.sdi.Run` object.

name — Name of signal with ID you want to access

character vector | string

Name of the signal with the signal ID you want to access, specified as a character vector or string.

A model can use the same signal name for more than one signal. In that case, when you want to access the signal ID for a specific signal, you can include the block path for the block that produces the signal in the name argument. For example, specify name as `'slexAircraftExample.Pilot.Stick'` to access the signal ID for the signal named `Stick` that is the output of the `Pilot` block in the `slexAircraftExample` model.

To access signals inside composite signals, specify the path to the signal through the hierarchy of the composite signal. For example, specify name as `'COUNTERBUS.LIMITBUS.lower_limit'` to access the signal ID for the `lower_limit` signal inside the bus `LIMITBUS` that is nested in the bus `COUNTERBUS`.

Data Types: `char` | `string`

Output Arguments

sigIDs — Signal IDs for signals with specified name

scalar | array

One or more signal IDs for signals with the specified name, returned as a scalar or array.

See Also

`Simulink.sdi.compareSignals` | `Simulink.sdi.deleteSignal` | `Simulink.sdi.getSignal` | `getSignalsByName`

Topics

“Inspect and Compare Data Programmatically”

Introduced in R2020a

getSignalsByName

Package: Simulink.sdi

Access signals in a Simulink.sdi.Run object using signal name

Syntax

```
sigs = getSignalsByName(runObj,name)
```

Description

`sigs = getSignalsByName(runObj,name)` returns one or more `Simulink.sdi.Signal` objects with the name specified by `name`.

Examples

Access Simulink.sdi.Signal Objects by Name

You can use the Simulation Data Inspector programmatic interface to access `Simulink.sdi.Signal` objects that correspond to logged or imported data. Using the `getSignalsByName` function, you can specify the name of the signal you want to get from a `Simulink.sdi.Run` object. You can access data for individual signals and composite signals.

Create Data in the Simulation Data Inspector

This example uses a model of a pulse counter to create simulation data in the Simulation Data Inspector. The model has two input signals that define the upper and lower limit for the counter, and one input pulse signal with pulses to count. The model uses buses to send data into the `Bus Counter` subsystem and out of it to an `Outport` block. The model is configured to log the pulse signal, `input`, and the output connected to the `Outport` block.

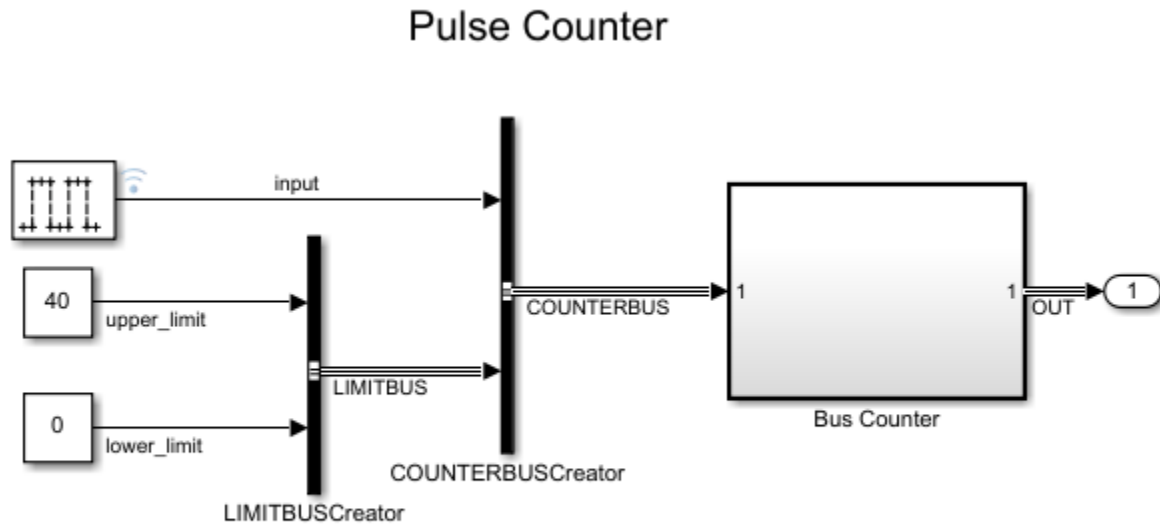

Copyright 1990-2014 The MathWorks, Inc.

Simulate the model to create a run that contains the logged data in the Simulation Data Inspector.

```
out = sim('ex_pulse_counter');
```

Access Signals in the Simulation Data Inspector

Use the Simulation Data Inspector programmatic interface to access the logged data. The `Simulink.sdi.Run.getLatest` function returns the `Simulink.sdi.Run` object that corresponds to the most recently created run.

```
countRun = Simulink.sdi.Run.getLatest;
```

Use the `getSignalsByName` function to access the input signal. Check the `Name` property of the returned `Simulink.sdi.Signal` object.

```
inSig = getSignalsByName(countRun, 'input');
inSig.Name
```

```
ans =
'input'
```

The input signal is not a composite signal, so the `Children` property of the `Signal` object is empty.

```
inChildren = inSig.Children;
size(inChildren)
```

```
ans = 1x2
```

```
0    0
```

Now, use the `getSignalsByName` function to access the output signal, `OUT`. `OUT` is a bus signal that contains the output signal from the counter, `output`, and the counter limit signals, `upper_limit` and `lower_limit`, in a nested bus named `LIMITBUS`.

```
outSig = getSignalsByName(countRun, 'OUT');
```

Check the Name and Children properties for the returned Signal object. The Children property value contains two Signal objects that correspond to the signals at the next level of hierarchy in the OUT bus.

```
outSig.Name
```

```
ans =  
'OUT'
```

```
outChildren = outSig.Children;  
size(outChildren)
```

```
ans = 1×2  
     1     2
```

Because the Signal object `outSig` corresponds to a composite signal, you cannot plot the signal data in the Simulation Data Inspector using the Checked property or the `plotOnSubPlot` function. To plot data in the composite signal, access the individual Signal objects.

Access Signals Inside a Composite Signal

You can access the signals inside the OUT bus and LIMITBUS by indexing into the Children property of the corresponding Signal object. For example, you can access the output signal from the OUT bus Signal object.

```
outChildren = outSig.Children;  
outputSig = outChildren(1);  
outputSig.Name
```

```
ans =  
'OUT.output'
```

You can also get the Signal object for the output signal by specifying the path to the signal through the bus hierarchy.

```
outputSig = getSignalsByName(countRun, 'OUT.output');  
outputSig.Name
```

```
ans =  
'OUT.output'
```

To access the `upper_limit` signal, specify the full path to the signal within the bus.

```
upper_limitSig = getSignalsByName(countRun, 'OUT.LIMITBUS.upper_limit');  
upper_limitSig.Name
```

```
ans =  
'OUT.LIMITBUS.upper_limit'
```

Input Arguments

runObj — Run containing signals you want to access

Simulink.sdi.Run object

Run containing the signals you want to access, specified as a `Simulink.sdi.Run` object.

name — Name of signal you want to access

character vector | string

Name of the signal you want to access, specified as a character vector or string.

A model can use the same signal name for more than one signal. In that case, when you want to access a specific signal, you can include the block path for the block that produces the signal in the name argument. For example, specify name as `'slexAircraftExample.Pilot.Stick'` to access the signal named `Stick` that is the output of the `Pilot` block in the `slexAircraftExample` model.

To access signals inside composite signals, specify the path to the signal through the hierarchy of the composite signal. For example, specify name as `'COUNTERBUS.LIMITBUS.lower_limit'` to access the `lower_limit` signal inside the bus `LIMITBUS` that is nested in the bus `COUNTERBUS`.

Data Types: `char` | `string`

Output Arguments

sigs — Signals matching specified name

`Simulink.sdi.Signal` object | array of `Simulink.sdi.Signal` objects

One or more signals matching the specified name, returned as a `Simulink.sdi.Signal` object or an array of `Simulink.sdi.Signal` objects.

See Also

`Simulink.sdi.compareSignals` | `Simulink.sdi.deleteSignal` | `Simulink.sdi.getSignal` | `getSignalIDsByName`

Topics

"Inspect and Compare Data Programmatically"

Introduced in R2020a

isValidSignalID

Package: Simulink.sdi

Check whether signal ID corresponds to signal in Simulink.sdi.Run object

Syntax

```
isValid = isValidSignalID(runObj,sigID)
```

Description

`isValid = isValidSignalID(runObj,sigID)` returns the logical indication `isValid` of whether the signal ID `sigID` corresponds to a signal in the Simulink.sdi.Run object `runObj`.

Input Arguments

runObj — Run in Simulation Data Inspector

Simulink.sdi.Run object

Run in the Simulation Data Inspector, specified as a Simulink.sdi.Run object.

sigID — Signal ID

integer

Unique numeric signal identifier, specified as an integer. The Simulation Data Inspector assigns a signal ID to each signal when a run is created. You can get the signal ID for a signal using one of these functions:

- `getAllSignalIDs`
- `getSignalIDByIndex`
- `getSignalIDsByName`
- `Simulink.sdi.createRun`

Output Arguments

isValid — Signal validity

logical

Signal validity, returned as a logical 1 or 0.

- 1 — The specified signal ID corresponds to a signal in the specified run.
- 0 — The specified signal ID does not correspond to a signal in the specified run.

See Also

Objects

Simulink.sdi.Run | Simulink.sdi.Signal

Functions

getSignalIDByIndex | getAllSignalIDs | Simulink.sdi.compareSignals

Tools

Simulation Data Inspector

Topics

“Inspect and Compare Data Programmatically”

Introduced in R2012b

Simulink.sdi.save

Package: Simulink.sdi

Save Simulation Data Inspector session

Syntax

```
Simulink.sdi.save(fileName)
```

Description

`Simulink.sdi.save(fileName)` saves all runs, signals, and visualization settings as a Simulation Data Inspector session in the file `fileName`.

A session file includes data as well as visualization information. Use the `Simulink.sdi.load` function to open a session file in the Simulation Data Inspector. When the session file opens, you can choose to add the data to existing data in the Simulation Data Inspector or clear the existing data.

You can also save only the visualization information to apply to other sets of data. Save visualization information for reuse in a view file using the `Simulink.sdi.saveView` function.

Examples

Save a Simulation Data Inspector Session

This example creates, saves, and loads a Simulation Data Inspector session. The example logs data in the model `slexAircraftExample` and visualizes the logged data in a Simulation Data Inspector session. Each time you use the Simulation Data Inspector, you create and modify a session. You can save the data and associated visualization settings for a session in an MLDATX file using the `Simulink.sdi.save` function. When you want to review the data later, you can load the session using the `Simulink.sdi.load` function.

Log Data to the Simulation Data Inspector

This example logs data from a simulation of the model `slexAircraftExample` to the Simulation Data Inspector. The model is not configured to log data. Load the model and mark the `Stick`, the `alpha`, `rad`, and the `q`, `rad/sec` signals for logging.

```
load_system('slexAircraftExample')

Simulink.sdi.markSignalForStreaming('slexAircraftExample/Pilot',1,'on')
Simulink.sdi.markSignalForStreaming('slexAircraftExample/Aircraft Dynamics Model',3,'on')
Simulink.sdi.markSignalForStreaming('slexAircraftExample/Aircraft Dynamics Model',4,'on')
```

For this example, run two simulations of the model. In the first simulation, use the sine wave output from the `Pilot` block, and in the second, use the square wave output.

```
set_param('slexAircraftExample/Pilot','WaveForm','sine')
sim('slexAircraftExample')
```

```
set_param('slexAircraftExample/Pilot','WaveForm','square')
sim('slexAircraftExample')
```

Visualize the Logged Data

You can use the Simulation Data Inspector programmatic interface to access the logged data from the simulations. When you access data using the Simulation Data Inspector programmatic interface, you can use functions to create plots in the Simulation Data Inspector.

To start, access the run IDs for the most recent two runs and then get the corresponding `Simulink.sdi.Run` object. The Run objects allow you to access the logged data for the simulations.

```
runIDs = Simulink.sdi.getAllRunIDs;
sineRunID = runIDs(end-1);
squareRunID = runIDs(end);

sineRun = Simulink.sdi.getRun(sineRunID);
squareRun = Simulink.sdi.getRun(squareRunID);
```

Suppose you want to analyze the relationship between the input and output for the model. Get the `Simulink.sdi.Signal` objects for the input and output signals from the two simulation runs.

```
sineOut = getSignalByIndex(sineRun,1);
sineIn = getSignalByIndex(sineRun,3);

squareOut = getSignalByIndex(squareRun,1);
squareIn = getSignalByIndex(squareRun,3);
```

Change the subplot layout in the Simulation Data Inspector to 2-by-1 and plot the signals from the first simulation run on the top plot and the signals from the second run on the bottom plot.

```
Simulink.sdi.setSubPlotLayout(2,1)

plotOnSubPlot(sineIn,1,1,true)
plotOnSubPlot(sineOut,1,1,true)

plotOnSubPlot(squareIn,2,1,true)
plotOnSubPlot(squareOut,2,1,true)
```

Save the Simulation Data Inspector Session

To view the plotted data in the Simulation Data Inspector, enter `Simulink.sdi.view` in the command window.

Then, save the Simulation Data Inspector session as an MLDATX file.

```
Simulink.sdi.save('myData.mldatx')
```

Load the Simulation Data Inspector Session

To mimic a scenario where you want to return to looking at the same data at a later point, clear the data from the Simulation Data Inspector and reset the subplot layout to 1-by-1.

```
Simulink.sdi.clear
Simulink.sdi.setSubPlotLayout(1,1)
```

Load the session file and resume working with the data. You can open the Simulation Data Inspector and view the results using the `Simulink.sdi.view` function.

```
Simulink.sdi.load('myData.mldatx');
```

Input Arguments

fileName — File name

character vector

Name for the session file.

Example: 'myData.mldatx'

See Also

[Simulink.sdi.close](#) | [Simulink.sdi.load](#) | [Simulink.sdi.saveView](#)

Topics

“Inspect and Compare Data Programmatically”

“Save and Share Simulation Data Inspector Data and Views”

Introduced in R2011b

Simulink.sdi.saveView

Save visualization settings to apply to other data

Syntax

```
Simulink.sdi.saveView(filename)
```

Description

`Simulink.sdi.saveView(filename)` saves the current view in the Simulation Data Inspector to the file, `filename`.

A view contains information about the layout and plots in the graphical viewing area as well as properties of plotted signals. When you load a view, the Simulation Data Inspector uses the properties and preferences in the file to display data currently in the Simulation Data Inspector. Signals in the Simulation Data Inspector that align with the signals in the view are plotted in the graphical viewing area. Use a view to apply a consistent set of visualization settings to multiple sets of similar data.

The view file saves the following information:

- Subplot layout and visualization type
- Settings for each visualization type in the layout
- Signal selection mode
- Replay controls visibility
- Metadata displayed in the work area
- Settings for signal grouping in the work area
- Plotted signals and the line style and color for each plotted signal

A view file does not contain data. To save run data, export the data or save a session using the `Simulink.sdi.save` function.

Examples

Save and Use a View

This example visualizes the output from the `ex_vdp` model, saves the configuration as a view, and then uses the view to visualize the output from another simulation of the same model.

To generate data to plot in the Simulation Data Inspector, simulate the model.

```
open_system('ex_vdp')
set_param('ex_vdp/Mu', 'Gain', '1')
sim('ex_vdp');
```

Programmatically Configure and Save a View

The `ex_vdp` model is configured to log two signals, `x1` and `x2`. Plot each signal on a subplot in a 2-by-1 layout.

```
Simulink.sdi.setSubPlotLayout(2,1)
```

To plot one signal on each subplot, first access the `Simulink.sdi.Run` object for the simulation.

```
runIDs = Simulink.sdi.getAllRunIDs;
ex_vdpRunID = runIDs(end);
ex_vdpRun = Simulink.sdi.getRun(ex_vdpRunID);
```

Then, you can access the data for each signal in a `Simulink.sdi.Signal` object and use the `plotOnSubPlot` function to specify where to plot each signal.

```
x1 = getSignalByIndex(ex_vdpRun,1);
x2 = getSignalByIndex(ex_vdpRun,2);
```

```
plotOnSubPlot(x1,1,1,true)
plotOnSubPlot(x2,2,1,true)
```

To view the result in the Simulation Data Inspector, enter `Simulink.sdi.view` in the command window.

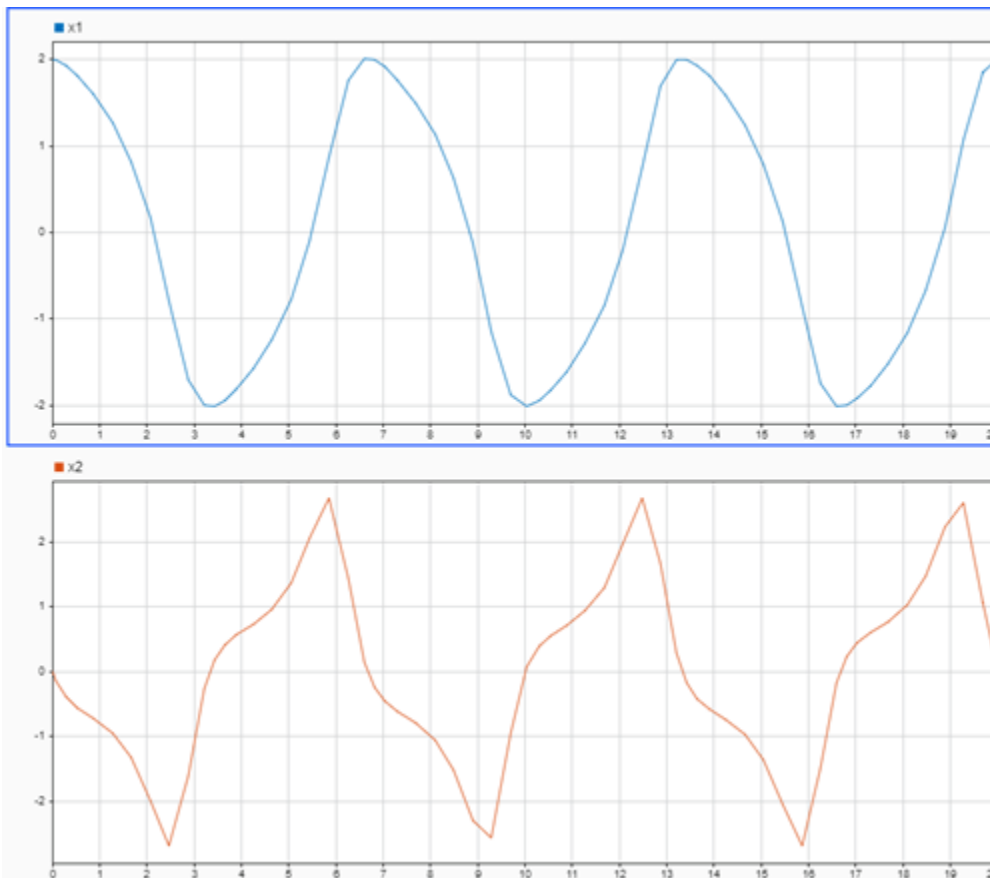

Then, save the view.

```
Simulink.sdi.saveView('ex_vdpView.mldatx')
```

Use the View

To mimic a situation where the Simulation Data Inspector is configured differently and contains data from another simulation, this example clears data from the Simulation Data Inspector, loads a view that represents the default visualization configuration, and runs another simulation of the `ex_vdp` model.

```
Simulink.sdi.clear
Simulink.sdi.loadView('default.mldatx');
set_param('ex_vdp/Mu', 'Gain', '2')
sim('ex_vdp');
```

Use the `Simulink.sdi.loadView` function to apply the saved view from the previous simulation.

```
Simulink.sdi.loadView('ex_vdpView.mldatx')
```

You can open the Simulation Data Inspector to view the results using the `Simulink.sdi.view` function. The saved view includes information regarding the axes limits. When you use a view to apply visualization settings, you may need to adjust axes limits or zoom levels to fit data from a modified simulation.

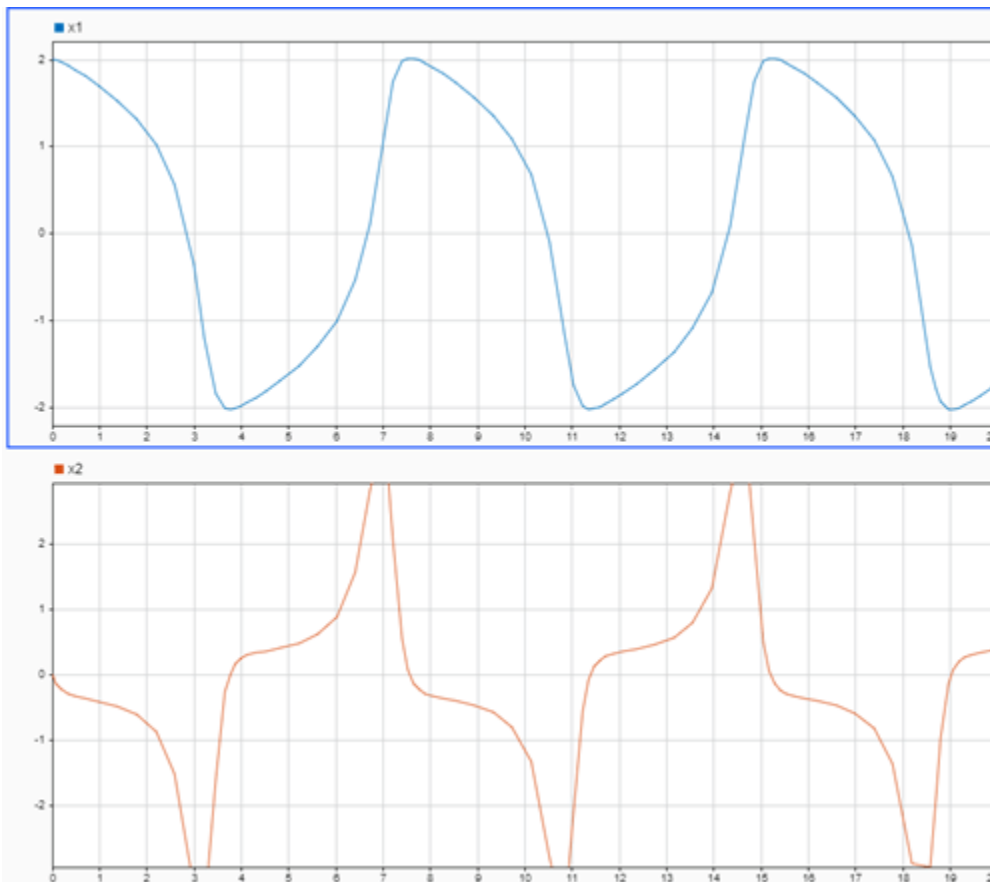

Input Arguments

filename — Name of view file

string | character array

Name of the view file, specified as a string or character array.

Example: 'myView.mldatx'

Data Types: char | string

See Also

[Simulink.sdi.loadView](#) | [Simulink.sdi.setBorderOn](#) | [Simulink.sdi.setGridOn](#) | [Simulink.sdi.setMarkersOn](#) | [Simulink.sdi.setSubPlotLayout](#) | [Simulink.sdi.setTableGrouping](#) | [Simulink.sdi.setTickLabelsDisplay](#) | [Simulink.sdi.setTicksPosition](#) | [Simulink.sdi.copyRunViewSettings](#)

Topics

“Save and Share Simulation Data Inspector Data and Views”

Introduced in R2020a

Simulink.sdi.sendWorkerRunToClient

Package: Simulink.sdi

Send run created on parallel workers to the Simulation Data Inspector

Syntax

```
Simulink.sdi.sendWorkerRunToClient  
Simulink.sdi.sendWorkerRunToClient(run)
```

Description

`Simulink.sdi.sendWorkerRunToClient` sends the run most recently generated by the worker to the client MATLAB and imports the run to the Simulation Data Inspector.

`Simulink.sdi.sendWorkerRunToClient(run)` sends the run corresponding to `run` to the client MATLAB and imports the run to the Simulation Data Inspector.

Examples

Manually Send Runs from Parallel Workers to the Simulation Data Inspector

This example shows how to use `Simulink.sdi.sendWorkerRunToClient` to send runs created using parallel workers manually to the Simulation Data Inspector.

Setup

This example runs several simulations of the `vdp` model, varying the value of the gain, `Mu`. To set up for the parallel simulation, define a vector of `Mu` values and configure the Simulation Data Inspector for manual Parallel Computing Toolbox support.

```
% Enable manual Parallel Computing Toolbox support  
Simulink.sdi.enablePCTSupport('manual');
```

```
% Choose several Mu values  
MuVals = [1 2 3 4];
```

Initialize Parallel Workers

Use `parpool` (Parallel Computing Toolbox) to start a pool of four parallel workers. This example calls `parpool` inside an `if` statement so you only create a parallel pool if you don't already have one. You can use `spmd` (Parallel Computing Toolbox) to run initialization code common to all workers. For example, load the `vdp` model and select signals to log to runs that we can send to the Simulation Data Inspector on the client MATLAB. To avoid data concurrency issues when simulating with `sim` in `parfor`, create a temporary directory on each worker. After the simulations complete, another `spmd` block deletes the temporary directories.

```
p = gcp('nocreate');  
  
if isempty(p)
```

```

    parpool(4);

end

Starting parallel pool (parpool) using the 'local' profile ...
connected to 4 workers.

spmd

    % Load system and select signals to log
    load_system('vdp')
    Simulink.sdi.markSignalForStreaming('vdp/x1',1,'on')
    Simulink.sdi.markSignalForStreaming('vdp/x2',1,'on')

    % Create temporary directory for simulation on worker
    workDir = pwd;
    addpath(workDir)
    tempDir = tempname;
    mkdir(tempDir)
    cd(tempDir)

end

```

Run Parallel Simulations with parfor

To stream data from parallel workers to the Simulation Data Inspector, you have to run parallel simulations using `parfor` (Parallel Computing Toolbox). Each worker runs a `vdp` simulation with a different value of `Mu`. Simulink cannot access the contents of the `parfor` loop, so the variable `MuVal` is defined in the worker's workspace, where the `vdp` model can see it, using `assignin`.

```

parfor (index = 1:4)

    % Set value of Mu in the worker's base workspace
    assignin('base','MuVal',MuVals(index));

    % Modify the value of Mu in the model and simulate
    set_param('vdp/Mu','Gain','MuVal')
    sim('vdp')

```

Access Data and Send Run to Client MATLAB

You can use the Simulation Data Inspector programmatic interface on the worker the same way you would in the client MATLAB. This example creates a `Simulink.sdi.Run` object and attaches the value of `Mu` used in the simulation with the `Tag` property.

```

    % Attach metadata to the run
    IDs = Simulink.sdi.getAllRunIDs;
    lastIndex = length(IDs);
    runID = Simulink.sdi.getRunIDByIndex(lastIndex);
    parRun = Simulink.sdi.getRun(runID);
    parRun.Tag = strcat('Mu = ',num2str(MuVals(index)));

    % Send the run to the Simulation Data Inspector on the client MATLAB
    Simulink.sdi.sendWorkerRunToClient

end

```

Close Temporary Directories and View Runs in the Simulation Data Inspector

Use another `spmd` section to delete the temporary directories created on the workers once the simulations complete. In each simulation, `Simulink.sdi.sendWorkerRunToClient` imported runs from all the workers into the Simulation Data Inspector. You can view the data and check the run properties to see the value of `Mu` used during simulation.

```
spmd
```

```
    % Remove temporary directories
    cd(workDir)
    rmdir(tempDir, 's')
    rmpath(workDir)
```

```
end
```

```
Simulink.sdi.view
```

Input Arguments

run — Run ID or `Simulink.sdi.Run` object

runID | `Simulink.sdi.Run` object

Run ID or `Simulink.sdi.Run` object corresponding to the run you want to import into the Simulation Data Inspector.

See Also

`Simulink.sdi.enablePCTSupport` | `Simulink.sdi.WorkerRun` |
`Simulink.sdi.cleanupWorkerResources` | `Simulink.sdi.isPCTSupportEnabled`

Topics

“Inspect and Compare Data Programmatically”

Introduced in R2018a

Simulink.sdi.setArchiveRunLimit

Package: Simulink.sdi

Specify a limit for the number of runs stored in the Simulation Data Inspector archive

Syntax

```
Simulink.sdi.setArchiveRunLimit(limit)
```

Description

`Simulink.sdi.setArchiveRunLimit(limit)` sets the Simulation Data Inspector archive limit as specified by `limit`. When the number of runs in the archive reaches the limit, the Simulation Data Inspector starts to delete runs from the archive on a first-in, first-out basis. When another run enters the archive, the Simulation Data Inspector deletes the run that has been in the archive the longest. A `limit` of `-1` indicates that the archive has no limit for the number of runs it stores. A `limit` of `0` means that the archive cannot contain any runs.

Tip To retain data for only the current run, configure the Simulation Data Inspector to automatically archive runs and set the archive run limit to `0`.

Examples

Configure the Simulation Data Inspector Archive

You can configure the Simulation Data Inspector to retain only the logged data for your current simulation. In iterative design and debugging workflows, this configuration helps prevent accumulation of unwanted logged data on disk. First, check the configuration of the Simulation Data Inspector archive. You can save the parameters to restore your preferences after you finish designing or debugging.

```
limit = Simulink.sdi.getArchiveRunLimit;  
mode = Simulink.sdi.getAutoArchiveMode;
```

Set the archive limit to `0` and configure the Simulation Data Inspector to automatically archive simulation runs.

```
Simulink.sdi.setArchiveRunLimit(0)  
Simulink.sdi.setAutoArchiveMode(true)
```

When you simulate your model, the Simulation Data Inspector deletes the previous run and updates the view to show signals in the current simulation.

When you finish designing or debugging your model, you can restore the Simulation Data Inspector archive back to its previous configuration.

```
Simulink.sdi.setArchiveRunLimit(limit)  
Simulink.sdi.setAutoArchiveMode(mode)
```

Input Arguments

limit — Maximum number of runs to store in the Simulation Data Inspector archive

scalar

Limit for the number of runs stored in the Simulation Data Inspector archive. When the number of runs in the archive reaches the limit, the Simulation Data Inspector starts to delete runs from the archive, on a first-in, first-out basis. A `limit` of `-1` indicates that there is no limit on the runs stored in the archive. A `limit` of `0` indicates that the archive cannot contain any runs.

Example: `-1`

Example: `10`

See Also

`Simulink.sdi.getArchiveRunLimit` | `Simulink.sdi.setAutoArchiveMode` |
`Simulink.sdi.getAutoArchiveMode`

Topics

“Iterate Model Design Using the Simulation Data Inspector”

Introduced in R2018b

Simulink.sdi.setAutoArchiveMode

Package: Simulink.sdi

Specify whether the Simulation Data Inspector automatically archives simulation runs

Syntax

```
Simulink.sdi.setAutoArchiveMode(mode)
```

Description

`Simulink.sdi.setAutoArchiveMode(mode)` configures the automatic archive behavior of the Simulation Data Inspector, according to `mode`. The Simulation Data Inspector automatically archives simulation runs when you specify `mode` as `true`. When you specify `mode` as `false`, the Simulation Data Inspector does not automatically archive.

Examples

Configure the Simulation Data Inspector Archive

You can configure the Simulation Data Inspector to retain only the logged data for your current simulation. In iterative design and debugging workflows, this configuration helps prevent accumulation of unwanted logged data on disk. First, check the configuration of the Simulation Data Inspector archive. You can save the parameters to restore your preferences after you finish designing or debugging.

```
limit = Simulink.sdi.getArchiveRunLimit;  
mode = Simulink.sdi.getAutoArchiveMode;
```

Set the archive limit to 0 and configure the Simulation Data Inspector to automatically archive simulation runs.

```
Simulink.sdi.setArchiveRunLimit(0)  
Simulink.sdi.setAutoArchiveMode(true)
```

When you simulate your model, the Simulation Data Inspector deletes the previous run and updates the view to show signals in the current simulation.

When you finish designing or debugging your model, you can restore the Simulation Data Inspector archive back to its previous configuration.

```
Simulink.sdi.setArchiveRunLimit(limit)  
Simulink.sdi.setAutoArchiveMode(mode)
```

Input Arguments

mode — Logical specification of Simulation Data Inspector automatic archive behavior

`true` (default) | `false`

Logical value that specifies whether the Simulation Data Inspector automatically archives simulation runs.

- `true` — The Simulation Data Inspector automatically archives simulation runs.
- `false` — The Simulation Data Inspector does not automatically archive simulation runs.

Example: `false`

Data Types: `logical`

See Also

`Simulink.sdi.getAutoArchiveMode` | `Simulink.sdi.setArchiveRunLimit` | `Simulink.sdi.getArchiveRunLimit`

Topics

“Iterate Model Design Using the Simulation Data Inspector”

Introduced in R2018b

Simulink.sdi.setBorderOn

Display or hide border on time plots

Syntax

```
Simulink.sdi.setBorderOn(border)
```

Description

`Simulink.sdi.setBorderOn(border)` displays or hides the border on time plots in the Simulation Data Inspector according to the logical input, `border`. The function sets the value of the **Show border** setting on the **Time Plot** section of the **Visualization Settings** in the Simulation Data Inspector. The setting applies to all time plots in the layout. By default, the Simulation Data Inspector shows the border on time plots.

Examples

Configure Time Plot Border Display

You can use the `Simulink.sdi.setBorderOn` function to show or hide the border on time plots in the Simulation Data Inspector. By default, the Simulation Data Inspector shows the border on time plots.

This example starts by showing how to use the `Simulink.sdi.getBorderOn` function to determine whether the border is currently displayed. Subsequent sections show the code to hide and show the border. To show the result, the example generates an image using the `Simulink.sdi.snapshot` function with settings specified by a `Simulink.sdi.CustomSnapshot` object.

```
snapSettings = Simulink.sdi.CustomSnapshot;  
snapSettings.Width = 300;  
snapSettings.Height = 300;
```

Get Current Border Display Setting

Before modifying the border display setting for time plots, you can save the current setting to a variable in the workspace in case you want to restore the preference later.

```
border = Simulink.sdi.getBorderOn;
```

Hide the Border on Time Plots

```
Simulink.sdi.setBorderOn(false)  
Simulink.sdi.snapshot('from','custom','settings',snapSettings);
```

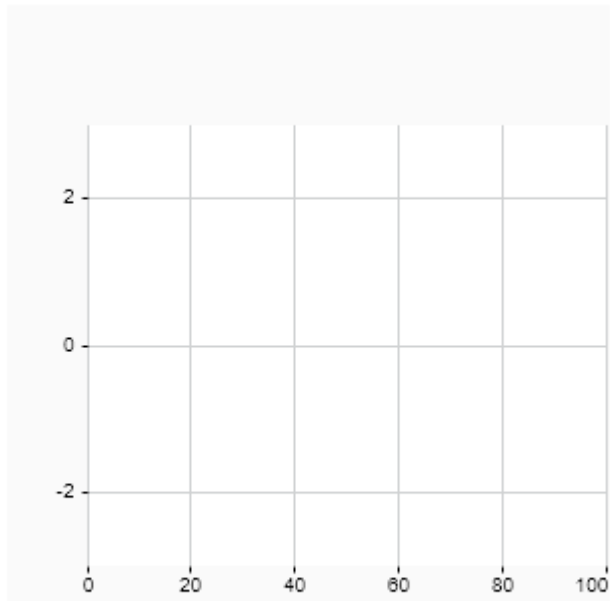

Show the Border on Time Plots

```
Simulink.sdi.setBorderOn(true)  
Simulink.sdi.snapshot('from', 'custom', 'settings', snapSettings);
```

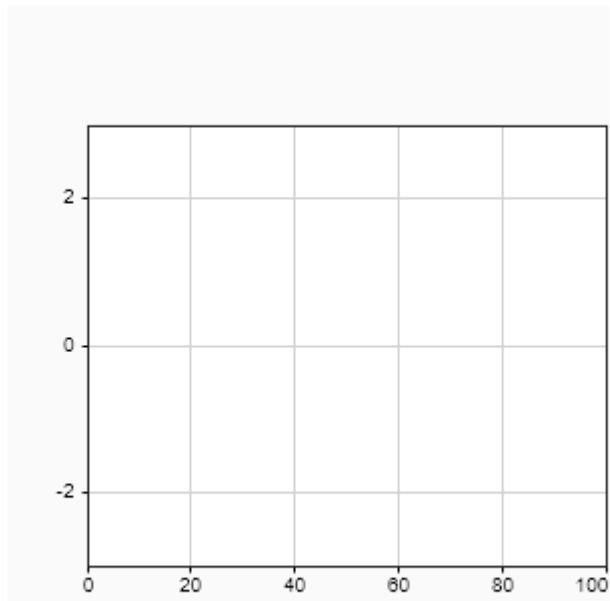

Input Arguments

border — Whether border is visible on time plots

`true` or `1` (default) | `false` or `0`

Whether the border is visible on time plots in the Simulation Data Inspector, specified as `true` (`1`) or `false` (`0`).

- `true` or `1` — Display border for time plots.
- `false` or `0` — Hide border for time plots.

See Also

`Simulink.sdi.getBorderOn` | `Simulink.sdi.setGridOn` | `Simulink.sdi.setMarkersOn` | `Simulink.sdi.setSubPlotLayout` | `Simulink.sdi.setTickLabelsDisplay` | `Simulink.sdi.setTicksPosition` | `Simulink.sdi.saveView` | `Simulink.sdi.save`

Topics

“Create Plots Using the Simulation Data Inspector”

Introduced in R2019b

Simulink.sdi.setCursorOptions

Configure shading options for cursors in the Simulation Data Inspector

Syntax

```
Simulink.sdi.setCursorOptions(Name,Value)
```

Description

`Simulink.sdi.setCursorOptions(Name,Value)` configures shading options for cursors in the Simulation Data Inspector according to one or more name-value pair arguments. For example, `'ShadeArea', 'InBetween'` configures the Simulation Data Inspector to apply shading to the area between two cursors. You can specify name-value pair arguments to configure the area to shade, the color and opacity of the shaded region, and whether signal data is emphasized in the shaded region.

Examples

Configure Shading Options for Cursors in the Simulation Data inspector

You can configure shading options for cursors to draw attention to a region of interest in a time plot. You can choose to emphasize or de-emphasize the signal data in the shaded region, and you can specify the shading color and opacity. By default, the Simulation Data Inspector shades areas gray with an opacity of 0.7 to de-emphasize signal data and shades areas light blue with an opacity of 0.7 when signal data is emphasized.

Suppose you want to highlight a signal transition by shading the area where the transition occurs a light yellow. Configure the cursors to highlight the area between the cursors a light yellow color.

```
Simulink.sdi.setCursorOptions('Emphasize',true,...  
    'ShadeArea','InBetween','ShadeColor',[1 1 0.6]);
```

Input Arguments

Name-Value Pair Arguments

Specify optional comma-separated pairs of `Name, Value` arguments. `Name` is the argument name and `Value` is the corresponding value. `Name` must appear inside quotes. You can specify several name and value pair arguments in any order as `Name1, Value1, ..., NameN, ValueN`.

Example: `'ShadeArea', 'Lead', 'ShadeOpacity', 0.5` configures cursors to shade the area that leads the left-most cursor with an opacity of 0.5.

Type — Where to apply cursor options

`'Inspect'` (default) | `'Compare'`

Where to apply cursor options, specified as the name-value pair consisting of `'Type'` and `'Inspect'` or `'Compare'`. You can configure independent cursor options for the **Inspect** and **Compare** panes in the Simulation Data Inspector.

Example: 'Type', 'Compare' configures cursor options for the **Compare** pane.

Emphasize — Whether signal data is emphasized in the shaded region

true or 1 (default) | false or 0

Whether signal data is emphasized in shaded region, specified as the name-value pair consisting of 'Emphasize' and true or false. When emphasized, the signal data is plotted on top of the cursor shading.

Example: 'Emphasize', false configures cursor options to plot signal data under shaded region.

ShadeArea — Area to shade relative to cursors

'lead' (default) | 'lag' | 'leadandlag' | 'inbetween' | 'none'

Area to shade relative to cursors, specified as the name-value pair consisting of 'ShadeArea' and one of these options:

- 'lead' — Shade the plot area that leads the left-most cursor.
- 'lag' — Shade the plot area that lags the right-most cursor.
- 'leadandlag' — Shade the plot area outside of the cursors, when two cursors are displayed.
- 'inbetween' — Shade the plot area between the cursors, when two cursors are displayed.
- 'none' — Do not shade any plot area.

Example: 'ShadeArea', 'none' configures cursor options to not shade any region relative to the cursors.

ShadeColor — Color of the shaded area

[r g b] vector

Color of the shaded area, specified as the name-value pair consisting of 'ShadeColor' and an r g b vector with values between 0 and 1.

Example: 'ShadeColor', [0 0 1] configures the color of the shaded area as blue.

ShadeOpacity — Opacity of the shaded area

percentage value between 0 and 1

Opacity of the shaded area, specified as the name-value pair consisting of 'ShadeOpacity' and a percentage value between 0 and 1.

Example: 'ShadeOpacity', 0.5 configures the opacity of the shaded area as 0.5.

See Also

Functions

Simulink.sdi.snapshot | Simulink.sdi.setSubPlotLayout

Topics

“Create Plots Using the Simulation Data Inspector”

Introduced in R2020a

Simulink.sdi.setCursorPositions

Specify active cursor positions in the Simulation Data Inspector

Syntax

```
Simulink.sdi.setCursorPositions(Name,Value)
```

Description

`Simulink.sdi.setCursorPositions(Name,Value)` configures the position for active cursors in the Simulation Data Inspector as specified by one or more name-value pair arguments.

Examples

Programmatically Interact with Cursors in the Simulation Data Inspector

You can use the Simulation Data Inspector programmatic interface to specify the position of cursors on time plots or sparklines and to access the time that corresponds to the current cursor position.

Open the session file `vdp_mu.mldatx` to add and plot data in the Simulation Data Inspector. The session file contains data for a 20-second simulation of a model of the Van Der Pol equation, with signals `x1` and `x2` plotted on separate subplots in a 2-by-1 subplot layout.

```
open vdp_mu.mldatx;
```

Use the `Simulink.sdi.setNumCursors` function to add one cursor to the plot.

```
Simulink.sdi.setNumCursors(1);
```

Suppose you want to know the signal values 5 seconds into the simulation. Use the `Simulink.sdi.setCursorPositions` function to move the cursor to `t=5s` and read the signal values off from the cursor on each subplot. The asterisk next to the value in the cursor label indicates that the value is interpolated because the simulation did not include a calculation for a simulation time of exactly 5s.

```
Simulink.sdi.setCursorPositions('left',5);
```

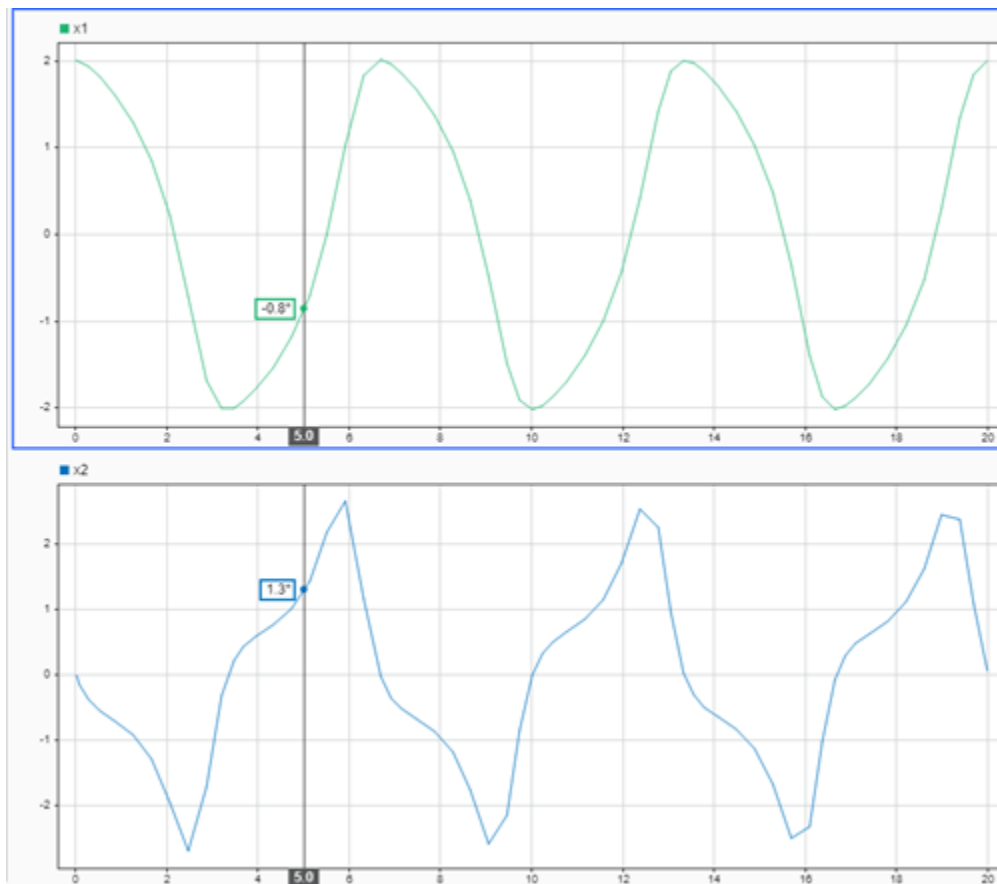

Suppose you want to calculate the time between two peaks in the x2 signal. Add a second cursor using the `Simulink.sdi.setNumCursors` function or using the **Show/hide data cursors** button in the Simulation Data Inspector.

```
numCursors = Simulink.sdi.getNumCursors;
if(numCursors < 2)
    Simulink.sdi.setNumCursors(2);
end
```

Drag the cursors so the left cursor is positioned at the first peak in the x2 signal and the right cursor is positioned at the second peak. Alternatively, run this code that positions the cursors for you.

```
Simulink.sdi.setCursorPositions('left',5.921998549931304,'right',12.378442136906246);
```

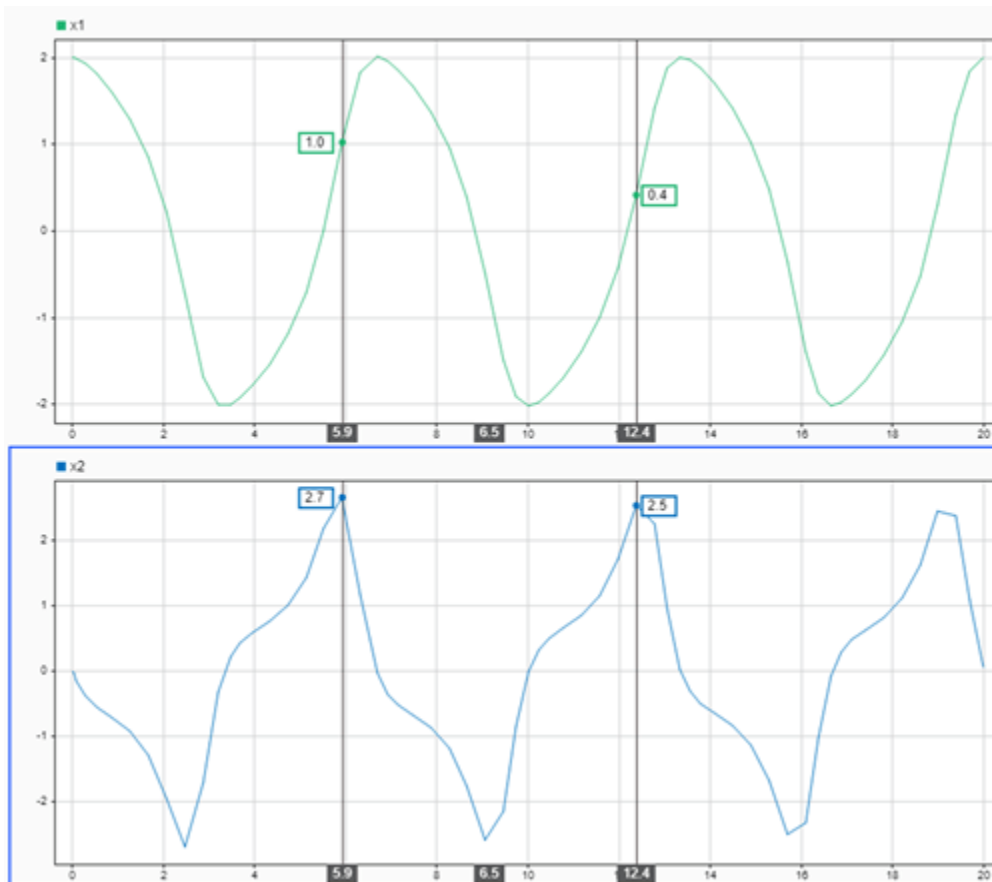

The Simulation Data Inspector displays the difference between the two cursors in seconds. However, the cursor position and difference values are both rounded. Use the `Simulink.sdi.getCursorPosition` function to programmatically retrieve the exact time values that correspond to the cursor positions. Then, compute the difference between the times.

```
[t1,t2] = Simulink.sdi.getCursorPosition;
T = t2 - t1
```

```
T = NaN
```

Input Arguments

Name-Value Pair Arguments

Specify optional comma-separated pairs of `Name, Value` arguments. `Name` is the argument name and `Value` is the corresponding value. `Name` must appear inside quotes. You can specify several name and value pair arguments in any order as `Name1, Value1, ..., NameN, ValueN`.

Example: `Simulink.sdi.setCursorPositions('right',10,'view','compare')` moves the right cursor on the **Compare** pane to 10s.

Left — Left cursor position

scalar

Left cursor position, specified as a finite scalar using units of s. Use the 'left' name-value pair argument to specify the position for a single active cursor.

Cursor identities are relative, not absolute. If you specify a value for the left cursor that moves it to the right of the right cursor, the left cursor becomes the right cursor and vice versa.

Example: `Simulink.sdi.setCursorPositions('left',0.5)` moves the left cursor to 500ms.

Data Types: double

right — Right cursor position

scalar

Right cursor position, specified as a finite scalar using units of s.

Cursor identities are relative, not absolute. If you specify a value for the left cursor that moves it to the right of the right cursor, the left cursor becomes the right cursor and vice versa.

Example: `Simulink.sdi.setCursorPositions('right',10)` moves the right cursor to 10s.

Tips

Use the 'left' name-value pair argument to specify the position for a single active cursor.

Data Types: double

view — Plot area on which to move cursors

'inspect' (default) | 'compare'

Plot area on which to move cursors, specified as 'inspect' or 'compare'.

Example: `Simulink.sdi.setCursorPositions('right',10,'view','compare')` moves the right cursor on the **Compare** pane to 10s.

Data Types: char | string

See Also

Functions

`Simulink.sdi.setCursorOptions` | `Simulink.sdi.getCursorPosition` | `Simulink.sdi.setNumCursors`

Topics

“Inspect Simulation Data”

“Create Plots Using the Simulation Data Inspector”

Introduced in R2021a

Simulink.sdi.setDeleteRunsOnLowSpace

Specify behavior when logged data size approaches configured limits

Syntax

```
Simulink.sdi.setDeleteRunsOnLowSpace(deleteRuns)
```

Description

`Simulink.sdi.setDeleteRunsOnLowSpace(deleteRuns)` configures the action to take when the size of logged data approaches the configured maximum size or minimum free disk space requirement. When `deleteRuns` is `true`, logged data from prior simulations is deleted first to free space for continued logging in the current simulation. If deleting prior simulation data does not free enough disk space to continue logging through the end of the current simulation, recording data is disabled. When `deleteRuns` is `false`, recording data from the current simulation is disabled and no logged data from prior simulations is deleted.

Examples

Configure Logged Data Size Limits

Logging data from simulation can produce large amounts of data that may fill up disk space. To mitigate issues related to filing disk space, you can specify a minimum disk space requirement, a maximum size for logged data, or both. To ensure the logged data does not exceed the specified maximum size or use enough disk space to violate the disk space requirement, prior run data may be deleted and recording logged data may be disabled. You can specify whether to prioritize continuing to log data in the current simulation or retaining prior simulation data.

Use the `Simulink.sdi.setRequiredFreeSpace` function to configure logging to leave at least 1 GB of disk space empty.

```
Simulink.sdi.setRequiredFreeSpace(1);
```

Use the `Simulink.sdi.setMaxDiskUsage` function to specify a maximum logged data size of 100 GB.

```
Simulink.sdi.setMaxDiskUsage(100);
```

When you configure logging size limits, you can also specify what to do when the logging limits are approached. You can choose whether to prioritize retaining data from prior runs or data in the current run.

By default, current simulation data is prioritized. If the size of logged data approaches configured limits, data from prior simulations is deleted. If deleting run data does not free enough space, recording logged data is disabled and no more data from the current simulation is saved. When you choose to prioritize logged data from prior simulations instead, recording is disabled as soon as the size of logged data approaches configured limits. You see a warning when run data is deleted and when recording is disabled.

Use the `Simulink.sdi.setDeleteRunsOnLowSpace` function to configure logging to prioritize retaining prior run data.

```
Simulink.sdi.setDeleteRunsOnLowSpace(false);
```

If recording is disabled due to the size of logged data, you need to enable recording again to save data from future simulations. Use the `Simulink.sdi.setRecordData` function to enable recording.

```
Simulink.sdi.setRecordData(true);
```

Input Arguments

deleteRuns — Behavior when logged data size approaches configured limits

`true` or `1` (default) | `false` or `0`

Behavior when logged data size approaches configured limits, specified as numeric or logical `1` (`true`) or `0` (`false`).

- `true` — First delete data logged from prior simulations. If deleting prior simulation data does not free enough space, disable recording data.
- `false` — Disable recording data for current simulation. Do not delete prior simulation data.

When recording is disabled due to configured disk space requirements or logged data size limits, you need to enable recording again to log data in subsequent simulations. You can configure the record mode in the Simulation Data Inspector preferences or using the `Simulink.sdi.setRecordData` function.

Data Types: `logical`

See Also

Functions

`Simulink.sdi.getDeleteRunsOnLowSpace` | `Simulink.sdi.setMaxDiskUsage` |
`Simulink.sdi.getMaxDiskUsage` | `Simulink.sdi.setRequiredFreeSpace` |
`Simulink.sdi.getRequiredFreeSpace` | `Simulink.sdi.setRecordData` |
`Simulink.sdi.getRecordData`

Topics

“Limit the Size of Logged Data”
“Configure the Simulation Data Inspector”

Introduced in R2021a

Simulink.sdi.setGridOn

Package: Simulink.sdi

Configure grid lines for time plots in the Simulation Data Inspector

Syntax

```
Simulink.sdi.setGridOn(grid)
```

Description

`Simulink.sdi.setGridOn(grid)` configures the grid lines for time plots in the Simulation Data Inspector according to the input, `grid`. The function configures the **Horizontal** and **Vertical** options on the **Time Plot** section of the **Visualization Settings** in the Simulation Data Inspector. The settings apply to the session and configure the grids for all time plots. By default, the Simulation Data Inspector shows horizontal and vertical grid lines.

Examples

Configure Grid for Time Plots in the Simulation Data Inspector

You can use `Simulink.sdi.setGridOn` to configure the appearance of the grid for time plots in the Simulation Data Inspector. By default, the Simulation Data Inspector shows horizontal and vertical grid lines.

This example starts by showing how to use `Simulink.sdi.getGridOn` to access the current grid configuration. The subsequent sections show the code for each configuration option for time plot grid in the Simulation Data Inspector. To see the result, the example uses a `Simulink.sdi.CustomSnapshot` object to specify settings for the output of the `Simulink.sdi.snapshot` function.

```
snapSettings = Simulink.sdi.CustomSnapshot;  
snapSettings.Width = 300;  
snapSettings.Height = 300;
```

Get Initial Grid Setting

Before modifying the grid display preferences, you can save the current configuration to a variable in the workspace in case you want to restore the preferences later.

```
gridInit = Simulink.sdi.getGridOn;
```

Configure Horizontal Grid Lines

Show only horizontal grid lines in the Simulation Data Inspector.

```
Simulink.sdi.setGridOn('horizontal')  
Simulink.sdi.snapshot('from', 'custom', 'settings', snapSettings);
```

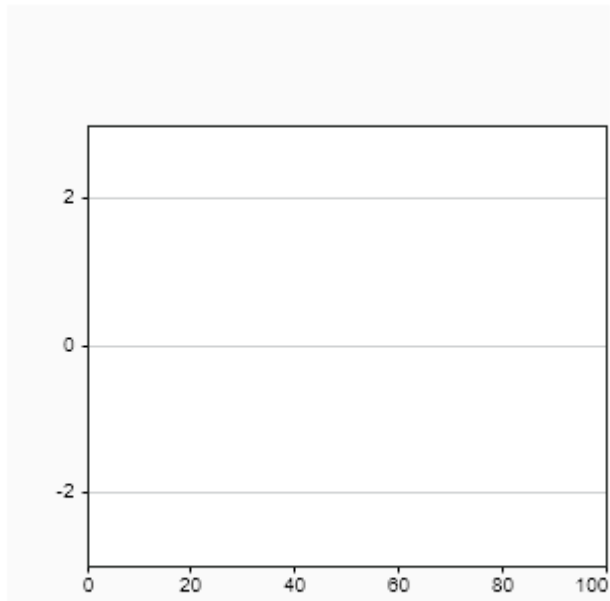

Configure Vertical Grid Lines

Show only vertical grid lines in the Simulation Data Inspector.

```
Simulink.sdi.setGridOn('vertical')  
Simulink.sdi.snapshot('from','custom','settings',snapSettings);
```

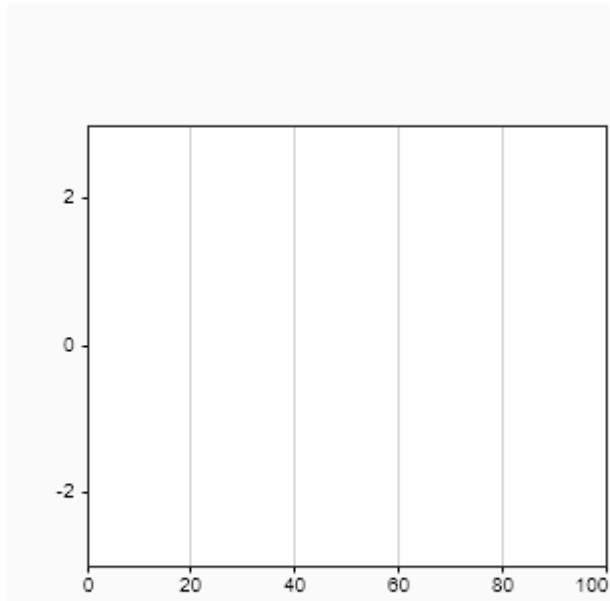

Configure No Grid Lines

Show no grid lines in the Simulation Data Inspector.

```
Simulink.sdi.setGridOn('off')  
Simulink.sdi.snapshot('from','custom','settings',snapSettings);
```

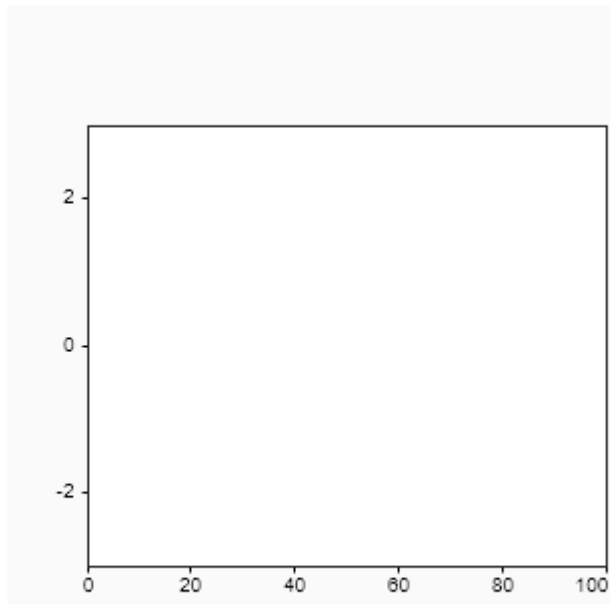

Configure Horizontal and Vertical Grid Lines

Show horizontal and vertical grid lines in the Simulation Data Inspector.

```
Simulink.sdi.setGridOn('on')  
Simulink.sdi.snapshot('from', 'custom', 'settings', snapSettings);
```

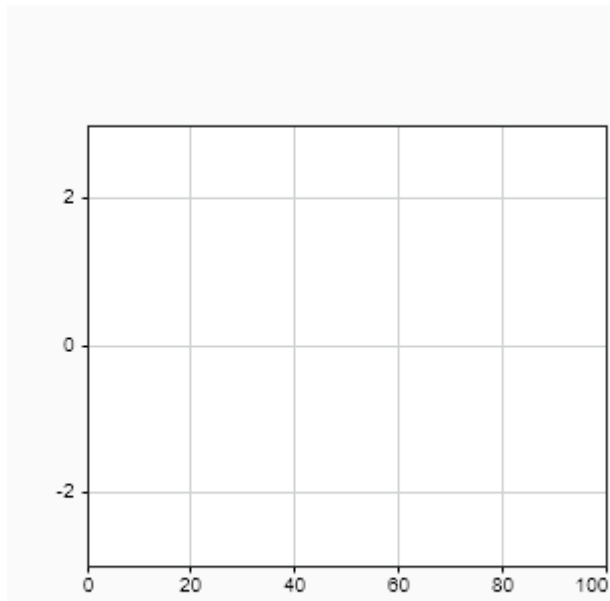

Input Arguments

grid — Visible grid lines

'on' (default) | 'horizontal' | 'vertical' | 'off'

Grid lines to show on time plots in the Simulation Data Inspector, specified as one of these options:

- 'on' — Horizontal and vertical grid lines
- 'horizontal' — Only horizontal grid lines
- 'vertical' — Only vertical grid lines
- 'off' — No grid lines

Compatibility Considerations

Specifying the input as a logical value is not recommended

Starting in R2019b, the `Simulink.sdi.setGridOn` input values changed to:

- 'on'
- 'horizontal'
- 'vertical'
- 'off'

In R2019a, the `Simulink.sdi.setGridOn` accepted a logical input to show or hide the grid on time plots in the Simulation Data Inspector:

- `true` or `1` shows horizontal and vertical grid lines on time plots in the Simulation Data Inspector.
- `false` or `0` hides horizontal and vertical grid lines on time plots in the Simulation Data Inspector.

Starting in R2019b, use the `'on'` input value for the same behavior as the `true` or `1` input, and use the `'off'` input value for the same behavior as the `false` or `0` input.

See Also

`Simulink.sdi.getGridOn` | `Simulink.sdi.setBorderOn` | `Simulink.sdi.setMarkersOn` |
`Simulink.sdi.setSubPlotLayout` | `Simulink.sdi.setTicksPosition` |
`Simulink.sdi.setTickLabelsDisplay` | `Simulink.sdi.clearPreferences` |
`Simulink.sdi.saveView` | `Simulink.sdi.save`

Topics

“Create Plots Using the Simulation Data Inspector”

“View Data in the Simulation Data Inspector”

Introduced in R2019a

Simulink.sdi.setMarkersOn

Package: Simulink.sdi

Show or hide markers for plotted signals

Syntax

```
Simulink.sdi.setMarkersOn(value)
```

Description

`Simulink.sdi.setMarkersOn(value)` shows or hides markers on signals plotted in the Simulation Data Inspector according to the logical input, `value`. The function configures the **Show markers** setting in the Simulation Data Inspector. The setting applies to the session and shows or hides markers for all signals plotted in the Simulation Data Inspector. By default, markers are hidden in the Simulation Data Inspector.

Examples

Display Markers in the Simulation Data Inspector

```
Simulink.sdi.setMarkersOn(true);
```

Input Arguments

`value` — Logical input

false or 0 (default) | true or 1

Logical specification of whether markers are shown on plots in the Simulation Data Inspector.

- true or 1 shows markers on plots in the Simulation Data Inspector.
- false or 0 does not show markers on plots in the Simulation Data Inspector.

Data Types: logical

See Also

`Simulink.sdi.getMarkersOn` | `Simulink.sdi.setBorderOn` |
`Simulink.sdi.setSubPlotLayout` | `Simulink.sdi.setGridOn` |
`Simulink.sdi.setTicksPosition` | `Simulink.sdi.setTickLabelsDisplay` |
`Simulink.sdi.clearPreferences` | `Simulink.sdi.saveView` | `Simulink.sdi.save`

Topics

“Inspect and Compare Data Programmatically”

Introduced in R2017b

Simulink.sdi.setMaxDiskUsage

Specify maximum size for data logged to disk

Syntax

```
Simulink.sdi.setMaxDiskUsage(maxSize)
```

Description

`Simulink.sdi.setMaxDiskUsage(maxSize)` configures logging to use no more than the maximum amount of disk space specified by `maxSize`, in units of GB.

When you configure a maximum size for logged data, you can also configure the behavior when logged data approaches the maximum size using the `Simulink.sdi.setDeleteRunsOnLowSpace` function. For more information, see “Specify a Minimum Disk Space Requirement or Maximum Size for Logged Data”.

Examples

Configure Logged Data Size Limits

Logging data from simulation can produce large amounts of data that may fill up disk space. To mitigate issues related to filing disk space, you can specify a minimum disk space requirement, a maximum size for logged data, or both. To ensure the logged data does not exceed the specified maximum size or use enough disk space to violate the disk space requirement, prior run data may be deleted and recording logged data may be disabled. You can specify whether to prioritize continuing to log data in the current simulation or retaining prior simulation data.

Use the `Simulink.sdi.setRequiredFreeSpace` function to configure logging to leave at least 1 GB of disk space empty.

```
Simulink.sdi.setRequiredFreeSpace(1);
```

Use the `Simulink.sdi.setMaxDiskUsage` function to specify a maximum logged data size of 100 GB.

```
Simulink.sdi.setMaxDiskUsage(100);
```

When you configure logging size limits, you can also specify what to do when the logging limits are approached. You can choose whether to prioritize retaining data from prior runs or data in the current run.

By default, current simulation data is prioritized. If the size of logged data approaches configured limits, data from prior simulations is deleted. If deleting run data does not free enough space, recording logged data is disabled and no more data from the current simulation is saved. When you choose to prioritize logged data from prior simulations instead, recording is disabled as soon as the size of logged data approaches configured limits. You see a warning when run data is deleted and when recording is disabled.

Use the `Simulink.sdi.setDeleteRunsOnLowSpace` function to configure logging to prioritize retaining prior run data.

```
Simulink.sdi.setDeleteRunsOnLowSpace(false);
```

If recording is disabled due to the size of logged data, you need to enable recording again to save data from future simulations. Use the `Simulink.sdi.setRecordData` function to enable recording.

```
Simulink.sdi.setRecordData(true);
```

Input Arguments

maxSize — Maximum size for data logged to disk

0 (default) | scalar

Maximum size for data logged to disk, specified as a scalar, in units of GB. To configure no limit on the size of logged data, specify 0.

Example: `Simulink.sdi.setMaxDiskUsage(500)` configures logging to use no more than 500 GB of disk space.

See Also

Functions

`Simulink.sdi.getMaxDiskUsage` | `Simulink.sdi.setRequiredFreeSpace` |
`Simulink.sdi.getRequiredFreeSpace` | `Simulink.sdi.setDeleteRunsOnLowSpace` |
`Simulink.sdi.getDeleteRunsOnLowSpace` | `Simulink.sdi.setRecordData` |
`Simulink.sdi.getRecordData`

Topics

“Limit the Size of Logged Data”
“Configure the Simulation Data Inspector”

Introduced in R2021a

Simulink.sdi.setNumCursors

Configure number of cursors active in Simulation Data Inspector

Syntax

```
Simulink.sdi.setNumCursors(num)
Simulink.sdi.setNumCursors(num,view)
```

Description

`Simulink.sdi.setNumCursors(num)` configures the Simulation Data Inspector to display the number of cursors specified by `num` in the **Inspect** pane plots.

`Simulink.sdi.setNumCursors(num,view)` configures the Simulation Data Inspector to display the number of cursors specified by `num` in the **Inspect** or **Compare** plot area, as specified by `view`.

Examples

Programmatically Interact with Cursors in the Simulation Data Inspector

You can use the Simulation Data Inspector programmatic interface to specify the position of cursors on time plots or sparklines and to access the time that corresponds to the current cursor position.

Open the session file `vdp_mu.mldatx` to add and plot data in the Simulation Data Inspector. The session file contains data for a 20-second simulation of a model of the Van Der Pol equation, with signals `x1` and `x2` plotted on separate subplots in a 2-by-1 subplot layout.

```
open vdp_mu.mldatx;
```

Use the `Simulink.sdi.setNumCursors` function to add one cursor to the plot.

```
Simulink.sdi.setNumCursors(1);
```

Suppose you want to know the signal values 5 seconds into the simulation. Use the `Simulink.sdi.setCursorPositions` function to move the cursor to `t=5s` and read the signal values off from the cursor on each subplot. The asterisk next to the value in the cursor label indicates that the value is interpolated because the simulation did not include a calculation for a simulation time of exactly 5s.

```
Simulink.sdi.setCursorPositions('left',5);
```

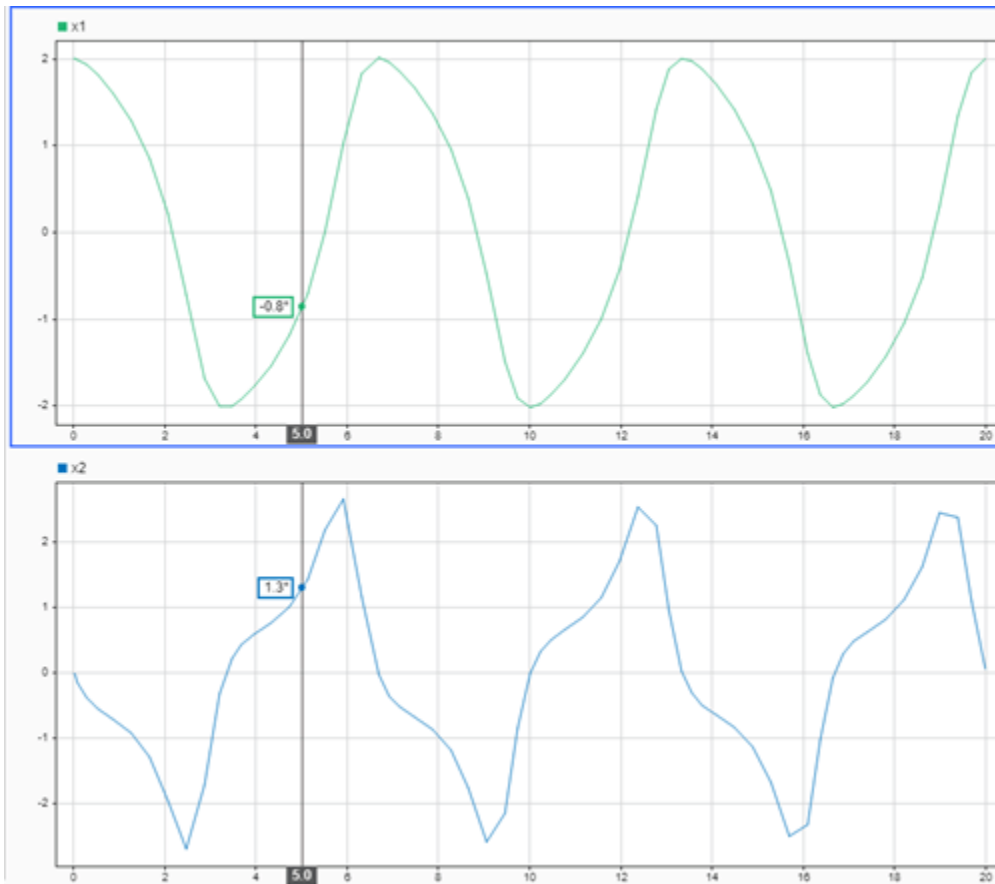

Suppose you want to calculate the time between two peaks in the x2 signal. Add a second cursor using the `Simulink.sdi.setNumCursors` function or using the **Show/hide data cursors** button in the Simulation Data Inspector.

```
numCursors = Simulink.sdi.getNumCursors;
if(numCursors < 2)
    Simulink.sdi.setNumCursors(2);
end
```

Drag the cursors so the left cursor is positioned at the first peak in the x2 signal and the right cursor is positioned at the second peak. Alternatively, run this code that positions the cursors for you.

```
Simulink.sdi.setCursorPositions('left',5.921998549931304,'right',12.378442136906246);
```

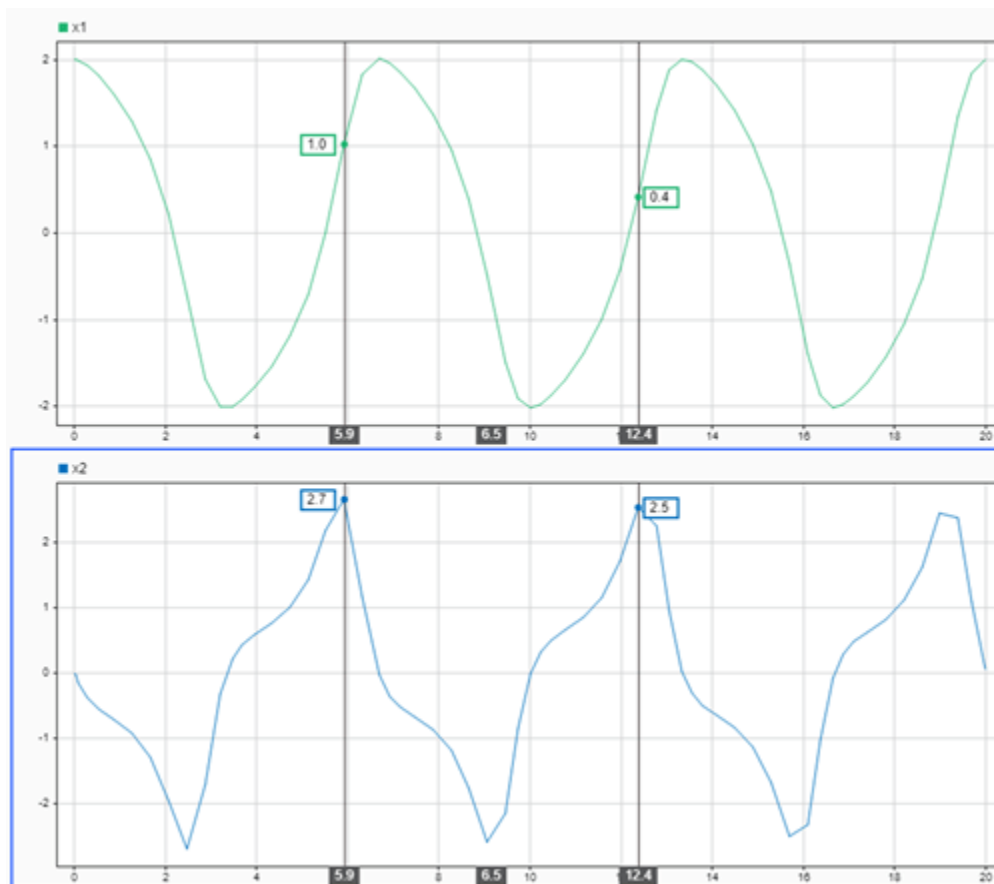

The Simulation Data Inspector displays the difference between the two cursors in seconds. However, the cursor position and difference values are both rounded. Use the `Simulink.sdi.getCursorPosition` function to programmatically retrieve the exact time values that correspond to the cursor positions. Then, compute the difference between the times.

```
[t1,t2] = Simulink.sdi.getCursorPosition;
T = t2 - t1
```

```
T = NaN
```

Input Arguments

num — Number of cursors to display

0 | 1 | 2

Number of cursors to display, specified as 0, 1, or 2.

view — Plot area in which to display cursors

'inspect' (default) | 'compare'

Plot area in which to display cursors, specified as 'inspect' or 'compare'.

Data Types: char | string

See Also

Functions

`Simulink.sdi.setCursorOptions` | `Simulink.sdi.getNumCursors` |
`Simulink.sdi.setCursorPositions`

Topics

“Inspect Simulation Data”
“Create Plots Using the Simulation Data Inspector”

Introduced in R2021a

Simulink.sdi.setRecordData

Specify record mode for logging

Syntax

```
Simulink.sdi.setRecordData(record)
```

Description

`Simulink.sdi.setRecordData(record)` configures the logging **Record mode** according to the value of `record`. When `record` is `true`, logged data is available to view during simulation and for analysis after simulation. When `record` is `false`, data is only available for viewing during simulation and is not available after simulation in the workspace or the Simulation Data Inspector.

Examples

Configure Logging to View Data Only During Simulation

In certain scenarios, you may want to only view logged data during simulation and not save any data to disk. For example, when using the Simulation Data Inspector to visualize data streaming from hardware, you may only want to view the data live and not record it. Use the `Simulink.sdi.setRecordData` function to configure the **Record mode** setting in the Simulation Data Inspector programmatically. To view data only during simulation, specify the input as `false`.

```
Simulink.sdi.setRecordData(false)
```

When you want to record logged data on disk so that it is available for analysis after simulation, call the `Simulink.sdi.setRecordData` function with `true` as the input.

```
Simulink.sdi.setRecordData(true)
```

The **Record mode** setting is restored to **View and record data** at the start of each MATLAB session.

Input Arguments

record — Record mode

`true` or 1 (default) | `false` or 0

Record mode, specified as numeric or logical 1 (`true`) or 0 (`false`).

- `true` — Logged data is stored on disk and available in the workspace and the Simulation Data Inspector after simulation.
- `false` — Logged data is not stored on disk and is only available to view during simulation. After simulation, no logged data is available in the Simulation Data Inspector or workspace.

Specifying `record` as `false` can affect other applications. For more information, see “View Data Only During Simulation”.

Data Types: `logical`

See Also

Functions

`Simulink.sdi.getRecordData`

Topics

“Configure the Simulation Data Inspector”

“Specify Signal Values to Log”

Introduced in R2021a

Simulink.sdi.setRequiredFreeSpace

Specify minimum disk space to leave free when logging data

Syntax

```
Simulink.sdi.setRequiredFreeSpace(minDiskSpace)
```

Description

`Simulink.sdi.setRequiredFreeSpace(minDiskSpace)` configures logging to leave at least the number of GB specified by `minDiskSpace` free when logging data.

When you configure a minimum amount of disk space to leave free, you can also configure the behavior when the free disk space limit is approached using the `Simulink.sdi.setDeleteRunsOnLowSpace` function. For more information, see “Specify a Minimum Disk Space Requirement or Maximum Size for Logged Data”.

Examples

Configure Logged Data Size Limits

Logging data from simulation can produce large amounts of data that may fill up disk space. To mitigate issues related to filing disk space, you can specify a minimum disk space requirement, a maximum size for logged data, or both. To ensure the logged data does not exceed the specified maximum size or use enough disk space to violate the disk space requirement, prior run data may be deleted and recording logged data may be disabled. You can specify whether to prioritize continuing to log data in the current simulation or retaining prior simulation data.

Use the `Simulink.sdi.setRequiredFreeSpace` function to configure logging to leave at least 1 GB of disk space empty.

```
Simulink.sdi.setRequiredFreeSpace(1);
```

Use the `Simulink.sdi.setMaxDiskUsage` function to specify a maximum logged data size of 100 GB.

```
Simulink.sdi.setMaxDiskUsage(100);
```

When you configure logging size limits, you can also specify what to do when the logging limits are approached. You can choose whether to prioritize retaining data from prior runs or data in the current run.

By default, current simulation data is prioritized. If the size of logged data approaches configured limits, data from prior simulations is deleted. If deleting run data does not free enough space, recording logged data is disabled and no more data from the current simulation is saved. When you choose to prioritize logged data from prior simulations instead, recording is disabled as soon as the size of logged data approaches configured limits. You see a warning when run data is deleted and when recording is disabled.

Use the `Simulink.sdi.setDeleteRunsOnLowSpace` function to configure logging to prioritize retaining prior run data.

```
Simulink.sdi.setDeleteRunsOnLowSpace(false);
```

If recording is disabled due to the size of logged data, you need to enable recording again to save data from future simulations. Use the `Simulink.sdi.setRecordData` function to enable recording.

```
Simulink.sdi.setRecordData(true);
```

Input Arguments

minDiskSpace — Minimum amount of free disk space required

0.1 (default) | scalar

Minimum amount of free disk space required, specified as a scalar, in units of GB. The minimum disk space requirement is a way to limit the size of logged data. The **When low on disk space** setting specifies what happens when the minimum disk space requirement is approached. For more information, see “Specify a Minimum Disk Space Requirement or Maximum Size for Logged Data”.

Example: `Simulink.sdi.setRequiredFreeSpace(0.5)` configures logging to leave at least half a gigabyte of free disk space.

See Also

Functions

`Simulink.sdi.getRequiredFreeSpace` | `Simulink.sdi.setMaxDiskUsage` |
`Simulink.sdi.getMaxDiskUsage` | `Simulink.sdi.setDeleteRunsOnLowSpace` |
`Simulink.sdi.getDeleteRunsOnLowSpace` | `Simulink.sdi.setRecordData` |
`Simulink.sdi.getRecordData`

Topics

“Limit the Size of Logged Data”
“Configure the Simulation Data Inspector”

Introduced in R2021a

Simulink.sdi.setRunNamingRule

Package: Simulink.sdi

Specify the Simulation Data Inspector run naming rule

Syntax

```
Simulink.sdi.setRunNamingRule('rule')
```

Description

`Simulink.sdi.setRunNamingRule('rule')` sets the Simulation Data Inspector rule for naming runs created by simulating a Simulink model.

Examples

Modify Run Naming Rule Then Restore Default

This example shows how to use the Simulation Data Inspector API to modify the Simulation Data Inspector run naming rule, check a run's name, restore default preferences, and check the run naming rule.

```
% Load model
load_system('sldemo_fuelsys')

% Modify run naming rule
Simulink.sdi.setRunNamingRule('<model_name> Run <run_index>')

% Simulate system
sim('sldemo_fuelsys')

% Check run name
runIDs = Simulink.sdi.getAllRunIDs;
runID = runIDs(end);
fuelRun = Simulink.sdi.getRun(runID);
fuelRun.name

ans =
'sldemo_fuelsys Run 1'

% Clear preferences to reset the run naming rule
Simulink.sdi.clearPreferences

% Check run naming rule
Simulink.sdi.getRunNamingRule

ans =
'Run <run_index>: <model_name>'
```

Input Arguments

'rule' — Simulation Data Inspector run naming rule

'Run <run_index>: <model_name> (default) | character vector

Simulation Data Inspector run naming rule for runs created by simulating a Simulink model. The character vector specifying the run naming rule can include plain text and any of the following tokens that represent data pulled from each run:

- <run_index> - Run's index in the Simulation Data Inspector repository.
- <model_name> - Name of the model simulated to create the run.
- <time_stamp> - Start time for the simulation that created the run.
- <sim_mode> - Simulation mode used for the simulation that created the run.

Example: '<time_stamp> Simulation <run_index>: <model_name>'

Example: '<model_name> - <run_index>'

Alternatives

You can modify the run naming rule using the Simulation Data Inspector UI in the **Preferences** menu. You can rename a run by modifying the Name property of its `Simulink.sdi.Run` object.

See Also

`Simulink.sdi.getRunNamingRule` | `Simulink.sdi.resetRunNamingRule` |
`Simulink.sdi.clearPreferences` | `Simulink.sdi.Run`

Topics

“Configure the Simulation Data Inspector”

“Inspect and Compare Data Programmatically”

Introduced in R2011b

Simulink.sdi.setRunOverwrite

Package: Simulink.sdi

(Removed) Enable and disable run overwrite mode for a Simulation Data Inspector run

Note The `Simulink.sdi.setRunOverwrite` function has been removed. You can configure the Overwrite Run mode behavior using the `Simulink.sdi.setAutoArchiveMode` and `Simulink.sdi.setArchiveRunLimit` functions. For further details, see “Compatibility Considerations”.

Syntax

```
Simulink.sdi.setRunOverwrite(runID, overwrite)
```

Description

`Simulink.sdi.setRunOverwrite(runID, overwrite)` configures run overwrite mode for the run corresponding to `runID`, according to the value specified for `overwrite`.

Examples

Configure the Simulation Data Inspector Archive

You can configure the Simulation Data Inspector to retain only the logged data for your current simulation. In iterative design and debugging workflows, this configuration helps prevent accumulation of unwanted logged data on disk. First, check the configuration of the Simulation Data Inspector archive. You can save the parameters to restore your preferences after you finish designing or debugging.

```
limit = Simulink.sdi.getArchiveRunLimit;  
mode = Simulink.sdi.getAutoArchiveMode;
```

Set the archive limit to 0 and configure the Simulation Data Inspector to automatically archive simulation runs.

```
Simulink.sdi.setArchiveRunLimit(0)  
Simulink.sdi.setAutoArchiveMode(true)
```

When you simulate your model, the Simulation Data Inspector deletes the previous run and updates the view to show signals in the current simulation.

When you finish designing or debugging your model, you can restore the Simulation Data Inspector archive back to its previous configuration.

```
Simulink.sdi.setArchiveRunLimit(limit)  
Simulink.sdi.setAutoArchiveMode(mode)
```

Input Arguments

runID — Numeric run identifier

scalar

Run ID for the run you want to set run overwrite for. The Simulation Data Inspector assigns run IDs when it creates runs. You can get the run ID for a run using `Simulink.sdi.getAllRunIDs` or `Simulink.sdi.getRunIDByIndex`.

overwrite — Run overwrite enable/disable

true | false

Logical value for run overwrite mode. Specify `overwrite` as `true` to enable run overwrite mode for a run, and set `overwrite` to `false` to disable run overwrite mode for a run.

Compatibility Considerations

Simulink.sdi.setRunOverwrite function has been removed

Errors starting in R2018b

The `Simulink.sdi.setRunOverwrite` function is removed in R2018b with the introduction of the Simulation Data Inspector archive. You can configure the Overwrite Run mode behavior using the new `Simulink.sdi.setAutoArchiveMode` and `Simulink.sdi.setArchiveRunLimit` functions. Enable the Simulation Data Inspector to automatically archive simulation runs, and set the archive limit to 0.

```
Simulink.sdi.setAutoArchiveMode(true);  
Simulink.sdi.setArchiveRunLimit(0);
```

With these settings, the Simulation Data Inspector retains the data for the current simulation run and discards the data for the previous simulation run. The view in the Simulation Data Inspector also updates to show signals in the current run, with consistent line styles and colors.

You can disable each aspect of the behavior separately. To retain prior run data, set the archive limit to a nonzero value. If you want no limit on the number of runs stored in the archive, you can specify -1 as the archive limit. When you disable the **Automatically archive** setting, the Simulation Data Inspector does not move the prior run to the archive or update the view to show signals from the current run.

See Also

`Simulink.sdi.setArchiveRunLimit` | `Simulink.sdi.setAutoArchiveMode` |
`Simulink.sdi.getArchiveRunLimit` | `Simulink.sdi.getAutoArchiveMode`

Topics

“Iterate Model Design Using the Simulation Data Inspector”

Introduced in R2011b

Simulink.sdi.setSignalInputProcessingMode

Specify value for Input Processing signal property

Syntax

```
Simulink.sdi.setSignalInputProcessingMode(blkPath,port,mode)  
Simulink.sdi.setSignalInputProcessingMode(h,mode)
```

Description

`Simulink.sdi.setSignalInputProcessingMode(blkPath,port,mode)` specifies `mode` as the value of the **Input Processing** property for the signal at the specified block path and port. You can only specify the **Input Processing** property for logged signals.

The **Input Processing** setting affects the format of the logged data and how the Simulation Data Inspector and dashboard blocks display the signal. You can configure a signal for frame-based or sample-based input processing.

`Simulink.sdi.setSignalInputProcessingMode(h,mode)` specifies `mode` as the value of the **Input Processing** property for the signal that corresponds to the line handle, `h`.

Examples

Programmatically Specify Input Processing Setting to Log a Frame-Based Signal

Many signal processing applications process data using frames, rather than individual signal values. A frame consists of signal values for several sample times. To process signals as frame-based in your model, specify frame-based processing in the blocks. To log and visualize frame-based signals, set the **Input Processing** setting to `Columns as channels (frame based)` in the Instrumentation Properties for the signal.

This example uses a model from the DSP System Toolbox™ to show how to programmatically specify the **Input Processing** setting for signals in a model using the `Simulink.sdi.setSignalInputProcessingMode` function. The model uses frame-based signals and demonstrates single sideband (SSB) modulation.

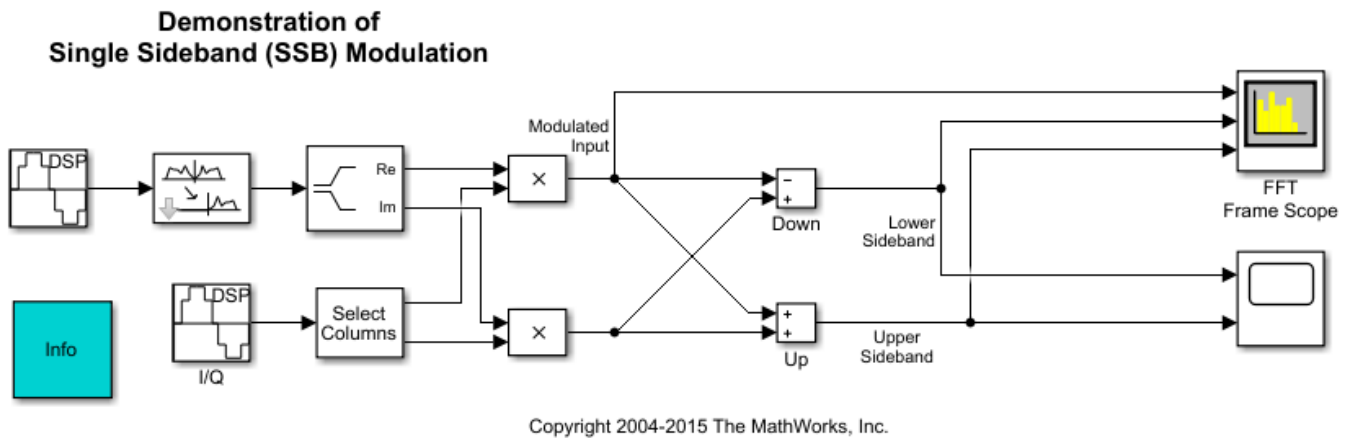

Configure Signal Logging

Open or load the model `ssbdemo_frame`. This example illustrates a scripting workflow and only loads the model.

```
load_system('ssbdemo_frame');
```

The model includes visualization blocks and does not use signal logging. Mark the signals that represent the upper sideband and lower sideband for logging.

```
upperSB_block = 'ssbdemo_frame/Up';
lowerSB_block = 'ssbdemo_frame/Down';
```

```
Simulink.sdi.markSignalForStreaming(upperSB_block,1,'on')
Simulink.sdi.markSignalForStreaming(lowerSB_block,1,'on')
```

If you simulate the model as-is, the signals would be logged as though they were sample-based, so each element in a sample would be treated as a separate channel. To log the signals as frame-based, specify the **Input Processing** setting for the signal as frame using the `Simulink.sdi.setSignalInputProcessingMode` function.

```
Simulink.sdi.setSignalInputProcessingMode(upperSB_block,1,'frame');
Simulink.sdi.setSignalInputProcessingMode(lowerSB_block,1,'frame');
```

After configuring the upper and lower sideband signals for logging and as frame-based, the data logs to the workspace and the Simulation Data Inspector in a frame-based format, so each column in a sample is treated as a channel in the signal. You can view and analyze the data in the Simulation Data Inspector or using its programmatic interface.

Input Arguments

blkPath — Block path for block that produces signal

string | character array

Block path for the block that produces the signal, specified as a string or character array.

Example: "vdp/Mu"

port — Number of block output port connected to signal

scalar

Block output port number for the port that produces the signal, specified as a scalar.

Example: 1

mode — Signal input processing setting

"sample" (default) | "frame"

Input Processing property value for the signal, returned as "signal" or "frame".

- **sample** — Sample-based input processing, where each element in a sample is treated as a channel.
- **frame** — Frame-based input processing, where each column in a sample is treated as a channel.

h — Signal line handle

line handle

Line handle for the signal. You can get the line handle for a signal using the `get_param` function with the 'LineHandles' option. For example, to access the line handle for the output of the Mu block in the model vdp:

```
MuLineHandles = get_param('vdp/Mu','LineHandles');  
MuOutputLineHandle = MuLineHandles.Outputport;
```

Example: MuOutputLineHandle

See Also

`get_param` | `Simulink.sdi.markSignalForStreaming` | `Simulink.sdi.getSignalInputProcessingMode`

Introduced in R2020a

Simulink.sdi.setStorageLocation

Specify location for logged data on disk

Syntax

```
Simulink.sdi.setStorageLocation(storagePath)
```

Description

`Simulink.sdi.setStorageLocation(storagePath)` configures `storagePath` as the location for simulation data logged to disk. By default, data is logged to the temporary directory on your computer.

Note Logging data to a network location can degrade performance.

Note The `Simulink.sdi.setStorageLocation` function configures the location of data logged to the workspace and Simulation Data Inspector when you log data to disk. The `Simulink.sdi.setStorageLocation` function does *not* configure the location of data logged to a file.

Examples

Specify Location of Logged Data

By default, data logged to the workspace and Simulation Data Inspector is stored in the temporary directory on your computer. You may want to change the location of logged data when you need to log large amounts of data and a secondary drive provides more storage capacity.

Use the `Simulink.sdi.setStorageLocation` function to specify the location for the file that holds data logged to disk.

```
Simulink.sdi.setStorageLocation('C:/Users/username/LoggedData');
```

Input Arguments

storagePath — Location of data logged to disk

character vector | string

Location of data logged to disk, specified as a character vector or string. By default, data logs to the temporary directory on your computer.

You may want to change the location of logged data when you need to log large amounts and a network location provides more storage capacity than your local machine. However, logging data to a network location can degrade performance.

Example: 'C:/Users/username/LoggedData'

Data Types: char | string

See Also

Functions

Simulink.sdi.getStorageLocation | Simulink.sdi.setStorageMode |
Simulink.sdi.getStorageMode

Topics

“Configure the Simulation Data Inspector”

Introduced in R2021a

Simulink.sdi.setStorageMode

Specify whether to log data to disk or memory

Syntax

```
Simulink.sdi.setStorageMode(storageMode)
```

Description

`Simulink.sdi.setStorageMode(storageMode)` configures logging to log data to disk or to memory according to `storageMode`. By default, data logged to the workspace and the Simulation Data Inspector is logged to disk.

Note When you change the logging storage mode, data from prior simulations is deleted. You cannot change the logging storage mode while a simulation is running.

Examples

Log Simulation Data to Memory

You can configure whether data logged in simulation logs to memory or to disk. By default, data is logged to disk and brought into memory on demand. If your machine has more RAM than disk space, you may want to log data to memory instead.

Use the `Simulink.sdi.setStorageMode` function to configure logging to log data to memory.

```
Simulink.sdi.setStorageMode("memory");
```

Input Arguments

storageMode — Where logged simulation data is stored on your machine

'disk' (default) | 'memory'

Where logged simulation data is stored on your machine, specified as 'disk' or 'memory'. By default, data logged to the workspace and the Simulation Data Inspector is logged to disk.

When you change the storage mode to log data to memory:

- Data logged from prior simulations is deleted.
- Configuring limits on the size of logged data is not supported.

You cannot change the storage mode while a simulation is running.

When you configure a parallel worker to log to memory, sending logged data to the client is not supported.

Logging data to memory is not supported for rapid accelerator simulations or models deployed using Simulink Compiler.

Data Types: char | string

See Also

Functions

Simulink.sdi.getStorageMode | Simulink.sdi.setStorageLocation |
Simulink.sdi.getStorageLocation

Topics

“Configure the Simulation Data Inspector”

Introduced in R2021a

Simulink.sdi.setSubPlotLayout

Package: Simulink.sdi

Set subplot layout in the Simulation Data Inspector

Syntax

```
Simulink.sdi.setSubPlotLayout(r,c)
```

Description

`Simulink.sdi.setSubPlotLayout(r,c)` sets the grid layout of plots in the **Simulation Data Inspector** using the specified number of rows, `r`, and columns, `c`.

Examples

Change Subplot Layout

```
% Change subplot layout to 4 rows and 2 columns  
Simulink.sdi.setSubPlotLayout(4,2);
```

Create a Run and View the Data

This example shows how to create a run, add data to it, and then view the data in the Simulation Data Inspector.

Create Data for the Run

Create `timeseries` objects to contain data for a sine signal and a cosine signal. Give each `timeseries` object a descriptive name.

```
time = linspace(0,20,100);  
  
sine_vals = sin(2*pi/5*time);  
sine_ts = timeseries(sine_vals,time);  
sine_ts.Name = 'Sine, T=5';  
  
cos_vals = cos(2*pi/8*time);  
cos_ts = timeseries(cos_vals,time);  
cos_ts.Name = 'Cosine, T=8';
```

Create a Run and Add Data

Use the `Simulink.sdi.view` function to open the Simulation Data Inspector.

```
Simulink.sdi.view
```

To import data into the Simulation Data Inspector from the workspace, create a `Simulink.sdi.Run` object using the `Simulink.sdi.Run.create` function. Add information about the run to its metadata using the `Name` and `Description` properties of the Run object.

```
sinusoidsRun = Simulink.sdi.Run.create;
sinusoidsRun.Name = 'Sinusoids';
sinusoidsRun.Description = 'Sine and cosine signals with different frequencies';
```

Use the `add` function to add the data you created in the workspace to the empty run.

```
add(sinusoidsRun, 'vars', sine_ts, cos_ts);
```

Plot the Data in the Simulation Data Inspector

Use the `getSignalByIndex` function to access `Simulink.sdi.Signal` objects that contain the signal data. You can use the `Simulink.sdi.Signal` object properties to specify the line style and color for the signal and plot it in the Simulation Data Inspector. Specify the `LineColor` and `LineDashed` properties for each signal.

```
sine_sig = getSignalByIndex(sinusoidsRun,1);
sine_sig.LineColor = [0 0 1];
sine_sig.LineDashed = '-.';

cos_sig = sinusoidsRun.getSignalByIndex(2);
cos_sig.LineColor = [0 1 0];
cos_sig.LineDashed = '--';
```

Use the `Simulink.sdi.setSubPlotLayout` function to configure a 2-by-1 subplot layout in the Simulation Data Inspector plotting area. Then use the `plotOnSubplot` function to plot the sine signal on the top subplot and the cosine signal on the lower subplot.

```
Simulink.sdi.setSubPlotLayout(2,1);

plotOnSubplot(sine_sig,1,1,true);
plotOnSubplot(cos_sig,2,1,true);
```

Close the Simulation Data Inspector and Save Your Data

When you have finished inspecting the plotted signal data, you can close the Simulation Data Inspector and save the session to an MLDATX file.

```
Simulink.sdi.close('sinusoids.mldatx')
```

Input Arguments

r — Number of rows

integer

Number of rows in the subplot grid layout, specified as a whole number between 1 and 8, inclusive.

Example: 2

Data Types: single | double | int8 | int16 | int32 | int64 | uint8 | uint16 | uint32 | uint64 | char

c — Number of columns

integer

Number of columns in the subplot grid layout, specified as a whole number between 1 and 8, inclusive.

Example: 2

Data Types: `single` | `double` | `int8` | `int16` | `int32` | `int64` | `uint8` | `uint16` | `uint32` | `uint64` | `char`

See Also

Functions

`Simulink.sdi.clearAllSubPlots` | `Simulink.sdi.clearPreferences` |
`Simulink.sdi.setBorderOn` | `Simulink.sdi.setMarkersOn` |
`Simulink.sdi.setTicksPosition` | `Simulink.sdi.setTickLabelsDisplay` |
`Simulink.sdi.setGridOn` | `plotOnSubPlot` | `Simulink.sdi.saveView` | `Simulink.sdi.save`

Tools

Simulation Data Inspector

Topics

“Inspect and Compare Data Programmatically”

“Create Plots Using the Simulation Data Inspector”

Introduced in R2016a

Simulink.sdi.setSubplotLimits

Specify subplot limits for time plots in the Simulation Data Inspector

Syntax

```
Simulink.sdi.setSubplotLimits(r,c,Name,Value)
```

Description

`Simulink.sdi.setSubplotLimits(r,c,Name,Value)` configures the time and y-axis limits for the subplot at the location specified by `r` and `c` according to the values specified by one or more name-value pair arguments. You can specify any combination of a *t*-axis minimum, *t*-axis maximum, *y*-axis minimum, and *y*-axis maximum using name-value pair arguments.

Note Limits for the *t*-axis apply to all linked time plots in the Simulation Data Inspector. For more information, see “Linked Subplots”.

Examples

Copy y-Axis Range from One Subplot to Another

You can use the `Simulink.sdi.getSubplotLimits` and `Simulink.sdi.setSubplotLimits` functions to copy the axis limits from one subplot to another. For example, you can specify the same y-axis limits for two subplots that display the same signal from simulations that used different values of a model parameter. This example copies the y-axis settings from one subplot to another to analyze the effect of changing the value of `Mu` in the model `vdp`.

Create the data in the Simulation Data Inspector by simulating the model `vdp` twice. The first time, specify the value of `Mu` as 1. For the second simulation, set the value of `Mu` to 2. The model logs data for the signals `x1` and `x2`.

```
open_system('ex_vdp');
set_param('ex_vdp/Mu','Gain','1')
sim('ex_vdp');

set_param('ex_vdp/Mu','Gain','2');
sim('ex_vdp');
```

Create plots in the Simulation Data Inspector to show the results from each simulation. Configure a 2x2 subplot layout so you can plot one signal on each plot, side by side.

```
Simulink.sdi.setSubPlotLayout(2,2)
```

Get the `Simulink.sdi.Signal` objects that correspond to each signal from each run, and plot one signal on each subplot. Plot the signals from the first simulation on the subplots in the first column and the signals from the second simulation on the subplots in the second column.

```
runIDs = Simulink.sdi.getAllRunIDs;
runID1 = runIDs(end-1);
```

```
runID2 = runIDs(end);

runMu1 = Simulink.sdi.getRun(runID1);
runMu2 = Simulink.sdi.getRun(runID2);

sig1 = getSignalByIndex(runMu1,1);
sig2 = getSignalByIndex(runMu1,2);
sig3 = getSignalByIndex(runMu2,1);
sig4 = getSignalByIndex(runMu2,2);

plotOnSubPlot(sig1,1,1,true);
plotOnSubPlot(sig2,2,1,true);
plotOnSubPlot(sig3,1,2,true);
plotOnSubPlot(sig4,2,2,true);
```

The signals in the first column of plots look similar to those in the second column. However, the y-axis limits for the plots of the x2 signal are different.

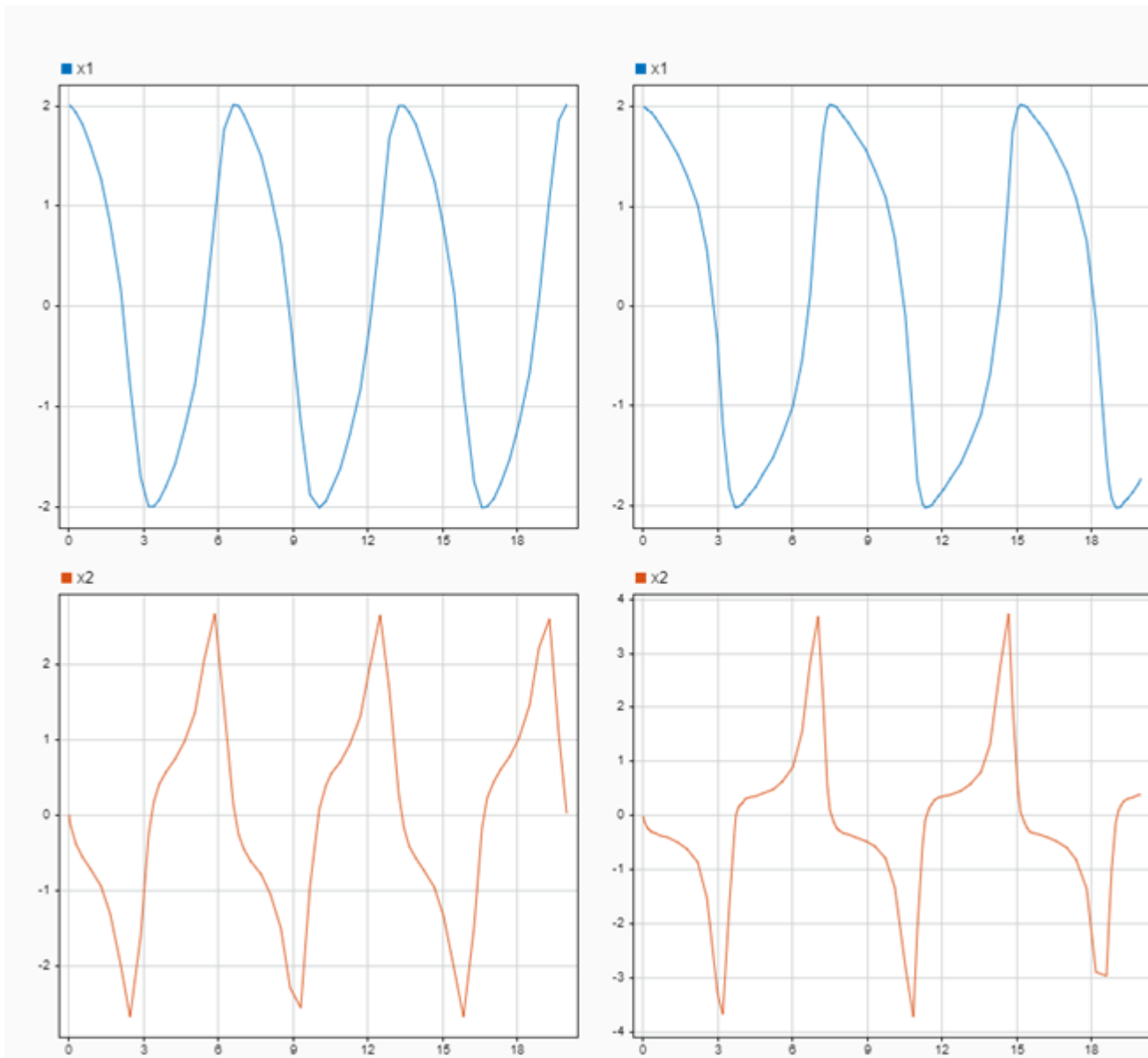

Use the `Simulink.sdi.getSubplotLimits` function to copy the limits used for the subplot with the x2 signal from the second simulation.

```
[~,~,ymin,ymax] = Simulink.sdi.getSubplotLimits(2,2);
```

Use the `Simulink.sdi.setSubplotLimits` function to apply the same y-axis limits to the subplot with the x2 signal from the first run.

```
Simulink.sdi.setSubplotLimits(2,1, 'yRange', [ymin,ymax]);
```

With the updated y-axis limits, the difference in the x2 signal is more apparent.

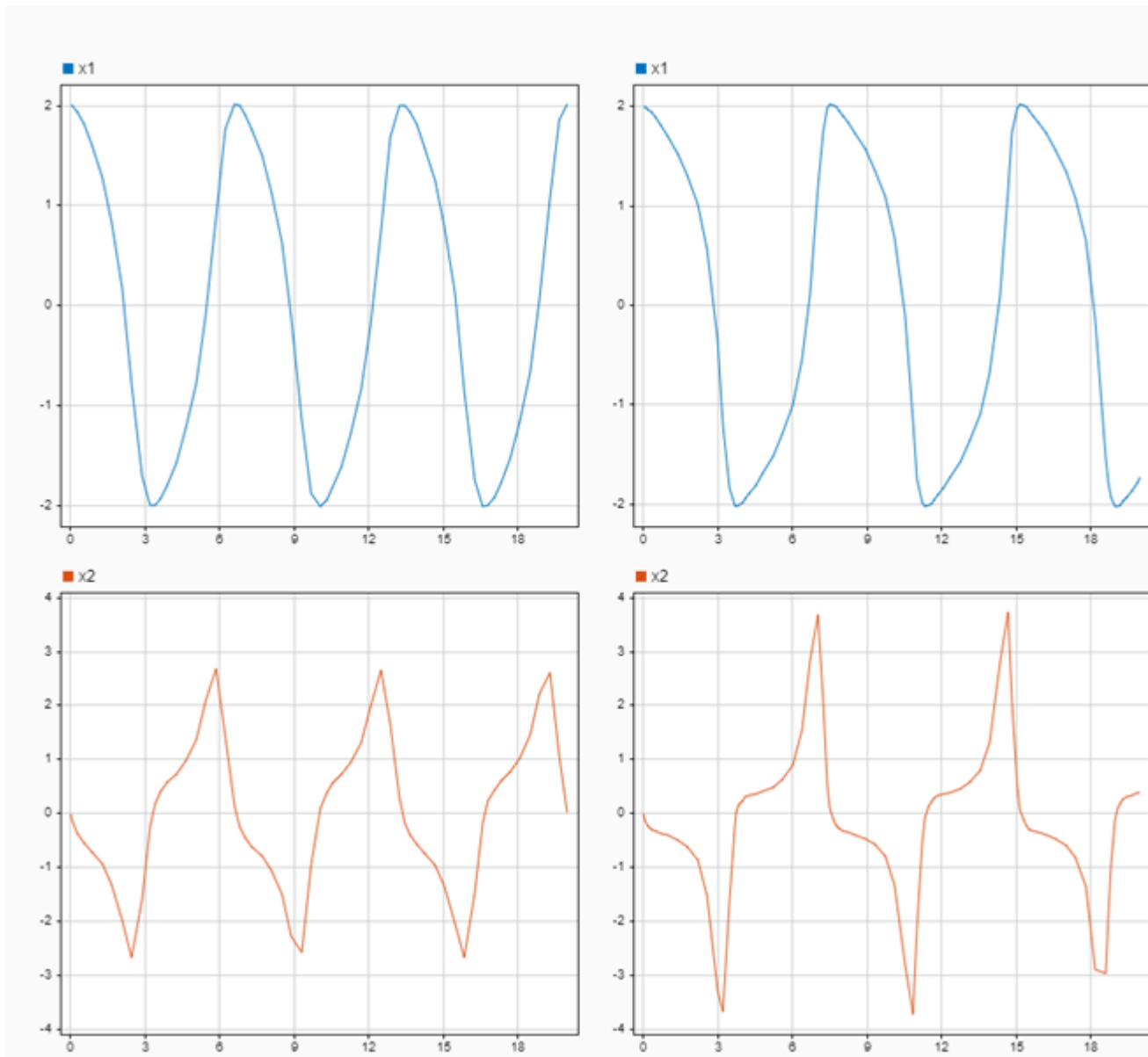

Input Arguments

r — Subplot row index
integer

Subplot row index, specified as an integer between 1 and 8, inclusive. Use the r and c inputs together to specify the location of the subplot for which you want to specify axis limits.

Example: `Simulink.sdi.setSubplotLimits(2,2,'yrange',[0,3])` configures y-axis limits for the time plot in the second row of the second column of the subplot layout in the Simulation Data Inspector.

c — Subplot column index

integer

Subplot column index, specified as an integer value between 1 and 8, inclusive. Use the `r` and `c` inputs together to specify the location of the subplot for which you want to specify axis limits.

Example: `Simulink.sdi.setSubplotLimits(2,2,'yrange',[0,3])` configures y-axis limits for the time plot in the second row of the second column of the subplot layout in the Simulation Data Inspector.

Name-Value Pair Arguments

Specify optional comma-separated pairs of `Name`, `Value` arguments. `Name` is the argument name and `Value` is the corresponding value. `Name` must appear inside quotes. You can specify several name and value pair arguments in any order as `Name1,Value1,...,NameN,ValueN`.

Example: `Simulink.sdi.setSubplotLimits(2,2,'ymin',0,'ymax',3)` configures y-axis limits for the time plot in the second row of the second column of the subplot layout in the Simulation Data Inspector.

View — Simulation Data Inspector view

'Inspect' (default) | 'Compare'

Simulation Data Inspector view, specified as 'Inspect' or 'Compare'. Specify the view with the subplot for which you want to specify limits. When you omit the 'View' argument, the limits are applied to the specified subplot in the inspect view.

Example: `Simulink.sdi.setSubplotLimits(2,1,'View','Compare','yRange',[-2,2])` configures y-axis limits for the difference plot in the compare view of the Simulation Data Inspector.

Data Types: char | string

tMin — t-axis minimum

scalar

t-axis minimum, specified as a scalar.

You can specify limits for the *t*-axis using the `tMin` and `tMax` name-value arguments, using the `tRange` argument, or using the `AllRange` argument. When you specify the `tMin` name-value pair argument, do not specify the `tRange` or `AllRange` arguments.

Data Types: double

tMax — t-axis maximum

scalar

t-axis maximum, specified as a scalar.

You can specify limits for the *t*-axis using the `tMin` and `tMax` name-value arguments, the `tRange` argument, or the `AllRange` argument. When you specify the `tMax` name-value argument, do not specify the `tRange` or `AllRange` arguments.

Data Types: double

yMin — y-axis minimum

scalar

y-axis minimum, specified as a scalar.

You can specify limits for the *y*-axis using the `yMin` and `yMax` name-value arguments, the `yRange` argument, or the `AllRange` argument. When you specify the `yMin` name-value argument, do not specify the `yRange` or `AllRange` arguments.

Data Types: `double`

yMax — y-axis maximum

scalar

y-axis maximum, specified as a scalar.

You can specify limits for the *y*-axis using the `yMin` and `yMax` name-value arguments, the `yRange` argument, or the `AllRange` argument. When you specify the `yMax` name-value argument, do not specify the `yRange` or `AllRange` arguments.

Data Types: `double`

tRange — t-axis range

1-by-2 vector

t-axis range, specified as a 1-by-2 vector that contains scalar numeric values.

You can specify limits for the *t*-axis using the `tMin` and `tMax` name-value arguments, the `tRange` argument, or the `AllRange` argument. When you specify the `tRange` name-value argument, do not specify the `tMin`, `tMax`, or `AllRange` arguments.

Example: `Simulink.sdi.setSubplotLimits(1,1,'tRange',[-1,20])` configures the *t*-axis range for the subplot in the first row and first column of the Simulation Data Inspector subplot layout.

Data Types: `double`

yRange — y-axis range

1-by-2 vector

y-axis range, specified as a 1-by-2 vector that contains scalar numeric values.

You can specify limits for the *y*-axis using the `yMin` and `yMax` name-value arguments, the `yRange` argument, or the `AllRange` argument. When you specify the `yRange` name-value argument, do not specify the `yMin`, `yMax`, or `AllRange` arguments.

Example: `Simulink.sdi.setSubplotLimits(1,1,'yRange',[-5,5])` configures the *y*-axis range for the subplot in the first row and first column of the Simulation Data Inspector subplot layout.

Data Types: `double`

AllRange — Ranges for t-axis and y-axis

1-by-4 vector

Ranges for *t*-axis and *y*-axis, specified as a 1-by-4 vector that contains scalar numeric values. The values specified in the vector are mapped to the *t*- and *y*-axis limits in this order: `[tMin,tMax,yMin,yMax]`.

When you specify the `AllRange` name-value argument, do not specify the `tMin`, `tMax`, `yMin`, `yMax`, `tRange`, or `yRange` arguments.

Example: `Simulink.sdi.setSubplotLimits(1,1,'AllRange',[-1,20,-5,5])` configures the *t*-axis range and *y*-axis range for the subplot in the first row and first column of the Simulation Data Inspector subplot layout.

Data Types: double

See Also

Functions

`Simulink.sdi.setSubPlotLayout` | `plotOnSubPlot` | `Simulink.sdi.setBorderOn` |
`Simulink.sdi.setGridOn` | `Simulink.sdi.setMarkersOn` |
`Simulink.sdi.setTickLabelsDisplay` | `Simulink.sdi.setTicksPosition`

Objects

`Simulink.sdi.Run` | `Simulink.sdi.Signal`

Topics

“Create Plots Using the Simulation Data Inspector”
“Inspect Simulation Data”

Introduced in R2021a

Simulink.sdi.setTableGrouping

Change signal grouping hierarchy in Inspect pane

Syntax

```
Simulink.sdi.setTableGrouping  
Simulink.sdi.setTableGrouping(group,group1,...,groupN)
```

Description

`Simulink.sdi.setTableGrouping` removes grouping for signals in the Simulation Data Inspector.

`Simulink.sdi.setTableGrouping(group,group1,...,groupN)` groups signals in the Simulation Data Inspector according to one or more specified options. Signal grouping is the same on the **Inspect** and **Compare** panes. You can group signals by any combination of domain, physical system hierarchy, data hierarchy, and model hierarchy.

Examples

Group Data by Model Hierarchy Then by Data Hierarchy

To help organize and find signals in the Simulation Data Inspector, you can group the signals. For example, you could group signals according to their location within a model hierarchy and then by data hierarchy.

```
Simulink.sdi.setTableGrouping('Subsystems','DataHierarchy');
```

Input Arguments

group — Signal grouping

'Domain' | 'DataHierarchy' | 'Subsystems' | 'PhysmodHierarchy'

Signal grouping, specified as one or more of these values:

- **Domain** — Group signals by domain.
- **DataHierarchy** — Group signals according to data hierarchy, such as the hierarchy for a bus.
- **SubSystems** — Group signals according to their location within the model hierarchy.
- **PhysmodHierarchy** — Group signals according to the Simscape hierarchy. This option is only available when you have a Simscape license.

You can specify up to three grouping options unless you have a Simscape license, in which case you can specify up to four.

By default, the Simulation Data Inspector groups signals by domain, then by physical system hierarchy (if you have a Simscape license), and then by data hierarchy.

See Also

`Simulink.sdi.view` | `Simulink.sdi.clearPreferences` | `Simulink.sdi.saveView` | `Simulink.sdi.save`

Topics

“Configure the Simulation Data Inspector”
“Inspect and Compare Data Programmatically”

Introduced in R2016a

Simulink.sdi.setTickLabelsDisplay

Configure tick label visibility for time plot axes

Syntax

```
Simulink.sdi.setTickLabelsDisplay(label)
```

Description

`Simulink.sdi.setTickLabelsDisplay(label)` displays labels for the tick marks on axes of time plots in the Simulation Data Inspector according to the input, `label`. The function sets the value of the **Tick labels** setting on the **Time Plot** section of the **Visualization Settings** in the Simulation Data Inspector. The setting applies to all time plots in the layout. By default, the Simulation Data Inspector displays tick mark labels for both axes.

Examples

Configure Tick Mark Label Visibility for Time Plots

You can use the `Simulink.sdi.setTickLabelsDisplay` function to configure the visibility of tick mark labels for the *t*- and *y*-axes on time plots in the Simulation Data Inspector. By default, the Simulation Data Inspector displays tick marks for both axes.

This example starts by showing how to use the `Simulink.sdi.getTickLabelsDisplay` function to access the current tick mark label visibility. Subsequent sections show the code to specify each available option for tick mark label visibility on time plots in the Simulation Data Inspector. To see the result of each configuration, the example generates an image using the `Simulink.sdi.snapshot` function with settings specified by a `Simulink.sdi.CustomSnapshot` object.

```
snapSettings = Simulink.sdi.CustomSnapshot;  
snapSettings.Width = 300;  
snapSettings.Height = 300;
```

Get Current Tick Mark Label Visibility

Before modifying the visibility of the tick mark labels on time plots, you can save the current configuration to a variable in the workspace in case you want to restore the preference later.

```
initTickLabels = Simulink.sdi.getTickLabelsDisplay;
```

Show Only *t*-Axis Tick Mark Labels

Show the tick mark labels for the *t*-Axis.

```
Simulink.sdi.setTickLabelsDisplay('t-axis')  
Simulink.sdi.snapshot('from','custom','settings',snapSettings);
```

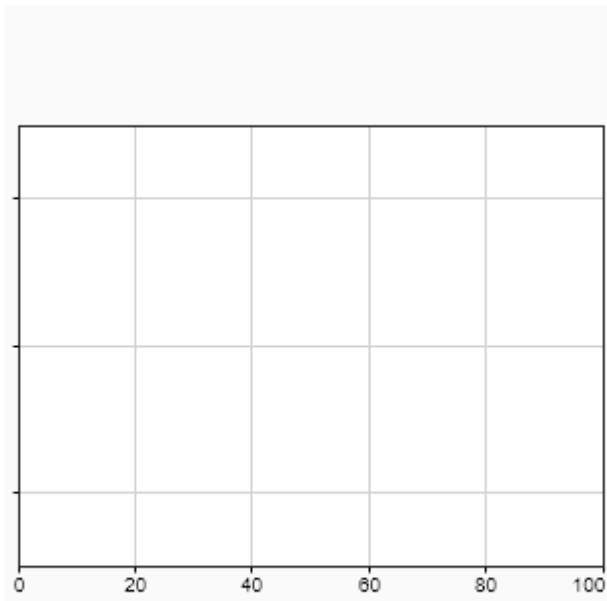

Show Only y-Axis Tick Mark Labels

Show the tick mark labels for the y-axis.

```
Simulink.sdi.setTickLabelsDisplay('y-axis')  
Simulink.sdi.snapshot('from', 'custom', 'settings', snapSettings);
```

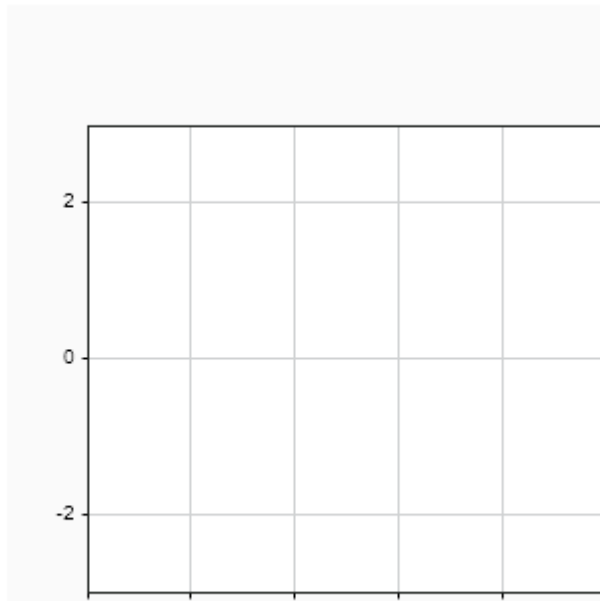

Hide Tick Mark Labels

You can hide the tick mark labels for both axes.

```
Simulink.sdi.setTickLabelsDisplay('none')  
Simulink.sdi.snapshot('from', 'custom', 'settings', snapSettings);
```

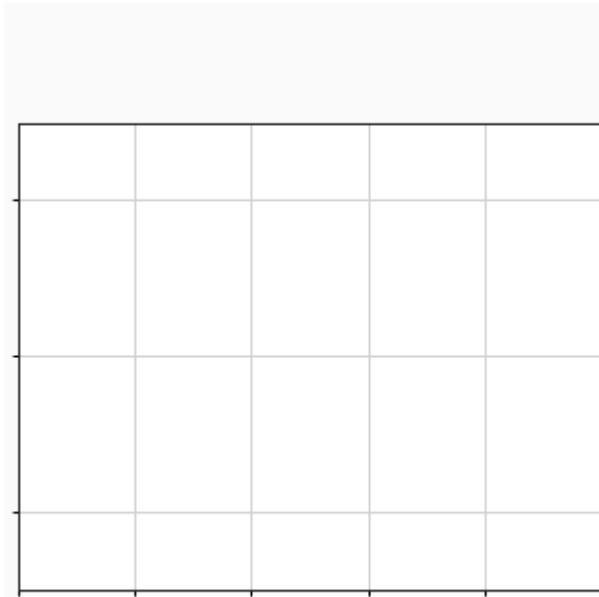

Show All Tick Mark Labels

By default, the Simulation Data Inspector shows tick mark labels for both axes on time plots.

```
Simulink.sdi.setTickLabelsDisplay('all')  
Simulink.sdi.snapshot('from', 'custom', 'settings', snapSettings);
```

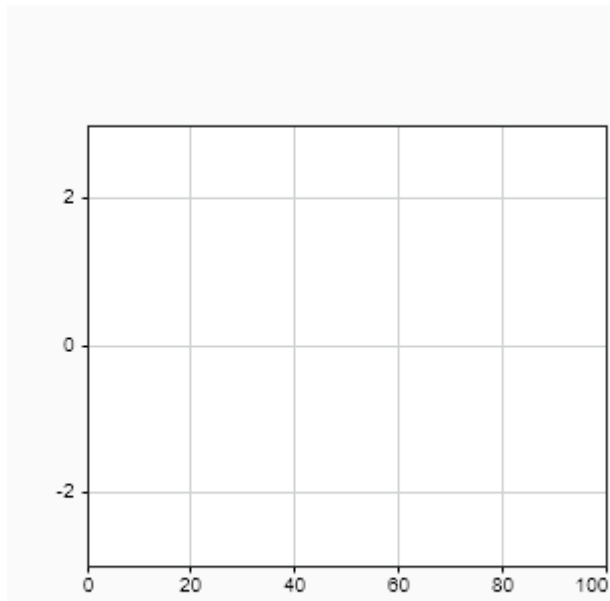

Input Arguments

label — Tick mark labels to display

'all' (default) | 't-axis' | 'y-axis' | 'none'

Tick mark labels to display on time plots in the Simulation Data Inspector, specified as one of these options:

- 'all' — Display tick mark labels for both time plot axes.
- 't-axis' — Display tick mark labels only on the *t*-axis for time plots.
- 'y-axis' — Display tick mark labels only on the *y*-axis for time plots.
- 'none' — Do not display tick mark labels.

See Also

[Simulink.sdi.getTickLabelsDisplay](#) | [Simulink.sdi.setBorderOn](#) |
[Simulink.sdi.setGridOn](#) | [Simulink.sdi.setMarkersOn](#) |
[Simulink.sdi.setSubPlotLayout](#) | [Simulink.sdi.setTicksPosition](#) |
[Simulink.sdi.clearPreferences](#) | [Simulink.sdi.save](#) | [Simulink.sdi.saveView](#)

Topics

“Create Plots Using the Simulation Data Inspector”

Introduced in R2019b

Simulink.sdi.setTicksPosition

Configure position for tick marks on time plots in the Simulation Data Inspector

Syntax

```
Simulink.sdi.setTicksPosition(position)
```

Description

`Simulink.sdi.setTicksPosition(position)` sets the location of tick marks on time plots in the Simulation Data Inspector according to the input, `position`. The function configures the **Ticks** setting on the **Time Plot** section of the **Visualization Settings** in the Simulation Data Inspector. The setting applies to all time plots in the layout. By default, the Simulation Data Inspector displays tick marks on the outside of the plot area.

Examples

Configure Position for Tick Marks on Time Plots

You can use `Simulink.sdi.setTicksPosition` function to specify the position for tick marks on time plots in the Simulation Data Inspector. By default, the Simulation Data Inspector displays tick marks outside of the plot area for time plots.

This example starts by showing how to use the `Simulink.sdi.getTicksPosition` function to access the current position of tick marks. Subsequent sections show the code to specify each configuration option for the position of tick marks on time plots in the Simulation Data Inspector. To see the result, the example generates an image using `Simulink.sdi.snapshot` with settings specified by a `Simulink.sdi.CustomSnapshot` object.

```
snapSettings = Simulink.sdi.CustomSnapshot;  
snapSettings.Width = 300;  
snapSettings.Height = 300;
```

Get Current Tick Mark Position

Before modifying the position of tick marks on time plots, you can save the current configuration to a variable in the workspace in case you want to restore the preference later.

```
initTickPos = Simulink.sdi.getTicksPosition;
```

Position Tick Marks Inside Plot Area

Position the tick marks inside the plot area to increase the amount of space used by the plot area.

```
Simulink.sdi.setTicksPosition('inside')  
Simulink.sdi.snapshot('from', 'custom', 'settings', snapSettings);
```

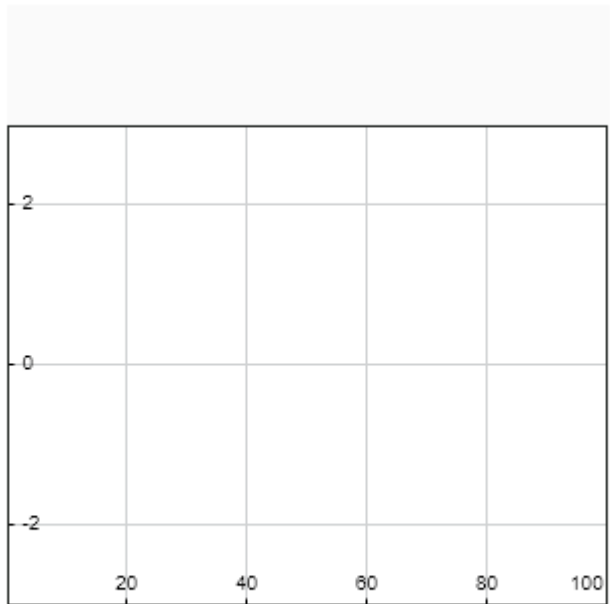

Hide Tick Marks on Time Plots

You can hide the tick marks for time plots in the Simulation Data Inspector. Hiding the tick marks expands the plot area.

```
Simulink.sdi.setTicksPosition('none')  
Simulink.sdi.snapshot('from', 'custom', 'settings', snapSettings);
```

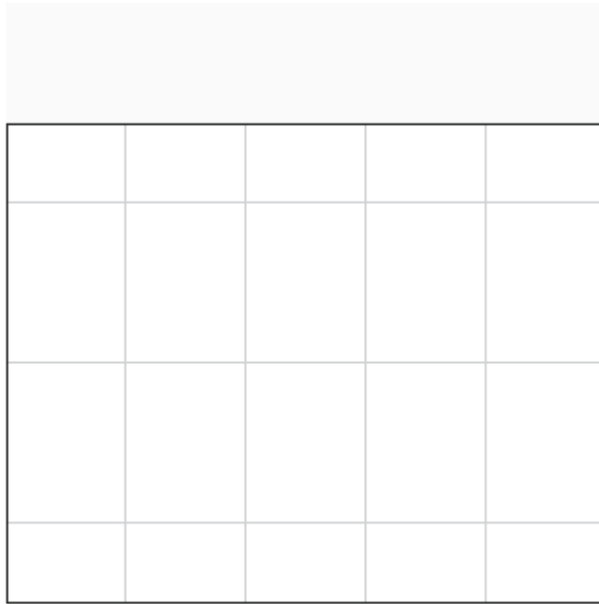

Position Tick Marks Outside Plot Area

By default, the Simulation Data Inspector displays tick marks outside of the plot area for time plots.

```
Simulink.sdi.setTicksPosition('outside')  
Simulink.sdi.snapshot('from', 'custom', 'settings', snapSettings);
```

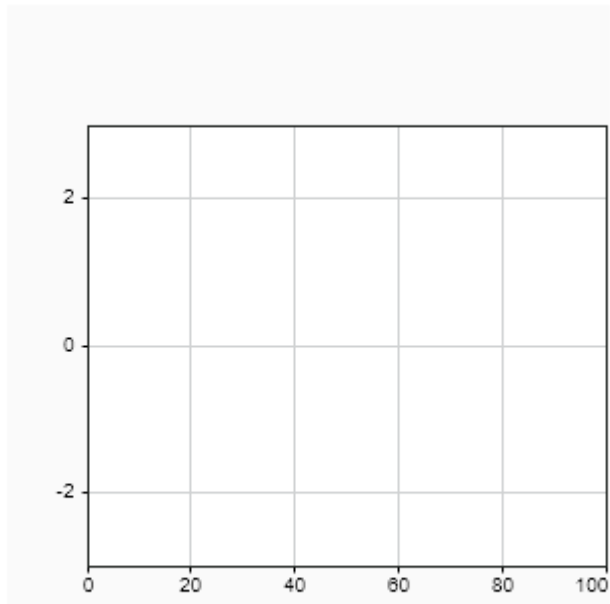

Input Arguments

position — Position of tick marks on time plots

'outside' (default) | 'inside' | 'none'

Position of tick marks on time plots in the Simulation Data Inspector, specified as 'inside' or 'outside'.

Tip Move tick marks to the inside of time plots to increase the space available for the plot area.

Example: 'inside'

See Also

[Simulink.sdi.getTicksPosition](#) | [Simulink.sdi.setBorderOn](#) |
[Simulink.sdi.setTickLabelsDisplay](#) | [Simulink.sdi.setGridOn](#) |
[Simulink.sdi.setMarkersOn](#) | [Simulink.sdi.setSubPlotLayout](#) |
[Simulink.sdi.clearPreferences](#) | [Simulink.sdi.save](#) | [Simulink.sdi.saveView](#)

Topics

“Create Plots Using the Simulation Data Inspector”

Introduced in R2019b

Simulink.sdi.setUnitSystem

Specify system of units to define signal display units in the Simulation Data Inspector

Syntax

```
Simulink.sdi.setUnitSystem(unitSystem)
Simulink.sdi.setUnitSystem(unitSystem,"Overrides",overrideUnits)
```

Description

`Simulink.sdi.setUnitSystem(unitSystem)` configures the Simulation Data Inspector to use the specified unit system to define the display units for logged and imported signals.

The Simulation Data Inspector plots signals using the display units. The display units for a signal may differ from the stored units, which indicate units for the data as stored on disk. When you specify a system of units in the Simulation Data Inspector preferences, the Simulation Data Inspector automatically adjusts the display units for logged or imported signals that use units that are not valid in the specified system.

`Simulink.sdi.setUnitSystem(unitSystem,"Overrides",overrideUnits)` configures the Simulation Data Inspector to use the specified override units. Specify override units when you want a type of measurement, such as length, to use consistent units, such as m or ft, across all signals in the Simulation Data Inspector.

Examples

Configure Unit Preferences in the Simulation Data Inspector

To specify a system of units to use for plotting signals in the Simulation Data Inspector, use the `Simulink.sdi.setUnitSystem` function. When you choose to display signals using the SI or US Customary unit system, the Simulation Data Inspector automatically changes the **Display Units** property for logged or imported signals that use units that are not part of the specified unit system. The signal data stored on disk does not change. Signals also have a **Stored Units** property, and the Simulation Data Inspector converts the data to plot the signal when the **Stored Units** and **Display Units** differ.

Specify a System of Units

By default, the Simulation Data Inspector displays signals using the units assigned to the signal during simulation or in the imported data. To facilitate analyzing multiple signals and data sets together, you can specify a system of units as a preference. The Simulation Data Inspector automatically updates the **Display Units** for logged or imported signals that use units that are invalid in the specified unit system. For example, a signal logged in a model using units of ft could be updated to use units of m when the system of units is specified as SI.

Use the `Simulink.sdi.setUnitSystem` function to configure the Simulation Data Inspector to display signals using units in the US Customary unit system.

```
Simulink.sdi.setUnitSystem('USCustomary');
```

Specify Override Units

When you want all signals that represent the same type of measurement to use the same **Display Units**, you can also specify override units. For example, to plot all signals that represent length using units of ft, specify ft as an override unit.

```
Simulink.sdi.setUnitSystem('USCustomary','Overrides','ft');
```

Check Unit Configuration

Use the `Simulink.sdi.getUnitSystem` function to check the current unit preferences configured in the Simulation Data Inspector.

```
[unitSystem,overrideUnits] = Simulink.sdi.getUnitSystem  
  
unitSystem =  
'USCustomary'  
  
overrideUnits =  
"ft"
```

Input Arguments

unitSystem — System of units used to define signal display units

'Default' (default) | 'SI' | 'USCustomary'

System of units used to define signal display units, specified as 'Default', 'SI', or 'USCustomary'.

- `Default` — Use signal stored units.
- `SI` — Use units from the SI unit system for signal display units.
- `USCustomary` — Use units from the US Customary unit system for signal display units.

overrideUnits — Units to override signal display units

string | string array

Units to override signal display units, specified as a string or string array. Specify override units when you want all signals that represent the same measurement type to use consistent units. For example, specify override units of ft to display all signals that represent length measurements using units of ft.

Example: "Overrides",["in","lb"]

Data Types: string

See Also

Objects

`Simulink.sdi.Signal`

Functions

`convertUnits` | `Simulink.sdi.clearPreferences` | `Simulink.sdi.getUnitSystem`

Topics

“Configure the Simulation Data Inspector”

“Modify Signal Properties in the Simulation Data Inspector”

Introduced in R2020b

collapse

Package: Simulink.sdi

Represent multidimensional signal as a single signal with nonscalar sample values

Syntax

```
collapse(sigObj)
```

Description

`collapse(sigObj)` converts the representation of the signal that corresponds to the `Simulink.sdi.Signal` object `sigObj` from a set of signals with scalar sample values to a single signal with nonscalar sample values.

When you convert the representation of a multidimensional signal from a set of scalar signals, called channels, to a single signal with nonscalar sample values:

- The `Signal` object that previously contained the data for the first channel contains the data for the multidimensional signal.
- The `Signal` objects for all other channels no longer contain data.
- The signal IDs for all other channels become invalid.

Examples

Convert Representation of Multidimensional Signal Data

When you analyze multidimensional signal data using the Simulation Data Inspector, you can choose whether to represent the data as a single signal with multidimensional sample values or as a set of signals, called *channels*, with scalar sample values. Use the Simulation Data Inspector programmatic interface to convert the representation of a signal created by logging the output of the Mux block in the model `vdp`.

Open and Simulate the Model

Open the model `vdp`, mark the output of the Mux block for logging, and name the Mux block output signal. Then, simulate the model.

```
open_system('vdp');  
  
MuxPort = get_param('vdp/Mux','PortHandles');  
set_param(MuxPort.Outputport,'DataLogging','on');  
  
MuxSig = get_param(MuxPort.Outputport,'Line');  
set_param(MuxSig,'Name','Mux');  
  
sim('vdp');
```

Access the Run and Signal Data

By default, the output of the Mux block is represented as channels in the Simulation Data Inspector because it contains fewer than four channels, so the run contains two signals: one for each channel in the Mux block output.

Use the `Simulink.sdi.getCurrentSimulationRun` function to access the `Simulink.sdi.Run` object that contains the simulation data. Then, check how many `Simulink.sdi.Signal` objects the Run object contains using the `SignalCount` property on the Run object.

```
runObj = Simulink.sdi.getCurrentSimulationRun('vdp');
runObj.SignalCount
```

```
ans = int32
     2
```

Signals with multidimensional data have a top-level `Signal` object that does not contain data. The `Children` property of the top-level signal object contains one or more `Signal` objects associated with the top-level composite signal that contain the data. Because the top-level signals do not contain data, they are not counted to determine the value of the `SignalCount` property for the Run object.

Use the `getSignalsByName` function to access the top-level `Signal` object for the Mux block output.

```
topSig = getSignalsByName(runObj, 'Mux');
```

Use the `Children` property to access the `Signal` object for each channel.

```
sig1 = topSig.Children(1);
sig1.Name
```

```
ans =
'Mux(1)'
```

```
sig2 = topSig.Children(2);
sig2.Name
```

```
ans =
'Mux(2)'
```

Convert Channels to a Multidimensional Signal

Use the `collapse` function to convert the representation of the Mux block output so you access the data as a single signal with multidimensional sample values.

```
collapse(sig1)
```

The Run object now contains only one signal with multidimensional sample values.

```
runObj.SignalCount
```

```
ans = int32
     1
```

The `Children` property of the top-level `Signal` object now contains only one signal.

```
size(topSig.Children)
```

```
ans = 1x2
```

```
1 1
```

After you convert a signal from channels to multidimensional representation, the `Signal` object that previously contained the data for the first channel contains the data for the multidimensional signal.

```
sig1.Values.Data
```

```
ans = 64x2
```

```
2.0000 0
2.0000 -0.0002
2.0000 -0.0012
2.0000 -0.0062
1.9998 -0.0306
1.9943 -0.1398
1.9379 -0.3840
1.8155 -0.5570
1.5990 -0.7204
1.2687 -0.9452
⋮
```

After conversion, the signal IDs for the `Signal` objects that contained data for other channels become invalid.

```
isValidSignalID(runObj,sig2.ID)
```

```
ans = logical
0
```

Convert a Multidimensional Signal to Channels

Use the `expand` function to convert the Mux output back to channels.

```
expand(sig1)
```

After converting a multidimensional signal to channels, the `Signal` object that previously contained the data for the multidimensional signal contains the data for the first channel. New `Signal` objects are created for other channels.

```
sig1.Name
```

```
ans =
'Mux(1)'
```

The `Run` object and the `Children` property of the top-level `Signal` object both contain two signals.

```
runObj.SignalCount
```

```
ans = int32
2
```

```
size(topSig.Children)
```

```
ans = 1x2
1 2
```

Access the new `Signal` object that contains the data for the second channel.

```
newSig = topSig.Children(2);  
newSig.Name
```

```
ans =  
'Mux(2)'
```

Input Arguments

sigObj — Channel of multidimensional signal to convert to single signal

`Simulink.sdi.Signal` object

Channel of multidimensional signal to convert to a single signal, specified as a `Simulink.sdi.Signal` object.

See Also

Objects

`Simulink.sdi.Signal` | `Simulink.sdi.Run`

Functions

`expand` | `convertToFrames`

Introduced in R2021b

convertToFrames

Package: Simulink.sdi

Remove buffering from frames of frame-based signal

Syntax

```
convertToFrames(sigObj)
```

Description

`convertToFrames(sigObj)` removes the buffering from each frame of the frame-based signal that corresponds to the `Simulink.sdi.Signal` object `sigObj`. For example, suppose `sigObj` is a frame-based signal with 64-by-2 sample values. The `convertToFrames` function interprets each 64-by-2 sample as 64 evenly spaced 1-by-2 samples.

To convert the representation of a signal using the `convertToFrames` function, the signal must have a discrete sample rate, and the sample values must be nonscalar with fixed dimensions. The `convertToFrames` function does not support variable-size signals. The Simulation Data Inspector does not support converting frames for imported data.

Examples

Interpret Data in Simulation Data Inspector as Frame-Based

Some applications buffer several samples of a signal into a *frame* to process with a single computation. When you log a frame-based signal to the Simulation Data Inspector, you can view and analyze the data for each frame using an array plot, or you can convert the representation of the signal data to undo the buffering.

This example converts the representation of two frame-based signals from the model `sfcndemo_frame`, which:

- 1 Samples a signal contaminated with noise using an analog to digital converter.
- 2 Performs a discrete Fourier transform (DFT) on a frame of the sampled signal.
- 3 Removes the noise from the signal in the frequency domain.
- 4 Performs an inverse DFT on the filtered signal to return to the time domain.

Simulating the model for this example requires a license for DSP System Toolbox™. Converting frame-based data in the Simulation Data Inspector does not require a license for DSP System Toolbox.

Open and Simulate the Model

Open the model `sfcndemo_frame`, then mark the time-domain signals for logging and give the signal lines a name.

```
open_system('sfcndemo_frame');  
ADPort = get_param(find_system(gcs, 'FindAll', 'on', 'name', 'A/D Converter' ), 'PortHandles');
```

```

set_param(ADPort.Outputport, 'DataLogging', 'on');

ADLine = get_param(ADPort.Outputport, 'Line');
set_param(ADLine, 'Name', 'Noisy Signal');

DAPort = get_param(find_system(gcs, 'FindAll', 'on', 'name', 'Remove trailing zeros' ), 'PortHandle');
set_param(DAPort.Outputport, 'DataLogging', 'on');

DALine = get_param(DAPort.Outputport, 'Line');
set_param(DALine, 'Name', 'Noise Removed Signal');

```

Simulate the model.

```
out = sim('sfcndemo_frame', 'StopTime', '99.84');
```

Access the Data in the Simulation Data Inspector

Use the `Simulink.sdi.getCurrentSimulationRun` function to access the simulation data.

```
runObj = Simulink.sdi.getCurrentSimulationRun('sfcndemo_frame');
```

Use the `getSignalsByName` function to access the `Simulink.sdi.Signal` object for each of the time-domain signals, `Noisy Signal` and `Noise Removed Signal`.

```
NoisySig = getSignalsByName(runObj, 'Noisy Signal');
NoNoiseSig = getSignalsByName(runObj, 'Noise Removed Signal');
```

Check the dimensions for a sample of each signal. The signal has two channels with a frame size of 64, resulting in sample values with dimensions 64-by-2. Because each sample is two-dimensional, the third dimension aligns with the time vector for the signal.

```
size(NoisySig.Values.Data(:, :, 1))
```

```
ans = 1×2
```

```
64    2
```

```
size(NoNoiseSig.Values.Data(:, :, 1))
```

```
ans = 1×2
```

```
64    2
```

Convert the Signals to Remove the Frame Buffering

To analyze the the data for each signal over the duration of the simulation, use the `convertToFrames` function to interpret the signal as frame-based.

```
convertToFrames(NoisySig);
convertToFrames(NoNoiseSig);
```

Check the dimensions for a sample of each signal. After interpreting the signal as frame-based, each sample is a vector, so time aligns with the first dimension.

```
size(NoisySig.Values.Data(1, :))
```

```
ans = 1×2
```

```
      1      2

size(NoNoiseSig.Values.Data(1,:))

ans = 1×2

      1      2
```

Because the resulting signal has fewer than four elements, the Simulation Data Inspector also automatically converts the signal to channels. The Run object now contains four signals.

```
runObj.SignalCount

ans = int32
     4
```

You can access the `Signal` objects for each channel using the `Children` property for each of the original `Signal` objects.

```
NoisyChannel1 = NoisySig.Children(1);
NoisyChannel1.Name

ans =
'Noisy Signal(1)'
```

```
NoisyChannel2 = NoisySig.Children(2);
NoisyChannel1.Name

ans =
'Noisy Signal(1)'
```

Each channel has scalar sample values.

```
size(NoisyChannel1.Values.Data(1,:))

ans = 1×2

      1      1
```

Input Arguments

sigObj — Signal with data to convert

`Simulink.sdi.Signal` object

Signal with data to convert, specified as a `Simulink.sdi.Signal` object. The `convertToFrames` function does not support variable-size signals.

See Also

Objects

`Simulink.sdi.Signal` | `Simulink.sdi.Run`

Functions

`collapse` | `expand`

Introduced in R2021b

convertUnits

Package: Simulink.sdi

Convert units of Simulink.sdi.Signal object

Syntax

```
convertUnits(sig,units)
```

Description

`convertUnits(sig,units)` converts the stored units of the `Simulink.sdi.Signal` object `sig` to the units specified by `units`. When you convert the stored units, the display units are updated. For a list of supported units, see [Allowed Units](#). You can use the `convertUnits` function to convert the units of `Simulink.sdi.Signal` objects that contain data of all built-in and fixed-point types.

Note Unit conversion does not support undo and may lead to precision loss.

Examples

Programmatically Convert Signal Units

Use the `convertUnits` function to convert the stored units of a `Simulink.sdi.Signal` object. This example uses data generated by simulating the model `sldemo_autotrans`. When you convert the stored units of the `Signal` object, the Simulation Data Inspector performs a conversion on the data and updates the signal display units any plots that display the signal. Changing the stored units of a `Signal` object does not affect the model that created the signal.

Generate Simulation Data

Simulate the `sldemo_autotrans` model to create a run in the Simulation Data Inspector. Then, use the `Simulink.sdi.Run.getLatest` function to access the `Run` object that corresponds to the simulation.

```
out = sim('sldemo_autotrans');  
autoRun = Simulink.sdi.Run.getLatest;
```

Inspect the Signal Properties

Get the `Simulink.sdi.Signal` object for the `EngineRPM` signal and check the `StoredUnits` and `DisplayUnits` properties.

```
engine_sig = getSignalsByName(autoRun, 'EngineRPM');  
engine_sig.StoredUnits  
  
ans =  
'rpm'
```



```
engine_sig.DisplayUnits
```

```
ans =  
'rpm'
```

Convert Stored Units

Use the `convertUnits` function to convert the `EngineRPM` signal units to `rad/s`. When you convert the stored units, the display units are updated. Then, change the signal name to reflect the new units.

```
convertUnits(engine_sig, 'rad/s')  
engine_sig.Name = 'EngineFreq, rad/s';
```

Check the modified signal properties.

```
engine_sig.StoredUnits
```

```
ans =  
'rad/s'
```

```
engine_sig.DisplayUnits
```

```
ans =  
'rad/s'
```

```
engine_sig.Name
```

```
ans =  
'EngineFreq, rad/s'
```

Input Arguments

sig — Signal with units to convert

`Simulink.sdi.Signal` object

Signal with units to convert, specified as a `Simulink.sdi.Signal` object.

units — Desired signal units

string | character vector

Desired signal units, specified as a string or character vector. For a list of accepted units, see [Allowed Units](#).

Example: 'm'

Example: "ft/s"

Data Types: char | string

See Also

`Simulink.sdi.Signal`

Topics

“Inspect and Compare Data Programmatically”

“Configure the Simulation Data Inspector”

“Modify Signal Properties in the Simulation Data Inspector”

“Unit Specification in Simulink Models”

“Units in Simulink”

Introduced in R2018a

expand

Package: Simulink.sdi

Represent multidimensional signal as group of signals with scalar sample values

Syntax

```
expand(sigObj)
```

Description

`expand(sigObj)` converts the representation of the signal that corresponds to the `Simulink.sdi.Signal` object `sigObj` from a single signal with nonscalar sample values to a set of signals with scalar sample values: one signal, called a channel, for each element in the multidimensional sample values.

Expanding a signal creates a new `Signal` object for each channel except the channel that corresponds to the first element in the multidimensional signal value. The data for the first channel in the multidimensional signal is stored in the `Signal` object that previously contained the multidimensional signal data.

The `expand` function does not support variable-size signals.

Examples

Convert Representation of Multidimensional Signal Data

When you analyze multidimensional signal data using the Simulation Data Inspector, you can choose whether to represent the data as a single signal with multidimensional sample values or as a set of signals, called *channels*, with scalar sample values. Use the Simulation Data Inspector programmatic interface to convert the representation of a signal created by logging the output of the Mux block in the model `vdp`.

Open and Simulate the Model

Open the model `vdp`, mark the output of the Mux block for logging, and name the Mux block output signal. Then, simulate the model.

```
open_system('vdp');  
  
MuxPort = get_param('vdp/Mux','PortHandles');  
set_param(MuxPort.Outputport,'DataLogging','on');  
  
MuxSig = get_param(MuxPort.Outputport,'Line');  
set_param(MuxSig,'Name','Mux');  
  
sim('vdp');
```

Access the Run and Signal Data

By default, the output of the Mux block is represented as channels in the Simulation Data Inspector because it contains fewer than four channels, so the run contains two signals: one for each channel in the Mux block output.

Use the `Simulink.sdi.getCurrentSimulationRun` function to access the `Simulink.sdi.Run` object that contains the simulation data. Then, check how many `Simulink.sdi.Signal` objects the Run object contains using the `SignalCount` property on the Run object.

```
runObj = Simulink.sdi.getCurrentSimulationRun('vdp');  
runObj.SignalCount
```

```
ans = int32  
     2
```

Signals with multidimensional data have a top-level `Signal` object that does not contain data. The `Children` property of the top-level signal object contains one or more `Signal` objects associated with the top-level composite signal that contain the data. Because the top-level signals do not contain data, they are not counted to determine the value of the `SignalCount` property for the Run object.

Use the `getSignalsByName` function to access the top-level `Signal` object for the Mux block output.

```
topSig = getSignalsByName(runObj, 'Mux');
```

Use the `Children` property to access the `Signal` object for each channel.

```
sig1 = topSig.Children(1);  
sig1.Name
```

```
ans =  
'Mux(1)'
```

```
sig2 = topSig.Children(2);  
sig2.Name
```

```
ans =  
'Mux(2)'
```

Convert Channels to a Multidimensional Signal

Use the `collapse` function to convert the representation of the Mux block output so you access the data as a single signal with multidimensional sample values.

```
collapse(sig1)
```

The Run object now contains only one signal with multidimensional sample values.

```
runObj.SignalCount
```

```
ans = int32  
     1
```

The `Children` property of the top-level `Signal` object now contains only one signal.

```
size(topSig.Children)
```

```
ans = 1×2
```

```
1 1
```

After you convert a signal from channels to multidimensional representation, the `Signal` object that previously contained the data for the first channel contains the data for the multidimensional signal.

```
sig1.Values.Data
```

```
ans = 64x2
```

```
2.0000 0
2.0000 -0.0002
2.0000 -0.0012
2.0000 -0.0062
1.9998 -0.0306
1.9943 -0.1398
1.9379 -0.3840
1.8155 -0.5570
1.5990 -0.7204
1.2687 -0.9452
⋮
```

After conversion, the signal IDs for the `Signal` objects that contained data for other channels become invalid.

```
isValidSignalID(runObj,sig2.ID)
```

```
ans = logical
0
```

Convert a Multidimensional Signal to Channels

Use the `expand` function to convert the Mux output back to channels.

```
expand(sig1)
```

After converting a multidimensional signal to channels, the `Signal` object that previously contained the data for the multidimensional signal contains the data for the first channel. New `Signal` objects are created for other channels.

```
sig1.Name
```

```
ans =
'Mux(1)'
```

The `Run` object and the `Children` property of the top-level `Signal` object both contain two signals.

```
runObj.SignalCount
```

```
ans = int32
2
```

```
size(topSig.Children)
```

```
ans = 1x2
1 2
```

Access the new `Signal` object that contains the data for the second channel.

```
newSig = topSig.Children(2);  
newSig.Name
```

```
ans =  
'Mux(2)'
```

Input Arguments

sigObj – Multidimensional signal to convert to channels

`Simulink.sdi.Signal` object

Multidimensional signal to convert to channels, specified as a `Simulink.sdi.Signal` object. The `expand` function does not support variable-size signals.

See Also

Objects

`Simulink.sdi.Signal` | `Simulink.sdi.Run`

Functions

`collapse` | `convertToFrames`

Introduced in R2021b

export

Package: Simulink.sdi

Export Simulink.sdi.Signal object to workspace or file

Syntax

```
ts = export(sig)
ts = export(sig,startTime,endTime)
export( ___,Name,Value)
```

Description

`ts = export(sig)` exports the Simulink.sdi.Signal object `sig` to the timeseries object, `ts`, in the MATLAB workspace.

`ts = export(sig,startTime,endTime)` exports the portion of the Simulink.sdi.Signal object defined by `startTime` and `endTime` to the timeseries object, `ts`, in the MATLAB workspace.

`export(___,Name,Value)` exports the Simulink.sdi.Signal object according to the options specified by one or more name-value arguments.

For most signals, you can choose to export the data to the base workspace, a MAT file, or a Microsoft Excel file.

When the signal contains video data, you can export the signal to an MP4 file. Exporting a video signal to an MP4 file is not supported for Linux® operating systems.

Examples

Export Signal Data to the Workspace

This example shows how to create a run in the Simulation Data Inspector, access the data, and export the signal data to a timeseries object in the workspace.

Simulate the model `sldemo_fuelsys` to create a run in the Simulation Data Inspector that contains the logged data.

```
sim('sldemo_fuelsys');
```

Use the `Simulink.sdi.getCurrentSimulationRun` function to access the run.

```
fuelRun = Simulink.sdi.getCurrentSimulationRun('sldemo_fuelsys');
```

Use the `getSignalByIndex` function to get the second signal in the `Simulink.sdi.Run` object.

```
sig = getSignalByIndex(fuelRun,2);
```

Export the signal data to the workspace using the `export` function.

```
ts = export(sig);
```

Input Arguments

sig – Signal to export

`Simulink.sdi.Signal` object

Signal to export, specified as a `Simulink.sdi.Signal` object.

startTime – Export start time

integer

Start time for the signal portion to export, specified as an integer.

Example: 0

Data Types: `single` | `double` | `int8` | `int16` | `int32` | `int64` | `uint8` | `uint16` | `uint32` | `uint64`

endTime – Export end time

integer

End time for the signal portion to export, specified as an integer.

Example: 10

Data Types: `single` | `double` | `int8` | `int16` | `int32` | `int64` | `uint8` | `uint16` | `uint32` | `uint64`

Name-Value Pair Arguments

Specify optional comma-separated pairs of `Name`, `Value` arguments. `Name` is the argument name and `Value` is the corresponding value. `Name` must appear inside quotes. You can specify several name and value pair arguments in any order as `Name1, Value1, ..., NameN, ValueN`.

Example: `'to', 'file'`

to – Where to export data

`'variable'` (default) | `'file'`

Where to export data, specified as the comma-separated pair consisting of `'to'` and `'variable'` or `'file'`.

When you export data to a file, you must also specify a file name using the `'filename'` name-value pair argument. You can specify a file name with a `.mat`, `.xlsx`, or `.mp4` extension.

When you export a signal to a MAT file, the data is saved in the MAT file as a `timeseries` object.

Data exported to a Microsoft Excel file is saved using the format described in “Microsoft Excel Import, Export, and Logging Format”.

When you export data to a Microsoft Excel file, you can specify additional options using the `'overwrite'`, `'metadata'`, and `'sharetimecolumn'` name-value arguments.

To export a video signal to an MP4 file:

- The signal must be 2D or 3D and contain RGB or monochrome video data.

- The data type for the signal values must be `double`, `single`, or `uint8`.
- The signal must be represented as a single signal with multidimensional sample values.

You may need to convert the representation of the signal using the `collapse` function before exporting the signal data. For more information, see “Analyze Multidimensional Signal Data”.

Example: `'to','file'`

filename — Name of file to contain exported data

string | character array

Name of file to contain exported data, specified as the comma-separated pair consisting of `'filename'` and a string or character array. Include a `.mat`, `.xlsx`, or `.mp4` extension in the file name to specify whether to export to a MAT file, a Microsoft Excel file, or an MP4 file. When you do not specify an extension with the file name, the data exports to a MAT file.

Use the `'filename'` name-value pair argument when you specify the `'to'` name-value pair argument with the value `'file'`.

When you export data to a Microsoft Excel file, you can specify additional options using the `'overwrite'`, `'metadata'`, and `'sharetimecolumn'` name-value pair arguments.

To export a video signal to an MP4 file:

- The signal must be 2D or 3D and contain RGB or monochrome video data.
- The data type for the signal values must be `double`, `single`, or `uint8`.
- The signal must be represented as a single signal with multidimensional sample values.

You may need to convert the representation of the signal using the `collapse` function before exporting the signal data. For more information, see “Analyze Multidimensional Signal Data”.

Example: `'filename','mySpreadsheet.xlsx'`

overwrite — Data to overwrite in existing Microsoft Excel file

`'file'` (default) | `'sheetonly'`

Data to overwrite in existing Microsoft Excel file, specified as the comma-separated pair consisting of `'overwrite'` and `'file'` or `'sheetonly'`.

- `'file'` — Overwrite the entire file with the exported data.
- `'sheetonly'` — Only overwrite sheets of the Microsoft Excel file with data that corresponds to the exported data.

When you export data to an existing MAT-file, the exported data overwrites the entire file.

Example: `'overwrite','sheetonly'`

metadata — Metadata to include in exported Microsoft Excel file

`[]` (default) | string array

Metadata to include in the exported Microsoft Excel file, specified as the comma-separated pair consisting of `'metadata'` and a string array. By default, the export operation does not include any metadata. You can export this metadata to the Microsoft Excel file:

- `dataType` — Signal data type
- `units` — Signal units
- `blockPath` — Path to the source block for logged signals
- `interp` — Signal interpolation method
- `portIndex` — Index of the port on the source block for logged signals

You can specify the desired metadata in any order you choose in the string array. The order of the metadata does not affect the format in the exported file, which always matches the description in “Microsoft Excel Import, Export, and Logging Format”.

Example: `'metadata', ["units", "dataType"]`

sharetimecolumn — Whether signals share time columns in exported Microsoft Excel file
'on' (default) | 'off'

Whether signals that have identical time data share time columns in the exported Microsoft Excel file, specified as the comma-separated pair consisting of 'sharetimecolumn' and 'on' or 'off'. By default, signals with the same time data share a time column in the exported file. When you specify the value as 'off', each signal in the exported file has its own time column.

Example: `'sharetimecolumn', 'off'`

Output Arguments

ts — Exported signal data

timeseries object

Exported signal data, returned as a `timeseries` object.

Alternatives

You can export data to the workspace or a file using the Simulation Data Inspector UI. For more information, see “Save and Share Simulation Data Inspector Data and Views”.

See Also

`Simulink.sdi.Signal` | `Simulink.sdi.exportRun`

Topics

“Inspect and Compare Data Programmatically”

“Save and Share Simulation Data Inspector Data and Views”

Introduced in R2017b

getAsTall

Package: Simulink.sdi

Create tall timetable from Simulink.sdi.Signal object

Syntax

```
tt = getAsTall(sig)
```

Description

`tt = getAsTall(sig)` returns a tall timetable containing the time and data values in the Simulink.sdi.Signal object `sig`. For more information on working with tall arrays, see “Tall Arrays for Out-of-Memory Data”.

Examples

Get Tall Timetable of Signal Data

This example shows how to generate a tall timetable from the signal data in a Simulink.sdi.Signal object.

Create a run containing logged data in the Simulation Data Inspector by simulating the model `sldemo_fuelsys`.

```
sim('sldemo_fuelsys');
```

Use the `Simulink.sdi.getAllRunIDs` function to get the run ID for the run that corresponds to the simulation. Then use the `Simulink.sdi.getRun` function to get the `Simulink.sdi.Run` object that corresponds to the run ID.

```
runIDs = Simulink.sdi.getAllRunIDs;
runID = runIDs(end);
```

```
fuelRun = Simulink.sdi.getRun(runID);
```

Use the `getSignalByIndex` function to get the `Simulink.sdi.Signal` object that corresponds to the second signal in the run.

```
sig = getSignalByIndex(fuelRun,2);
```

Get a tall timetable containing the signal data by using the `getAsTall` function.

```
tt = getAsTall(sig)
```

```
tt =
```

```
    Mx1 tall timetable
```

```
      Time
```

```
      Data
```

```
_____
```

| | |
|----------------|----------|
| 0 sec | 0.068493 |
| 0.00056199 sec | 0.092452 |
| 0.0033719 sec | 0.21101 |
| 0.01 sec | 0.48273 |
| 0.02 sec | 0.88522 |
| 0.03 sec | 1.2763 |
| 0.04 sec | 1.6563 |
| 0.05 sec | 2.0255 |
| : | : |
| : | : |

Input Arguments

sig — Signal to return as a tall timetable

`Simulink.sdi.Signal` object

Signal to return as a tall timetable, specified as a `Simulink.sdi.Signal` object.

Output Arguments

tt — Tall timetable

tall timetable

Data from the `Simulink.sdi.Signal`, returned as a tall timetable.

See Also

`Simulink.sdi.Signal` | `export` | `Simulink.sdi.exportRun` | `tall`

Topics

“Inspect and Compare Data Programmatically”

Introduced in R2017b

plotOnSubPlot

Package: Simulink.sdi

Plot Simulink.sdi.Signal object on Simulation Data Inspector subplot

Syntax

```
plotOnSubplot(sig,r,c,checked)
```

Description

plotOnSubplot(sig,r,c,checked) plots or clears the signal that corresponds to the Simulink.sdi.Signal object sig on the subplot specified by r and c.

Examples

Plot Signals from Simulation Run

This example demonstrates how to access the Simulink.sdi.Run object for a Simulation Data Inspector run created by logging signals. From the Simulink.sdi.Run object you can get Simulink.sdi.Signal objects that contain the logged signal data and metadata. You can use the Signal objects and the plotOnSubPlot function to plot the data in the Simulation Data Inspector.

Create a Simulation Run and Access the Run Object

The ex_vdp model logs two signals. To create a simulation run containing the logged data, simulate the model.

```
sim('ex_vdp');
```

The Simulation Data Inspector keeps track of runs by assigning a unique numeric run ID to each run created by simulation, importing data, or opening a session. To access the run object for the simulation you just performed, use the Simulink.sdi.getAllRunIDs function and take the last run ID in the returned vector.

```
runIDs = Simulink.sdi.getAllRunIDs;
runID = runIDs(end);
```

Once you have the run ID for the run, you can use the Simulink.sdi.getRun function to get the Simulink.sdi.Run object that corresponds to the run. You can use the Run object to check the metadata associated with the run, including the number of signals in the run.

```
vdpRun = Simulink.sdi.getRun(runID);
```

```
vdpRun.SignalCount
```

```
ans = int32
     2
```

Plot Data Using Signal Objects

Use the `getSignalByIndex` function to access signals from the Run object, `fuelRun`.

```
signal1 = getSignalByIndex(vdpRun,1);  
signal2 = getSignalByIndex(vdpRun,2);
```

Use the `Simulink.sdi.setSubPlotLayout` function to specify a 3-by-1 layout.

```
Simulink.sdi.setSubPlotLayout(2,1)
```

Before plotting the data, use the `Simulink.sdi.clearAllSubPlots` function to clear any data that is already plotted.

```
Simulink.sdi.clearAllSubPlots
```

Plot one signal on each subplot. To plot signals on the first subplot, you can set the checked property for the signal. To plot signals on subplots other than the first subplot, use the `plotOnSubPlot` function.

```
signal1.Checked = true;  
plotOnSubPlot(signal2,2,1,true);
```

View the Plotted Data

To view the plots you just created, open the Simulation Data Inspector using the `Simulink.sdi.view` function.

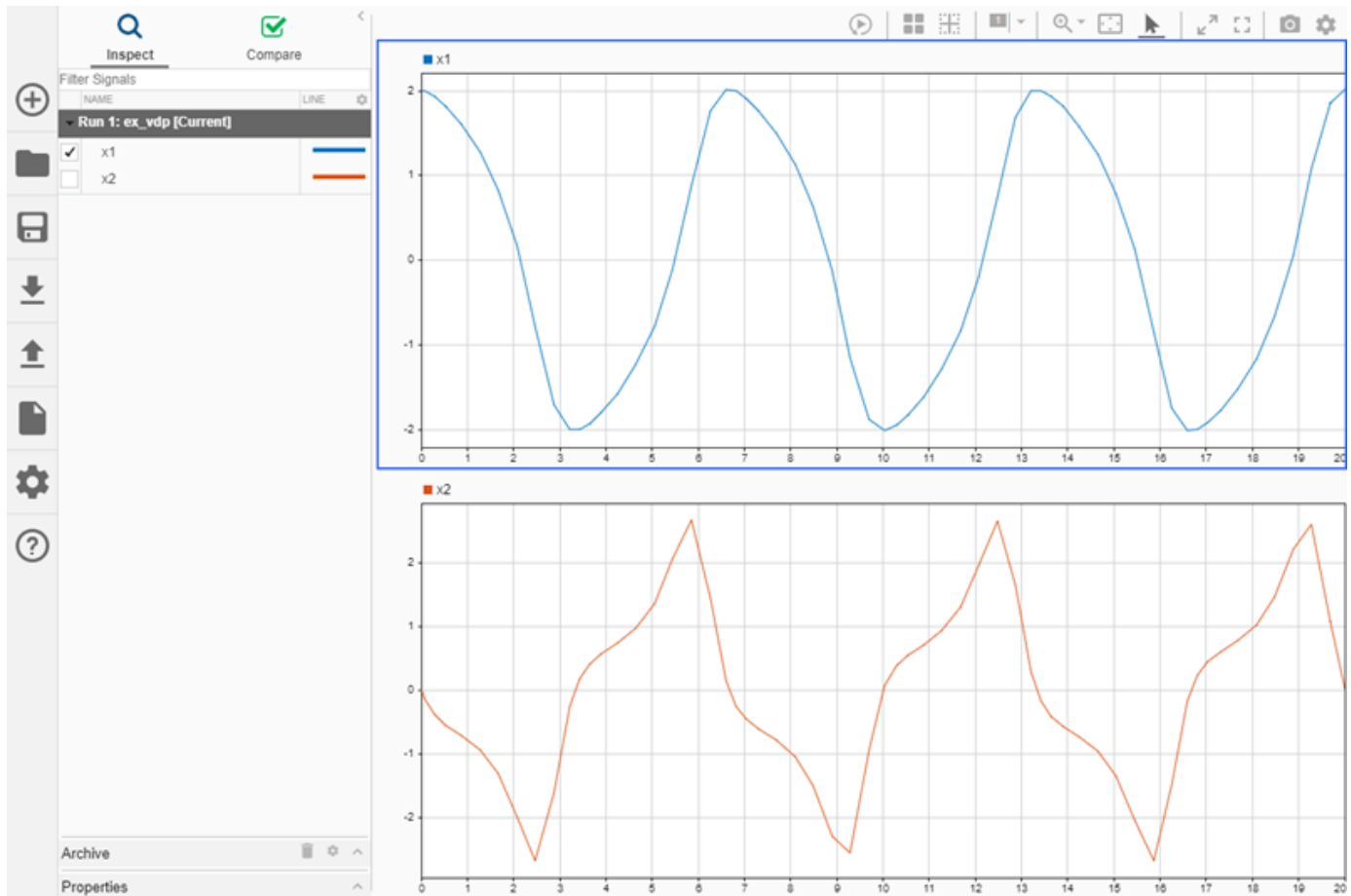

Input Arguments

sig – Signal to plot

`Simulink.sdi.Signal` object

Signal to plot, specified as a `Simulink.sdi.Signal` object.

r – Row index

integer

Row index for the subplot, specified as an integer between 1 and 8, inclusive.

Example: 1

c – Column index

integer

Column index for the subplot, specified as an integer between 1 and 8, inclusive.

Example: 2

checked – Plot or clear signal

`true` | `false`

Plot or clear the signal on the subplot, specified as one of these values:

- `true` plots the signal on the subplot.
- `false` clears the signal from the subplot.

Data Types: `logical`

Alternatives

You can use the Simulation Data Inspector UI to modify the plot layout and plotted signals. For more information, see “Inspect Simulation Data”.

See Also

`Simulink.sdi.clearAllSubPlots` | `Simulink.sdi.setSubPlotLayout` |
`Simulink.sdi.Signal` | `Simulink.sdi.saveView` | `Simulink.sdi.save`

Topics

“Inspect and Compare Data Programmatically”

“Create Plots Using the Simulation Data Inspector”

Introduced in R2017b

Simulink.sdi.snapshot

Package: Simulink.sdi

Capture contents of Simulation Data Inspector plots

Syntax

```
fig = Simulink.sdi.snapshot
[fig,image] = Simulink.sdi.snapshot
Simulink.sdi.snapshot(Name,Value)
Simulink.sdi.snapshot(Name,Value)
Simulink.sdi.snapshot(Name,Value)
```

Description

`fig = Simulink.sdi.snapshot` creates a figure of the plotting area in the open Simulation Data Inspector session with the figure handle `fig`.

`[fig,image] = Simulink.sdi.snapshot` creates a figure of the plotting area in the open Simulation Data Inspector session with the figure handle `fig` and returns the image data in the array, `image`.

`Simulink.sdi.snapshot(Name,Value)` captures an image of the Simulation Data Inspector plots according to the options specified by name-value pairs.

`fig = Simulink.sdi.snapshot(Name,Value)` captures an image of the Simulation Data Inspector plots according to the options specified by name-value pairs. This syntax returns the figure handle, `fig`, if a figure is created.

`[fig, image] = Simulink.sdi.snapshot(Name,Value)` captures an image of the Simulation Data Inspector plots according to the options specified by name-value pairs. This syntax returns the figure handle, `fig`, and an array of image data, `image`, when appropriate for the specified options.

Examples

Copy View Settings to a Run

This example shows how to copy view settings from one run to another and how to create figures using the `Simulink.sdi.CustomSnapshot` object.

Simulate Your Model and Get a Run Object

Configure the `vdp` model to save output data, and run a simulation to create data.

```
load_system('vdp')
set_param('vdp','SaveFormat','Dataset','SaveOutput','on')
set_param('vdp/Mu','Gain','1');
sim('vdp');
```

Use the Simulation Data Inspector programmatic interface to access the run data.

```
runIndex = Simulink.sdi.getRunCount;  
runID = Simulink.sdi.getRunIDByIndex(runIndex);  
vdpRun = Simulink.sdi.getRun(runID);
```

Modify Signal View Settings

Use the `Simulink.sdi.Run` object to access signals in the run. Then, modify the signal view settings. This example specifies the line color and style for each signal. The view settings for the run comprise the view settings for each signal and view settings specified for the plot area.

```
sig1 = vdpRun.getSignalByIndex(1);  
sig2 = vdpRun.getSignalByIndex(2);  
  
sig1.LineColor = [0 0 1];  
sig1.LineDashed = '-.';  
  
sig2.LineColor = [1 0 0];  
sig2.LineDashed = ':';
```

Capture a Snapshot from the Simulation Data Inspector

Create a `Simulink.sdi.CustomSnapshot` object and use the `Simulink.sdi.snapshot` function to programmatically capture a snapshot of the contents of the Simulation Data Inspector.

```
snap = Simulink.sdi.CustomSnapshot;
```

You can use properties of the `Simulink.sdi.CustomSnapshot` object to configure the plot settings, like the subplot layout and axis limits, and to plot signals. When you use a `Simulink.sdi.CustomSnapshot` object to create your figure, these plot settings do not affect the Simulation Data Inspector.

```
snap.Rows = 2;  
snap.YRange = {[-2.25 2.25], [-3 3]};  
snap.plotOnSubPlot(1,1,sig1,true)  
snap.plotOnSubPlot(2,1,sig2,true)
```

Use `Simulink.sdi.snapshot` to generate the figure you specified in the properties of the `Simulink.sdi.CustomSnapshot` object.

```
fig = Simulink.sdi.snapshot("from", "custom", "to", "figure", "settings", snap);
```

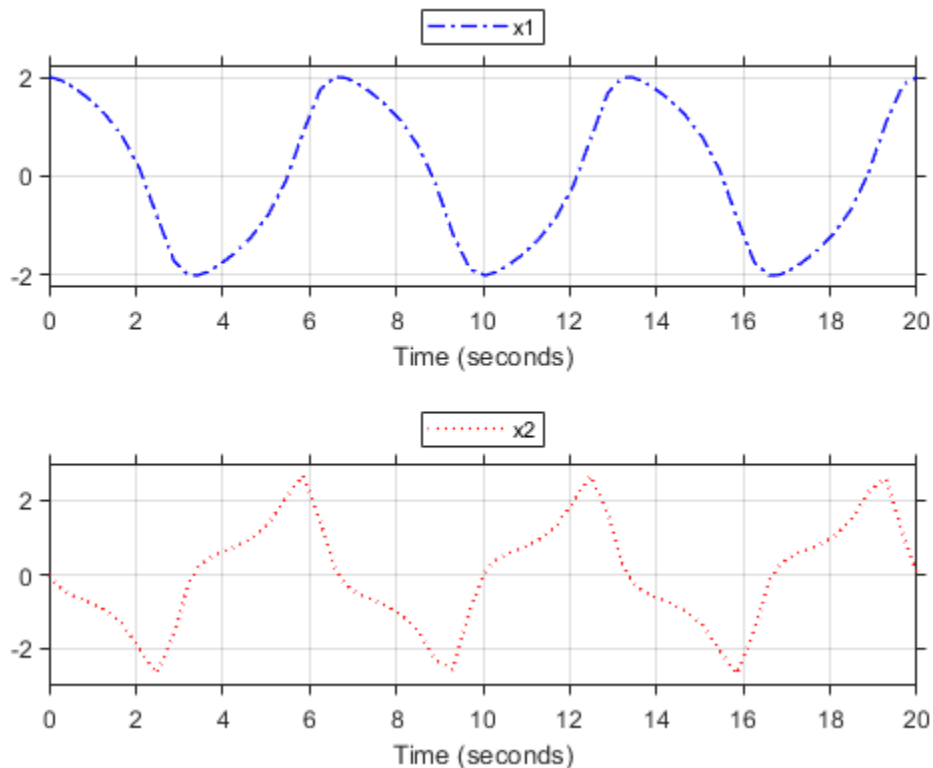

Copy the View Settings to a New Simulation Run

Simulate the model again, with a different Mu value. Use the Simulation Data Inspector programmatic interface to access the simulation data.

```
set_param('vdp/Mu','Gain','5')
sim('vdp');
```

```
runIndex2 = Simulink.sdi.getRunCount;
runID2 = Simulink.sdi.getRunIDByIndex(runIndex2);
run2 = Simulink.sdi.getRun(runID2);
```

To create a plot of the new output data that looks like the one you created in the previous step, you can copy the view settings to the run in a single line of code using `Simulink.sdi.copyRunViewSettings`. The `Simulink.sdi.copyRunViewSettings` function does not automatically update plot settings in `Simulink.sdi.CustomSnapshot` objects, so specify the plot input as `false`.

```
sigIDs = Simulink.sdi.copyRunViewSettings(runID,runID2,false);
```

Capture a Snapshot of the New Simulation Run

Use the `Simulink.sdi.CustomSnapshot` object to capture a snapshot of the new simulation run. First, clear the signals from the subplots. Then, plot the signals from the new run and capture another snapshot.

```
snap.clearSignals
snap.YRange = {[-2.25 2.25],[-8 8]};
```

```

snap.plotOnSubPlot(1,1,sigIDs(1),true)
snap.plotOnSubPlot(2,1,sigIDs(2),true)

fig = snap.snapshot("to","figure");

```

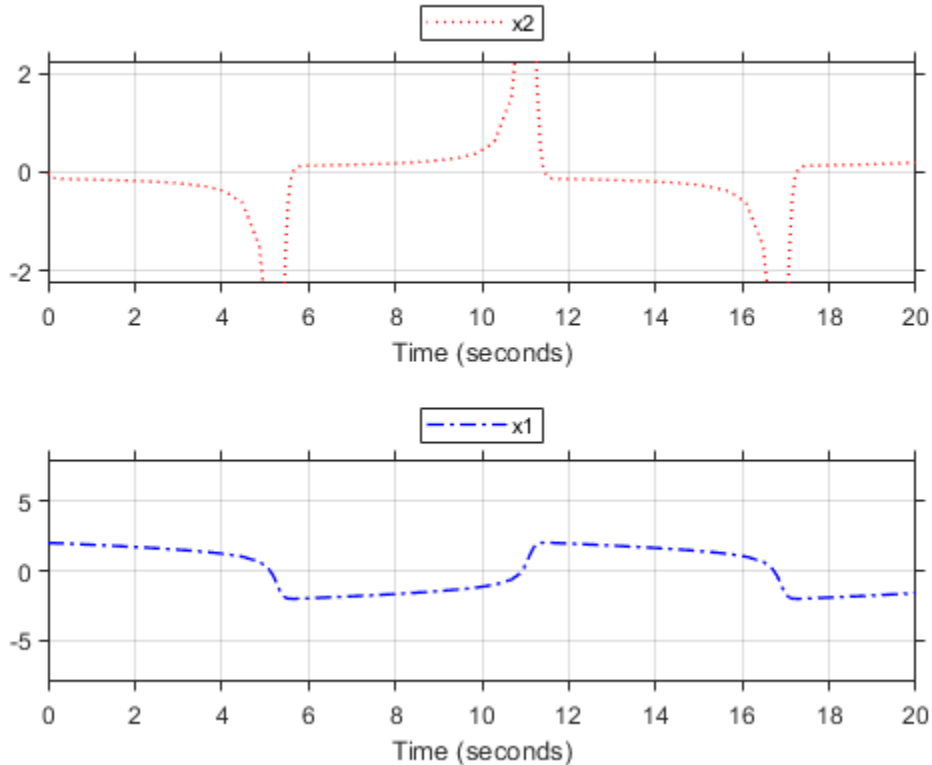

Input Arguments

Name-Value Pair Arguments

Specify optional comma-separated pairs of **Name**, **Value** arguments. **Name** is the argument name and **Value** is the corresponding value. **Name** must appear inside quotes. You can specify several name and value pair arguments in any order as **Name1**, **Value1**, ..., **NameN**, **ValueN**.

Example: 'to', 'figure', 'props', {'Name', 'My Data'}

from — Content to include in the snapshot

'opened' (default) | 'active' | 'comparison' | 'custom'

Content to include in the snapshot.

- 'opened' — Include all subplots in the graphical viewing area of the open Simulation Data Inspector session.
- 'active' — Include only the active (selected) subplot in the open Simulation Data Inspector session.
- 'comparison' — Include the comparison plots for the selected comparison run or signal in the open Simulation Data Inspector session.

- `'custom'` — Include contents specified by the `settings` name-value pair `Simulink.sdi.CustomSnapshot` object. You can use the `'from', 'custom'` option to create a snapshot without opening the Simulation Data Inspector or affecting your open Simulation Data Inspector session. Include a `settings` name-value pair when you specify `'from', 'custom'`.

Example: `'from', 'comparison'`

Data Types: `char | string`

to — Type of snapshot to create

`'image'` (default) | `'figure'` | `'file'` | `'clipboard'`

Type of snapshot to create.

- `'image'` — Create a figure and return the figure handle and an array of image data. When you specify `'to', 'image'`, the `fig` and `image` outputs both have value.
- `'figure'` — Create a figure and return the figure handle. When you specify `'to', 'figure'` the `fig` output has value, and the `image` output is empty.
- `'file'` — Save to a PNG file with the name specified by the `filename` name-value pair. If you do not specify a `filename` name-value pair, the file is named `plots.png`. When you specify `'to', 'file'`, the `fig` and `image` outputs are both empty.
- `'clipboard'` — Copy the plots to your system clipboard. From the clipboard, you can paste the image into another program such as Microsoft Word. When you specify `'to', 'clipboard'`, the `fig` and `image` outputs are both empty.

Example: `'to', 'file'`

Data Types: `char | string`

filename — Name for image file

`'plots.png'` (default) | character array | string

Name of the image file to store the snapshot when you specify `'to', 'file'`.

Example: `'filename', 'MyImage.png'`

Data Types: `char | string`

props — Properties to customize the figure

cell array

Figure properties, specified as a cell array. You can include settings for the figure properties described in Figure Properties.

Example: `'props', {'Name', 'MyData', 'NumberTitle', 'off'}`

Data Types: `char | string`

settings — Custom snapshot settings

`Simulink.sdi.CustomSnapshot`

`Simulink.sdi.CustomSnapshot` object specifying custom snapshot settings. You can use the `settings` name-value pair to specify the dimensions of the image in pixels, subplot layout, and limits for the `x-` and `y-`axes.

Example: `'settings', customSnap`

Data Types: `char | string`

Output Arguments

fig — Figure handle

figure handle

Handle for the figure. When a figure is not created with your specified options, the `fig` output is empty.

image — Image data

array

Array of image data. The `image` output has value when you use `Simulink.sdi.snapshot` without any input arguments or without a `to` name-value pair and when you specify `'to','image'`.

See Also

`Simulink.sdi.setSubPlotLayout` | `Simulink.sdi.Signal` |
`Simulink.sdi.CustomSnapshot` | `Simulink.sdi.setMarkersOn` |
`Simulink.sdi.clearPreferences` | `Simulink.sdi.clear` | `Simulink.sdi.view`

Topics

“Inspect and Compare Data Programmatically”

“Create Plots Using the Simulation Data Inspector”

Introduced in R2018a

Simulink.sdi.unregisterCursorCallback

Unregister cursor callback function

Syntax

```
Simulink.sdi.unregisterCursorCallback(callbackID)
```

Description

`Simulink.sdi.unregisterCursorCallback(callbackID)` unregisters the cursor callback function that corresponds to `callbackID`.

Examples

Use Simulation Data Inspector Cursor Callback in App Designer App

You can use a Simulation Data Inspector cursor callback function to send cursor position data to an app you build using the App Designer. This example shows how to add a property to the app to store the callback ID and where to register and unregister the cursor callback. For an example of an App Designer app that uses a cursor callback, see “Synchronize Cursors in the Simulation Data Inspector with an App Designer App”.

Add a `callbackID` property to the app object.

```
properties (Access = private)
    callbackID
end
```

Define the behavior of the cursor callback function.

```
methods (Access = public)
    function myCursorCallback(app,~,~)
        if isvalid(app)
            ...
        end
    end
end
```

Register the cursor callback in the app `startupFcn`. This example registers the same callback on the **Inspect** pane and the **Compare** pane.

```
function startupFcn(app)
    app.callbackID = Simulink.sdi.registerCursorCallback(...
        @(t1,t2)myCursorCallback(app,t1,t2));
    app.callbackID(2) = Simulink.sdi.registerCursorCallback(...
        @(t1,t2)myCursorCallback(app,t1,t2), 'compare');
    ...
end
```

Unregister the cursor callback in the app `UIFigureCloseRequest` function.

```
function myAppUIFigureCloseRequest(app, event)
    Simulink.sdi.unregisterCursorCallback(app.callbackID(1));
    Simulink.sdi.unregisterCursorCallback(app.callbackID(2));

end
```

Input Arguments

callbackID — Registered callback ID

scalar

Registered callback ID, specified as a scalar. The callback ID is returned when you register the callback using the `Simulink.sdi.registerCursorCallback` function.

See Also

Functions

`Simulink.sdi.registerCursorCallback` | `Simulink.sdi.setCursorPositions` |
`Simulink.sdi.getCursorPositions` | `Simulink.sdi.setNumCursors` |
`Simulink.sdi.getNumCursors`

Topics

“Synchronize Cursors in the Simulation Data Inspector with an App Designer App”

Introduced in R2021a

Simulink.sdi.view

Package: Simulink.sdi

Open the Simulation Data Inspector

Syntax

```
Simulink.sdi.view
```

Description

`Simulink.sdi.view` opens the **Simulation Data Inspector**. You can write a script to plot your data and customize the Simulation Data Inspector properties and then use `Simulink.sdi.view` to see the results.

Examples

Open the Simulation Data Inspector from the Command Line

You can open the Simulation Data Inspector from the MATLAB command line to visualize, inspect, and analyze your data.

```
Simulink.sdi.view
```

Create a Run and View the Data

This example shows how to create a run, add data to it, and then view the data in the Simulation Data Inspector.

Create Data for the Run

Create `timeseries` objects to contain data for a sine signal and a cosine signal. Give each `timeseries` object a descriptive name.

```
time = linspace(0,20,100);  
  
sine_vals = sin(2*pi/5*time);  
sine_ts = timeseries(sine_vals,time);  
sine_ts.Name = 'Sine, T=5';  
  
cos_vals = cos(2*pi/8*time);  
cos_ts = timeseries(cos_vals,time);  
cos_ts.Name = 'Cosine, T=8';
```

Create a Run and Add Data

Use the `Simulink.sdi.view` function to open the Simulation Data Inspector.

```
Simulink.sdi.view
```

To import data into the Simulation Data Inspector from the workspace, create a `Simulink.sdi.Run` object using the `Simulink.sdi.Run.create` function. Add information about the run to its metadata using the `Name` and `Description` properties of the Run object.

```
sinusoidsRun = Simulink.sdi.Run.create;
sinusoidsRun.Name = 'Sinusoids';
sinusoidsRun.Description = 'Sine and cosine signals with different frequencies';
```

Use the `add` function to add the data you created in the workspace to the empty run.

```
add(sinusoidsRun, 'vars', sine_ts, cos_ts);
```

Plot the Data in the Simulation Data Inspector

Use the `getSignalByIndex` function to access `Simulink.sdi.Signal` objects that contain the signal data. You can use the `Simulink.sdi.Signal` object properties to specify the line style and color for the signal and plot it in the Simulation Data Inspector. Specify the `LineColor` and `LineDashed` properties for each signal.

```
sine_sig = getSignalByIndex(sinusoidsRun,1);
sine_sig.LineColor = [0 0 1];
sine_sig.LineDashed = '-.';

cos_sig = sinusoidsRun.getSignalByIndex(2);
cos_sig.LineColor = [0 1 0];
cos_sig.LineDashed = '--';
```

Use the `Simulink.sdi.setSubPlotLayout` function to configure a 2-by-1 subplot layout in the Simulation Data Inspector plotting area. Then use the `plotOnSubplot` function to plot the sine signal on the top subplot and the cosine signal on the lower subplot.

```
Simulink.sdi.setSubPlotLayout(2,1);

plotOnSubPlot(sine_sig,1,1,true);
plotOnSubPlot(cos_sig,2,1,true);
```

Close the Simulation Data Inspector and Save Your Data

When you have finished inspecting the plotted signal data, you can close the Simulation Data Inspector and save the session to an MLDATX file.

```
Simulink.sdi.close('sinusoids.mldatx')
```

Alternatives

You can open the Simulation Data Inspector from the Simulink Editor toolbar with the **Simulation**

Data Inspector button .

See Also

Functions

`Simulink.sdi.close` | `Simulink.sdi.clear` | `Simulink.sdi.clearPreferences` | `Simulink.sdi.setSubPlotLayout`

Tools

Simulation Data Inspector

Topics

“Inspect and Compare Data Programmatically”

“View Data in the Simulation Data Inspector”

Introduced in R2011b

Simulink.SimulationData.createStructOfTimeseries

Create structure of timeseries data to load as simulation input for bus

Syntax

```
tsStruct = Simulink.SimulationData.createStructOfTimeseries(busObj,  
tsStructIn)  
tsStruct = Simulink.SimulationData.createStructOfTimeseries(busObj,  
tsCellArray)  
tsStructArray = Simulink.SimulationData.createStructOfTimeseries(busObj,  
tsCellArray,dims)  
tsStruct = Simulink.SimulationData.createStructOfTimeseries(tsArray)
```

Description

`tsStruct = Simulink.SimulationData.createStructOfTimeseries(busObj, tsStructIn)` creates a structure with attributes that match those specified by the `Simulink.Bus` object, `busObj`, and data specified by the structure of timeseries objects, `tsStructIn`.

When the names in the input structure do not match the names specified by the bus object, the function renames the fields in the output structure to match the bus object specification. When other attributes such as data type and complexity do not match, the function returns an error.

You can use this syntax to create a simulation input that fully or partially specifies the data for a bus. You can also use this syntax to rename the structure elements to match the names in the `Simulink.Bus` object.

`tsStruct = Simulink.SimulationData.createStructOfTimeseries(busObj, tsCellArray)` creates a structure of timeseries objects with attributes that match those specified by the `Simulink.Bus` object, `busObj`, and data specified by the cell array of timeseries objects, `tsCellArray`.

When the names in the input structure do not match the names specified by the bus object, the function renames the fields in the output structure to match the bus object specification. When other attributes such as data type and complexity do not match, the function returns an error.

You can use this syntax to create simulation input that fully or partially specifies the data for a bus using a flat list of timeseries objects. The function maps the timeseries objects to the hierarchy specified by the `Simulink.Bus` object using a depth-first search.

`tsStructArray = Simulink.SimulationData.createStructOfTimeseries(busObj, tsCellArray,dims)` creates an array of timeseries structures where the attributes of each structure match those defined by the `Simulink.Bus` object, `busObj` with the data specified by the cell array of timeseries objects, `tsCellArray`. The input `dims` specifies the dimensions of the array.

`tsStruct = Simulink.SimulationData.createStructOfTimeseries(tsArray)` creates a structure of timeseries objects from the bus data stored in the `Simulink.TsArray` object, `tsArray`. In versions before R2016a, signal logging creates `Simulink.TsArray` objects to store

logged bus data. Use this syntax when you want to use bus data logged in a release before R2016a using ModelDataLogs format as simulation input.

Examples

Use Logged Bus Data as Simulation Input

You can use the `Simulink.SimulationData.createStructOfTimeseries` function to create structures of `timeseries` objects to use as simulation input for bus signals. This example shows you how to create a structure of `timeseries` to load into a model using `timeseries` data logged from a different simulation.

Create a Structure of Timeseries

Open the `ex_log_structtimeseries` model.

```
open_system('ex_log_structtimeseries')
```

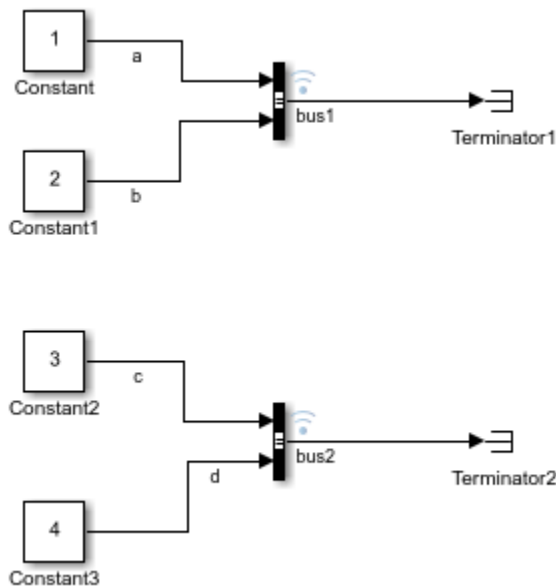

The model uses Constant blocks and Bus Creator blocks to build two buses, `bus1` and `bus2`, with signals `a`, `b`, `c`, and `d`. The model uses signal logging to log the bus data. Create bus data by simulating the model.

```
out = sim('ex_log_structtimeseries');
```

View the data in the logging variable `logout`. Signal logging creates a `Simulink.SimulationData.Dataset` object with `Simulink.SimulationData.Signal` objects as elements.

```
logout = out.logout
```

```
logout =
```

```
Simulink.SimulationData.Dataset 'logout' with 2 elements
```

| | Name | BlockPath |
|---|--------------|---|
| 1 | [1x1 Signal] | bus1 ex_log_structtimeseries/Bus Creator |
| 2 | [1x1 Signal] | bus2 ex_log_structtimeseries/Bus Creator1 |

- Use braces { } to access, modify, or add elements using index.

You can use the `get` function to select the `Simulink.SimulationData.Signal` object for `bus2`. The bus data is in the `Values` property of the `Simulink.SimulationData.Signal` object. The data representing `bus2` is logged in a structure containing `timeseries` objects named `c` and `d`.

```
logout.get(2).Values
```

```
ans =
```

```
struct with fields:
    c: [1x1 timeseries]
    d: [1x1 timeseries]
```

Loading Model Configuration

Open the `ex_load_structtimeseries` model, which uses the logged simulation data as input.

```
open_system('ex_load_structtimeseries')
```

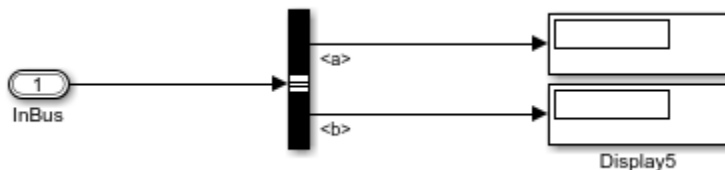

The model uses the `InBus` Inport block to load input bus data. A `Bus Selector` block chooses signals from the bus to display on `Display` blocks.

Double-click the `InBus` block and check its **Data type** on the **Signal Attributes** tab of the dialog. The data type is specified by a `Simulink.Bus` object called `bus`.

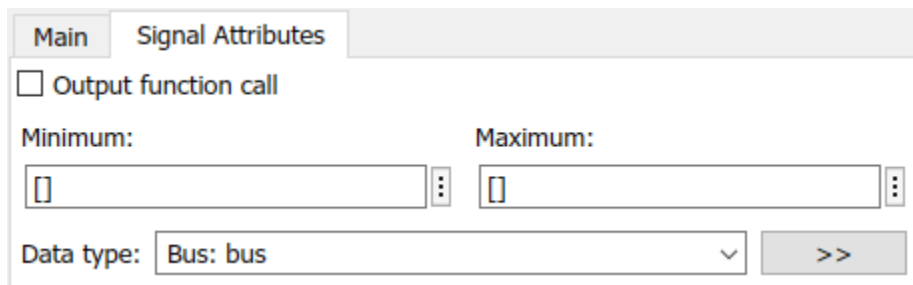

Close the dialog and open the Model Explorer. On the **Callbacks** tab, you can see the model uses its `PreLoadFcn` to define the `Simulink.Bus` object that defines the data type for the Inport block.

Open the Configuration Parameters and view the specification for the **Input** parameter on the **Data Import/Export** pane. The model uses the variable `inputBus` for its **Input**.

Create Simulation Input from the Structure of timeseries Data

To load the data logged for `bus1`, you only need to assign the structure data to the Input variable for the model.

```
inputBus = logouts.get(1).Values
```

```
inputBus =
    struct with fields:
        a: [1x1 timeseries]
        b: [1x1 timeseries]
```

When you simulate the model, the Display blocks show the values 1 and 2 logged in `bus1` and loaded into the model.

To load the data logged for `bus2`, you need to use the `Simulink.Bus` object that defines the Inport block data type and `Simulink.SimulationData.createStructOfTimeseries` to create a structure of `timeseries` with names specified by the `Simulink.Bus` object.

```
inputBus = Simulink.SimulationData.createStructOfTimeseries('bus', ...
    logouts.get(2).Values)
```

```
inputBus =
    struct with fields:
        a: [1x1 timeseries]
        b: [1x1 timeseries]
```

When you simulate the model, the Display blocks show the values 3 and 4 logged in `bus2` and loaded into the model.

Partially Specify Simulation Input for a Bus

This example shows how to use the `Simulink.SimulationData.createStructOfTimeseries` function to create partially specified simulation input for a bus. This example logs data from `ex_log_structtimeseries` and then loads that data into `ex_load_structtimeseries`.

Create timeseries Data

First, open and simulate the `ex_log_structtimeseries` model. The model logs two bus signals, `bus1` and `bus2`, created using Constant blocks and Bus Creator blocks. Access the `logouts` Dataset in the `Simulink.SimulationOutput` object, `out`.

```
open_system('ex_log_structtimeseries')
out = sim('ex_log_structtimeseries');
```

```
logout = out.logout;
```

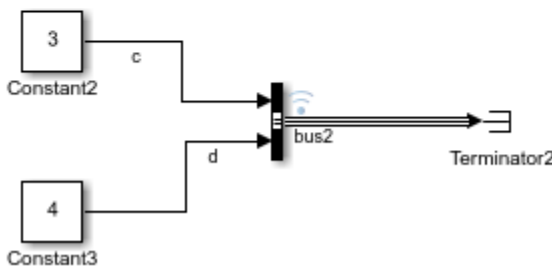
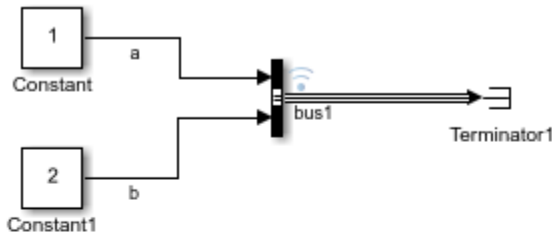

You can use a structure of timeseries data or a cell array of timeseries data to partially specify simulation input for a bus.

Partially Specify Bus Data with a Structure of timeseries Data

Open the model `ex_load_structtimeseries` that will load some of the data you logged in the previous section.

```
open_system('ex_load_structtimeseries')
```

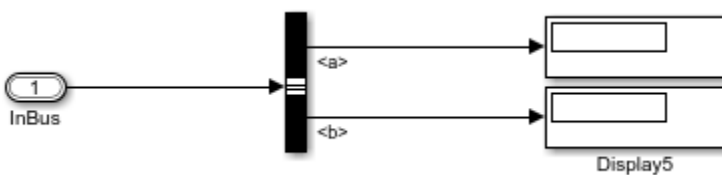

Use the `get` function to access the structure of timeseries data logged for `bus1`.

```
bus1 = logout.get(1).Values;
```

Then, replace the `b` data with `[]`.

```
bus1.b = [];
```

The `ex_load_structtimeseries` model uses the variable `inputBus` as its **Input**. The `Simulink.Bus` object, `bus`, that defines the data type for the Inport block is defined in the `PreLoadFcn` callback for the `ex_load_structtimeseries` model. Because the signal names in `bus1` match the `Simulink.Bus` object specification for the Inport block in the `ex_load_structtimeseries` model, you can use the logged structure without modification. To load the data for `bus1`, assign `bus1` to the variable `inputBus`.

```
inputBus = bus1;
```

Simulate the model. The Display blocks show the logged value 1 for a and 0 for b. The simulation uses ground values when you do not specify data for the signal.

```
loadOut = sim('ex_load_structtimeseries');
```

Now, load the data logged for bus2. The signal names in bus2 do not match the `Simulink.Bus` object specification for the Inport block in the `ex_load_structtimeseries` model. Modify the data in the structure to partially specify input data for the bus. Then, use the `Simulink.SimulationData.createStructOfTimeseries` function to change the names in the structure to match the bus specification.

```
bus2 = logout.get(2).Values;
bus2.d = [];
inputBus = bus2;
inputBus = Simulink.SimulationData.createStructOfTimeseries('bus',inputBus);
```

Simulate the model. The Display blocks show the logged value 3 for a and 0 for b.

```
loadOut = sim('ex_load_structtimeseries');
```

Partially Specify Bus Data with a Cell Array of Timeseries Data

When you have `timeseries` data, you can use `Simulink.SimulationData.createStructOfTimeseries` to partially specify simulation input for a bus using a cell array of the `timeseries` data. Load the `timeseries` data for signal d in bus2 as part of a partial bus specification for the Inport block in the `ex_load_structtimeseries` model. The `PreLoadFcn` callback for the `ex_load_structtimeseries` model defines the `Simulink.Bus` object, `bus`, that defines the data type for the Inport block.

```
d = logout.get(2).Values.d;

inputBus = Simulink.SimulationData.createStructOfTimeseries('bus',...
    {d, []});
```

Simulate the model. The Display block for signal a in the `ex_load_structtimeseries` model shows the data logged in signal d from the `ex_log_structtimeseries` model. The Display block for signal b shows 0.

```
loadOut = sim('ex_load_structtimeseries');
```

Load Simulation Input Data for an Array of Buses

This example shows how to use the `Simulink.SimulationData.createStructOfTimeseries` function to generate simulation input for an array of buses. You create `timeseries` data by simulating one model. Then, you create an input structure using the logged data to load into an array of buses in another model.

Create `timeseries` Data

To start, open the `ex_log_structtimeseries` model.

```
open_system('ex_log_structtimeseries')
```

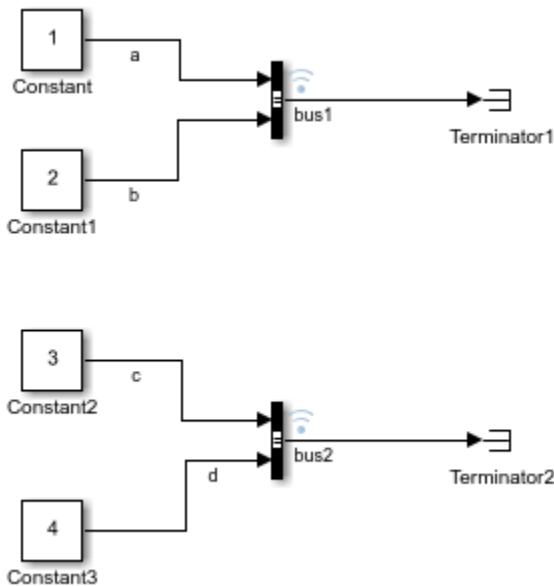

The model creates two buses, bus1 and bus2, using Constant blocks and Bus Creator blocks. The signals are named a, b, c, and d. Create logged bus data by simulating the model.

```
out = sim('ex_log_structtimeseries');
```

The output out contains a Simulink.SimulationData.Dataset object, logouts, with the logged data. You can access the bus1 and bus2 signals using the get function. The data for each signal is in the Simulink.SimulationData.Signal object Values parameter. You can access the bus elements using a dot followed by the signal name. bus1 is the first signal in the Dataset object and contains signals a and b. bus2 contains signals c and d.

```
logouts = out.logouts;
```

```
a = logouts.get(1).Values.a;
b = logouts.get(1).Values.b;
c = logouts.get(2).Values.c;
d = logouts.get(2).Values.d;
```

Loading Model Configuration

Open the model ex_structtimeseries_aob, which uses an array of buses as input.

```
open_system('ex_load_structtimeseries_aob')
```

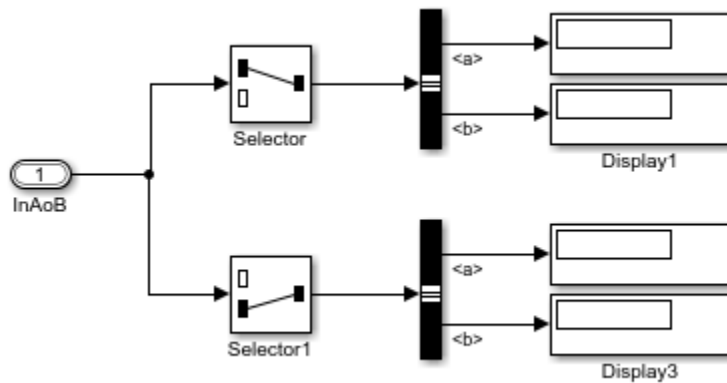

The model uses the InAoB Inport block to load simulation input. Selector blocks select a bus from the array of buses, and Bus Selector blocks select signals to show in the Display blocks.

Double-click the InAoB block and look at the **Signal Attributes** pane of the dialog. The **Data type** for the block is set to **Bus** with the type defined by the Simulink.Bus object, bus. The **Port dimensions** parameter is set to [2 1].

You can see the definition for the Simulink.Bus object, bus, in the **Callbacks** tab in the Model Explorer. This model uses the PreLoadFcn to define the bus object.

Open the Model Configuration Parameters and look at the **Input** parameter. The model uses the variable inputAoB as input.

Create Array of Buses Simulation Input

Use Simulink.SimulationData.createStructOfTimeseries and the data logged in the first section to create a structure to load as simulation input for the array of buses. Specify the dimensions as [2 1] to match the dimensions of the InAoB block.

```
inputAoB = Simulink.SimulationData.createStructOfTimeseries('bus', ...
    {a,b,c,d}, [2 1]);
```

When you simulate the model, the Display blocks show the data for signals a, b, c, and d logged from the ex_log_structtimeseries model. The array of buses contains two buses with signals a and b. Simulink.SimulationData.createStructOfTimeseries renamed signals c and d to match the Simulink.Bus specification used by the array of buses.

```
inputAoB(2)
```

```
ans =
```

```
struct with fields:
```

```
  a: [1x1 timeseries]
  b: [1x1 timeseries]
```

Simulate the model. The display blocks show the logged values.

```
aob_out = sim('ex_load_structtimeseries_aob');
```

Create a Structure of timeseries Objects from a Simulink.TsArray Object

In releases before R2016a, when you log simulation data using ModelDataLogs format, bus data is stored as a Simulink.TSArray object. You cannot log data using ModelDataLogs format using a release after R2016a. In this example, the logged data, log sout, was logged in ModelDataLogs format using a release before R2016a. The variable log sout contains data for a single bus, bus1.

```
log sout
```

```
log sout =
```

```
Simulink.ModelDataLogs (log_modeldatalogs):
  Name           Elements  Simulink Class
  bus1           2        TsArray
```

To load the logged data as simulation input for a bus, create a structure of timeseries objects from the data in bus1.

```
struct_of_ts = ...
Simulink.SimulationData.createStructOfTimeseries(logsout.bus1)

struct_of_ts =

    const1_sig: [1x1 timeseries]
    const2_sig: [1x1 timeseries]
```

Input Arguments

busObj — Name of Simulink.Bus object

character vector

Name of the Simulink.Bus object that specifies the attributes for the data in the output structure of timeseries objects. When you want to load the structure of timeseries objects as simulation input for a bus, the busObj is the bus that defines the data type for the root-level Inport block.

Simulink.SimulationData.createStructOfTimeseries validates the input timeseries attributes including data type and complexity against the Simulink.Bus object specification. When element names do not match between the Simulink.Bus specification and the input timeseries data, Simulink.SimulationData.createStructOfTimeseries renames the timeseries data to match the bus specification. When other attributes do not match, the function returns an error.

Example: 'MyInputBus'

tsStructIn — Structure of timeseries objects

structure of timeseries data

Structure of timeseries data for use in creating the output structure of timeseries objects according to the Simulink.Bus object. The structure must have the same hierarchy as the Simulink.Bus object.

To partially specify data for a bus, use [] in the place of the bus element you want to use ground values.

tsCellArray – Cell array of timeseries objectscell array of `timeseries` objects

Cell array of `timeseries` objects specifying the data for the output structure of `timeseries` objects.

To partially specify data for a bus, use `[]` in the place of the bus element you want to use ground values.

The `Simulink.SimulationData.createStructOfTimeseries` function maps the `timeseries` elements of the cell array to the hierarchy specified by the `Simulink.Bus` object using a depth-first search.

Example: `{ts1,ts2,ts3}`

Example: `{ts1,[],ts3}`

Dependencies

When you specify the `dims` argument, the number of cells in the cell array must match the number of individual signal elements in the `Simulink.Bus` object multiplied by the product of the specified dimensions.

dims – Dimensions for output array

vector

Dimensions for the array of `timeseries` structures, specified as a vector.

When you specify the dimensions as a scalar, `n`, the function creates a 1-by-`n` array.

Example: `[2,1]`

Dependencies

When you specify the `dims` argument, the number of cells in the cell array must match the number of individual signal elements in the `Simulink.Bus` object multiplied by the product of the specified dimensions.

Data Types: `double`

tsArray – Simulink.TsArray object`Simulink.TsArray`

`Simulink.TsArray` object.

In versions prior to R2016a, signal logging creates `Simulink.TsArray` objects to store logged bus data. Use this syntax when you want to use data logged using `ModelDataLogs` format in a version before R2016a to create simulation input for a bus.

Example: `myTsArrayObj`

Output Arguments**tsStruct – Structure of timeseries objects**

struct

Structure of `timeseries` objects with attributes specified by the `Simulink.TsArray` or `Simulink.Bus` input. You can load the structure of `timeseries` objects as simulation input for a bus.

tsStructArray – Array of timeseries structures

array

Array of structures of `timeseries` objects with dimensions specified by the `dims` input.

See Also

`Simulink.Bus` | `Simulink.TsArray` | `timeseries`

Topics

“Load Data to Root-Level Input Ports”

“Load Bus Data to Root-Level Input Ports”

Introduced in R2013a

getAsDatastore

Class: Simulink.SimulationData.DatasetRef

Package: Simulink.SimulationData

Get matlab.io.datastore.SimulationDatastore representation of element from referenced Dataset object

Syntax

```
element =  
Simulink.SimulationData.DatasetRef.getAsDatastore(datasetref_elements)
```

Description

element =
Simulink.SimulationData.DatasetRef.getAsDatastore(datasetref_elements) returns a matlab.io.datastore.SimulationDatastore representation of an element or collection of elements from the referenced dataset, based on index, name, or block path of the element.

You can represent a Dataset element as a matlab.io.datastore.SimulationDatastore object if the element was placed into the MAT-file using either of these approaches:

- Log Dataset format data to persistent storage (MAT-file).
- Place the element into a Simulink.SimulationData.Dataset object and saved the Dataset object to a v7.3 MAT-file.

The SimulationDatastore representation for a Dataset element creates a SimulationDatastore object for the Values field of that element. The SimulationDatastore representation supports streaming of the data for the Values property of the element into other simulations or into MATLAB.

Note You cannot use create a SimulationDatastore for Dataset elements that contain these types of data:

- Array
-

You can use SimulationDatastore objects to:

- Refer to logged simulation data that is stored on disk in a MAT-file.
- Specify signals to stream incrementally from disk to a simulation.
- Provide a basis for big data analysis using MATLAB functions.

Input Arguments

datasetref_element — Element of referenced dataset in MAT-file
index of the element

Element of a referenced dataset in a MAT-file, specified as an index, name (as a character vector), or block path (as a character vector).

Output Arguments

element — Element accessed using SimulationDatastore object

matlab.io.datastore.SimulationDatastore object | Simulink.SimulationData.Signal, Simulink.SimulationData.State or similar object, whose Values data uses a matlab.io.datastore.SimulationDatastore object

Element accessed using SimulationDatastore object, returned as either a matlab.io.datastore.SimulationDatastore object or a Simulink.Signal, Simulink.State, or similar object, whose Values data uses a matlab.io.datastore.SimulationDatastore object.

Examples

Use a SimulationDatastore to Reference a Signal's Data in a DatasetRef

Log signal data to persistent storage (select the **Log Dataset data to file** configuration parameter) and simulate a model.

Create a DatasetRef for the signal logging Dataset data (logout) in the out.mat MAT-file.

```
sigLogRef = Simulink.SimulationData.DatasetRef('out.mat', 'logout');
firstSig = sigLogRef.getAsDatastore(1)
```

```
firstSig =
```

```
Simulink.SimulationData.Signal
Package: Simulink.SimulationData

Properties:
    Name: 'x1'
    PropagatedName: ''
    BlockPath: [1x1 Simulink.SimulationData.BlockPath]
    PortType: 'output'
    PortIndex: 1
    Values: [1x1 matlab.io.datastore.SimulationDatastore]
```

Load the data into another model. This approach streams the values of the signal x1 for another simulation.

```
ds = Simulink.SimulationData.Dataset;
ds{1} = sigLogRef{1};
sim('other_model', 'ExternalInput', 'ds');
```

Alternative

To streamline the use of indexing, you can use curly braces ({}) syntax to obtain a SimulationDatastore object for DatasetRef object signal values. The requirements and results are the same as using getAsDatastore. For example, if you log signal data to persistent storage (select the **Log Dataset data to file** configuration parameter) and simulate a model.

```
sigLogRef = Simulink.SimulationData.DatasetRef('out.mat','logsout');  
firstSig = sigLogRef{1}
```

```
ans =
```

```
Simulink.SimulationData.Signal  
Package: Simulink.SimulationData
```

```
Properties:
```

```
    Name: 'x1'  
PropagatedName: ''  
    BlockPath: [1x1 Simulink.SimulationData.BlockPath]  
    PortType: 'outport'  
    PortIndex: 1  
    Values: [1x1 matlab.io.datastore.SimulationDatastore]
```

See Also

[Simulink.SimulationData.DatasetRef](#) | [matlab.io.datastore.SimulationDatastore](#) | [Simulink.SimulationData.Dataset](#)

Topics

“Load Big Data for Simulations”

Introduced in R2017a

Simulink.SimulationData.DatasetRef.getDatasetVariableNames

List names of Dataset variables in MAT-file

Syntax

```
varNames = Simulink.SimulationData.DatasetRef.getDatasetVariableNames(  
matFile)
```

Description

`varNames = Simulink.SimulationData.DatasetRef.getDatasetVariableNames(matFile)` lists the names of variables for Dataset data in a MAT-file.

Examples

List Variable Names in MAT-File

Suppose that you simulate a model using the default variable names for signal logging data and states data. You enable the **Configuration Parameters > Data Import/Export > Log Dataset data to file** and use the default MAT-file name of `out.mat`.

List the variable names in the MAT-file.

```
varNames = Simulink.SimulationData.DatasetRef.getDatasetVariableNames('out.mat')  
  
varNames =  
  
    'xout'    'logout'
```

Tips

To get the names of Dataset variables in the MAT-file, using the `Simulink.SimulationData.DatasetRef.getDatasetVariableNames` function processes faster than using the `who`, or `whos` functions.

Input Arguments

matFile — MAT-file that contains Dataset variables

character vector

MAT-file that contains Dataset variables, specified as a character vector. The character vector specifies the path to the MAT-file.

Output Arguments

varNames — Names of Dataset variables in MAT-file

cell array

Names of Dataset variables in MAT-file, returned as a cell array.

See Also

[Simulink.SimulationData.DatasetRef](#) | [Simulink.SimulationData.Dataset](#)

Topics

[“Log Data to Persistent Storage”](#)

[“Load Big Data for Simulations”](#)

Introduced in R2016a

Simulink.SimulationData.forEachTimeseries

Call function on each timeseries object

Syntax

```
dataResults = Simulink.SimulationData.forEachTimeseries(functionHandle,
inputData)
```

Description

`dataResults = Simulink.SimulationData.forEachTimeseries(functionHandle, inputData)` runs the specified function handle on all MATLAB timeseries objects contained in `inputData`.

Examples

Find Minimum for Logged Bus Signal Data

This example shows how to use the `forEachTimeseries` function to run the `min` function on each timeseries object in the logged data for the `COUNTERBUS` signal.

Open the model and simulate it.

```
open_system('sldemo_mdref_bus')
sim('sldemo_mdref_bus');
```

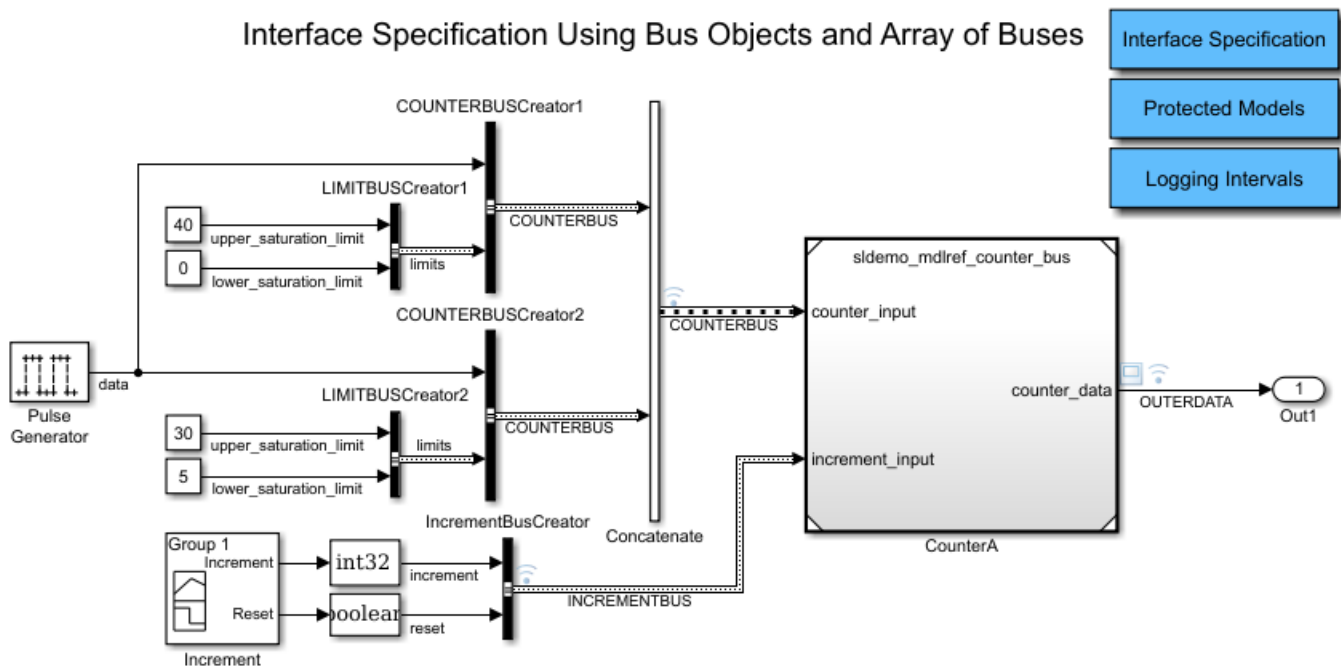

Access the signal logging data. For this model, that data is stored in the `topOut` variable.

```
topOut
```

```
Simulink.SimulationData.Dataset 'topOut' with 4 elements
```

| | Name | BlockPath |
|----------------|--------------|---|
| 1 [1x1 Signal] | COUNTERBUS | sldemo_mdref_bus/Concatenate |
| 2 [1x1 Signal] | OUTERDATA | sldemo_mdref_bus/CounterA |
| 3 [1x1 Signal] | INCREMENTBUS | sldemo_mdref_bus/IncrementBusCreator |
| 4 [1x1 Signal] | INNERDATA | ...erA\sldemo_mdref_counter_bus/COUNTER |

- Use braces `{ }` to access, modify, or add elements using index.

Find the values for the COUNTERBUS element.

```
counterbusData = topOut{1}.Values
```

```
counterbusData =
```

```
2x1 struct array with fields:
```

```
data
limits
```

Run the `min` function on the counterbus data.

```
ret = Simulink.SimulationData.forEachTimeseries(@min,counterbusData)
```

```
ret =
```

```
2x1 struct array with fields:
```

```
data
limits
```

Explore the returned data.

```
ret(1)
```

```
ans =
```

```
data: 0
limits: [1x1 struct]
```

```
ret(2).limits
```

```
ans =
```

```
upper_saturation_limit: 40
lower_saturation_limit: 0
```

Input Arguments

functionHandle — Function to run on MATLAB timeseries objects

function handle

Function to run on `timeseries` objects, specified as a function handle. For information about specifying function handles, see “Pass Function to Another Function”.

The function that you use with `forEachTimeseries`:

- Can be either a built-in function or a user-specified function
- Must return a scalar

If the function that you use with `forEachTimeseries` takes:

- One argument, specify the function handle and the input data. For example:

```
ret = Simulink.SimulationData.forEachTimeseries(@min,data);
```

- More than one argument, specify the function handle as `@(x)` and then specify the function, using `x` as the first argument. For remaining arguments, specify values. For example, this command runs the `resample` function on MATLAB timeseries objects in `data`, for the time vector `[2.5 3]`.

```
ret = Simulink.SimulationData.forEachTimeseries(@(x)...  
(resample(x,[2.5 3])),data);
```

inputData — Data to run specified function on

MATLAB timeseries object | array of timeseries | structure with timeseries at leaf nodes | array of structures with timeseries at leaf nodes

Data to run specified function on, specified as timeseries data.

Output Arguments

dataResults — Data resulting from running specified function

MATLAB timeseries object | array of timeseries | structure with timeseries at leaf nodes | array of structures with timeseries at leaf nodes

Data resulting from running specified function, returned using the format and hierarchy of the input data.

Related Links

MATLAB timeseries“Function Handles”

Introduced in R2016b

Simulink.SimulationData.signalLoggingSelector

Open Signal Logging Selector

Syntax

```
Simulink.SimulationData.signalLoggingSelector(modelName)
```

Description

`Simulink.SimulationData.signalLoggingSelector(modelName)` opens the Signal Logging Selector dialog box for the model that you specify with `modelName`.

Input Arguments

`modelName`

Character vector that specifies the name of the model for which you want to open the Signal Logging Selector dialog box.

Example

Open the Signal Logging Selector dialog box for the `sldemo_mdref_bus.mdl`.

```
Simulink.SimulationData.signalLoggingSelector('sldemo_mdref_bus')
```

See Also

`Simulink.SimulationData.Dataset`

Topics

“Override Signal Logging Settings”

Introduced in R2011a

setName

Class: Simulink.SimulationData.Unit

Package: Simulink.SimulationData

Specify name of logging data units

Syntax

```
unitObject = setName(unitObj,unitName)
```

Description

`unitObject = setName(unitObj,unitName)` sets the name for the `Simulink.SimulationData.Unit` object to the name specified in `unitName`.

Input Arguments

unitObj — Logging data unit object to name

`Simulink.SimulationData.Unit` object

Logging data unit object to name, specified as a `Simulink.SimulationData.Unit` object.

unitName — Name of logging data unit

character vector

Name of logging data unit, specified as a character vector.

Output Arguments

name — Name of logging data units

character vector

Name of logging data units, returned as a character vector.

Examples

Name a Logging Data Unit Object

```
inchesUnit = Simulink.SimulationData.Unit('in');  
inchesUnit = setName(inchesUnit,'inches')
```

```
inchesUnit =
```

```
    Units with properties:
```

Name: 'inches'

See Also

`Simulink.SimulationData.Unit`

Topics

“Log Signal Data That Uses Units”

“Convert Logged Data to Dataset Format”

“Prepare Model Inputs and Outputs”

Introduced in R2011a

Simulink.SimulationData.updateDatasetFormatLogging

Convert model and its referenced models to use `Dataset` format for signal logging

Syntax

```
Simulink.SimulationData.updateDatasetFormatLogging(top_model)
Simulink.SimulationData.updateDatasetFormatLogging(top_model, variants)
```

Description

Note The `ModelDataLogs` class is supported for backwards compatibility. Starting in R2016a, you cannot log data in the `ModelDataLogs` format. Signal logging uses the `Dataset` format. In R2016a or later, when you open a model from an earlier release that had used `ModelDataLogs` format, the model simulated in use `Dataset` format. You do not need to use this command to update the signal logging format for a model that uses model referencing. Opening the model in R2016a or later uses `Dataset` format for all signal logging.

You can convert signal logging data from `ModelDataLogs` to `Dataset` format. Converting to `Dataset` format makes it easier to post-process with other logged data (for example, logged states), which can also use `Dataset` format. For more information, see “Convert Logged Data to Dataset Format”.

If you have legacy code that uses the `ModelDataLogs` API, you can encounter situations that require updates to your code or model. See “Migrate Scripts That Use Legacy `ModelDataLogs` API”.

`Simulink.SimulationData.updateDatasetFormatLogging(top_model)` converts the top-level model and all of its referenced models to use the `Dataset` format for signal logging instead of the `ModelDataLogs` format. You can convert signal logging data from `ModelDataLogs` to `Dataset` format. Converting to `Dataset` format makes it easier to post-process with other logged data (for example, logged states), which can also use `Dataset` format. For more information, see “Convert Logged Data to Dataset Format”.

If a `Model` block has the **Generate preprocessor conditionals** option selected, the function converts all the variants; otherwise, the function converts only the active variant.

`Simulink.SimulationData.updateDatasetFormatLogging(top_model, variants)` specifies which variant models to convert to use the `Dataset` signal logging format. For details about the `variants` argument, see “Input Arguments” on page 2-1136

Input Arguments

`top_model`

Character vector that specifies the name of the top-level model.

variants

Character vector that specifies which variant models to update:

- 'ActivePlusCodeVariants' — (Default) Search all variants if any generate preprocessor conditionals. Otherwise, search only the active variant.
- 'ActiveVariants' — Convert only the active variant.
- 'AllVariants' — Convert all variants.

More About

Dataset

The *Dataset* format causes Simulink to use a `Simulink.SimulationData.Dataset` object to store the logged signal data. The *Dataset* format use MATLAB timeseries objects to formatting the data.

ModelDataLogs

The *ModelDataLogs* format causes Simulink to use a `Simulink.ModelDataLogs` object to store the logged signal data. `Simulink.Timeseries` and `Simulink.TsArray` objects provide the format for the data.

Tips

- The conversion function sets the `SignalLoggingSaveFormat` parameter value to `Dataset` for all the updated models.
- If you want to save the format updates that the conversion function makes, then ensure that the top-level model, referenced models, and variant models are accessible and writable.
- If a model has no other unsaved changes, the conversion function saves the format updates to the model. If the model has unsaved changes, the function updates the format, but does not save those changes.
- If you use this function for a model that does not include any referenced models, the function converts the top-level model use the *Dataset* format.

See Also

`Simulink.SimulationData.Dataset` | `Simulink.ModelDataLogs` | `Simulink.ModelDataLogs.convertToDataset`

Topics

“Migrate Scripts That Use Legacy ModelDataLogs API”

Introduced in R2011a

find

Access and display values of simulation results

Syntax

```
output = find(simout, 'VarName')  
output = simOut.find('VarName')
```

Description

`output = find(simout, 'VarName')` finds the `VarName` in `Simulink.SimulationOutput`. Specify `VarName` in single quotes.

`output = simOut.find('VarName')` is a syntax with dot notation for the `find` method.

Input Arguments

simout — Simulation output

object

Simulation output to find `VarName` in.

VarName — Name of the Variable

character vector

Name of logged variable for which you seek values.

Output Arguments

Value

Value of the logged variable name specified in input.

Examples

Simulate `vdp` and store the values of the variable `youtNew` in `yout`.

```
simOut = sim('vdp', 'SaveState', 'on', 'StateSaveName', 'xoutNew', ...  
            'SaveOutput', 'on', 'OutputSaveName', 'youtNew');  
yout = simOut.find('youtNew')
```

See Also

`get` | `who` | `Simulink.SimulationOutput`

get

Access and display values of simulation results

Syntax

```
output = get(simOut, 'VarName')
output = simOut.get('VarName')
```

Description

`output = get(simOut, 'VarName')` accepts one variable name. Specify *VarName* inside single quotes.

`output = simOut.get('VarName')` is a syntax with dot notation to accept one variable name.

Tip A simpler alternative to using the `get` function is to use dot notation. For example, to access data for the `xout` output variable, you can use this command:

```
simOut.xout
```

Input Arguments

simout — Simulation object to get metadata from

object

Simulation object to get metadata from, specified as a `SimulationOutput` object.

VarName — Name of the Variable

character vector

Name of logged variable for which you seek values.

Output Arguments

Value

Value of the logged variable name specified in input.

Examples

Simulate `vdp` and store the values of the variable `youtNew` in `yout`.

```
simOut = sim('vdp',...
    'SaveState','on','StateSaveName','xoutNew',...
    'SaveOutput','on','OutputSaveName','youtNew');
yout = simOut.get('youtNew')
```

Alternatives

A simpler alternative is to use dot notation. For example, to access data for the `xout` output variable, you can use this command:

```
simOut.xout
```

Another alternative is to use `Simulink.SimulationOutput.who` and then `Simulink.SimulationOutput.find`.

See Also

[find](#) | [who](#)

getSimulationMetadata

Return SimulationMetadata object for simulation

Syntax

```
mData = getSimulationMetadata(simout)
mData = simout.getSimulationMetadata()
```

Description

`mData = getSimulationMetadata(simout)` retrieves metadata information in a SimulationMetadata object from Simulink.SimulationOutput object.

`mData = simout.getSimulationMetadata()` is a syntax with dot notation to retrieve metadata information in a SimulationMetadata object.

Input Arguments

simout — Simulation object to get metadata from
object

Simulation output to get metadata from.

Output Arguments

mData — Simulink.SimulationMetadata object stored in the simout SimulationOutput object
object

SimulationMetadata object stored in the simout SimulationOutput object.

Examples

Retrieve Metadata From vdp Simulation

Simulate the vdp model and retrieve metadata information from the simulation.

Simulate the vdp model. Save the results of the Simulink.SimulationOutput object in simout

```
open_system('vdp')
simout = sim(bdroot,'ReturnWorkspaceOutputs','on');
```

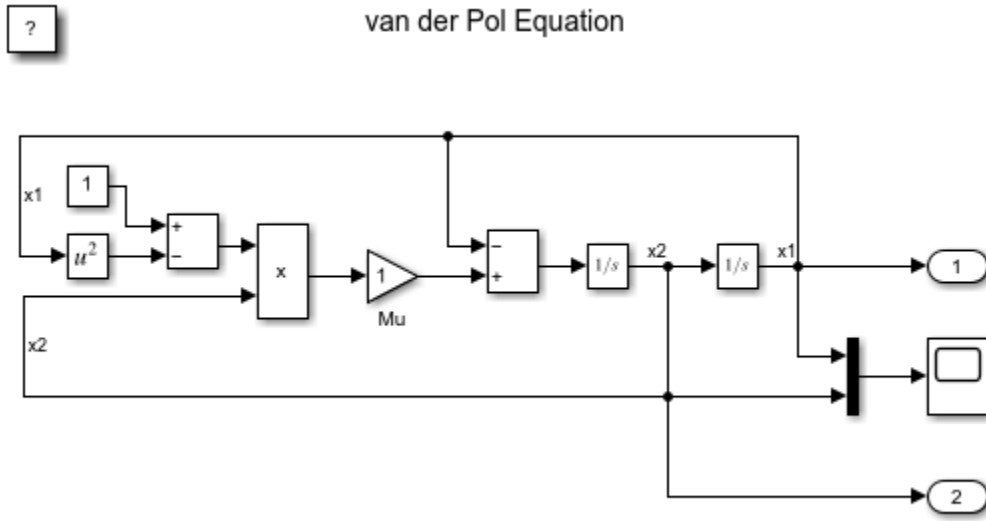

Copyright 2004-2020 The MathWorks, Inc.

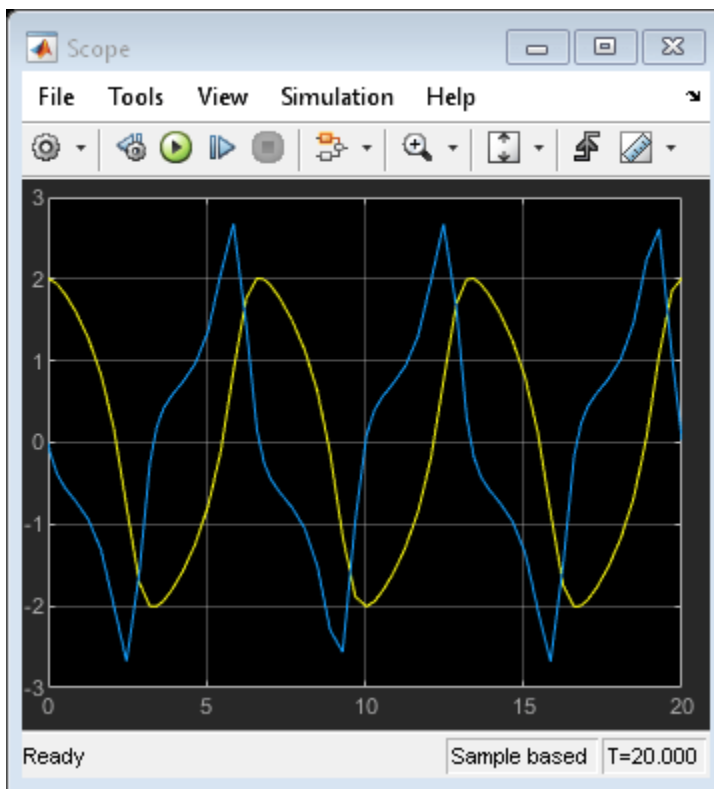

Retrieve metadata information about this simulation using mData.

```
mData=simout.getSimulationMetadata()
```

```
mData =
```

```
SimulationMetadata with properties:
```



```
ModelInfo: [1x1 struct]
TimingInfo: [1x1 struct]
ExecutionInfo: [1x1 struct]
UserString: ''
UserData: []
```

Alternatives

A simpler alternative to use dot notation with the `SimulationMetadata` property. For example:

```
simOut.SimulationMetadata.ModelInfo
```

Another alternative is to display simulation metadata in the Variable Editor using one of these approaches:

- Select the **Show Simulation Metadata** check box (which displays the data in a tree structure).
- Double-click the **SimulationMetadata** row.
- View the `SimulationMetadata` object.

See Also

`Simulink.SimulationMetadata` | `setUserData` | `setUserString` |
`Simulink.SimulationOutput`

setUserData

Store custom data in SimulationMetadata object that SimulationOutput object contains

Syntax

```
simoutNew = setUserData(simout,CustomData)
simoutNew = simout.setUserData(CustomData)
```

Description

`simoutNew = setUserData(simout,CustomData)` assigns a copy of `Simulink.SimulationOutput` to `simoutNew`. The copy contains `CustomData` in its `SimulationMetadata` object.

`simoutNew = simout.setUserData(CustomData)` is a syntax with dot notation to assign the modified copy of `Simulink.SimulationOutput` to `simoutNew`.

Input Arguments

simout — Simulation Output

object

Simulation output in which to modify custom data

CustomData — Data to store in a metadata object

data

Any custom data you want to store in the metadata object.

Output Arguments

simoutNew — Simulation object that stores metadata object with custom data

object

A copy of the `simout` `SimulationOutput` object that contains `CustomData` in its `SimulationMetadata` object, returned as an object.

Examples

Store Data in SimulationMetadata Object of vdp Simulation

Simulate the `vdp` model. Store custom data in the `SimulationMetadata` object that the `SimulationOutput` object contains.

Simulate the `vdp` model. Save the results of the `Simulink.SimulationOutput` object in `simout`.

```
open_system('vdp')
simout=sim(bdroot,'ReturnWorkspaceOutputs','on');
```

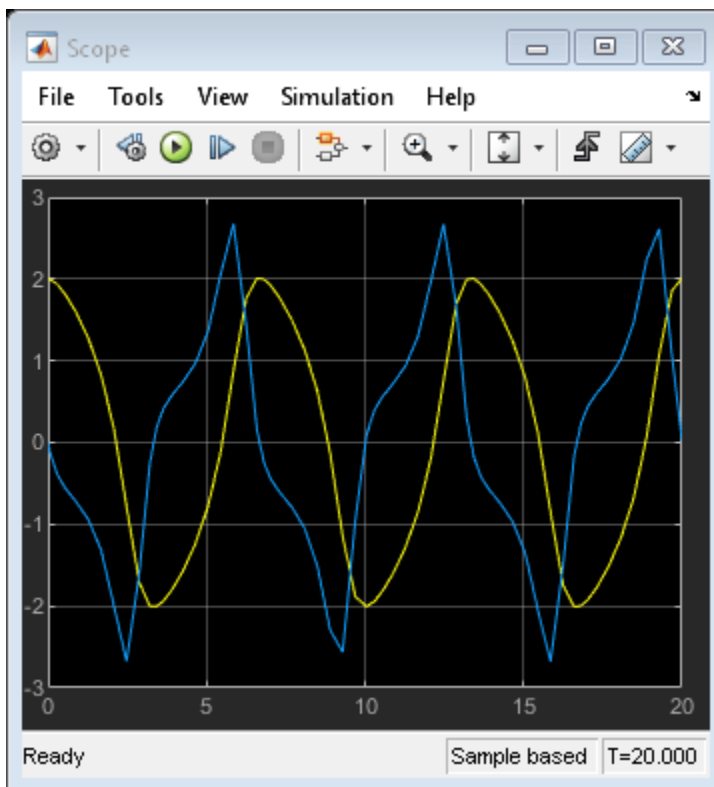
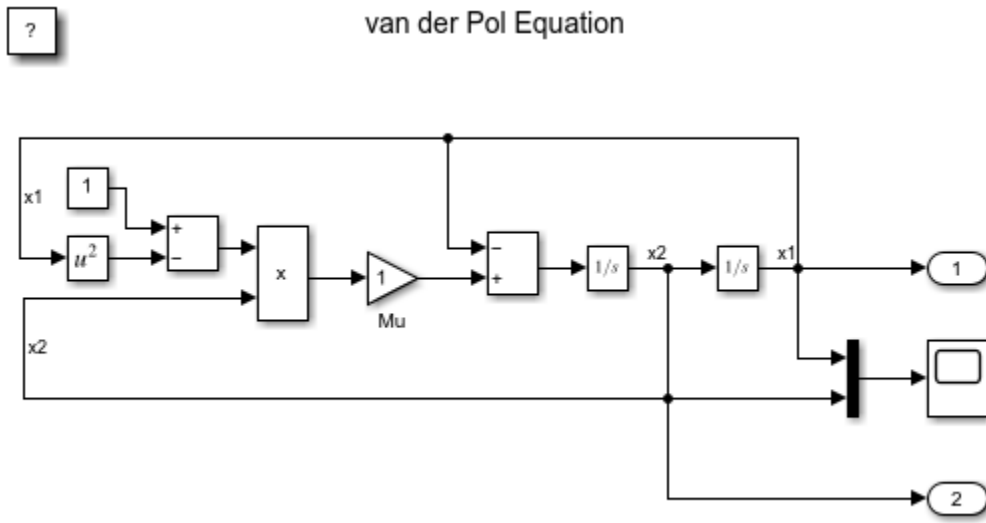

Store custom data about the simulation in the SimulationMetadata object that simout contains.

```
simout=simout.setUserData(struct('param1','value1','param2','value2','param3','value3'));
```

Use SimulationOutput.getSimulationMetadata to retrieve the information you stored.

```
mData=simout.getSimulationMetadata();
disp(mData.UserData)
```

```
param1: 'value1'  
param2: 'value2'  
param3: 'value3'
```

See Also

`Simulink.SimulationMetadata` | `getSimulationMetadata` | `setUserString` |
`Simulink.SimulationOutput`

setUserString

Store custom character vector in SimulationMetadata object in SimulationOutput object

Syntax

```
simoutNew = setUserString(simout, CustomString)
simoutNew = simout.setUserString(CustomString)
```

Description

`simoutNew = setUserString(simout, CustomString)` assigns a copy of `Simulink.SimulationOutput` to `simoutNew`. The copy contains `CustomString` in its `SimulationMetadata` object.

`simoutNew = simout.setUserString(CustomString)` is a syntax with dot notation to assign the modified copy of `Simulink.SimulationOutput` to `simoutNew`.

Input Arguments

simout — Simulation Output
object

Simulation output in which to set custom string.

CustomString — Character vector to store in a metadata object
character vector or a string

Any custom character vector you want to store in the metadata object.

Output Arguments

simoutNew — Simulation object that stores metadata object with custom character vector
object

A copy of the `simout` `SimulationOutput` object that contains `CustomString` in its `SimulationMetadata` object, returned as an object.

Examples

Store a Character Vector in SimulationMetadata Object of vdp Simulation

Simulate the `vdp` model. Store a custom character vector in the `SimulationMetadata` object that the `SimulationOutput` object contains.

Simulate the `vdp` model. Save the results of the `Simulink.SimulationOutput` object in `simout`.

```
open_system('vdp')
simout=sim(bdroot,'ReturnWorkspaceOutputs','on');
```

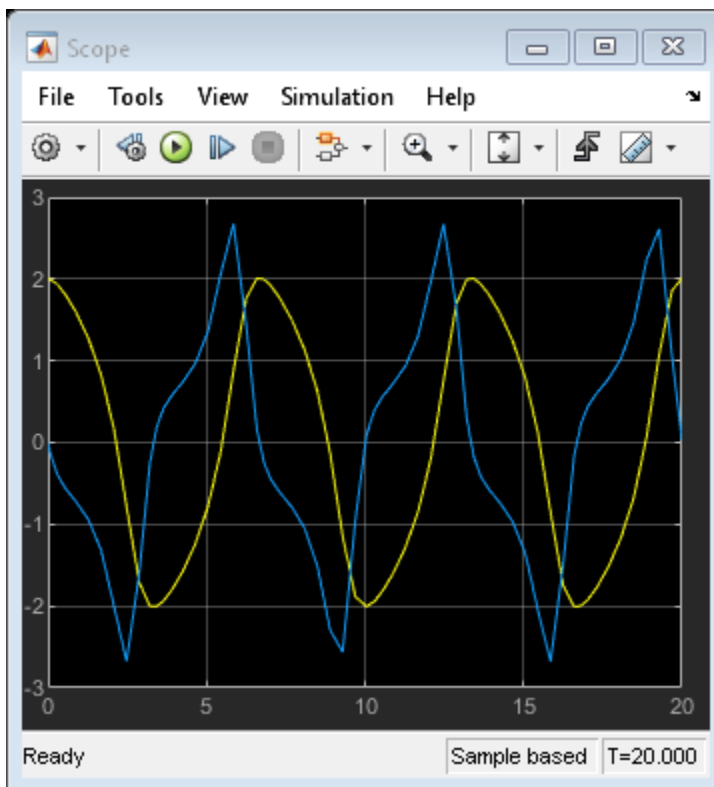
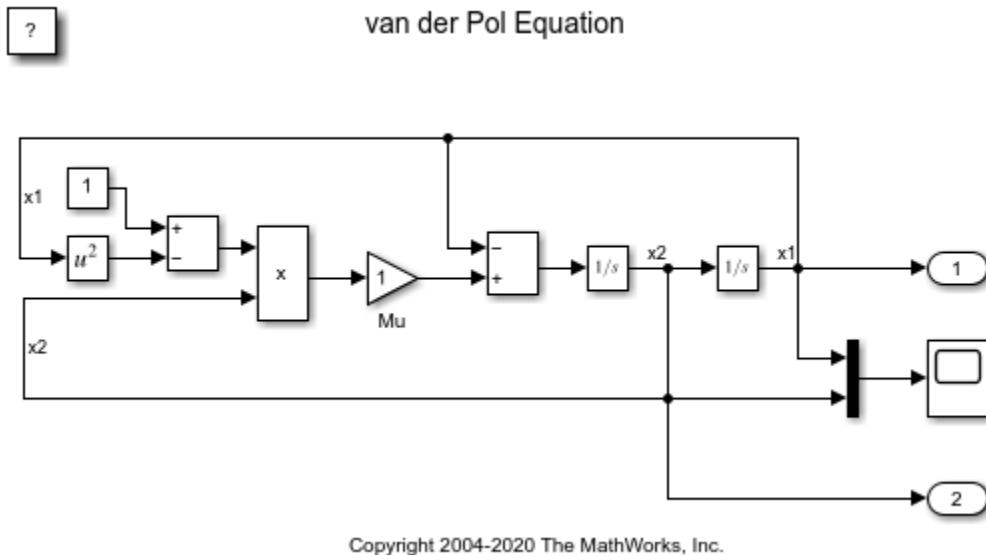

Store a character vector to describe the simulation.

```
simout=simout.setUserString('First Simulation');
```

Use `SimulationOutput.getSimulationMetadata` to retrieve the information you stored.

```
mData=simout.getSimulationMetadata();
disp(mData.UserString)
```

First Simulation

See Also

Simulink.SimulationMetadata | getSimulationMetadata | setUserData |
Simulink.SimulationOutput

who

Access and display output variable names of simulation

Syntax

```
simOutVar = who(simOut)  
simOutVar = simOut.who
```

Description

simOutVar = who(simOut) returns the names of all simulation output variables, including workspace variables.

simOutVar = simOut.who is a syntax with dot notation to return the names of all simulation output variables, including workspace variables.

Input Arguments

simout — Simulation object to get metadata from
object

Simulation output to get metadata from.

Output Arguments

simOutVar

Character vector array of output variable names of simulation.

Examples

Simulate vdp and store the character vector values of the output variable names.

```
simOut = sim('vdp','SaveState','on','StateSaveName','xoutNew',...  
            'SaveOutput','on','OutputSaveName','youtNew');  
simOutVar = simOut.who
```

See Also

find | get | Simulink.SimulationOutput

Simulink.SubSystem.convertToModelReference

Convert subsystem to model reference

Syntax

```
Simulink.SubSystem.convertToModelReference(gcf,'UseConversionAdvisor',true)
```

```
[tf,h] = Simulink.SubSystem.convertToModelReference(subsys,model)
```

```
[tf,h] = Simulink.SubSystem.convertToModelReference(subsys,model,Name,Value)
```

Description

`Simulink.SubSystem.convertToModelReference(gcf,'UseConversionAdvisor',true)` opens the **Model Reference Conversion Advisor** for the selected Subsystem block.

`[tf,h] = Simulink.SubSystem.convertToModelReference(subsys,model)` converts the specified subsystems to referenced models.

For each subsystem that the function converts, it:

- Creates a model.
- Copies the contents of the subsystem into the new model.
- Updates any root-level input and output blocks and the configuration parameters of the model to match the compiled attributes of the original subsystem.
- Copies the contents of the model workspace of the original model to the new model.

Before you use this function, load the model containing the subsystem.

`[tf,h] = Simulink.SubSystem.convertToModelReference(subsys,model,Name,Value)` specifies options using one or more name-value pair arguments.

Examples

Open the Model Reference Conversion Advisor

Open the f14 model.

```
open_system('f14');
```

In the f14 model, select the Controller subsystem output signal and click **Log Signals**.

In the Simulink Editor, select the Controller subsystem. Open the **Model Reference Conversion Advisor** from the command window.

```
Simulink.SubSystem.convertToModelReference(gcf,'UseConversionAdvisor',true);
```

Perform the conversion using the advisor.

Programmatically Convert Subsystem to Referenced Model

Convert the Bus Counter subsystem to a referenced model named `bus_counter_ref_model`.

```
open_system('sldemo_mdref_conversion');
Simulink.SubSystem.convertToModelReference(...
    'sldemo_mdref_conversion/Bus Counter', ...
    'bus_counter_ref_model', ...
    'AutoFix',true,...
    'ReplaceSubsystem',true,...
    'CheckSimulationResults',true);
```

Successfully converted Subsystem block to Model block.

Conversion to Model Reference Example

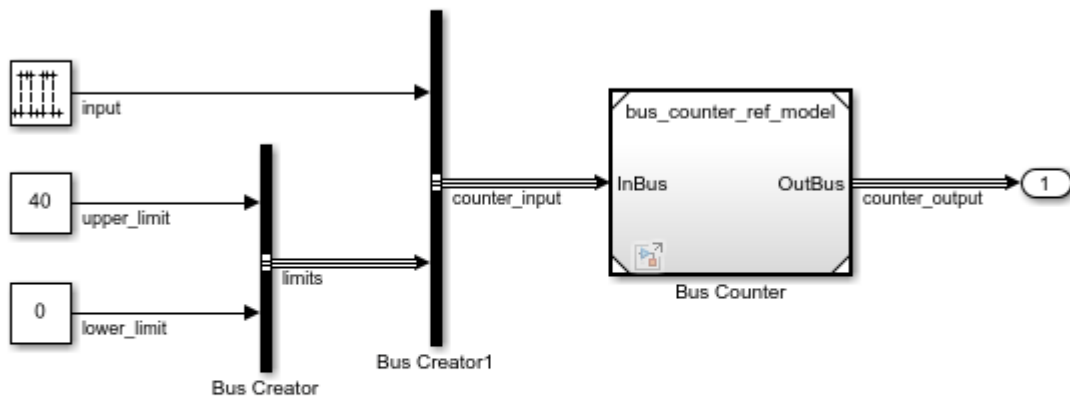

Double-click here to convert the Bus Counter subsystem to a referenced model.

Copyright 1990-2020 The MathWorks, Inc.

Convert Multiple Subsystems to Referenced Models

Convert the two subsystems with one command.

```
open_system('f14');
set_param(gcs,'SaveOutput','on','SaveFormat','Dataset');
set_param(gcs,'SignalResolutionControl','UseLocalSettings');
Simulink.SubSystem.convertToModelReference(...
    {'f14/Controller','f14/Aircraft Dynamics Model'},...
    {'controller_ref_model','aircraft_dynamics_ref_model'},...
    'ReplaceSubsystem',true,...
```

```
'AutoFix',true,...
'CheckSimulationResults',true)
```

Input Arguments

subsys — Subsystem names or handles

numeric array | character vector | cell array of character vectors | string array

Subsystem names or handles, specified as a numeric array, character vector, cell array of character vectors, or string array.

For information on which subsystems you can convert, see “Conditionally Execute Referenced Models”.

Data Types: double | char | string

model — Referenced model names

character vector | cell array of character vectors | string array

Referenced model names, specified as a character vector, cell array of character vectors, or string array. Each model name must be 59 characters or less.

If you specify multiple subsystems to convert, specify the same number of referenced model names. Each model name corresponds to the specified subsystem, in the same order.

Data Types: char | string

Name-Value Pair Arguments

Specify optional comma-separated pairs of **Name**, **Value** arguments. **Name** is the argument name and **Value** is the corresponding value. **Name** must appear inside quotes. You can specify several name and value pair arguments in any order as **Name1**, **Value1**, ..., **NameN**, **ValueN**.

Example: `Simulink.SubSystem.convertToModelReference...
(engineSubsys,engineModelRef,'ReplaceSubsystem',true)`

AutoFix — Option to fix all conversion issues that can be fixed automatically

false (default) | true

Option to fix all conversion issues that can be fixed automatically, specified as the comma-separated pair consisting of 'AutoFix' and true or false.

If you set **AutoFix** to true, the function fixes all conversion issues that it can fix. For issues that the function cannot fix, the conversion process generates error messages that you address by modifying the model.

Note If you set **Force** to true, then the function does not automatically fix conversion issues.

Data Types: logical

Force — Option to complete conversion even with errors

false (default) | true

Option to complete conversion even with errors, specified as the comma-separated pair consisting of 'Force' and true or false.

If `true`, the function returns conversion errors as warnings and continues with the conversion without fixing the errors, even if you set `AutoFix` to `true`. The `Force` option allows you to use the function to do the initial steps of the conversion and then complete the conversion process yourself.

Data Types: `logical`

CopyCodeMappings — Option to copy code mappings from parent model to new, converted model

`false` (default) | `true`

Option to copy code mappings from parent model to the new, converted model, specified as the comma-separated pair consisting of `'CopyCodeMappings'` and `true` or `false`.

If `true`, the function copies the existing code mapping configurations from the parent model to the new, converted referenced model.

If `false`, the function does not copy the existing code mapping configurations from the parent model to the new, converted model.

Data Types: `logical`

CheckSimulationResults — Option to check simulation results before and after conversion

`false` (default) | `true`

Option to check simulation results before and after conversion, specified as the comma-separated pair consisting of `'CheckSimulationResults'` and `true` or `false`.

Before performing the conversion:

- Enable signal logging for the subsystem output signals of interest in the model.
- Set `CheckSimulationResults` to `true`.
- Set `AbsoluteTolerance`.
- Set `RelativeTolerance`.
- Set `SimulationModes` to the simulation mode used by the original model.

If the difference between simulation results exceeds the tolerance level, the function displays a message.

Data Types: `logical`

AbsoluteTolerance — Absolute signal tolerance for comparison

`1e-06` (default) | numeric scalar

Absolute signal tolerance for comparison, specified as the comma-separated pair consisting of `'AbsoluteTolerance'` and a numeric scalar.

Use this option only if you set `CheckSimulationResults` to `true`.

Data Types: `double`

RelativeTolerance — Relative signal tolerance for comparison

`1e-06` (default) | numeric scalar

Relative signal tolerance for comparison, specified as the comma-separated pair consisting of `'RelativeTolerance'` and a numeric scalar.

Use this option only if you set `CheckSimulationResults` to `true`.

Data Types: `double`

DataFileName — Name of file for storing conversion data

character vector

Name of file for storing conversion data, specified as the comma-separated pair consisting of `'DataFileName'` and a character vector. You can specify an absolute or relative path.

You can save the conversion data in a MAT-file (default) or a MATLAB file. If you use a `.m` file extension, the function serializes all variables to a MATLAB file.

By default, the function uses a file name consisting of the model name plus `_conversion_data.mat`.

Data Types: `char`

ReplaceSubsystem — Option to replace Subsystem blocks with Model blocks

`false` (default) | `true`

Option to replace Subsystem blocks with Model blocks, specified as the comma-separated pair consisting of `'ReplaceSubsystem'` and `true` or `false`.

If you set the value to `true`, consider making a backup of the original model before you convert the subsystems. If you want to undo the conversion, having a backup makes it easier to restore the model.

If you set `ReplaceSubsystem` to `true`, the conversion action depends on whether you use the automatic fix options.

- If you use the automatic fixes, then the conversion replaces the Subsystem block with a Model block unless the automatic fixes change the input or output ports. If the ports change, then the conversion includes the contents of the subsystem in a Model block that is inserted in the Subsystem block.
- If you do not use the automatic fixes, then the conversion replaces the Subsystem block with a Model block.

Data Types: `logical`

CreateWrapperSubsystem — Option to insert wrapper subsystem to preserve model layout

`false` (default) | `true`

Option to insert wrapper subsystem to preserve model layout, specified as the comma-separated pair consisting of `'CreateWrapperSubsystem'` and `true` or `false`.

When you convert a subsystem to a referenced model, you can have the conversion process insert a wrapper subsystem to preserve the layout of a model. The subsystem wrapper contains the Model block from the conversion.

The conversion creates a wrapper subsystem automatically if the conversion modifies the Model block interface by adding ports.

Data Types: `logical`

SimulationModes — Simulation mode for Model blocks

`'Normal'` (default) | `'Accelerator'`

Simulation mode for Model blocks, specified as the comma-separated pair consisting of 'SimulationModes' and 'Normal' or 'Accelerator'. The simulation mode setting applies to the Model blocks that reference the models that the conversion creates.

Data Types: char

BuildTarget — Model reference targets to generate

'Sim' | 'Coder'

Model reference targets to generate, specified as the comma-separated pair consisting of 'BuildTarget' and 'Sim' or 'Coder'.

- 'Sim' — Model reference simulation target
- 'Coder' — Code generation target

Data Types: char

Output Arguments

tf — True or false result

1 | 0 | logical array

True or false result, returned as 1 or 0 of data type `logical`.

A value of 1 indicates a successful conversion.

If you set `Force` to `true`, the function returns a value of 1 if the conversion completes. However, the simulation results can differ from the simulation results for the model before conversion.

h — Handles of created Model blocks

numeric array

Handles of the created Model blocks, returned as a numeric array.

Data Types: double

Tips

- You cannot convert a parent subsystem and a child of that subsystem at the same time.
- Specifying multiple subsystems to convert with one command can save time compared to converting each subsystem separately. The multiple subsystem conversion process compiles the model once.
- If you specify multiple subsystems to convert, the conversion process attempts to convert each subsystem. Successfully converted subsystems produce referenced models, even if the conversions of other subsystems fail.
- If you specify multiple subsystems, consider:
 - In the input arguments, setting 'Autofix', 'ReplaceSubsystem', and 'CheckSimulationResults' to `true`.
 - In the model, setting a short simulation time.
- A data dictionary saves bus objects that it creates as part of the conversion process when both of these conditions exist:

- The top model uses a data dictionary.
- All changes to the top model are saved.
- To maintain the behavior of a masked subsystem, perform these additional tasks:
 - For masked callbacks, icons, ports, and documentation, create a backup copy of the masked subsystem before converting it to a referenced model. After conversion, copy the content from the Mask Editor of the backup masked subsystem to the Mask Editor of the new Model block.
 - Replace mask parameters with model arguments (see “Parameterize Instances of a Reusable Referenced Model”).

Note Referenced models do not support the functionality that you can achieve with mask initialization code to create masked parameters.

Compatibility Considerations

'BuildTarget' argument value 'RTW' is not recommended

Not recommended starting in R2019a

In R2019a, an argument value used with the `Simulink.SubSystem.convertToModelReference` function was updated. The legacy argument value is supported for backward compatibility.

To take advantage of the updated 'BuildTarget' argument value, use 'Coder' instead of 'RTW'.

See Also

`Simulink.BlockDiagram.copyContentsToSubsystem` | `Simulink.Bus.save` | `Simulink.SubSystem.copyContentsToBlockDiagram`

Topics

“Convert Subsystems to Referenced Models”

“Convert Subsystem to Referenced Model and Generate Code” (Simulink Coder)

Introduced in R2006a

Simulink.SubSystem.copyContentsToBlockDiagram

Copy graphical contents from subsystem to empty system

Syntax

```
Simulink.SubSystem.copyContentsToBlockDiagram(subsys, sys)
```

Description

`Simulink.SubSystem.copyContentsToBlockDiagram(subsys, sys)` copies the blocks, lines, and annotations of the specified subsystem to the top-level block diagram of the specified system. It does not affect nongraphical information such as configuration sets.

To use this function:

- The specified system must be loaded in memory.
- The specified subsystem must be loaded in memory.
- The specified system must not contain any blocks or lines. Other types of information can exist in the system and are unaffected by the function. To delete the graphical content of the system, use `Simulink.BlockDiagram.deleteContents`.

Examples

Copy Subsystem Contents to Model

Copy the graphical contents of a subsystem to a new model.

Open the f14 model.

```
open_system('f14');
```

Create an empty model named f14Controller.

```
model = new_system('f14Controller');  
open_system(model)
```

Copy the graphical contents from the f14/Controller subsystem to the empty f14Controller model.

```
Simulink.SubSystem.copyContentsToBlockDiagram('f14/Controller', model)
```

Input Arguments

subsys — Subsystem block path or handle

character vector | string scalar | numeric scalar

Subsystem block path or handle, specified as a character vector, string scalar, or numeric scalar.

Example: 'model1/Subsystem'

Data Types: `double` | `char` | `string`

sys — System name or handle

character vector | string scalar | numeric scalar

System name or handle, specified as a character vector, string scalar, or numeric scalar.

A system name must not include a path or extension.

Example: `'model2'`

Data Types: `double` | `char` | `string`

Tips

To flatten a model hierarchy by replacing a subsystem with its contents, use the `Simulink.BlockDiagram.expandSubsystem` function.

See Also

`Simulink.BlockDiagram.copyContentsToSubsystem` |

`Simulink.BlockDiagram.deleteContents` |

`Simulink.SubSystem.convertToModelReference` | `Simulink.SubSystem.deleteContents`

Topics

“Create Subsystems”

“Expand Subsystem Contents”

Introduced in R2007a

Simulink.SubSystem.deleteContents

Delete contents of subsystem

Syntax

```
Simulink.SubSystem.deleteContents(subsys)
```

Description

`Simulink.SubSystem.deleteContents(subsys)` deletes the blocks, lines, and annotations in the specified subsystem, which must be loaded in memory.

Examples

Delete Subsystem Contents

Open the f14 model.

```
open_system('f14')
```

Delete the graphical contents from the f14/Controller subsystem.

```
Simulink.SubSystem.deleteContents('f14/Controller')
```

Input Arguments

subsys — Subsystem block path or handle

character vector | string scalar | numeric scalar

Subsystem block path or handle, specified as a character vector, string scalar, or numeric scalar.

Data Types: double | char | string

See Also

`Simulink.BlockDiagram.copyContentsToSubsystem` |

`Simulink.BlockDiagram.deleteContents` |

`Simulink.SubSystem.convertToModelReference` |

`Simulink.SubSystem.copyContentsToBlockDiagram`

Topics

“Create Subsystems”

Introduced in R2007a

Simulink.SubSystem.getChecksum

Return checksum of nonvirtual subsystem

Syntax

```
[checksum,details] = Simulink.SubSystem.getChecksum(subsys)
```

Description

[checksum,details] = Simulink.SubSystem.getChecksum(subsys) returns the checksum of the specified nonvirtual subsystem. Simulink computes the checksum based on the subsystem parameter settings and the blocks the subsystem contains. Virtual subsystems do not have checksums.

One use of this command is to determine why code generated for a subsystem is not being reused.

Note Simulink.SubSystem.getChecksum compiles the model that contains the specified subsystem, if the model is not already in a compiled state. If you need to get the checksum for multiple subsystems and want to avoid multiple compiles, use the command `model([], [], [], 'compile')` to place the model in a compiled state before using Simulink.SubSystem.getChecksum.

This command accepts the argument `subsys`, which is the full name or handle of the nonvirtual subsystem block for which you are returning checksum data.

Examples

Run getChecksum on Model

Run the function Simulink.SubSystem.getChecksum on the model `rtwdemo_ssreuse`. In the MATLAB editor window, both output structures are displayed. In the workspace pane, double-click on either of the structures to view its contents.

Load the model `rtwdemo_ssreuse`.

```
rtwdemo_ssreuse
```

Select subsystem `SS1` and execute the follow line of code in the MATLAB editor to get the full name and path to the subsystem `SS1`:

```
path_ss1 = gcb
```

Run the function `getChecksum` on the subsystem with the following command:

```
[chksum1, chksum1_details] = Simulink.SubSystem.getChecksum(path_ss1)
```

The output structures `chksum1` and `chksum1_details` will store the output of the `getChecksum` function call.

```
chksum1 =  
  
    struct with fields:  
        Value: [4×1 uint32]  
        MarkedUnique: 0  
  
chksum1_details =  
  
    struct with fields:  
        ContentsChecksum: [1×1 struct]  
        InterfaceChecksum: [1×1 struct]  
        ContentsChecksumItems: [359×1 struct]  
        InterfaceChecksumItems: [60×1 struct]
```

Input Arguments

subsys — Name or handle of nonvirtual subsystem

character vector

Input the full name of the nonvirtual subsystem for which you want to calculate the checksum.

Data Types: char

Output Arguments

checksum — A structure that stores the value of the checksum and indicates whether **subsys** contains unique block or subsystem properties which prevent generated code reuse

structure

Checksum information, returned as a structure with the fields:

Value - 4×1 uint32 - Array of four 32-bit integers that represents the subsystem's 128-bit checksum

MarkedUnique - bool - True if the subsystem or the blocks it contains have properties that would prevent the code generated for the subsystem from being reused; otherwise, false

details — A structure that stores checksum data on model contents and the interface

structure

Checksum information, returned as a structure with the fields:

ContentsChecksum - structure - A structure of the same form as **checksum**, representing a checksum that provides information about all blocks in the system.

InterfaceChecksum - structure - A structure of the same form as **checksum**, representing a checksum that provides information about the subsystem's block parameters and connections

ContentsChecksumItems — Structure array that Simulink uses to compute the checksum for **ContentsChecksum**

structure

Structure array returned with the following fields:

Handle - char array Object for which Simulink added an item to the checksum. For a block, the handle is a full block path. For a block port, the handle is the full block path and a character vector that identifies the port.

Identifier - char array - Descriptor of the item Simulink added to the checksum. If the item is a documented parameter, the identifier is the parameter name

Value - type - Value of the item Simulink added to the checksum. If the item is a parameter, Value is the value returned by `get_param(handle, identifier)`.

InterfaceChecksumItems — Structure array that Simulink uses to compute the checksum for InterfaceChecksum

structure

Structure array returned with the following fields:

Handle - char array Object for which Simulink added an item to the checksum. For a block, the handle is a full block path. For a block port, the handle is the full block path and a character vector that identifies the port.

Identifier - char array - Descriptor of the item Simulink added to the checksum. If the item is a documented parameter, the identifier is the parameter name

Value - type - Value of the item Simulink added to the checksum. If the item is a parameter, Value is the value returned by `get_param(handle, identifier)`.

See Also

`Simulink.BlockDiagram.getChecksum`

Introduced in R2006b

Simulink.suppressDiagnostic

Suppress a diagnostic from a specific block

Syntax

```
Simulink.suppressDiagnostic(source, message_id)  
Simulink.suppressDiagnostic(diagnostic)
```

Description

`Simulink.suppressDiagnostic(source, message_id)` suppresses all instances of diagnostics represented by `message_id` thrown by the blocks specified by `source`.

`Simulink.suppressDiagnostic(diagnostic)` suppresses the diagnostics associated with MSLDiagnostic object `diagnostic`.

Examples

Suppress a Warning Thrown By a Block

Using the model from “Suppress Diagnostic Messages Programmatically”, use the `Simulink.suppressDiagnostic` function to suppress the parameter precision loss warning thrown by the Constant block, `one`.

```
Simulink.suppressDiagnostic('Suppressor_CLI_Demo/one', ...  
    'SimulinkFixedPoint:util:fxpParameterPrecisionLoss');
```

Input Arguments

source — Block or model object throwing the diagnostic

block path | block handle

The source of the diagnostic, specified as a block path, block handle, cell array of block paths, or cell array of block handles.

To get the block path, use the `gcb` function.

To get the block handle, use the `getSimulinkBlockHandle` function.

Data Types: char | cell

message_id — message identifier of diagnostic

message identifier | cell array of message identifiers

Message identifier of the diagnostic, specified as a character vector or a cell array of character vectors. You can find the message identifier of diagnostics thrown during simulation by accessing the `ExecutionInfo` property of the `Simulink.SimulationMetadata` object associated with a simulation. You can also use the `lastwarn` function.

Data Types: char | cell

diagnostic – Diagnostic object

MSLDiagnostic object

Diagnostic specified as an MSLDiagnostic object. Access the MSLDiagnostic object through the ExecutionInfo property of the Simulink.SimulationMetadata object.

Data Types: struct

See Also

Simulink.getSuppressedDiagnostics | Simulink.restoreDiagnostic | restore | Simulink.SuppressedDiagnostic

Topics

“Suppress Diagnostic Messages Programmatically”

sint

Create `Simulink.NumericType` object describing signed integer data type

Syntax

```
a = sint(WordLength)
```

Description

`sint(WordLength)` returns a `Simulink.NumericType` object that describes the data type of a signed integer with a word size given by *WordLength*.

Note `sint` is a legacy function. In new code, use `fixdt` instead. In existing code, replace `sint(WordLength)` with `fixdt(1,WordLength,0)`.

Examples

Define a 16-bit signed integer data type.

```
a = sint(16)
```

```
a =
```

```
    NumericType with properties:
```

```
        DataTypeMode: 'Fixed-point: binary point scaling'
        Signedness: 'Signed'
        WordLength: 16
        FractionLength: 0
        IsAlias: 0
        DataScope: 'Auto'
        HeaderFile: ''
        Description: ''
```

See Also

`fixdt` | `Simulink.NumericType` | `float` | `sfix` | `sfrac` | `ufix` | `ufrac` | `uint`

Introduced before R2006a

slblocksearchdb.trainfrommodel

Train suggestion engine to improve quick insert results based on one model

Syntax

```
slblocksearchdb.trainfrommodel(model)
```

Description

`slblocksearchdb.trainfrommodel(model)` improves quick insert search results based on a single model.

Examples

Use a Single Model for Training

Train the suggestion engine to use a model to improve results. Assume 'MyModels' is in the current folder. This code uses a relative path.

```
slblocksearchdb.trainfrommodel('MyModels/model.slx')
```

Input Arguments

model — Model for training the suggestion engine

model path

Model to train the suggestion engine, specified as a character vector or string scalar of the full model path or relative path. Include the `.slx` or `.mdl` extension

Example: 'H:/MyModels/model.slx' 'mymodel.slx'

See Also

`slblocksearchdb.untrainall` | `slblocksearchdb.trainfrommodelsindir` |
`slblocksearchdb.untrainmodel` | `slblocksearchdb.untrainmodelsindir`

Topics

"Improve Quick Block Insert Results"

Introduced in R2018a

slblocksearchdb.trainfrommodelsindir

Train suggestion engine to improve quick insert results based on models in a folder

Syntax

```
slblocksearchdb.trainfrommodelsindir(folder)
slblocksearchdb.trainfrommodelsindir(folder,'exclude',exclusions)
```

Description

`slblocksearchdb.trainfrommodelsindir(folder)` improves search results based on the models in `folder`, recursively.

`slblocksearchdb.trainfrommodelsindir(folder,'exclude',exclusions)` excludes the specified models from updating the suggestion engine.

Examples

Train Suggestion Engine and Exclude Folders and Models

Create the cell array `exPath` for a folder you want to exclude and a model you want to exclude. To train the suggestion engine, use the cell array in the `slblocksearchdb.trainfrommodelsindir` command.

```
exPath = {'MyModels/testmodels' 'MyModels/myvdp.slx'}
slblocksearchdb.trainfrommodelsindir('MyModels','exclude',exPath)
```

The command uses the models in the folder 'MyModels' with the exclusions you specified.

Input Arguments

folder — Folder whose models to use for training

folder path

Folder whose models to use for training the suggestion engine, specified as an absolute or relative path character vector or string scalar.

Example: 'H:/MyModels/trainingmodels' 'MyModels'

exclusions — Models to exclude from training models

cell array of character vectors | string array

Models to exclude from training the suggestion engine, specified as a cell array of character vectors or a string array. Specify folders or models to exclude as a full or relative path. Model names must include the file extension `.slx` or `.mdl`.

Example: {'H:/MyModels/trainingmodels' 'MyModels/trainingmodels2' 'MyModels/myvdp.slx'}

See Also

slblocksearchdb.untrainall | slblocksearchdb.untrainmodel |
slblocksearchdb.untrainmodelsindir | slblocksearchdb.trainfrommodel

Topics

“Improve Quick Block Insert Results”

Introduced in R2018a

slblocksearchdb.untrainall

Remove the effects of all added models from the suggestion engine

Syntax

```
slblocksearchdb.untrainall
```

Description

`slblocksearchdb.untrainall` removes the models added to the suggestion engine to improve quick insert results. Use this function when you want to return the database to the default state.

Examples

Add Models and Remove All

Add some models to the suggestion engine.

```
slblocksearchdb.trainfrommodelsindir('MyModels')  
slblocksearchdb.trainfrommodel('C:/users/TrainingModels/mymodel.slx')
```

Remove all added models from the suggestion engine.

```
slblocksearchdb.untrainall
```

See Also

```
slblocksearchdb.untrainmodelsindir | slblocksearchdb.untrainmodel |  
slblocksearchdb.trainfrommodelsindir | slblocksearchdb.trainfrommodel
```

Topics

“Improve Quick Block Insert Results”

Introduced in R2018a

slblocksearchdb.untrainmodel

Remove the effect of a model from the suggestion engine

Syntax

```
slblocksearchdb.untrainmodel('model')
```

Description

`slblocksearchdb.untrainmodel('model')` removes the effects of a single model from the suggestion engine.

Examples

Remove a Model from the Suggestion Engine

Train the suggestion engine to use a model to improve results.

```
slblocksearchdb.trainfrommodel('MyModels/model.slx')
```

Remove the model from the suggestion engine.

```
slblocksearchdb.untrainmodel('MyModels/model.slx')
```

Input Arguments

model — Model to remove from the suggestion engine

model path

Model whose effects to remove from the suggestion engine, specified as the full or relative path character vector or string scalar. Include the `.slx` or `.mdl` extension.

Example: `'H:/MyModels/model.slx'`

See Also

`slblocksearchdb.trainfrommodel` | `slblocksearchdb.trainfrommodelsindir` | `slblocksearchdb.untrainall` | `slblocksearchdb.untrainmodelsindir`

Topics

“Improve Quick Block Insert Results”

Introduced in R2018a

slblocksearchdb.untrainmodelsindir

Remove the effects of models from the suggestion engine

Syntax

```
slblocksearchdb.untrainmodelsindir(folder)
slblocksearchdb.untrainmodelsindir(folder,'exclude',exclusions)
```

Description

`slblocksearchdb.untrainmodelsindir(folder)` removes models in `folder` from the suggestion engine, recursively.

`slblocksearchdb.untrainmodelsindir(folder,'exclude',exclusions)` excludes the specified models from updating the suggestion engine.

Examples

Remove the Effects of Models from Suggestion Engine

Create the cell array `exPath` for a folder and a model whose effects you do not want to remove from the suggestion engine. Then use the cell array in the `slblocksearchdb.untrainmodelsindir` command.

```
exPath = {'MyModels/subfolder' 'MyModels/myvdp.slx'}
slblocksearchdb.untrainmodelsindir('MyModels','exclude',exPath)
```

The command removes the models in the folder 'MyModels' with the exclusions you specified.

Input Arguments

folder — Folder whose models to remove from the suggestion engine

folder path

Folder whose models to remove from the suggestion engine, specified as an absolute or relative path character vector or string scalar.

Example: 'H:/MyModels/trainingmodels' 'MyModels'

exclusions — Folders and models to exclude from removing

cell array of character vectors | string array

Folders or models to exclude from removing from the suggestion engine, specified as a cell array of character vectors or a string array. Specify the folders or models to exclude as a full or relative path. For models, include the `.slx` or `.mdl` extension.

Example: {'H:/MyModels/trainingmodels' 'MyModels/trainingmodels2' 'MyModels/myvdp.slx'}

See Also

slblocksearchdb.trainfrommodel | slblocksearchdb.untrainmodel |
slblocksearchdb.trainfrommodelsindir | slblocksearchdb.untrainall

Topics

“Improve Quick Block Insert Results”

Introduced in R2018a

slbuild

Build standalone executable file or model reference target for model

Syntax

```
slbuild(model)
slbuild(model,buildSpec)
slbuild(model,Name,Value)
blockHandle = slbuild(subsystem)
blockHandle = slbuild(subsystem,'Mode','ExportFunctionCalls')
blockHandle = slbuild(subsystem,Name,Value)
```

Description

`slbuild(model)` builds a standalone Simulink Coder binary executable file from the specified model, using the current configuration parameter settings. If the model is not loaded, `slbuild` loads the model before starting the build process.

`slbuild(model,buildSpec)` builds a standalone Simulink Coder binary executable file from the model according to the specified code generation action.

`slbuild(model,Name,Value)` builds a standalone Simulink Coder binary executable file from the model as specified by one or more name-value arguments.

`blockHandle = slbuild(subsystem)` generates subsystem code and builds a Simulink Coder binary executable file by using the current configuration parameter settings of your model. If the selected system target file creates an S-Function block, the function returns a non-empty block handle to an autogenerated S-Function wrapper. Before you run the command, you must open or load the parent model.

`blockHandle = slbuild(subsystem,'Mode','ExportFunctionCalls')` generates code from the subsystem that includes function calls that you can export to external application code. This command requires Embedded Coder. If the **Create block** configuration parameter is set to `SIL`, the function returns the handle to a `SIL` block. You can then use the `SIL` block for numerical equivalence testing.

`blockHandle = slbuild(subsystem,Name,Value)` generates subsystem code and builds a Simulink Coder binary executable file as specified by one or more name-value arguments.

Examples

Generate Code and Build Executable File for Model

Generate C code for model `rtwdemo_rtwintr`.

```
slbuild('rtwdemo_rtwintr')
% Same operation as ...
% slbuild('rtwdemo_rtwintr','StandaloneCoderTarget')
```

For the generic real-time (GRT) target, the coder generates these code files and places them in folders `rtwdemo_rtwintrg_grt_rtw` and `slprj/grt/_sharedutils`.

| Model Files | Shared Files | Interface Files | Other Files |
|---|-------------------------------------|------------------------|-------------|
| <code>rtwdemo_rtwintrg.c</code> | <code>rtwtypes.h</code> | <code>rtmodel.h</code> | none |
| <code>rtwdemo_rtwintrg.h</code> | <code>multiword_types.h</code> | | |
| <code>rtwdemo_rtwintrg_private.h</code> | <code>builtin_typeid_types.h</code> | | |
| <code>rtwdemo_rtwintrg_types.h</code> | | | |

If the following model configuration parameters settings apply, the coder generates additional results.

| Parameter Setting | Results |
|---|--|
| Code Generation > Generate code only pane is cleared | Executable file <code>rtwdemo_rtwintrg.exe</code> |
| Code Generation > Report > Create code generation report is selected | Report appears, providing information and links to generated code files, subsystem and code interface reports, entry-point functions, inports, outports, interface parameters, and data stores |

Build Multiple Top Models

This example shows how to use `slbuild` to generate executable code for two models, `sldemo_mdhref_depgraph` and `rtwdemo_counter`. `sldemo_mdhref_depgraph` is a top model that references models. The example also shows how to build the referenced models in parallel.

Create a local folder.

```
if exist(fullfile('.', 'myTempFolder'), 'dir')
    rmdir('myTempFolder', 's')
end
mkdir myTempFolder
cd myTempFolder
```

Copy `sldemo_mdhref_depgraph`, which references models, to the local folder.

```
src_dir = fullfile(matlabroot, ...
    'toolbox', ...
    'simulink', ...
    'simdemos', ...
    'simfeatures', ...
    'modelreference');
copyfile(fullfile(src_dir, ...
    'sldemo_mdhref_depgraph.slx'), ...
    '.');
```

Enable parallel building of models referenced by `sldemo_mdhref_depgraph`.

```
load_system('sldemo_mdref_depgraph')
set_param('sldemo_mdref_depgraph', ...
'EnableParallelModelReferenceBuilds', 'on');
```

Initialize MATLAB workers for parallel building of referenced models.

```
set_param('sldemo_mdref_depgraph', ...
'ParallelModelReferenceMATLABWorkerInit', ...
'Copy Base Workspace');
```

Build the models.

```
slbuild({'sldemo_mdref_depgraph', 'rtwdemo_counter'})
```

In myTempFolder, the build process creates standalone executable files, sldemo_mdref_depgraph.exe and rtwdemo_counter.exe.

For each model, in the Command Window, the build process displays a build summary.

Build Summary

Code generation targets built:

| Model | Action | Rebuild Reason |
|---------------------------|-----------------------------|---|
| sldemo_mdref_F2C | Code generated and compiled | sldemo_mdref_F2C.c does not exist. |
| sldemo_mdref_thermostat | Code generated and compiled | sldemo_mdref_thermostat.c does not exist. |
| sldemo_mdref_heat2cost | Code generated and compiled | sldemo_mdref_heat2cost.c does not exist. |
| sldemo_mdref_house | Code generated and compiled | sldemo_mdref_house.c does not exist. |
| sldemo_mdref_heater | Code generated and compiled | sldemo_mdref_heater.c does not exist. |
| sldemo_mdref_outdoor_temp | Code generated and compiled | sldemo_mdref_outdoor_temp.c does not exist. |

Top model targets built:

| Model | Action | Rebuild Reason |
|-----------------------|-----------------------------|--|
| sldemo_mdref_depgraph | Code generated and compiled | Code generation information file does not exist. |

7 of 7 models built (0 models already up to date)

Build duration: 0h 3m 56.859s

Starting build procedure for: rtwdemo_counter

Successful completion of build procedure for: rtwdemo_counter

Build Summary

Top model targets built:

| Model | Action | Rebuild Reason |
|-----------------|-----------------------------|--|
| rtwdemo_counter | Code generated and compiled | Code generation information file does not exist. |

1 of 1 models built (0 models already up to date)

Build duration: 0h 1m 12.556s

Force Top Model Build

Generate code and build an executable file for rtwdemo_mdref_top, which refers to model rtwdemo_mdref_bot, regardless of model checksums and parameter settings.

```
slbuild('rtwdemo_mdleftop','StandaloneCoderTarget', ...
    'ForceTopModelBuild',true)
```

Generate Code and Build Executable File for Subsystem

Generate C code for subsystem Amplifier in model rtwdemo_rtwinintro.

```
rtwdemo_rtwinintro
slbuild('rtwdemo_rtwinintro/Amplifier')
```

The code generator produces code files in the Amplifier_grt_rtw and slprj/grt/_sharedutils folders.

In your current working folder, the build process creates an executable file (Amplifier.exe).

Build Subsystem for Exporting Code to External Application

To export function calls to external application code, build an executable file from a function-call subsystem.

```
rtwdemo_exporting_functions
set_param('rtwdemo_exporting_functions','GenCodeOnly','off');
slbuild('rtwdemo_exporting_functions/rtwdemo_subsystem','Mode','ExportFunctionCalls')
```

The executable file rtwdemo_subsystem.exe appears in your working folder.

Create SIL Block for Testing

From a function-call subsystem, create a SIL block that you can use to test the code generated from a model.

Open subsystem rtwdemo_subsystem in model rtwdemo_exporting_functions and set the **Create block** configuration parameter to SIL.

Create the SIL block.

```
mysilblockhandle = slbuild('rtwdemo_exporting_functions/rtwdemo_subsystem',...
    'Mode','ExportFunctionCalls')
```

The code generator produces a SIL block for the generated subsystem code. You can add the block to an environment or test harness model that supplies test vectors or stimulus input. You can then run simulations that perform SIL tests and verify that the generated code in the SIL block produces the same result as the original subsystem.

Input Arguments

model — Specifies model for the build process

handle | character vector | cell array of handles or character vectors

If you specify the model name as a handle or character vector, the build process creates a standalone executable file or model reference target.

If you specify multiple models through a cell array of handles or character vectors, the build process applies `buildSpec` to each model in the cell array.

Example: `gcs`

subsystem — Subsystem name

handle | character vector | cell array of handles or character vectors

Name of subsystem from which you want to generate code or build an executable file, specified as a handle or character vector representing the subsystem name or the full block path.

You can specify multiple subsystems through a cell array of handles or character vectors

Example: `'rtwdemo_exporting_functions/rtwdemo_subsystem'`

buildSpec — Specifies the code generation action for the build process

'StandaloneCoderTarget' (default) | 'ModelReferenceSimTarget' |
'ModelReferenceCoderTarget' | 'ModelReferenceCoderTargetOnly' | 'CleanTopModel'

`buildSpec` directs the code generator to perform the selected build action for the model and the build process:

- Honors the setting of the **Rebuild** parameter on the **Model Referencing** pane of the Configuration Parameters dialog box.
- Requires a Simulink Coder license only if you build a model reference Simulink Coder target, not if you build a model reference simulation target only.

The `buildSpec` argument must be one of the following.

| buildSpec | Build Action |
|---------------------------------|---|
| 'StandaloneCoderTarget' | Builds a standalone Simulink Coder binary executable file for the specified model, using the current model configuration settings. It also builds model reference coder targets for the referenced models. If the specified model is not loaded, <code>sbuild</code> loads it before initiating the build process. |
| 'ModelReferenceSimTarget' | Builds a model reference simulation target (does not require a Simulink Coder license). |
| 'ModelReferenceCoderTarget' | Builds a model reference Simulink Coder target and the corresponding model reference simulation target. |
| 'ModelReferenceCoderTargetOnly' | Builds only a model reference Simulink Coder target. |
| 'CleanTopModel' | Cleans the model build area enough to trigger regeneration of the top model code at the next build. |

Example: `'ModelReferenceSimTarget'`

Name-Value Pair Arguments

Specify optional comma-separated pairs of `Name`, `Value` arguments. `Name` is the argument name and `Value` is the corresponding value. `Name` must appear inside quotes. You can specify several name and value pair arguments in any order as `Name1, Value1, ..., NameN, ValueN`.

Example: `'UpdateThisModelReferenceTarget', 'Force'`

UpdateThisModelReferenceTarget — Conditional rebuild option for model reference build

'Force' | 'IfOutOfDateOrStructuralChange' | 'IfOutOfDate'

Conditional rebuild option for the model reference build, specified as the comma-separated pair consisting of 'UpdateThisModelReferenceTarget' and 'Force', 'IfOutOfDateOrStructuralChange', or 'IfOutOfDate'.

This option applies only to the specified model, not to any models referenced by the specified model.

| 'UpdateThisModelReferenceTarget' Value | Equivalent Rebuild Option | Rebuild Action |
|--|---|--|
| 'Force' | Always | Unconditionally rebuilds the model. |
| 'IfOutOfDateOrStructuralChange' | If any changes detected | Rebuilds the model if the build process detects any changes. |
| 'IfOutOfDate' | If any changes in known dependencies detected | Rebuilds the model if the build process detects any changes in known dependencies of this model. |

For more information on the different rebuild options, see **Rebuild**.

Example: 'UpdateThisModelReferenceTarget', 'Force'

Dependencies

To use this option, set buildSpec to 'ModelReferenceSimTarget', 'ModelReferenceCoderTarget', or 'ModelReferenceCoderTargetOnly'.

Data Types: char | string

ForceTopModelBuild — Force top model of model hierarchy to build

false (default) | true

Option to force the top model of the model hierarchy to build, specified as the comma-separated pair consisting of 'ForceTopModelBuild' and true or false.

Setting the value to true directs the code generator to generate code and build an executable file for the top model of the model hierarchy, regardless of model checksums and parameter settings.

Example: 'ForceTopModelBuild', true

Dependencies

To use this option, set buildSpec to 'StandaloneCoderTarget'.

Data Types: logical

GenerateCodeOnly — Generate code only

false | true

If you do not specify a value, the **Generate code only** (GenCodeOnly) option on the **Code Generation** pane controls build process behavior.

If you specify a value, the argument overrides the **Generate code only** (GenCodeOnly) option on the **Code Generation** pane:

- true -- Generate code only.

- `false` -- Generate code and build executable file.

Mode — Export function calls (for subsystem builds only)`'ExportFunctionCalls' | 'Normal'`

- `'ExportFunctionCalls'` -- If you have Embedded Coder, generates code from subsystem that includes function calls that you can export to external application code.
- `'Normal'` -- Does not export function calls.

ExportFunctionFileName — Function name

character vector

Name the exported function for the specified subsystem.

Example:

```
slbuild(subsystem, 'Mode', 'ExportFunctionCalls', 'ExportFunctionFileName',  
fcname)
```

OpenBuildStatusAutomatically — Display build information`false (default) | true`

Option to display the build information, specified as the comma-separated pair consisting of `'OpenBuildStatusAutomatically'` and `true` or `false`.

To display build information in the Build Status window, specify `true`. The default is `false`. For more information about using the status window, see “Monitor Parallel Building of Referenced Models” (Simulink Coder).

The Build Status window supports parallel builds of referenced model hierarchies. Do not use the Build Status window for serial builds.

Dependencies

To use this option, set `buildSpec` to `'StandaloneCoderTarget'`.

Data Types: `logical`

ObfuscateCode — Generate obfuscated C code`false (default) | true`

Specify whether to generate obfuscated C code:

- `true` -- Generate obfuscated C code that you can share with third parties with reduced likelihood of compromising intellectual property.
- `false` -- Generated C code is not obfuscated.

IncludeModelReferenceSimulationTargets — Build model reference simulation targets`false (default) | true`

Option to build model reference simulation targets, specified as the comma-separated pair consisting of `'IncludeModelReferenceSimulationTargets'` and `true` or `false`.

Dependencies

To use this option, set `buildSpec` to `'StandaloneCoderTarget'`.

Data Types: `logical`

Output Arguments

blockHandle — Block handle

handle

Block handle to an autogenerated S-Function wrapper block.

Compatibility Considerations

slbuild does not generate model reference simulation targets by default

Behavior changed in R2020b

Starting in R2020b, the `slbuild` function does not generate model reference simulation targets by default. Excluding the model reference simulation targets allows for faster code generation for model hierarchies.

You can generate both the simulation and code generation targets with the default `buildSpec` value ('`StandaloneCoderTarget`') by setting `IncludeModelReferenceSimulationTargets` to `true`.

'StandaloneRTWTarget', 'ModelReferenceRTWTarget', and 'ModelReferenceRTWTargetOnly' arguments are not recommended

Not recommended starting in R2019a

In R2019a, some arguments used with the `slbuild` function were updated. Legacy arguments are supported for backward compatibility.

To take advantage of the updated arguments:

- Use '`StandaloneCoderTarget`' instead of '`StandaloneRTWTarget`'
- Use '`ModelReferenceCoderTarget`' instead of '`ModelReferenceRTWTarget`'
- Use '`ModelReferenceCoderTargetOnly`' instead of '`ModelReferenceRTWTargetOnly`'

Extended Capabilities

Automatic Parallel Support

Accelerate code by automatically running computation in parallel using Parallel Computing Toolbox™.

To build referenced models in parallel, in the top model, select the configuration parameter check box **Enable parallel model reference builds**. For more information, see “Reduce Build Time for Referenced Models by Using Parallel Builds” (Simulink Coder).

In Parallel Computing Toolbox commands, for example, a `parfor` or `spm` loop, do not invoke `rtwbuild`, `rtwrebuild`, or `slbuild` commands that build models that are configured for parallel builds.

See Also

`codebuild` | `rtwrebuild`

Topics

“Manage Simulation Targets for Referenced Models”

“What Is Acceleration?”

“Perform Acceleration”

“Share Simulink Cache Files for Faster Simulation”

“Build and Run a Program” (Simulink Coder)

“Approaches for Building Code Generated from Simulink Models” (Simulink Coder)

“Control Regeneration of Top Model Code” (Simulink Coder)

“Generate Component Source Code for Export to External Code Base” (Embedded Coder)

“Test Generated Code with SIL and PIL Simulations” (Embedded Coder)

Introduced before R2006a

slCharacterEncoding

Specify encoding to use in code generated from Simulink models

Syntax

```
slCharacterEncoding(encoding)  
encoding = slCharacterEncoding()
```

Description

`slCharacterEncoding(encoding)` specifies the character set used in the code generated from Simulink models. The character set encoding affects the comments in the generated code.

`encoding = slCharacterEncoding()` returns the current Simulink character set encoding.

Examples

Specify Encoding for ASCII Characters

Suppose that you generate code for an embedded target and the compiler you use requires that the source code contain only ASCII characters.

Use this command:

```
slCharacterEncoding('US-ASCII')
```

Specify Encoding for Non-ASCII Characters

Suppose that you have a model that contains non-ASCII characters (multilingual characters, special symbols) and you want these annotations to be easily readable in your generated code.

If your compiler supports UTF-8, on Windows, use this command:

```
slCharacterEncoding('UTF-8')
```

UTF-8 is the default encoding on Linux and Mac.

Specify Encoding for Non-English Locale

Suppose that your model contains Japanese text but your machine is configured for an English-language locale. You want to generate code with 'Shift_JIS' encoded text so that your team members who use 'Shift_JIS' as their locale-specific encoding can see the Japanese text in the generated code.

Use this command:

```
slCharacterEncoding('Shift_JIS')
```

Input Arguments

encoding – Character encoding to use for the generated code
'US-ASCII' | 'UTF-8' | other supported encodings

Set the character encoding to a supported encoding value.

See Also

Topics

“Open a Model That Has Different Character Encoding”

Introduced before R2006a

slCreateToolstripComponent

Create custom Simulink Toolstrip component

Syntax

```
slCreateToolstripComponent(component)  
slCreateToolstripComponent(component,Name=Value)
```

Description

`slCreateToolstripComponent(component)` creates a `resources` folder for a custom Simulink Toolstrip component in the current folder and adds the current folder to the MATLAB path.

`slCreateToolstripComponent(component,Name=Value)` sets properties using name-value arguments. For example, `slCreateToolstripComponent("custom",Location="B:\path\customtab")` creates the `resources` folder for a component named `custom` in the `B:\path\customtab` directory and adds `B:\path\customtab` to the MATLAB path.

Examples

Create Simulink Toolstrip Component

A Simulink Toolstrip component contains the definition for one or more custom tabs. Before you create a custom tab, you must create the component that will contain it.

To work with the Simulink Toolstrip, start Simulink. For example, in the MATLAB Command Window, enter:

```
start_simulink
```

Create a custom Simulink Toolstrip component by using the `slCreateToolstripComponent` function. For example, name the component `custom`.

```
slCreateToolstripComponent("custom");
```

This command creates a `resources` folder in your current folder and adds your current folder to the MATLAB path. The `resources` folder contains two folders and one JSON file.

- `icons` folder — Location of icons used by custom tab elements
- `json` folder — Location of JSON files that define custom tabs
- `sl_toolstrip_plugins.json` — JSON file that must not be edited

Create Temporary Simulink Toolstrip Component

By default, Simulink Toolstrip components persist across sessions. You can create a temporary Simulink Toolstrip component that persists only during the current session.

Create a temporary custom Simulink Toolstrip component by using the `slCreateToolstripComponent` function. For example, name the component `temp`.

```
slCreateToolstripComponent("temp",Persist=false);
```

This command creates a `resources` folder in your current folder and adds your current folder to the MATLAB path. The `resources` folder contains two folders and one JSON file.

- `icons` folder — Location of icons used by custom tab elements
- `json` folder — Location of JSON files that define custom tabs
- `sl_toolstrip_plugins.json` — JSON file that must not be edited

When you open a new MATLAB session, the `temp` component is not loaded.

Input Arguments

component — Component name

character vector | string scalar

Component name, specified as a character vector or string scalar.

The component name appears in the `sl_toolstrip_plugins.json` file as the value for the `Name` property. Do not edit this file.

Example: `slCreateToolstripComponent("custom")`

Data Types: `char` | `string`

Name-Value Arguments

Specify optional pairs of arguments as `Name1=Value1, ..., NameN=ValueN`, where `Name` is the argument name and `Value` is the corresponding value. Name-value arguments must appear after other arguments, but the order of the pairs does not matter.

Example: `slCreateToolstripComponent("custom",Location="B:\path\customtab",Persist=false)`

Location — Storage location for component files

current folder (default) | character vector | string scalar

Storage location for component files, specified as a character vector or string scalar. The function adds the storage location to the MATLAB path.

By default, the function generates the component files in a `resources` folder in the current folder.

Example: `slCreateToolstripComponent("custom",Location="B:\path\customtab")`

Data Types: `char` | `string`

Persist — Option to load component for new MATLAB sessions

true or 1 (default) | false or 0

Option to load component for new MATLAB sessions, specified as a numeric or logical 1 (`true`) or 0 (`false`).

Example: `slCreateToolstripComponent("custom",Persist=false)`

Data Types: double | logical

See Also

slCreateToolstripTab | slDestroyToolstripComponent | slLoadedToolstripComponents
| slPersistToolstripComponent

Topics

“Create Custom Simulink Toolstrip Tabs”

“Add Prepopulated Custom Tab to Simulink Toolstrip”

Introduced in R2021b

slCreateToolstripTab

Create custom tab for Simulink Toolstrip

Syntax

```
slCreateToolstripTab(tab,component)
slCreateToolstripTab(tab,component,Name=Value)
```

Description

`slCreateToolstripTab(tab,component)` creates a blank custom tab in the specified Simulink Toolstrip component, opens the JSON file that defines the custom tab, and reloads the toolstrip configuration.

`slCreateToolstripTab(tab,component,Name=Value)` sets properties using name-value arguments. For example, `slCreateToolstripTab('toolsTab','custom',Title="Tools")` creates a **Tools** tab.

Examples

Create Untitled Custom Tab in Simulink Toolstrip

A Simulink Toolstrip component contains the definition for one or more custom tabs. Before you create a custom tab, you must create the component to contain it.

To work with the Simulink Toolstrip, start Simulink. For example, in the MATLAB Command Window, enter:

```
start_simulink
```

Create a custom Simulink Toolstrip component by using the `slCreateToolstripComponent` function. For example, name the component `custom`.

```
slCreateToolstripComponent("custom");
```

This command creates a `resources` folder in your current folder and adds your current folder to the MATLAB path. The `resources` folder contains two folders and one JSON file.

- `icons` folder — Location of icons used by custom tab elements
- `json` folder — Location of JSON files that define custom tabs
- `sl_toolstrip_plugins.json` — JSON file that must not be edited

Create an untitled custom tab with the `slCreateToolstripTab` function.

For example, create the tab `customTab` in the `custom` component.

```
slCreateToolstripTab("customTab","custom");
```

The function creates a JSON file in the `json` folder that contains information about the tab. For example:

```
{
  "version": "R2021b",
  "entries": [
    {
      "type": "Tab",
      "id": "customTab",
      "title": ""
    }
  ]
}
```

Open a model. For example, open the vdp model.

```
vdp
```

The Simulink Toolstrip displays a blank tab without a title.

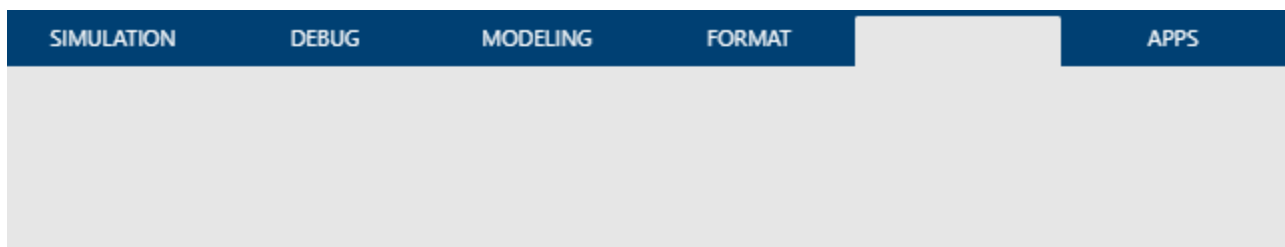

Create Titled Custom Tab in Simulink Toolstrip

A Simulink Toolstrip component contains the definition for one or more custom tabs. Before you create a custom tab, you must create the component to contain it.

To work with the Simulink Toolstrip, start Simulink. For example, in the MATLAB Command Window, enter:

```
start_simulink
```

Create a custom Simulink Toolstrip component by using the `slCreateToolstripComponent` function. For example, name the component `custom`.

```
slCreateToolstripComponent("custom");
```

This command creates a `resources` folder in your current folder and adds your current folder to the MATLAB path. The `resources` folder contains two folders and one JSON file.

- `icons` folder — Location of icons used by custom tab elements
- `json` folder — Location of JSON files that define custom tabs
- `sl_toolstrip_plugins.json` — JSON file that must not be edited

Create a custom tab with the `slCreateToolstripTab` function.

For example, create the tab `customTab` in the `custom` component, and title the tab `CUSTOM TAB`.

```
slCreateToolstripTab("customTab","custom",Title="CUSTOM TAB");
```

The function creates a JSON file named `customTab.json` in the `json` folder that defines the tab.

Open a model. For example, open the vdp model.

vdp

The Simulink Toolstrip displays a blank tab titled CUSTOM TAB.

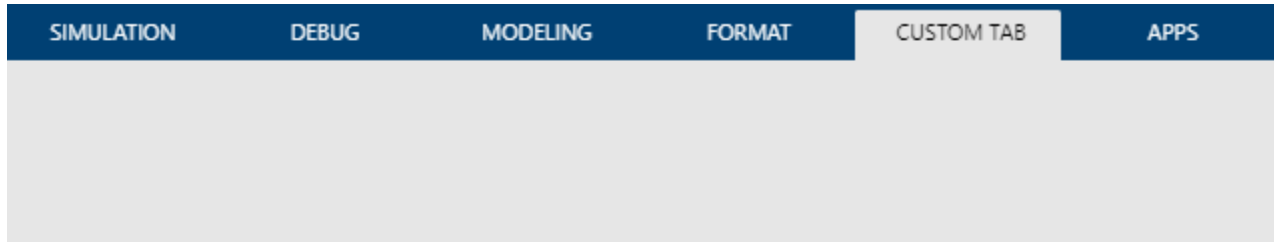

Input Arguments

tab — Tab ID

character vector | string scalar

Tab ID, specified as a character vector or string scalar.

The tab ID appears in the JSON file that defines the tab as the value for the `id` property in the JSON object where `"type": "Tab"`.

Data Types: `char` | `string`

component — Component name

character vector | string scalar

Component name, specified as a character vector or string scalar.

The component name appears in the `sl_toolstrip_plugins.json` file as the value for the `Name` property. Do not edit this file.

Data Types: `char` | `string`

Name-Value Arguments

Specify optional pairs of arguments as `Name1=Value1, ..., NameN=ValueN`, where `Name` is the argument name and `Value` is the corresponding value. Name-value arguments must appear after other arguments, but the order of the pairs does not matter.

Example: `slCreateToolstripTab('customTab','custom',Title="Custom Tab")`

Title — Tab title

`""` (default) | character vector | string scalar

Tab title, specified as a character vector or string scalar.

Tab titles use all uppercase letters even when you specify a title with lowercase letters.

The tab title appears in the JSON file that defines the tab as the value for the `title` property of the JSON object where `"type": "Tab"`.

Data Types: `char` | `string`

FileName — Name of file that defines tab

<tabname>.json (default) | character vector | string scalar

Name of file that defines the tab, specified as a character vector or string scalar.

Data Types: char | string

See Also

slCreateToolstripComponent | slToolstripDeveloperMode | slReloadToolstripConfig

Topics

“Create Custom Simulink Toolstrip Tabs”

“Add Prepopulated Custom Tab to Simulink Toolstrip”

Introduced in R2021b

sldebug

Start simulation in debug mode

Syntax

```
sldebug('sys')
```

Description

`sldebug('sys')` starts a simulation in debug mode. See “Debugger Command-Line Interface” for information about using the debugger.

Examples

The following command:

```
sldebug('vdp')
```

loads the Simulink example model `vdp` into memory and starts the simulation in debug mode. Alternatively, you can achieve the same result by using the `sim` command:

```
sim('vdp', 'debug', 'on')
```

See Also

`sim`

Introduced in R2006a

slDestroyToolstripComponent

Destroy Simulink Toolstrip component

Syntax

```
slDestroyToolstripComponent(component)
```

Description

`slDestroyToolstripComponent(component)` destroys the specified Simulink Toolstrip component and its resource directory.

Examples

Delete Custom Simulink Toolstrip Component

Suppose you have a Simulink Toolstrip component that you no longer need named `custom`.

Delete the component named `custom`. In the MATLAB Command Window, enter:

```
slDestroyToolstripComponent("custom")
```

Input Arguments

component — Component name

character vector | string scalar

Component name, specified as a character vector or string scalar.

The component name appears in the `sl_toolstrip_plugins.json` file as the value for the "Name" property. Do not edit this file.

Example: `slDestroyToolstripComponent("custom")`

Data Types: `char` | `string`

See Also

`slCreateToolstripComponent` | `slLoadedToolstripComponents`

Topics

"Create Custom Simulink Toolstrip Tabs"

"Add Prepopulated Custom Tab to Simulink Toolstrip"

Introduced in R2021b

sldiagnostics

Display diagnostic information about Simulink system

Syntax

```
sldiagnostics('sys')
[txtRpt, sRpt] = sldiagnostics('sys')
[txtRpt, sRpt] = sldiagnostics('sys', options)
[txtRpt, sRpt] = sldiagnostics('sys', 'CompileStats')
[txtRpt, sRpt] = sldiagnostics('sys', 'RTWBuildStats')
```

Description

`sldiagnostics('sys')` displays the following diagnostic information associated with the model or subsystem specified by `sys`:

- Number of each type of block
- Number of each type of Stateflow object
- Number of states, outputs, inputs, and sample times of the root model.
- Names of libraries referenced and instances of the referenced blocks
- Time and additional memory used for each compilation phase of the root model

If the model specified by `sys` is not loaded, then `sldiagnostics` loads the model before performing the analysis.

The command `sldiagnostics('sys', options)` displays only the diagnostic information associated with the specific operations listed as `options` character vectors. The table below summarizes the options available and their corresponding valid input and output.

With `sldiagnostics`, you can input the name of a model or the path to a subsystem. For some analysis options, `sldiagnostics` can analyze only a root model. If you provide an incompatible input for one of these analyses, then `sldiagnostics` issues a warning. Finally, if you input a Simulink Library, then `sldiagnostics` cannot perform options that require a model compilation (**Update Diagram**). Instead, `sldiagnostics` issues a warning.

During the analysis, `sldiagnostics` will follow library links but will not follow or analyze Model References. See `find_mdhrefs` for more information on finding all Model blocks and referenced models in a specified model.

| Option | Valid Inputs | Output |
|-------------|-----------------------------------|--|
| CountBlocks | root model, library, or subsystem | Lists all unique blocks in the system and the number of occurrences of each. This includes blocks that are nested in masked subsystems or hidden blocks. |
| CountSF | root model, library, or subsystem | Lists all unique Stateflow objects in the system and the number of occurrences of each. |

| Option | Valid Inputs | Output |
|---------------|-----------------------------------|---|
| Sizes | root model | Lists the number of states, outputs, inputs, and sample times, as well as a flag indicating direct feedthrough, used in the root model. |
| Libs | root model, library, or subsystem | Lists all unique libraries referenced in the root model, as well as the names and numbers of the library blocks. |
| CompileStats | root model | Lists the time and additional memory used for each compilation phase of the root model. This information helps users troubleshoot model compilation speed and memory issues. |
| RTWBuildStats | root model | Lists the same information as the <code>CompileStats</code> diagnostic. When issued with the second output argument <code>sRpt</code> , it captures the same statistics included in <code>CompileStats</code> and also the Simulink Coder build statistics. You must explicitly specify this option, because it is not part of the default analysis. |
| All | not applicable | Performs all diagnostics. |

Note Running the `CompileStats` diagnostic before simulating a model for the first time will show greater memory usage. However, subsequent runs of the `CompileStats` diagnostic on the model will require less memory usage.

`[txtRpt, sRpt] = sldiagnostics('sys')` returns the diagnostic information as a textual report `txtRpt` and a structure array `sRpt`, which contains the following fields that correspond to the diagnostic options:

- `blocks`
- `stateflow`
- `sizes`
- `links`
- `compilestats`

`[txtRpt, sRpt] = sldiagnostics('sys', options)` returns only the specified options. If your chosen options specify just one type of analysis, then `sRpt` contains the results of only that analysis.

`[txtRpt, sRpt] = sldiagnostics('sys', 'CompileStats')` returns information on time and memory usage in `txtRpt` and `sRpt`.

`[txtRpt, sRpt] = sldiagnostics('sys', 'RTWBuildStats')` includes Simulink Coder build statistics in addition to the information reported for `CompileStats` in the `sRpt` output.

- `txtRpt` contains the formatted textual output of time spent in each of the phases in Simulink and Simulink Coder (if you specified `RTWBuildStats`), for example:

```

Compile Statistics For: rtwdemo_counter
  Cstat1: 0.00 seconds Model compilation pre-start
  Cstat2: 0.00 seconds Stateflow compile pre-start notification
  Cstat3: 0.10 seconds Post pre-comp-start engine event
  Cstat4: 10.00 seconds Stateflow compile start notification
  Cstat5: 0.00 seconds Model compilation startup completed

```

- `sRpt` is a MATLAB structure containing time and memory usage for each of the phases, for example:

```

sRpt =
Model:      'myModel1'
Statistics:  [1x134 struct]

```

The size of the `sRpt.Statistics` array indicates the number of compile and build phases executed during the operation. Examine the Statistics fields:

```

sRpt.Statistics(1) =
Description:      'Phase1'
CPUTime:         7.2490
WallClockTime    4.0092
ProcessMemUsage: 26.2148
ProcessMemUsagePeak: 28.6680
ProcessVMSize:   15.9531

```

`CPUTime` and `WallClockTime` show the elapsed time for the phase in seconds. `ProcessMemUsage`, `ProcessMemUsagePeak` and `ProcessVMSize` show the memory consumption during execution of the phase in MB.

Examine these key metrics to understand the performance:

- `WallClockTime`—The real-time elapsed in each phase in seconds. Sum the `WallClockTime` in each phase to get the total time taken to perform the operation:

```
ElapsedTime = sum([statRpt.Statistics(:).WallClockTime]);
```

- `ProcessMemUsage`—The amount of memory consumed in each phase. Sum the `ProcessMemUsage` across all the phases to get the memory consumption during the entire operation:

```
TotalMemory = sum([statRpt.Statistics(:).ProcessMemUsage]);
```

- `ProcessMemUsagePeak`—The maximum amount of allocated memory in each phase. Get the maximum of this metric across all the phases to find the peak memory allocation during the operation:

```
PeakMemory = max([statRpt.Statistics(:).ProcessMemUsagePeak]);
```

Note Memory statistics are available only on the Microsoft Windows platform.

Examples

The following command counts and lists each type of block used in the `sldemo_bounce` model that comes with Simulink software.

```
sldiagnostics('sldemo_bounce', 'CountBlocks')
```

The following command counts and lists both the unique blocks and Stateflow objects used in the `sf_boiler` model that comes with Stateflow software; the textual report returned is captured as `myReport`.

```
myReport = sldiagnostics('sf_boiler', 'CountBlocks', 'CountSF')
```

The following commands open the `f14` model that comes with Simulink software, and counts the number of blocks used in the `Controller` subsystem.

```
sldiagnostics('f14/Controller', 'CountBlocks')
```

The following command runs the `Sizes` and `CompileStats` diagnostics on the `f14` model, capturing the results as both a textual report and structure array.

```
[txtRpt, sRpt] = sldiagnostics('f14', 'Sizes', 'CompileStats')
```

See Also

`find_system` | `get_param`

Introduced in R2006a

sldiagviewer.createStage

Create a stage to display diagnostic messages

Syntax

```
myStage = sldiagviewer.createStage(StageName)
myStage = sldiagviewer.createStage(__, 'modelName', Value)
```

Description

`myStage = sldiagviewer.createStage(StageName)` creates a stage with the given stage name in the model specified. In the Diagnostic Viewer, errors, warnings, and information messages are displayed in groups based on the operation, such as model load, simulation, and build. These groups are called stages. When you create a stage object, Simulink initializes the stage. When you close the stage object, Simulink ends the stage. If you delete a parent stage object, the corresponding parent and its child stage close in the Diagnostic Viewer.

`myStage = sldiagviewer.createStage(__, 'modelName', Value)` is a required name-value pair that specifies the model in which the diagnostics is run.

Examples

Create Stage and Display Diagnostic Messages

Use the `createStage` function to create a stage to display diagnostic messages in the Diagnostic Viewer.

```
% Create a stage to display all the messages
```

```
myStage = sldiagviewer.createStage('Analysis', 'modelName', 'vdp');
```

```
myStage =
    Stage with no properties.
```

Input Arguments

StageName — Name of stage

character vector

Name of the stage, specified as a character vector.

Example: 'Analysis'

Data Types: `string`

Value — Name of model

character vector

Name of model, specified as a comma-separated pair consisting of 'ModelName' and a character vector or string.

Example: 'vdp'

Output Arguments

myStage — Handle to created stage

stage object

Handle to the created stage, returned as a stage object.

See Also

Topics

“View Diagnostics”

“Customize Diagnostic Messages”

“Report Diagnostic Messages Programmatically”

Introduced in R2014a

sldiagviewer.diary

Log simulation warnings and errors and build information to file

Syntax

```
sldiagviewer.diary  
sldiagviewer.diary(filename)  
sldiagviewer.diary(toggle)  
sldiagviewer.diary(filename, 'UTF-8')
```

Description

`sldiagviewer.diary` intercepts build information, warnings, and errors transmitted to the Command Window or the Diagnostic Viewer and logs them to a text file `diary.txt` in the current folder.

`sldiagviewer.diary(filename)` toggles the logging state of the text file specified by `filename`.

`sldiagviewer.diary(toggle)` turns logging to the log file on or off. The setting applies to the last file name you specified for logging or to `diary.txt` if you did not specify a file name.

`sldiagviewer.diary(filename, 'UTF-8')` specifies the character encoding for the log file `filename`.

Examples

Log Build Information and Simulation Warnings and Errors

Start logging build information and simulation warnings and errors to `diary.txt`.

```
sldiagviewer.diary  
open_system('vdp')  
slbuild('vdp')
```

Open `diary.txt` to view logs.

```
### Starting build procedure for model: vdp  
### Build procedure for model: 'vdp' aborted due to an error.  
...
```

Log to Specific File

Set up logging to a file.

```
sldiagviewer.diary('C:\MyLogs\log1.txt')
```

Toggle File Logging State

Switch the logging state of a file.

```
sdiagviewer.diary('C:\MyLogs\log1.txt') % Start logging
open_system('vdp')
slbuild('vdp')

sdiagviewer.diary('off') % Switch off logging
open_system('sldemo_fuelsys')
slbuild('sldemo_fuelsys')

sdiagviewer.diary('on') % Resume logging
```

Specify Log File Name and Character Encoding

Set the file name to log to and the character encoding to use.

```
sdiagviewer.diary('C:\MyLogs\log1.txt', 'UTF-8')
```

Input Arguments

toggle — Logging state

'off' | 'on'

Logging state, specified as 'on' or 'off'.

Example: `sdiagviewer.diary('on')`

filename — Name of file to log data to

character vector

Name of file to log data to, specified as a character vector.

Example: `sdiagviewer.diary('C:\Simulations\mySimulationDiary.txt')`

See Also

Topics

“View Diagnostics”

“Customize Diagnostic Messages”

Introduced in R2014a

sldiagviewer.reportError

Report error messages in Diagnostic Viewer

Syntax

```
output = sldiagviewer.reportError(Message)
myStage = sldiagviewer.reportError(__, 'Component', Value)
```

Description

`output = sldiagviewer.reportError(Message)` reports the message as an error.

`myStage = sldiagviewer.reportError(__, 'Component', Value)` specifies the name of the component. For example, Stateflow or Model Advisor.

Examples

Report an Error Message

Create a stage and use the `reportError` function to report an error message in the Diagnostic Viewer for the specified model.

```
>> vdp >>
```

```
% Create a stage
my_stage = sldiagviewer.createStage('StageName', 'ModelName', 'vdp');
%% write some code inside try, which will throw an error
try
    i = p;
catch error
end
sldiagviewer.reportError(error);
```

```
output =
    logical
         1
```

The diagnostic window opens up for the model vdp. It shows the StageName and the error message

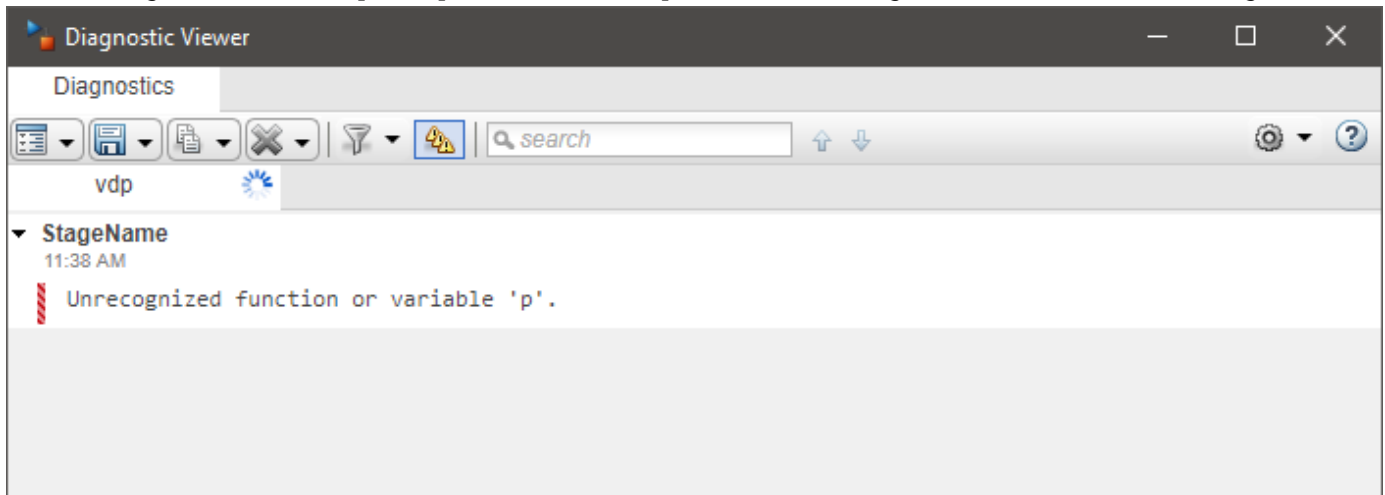

Input Arguments

Message — Message to be displayed

MSLException object | MException object | string

This message is displayed as an error in the Diagnostic Viewer.

Example: 'This is a custom error message.'

Value — Component name

character vector | string

The name of the component specified as the comma-separated pair consisting of 'Component' and a character vector or string.

Example: Stateflow

Output Arguments

output — shows the success or failure of the operation

logical

Shows whether the message was displayed successfully.

See Also

Topics

“View Diagnostics”

“Customize Diagnostic Messages”

“Report Diagnostic Messages Programmatically”

Introduced in R2014a

sldiagviewer.reportInfo

Report information messages in Diagnostic Viewer

Syntax

```
output = sldiagviewer.reportInfo(Message)
myStage = sldiagviewer.reportInfo(__, 'Component' Value)
```

Description

`output = sldiagviewer.reportInfo(Message)` reports the message as information.

`myStage = sldiagviewer.reportInfo(__, 'Component' Value)` specifies the name of the component.

Examples

Report an Information Message

Create a stage and use the `reportInfo` function to report a message as information in the Diagnostic Viewer for the specified model.

```
% Create a Stage to display all the messages
```

```
my_stage = sldiagviewer.createStage('Analysis', 'ModelName', 'vdp');
```

```
% Report a custom info message to Diagnostic Viewer
```

```
sldiagviewer.reportInfo('Information message.', 'Component', 'Stateflow');
```

```
output =
    logical
         1
```

Input Arguments

Message — Message to be displayed

MSLException object | MException object | string

This message is displayed in the Diagnostic Viewer as an information.

Example: 'This is a custom information message.'

Value — Component name

character vector | string

The name of the component specified as the comma-separated pair consisting of 'Component' and a character vector or string.

Example: Stateflow

Output Arguments

output — shows the success or failure of the operation
logical

Shows whether the message was displayed successfully.

See Also

Topics

“View Diagnostics”

“Customize Diagnostic Messages”

“Report Diagnostic Messages Programmatically”

Introduced in R2014a

sldiagviewer.reportWarning

Report warning messages in Diagnostic Viewer

Syntax

```
output = sldiagviewer.reportWarning(Message)
myStage = sldiagviewer.reportWarning(__, 'Component', Value)
```

Description

`output = sldiagviewer.reportWarning(Message)` reports a message as warning in the diagnostic Viewer.

`myStage = sldiagviewer.reportWarning(__, 'Component', Value)` specifies the name of the component. For example, Model Advisor or Stateflow.

Examples

Report a Warning in Diagnostic Viewer

Create a stage and use the `reportWarning` function to report a warning message in the Diagnostic Viewer for the specified model.

```
>> vdp

% Create a stage
my_stage = sldiagviewer.createStage('StageName', 'ModelName', 'vdp');
%% write some code inside try, which will throw an error
try
    i = p;
catch error
end
sldiagviewer.reportWarning(error);

output =
    logical
         1
```

The diagnostic window opens up for the model `vdp`. It shows the `StageName` and the warning message in yellow.

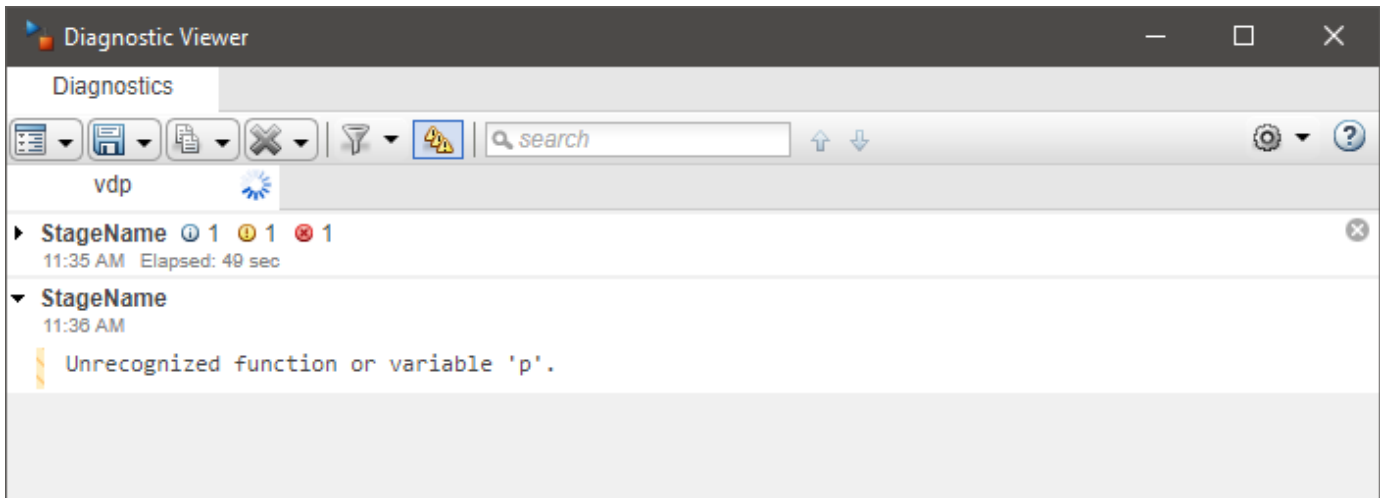

Input Arguments

Message — Message to display

MSLException object | MException object | string

This message is displayed as a warning in the Diagnostic Viewer.

Example: 'This is a custom warning message.'

Value — Component name

character vector | string

The name of the component specified as the comma-separated pair consisting of 'Component' and a character vector or string.

Example: Stateflow

Output Arguments

output — shows the success or failure of the operation

logical

Shows whether the message was displayed successfully.

See Also

Topics

“View Diagnostics”

“Customize Diagnostic Messages”

“Report Diagnostic Messages Programmatically”

Introduced in R2014a

sldiagviewer.reportSimulationMetadataDiagnostics

Display errors and warnings of simulation output object in Diagnostic Viewer

Syntax

```
sldiagviewer.reportSimulationMetadataDiagnostics(simOutputObject)
```

Description

`sldiagviewer.reportSimulationMetadataDiagnostics(simOutputObject)` displays errors and warnings of a simulation output object in the Diagnostic Viewer.

Examples

Display Errors and Warnings in Diagnostic Viewer

Simulate a model, place the `Simulink.SimulationOutput` object in `simOut`, and use the `reportSimulationMetadataDiagnostics` function to display errors and warnings in the Diagnostic Viewer.

Create a single `SimulationInput` object for the model.

```
>>vdp
set_param('vdp/Mu','Gain','z')
delete_line('vdp','Product/1','Mu/1');
model = 'vdp';
in = Simulink.SimulationInput(model);
```

Create an array of `SimulationInput` objects by using the `for` loop.

```
in(1:5) = in;
```

Simulate all the `SimulationInput` objects in the array to output the indices of the models with errors or warnings. The output is returned in a single `Simulink.SimulationOutput` object.

```
simOut = sim(in);
sldiagviewer.reportSimulationMetadataDiagnostics(simOut(1));
```

Open the Diagnostic Viewer to show errors and warnings in the first model of the `SimulationOutput` object.

```
sldiagviewer.reportSimulationMetadataDiagnostics(simOut(1));
```

Input Arguments

simOutputObject — Simulation output object containing errors and warnings
object

`Simulink.SimulationOutput` object containing errors and warnings that are generated when you simulate the model.

See Also

Topics

[“View Diagnostics”](#)

[“Customize Diagnostic Messages”](#)

[“Report Diagnostic Messages Programmatically”](#)

Introduced in R2020b

sldiscmdl

Discretize model that contains continuous blocks

Syntax

```
sldiscmdl('model_name',sample_time)
sldiscmdl('model_name',sample_time,method)
sldiscmdl('model_name',sample_time,options)
sldiscmdl('model_name',sample_time,method,freq)
sldiscmdl('model_name',sample_time,method,options)
sldiscmdl('model_name',sample_time,method,freq,options)
[old_blks,new_blks] = sldiscmdl('model_name',sample_time,method,freq,options)
```

Description

`sldiscmdl('model_name',sample_time)` discretizes the model named '*model_name*' using the specified *sample_time*. The model does not need to be open, and the units for *sample_time* are simulation seconds.

`sldiscmdl('model_name',sample_time,method)` discretizes the model using *sample_time* and the transform method specified by *method*.

`sldiscmdl('model_name',sample_time,options)` discretizes the model using *sample_time* and criteria specified by the *options* cell array. This array consists of four elements: {*target*, *replace_with*, *put_into*, *prompt*}.

`sldiscmdl('model_name',sample_time,method,freq)` discretizes the model using *sample_time*, *method*, and the critical frequency specified by *freq*. The units for *freq* are Hz. When you specify *freq*, *method* must be 'prewarp'.

`sldiscmdl('model_name',sample_time,method,options)` discretizes the model using *sample_time*, *method*, and *options*.

`sldiscmdl('model_name',sample_time,method,freq,options)` discretizes the model using *sample_time*, *method*, *freq*, and *options*. When you specify *freq*, *method* must be 'prewarp'.

`[old_blks,new_blks] = sldiscmdl('model_name',sample_time,method,freq,options)` discretizes the model using *sample_time*, *method*, *freq*, and *options*. When you specify *freq*, *method* must be 'prewarp'. The function also returns two cell arrays that contain full path names of the original, continuous blocks and the new, discretized blocks.

Input Arguments

model_name

Name of the model to discretize.

sample_time

Sample-time specification for the model:

| | |
|--------------------|--|
| Scalar value | Sample time with zero offset, such as 1 |
| Two-element vector | Sample time with nonzero offset, such as [1 0.1] |

method

Method of converting blocks from continuous to discrete mode:

| | |
|-----------------|--|
| 'zoh' (default) | Zero-order hold on the inputs |
| 'foh' | First-order hold on the inputs |
| 'tustin' | Bilinear (Tustin) approximation |
| 'prewarp' | Tustin approximation with frequency prewarping |
| 'matched' | Matched pole-zero method |

For single-input, single-output (SISO) systems only

freq

Critical frequency in Hz. This input applies only when the *method* input is 'prewarp'.

options

Cell array {*target*, *replace_with*, *put_into*, *prompt*}, where each element can take the following values:

| | | |
|---------------------|-----------------------|--|
| <i>target</i> | 'all' (default) | Discretize all continuous blocks |
| | 'selected' | Discretize only selected blocks in the model |
| | 'full_blk_path' | Discretize specified block |
| <i>replace_with</i> | 'parammask' (default) | Create discrete blocks whose parameters derive from the corresponding continuous blocks |
| | 'hardcoded' | Create discrete blocks with hard-coded parameters placed directly into each block dialog box |
| <i>put_into</i> | 'copy' (default) | Create discretization in a copy of the original model |
| | 'variant' | Create discretization candidate in a variant subsystem |
| | 'current' | Apply discretization to the current model |
| | 'untitled' | Create discretization in a new untitled window |
| <i>prompt</i> | 'on' (default) | Show discretization information at the command prompt |
| | 'off' | Do not show discretization information at the command prompt |

Examples

Discretize all continuous blocks in the `slexAircraftExample` model using a 1-second sample time:

```
openExample('slexAircraftExample');
sldiscmdl('slexAircraftExample',1);
```

Discretize the `Aircraft Dynamics Model` subsystem in the `slexAircraftExample` model using a 1-second sample time, a 0.1-second offset, and a first-order hold transform method:

```
sldiscmdl('slexAircraftExample',[1 0.1],'foh',...
{'slexAircraftExample/Aircraft Dynamics Model',...
'parammask','copy','on'});
```

Discretize the `Aircraft Dynamics Model` subsystem in the `slexAircraftExample` model and retrieve the full path name of the second discretized block:

```
[old_blks,new_blks] = sldiscmdl('slexAircraftExample',[1 0.1],...
'foh',{'slexAircraftExample/Aircraft Dynamics Model','parammask',...
'copy','on'});
% Get full path name of the second discretized block
new_blks{2}
```

Discretize all continuous blocks in the `slexAircraftExample` model using a 1-second sample time:

```
openExample('slexAircraftExample');
[old_blk,new_blk] = sldiscmdl('f14',1,'zoh',...
{'f14/Aircraft Dynamics Model',...
'parammask','variant','on'})
```

--discretizing 'f14/Aircraft Dynamics Model' and putting results into a variant subsystem

```
old_blk =
```

```
    1x1 cell array
```

```
    {'f14/Aircraft Dynamics Model'}
```

```
new_blk =
```

```
    1x1 cell array
```

```
    {'f14/Aircraft↔Dynamics↔Model'}
```

See Also

`sldmdliscui`

Topics

“Aircraft Longitudinal Flight Control” on page 13-224

“Discretize a Model with the `sldiscmdl` Function”

Introduced before R2006a

slEditToolstripAction

Open file that defines custom Simulink Toolstrip action

Syntax

```
slEditToolstripAction(action)
```

Description

`slEditToolstripAction(action)` opens the file that defines the specified custom toolstrip action.

Examples

Edit Custom Toolstrip Action

Suppose you have many JSON files that define actions for a custom tab in a toolstrip component named `custom`.

To open the file that defines a custom action, such as `myAction`, use the `slEditToolstripAction` function.

```
slEditToolstripAction("custom:myAction")
```

Input Arguments

action — Fully qualified action name

character vector | string scalar

Fully qualified action name, specified as a character vector or string scalar. The fully qualified name is the name of the toolstrip component followed by a colon and the full path to the action within the toolstrip component.

When an action is defined at the top level of a toolstrip component, the fully qualified action name consists of these parts:

- 1 Name of the toolstrip component followed by a colon
- 2 Action ID

When an action is defined in the JSON object for a control, the action does not use an action ID. The fully qualified action name consists of these parts:

- 1 Name of the toolstrip component followed by a colon
- 2 Tab ID followed by a forward slash
- 3 Section ID or index followed by a forward slash
- 4 Column ID or index followed by a forward slash

5 Control ID or index

Example: `slEditToolstripAction("custom:myAction")` opens the file that defines `myAction` for the custom toolstrip component.

Example: `slEditToolstripAction("custom:customTab/2/1/3")` opens the file that defines the action for the third control in the first column of the second section on the tab named `customTab` in the custom toolstrip component.

Data Types: `char` | `string`

See Also

`slCreateToolstripComponent` | `slReloadToolstripConfig` | `slEditToolstripCommand` | `slEditToolstripIcon` | `slEditToolstripWidget`

Topics

“Create Custom Simulink Toolstrip Tabs”

“Add Prepopulated Custom Tab to Simulink Toolstrip”

Introduced in R2021b

slEditToolstripCommand

Open file that defines custom Simulink Toolstrip command

Syntax

```
slEditToolstripCommand(action)
```

Description

`slEditToolstripCommand(action)` opens the file that defines the custom Simulink Toolstrip command.

For scripts, the file that defines the action also defines the command. When you set `commandType` to `Script`, the `command` property directly specifies the script. When you set the `command` property to the name of a script on the MATLAB path, the function opens the JSON file, not the referenced MATLAB script.

Examples

Edit Custom Toolstrip Command

Suppose you have many files that define commands for a custom tab in a toolstrip component named `custom`.

To open the file that defines a command for an action, such as `myAction`, use the `slEditToolstripCommand` function.

```
slEditToolstripCommand("custom:myAction");
```

Input Arguments

action — Fully qualified action name

character vector | string scalar

Fully qualified action name, specified as a character vector or string scalar. The fully qualified name is the name of the toolstrip component followed by a colon and the full path to the action within the toolstrip component.

When an action is defined at the top level of a toolstrip component, the fully qualified action name consists of these parts:

- 1 Name of the toolstrip component followed by a colon
- 2 Action ID

When an action is defined in the JSON object for a control, the action does not use an action ID. The fully qualified action name consists of these parts:

- 1 Name of the toolstrip component followed by a colon

- 2 Tab ID followed by a forward slash
- 3 Section ID or index followed by a forward slash
- 4 Column ID or index followed by a forward slash
- 5 Control ID or index

Example: `slEditToolstripCommand("custom:myAction")` opens the file that defines `myAction` for the custom toolstrip component.

Example: `slEditToolstripCommand("custom:customTab/2/1/3")` opens the file that defines the command for the third control in the first column of the second section on the tab named `customTab` in the custom toolstrip component.

Data Types: `char` | `string`

See Also

`slCreateToolstripComponent` | `slReloadToolstripConfig` | `slEditToolstripAction` | `slEditToolstripIcon` | `slEditToolstripWidget`

Topics

“Create Custom Simulink Toolstrip Tabs”

“Add Prepopulated Custom Tab to Simulink Toolstrip”

Introduced in R2021b

slEditToolstripIcon

Open file that defines custom Simulink Toolstrip icon

Syntax

```
slEditToolstripIcon(icon)
```

Description

slEditToolstripIcon(icon) opens the file that defines the specified custom toolstrip icon.

Examples

Edit Custom Toolstrip Icon

Suppose you have many JSON files that define icons for a custom tab in a toolstrip component named `custom`.

To open the file that defines a custom icon, such as `myIcon`, use the `slEditToolstripIcon` function.

```
slEditToolstripIcon("custom:myIcon");
```

Input Arguments

icon — Fully qualified icon name

character vector | string scalar

Fully qualified icon name, specified as a character vector or string scalar. The fully qualified name is the name of the toolstrip component followed by a colon and the full path to the icon within the toolstrip component.

When an icon is defined at the top level of a toolstrip component, the fully qualified icon name consists of these parts:

- 1 Name of the toolstrip component followed by a colon
- 2 Icon ID

When an icon is defined in the JSON object for a top-level action, the fully qualified icon name consists of these parts:

- 1 Name of the toolstrip component followed by a colon
- 2 Action ID

When an icon is defined in the JSON object for a nested action, the fully qualified icon name consists of these parts:

- 1 Name of the toolstrip component followed by a colon

- 2** Tab ID followed by a forward slash
- 3** Section ID or index followed by a forward slash
- 4** Column ID or index followed by a forward slash
- 5** Control ID or index

Example: `slEditToolstripIcon("custom:myIcon")` opens the file that defines `myIcon` for the `custom` toolstrip component.

Example: `slEditToolstripIcon("custom:customTab/2/1/3")` opens the file that defines the icon for the third control in the first column of the second section on the tab named `customTab` in the `custom` toolstrip component.

Data Types: `char` | `string`

See Also

`slCreateToolstripComponent` | `slReloadToolstripConfig` | `slEditToolstripAction` | `slEditToolstripCommand` | `slEditToolstripWidget`

Topics

“Create Custom Simulink Toolstrip Tabs”

“Add Prepopulated Custom Tab to Simulink Toolstrip”

Introduced in R2021b

sLEditToolstripWidget

Open file that defines custom Simulink Toolstrip tab, section, column, or control

Syntax

```
sLEditToolstripWidget(widget)
```

Description

`sLEditToolstripWidget(widget)` opens the file that defines the specified custom toolstrip widget, which can be a custom tab, section, column, or control.

Examples

Edit Custom Toolstrip Widget

Suppose you have multiple JSON files that define custom tabs in a toolstrip component named `custom`.

To open the file that defines a custom tab named `customTab`, use the `sLEditToolstripWidget` function.

```
sLEditToolstripWidget("custom:customTab")
```

Input Arguments

widget — Fully qualified widget name

character vector | string scalar

Fully qualified widget name, specified as a character vector or string scalar. The fully qualified name is the name of the toolstrip component followed by a colon and the full path to the widget within the toolstrip component. When the widget has a parent JSON object, the fully qualified name includes the ID or index of each JSON object above the widget.

Example: `sLEditToolstripWidget("custom:customTab")` opens the file that defines the tab named `customTab` in the `custom` toolstrip component.

Example: `sLEditToolstripWidget("custom:customTab/2")` opens the file that defines the second section on the tab named `customTab` in the `custom` toolstrip component.

Example: `sLEditToolstripWidget("custom:customTab/2/1")` opens the file that defines the first column of the second section on the tab named `customTab` in the `custom` toolstrip component.

Example: `sLEditToolstripWidget("custom:customTab/2/1/3")` opens the file that defines the third control in the first column of the second section on the tab named `customTab` in the `custom` toolstrip component.

Data Types: char | string

See Also

`slCreateToolstripComponent` | `slReloadToolstripConfig` | `slEditToolstripAction` | `slEditToolstripCommand` | `slEditToolstripIcon`

Topics

“Create Custom Simulink Toolstrip Tabs”

“Add Prepopulated Custom Tab to Simulink Toolstrip”

Introduced in R2021b

slExportFavoriteCommands

Export favorite commands from Simulink quick access toolbar

Syntax

```
slExportFavoriteCommands(file)
```

Description

`slExportFavoriteCommands(file)` exports the contents of the Simulink **Favorite Commands** gallery to the specified file.

Examples

Export Simulink Favorite Commands

Suppose you create a set of favorite commands in the Simulink **Favorite Commands** gallery that you want to share with team members. You can export the contents of your Simulink **Favorite Commands** gallery to a file.

For example, export the gallery contents to a file named `slFavorites.mat` in the `B:\path\` directory.

In the MATLAB Command Window, enter:

```
slExportFavoriteCommands('B:\path\slFavorites.mat');
```

Input Arguments

file — File name or path

character vector | string scalar

File name or path, including a `.mat` file extension, specified as a character vector or string scalar.

Example: `slExportFavoriteCommands('B:\path\slFavorites.mat')`

Data Types: `char` | `string`

See Also

`slImportFavoriteCommands` | `slResetFavoriteCommands`

Topics

“Access Frequently Used Features and Commands in Simulink”

Introduced in R2021b

slexpr

Generate expression to use in value of parameter object

Syntax

```
expressionOut = slexpr(expressionIn)
```

Description

`expressionOut = slexpr(expressionIn)` converts the MATLAB-syntax expression `expressionIn` to an object, `expressionOut`, that you can use to set the `Value` property of a parameter object (such as `Simulink.Parameter`). When you use multiple parameter objects to set block parameter values, you can use the expression to model mathematical relationships between the objects. For more information, see “Set Variable Value by Using a Mathematical Expression”.

Examples

Model Relationship Between Mass, Length, and Moment of Inertia of Metronome

In the base workspace, create three `Simulink.Parameter` objects that represent the mass, length, and moment of inertia of a pointlike metronome.

```
m = Simulink.Parameter;  
r = Simulink.Parameter;  
J = Simulink.Parameter;
```

Set the mass to 0.1 kg and the length to 1.0 m.

```
m.Value = 0.1;  
r.Value = 1.0;
```

Set the value of the moment of inertia to the mass times the square of the length.

```
J.Value = slexpr('m*r^2');
```

Simulink preserves the expression, $m*r^2$. If you change the value of the mass or the length, Simulink recalculates the value of the moment of inertia.

Input Arguments

expressionIn — Target expression

string | character vector

Target expression, specified as a string or character vector.

Example: "myParam + myOtherParam"

Data Types: char | string

Output Arguments

expressionOut — Simulink representation of expression

`Simulink.data.Expression` object

Simulink representation of the target expression, returned as a `Simulink.data.Expression` object. A `Simulink.data.Expression` object has no use outside the `Value` property of a parameter object.

See Also

`Simulink.Parameter`

Topics

“Share and Reuse Block Parameter Values by Creating Variables”

“Create Tunable Calibration Parameter in the Generated Code” (Simulink Coder)

Introduced in R2018a

slImportFavoriteCommands

Import favorite commands to Simulink quick access toolbar

Syntax

```
backup = slImportFavoriteCommands(file)
backup = slImportFavoriteCommands(file,'overwrite')
```

Description

`backup = slImportFavoriteCommands(file)` imports favorite commands and categories from the specified file to the Simulink **Favorite Commands** gallery.

`backup = slImportFavoriteCommands(file,'overwrite')` overwrites the contents of the Simulink **Favorite Commands** gallery with the contents of the specified file.

Examples

Import Simulink Favorite Commands

Suppose a team member shares a file that contains favorite commands you want to use in Simulink, and you want to merge the file contents with the contents of your Simulink **Favorite Commands** gallery.

In the MATLAB Command Window, enter:

```
slImportFavoriteCommands('B:\path\slFavorites.mat');
```

Overwrite Simulink Favorite Commands

Suppose a team member shares a file that contains favorite commands you want to use in Simulink, and you want to overwrite the contents of your Simulink **Favorite Commands** gallery with the file contents.

In the MATLAB Command Window, enter:

```
slImportFavoriteCommands('B:\path\slFavorites.mat','overwrite');
```

Input Arguments

file — File name or path

character vector | string scalar

File name or path, including a `.mat` file extension, specified as a character vector or string scalar.

Example: `slImportFavoriteCommands('B:\path\slFavorites.mat')`

Data Types: `char` | `string`

Output Arguments

backup — Backup of previous state

character vector

Backup of previous state, returned as a character vector.

To restore the previous state, you can pass the returned value as the input to the function and overwrite the current state.

See Also

[slExportFavoriteCommands](#) | [slResetFavoriteCommands](#)

Topics

“Access Frequently Used Features and Commands in Simulink”

Introduced in R2021b

slIsFileChangedOnDisk

Determine whether model has changed since it was loaded

Syntax

```
tf = slIsFileChangedOnDisk(sys)
```

Description

`tf = slIsFileChangedOnDisk(sys)` returns whether the file that contains block diagram `sys` has changed on disk since the block diagram was loaded.

Examples

Return Error When File Has Changed

To ensure that code is not generated for a model whose file has changed on disk since it was loaded, include the following in the 'entry' section of the `STF_make_rtw_hook.m` file.

```
if (slIsFileChangedOnDisk(sys))  
    error('File has changed on disk since it was loaded. Aborting code generation.');
```

For more information, see “Customize Build Process with STF_make_rtw_hook File” (Simulink Coder).

Input Arguments

sys — System name

character vector | string scalar

System name, specified as a character vector or string scalar.

Data Types: `char` | `string`

Output Arguments

tf — True or false result

1 | 0

True or false result, returned as a 1 or 0 of data type `logical`.

- 1 (`true`) — File that contains block diagram `sys` has changed on disk since the block diagram was loaded.
- 0 (`false`) — File that contains block diagram `sys` has not changed on disk since the block diagram was loaded.

See Also

Topics

“Customize Build Process with STF_make_rtw_hook File” (Simulink Coder)

“Model File Change Notification”

Introduced in R2007b

sLibraryBrowser

Open Simulink Library Browser

Syntax

```
sLibraryBrowser  
sLibraryBrowser('open')  
sLibraryBrowser('noshow')  
libraryhandle = sLibraryBrowser  
sLibraryBrowser('close')
```

Description

sLibraryBrowser opens the Simulink Library Browser.

If you want to load the Simulink block library, use `load_system simulink` instead.

If you want to start Simulink without opening any windows, use the faster `start_simulink` instead.

sLibraryBrowser('open') opens the Library Browser.

sLibraryBrowser('noshow') loads the Library Browser in memory without making it visible. Use this to make future calls to sLibraryBrowser('open') faster.

libraryhandle = sLibraryBrowser returns the handle of the Library Browser object.

sLibraryBrowser('close') closes the Library Browser.

Examples

Open and Close Library Browser

```
sLibraryBrowser  
sLibraryBrowser('close')
```

Load Library Browser and Get Handle

```
libraryhandle = sLibraryBrowser('noshow')
```

Compatibility Considerations

LibraryBrowser.LBStandalone object replaces LibraryBrowser.LibraryBrowser2 object
Behavior changed in R2016b

In previous releases, these two commands returned a LibraryBrowser.LibraryBrowser2 object:

```
lb = sLibraryBrowser  
lb = LibraryBrowser.LibraryBrowser2
```

Starting in R2016b, each command returns a `LibraryBrowser.LBStandalone` object. The functions to access Library Browser operations such as `show` and `refresh` support `LibraryBrowser.LBStandalone` objects.

See Also

Functions

`simulink` | `start_simulink`

Tools

Library Browser

Objects

`LibraryBrowser.LBStandalone`

Topics

“Build and Edit a Model Interactively”

Introduced in R2016a

slLoadedToolstripComponents

Find loaded custom Simulink Toolstrip components

Syntax

```
components = slLoadedToolstripComponents
```

Description

`components = slLoadedToolstripComponents` returns the name, path, and persistence of loaded custom Simulink Toolstrip components.

Examples

Remove Custom Tab by Finding Loaded Custom Simulink Toolstrip Components

Suppose you have a custom tab that you want to remove from the Simulink Toolstrip.

Find the loaded custom Simulink Toolstrip components. In the MATLAB Command Window, enter:

```
components = slLoadedToolstripComponents
```

```
components =
```

```
    1×2 struct array with fields:
```

```
    name  
    path  
    persisted
```

The function finds two loaded components.

Get information about the first component.

```
components(1)
```

```
ans =
```

```
    struct with fields:
```

```
    name: 'tools'  
    path: 'B:\path\components\tools'  
    persisted: 0
```

The function returns the name (`tools`), path (`B:\path\components\tools`), and persistence (`0`) of the component. This component does not persist across MATLAB sessions.

Get information about the second component.

```
components(2)
```



```
ans =
    struct with fields:
        name: 'custom'
        path: 'B:\path\customtab'
        persisted: 1
```

The function returns the name (`custom`), path (`B:\path\customtab`), and persistence (`1`) of the component. This component persists across MATLAB sessions.

Inspect the JSON files in the `B:\path\customtab\resources\json` folder of the second component to determine whether the second component defines the custom tab you want to remove. Also check whether the component defines custom tabs that you want to keep.

Remove the custom tab by performing one of these actions:

- Remove the parent folder of the `resources` folder from the MATLAB path.
- Stop the custom Simulink Toolstrip component from persisting across MATLAB sessions by using the `slPersistToolstripComponent` function.
- Rename the `resources` folder to prevent it from being found.
- Edit the JSON file that defines the custom tab.
- Destroy the custom Simulink Toolstrip component by using the `slDestroyToolstripComponent` function.

Then, reload the toolstrip configuration.

```
slReloadToolstripConfig;
```

Output Arguments

components — Name, path, and persistence of loaded components

structure array

Name, path, and persistence of loaded components, returned as a structure array.

See Also

`slCreateToolstripComponent` | `slDestroyToolstripComponent` | `slPersistToolstripComponent`

Topics

“Create Custom Simulink Toolstrip Tabs”

“Add Prepopulated Custom Tab to Simulink Toolstrip”

Introduced in R2021b

slmdliscui

Open Model Discretizer GUI

Syntax

```
slmdliscui  
slmdliscui('model')
```

Description

`slmdliscui` opens the Model Discretizer. A model does not need to be open.

`slmdliscui('model')` opens the Model Discretizer for the model or library called '*name*'.

To use the Model Discretizer, you must have a Control System Toolbox license, version 5.2 or later.

Examples

Open the Model Discretizer for the `slexAircraftExample` model:

```
openExample('slexAircraftExample');  
slmdliscui('slexAircraftExample')
```

Open the Model Discretizer for the `discretizing` library:

```
slmdliscui('discretizing')
```

See Also

`sldiscmdl`

Topics

"Aircraft Longitudinal Flight Control" on page 13-224

"Discretize a Model with the Model Discretizer"

Introduced before R2006a

slPersistToolstripComponent

Specify whether custom Simulink Toolstrip component persists across MATLAB sessions

Syntax

```
slPersistToolstripComponent(component,persistence)
```

Description

`slPersistToolstripComponent(component,persistence)` specifies whether to add the path for the specified custom Simulink Toolstrip component to the list of paths to restore for each MATLAB session.

Examples

Remember Custom Simulink Toolstrip Component Across Sessions

Suppose you create a custom tab that you want to remain in the Simulink Toolstrip the next time you open Simulink.

Specify that the component persists in future MATLAB sessions. For example, specify that a component named `custom` persists across sessions. In the MATLAB Command Window, enter:

```
slPersistToolstripComponent("custom",true);
```

Input Arguments

component — Name of component to persist across sessions

character vector | string scalar

Name of the component to persist across sessions, specified as a character vector or string scalar.

Data Types: `char` | `string`

persistence — Option for component to persist across sessions

`true` | `false`

Option for component to persist across sessions, specified as `true` or `false`.

Data Types: `logical`

See Also

`slCreateToolstripComponent` | `slDestroyToolstripComponent` | `slLoadedToolstripComponents`

Topics

“Create Custom Simulink Toolstrip Tabs”

“Add Prepopulated Custom Tab to Simulink Toolstrip”

Introduced in R2021b

slprofreport

(Not recommended) Regenerate profiler report from data, ProfileData, saved from previous run

Syntax

```
slprofreport(model_nameProfileData)
```

Description

When you run a model with the profiler enabled, the simulation generates the data and saves it in the variable, `model_nameProfileData`. `slprofreport(model_nameProfileData)` generates a profiler report based on the data in `model_nameProfileData`, saved from the model run.

Input Arguments

ProfileData

Variable containing profiler data from a model run. The variable name consists of the model name and ProfileData, for example, `vdpProfileData`.

Default: None

Examples

Regenerate Simulink Profiler Results

Regenerate the Profiler report for model `vdp`

In the MATLAB Command Window, start the `vdp` model.

In the Simulink editor window, run `vdp` model with Simulink Profiler enabled.

Simulink stores the data to the variable `vdpProfileData`.

To review the report, in the MATLAB Command Window

```
slprofreport(vdpProfileData)
```

The Simulink Profiler Report window is displayed.

Compatibility Considerations

slprofreport is not recommended

Not recommended starting in R2020a

Starting in R2020a, the `slprofreport` function is no longer recommended to load saved **Simulink Profiler** reports. The reports are saved to a MAT file and can be directly loaded into the current workspace.

For profiling reports saved before R2019b, you can use the `slprofreport` function to load the report.

See Also

Topics

“Save Profiler Results”

“How Profiler Captures Performance Data”

Introduced in R2012a

slproject.create

(Not recommended) Create blank project

Note `slproject.create` is not recommended. Use `matlab.project.createProject` instead. For more information, see “Compatibility Considerations”.

Syntax

```
proj = slproject.create
proj = slproject.create(path)
proj = slproject.create(name)
```

Description

`proj = slproject.create` creates and opens a project using the blank project template from the Simulink start page, and returns a project object. Use the project object to manipulate the currently open project at the command line. The new project is created in the default project folder. To change the default folder for new projects, on the MATLAB Home tab, click **Preferences**. In the Preferences dialog box, on the MATLAB Project pane, set the **Default folder**.

`proj = slproject.create(path)` creates the project at the location specified by path.

`proj = slproject.create(name)` creates the project in the default folder, with the name specified by name.

Examples

Create a Blank Project in the Default Folder

```
slproject.create
```

You can control the default folder for new projects using the project preferences.

Create a Blank Project in a Specified Folder

```
proj = slproject.create('C:\work\myprojectname');
```

Create a Named Blank Project in the Default Folder

```
proj = slproject.create('myprojectname');
```

Input Arguments

path — Path for the new project location

character vector

Path for the new project location, specified as a character vector. If you do not specify the path, `slproject.create` creates the project in the default location. You can change the default location in the project preferences.

Example: `C:\work\projectname`

Data Types: `char`

name — Name for the new project

character vector

Name for the new project, specified as a character vector.

Example: `myproject`

Data Types: `char`

Output Arguments

proj — Project

project object

Project, returned as a project object. Use the project object to manipulate the currently open project at the command line.

Properties of `proj` output argument.

| Project Property | Description |
|-------------------------|--|
| Name | Project name |
| Information | Information about the project such as the description, source control integration, repository location, and whether it is a top-level project. |
| Dependencies | Dependencies between project files in a MATLAB digraph object. |
| Shortcuts | Shortcut files in the project. |
| ProjectPath | Folders that the project puts on the MATLAB path. |
| ProjectReferences | Folders that contain referenced projects. Contains read-only project objects for referenced projects. |
| Categories | Categories of project labels. |
| Files | Paths and names of project files. |
| RootFolder | Full path to project root folder. |

Compatibility Considerations

Simulink project API is not recommended

Not recommended starting in R2019a

Starting in R2019a, instead of `simulinkproject` and related functions, use the `currentProject` or `openProject` functions in MATLAB. The Simulink project API will continue to be supported, but,

after R2019a, new features will be available only if you use the new MATLAB project API. There are no plans to remove the Simulink project API at this time.

You can continue to use `simulinkproject` and related functions listed in `methods(simulinkproject)`. New functions added after R2019a, such as `runChecks` and `listImpactedFiles`, do not work with `simulinkproject`. Use `currentProject` instead.

The new MATLAB project API is part of the R2019a functionality enabling you to use projects in MATLAB, with or without Simulink. You can now share projects with users who do not have Simulink.

See Also

`matlab.project.createProject` | `Simulink.createFromTemplate` | `addFile` | `addPath` | `addFolderIncludingChildFiles` | `addReference` | `addShortcut`

Topics

“Create and Reference a Project Programmatically” on page 13-515

“Automate Project Tasks Using Scripts”

Introduced in R2017a

slproject.getCurrentProject

(To be removed) Manipulate current project at command line

Note `slproject.getCurrentProject` will be removed in a future release. Use `currentProject` instead.

Syntax

```
proj = slproject.getCurrentProject
```

Description

`proj = slproject.getCurrentProject` gets the current project open in the Project Tool and returns a project object `proj` that you can use to manipulate the project programmatically. If no project is open, then you see an error.

Note `slproject.getCurrentProject` is replaced by `slproject.getCurrentProjects`.

Examples

Get Airframe Example Project

Open the Airframe project and use `slproject.getCurrentProject` to get a project object to manipulate the project at the command line.

```
sldemo_slproject_airframe  
proj = slproject.getCurrentProject
```

```
proj =
```

```
  ProjectManager with properties:
```

```
      Name: 'Simulink Project Airframe Example'  
      Categories: [1x1 slproject.Category]  
      Shortcuts: [1x8 slproject.Shortcut]  
      ProjectPath: [1x7 slproject.PathFolder]  
      ProjectReferences: [1x0 slproject.ProjectReference]  
      Files: [1x30 slproject.ProjectFile]  
      RootFolder: 'C:\Work\Simulink\Projects\slexamples\airframe'
```

Output Arguments

proj – Project

project object

Project, returned as a project object. Use the project object to manipulate the currently open project at the command line.

See Also

Functions

`currentProject` | `simulinkproject` | `slproject.getCurrentProjects` | `slproject.loadProject`

Introduced in R2013a

slproject.getCurrentProjects

(Not recommended) List all top-level projects

Note `slproject.getCurrentProjects` is not recommended. Use `matlab.project.rootProject` instead. For more information, see “Compatibility Considerations”.

Syntax

```
projects = slproject.getCurrentProjects
```

Description

`projects = slproject.getCurrentProjects` returns a list of all open top-level projects. Currently only one or zero top-level projects can be loaded. Returns an object array of 1 or 0 `ProjectManager` objects `projects` that you can use to manipulate the project programmatically. Use `slproject.getCurrentProjects` for project automation scripts.

If you execute `slproject.getCurrentProjects` inside a project shortcut, it returns only the project that the shortcut belongs to. If the shortcut belongs to a referenced project, it returns the referenced project.

Examples

Get Airframe Example Project

Open the Airframe project and use `slproject.getCurrentProjects` to get a project object to manipulate the project at the command line.

```
sldemo_slproject_airframe
proj = slproject.getCurrentProjects
```

```
proj =
```

```
ProjectManager with properties:
```

```
    Name: 'Simulink Project Airframe Example'
    Categories: [1x1 slproject.Category]
    Shortcuts: [1x8 slproject.Shortcut]
    ProjectPath: [1x7 slproject.PathFolder]
    ProjectReferences: [1x0 slproject.ProjectReference]
    Files: [1x30 slproject.ProjectFile]
    RootFolder: 'C:\Work\Simulink\Projects\airframe'
```

Find Project Commands

Open the airframe project and create a project object.

```

sldemo_slproject_airframe
proj = slproject.getCurrentProject

proj =

  ProjectManager with properties:

    Name: 'Simulink Project Airframe Example'
    Categories: [1x1 slproject.Category]
    Shortcuts: [1x8 slproject.Shortcut]
    ProjectPath: [1x7 slproject.PathFolder]
    ProjectReferences: [1x0 slproject.ProjectReference]
    Files: [1x30 slproject.ProjectFile]
    RootFolder: 'C:\Work\Simulink\Projects\airframe'

```

Find out what you can do with your project.

```
methods(proj)
```

```
Methods for class slproject.ProjectManager:
```

```

addFile                findCategory
addFolderIncludingChildFiles findFile
close                  isLoaded
createCategory         listModifiedFiles
export                  refreshSourceControl

```

```

reload
removeCategory
removeFile

```

Examine Project Properties

After you get a project object, you can examine project properties.

Open the airframe project and create a project object.

```

sldemo_slproject_airframe
proj = slproject.getCurrentProjects;

```

Examine the project files.

```
files = proj.Files
```

```
files =
```

```
1x30 ProjectFile array with properties:
```

```

  Path
  Labels
  Revision
  SourceControlStatus

```

Examine the labels of the eighth file.

```
proj.Files(8).Labels
```

```
ans =

    Label with properties:

    File: 'C:\Work\airframe\data\system_model.sldd'
         Data: []
         DataType: 'none'
         Name: 'Design'
         CategoryName: 'Classification'
```

Get a particular file.

```
myfile = findFile(proj, 'models/AnalogControl.slx')
```

```
myfile =
```

```
    ProjectFile with properties:

    Path: 'C:\Temp\airframe\models\AnalogControl.slx'
    Labels: [1x1 slproject.Label]
    Revision: '2'
    SourceControlStatus: Unmodified
```

Find out what you can do with the file.

```
methods(myfile)
```

```
Methods for class slproject.ProjectFile:
```

```
addLabel
removeLabel
findLabel
```

Output Arguments

projects – Projects

object array of 1 or 0 ProjectManager objects

Projects, returned as an object array of 1 or 0 ProjectManager objects. Use the project object to manipulate the currently open project at the command line.

Properties of ProjectManager objects in output argument.

| Project Property | Description |
|-------------------|--|
| Name | Project name |
| Categories | Categories of project labels |
| Shortcuts | Shortcut files in project |
| ProjectPath | Folders that the project puts on the MATLAB path |
| ProjectReferences | Folders that contain referenced projects |
| Files | Paths and names of project files |
| RootFolder | Full path to project root folder |

Tips

Alternatively, you can use `simulinkproject` to get a project object, but `simulinkproject` also opens and gives focus to the Project Tool. Use `simulinkproject` to open projects and explore projects interactively. Use `slproject.getCurrentProjects` for project automation scripts.

Compatibility Considerations

Simulink project API is not recommended

Not recommended starting in R2019a

Starting in R2019a, instead of `simulinkproject` and related functions, use the `currentProject` or `openProject` functions in MATLAB. The Simulink project API will continue to be supported, but, after R2019a, new features will be available only if you use the new MATLAB project API. There are no plans to remove the Simulink project API at this time.

You can continue to use `simulinkproject` and related functions listed in `methods(simulinkproject)`. New functions added after R2019a, such as `runChecks` and `listImpactedFiles`, do not work with `simulinkproject`. Use `currentProject` instead.

The new MATLAB project API is part of the R2019a functionality enabling you to use projects in MATLAB, with or without Simulink. You can now share projects with users who do not have Simulink.

See Also

Functions

`matlab.project.rootProject` | `simulinkproject` | `slproject.loadProject` | `slproject.getCurrentProject`

Introduced in R2016a

slproject.loadProject

(Not recommended) Load project

Note `simulinkproject` is not recommended. Use `currentProject` or `openProject` instead. For more information, see “Compatibility Considerations”.

Syntax

```
slproject.loadProject(projectPath);  
proj = slproject.loadProject(projectPath)
```

Description

`slproject.loadProject(projectPath)`; loads the project specified by the `.prj` file or folder `projectPath` in the Project Tool, and closes any currently open project.

`proj = slproject.loadProject(projectPath)` loads the project and returns a project object `proj` for manipulating the project. Use `slproject.loadProject` for project automation scripts.

Examples

Load Project

Load a project from a folder called 'C:/projects/project1/'. Replace this path with the location of your project.

```
proj = slproject.loadProject('C:/projects/project1/')
```

Get Airframe Example Project

Open the Airframe project and use `slproject.getCurrentProjects` to get a project object to manipulate the project at the command line.

```
sldemo_slproject_airframe  
proj = slproject.getCurrentProjects
```

```
proj =
```

```
  ProjectManager with properties:
```

```
    Name: 'Simulink Project Airframe Example'  
    Categories: [1x1 slproject.Category]  
    Shortcuts: [1x8 slproject.Shortcut]  
    ProjectPath: [1x7 slproject.PathFolder]  
    ProjectReferences: [1x0 slproject.ProjectReference]
```



```
Files: [1x30 slproject.ProjectFile]
RootFolder: 'C:\Work\Simulink\Projects\airframe'
```

Find Project Commands

Get the Airframe project.

```
sldemo_slproject_airframe
proj = slproject.getCurrentProjects;
```

Find project commands.

```
methods(proj)
```

Methods for class slproject.ProjectManager:

```
addFile                findCategory
addFolderIncludingChildFiles  findFile
close                  isLoading
createCategory         listModifiedFiles
export                 refreshSourceControl
```

```
reload
removeCategory
removeFile
```

Examine Project Properties

After you get a project object, you can examine project properties.

Get the airframe project.

```
sldemo_slproject_airframe
proj = slproject.getCurrentProjects;
```

Examine the project files.

```
files = proj.Files
```

```
files =
```

```
1x30 ProjectFile array with properties:
```

```
Path
Labels
Revision
SourceControlStatus
```

Examine the labels of the 13th file.

```
proj.Files(13).Labels
```

```
ans =
```

Label with properties:

```
File: 'C:\Temp\airframe\models\AnalogControl.slx'
  Data: []
  DataType: 'none'
  Name: 'Design'
  CategoryName: 'Classification'
```

Get a particular file by name.

```
myfile = findFile(proj, 'models/AnalogControl.slx')
```

```
myfile =
```

ProjectFile with properties:

```
Path: 'C:\Temp\airframe\models\AnalogControl.slx'
Labels: [1x1 slproject.Label]
Revision: '2'
SourceControlStatus: Unmodified
```

Find out what you can do with the file.

```
methods(myfile)
```

Methods for class slproject.ProjectFile:

```
addLabel
removeLabel
findLabel
```

Input Arguments

projectPath — Full path to project file or folder

character vector

Full path to project .prj file or the path to the project root folder, specified as a character vector.

Example: 'C:/projects/project1/myProject.prj'

Example: 'C:/projects/project1/'

Output Arguments

proj — Project

project object

Project, returned as a project object. Use the project object to manipulate and explore the project at the command line.

Properties of proj output argument.

| Project Property | Description |
|------------------|------------------------------|
| Name | Project name |
| Categories | Categories of project labels |

| Project Property | Description |
|-------------------|--|
| Shortcuts | Shortcut files in project |
| ProjectPath | Folders that the project puts on the MATLAB path |
| ProjectReferences | Folders that contain referenced projects |
| Files | Paths and names of project files |
| RootFolder | Full path to project root folder |

Compatibility Considerations

Simulink project API is not recommended

Not recommended starting in R2019a

Starting in R2019a, instead of `simulinkproject` and related functions, use the `currentProject` or `openProject` functions in MATLAB. The Simulink project API will continue to be supported, but, after R2019a, new features will be available only if you use the new MATLAB project API. There are no plans to remove the Simulink project API at this time.

You can continue to use `simulinkproject` and related functions listed in `methods(simulinkproject)`. New functions added after R2019a, such as `runChecks` and `listImpactedFiles`, do not work with `simulinkproject`. Use `currentProject` instead.

The new MATLAB project API is part of the R2019a functionality enabling you to use projects in MATLAB, with or without Simulink. You can now share projects with users who do not have Simulink.

See Also

Functions

`simulinkproject` | `slproject.getCurrentProjects`

Topics

“What Are Projects?”

Introduced in R2013a

slReloadToolstripConfig

Reload Simulink Toolstrip configuration

Syntax

```
slReloadToolstripConfig
```

Description

`slReloadToolstripConfig` reloads the Simulink Toolstrip configuration. Use this function after you make changes to the JSON files that define custom tabs.

Examples

Reload Simulink Toolstrip

After you modify a JSON file that defines a custom tab, use the `slReloadToolstripConfig` function to reload the toolstrip configuration with your changes.

In the MATLAB Command Window, enter:

```
slReloadToolstripConfig;
```

The function searches the MATLAB path for `resources` folders that contain a valid `sl_toolstrip_plugins.json` file. To temporarily modify the toolstrip configuration, add folders that contain `resources` folders to the MATLAB path or remove them from the MATLAB path before you call this function.

If the custom tab does not appear:

- Debug and correct errors in the JSON code.
- Add the folder that contains the corresponding `resources` folder to the MATLAB path.

See Also

[slCreateToolstripComponent](#) | [slCreateToolstripTab](#) | [slToolstripDeveloperMode](#)

Topics

“Create Custom Simulink Toolstrip Tabs”

“Add Prepopulated Custom Tab to Simulink Toolstrip”

Introduced in R2021b

slResetFavoriteCommands

Reset Simulink Favorite Commands gallery

Syntax

```
backup = slResetFavoriteCommands
```

Description

`backup = slResetFavoriteCommands` resets the Simulink **Favorite Commands** gallery and saves a backup of the previous state of the gallery.

Examples

Reset Simulink Favorite Commands Gallery

Suppose you want to delete all the commands and custom categories in the Simulink **Favorite Commands** gallery.

In the MATLAB Command Window, enter:

```
slResetFavoriteCommands;
```

Output Arguments

backup — Backup of previous state

character vector

Backup of previous state, returned as a character vector.

To restore the previous state, you can pass the returned value as the input to the `slImportFavoriteCommands` function and overwrite the current state.

See Also

`slImportFavoriteCommands` | `slExportFavoriteCommands`

Topics

“Access Frequently Used Features and Commands in Simulink”

Introduced in R2021b

slToolstripDeveloperMode

Enable developer mode for Simulink Toolstrip

Syntax

```
tf = slToolstripDeveloperMode(status)
```

Description

`tf = slToolstripDeveloperMode(status)` enables a developer mode that lets you get action and icon names for controls, such as push buttons, in the Simulink Toolstrip.

To display the action and icon names in the MATLAB Command Window, pause on the control in the Simulink Toolstrip and press **Ctrl**. On a Mac, press **command** (⌘) instead of **Ctrl**.

Examples

Enable Simulink Toolstrip Developer Mode

In the MATLAB Command Window, enable developer mode for the Simulink Toolstrip.

```
slToolstripDeveloperMode('on')
```

```
ans =
```

```
logical
```

```
0
```

The function enables developer mode for the Simulink Toolstrip. The returned value indicates that developer mode was disabled before you entered this command.

Input Arguments

status — Desired status of developer mode

on/off logical value

Desired status of developer mode, specified as 'on' or 'off', or as numeric or logical 1 (`true`) or 0 (`false`). A value of 'on' is equivalent to `true`, and 'off' is equivalent to `false`. Thus, you can use the value of this property as a logical value. The value is stored as an on/off logical value of type `matlab.lang.OnOffSwitchState`.

By default, developer mode for the Simulink Toolstrip is disabled. Enable developer mode when you want to get the action and icon names of items in the Simulink Toolstrip.

Data Types: `single` | `double` | `int8` | `int16` | `int32` | `int64` | `uint8` | `uint16` | `uint32` | `uint64` | `logical` | `char`

Output Arguments

tf — Previous status of developer mode

1 | 0

Previous status of developer mode, returned as a 1 or 0 of data type `logical`.

See Also

Topics

“Create Custom Simulink Toolstrip Tabs”

“Disable Simulink Toolstrip and Context Menu Actions”

Introduced in R2021b

slxcinfo

Query contents of Simulink cache files

Syntax

```
info = slxcinfo(filename)
```

Description

`info = slxcinfo(filename)` creates a MATLAB table that lists the contents of the specified Simulink cache file. The table information includes the corresponding Simulink model name, MATLAB release, platform, and target type.

Examples

Query Contents of Simulink Cache File

Suppose you have a Simulink cache file named `model.slxc`. To return a table that lists the artifacts in the Simulink cache file, you would enter:

```
info = slxcinfo('model.slxc')
```

```
info =
```

```
7×4 table
```

| Model | Release | Platform | Target |
|---------|----------|----------|------------------------------------|
| "model" | "R2020a" | "all" | "Variable usage information" |
| "model" | "R2020a" | "win64" | "Rapid accelerator target" |
| "model" | "R2020a" | "win64" | "Accelerator target" |
| "model" | "R2020b" | "all" | "Variable usage information" |
| "model" | "R2020b" | "win64" | "Rapid accelerator target" |
| "model" | "R2020b" | "win64" | "Accelerator target" |
| "model" | "R2020b" | "win64" | "grt Top model Model specific" |

Input Arguments

filename — Name or path of Simulink cache file

character vector | string scalar

Name or path of the Simulink cache file, including the `.slxc` extension, specified as a character vector or string scalar.

Example: `slxcinfo('model.slxc')`

Data Types: `char` | `string`

Output Arguments

info — Simulink cache file contents

MATLAB table

Simulink cache file contents, returned as a MATLAB table.

Alternative Functionality

In the Current Folder browser, double-click the Simulink cache file to open the Simulink cache report.

See Also

`slxcunpack`

Topics

“Share Simulink Cache Files for Faster Simulation”

“Simulink Cache Files for Incremental Code Generation” (Simulink Coder)

Introduced in R2020b

slxcunpack

Unpack simulation and code generation targets from Simulink cache file

Syntax

```
info = slxcunpack(filename)
info = slxcunpack(filename,Name,Value)
```

Description

`info = slxcunpack(filename)` unpacks the simulation and code generation artifacts from the specified Simulink cache file for the current platform and MATLAB release. Code generation artifacts must apply to the current system target file and folder configuration.

When using this function, consider these limitations:

- Do not use this function during model callbacks, model updates, simulation, or code generation. This function loads the model associated with the Simulink cache file.
- Do not use this function as part of asynchronous functions, such as `parfor` and `parfeval`.
- The contents of the Simulink cache file might be out of date. Simulation and code generation can update the artifacts on disk and in the Simulink cache file.

`info = slxcunpack(filename,Name,Value)` specifies additional options using one or more name-value pair arguments.

Examples

Unpack Artifacts from Simulink Cache File

Suppose you have this setup:

- R2020b MATLAB release
- 64-bit Windows operating system
- `grt.tlc` system target file — For more information, see **System target file**.
- `Model specific` code generation folder structure — For more information, see **Code generation folder structure**.

And you have two Simulink cache files:

- `topmodel.slxc` is a Simulink cache file for the top model in a model hierarchy.
- `refmodel.slxc` is a Simulink cache file for the only referenced model in the model hierarchy.

To unpack the simulation and code generation artifacts that correspond to your setup from the Simulink cache file, you would enter:

```
info = slxcunpack('topmodel.slxc')
```

```
info =
```

5×4 table

| Model | Release | Platform | Target |
|------------|----------|----------|--|
| "topmodel" | "R2020b" | "win64" | "Rapid accelerator target" |
| "topmodel" | "R2020b" | "win64" | "Accelerator target" |
| "topmodel" | "R2020b" | "win64" | "grt Top model Model specific" |
| "refmodel" | "R2020b" | "win64" | "Model reference simulation target" |
| "refmodel" | "R2020b" | "win64" | "grt Model reference Model specific" |

The returned table lists the artifacts that the function unpacks into the **Simulation cache folder** and **Code generation folder**.

Unpack Only Simulation Artifacts from Simulink Cache File

Suppose you have this setup:

- R2020b MATLAB release
- 64-bit Windows operating system

And you have two Simulink cache files:

- `topmodel.slxc` is a Simulink cache file for the top model in a model hierarchy.
- `refmodel.slxc` is a Simulink cache file for the only referenced model in the model hierarchy.

To unpack the simulation artifacts that correspond to your setup from the Simulink cache file and display status messages, you would enter:

```
info = slxcunpack('topmodel.slxc','Target','Simulation','Verbose',true)
```

```
### Rapid accelerator target for 'topmodel': Unpacked.
### Accelerator target for 'topmodel': Unpacked.
### Model reference simulation target for 'refmodel': Unpacked.
```

```
info =
```

3×4 table

| Model | Release | Platform | Target |
|------------|----------|----------|-------------------------------------|
| "topmodel" | "R2020b" | "win64" | "Rapid accelerator target" |
| "topmodel" | "R2020b" | "win64" | "Accelerator target" |
| "refmodel" | "R2020b" | "win64" | "Model reference simulation target" |

The returned table lists the artifacts that the function unpacks into the **Simulation cache folder**.

Input Arguments

filename — Name of Simulink cache file

character vector | string scalar

Name of the Simulink cache file, including the `.slxc` extension, specified as a character vector or string scalar.

Note The Simulink cache file must be in the **Simulation cache folder**, which, by default, is the current working folder (`pwd`).

Data Types: `char` | `string`

Name-Value Pair Arguments

Specify optional comma-separated pairs of `Name`, `Value` arguments. `Name` is the argument name and `Value` is the corresponding value. `Name` must appear inside quotes. You can specify several name and value pair arguments in any order as `Name1, Value1, ..., NameN, ValueN`.

Example: `slxcunpack('model.slxc','Target','Simulation')`

Target — Type of target to unpack

`'All'` (default) | `'Simulation'` | `'CodeGeneration'`

Type of target to unpack, specified as the comma-separated pair consisting of `'Target'` and `'All'`, `'Simulation'`, or `'CodeGeneration'`. If `'All'`, the function unpacks both simulation and code generation targets.

The unpacked simulation targets can be accelerator targets, rapid accelerator targets, and model reference simulation targets.

Data Types: `char` | `string`

UnpackReferencedModels — Option to unpack referenced model targets

`true` (default) | `false`

Option to unpack referenced model targets, specified as the comma-separated pair consisting of `'UnpackReferencedModels'` and `true` or `false`. If `true`, the function also unpacks the Simulink cache files that correspond to referenced models.

Data Types: `logical`

Verbose — Option to display status messages

`false` (default) | `true`

Option to display status messages, specified as the comma-separated pair consisting of `'Verbose'` and `true` or `false`.

Data Types: `logical`

Output Arguments

info — Unpacked Simulink cache file contents

MATLAB table

Unpacked Simulink cache file contents, returned as a MATLAB table.

See Also

Functions

`slxcinfo`

Simulink Configuration Parameters

Simulation cache folder | **Code generation folder** | **Code generation folder structure** | **System target file**

Topics

“Share Simulink Cache Files for Faster Simulation”

“Simulink Cache Files for Incremental Code Generation” (Simulink Coder)

Introduced in R2020b

solverprofiler.profileModel

Examine model for performance analysis

Syntax

```
res = solverprofiler.profileModel(model)
res = solverprofiler.profileModel(model, Name, Value)
```

Description

`res = solverprofiler.profileModel(model)` runs the Solver Profiler on the specified model and stores the results in `res`

`res = solverprofiler.profileModel(model, Name, Value)` specifies the Solver Profiler parameters using one or more `Name, Value` pair arguments.

Examples

Examine a Model with Default Settings

Examine the model `f14` using the default commandline settings.

```
model = 'f14';
res = solverprofiler.profileModel(model);
```

You can see a summary of the results by calling `res.summary`.

```
res.summary
struct with fields:
    solver: 'ode45'
    tStart: 0
    tStop: 60
    absTol: 1.0000e-06
    relTol: 1.0000e-04
    hMax: 0.1000
    hAverage: 0.0444
    steps: 1352
    profileTime: 0.9974
    zcNumber: 0
    resetNumber: 600
    jacobianNumber: 0
    exceptionNumber: 195
```

Open the results in the Solver Profiler dialog to visualize them. This step is equivalent to enabling `OpenSP` when calling the function.

```
solverprofiler.exploreResult(res)
```

Configure Solver Profiler and Examine a Model

Examine the model `ssc_actuator_custom_pneumatic` with a fully specified configuration.

```
model = 'ssc_actuator_custom_pneumatic';
res = solverprofiler.profileModel(model, ...
    'SaveStates' , 'on' , ...
    'SaveSimscapeStates' , 'On' , ...
    'SaveJacobian' , 'On' , ...
    'StartTime' , 5 , ...
    'StopTime' , 50 , ...
    'BufferSize' , 10000 , ...
    'TimeOut' , 5 , ...
    'OpenSP' , 'On' , ...
    'DataFullFile' , fullfile(pwd, 'ssc_profiling_result.mat'));
```

Input Arguments

model — Model to examine

character vector (default)

Name of model to be profiled, specified as a character vector.

Example: `h = solverprofiler.profileModel('vdp')`

Name-Value Pair Arguments

Specify optional comma-separated pairs of **Name**, **Value** arguments. **Name** is the argument name and **Value** is the corresponding value. **Name** must appear inside quotes. You can specify several name and value pair arguments in any order as `Name1, Value1, ..., NameN, ValueN`.

Example: `'StartTime', 0, 'StopTime', 10, 'SaveStates', 'On'`

SaveStates — Save model states to file

off (default) | on

By default, the profiler does not save the states of the model. Enabling this parameter configures the profiler to save the states to a MAT-file.

Example: `'SaveStates', 'On'`

SaveSimscapeStates — Save Simscape states to file

off (default) | on

Enable this parameter to save Simscape states to a MAT-file.

Example: `'SaveSimscapeStates', 'On'`

SaveJacobian — Save model Jacobian

off (default) | on

Option to log the solver Jacobian matrices to memory. This option is useful for simulations that use implicit solvers. For a comparison of solvers, see “Compare Solvers”.

Example: `'SaveJacobian', 'On'`

StartTime — Profiler start time

model start time (default) | scalar

Time, in seconds, of the simulation that the profiler starts analyzing the model. This is not the same as the start time of the simulation.

Example: 'StartTime',5

StopTime – Profiler stop time

model stop time (default) | scalar

Time, in seconds, of the simulation to which the profiler should profile the model. By default, the analysis continues until the end of the simulation. Changing this parameter does not change the stop time of the model which you specify in the Model Configuration Parameters.

A value less than the configured stop time of the model stops the profiling and simulation at **StopTime**.

Example: 'StopTime',30

BufferSize – Memory impact of logging

50000 (default) | positive scalar

Maximum number of events that are logged. If the number of logged events reaches this value and memory is available, increase **BufferSize**. If memory is limited, consider lowering the value.

Example: 'BufferSize',60000

TimeOut – Maximum time to wait for solver to resume

positive scalar

Time, in seconds, to wait before the profiler stops running. This option is useful in situations where the simulation is unable to proceed. The profiler waits for the specified time and quits if no progress has been made.

Example: 'TimeOut', 10

OpenSP – Open the Solver Profiler dialog box

off (default) | on

Option to open the Solver Profiler dialog box after profiling has completed.

Example: 'OpenSP', 'On'

DataFullFile – Path and name of saved results

character vector of full file path

By default, the profiling results are saved in a MAT-file named `model_@_dd_Month_yyyy_hh_mm_ss.mat` in the current working folder. You can specify a different file name by which to save the results in the current working folder. To save the file in a different location, specify the full path of the file, including the file name.

Example: 'DataFullFile', 'C:\Users\myusername\Documents\profiled\vdp_results.mat'

Output Arguments

res – High-level summary of profiling results

structure

Profiling results, returned as a structure with the fields:

file — Full path and name of saved results

character vector

Path and name of the MAT-file where the results of the profiling operation are stored as MAT file. By default, they are stored in the current working folder with a file name having the pattern: `model_@_dd_Month_yyyy_hh_mm_ss.mat`. To store them in a different location or by a different name, specify `DataFullFile` when calling `solverprofiler.profileModel`.

summary — Summary of profiling results

structure

A high-level summary of the results of the profiling operation, returned as a structure. The summary provides an overview of the performance of the simulation and health of the model.

The summary structure contains these fields.

| Field | Purpose | Values | Description |
|--------------------------|----------------------------------|---|--|
| <code>solver</code> | Solver used by simulation | any of the solvers supported by Solver Profiler | Solver used by the simulation as configured in the Configuration Parameters for the model. For a list of all the solvers, see "Solver". The Solver Profiler does not support models without any continuous states. |
| <code>tStart</code> | Start time of simulation | scalar | Start time, in seconds, for the simulation of the model during the profiling operation. |
| <code>tStop</code> | Stop time of simulation | scalar | Stop time, in seconds, of the simulation during the profiling operation. If <code>StopTime</code> is set to be earlier than the configured <code>StopTime</code> of the model, the simulation stops at <code>StopTime</code> . |
| <code>absTol</code> | Absolute tolerance of the solver | positive scalar | Absolute tolerance of the solver as specified in the configuration settings for the model. For more information, see "Absolute tolerance" |
| <code>relTol</code> | Relative tolerance of the solver | positive scalar | Relative tolerance of the solver as specified in the configuration settings of the model. For more information, see "Relative tolerance" |
| <code>hMax</code> | Maximum step size | positive scalar | Largest time step that the solver can take. See "Max step size". |
| <code>hAverage</code> | Average step size | positive scalar | Average size of the time step taken by the solver. |
| <code>steps</code> | Total steps taken | positive scalar | Total number of time steps taken by the solver. |
| <code>profileTime</code> | Time to profile | positive scalar | Time, in seconds, taken by the Solver Profiler to examine the model. |

| Field | Purpose | Values | Description |
|-----------------|--------------------------------|--------------------|--|
| zcNumber | Total number of zero crossings | nonnegative scalar | Number of times zero crossings occur during the simulation of the model. The detection of these zero crossings incurs computational cost and can slow down the simulation. For information on zero-crossing detection, see “Zero-Crossing Detection”. |
| resetNumber | Number of solver resets | nonnegative scalar | Number of times the solver has to reset its parameters. |
| jacobianNumber | Number of Jacobian updates | nonnegative scalar | Number of times the solver Jacobian matrix is updated during a simulation. For more information, see “Explicit Versus Implicit Continuous Solvers”. |
| exceptionNumber | Number of solver exceptions | nonnegative scalar | Total number of solver exceptions encountered during a simulation. These exceptions are events where the solver is unable to solve the model states to the specified accuracy. As a result, the solver runs adjusted trials which increase computational cost. |

Data Types: struct

See Also

“Examine Model Dynamics Using Solver Profiler”

Topics

“Solver Selection Criteria”

“Choose a Solver”

Introduced in R2017b

start_simulink

Start Simulink without opening any windows

Syntax

```
start_simulink
```

Description

`start_simulink` starts Simulink without opening any models, the Start Page, or the Simulink Library Browser. Use this in startup scripts to start Simulink without any other window taking the focus away from the MATLAB Desktop. For example, use `start_simulink` in the MATLAB `startup.m` file, when starting MATLAB with the `-r` command line option, or in project startup scripts. Opening a model for the first time in a MATLAB session is much quicker after running `start_simulink`.

If you want to open the Simulink Start Page to create or open models, use the `simulink` function instead.

If you want to open the Library Browser, use `sLibraryBrowser`.

Examples

Start Simulink When Starting MATLAB

Use the `-r` command line option to start Simulink when starting MATLAB, without opening any windows.

On Windows, create a desktop shortcut with the following target:

```
matlabroot\bin\win64\matlab.exe -r start_simulink
```

On Linux and Mac, enter:

```
matlab -r start_simulink
```

See Also

`simulink` | `sLibraryBrowser` | `openProject`

Topics

“Automate Startup Tasks”

Introduced in R2015b

stringtype

Create string data type

Syntax

```
string = stringtype(maximum_length)
stringtype(maximum_length)
```

Description

`string = stringtype(maximum_length)` creates a Simulink string data type with a maximum length. Alternatively, you can also create string data types using the String Constant, String Concatenate, and Compose String blocks.

`stringtype(maximum_length)` creates a Simulink string data type with a maximum length that you can type directly on the MATLAB command line or in the **Output data type** parameter of the String Constant, String Concatenate, or Compose String block.

Tip Specifying `stringtype(0)` creates a string data type with no maximum length. This syntax is the same as specifying `string` for Simulink block data types.

Examples

Create a String Data Type of Maximum Length 10

Create a string data type of maximum length 10.

```
h=stringtype(10)
```

h =

StringType with properties:

```
MaximumLength: 10
Description: ''
DataScope: 'Auto'
HeaderFile: ''
```

Input Arguments

maximum_length — Maximum length

scalar

Maximum length of string data type, specified as a scalar, from 1 to 32766. This value can be an integer, MATLAB variable, or MATLAB expression.

Data Types: double

Output Arguments

string — String data type object

scalar

String object, specified as a scalar.

See Also

[ASCII to String](#) | [Compose String](#) | [Scan String](#) | [String Compare](#) | [String Concatenate](#) | [String Constant](#) | [String Find](#) | [String Length](#) | [String to Double](#) | [String to Single](#) | [String To Enum](#) | [String To ASCII](#) | [Substring](#) | [To String](#)

Topics

“Simulink Strings”

Introduced in R2018a

trim

Find trim point of dynamic system

Syntax

```
[x,u,y,dx] = trim('sys')
[x,u,y,dx] = trim('sys',x0,u0,y0)
[x,u,y,dx] = trim('sys',x0,u0,y0,ix,iu,iy)
[x,u,y,dx] = trim('sys',x0,u0,y0,ix,iu,iy,dx0,idx)
[x,u,y,dx,options] = trim('sys',x0,u0,y0,ix,iu,iy,dx0,idx,options)
[x,u,y,dx,options] = trim('sys',x0,u0,y0,ix,iu,iy,dx0,idx,options,t)
```

Description

A trim point, also known as an equilibrium point, is a point in the parameter space of a dynamic system at which the system is in a steady state. For example, a trim point of an aircraft is a setting of its controls that causes the aircraft to fly straight and level. Mathematically, a trim point is a point where the system's state derivatives equal zero. `trim` starts from an initial point and searches, using a sequential quadratic programming algorithm, until it finds the nearest trim point. You must supply the initial point implicitly or explicitly. If `trim` cannot find a trim point, it returns the point encountered in its search where the state derivatives are closest to zero in a min-max sense; that is, it returns the point that minimizes the maximum deviation from zero of the derivatives. `trim` can find trim points that meet specific input, output, or state conditions, and it can find points where a system is changing in a specified manner, that is, points where the system's state derivatives equal specific nonzero values.

`[x,u,y,dx] = trim('sys')` finds the equilibrium point of the model 'sys', nearest to the system's initial state, `x0`. Specifically, `trim` finds the equilibrium point that minimizes the maximum absolute value of $[x-x_0, u, y]$. If `trim` cannot find an equilibrium point near the system's initial state, it returns the point at which the system is nearest to equilibrium. Specifically, it returns the point that minimizes $\text{abs}(dx)$ where `dx` represents the derivative of the system. You can obtain `x0` using this command.

```
[sizes,x0,xstr] = sys([],[],[],0)
```

`[x,u,y,dx] = trim('sys',x0,u0,y0)` finds the trim point nearest to `x0`, `u0`, `y0`, that is, the point that minimizes the maximum value of

```
abs([x-x0; u-u0; y-y0])
```

`[x,u,y,dx] = trim('sys',x0,u0,y0,ix,iu,iy)` finds the trim point closest to `x0`, `u0`, `y0` that satisfies a specified set of state, input, and/or output conditions. The integer vectors `ix`, `iu`, and `iy` select the values in `x0`, `u0`, and `y0` that must be satisfied. If `trim` cannot find an equilibrium point that satisfies the specified set of conditions exactly, it returns the nearest point that satisfies the conditions, namely,

```
abs([x(ix)-x0(ix); u(iu)-u0(iu); y(iy)-y0(iy)])
```

`[x,u,y,dx] = trim('sys',x0,u0,y0,ix,iu,iy,dx0,idx)` finds specific nonequilibrium points, that is, points at which the system's state derivatives have some specified nonzero value.

Here, `dx0` specifies the state derivative values at the search's starting point and `idx` selects the values in `dx0` that the search must satisfy exactly.

`[x,u,y,dx,options] = trim('sys',x0,u0,y0,ix,iu,iy,dx0,idx,options)` specifies an array of optimization parameters that `trim` passes to the optimization function that it uses to find trim points. The optimization function, in turn, uses this array to control the optimization process and to return information about the process. `trim` returns the `options` array at the end of the search process. By exposing the underlying optimization process in this way, `trim` allows you to monitor and fine-tune the search for trim points.

The following table describes how each element affects the search for a trim point. Array elements 1, 2, 3, 4, and 10 are particularly useful for finding trim points.

| No. | Default | Description |
|-----|---------------------------|--|
| 1 | 0 | Specifies display options. 0 specifies no display; 1 specifies tabular output; -1 suppresses warning messages. |
| 2 | 10^{-4} | Precision the computed trim point must attain to terminate the search. |
| 3 | 10^{-4} | Precision the trim search goal function must attain to terminate the search. |
| 4 | 10^{-6} | Precision the state derivatives must attain to terminate the search. |
| 5 | N/A | Not used. |
| 6 | N/A | Not used. |
| 7 | N/A | Used internally. |
| 8 | N/A | Returns the value of the trim search goal function (λ in goal attainment). |
| 9 | N/A | Not used. |
| 10 | N/A | Returns the number of iterations used to find a trim point. |
| 11 | N/A | Returns the number of function gradient evaluations. |
| 12 | 0 | Not used. |
| 13 | 0 | Number of equality constraints. |
| 14 | 100*(Number of variables) | Maximum number of function evaluations to use to find a trim point. |
| 15 | N/A | Not used. |
| 16 | 10^{-8} | Used internally. |
| 17 | 0.1 | Used internally. |
| 18 | N/A | Returns the step length. |

`[x,u,y,dx,options] = trim('sys',x0,u0,y0,ix,iu,iy,dx0,idx,options,t)` sets the time to `t` if the system is dependent on time.

Note If you fix any of the state, input or output values, `trim` uses the unspecified free variables to derive the solution that satisfies these constraints.

Examples

Consider a linear state-space system modeled using a State-Space block

$$\begin{aligned}\dot{x} &= Ax + Bu \\ y &= Cx + Du\end{aligned}$$

The A , B , C , and D matrices to enter at the command line or in the block parameters dialog are:.

```
A = [-0.09 -0.01; 1 0];
B = [ 0 -7; 0 -2];
C = [ 0 2; 1 -5];
D = [-3 0; 1 0];
```

Example 1

To find an equilibrium point in this model called `sys`, use:

```
[x,u,y,dx,options] = trim('sys')
x =
    0
    0
u =
    0
    0
y =
    0
    0
dx =
    0
    0
```

The number of iterations taken is:

```
options(10)
ans =
    7
```

Example 2

To find an equilibrium point near $x = [1;1]$, $u = [1;1]$, enter

```
x0 = [1;1];
u0 = [1;1];
[x,u,y,dx,options] = trim('sys', x0, u0);
x =
    1.0e-13 *
    -0.5160
    -0.5169
u =
    0.3333
    0.0000
y =
    -1.0000
    0.3333
dx =
    1.0e-12 *
```



```

0.1979
0.0035

```

The number of iterations taken is

```

options(10)
ans =
    25

```

Example 3

To find an equilibrium point with the outputs fixed to 1, use:

```

y = [1;1];
iy = [1;2];
[x,u,y,dx] = trim('sys', [], [], y, [], [], iy)
x =
    0.0009
   -0.3075
u =
   -0.5383
    0.0004
y =
    1.0000
    1.0000
dx =
    1.0e-15 *
   -0.0170
    0.1483

```

Example 4

To find an equilibrium point with the outputs fixed to 1 and the derivatives set to 0 and 1, use

```

y = [1;1];
iy = [1;2];
dx = [0;1];
idx = [1;2];
[x,u,y,dx,options] = trim('sys',[],[],y,[],[],iy,dx,idx)
x =
    0.9752
   -0.0827
u =
   -0.3884
   -0.0124
y =
    1.0000
    1.0000
dx =
    0.0000
    1.0000

```

The number of iterations taken is

```

options(10)
ans =
    13

```

Limitations

The trim point found by `trim` starting from any given initial point is only a local value. Other, more suitable trim points may exist. Thus, if you want to find the most suitable trim point for a particular application, it is important to try a number of initial guesses for x , u , and y .

Algorithms

`trim` uses a sequential quadratic programming algorithm to find trim points. See “Sequential Quadratic Programming (SQP)” (Optimization Toolbox) for a description of this algorithm.

Introduced before R2006a

tunablevars2parameterobjects

Create Simulink parameter objects from tunable parameters

Syntax

```
tunablevars2parameterobjects ('modelName')  
tunablevars2parameterobjects ('modelName', class)
```

Description

`tunablevars2parameterobjects ('modelName')` creates `Simulink.Parameter` objects in the base workspace for the variables listed in the specified model's Tunable Parameters dialog, then deletes the source information from the dialog. To preserve the information, save the resulting Simulink parameter objects into a MAT-file.

If a tunable variable is already defined as a numeric variable in the base workspace, the variable will be replaced by a parameter object and the original variable will be copied to the object's Value property.

If a tunable variable is already defined as a Simulink parameter object, the object will not be modified but the information for the variable will still be deleted from the Tunable Parameters dialog.

If a tunable variable is defined as any other class of variable, the variable will not be modified and the information for the variable will not be deleted from the Tunable Parameters dialog.

`tunablevars2parameterobjects ('modelName', class)` creates objects of the specified class rather than `Simulink.Parameter` objects.

Input Arguments

modelName

Model name or handle

class

Parameter class to use for creating objects

Default: `Simulink.Parameter`

See Also

`Simulink.Parameter`

Topics

"Tunable Parameters"

Introduced in R2007b

ufix

Create `Simulink.NumericType` object describing unsigned fixed-point data type

Syntax

```
a = ufix(WordLength)
```

Description

`ufix(WordLength)` returns a `Simulink.NumericType` object that describes an unsigned fixed-point data type with the specified word length and unspecified scaling.

Note `ufix` is a legacy function. In new code, use `fixdt` instead. In existing code, replace `ufix(WordLength)` with `fixdt(0,WordLength)`.

Examples

Define a 16-bit unsigned fixed-point data type.

```
a = ufix(16)
```

```
a =
```

```
    NumericType with properties:
```

```
    DataTypeMode: 'Fixed-point: unspecified scaling'  
    Signedness: 'Unsigned'  
    WordLength: 16  
    IsAlias: 0  
    DataScope: 'Auto'  
    HeaderFile: ''  
    Description: ''
```

See Also

`fixdt` | `Simulink.NumericType` | `float` | `sfix` | `sfrac` | `sint` | `ufrac` | `uint`

Introduced before R2006a

ufrac

Create `Simulink.NumericType` object describing unsigned fractional data type

Syntax

```
a = ufrac(WordLength)
a = ufrac(WordLength, GuardBits)
```

Description

`ufrac(WordLength)` returns a `Simulink.NumericType` object that describes the data type of an unsigned fractional data type with a word size given by `WordLength`.

`ufrac(WordLength, GuardBits)` returns a `Simulink.NumericType` object that describes the data type of an unsigned fractional data type. The total word size is given by `WordLength` with `GuardBits` bits located to the left of the binary point.

Note `ufrac` is a legacy function. In new code, use `fixdt` instead. In existing code, replace `ufrac(WordLength)` with `fixdt(0,WordLength,WordLength)` and `ufrac(WordLength,GuardBits)` with `fixdt(0,WordLength,(WordLength-GuardBits))`.

Examples

Define an 8-bit unsigned fractional data type with 4 guard bits. Note that the range of this data type is from 0 to $(1 - 2^{-8}) \cdot 2^4 = 15.9375$.

```
a = ufrac(8,4)
```

```
a =
```

```

NumericType with properties:
    DataTypeMode: 'Fixed-point: binary point scaling'
    Signedness: 'Unsigned'
    WordLength: 8
    FractionLength: 4
    IsAlias: 0
    DataScope: 'Auto'
    HeaderFile: ''
    Description: ''

```

See Also

`fixdt` | `Simulink.NumericType` | `float` | `sfix` | `sfrac` | `sint` | `ufix` | `uint`

Introduced before R2006a

uint

Create `Simulink.NumericType` object describing unsigned integer data type

Syntax

```
a = uint(WordLength)
```

Description

`uint(WordLength)` returns a `Simulink.NumericType` object that describes the data type of an unsigned integer with a word size given by `WordLength`.

Note `uint` is a legacy function. In new code, use `fixdt` instead. In existing code, replace `uint(WordLength)` with `fixdt(0,WordLength,0)`.

Examples

Define a 16-bit unsigned integer.

```
a = uint(16)
```

```
a =
```

```
    NumericType with properties:
```

```
        DataTypeMode: 'Fixed-point: binary point scaling'  
        Signedness: 'Unsigned'  
        WordLength: 16  
        FractionLength: 0  
        IsAlias: 0  
        DataScope: 'Auto'  
        HeaderFile: ''  
        Description: ''
```

See Also

`fixdt` | `Simulink.NumericType` | `float` | `sfix` | `sfrac` | `sint` | `ufix` | `ufrac`

Introduced before R2006a

unpack

Extract signal logging objects from signal logs and write them into MATLAB workspace

Syntax

```
log.unpack  
tsarray.unpack  
log.unpack('systems')  
log.unpack('all')
```

Description

Note The `ModelDataLogs` class is supported for backwards compatibility. Starting in R2016a, you cannot log data in the `ModelDataLogs` format. Signal logging uses the `Dataset` format. In R2016a or later, when you open a model from an earlier release that had used `ModelDataLogs` format, the model simulated in use `Dataset` format.

You can convert signal logging data from `ModelDataLogs` to `Dataset` format. Converting to `Dataset` format makes it easier to post-process with other logged data (for example, logged states), which can also use `Dataset` format. For more information, see “Convert Logged Data to Dataset Format”.

If you have legacy code that uses the `ModelDataLogs` API, you can encounter situations that require updates to your code or model. See “Migrate Scripts That Use Legacy `ModelDataLogs` API”.

`log.unpack` or `unpack(log)` extracts the top level elements of the `Simulink.ModelDataLogs` or `Simulink.SubsysDataLogs` object named **log** (e.g., `logout`).

`log.unpack('systems')` or `unpack(log, 'systems')` extracts `Simulink.Timeseries` and `Simulink.TsArray` objects from the `Simulink.ModelDataLogs` or `Simulink.SubsysDataLogs` object named `log`. This command does not extract `Simulink.Timeseries` objects from `Simulink.TsArray` objects nor does it write intermediate `Simulink.ModelDataLogs` or `Simulink.SubsysDataLogs` objects to the MATLAB workspace.

`log.unpack('all')` or `unpack(log, 'all')` extracts all the `Simulink.Timeseries` objects contained by the `Simulink.ModelDataLogs`, `Simulink.TsArray`, or `Simulink.SubsysDataLogs` object named `log`.

`tsarray.unpack` extracts the time-series objects of class `Simulink.Timeseries` from the `Simulink.TsArray` object named `tsarray`.

See Also

`Simulink.ModelDataLogs` | `Simulink.SubsysDataLogs` | `Simulink.Timeseries` | `Simulink.TsArray` | `who` | `whos`

Topics

“Export Signal Data Using Signal Logging”

Introduced before R2006a

upgradeadvisor

Open Upgrade Advisor

Syntax

```
upgradeadvisor('modelname')  
upgrader = upgradeadvisor('modelname')
```

Description

`upgradeadvisor('modelname')` opens the Upgrade Advisor for the model specified by `modelname`. This command loads the model if necessary, but does not open it in the Simulink Editor. Use the Upgrade Advisor to help you upgrade and improve models with the current release.

`upgrader = upgradeadvisor('modelname')` returns an object that you can use to analyze and upgrade a hierarchy of models programmatically. If you specify an output, then the Upgrade Advisor does not open. You can use the methods `analyze` and `upgrade` with the `upgrader` object output of the `upgradeadvisor` function.

- To programmatically analyze a model for recommended upgrades, create an `upgrader` object and use the method `analyze`.
- To programmatically analyze and upgrade a model, create an `upgrader` object and use the method `upgrade`.
- To configure options before running `analyze` or `upgrade`, see “Examples” on page 2-1279.

Tip For an example showing how to programmatically upgrade a whole project, see “Upgrade Simulink Models Using a Project” on page 13-511.

Input Arguments

modelname

Name or handle to the model, specified as a character vector.

Output Arguments

upgrader

Object for analyzing and upgrading the hierarchy of models programmatically.

Examples

Open Upgrade Advisor on a Model

To open the Upgrade Advisor on the `vdp` example model:

```
upgradeadvisor('vdp')
```

To open the Upgrade Advisor on the currently selected model:

```
upgradeadvisor(bdroot)
```

Programmatically Analyze and Upgrade a Model

- 1 Get an upgrader object. This example uses a writable copy of the vdp model.

```
load_system('vdp'); save_system('vdp',fullfile(tempdir, 'myvdp'))
upgrader = upgradeadvisor('myvdp')
```

```
upgrader =
```

```
Upgrader with properties:
```

```
ChecksToSkip: {}
SkipLibraries: 0
SkipBlocksets: 1
OneLevelOnly: 0
ShowReport: 1
RootModel: 'myvdp'
ReportFile: ''
```

- 2 To analyze the model for recommended upgrades, following library links and model references, run:

```
analyze(upgrader);
```

You see a report of issues found.

- 3 To analyze the model and automatically fix all issues (where automated fixes are available), run:

```
upgrade(upgrader);
```

This command follows library links and model references, and saves any fixes to the model files.

You see a report of issues found and actions taken.

- 4 To find the location of the report:

```
reportLocation = upgrader.ReportFile
```

- 5 You can configure options before running analyze or upgrade.

- Specify checks to skip before running analyze or upgrade. Find the ID for a check in the Upgrade Advisor by right-clicking the check and selecting **Send Check ID to Workspace**. Then set the `upgrader.ChecksToSkip` property. For example:

```
upgrader.ChecksToSkip = {'mathworks.design.CSStoVSSConvert'};
upgrade(upgrader);
```

- Specify running the Upgrade Advisor on only the current model without following library links or model references:

```
upgrader.OneLevelOnly = true; % default false
```

- Specify running the Upgrade Advisor on the current model, following model references but not library links:

```
upgrader.SkipLibraries = true; % default false
```

- Specify running the Upgrade Advisor on the current model, including upgrading files in blocksets or toolboxes:

```
upgrader.SkipBlocksets = false; % default true
```

By default, the Upgrade Advisor does not upgrade files in blocksets or toolboxes. The Upgrade Advisor detects blocksets from the output of `ver` and the existence of a `Contents.m` file.

- To turn off showing the report after analyze or upgrade, set:

```
upgrader.ShowReport = false; % default true
```

Tip For an example showing how to programmatically upgrade a whole project, see “Upgrade Simulink Models Using a Project” on page 13-511.

Tips

- The Upgrade Advisor can identify cases where you can benefit by changing your model to use new features and settings in Simulink. The Advisor provides advice for transitioning to new technologies, and upgrading a model hierarchy.

The Upgrade Advisor can also identify cases where a model will not work because changes and improvements in Simulink require changes to a model.

The Upgrade Advisor offers options to perform recommended actions automatically or instructions for manual fixes.

Alternatives

You can also open the Upgrade Advisor from the Simulink Editor. In the **Modeling** tab, select **Model Advisor > Upgrade Advisor**.

Alternatively, you can open the Upgrade Advisor from the Model Advisor. In the Model Advisor, under **By Task checks**, expand the folder **Upgrading to the Current Simulink Version** and select the check **Open the Upgrade Advisor**.

See Also

`modeladvisor`

Topics

“Consult the Upgrade Advisor”

“Run Model Advisor Checks”

“Upgrade Simulink Models Using a Project” on page 13-511

Introduced in R2012b

view_mdhrefs

Analyze and visualize model referencing dependencies without library dependencies

Syntax

```
view_mdhrefs(sys)
```

Description

`view_mdhrefs` opens the Dependency Analyzer with library dependencies omitted. To open a specific configuration of the Dependency Analyzer, use `depview` with programmatic options. The Dependency Analyzer provides the same options regardless of how you open it.

`view_mdhrefs(sys)` opens the Dependency Analyzer. It displays a graph of model referencing dependencies for the specified model. The nodes in the graph represent Simulink models. The directed lines indicate model dependencies.

Examples

Open Dependency Analyzer without Library Dependencies

Open the Dependency Analyzer for the `sldemo_mdhref_depgraph` model.

```
view_mdhrefs('sldemo_mdhref_depgraph');
```

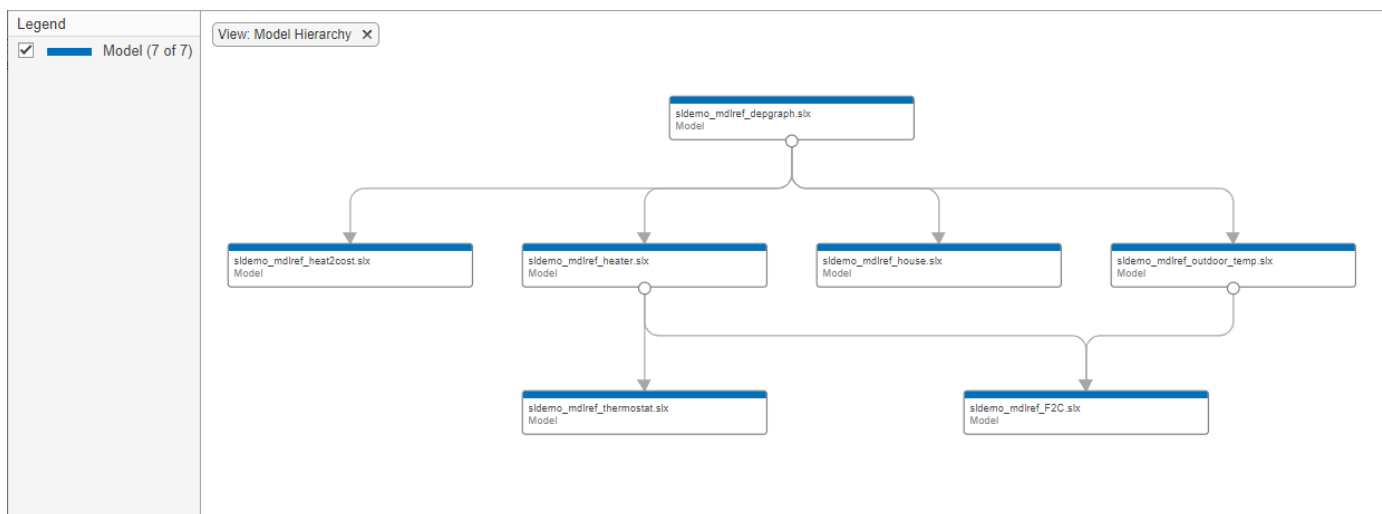

Input Arguments

sys — Model name or path
character vector

The full name or path of a model, specified as a character vector.

Data Types: char

See Also

Blocks

Model

Functions

depview | find_mdrefs

Topics

“Model Reference Basics”

“Analyze Model Dependencies”

Introduced before R2006a

who

List names of top-level data logging objects in Simulink ModelDataLogs data log

Syntax

```
log.who
```

```
tsarray.who
```

```
log.who('systems')
```

```
log.who('all')
```

Description

Note To list names of top-level data logging objects in Dataset format, use `find`.

The `ModelDataLogs` class is supported for backwards compatibility. Starting in R2016a, you cannot log data in the `ModelDataLogs` format. Signal logging uses the `Dataset` format. In R2016a or later, when you open a model from an earlier release that had used `ModelDataLogs` format, the model simulated in use `Dataset` format.

You can convert signal logging data from `ModelDataLogs` to `Dataset` format. Converting to `Dataset` format makes it easier to post-process with other logged data (for example, logged states), which can also use `Dataset` format. For more information, see “Convert Logged Data to Dataset Format”.

If you have legacy code that uses the `ModelDataLogs` API, you can encounter situations that require updates to your code or model. See “Migrate Scripts That Use Legacy ModelDataLogs API”.

`log.who` or `who(log)` lists the names of the top-level signal logging objects contained by `log`, where `log` is the handle of a `Simulink.ModelDataLogs` object name.

`tsarray.who` or `who(tsarray)` lists the names of `Simulink.TimeSeries` objects contained by the `Simulink.TsArray` object named `tsarray`.

`log.who('systems')` or `who(log, 'systems')` lists the names of all signal logging objects contained by `log` except for `Simulink.Timeseries` objects stored in `Simulink.TsArray` objects contained by `log`.

`log.who('all')` or `who(log, 'all')` lists the names of all the `Simulink.Timeseries` objects contained by the `Simulink.ModelDataLogs`, `Simulink.TsArray`, or `Simulink.SubsysDataLogs` object named `log`.

For information about other uses of `who`, use the `help` function for `who` in the MATLAB Command Window.

Tip To get the names of Dataset variables in the MAT-file, using the `Simulink.SimulationData.DatasetRef.getDatasetVariableNames` function processes faster than using the `who` or `whos` functions.

See Also

`find` | `Simulink.SimulationData.DatasetRef.getDatasetVariableNames` | `Simulink.ModelDataLogs` | `Simulink.SubsysDataLogs` | `Simulink.Timeseries` | `Simulink.TsArray` | `whos` | `unpack`

Topics

“Load Big Data for Simulations”

Introduced before R2006a

whos

List names and types of top-level data logging objects in Simulink ModelDataLogs data log

Syntax

```
log.whos
```

```
tsarray.whos
```

```
log.whos('systems')
```

```
log.whos('all')
```

Description

Note To list names of top-level data logging objects in Dataset format, use `find`.

The `ModelDataLogs` class is supported for backwards compatibility. Starting in R2016a, you cannot log data in the `ModelDataLogs` format. Signal logging uses the `Dataset` format. In R2016a or later, when you open a model from an earlier release that had used `ModelDataLogs` format, the model simulated in use `Dataset` format.

You can convert signal logging data from `ModelDataLogs` to `Dataset` format. Converting to `Dataset` format makes it easier to post-process with other logged data (for example, logged states), which can also use `Dataset` format. For more information, see “Convert Logged Data to Dataset Format”.

If you have legacy code that uses the `ModelDataLogs` API, you can encounter situations that require updates to your code or model. See “Migrate Scripts That Use Legacy ModelDataLogs API”.

`log.whos` or `whos(log)` lists the names and types of the top-level signal logging objects contained by `log`, where `log` is the handle of a `Simulink.ModelDataLogs` object name.

`tsarray.whos` or `whos(tsarray)` lists the names and types of `Simulink.TimeSeries` objects contained by the `Simulink.TsArray` object named `tsarray`.

`log.whos('systems')` or `whos(log, 'systems')` lists the names and types of all signal logging objects contained by `log` except for `Simulink.Timeseries` objects stored in `Simulink.TsArray` objects contained by `log`.

`log.whos('all')` or `whos(log, 'all')` lists the names and types of all the `Simulink.Timeseries` objects contained by the `Simulink.ModelDataLogs`, `Simulink.TsArray` or `Simulink.SubsysDataLogs` object named `log`.

For information about other uses of `whos`, use the `help` function for `who` in the MATLAB Command Window.

Tip To get the names of Dataset variables in the MAT-file, using the `Simulink.SimulationData.DatasetRef.getDatasetVariableNames` function processes faster than using the `who` or `whos` functions.

See Also

`find` | `Simulink.SimulationData.DatasetRef.getDatasetVariableNames` | `Simulink.ModelDataLogs` | `Simulink.SubsysDataLogs` | `Simulink.Timeseries` | `Simulink.TsArray` | `who` | `unpack`

Topics

“Load Big Data for Simulations”

Introduced before R2006a

addChoice

Package: Simulink

Add choices to variant parameter object

Syntax

```
P = addChoice(P,Choices{Condition,Value})
```

Description

`P = addChoice(P,Choices{Condition,Value})` adds a new variant choice to the variant parameter object `P`. A variant choice consists of a variant condition and a value specified as `Condition` and `Value`, respectively. You can add multiple choices to `p` by specifying condition-value pairs in a cell array. No two values of a variant variable can be associated with the same variant condition.

Note Adding a value to an existing variant condition results in an error.

Examples

Add Variant Choice

Create a `Simulink.VariantVariable` object.

```
P = Simulink.VariantVariable;
```

Add a variant choice to the object.

```
P = addChoice(P, {'V==1', 3.5});
```

Add Multiple Variant Choices

Create a `Simulink.VariantVariable` object.

```
P = Simulink.VariantVariable;
```

Add multiple variant choices to the object.

```
P = addChoice(P, {'V==1', 3.5, 'V==2', 8.3});
```

Input Arguments

P — Variant parameter object

`Simulink.VariantVariable` object

Variant parameter object created using `Simulink.VariantVariable`, specified as a `Simulink.VariantVariable` object. The choices that you specify using `addChoice` are added to this object.

Condition, Value — Variant condition and associated value

cell array

Variant condition and associated value, specified as a cell array. A variant condition is a control expression that determines the active value of the variant parameter object. During simulation, when a variant condition evaluates to `true`, the value associated with the condition becomes active. When a variant condition evaluates to `false`, the value associated the condition becomes inactive. You can add multiple values of the object by specifying condition-value pairs in a cell array.

You can specify the variant condition as boolean MATLAB expressions that contain one or more operands and operators. See “Variant Controls in Variant Parameters”.

Example: `{ 'V==2' ,5}`

Data Types: `struct`

See Also

`setChoice` | `getChoice` | `removeChoice` | `Simulink.VariantVariable`

Topics

“Change Active Values and Activation Time of Variant Parameters”

Introduced in R2021a

getChoice

Package: Simulink

Return choices of variant parameter object

Syntax

```
choices = getChoice(P)
choices = getChoice(P,Condition)
```

Description

`choices = getChoice(P)` returns all the choices of variant parameter `p` in a cell array.

`choices = getChoice(P,Condition)` returns the value associated with the variant condition `Condition`. You can specify multiple conditions of variant parameter `p` in a cell array.

Examples

Get All Variant Choices

Create a `Simulink.VariantVariable` object.

```
p = Simulink.VariantVariable('Choices',{ 'V==1',8, 'V==2',9})
```

Get all variant choices of the object.

```
choices = getChoice(p)
```

Get Specific Variant Choices

Create a `Simulink.VariantVariable` object.

```
p = Simulink.VariantVariable('Choices',{ 'V==1',8, 'V==2',9})
```

Get the value associated with variant condition `V==1`.

```
choice = getChoice(p, 'V==2')
```

Input Arguments

P — Variant parameter object

`Simulink.VariantVariable` object

Variant parameter object created using `Simulink.VariantVariable`, specified as a `Simulink.VariantVariable` object.

Condition – Variant control expression

string

Variant control expression corresponding to the value to be returned, specified as a string. You can get multiple choices of the object by specifying conditions in a cell array.

Example: 'V==2'

Data Types: char

See Also

[addChoice](#) | [setChoice](#) | [removeChoice](#) | [Simulink.VariantVariable](#)

Topics

“Change Active Values and Activation Time of Variant Parameters”

Introduced in R2021a

setChoice

Package: Simulink

Modify existing choices of variant parameter object

Syntax

```
P = setChoice(P,Choices{Condition,Value})
```

Description

`P = setChoice(P,Choices{Condition,Value})` replaces the value associated with the variant condition `Condition` by the new value `Value`. You can modify multiple values of variant variable `P` by specifying condition-value pairs in a cell array. If the choice corresponding to the specified condition already exists, the associated value is overridden. Otherwise, a new choice is added.

Examples

Modify Variant Choice

Create a `Simulink.VariantVariable` object.

```
P = Simulink.VariantVariable('Choices',{ 'V==1',8, 'V==2',9})
```

Modify a variant choice associated with the variant condition `V==1`.

```
P = setChoice(P, {'V==1', 3.5});
```

Modify Multiple Variant Choices

Create a `Simulink.VariantVariable` object.

```
P = Simulink.VariantVariable('Choices',{ 'V==1',8, 'V==2',9, 'V==3',12})
```

Modify variant choices associated with variant conditions `V==1` and `V==3`.

```
P = setChoice(P, {'V==1', 3.5, 'V==3',20});
```

Input Arguments

P — Variant parameter object

`Simulink.VariantVariable` object

Variant parameter object created using `Simulink.VariantVariable`, specified as a `Simulink.VariantVariable` object. This object is updated with the new values that you specify using `setChoice`.

Condition, Value — Variant condition and associated value

cell array

Variant condition and its associated value, specified as a cell array. Simulink replaces the existing value of the specified variant condition with the new value. You can modify multiple values of the object by specifying condition-value pairs in a cell array. You can specify the variant condition as boolean MATLAB expressions that contain one or more operands and operators. See “Variant Controls in Variant Parameters”.

Example: {'V==2',5}

Data Types: struct

See Also

addChoice | getChoice | removeChoice | Simulink.VariantVariable

Topics

“Change Active Values and Activation Time of Variant Parameters”

Introduced in R2021a

removeChoice

Package: Simulink

Remove choices from variant parameter object

Syntax

```
P = removeChoice(P,Condition)
```

Description

`P = removeChoice(P,Condition)` removes the condition-value pair from variant variable `P` corresponding to condition `Condition`. You can remove multiple choices from `P` by specifying conditions in a cell array. Specifying variant conditions that do not exist results in an error.

Examples

Remove Variant Choice

Create a `Simulink.VariantVariable` object.

```
P = Simulink.VariantVariable('Choices',{ 'V==1',8, 'V==2',9, 'V==3',20})
```

Remove the variant choice associated with condition `V==2`.

```
P = removeChoice(P, 'V==2');
```

Remove Multiple Variant Choices

Create a `Simulink.VariantVariable` object.

```
P = Simulink.VariantVariable('Choices',{ 'V==1',8, 'V==2',9, 'V==3',20})
```

Remove variant choices associated with conditions `V==2` and `V==3`.

```
P = removeChoice(P, {'V==2','V==3'});
```

Input Arguments

P — Variant parameter object

`Simulink.VariantVariable` object

Variant parameter object created using `Simulink.VariantVariable`, specified as an `Simulink.VariantVariable` object. The choices that you specify using `removeChoice` are removed from this object.

Condition — Variant control expression

string

Variant control expression corresponding to the value to be removed, specified as a string. You can remove multiple choices from the object by specifying conditions in a cell array.

Example: 'V==2'

Data Types: char

See Also

`addChoice` | `setChoice` | `getChoice` | `Simulink.VariantVariable`

Topics

“Change Active Values and Activation Time of Variant Parameters”

Introduced in R2021a

Mask Icon Drawing Commands

| | |
|------------|---|
| color | Change drawing color of subsequent mask icon drawing commands |
| disp | Display text on masked subsystem icon |
| dpoly | Display transfer function on masked subsystem icon |
| droots | Display transfer function on masked subsystem icon |
| fprintf | Display variable text centered on masked subsystem icon |
| image | Display RGB image on masked subsystem icon |
| patch | Draw color patch of specified shape on masked subsystem icon |
| plot | Draw graph connecting series of points on masked subsystem icon |
| port_label | Draw port label on masked subsystem icon |
| text | Display text at specific location on masked subsystem icon |
| block_icon | Promote a block icon image to the masked Subsystem |

color

Change drawing color of subsequent mask icon drawing commands

Syntax

```
color(colorstr)
```

Here, *colorstr* must be a character vector.

Description

`color(colorstr)` sets the drawing color of all subsequent mask drawing commands to the color specified by the string *colorstr*.

colorstr must be one of the following supported color strings.

```
blue  
green  
red  
cyan  
magenta  
yellow  
black
```

Entering any other string or specifying the color using RGB values results in a warning at the MATLAB command prompt; Simulink ignores the color change. The specified drawing color does not influence the color used by the `patch` or `image` drawing commands.

Examples

The following commands

```
color('cyan');  
roots([-1], [-2 -3], 4)  
color('magenta')  
port_label('input',1,'in')  
port_label('output',1,'out')
```

draw the following mask icon.

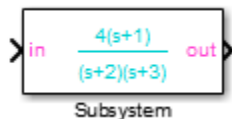

See Also

`roots` | `port_label`

Introduced in R2006b

disp

Display text on masked subsystem icon

Syntax

```
disp(text)
disp(text, 'texmode', 'on')
```

Description

`disp(text)` displays *text* centered on the block icon. *text* is any MATLAB expression that evaluates to a string.

`disp(text, 'texmode', 'on')` allows you to use TeX formatting commands in *text*. The TeX formatting commands in turn allow you to include symbols and Greek letters in icon text. See “Interpreter” for information on the TeX formatting commands supported by Simulink software.

Examples

The following command

```
disp('\itEquation: \alpha^2 + \beta^2 \rightarrow \gamma^2, \chi, \phi_3 = \bfcool', 'texmode','on')
```

draws the equation that appears on this masked block icon.

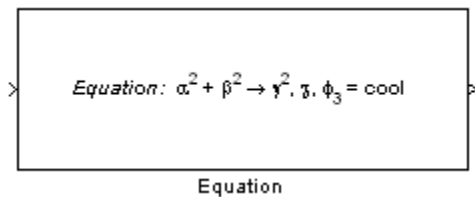

See Also

`fprintf` | `port_label` | `text`

Introduced in R2007a

dpoly

Display transfer function on masked subsystem icon

Syntax

```
dpoly(num, den)
```

```
dpoly(num, den, 'character')
```

Description

`dpoly(num, den)` displays the transfer function whose numerator is *num* and denominator is *den*.

`dpoly(num, den, 'character')` specifies the name of the transfer function independent variable. The default is *s*.

When Simulink draws the block icon, the initialization commands execute and the resulting equation appears on the block icon, as in the following examples:

- To display a continuous transfer function in descending powers of *s*, enter

```
dpoly(num, den)
```

For example, for `num = [0 0 1]`; and `den = [1 2 1]` the icon looks like:

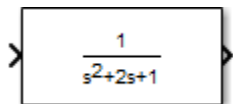

$$\frac{1}{s^2 + 2s + 1}$$

- To display a discrete transfer function in descending powers of *z*, enter

```
dpoly(num, den, 'z')
```

For example, for `num = [0 0 1]`; and `den = [1 2 1]`; the icon looks like:

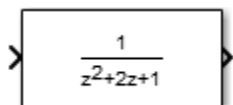

$$\frac{1}{z^2 + 2z + 1}$$

- To display a discrete transfer function in ascending powers of $1/z$, enter

```
dpoly(num, den, 'z-')
```

For example, for *num* and *den* as defined previously, the icon looks like:

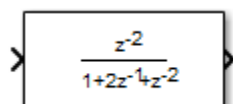

$$\frac{z^{-2}}{1 + 2z^{-1} + z^{-2}}$$

If the parameters are not defined or have no values when you create the icon, Simulink software displays three question marks (? ? ?) in the icon. When you define parameter values in the Mask

Settings dialog box, Simulink software evaluates the transfer function and displays the resulting equation in the icon.

See Also

`disp` | `port_label` | `text` | `droots`

droots

Display transfer function on masked subsystem icon

Syntax

```
droots(zero, pole, gain)
droots(zero, pole, gain, 'z')
droots(zero, pole, gain, 'z-')
```

Description

`droots(zero, pole, gain)` displays the transfer function whose *zero* is *zero*, *pole* is *pole*, and *gain* is *gain*.

`droots(zero, pole, gain, 'z')` and `droots(zero, pole, gain, 'z-')` expresses the transfer function in terms of *z* or $1/z$.

When Simulink draws the block icon, the initialization commands execute and the resulting equation appears on the block icon, as in the following examples:

- To display a zero-pole gain transfer function, enter

```
droots(z, p, k)
```

For example, the preceding command creates this icon for these values:

```
z = []; p = [-1 -1]; k = 1;
```

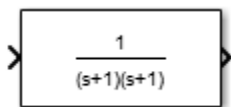

If the parameters are not defined or have no values when you create the icon, Simulink software displays three question marks (? ? ?) in the icon. When you define parameter values in the Mask Settings dialog box, Simulink software evaluates the transfer function and displays the resulting equation in the icon.

See Also

`disp` | `port_label` | `text` | `dpoly`

Introduced in R2007a

fprintf

Display variable text centered on masked subsystem icon

Syntax

```
fprintf(text)
fprintf(formatSpec, var)
```

Description

The `fprintf` command displays formatted text centered on the icon and can display *formatSpec* along with the contents of *var*.

Note While this `fprintf` function is identical in name to its corresponding MATLAB function, it provides only the functionality described on this page.

`formatSpec` can be a character vector in single quotes, or a string scalar.

Formatting Operator

A formatting operator starts with a percent sign, %, and ends with a conversion character. The conversion character is required. Optionally, you can specify identifier, flags, field width, precision, and subtype operators between % and the conversion character. (Spaces are invalid between operators and are shown here only for readability).

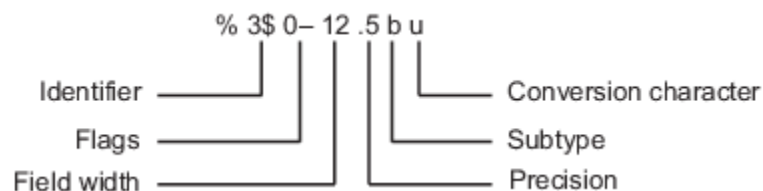

Conversion Character

This table shows conversion characters to format numeric and character data as text.

| Value Type | Conversion | Details |
|-----------------------|------------------------------------|--|
| Integer, signed | <code>%d</code> or <code>%i</code> | Base 10 |
| Integer, unsigned | <code>%u</code> | Base 10 |
| | <code>%o</code> | Base 8 (octal) |
| | <code>%x</code> | Base 16 (hexadecimal), lowercase letters a-f |
| | <code>%X</code> | Same as <code>%x</code> , uppercase letters A-F |
| Floating-point number | <code>%f</code> | Fixed-point notation (Use a precision operator to specify the number of digits after the decimal point.) |

| Value Type | Conversion | Details |
|-----------------------|-----------------|--|
| | <code>%e</code> | Exponential notation, such as <code>3.141593e+00</code> (Use a precision operator to specify the number of digits after the decimal point.) |
| | <code>%E</code> | Same as <code>%e</code> , but uppercase, such as <code>3.141593E+00</code> (Use a precision operator to specify the number of digits after the decimal point.) |
| | <code>%g</code> | The more compact of <code>%e</code> or <code>%f</code> , with no trailing zeros (Use a precision operator to specify the number of significant digits.) |
| | <code>%G</code> | The more compact of <code>%E</code> or <code>%f</code> , with no trailing zeros (Use a precision operator to specify the number of significant digits.) |
| Characters or strings | <code>%c</code> | Single character |
| | <code>%s</code> | Character vector or string array. The type of the output text is the same as the type of <code>formatSpec</code> . |

Examples

The command

```
fprintf('Hello');
```

displays the text 'Hello' on the icon.

The command

```
fprintf('Hello = %d',17);
```

uses the decimal notation format (`%d`) to display the variable 17.

See Also

`disp` | `port_label` | `text`

Introduced before R2006a

image

Display RGB image on masked subsystem icon

Syntax

```
image(a)
image(a, position)
image(a, position, rotation)
```

Description

`image(a)` displays the image *a*, where *a* is an *m*-by-*n*-by-3 array of RGB values. If necessary, use the MATLAB commands `imread` and `ind2rgb` to read and convert bitmap files (such as GIF) to the necessary matrix format.

`image(a, position)` creates the image at the specified position as follows.

| Position | Description |
|-----------------------------|---|
| <code>[x, y, w, h]</code> | Position (<i>x</i> , <i>y</i>) and size (<i>w</i> , <i>h</i>) of the image where the position is relative to the lower-left corner of the mask. The image scales to fit the specified size. |
| <code>'center'</code> | Center of the mask |
| <code>'top-left'</code> | Top left corner of the mask, unscaled |
| <code>'bottom-left'</code> | Bottom left corner of the mask, unscaled |
| <code>'top-right'</code> | Top right corner of the mask, unscaled |
| <code>'bottom-right'</code> | Bottom right corner of the mask, unscaled |

`image(a, position, rotation)` allows you to specify whether the image rotates (`'on'`) or remains stationary (`'off'`) as the icon rotates. The default is `'off'`.

Note Images in formats `.cur`, `.hdf4`, `.ico`, `.pcx`, `.ras`, `.xwd`, `.svg` (full version) cannot be used as block mask images.

Examples

You can use different commands depending on your requirement to add an image. These commands can be added in the **Icon & Ports** pane of the Mask Editor dialog box.

| Syntax | Description |
|---|---|
| <code>image('icon.jpg')</code> | Reads the icon image from a JPEG file named <code>icon.jpg</code> in the MATLAB path. |
| <code>[data, map]=image('label.gif');</code> <code>pic=ind2rgb(data,map);</code> | Reads and converts a GIF file, <code>label.gif</code> , to the appropriate matrix format. |
| <code>image(pic)</code> | Reads the converted label image. |

See Also

patch | plot

Introduced before R2006a

patch

Draw color patch of specified shape on masked subsystem icon

Syntax

```
patch(x, y)
patch(x, y, [r g b])
```

Description

`patch(x, y)` creates a solid patch having the shape specified by the coordinate vectors `x` and `y`. The patch's color is the current foreground color.

`patch(x, y, [r g b])` creates a solid patch of the color specified by the vector `[r g b]`, where `r` is the red component, `g` the green, and `b` the blue. For example,

```
patch([0 .5 1], [0 1 0], [1 0 0])
```

creates a red triangle on the mask's icon.

Examples

The command

```
patch([0 .5 1], [0 1 0], [1 0 0])
```

creates a red triangle on the mask's icon.

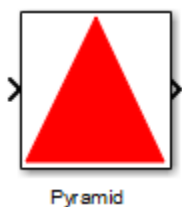

See Also

`image` | `plot`

Introduced before R2006a

plot

Draw graph connecting series of points on masked subsystem icon

Syntax

```
plot(Y)
plot(X1,Y1,X2,Y2,...)
```

Description

`plot(Y)` plots, for a vector Y , each element against its index. If Y is a matrix, it plots each column of the matrix as though it were a vector.

`plot(X1,Y1,X2,Y2,...)` plots the vectors $Y1$ against $X1$, $Y2$ against $X2$, and so on. Vector pairs must be the same length and the list must consist of an even number of vectors.

Plot commands can include `NaN` and `inf` values. When Simulink software encounters `NaNs` or `infs`, it stops drawing, and then begins redrawing at the next numbers that are not `NaN` or `inf`. The appearance of the plot on the icon depends on the units defined by the **Icon units** option in the Mask Editor.

Simulink software displays three question marks (? ? ?) in the block icon and issues warnings in these situations:

- When you have not defined values for the parameters used in the drawing commands (for example, when you first create the mask, but have not yet entered values in the Mask Settings dialog box)
- When you enter a masked block parameter or drawing command incorrectly

The `plot` command in masking supports a subset of the syntax of the MATLAB `plot` command. The `plot` command in masking supports all numeric data types and accepts only numbers as input.

Examples

The command

```
plot([0 1 5], [0 0 4])
```

generates the plot that appears on the icon for the Ramp block, in the Sources library.



See Also

image

Introduced before R2006a

port_label

Draw port label on masked subsystem icon

Syntax

```
port_label('port_type', port_number, 'label')
port_label('port_type', port_number, 'label', 'texmode', 'on')
```

Description

`port_label('port_type', port_number, 'label')` draws a label on a port. Valid values for `port_type` include the following.

| Value | Description |
|---------|--|
| input | Simulink input port |
| output | Simulink output port |
| lconn | Physical Modeling connection port on the left side of a masked subsystem |
| rconn | Physical Modeling connection port on the right side of a masked subsystem |
| Enable | Label for the enable port in a masked Triggered or Enabled and Triggered subsystem. |
| trigger | Label for the trigger port in a masked Triggered or Enabled and Triggered subsystem. |
| action | Label for the action port in a masked Switch Case Action Subsystem. |

The input argument `port_number` is an integer, and `label` is text specifying the port's label.

Note Physical Modeling port labels are assigned based on the nominal port location. If the masked subsystem has been rotated or flipped, for example, a port labeled using 'lconn' as the `port_type` may not appear on the left side of the block.

`port_label('port_type', port_number, 'label', 'texmode', 'on')` lets you use TeX formatting commands in `label`. The TeX formatting commands allow you to include symbols and Greek letters in the port label. See "Interpreter" for information on the TeX formatting commands that the Simulink software supports.

Note Simulink does not support LaTeX formatting commands.

Examples

The command

```
port_label('input', 1, 'a')
```

defines a as the label of input port 1.

The command

```
port_label('Enable','En')
```

defines En as the label of Enable port.

The command

```
port_label('trigger','Tr')
```

defines Tr as the label of trigger port.

The command

```
port_label('action','Switch():')
```

defines Switch(): as the label of action port.

The command

```
port_label('trigger','\surd m','interpreter','tex')
```

defines the label of trigger port with TeX interpretation.

The commands

```
disp('Card\nSwapper');  
port_label('input',1,'\spadesuit','texmode','on');  
port_label('output',1,'\heartsuit','texmode','on');
```

draw playing card symbols as the labels of the ports on a masked subsystem.

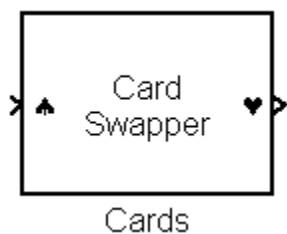

See Also

disp | fprintf | text

Introduced before R2006a

text

Display text at specific location on masked subsystem icon

Syntax

```
text(x, y, 'text')
text(x, y, 'text', 'horizontalAlignment', 'halign',
     'verticalAlignment', 'valign')
text(x, y, 'text', 'texmode', 'on')
```

Description

The `text` command places a character vector at a location specified by the point (x, y) whose units are defined by the **Icon units** option in the Mask Editor.

`text(x,y, text, 'texmode', 'on')` allows you to use TeX formatting commands in `text`. The TeX formatting commands in turn allow you to include symbols and Greek letters in icon text. See “Interpreter” for information on the TeX formatting commands supported by Simulink software.

You can optionally specify the horizontal and/or vertical alignment of the text relative to the point (x, y) in the `text` command.

The `text` command offers the following horizontal alignment options.

| Option | Aligns |
|----------|--|
| 'left' | The left end of the text at the specified point |
| 'right' | The right end of the text at the specified point |
| 'center' | The center of the text at the specified point |

The `text` command offers the following vertical alignment options.

| Option | Aligns |
|----------|--|
| 'base' | The baseline of the text at the specified point |
| 'bottom' | The bottom line of the text at the specified point |
| 'middle' | The midline of the text at the specified point |
| 'cap' | The capitals line of the text at the specified point |
| 'top' | The top of the text at the specified point |

Note While this `text` function is identical in name to its corresponding MATLAB function, it provides only the functionality described on this page.

Examples

Text Alignment

Center the mask icon text foobar.

```
text(0.5, 0.5, 'foobar', 'horizontalAlignment', 'center')
```

Equation in Mask Icon

Draw a left-aligned equation as the mask icon.

In the Icons & Ports dialog of the Mask Editor, set **Icon units** to Normalized.

In the **Icon drawing commands** text box, enter the following command.

```
text(.05,.5,'\itEquation:} \Sigma \alpha^2 +  
\beta^2 \rightarrow \infty, \Pi, \phi_3 = {\bfcool}',  
'hor','left','texmode','on')
```

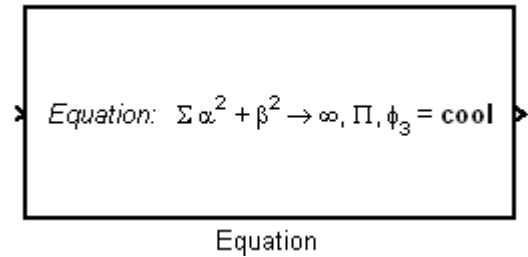

See Also

disp | fprintf | port_label

Introduced before R2006a

block_icon

Promote a block icon image to the masked Subsystem

Syntax

```
block_icon(BlockName)
```

Description

`block_icon(BlockName)` displays the underneath block icon image on the masked Subsystem icon. For more information, see `slexMaskDrawingExamples`.

Input Arguments

BlockName — Name of the underneath block

string

The name of the underneath block whose icon image you want to display on the Subsystem block that encapsulates the specified block. For more information, see `slexMaskDrawingExamples`

Data Types: `string`

See Also

`Simulink.Mask` | `slexMaskDrawingExamples`

Introduced in R2006b

Simulink Debugger Commands

| | |
|----------|---|
| ashow | Show algebraic loop |
| atrace | Set algebraic loop trace level for |
| bafter | Insert breakpoint after specified method |
| break | Insert breakpoint before specified method |
| bshow | Show specified block |
| clear | Clear breakpoints from model |
| continue | Continue simulation |
| disp | Display block's I/O when simulation stops |
| ebreak | Enable (or disable) breakpoint on solver errors |
| elist | List simulation methods in order in which they are executed during simulation |
| emode | Toggle model execution between accelerated and normal mode |
| etrace | Enable or disable method tracing |
| help | Display help for debugger commands |
| nanbreak | Set or clear nonfinite value break mode |
| next | Advance simulation to start of next method at current level in model's execution list |
| probe | I/O and state data for blocks |
| quit | Stop simulation debugger |
| rbreak | Break simulation before solver reset |
| run | Run simulation to completion |
| slist | Sorted list of model blocks |
| states | Current state values |
| status | Debugging options in effect |
| step | Advance simulation by one or more methods |
| stimes | Model sample times |
| stop | Stop simulation |
| strace | Set solver trace level |
| systems | List nonvirtual systems of model |
| tbreak | Set or clear time breakpoint |
| trace | Display block's I/O each time block executes |
| undisp | Remove block from debugger's list of display points |
| untrace | Remove block from debugger's list of trace points |
| where | Display current location of simulation in simulation loop |
| xbreak | Break when debugger encounters step-size-limiting state |
| zcbreak | Toggle breaking at nonsampled zero-crossing events |
| zclist | List blocks containing nonsampled zero crossings |

ashow

Show algebraic loop

Syntax

```
ashow  
ashow gcb  
ashow s:b  
ashow s#n  
ashow clear
```

Description

ashow returns a list of algebraic loops in the current model.

ashow gcb returns the algebraic loop containing the currently selected block.

ashow s:b returns the algebraic loop containing block b in system s

ashow s#n returns the nth algebraic loop in the system s

ashow clear removes algebraic loop highlighting in the current model

Examples

Use ashow to Find Algebraic Loops in the Simulink Debugger

This example shows you how to find algebraic loops and step through a simulation in the Simulink Debugger.

Highlight algebraic loops during debugging

Open the `ex_sl_demo_hydcyl` model. Start the Simulink debugger. Select **Debug > Breakpoints List > Debug Model** from the toolstrip. You can also start the debugger from the MATLAB command line using `sldebug`

```
sldebug('ex_sl_demo_hydcyl');
```

Run the debugger. In the MATLAB command prompt, enter:

```
ashow
```

```
Found 1 Algebraic loop(s):  
System#Algebraic loop id, number of blocks in loop  
- 0#1, 9 blocks in loop
```

The `ashow` command returns the algebraic loops in the model as well as the number of blocks contained within.

Find algebraic loops containing selected block

Select any nonvirtual block in the model. For example, select the PlotResults block, which is a Scope block.

In the MATLAB command prompt, enter

```
ashow gcb
```

```
Block sldemo_hydcyl/PlotResults isn't in an algebraic loop.
```

The PlotResults block does not belong in any algebraic loop.

In the MATLAB command prompt, enter

```
ashow gcb
```

```
- sldemo_hydcyl/Valve//Cylinder//Piston//Spring Assembly/Control Valve Flow/IC
- sldemo_hydcyl/Valve//Cylinder//Piston//Spring Assembly/Control Valve Flow/signed sqrt
- sldemo_hydcyl/Valve//Cylinder//Piston//Spring Assembly/Control Valve Flow/Product
- sldemo_hydcyl/Valve//Cylinder//Piston//Spring Assembly/laminar flow pressure drop
- sldemo_hydcyl/Valve//Cylinder//Piston//Spring Assembly/Sum7
- sldemo_hydcyl/Pump/IC
- sldemo_hydcyl/Valve//Cylinder//Piston//Spring Assembly/Control Valve Flow/Sum1 (algebraic variable)
- sldemo_hydcyl/Pump/Sum1
- sldemo_hydcyl/Pump/leakage (algebraic variable)
```

The laminar flow pressure drop block is contained in an algebraic loop with 8 other blocks.

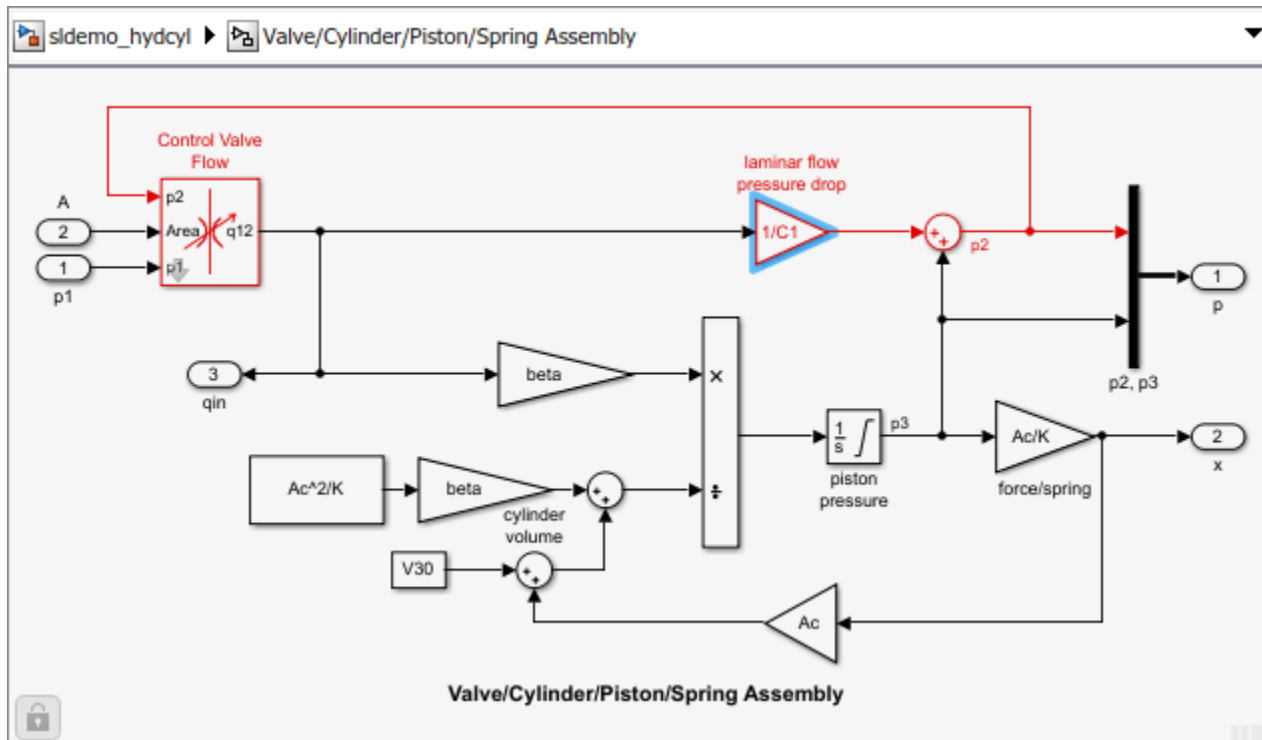

Input Arguments

gcb – Currently selected block

gcb

Currently selected block, specified as gcb.

Example: `ashow gcb`

s:b – Block in model

system index:block index

Block index in the model, specified as system index:block index.

Example: `ashow 1:1`

Data Types: double

s#n – Algebraic loop index

system index#loop index

Algebraic loop index, specified as system index#loop index

Example: `ashow 0#1`

Data Types: double

clear – Remove highlighting

clear

Remove algebraic loop highlighting from model.

See Also

atrace

Topics

“Identify Algebraic Loops in Your Model”

Introduced before R2006a

atrace

Set algebraic loop trace level for

Syntax

```
atrace level
```

```
at level
```

Arguments

level Trace level (0 = none, 4 = everything).

Description

The `atrace` command sets the algebraic loop trace level for a simulation.

| Command | Displays for Each Algebraic Loop |
|-----------------------|---|
| <code>atrace 0</code> | No information |
| <code>atrace 1</code> | The loop variable solution, the number of iterations required to solve the loop, and the estimated solution error |
| <code>atrace 2</code> | Same as level 1 |
| <code>atrace 3</code> | Level 2 plus Jacobian matrix used to solve loop |
| <code>atrace 4</code> | Level 3 plus intermediate solutions of the loop variable |

See Also

`states` | `systems`

Introduced before R2006a

bafter

Insert breakpoint after specified method

Syntax

```
bafter
```

```
ba
```

```
bafter m:mid
```

```
bafter <(taskId)sysIdx:blkIdx | gcb> [mth] [tid:TID]
```

```
bafter <s:sysIdx | gcs> [mth] [tid:TID]
```

```
bafter model [mth] [tid:TID]
```

```
bafter modelName <(taskId)sysIdx:blkIdx | gcb> [mth] [tid:TID]
```

Arguments

| | |
|------------------|---|
| <i>mid</i> | Method ID |
| <i>taskId</i> | Task ID |
| <i>blkIdx</i> | Block ID |
| gcb | Currently selected block |
| <i>sysIdx</i> | System ID |
| <i>gcs</i> | Currently selected system |
| model | Currently selected model |
| <i>mth</i> | A method name, e.g., <code>Outputs.Major</code> |
| <i>TID</i> | Task ID |
| <i>modelName</i> | The name of the referenced model within the hierarchy of the top model, which is under debugging. |

Description

`bafter` inserts a breakpoint after the current method.

Instead of `bafter`, you can use the short form of `ba` with any of the syntaxes.

`bafter m:mid` inserts a breakpoint after the method specified by *mid* (see “Method ID”).

`bafter (taskId)sysIdx:blkIdx` inserts a breakpoint after each invocation of the method of the block specified by *sysIdx:blkIdx* (see “Block ID”) in major time steps. `bafter gcb` inserts a breakpoint after each invocation of a method of the currently selected block (see `gcb`) in major time steps.

`bafter s:sysIdx` inserts a breakpoint after each method of the root system or nonvirtual subsystem specified by the system ID: *sysIdx*.

Note The `systems` command displays the system IDs for all nonvirtual systems in the currently selected model.

`bafter gcs` inserts a breakpoint after each method of the currently selected nonvirtual system.

`bafter model` inserts a breakpoint after each method of the currently selected model.

The optional `meth` parameter allow you to set a breakpoint after a particular block, system, or model method and task. For example, `bafter gcb Outputs` sets a breakpoint after the Outputs method of the currently selected block.

The optional TID parameter allows you to set a breakpoint after invocation of a method by a particular task. For example, suppose that the currently selected nonvirtual subsystem operates on task 2 and 3. Then `bafter gcs Outputs tid:2` sets a breakpoint after the invocation of the subsystem's Outputs method that occurs when task 2 is active.

See Also

`break` | `ebreak` | `tbreak` | `xbreak` | `nanbreak` | `zcbreak` | `rbreak` | `clear` | `where` | `slist` | `systems`

Introduced before R2006a

break

Insert breakpoint before specified method

Syntax

```
break
```

```
b
```

```
break m:mid
```

```
break mdl
```

```
break mdl [mth] [tid:TID]
```

```
break <(taskId)sysIdx:blkIdx | gcb> [mth] [tid:TID]
```

```
break <(taskId)sysIdx:blkIdx | gcb>
```

```
break <s:sysIdx | gcs> [mth] [tid:TID]
```

```
break modelName [mth] [tid:TID]
```

```
break modelName < (taskId)sysIdx:blkIdx> [mth] [tid:TID]
```

Arguments

| | |
|----------------------|---|
| <i>mid</i> | Method ID |
| <i>taskId</i> | Task ID |
| <i>sysIdx:blkIdx</i> | Block ID |
| gcb | Currently selected block |
| <i>sysIdx</i> | System ID |
| <i>gcs</i> | Currently selected system |
| modelName | Currently selected model |
| <i>mth</i> | A method name, e.g., <code>Outputs.Major</code> |
| <i>TID</i> | task ID |
| <i>mdl</i> | Given model |

Description

`break` inserts a breakpoint before the current method.

Instead of `break`, you can use the short form of `b` with any of the syntaxes.

`break mdl` breaks at each method of model (`mdl`). `mdl` refers to the top model.

`break mdl [mth] [tid:TID]` breaks at the method `[mth]` at `tid` (`TID`) of model (`mdl`).

`break m:mid` inserts a breakpoint before the method specified by `mid` (see “Method ID”).

`break (taskIdx)sysIdx:blkIdx` inserts a breakpoint before each invocation of the method of the block specified by `sysIdx:blkIdx` (see “Block ID”) in major time steps. `break gcb` inserts a breakpoint before each invocation of a method of the currently selected block (see `gcb`) in major times steps.

`break s:sysIdx` inserts a breakpoint at each method of the root system or nonvirtual subsystem specified by the system ID: `sysIdx`.

Note The `systems` command displays the system IDs for all nonvirtual systems in the currently selected model.

`break gcs` inserts a breakpoint at each method of the currently selected nonvirtual system.

`break model` inserts a breakpoint at each method of the currently selected model.

Note Do not use a model name instead of identifier `model` in the `break model` command.

The optional `meth` parameter allow you to set a breakpoint at a particular block, system, or model method. For example, `break gcb Outputs` sets a breakpoint at the `Outputs` method of the currently selected block.

The optional TID parameter allows you to set a breakpoint at the invocation of a method by a particular task. For example, suppose that the currently selected nonvirtual subsystem operates on task 2 and 3. Then `break gcs Outputs tid:2` sets a breakpoint at the invocation of the subsystem's `Outputs` method that occurs when task 2 is active.

`break <(taskIdx)sysIdx:blkIdx | gcb>` breaks at each method of block `((taskIdx)sysIdx:blkIdx)`.

`break modelName < (taskIdx)sysIdx:blkIdx> [meth] [tid:TID]` breaks at the method `[meth]` at `tid` (TID) of block `((taskIdx)sysIdx:blkIdx)` in the model (`modelName`).

See Also

`bafter` | `clear` | `ebreak` | `nanbreak` | `rbreak` | `systems` | `tbreak` | `where` | `xbreak` | `zcbreak` | `slist`

Introduced before R2006a

bshow

Show specified block

Syntax

```
bshow (t)s:b
```

```
bshow [modelName] (taskIdx)sysIdx:blkIdx
```

```
bs s:b
```

Arguments

| | |
|---------------|---|
| (t)s:b | The block whose task index is <i>t</i> , system index is <i>s</i> and block index is <i>b</i> . |
| modelName s:b | The name of the model that is referenced followed by the block whose system index is <i>s</i> and block index is <i>b</i> . |

Description

The `bshow` command opens the model window containing the specified block and selects the block.

`bshow [modelName] (taskIdx)sysIdx:blkIdx` shows block in system, `sysIdx`, with sorted list index, `blkIdx`, in the given task, `taskIdx`. The system and block are picked from the top model, unless referenced model is specified through `modelName`.

See Also

`slist`

Introduced before R2006a

clear

Clear breakpoints from model

Syntax

```
clear
```

```
cl
```

```
clear m:mid
```

```
clear id
```

```
clear <(taskIdx)sysIdx:blkIdx | gcb>
```

Arguments

| | |
|---------------------------------|--------------------------|
| <i>mid</i> | Method ID |
| <i>id</i> | Breakpoint ID |
| <i>taskIdx</i> | Task ID |
| <i>sysIdx:blkI</i> <i>dx</i> | Block ID |
| gcb | Currently selected block |

Description

`clear` clears a breakpoint from the current method.

Instead of `clear`, you can use the short form of `cl` with any of the syntaxes.

`clear m:mid` clears a breakpoint from the method specified by *mid*.

`clear id` clears the breakpoint specified by the breakpoint ID *id*.

`clear sysIdx:blkIdx` clears any breakpoints set on the methods of the block specified by *sysIdx:blkIdx*.

`clear gcb` clears any breakpoints set on the methods of the currently selected block.

See Also

`break` | `bafter` | `slist`

Introduced before R2006a

continue

Continue simulation

Syntax

```
continue
```

```
c
```

Description

The `continue` command continues the simulation from the current breakpoint. If animation mode is not enabled, the simulation continues until it reaches another breakpoint or its final time step. If animation mode is enabled, the simulation continues in animation mode to the first method of the next major time step, ignoring breakpoints.

See Also

`run` | `stop` | `quit`

Introduced before R2006a

disp

Display block's I/O when simulation stops

Syntax

```
disp
```

```
d
```

```
disp gcb
```

```
disp (t)s:b
```

```
disp modelName (t)s:b
```

Arguments

Syntax and Description

| Syntax | Description |
|---------------|--|
| (t)s:b | The block whose task index is <i>t</i> , system index is <i>s</i> and block index is <i>b</i> . |
| modelName s:b | The name of the referenced model within the hierarchy of the top model, which is under debugging followed by the block whose task index is <i>t</i> , system index is <i>s</i> and block index is <i>b</i> . |
| gcb | Current block. |

Description

The `disp` command registers a block as a display point. The debugger displays the inputs and outputs of all display points in the MATLAB Command Window whenever the simulation halts. Invoking `disp` without arguments shows a list of display points. Use `undisp` to unregister a block.

Instead of `disp`, you can use the short form of `d` with any of the syntaxes.

See Also

`undisp` | `slist` | `probe` | `trace`

Introduced before R2006a

ebreak

Enable (or disable) breakpoint on solver errors

Syntax

ebreak

eb

Description

This command causes the simulation to stop if the solver detects a recoverable error in the model. If you do not set or disable this breakpoint, the solver recovers from the error and proceeds with the simulation without notifying you.

See Also

break | bafter | tbreak | xbreak | nanbreak | zcbreak | rbreak | clear | where | slist | systems

Introduced before R2006a

elist

List simulation methods in order in which they are executed during simulation

Syntax

```
elist
```

```
el
```

```
elist m:mid [tid:TID]
```

```
elist <gcs | s:sysIdx> [mth] [tid:TID]
```

```
elist <gcb | (taskId)sysIdx:blkIdx> [mth] [tid:TID]
```

```
elist [modelName] <(taskId)sysIdx:blkIdx >
```

Description

Instead of `elist`, you can use the short form of `el` with any of the syntaxes.

`elist m:mid` lists the methods invoked by the system or nonvirtual subsystem method corresponding to the method id *mid* (see the `where` command for information on method IDs), e.g.,

```
(sldebug @19): elist m:19

RootSystem.Outputs 'vdp' [tid=0] : ← Calling method
 0:0 Integrator.Outputs 'vdp/x1' [tid=0]
 0:1 Outport.Outputs 'vdp/Out1' [tid=0]
 0:2 Integrator.Outputs 'vdp/x2' [tid=0]
 ...
 ↑      ↑      ↑      ↑
Block id Method Block Task id
```

The method list specifies the calling method followed by the methods that it calls in the order in which they are invoked. The entry for the calling method includes

- The name of the method

The name of the method is prefixed by the type of system that defines the method, e.g., `RootSystem`.

- The name of the model or subsystem instance on which the method is invoked
- The ID of the task that invokes the method

The entry for each called method includes

- The ID (*(taskId)sysIdx:blkIdx*) of the block instance on which the method is invoked

The block ID is prefixed by a number specifying the system that contains the block (the *sysIdx*). This allows Simulink software to assign the same block ID to blocks residing in different subsystems.

- The name of the method

The method name is prefixed with the type of block that defines the method, e.g., Integrator.

- The name of the block instance on which the method is invoked
- The task that invokes the method

The optional task ID parameter (**tid:TID**) allows you to restrict the displayed lists to methods invoked for a specified task. You can specify this option only for system or atomic subsystem methods that invoke Outputs or Update methods.

`elist <gcs | s:sysIdx>` lists the methods executed for the currently selected system (specified by the `gcs` command) or the system or nonvirtual subsystem specified by the system ID *sysIdx*, e.g.,

```
(sdebug @19): elist gcs

RootSystem.Start 'vdp':
  0:0 Integrator.Start 'vdp/x1'
  0:2 Integrator.Start 'vdp/x2'
  0:4 Scope.Start 'vdp/Scope'
  0:5 Fcn.Start 'vdp/Fcn'
  0:6 Product.Start 'vdp/Product'
  0:7 Gain.Start 'vdp/Mu'
  0:8 Sum.Start 'vdp/Sum'

RootSystem.Initialize 'vdp':
  0:0 Integrator.Initialize 'vdp/x1'
  ...
```

The system ID of a model's root system is 0. You can use the debugger's `systems` command to determine the system IDs of a model's subsystems.

Note The `elist` and `where` commands use block IDs to identify subsystems in their output. The block ID for a subsystem is not the same as the system ID displayed by the `systems` command. Use the `elist (taskIdx)sysIdx:blkIdx` form of the `elist` command to display the methods of a subsystem whose block ID appears in the output of a previous invocation of the `elist` or `where` command.

`elist m:mid [tid:TID]` displays the system execution list(s) identified by the system method, `mid` and `tid`.

`elist <gcs | s:sysIdx> mth` lists methods of type *mth* to be executed for the system specified by the `gcs` command or the system ID *sysIdx*, e.g.,

```
(sldebug @19): elist gcs Start

RootSystem.Start 'vdp':
  0:0 Integrator.Start 'vdp/x1'
  0:2 Integrator.Start 'vdp/x2'
  0:4 Scope.Start 'vdp/Scope'
  0:5 Fcn.Start 'vdp/Fcn'
  0:6 Product.Start 'vdp/Product'
  0:7 Gain.Start 'vdp/Mu'
  0:8 Sum.Start 'vdp/Sum'
  ...
```

Use `elist gcb` to list the methods invoked by the nonvirtual subsystem currently selected in the model.

`elist m:mid [tid:TID]` displays the system execution list(s) identified by the system method, `mid` and `tid`.

`elist [modelName] < (taskIdx)sysIdx:blkIdx >` displays the system execution list(s) identified by the subsystem block ((*taskIdx*)*sysIdx:blkIdx*), method, `mth`, and `tid` in the referenced model identified by `modelName`.

`elist <gcb | (taskIdx)sysIdx:blkIdx> [mth] [tid:TID]` displays the system execution list(s) identified by the subsystem block ((*taskIdx*)*sysIdx:blkIdx*), method, `mth`, and `tid`.

See Also

where | `slist` | `systems`

Introduced before R2006a

emode

Toggle model execution between accelerated and normal mode

Syntax

emode

em

Description

Toggles the simulation between accelerated and normal mode when using the Accelerator mode in Simulink software. For more information, see “Run Accelerator Mode with the Simulink Debugger”.

Introduced before R2006a

etrace

Enable or disable method tracing

Syntax

```
etrace level level-number
```

```
et level level-number
```

Description

This command enables or disables method tracing, depending on the value of `level`:

| Level | Description |
|-------|---|
| 0 | Turn tracing off. |
| 1 | Trace model methods. |
| 2 | Trace model and system methods. |
| 3 | Trace model, system, and block methods. |

When method tracing is on, the debugger prints a message at the command line every time a method of the specified level is entered or exited. The message specifies the current simulation time, whether the simulation is entering or exiting the method, the method id and name, and the name of the model, system, or block to which the method belongs.

See Also

`elist` | `where` | `trace`

Introduced before R2006a

help

Display help for debugger commands

Syntax

help

?

h

Description

The help command displays a list of debugger commands in the command window. The list includes the syntax and a brief description of each command.

Introduced before R2006a

nanbreak

Set or clear nonfinite value break mode

Syntax

nanbreak

na

Description

The `nanbreak` command causes the debugger to break whenever the simulation encounters a nonfinite (NaN or Inf) value. If nonfinite break mode is set, `nanbreak` clears it.

See Also

`break` | `bafter` | `rbreak` | `tbreak` | `xbreak` | `zcbreak`

Topics

`ebreak`

Introduced before R2006a

next

Advance simulation to start of next method at current level in model's execution list

Syntax

next

n

Description

The `next` command advances the simulation to the start of the next method at the current level in the model's method execution list.

Note The `next` command has the same effect as the `step over` command. See `step` for more information.

See Also

`step`

Introduced before R2006a

probe

I/O and state data for blocks

Syntax

```
probe
probe (t)s:b
probe modelName (t)s:b
probe gcb
probe level level-type
p
```

Description

`probe` sets the Simulink debugger to interactive probe mode. In this mode, the debugger displays the I/O of a selected block. To exit interactive probe mode, enter a debugger command or press the **Enter** key.

`probe (t)s:b` displays the I/O of the block whose task index is *t*, system index is *s* and block index is *b*.

`probe modelName (t)s:b` displays the I/O of the block whose task index is *t* system index is *s* and block index is *b* in the *modelName* model.

`probe gcb` displays the I/O of the currently selected block.

`probe level level-type` sets the verbosity level for `probe`, `trace`, and `dis`. If *level-type* is `io`, the debugger displays block I/O. If *level-type* is `all` (default), the debugger displays all information for the current state of a block, including inputs and outputs, states, and zero crossings.

`p` is the short form of the command.

Examples

Display I/O for the currently selected block `Out2` in the model `vdp` using the Simulink debugger.

- 1 In the MATLAB Command Window, enter:

```
sldebug 'vdp'
```

The MATLAB command prompt `>>` changes to the Simulink debugger prompt (`sldebug @0`): `>>`.

- 2 Enter:

```
probe gcb
```

The MATLAB Command Window displays:

```
probe: Data of 0:3 Output block 'vdp/Out2':
U1      = [0]
```

See Also

disp | trace

Introduced in R2007a

quit

Stop simulation debugger

Syntax

```
quit  
q
```

Description

`quit` stops the Simulink debugger and returns to the MATLAB command prompt.

`q` is the short form of the command.

Examples

Start the Simulink debugger for the model `vdp` and then stop it.

- 1 In the MATLAB Command Window, enter:

```
sldebug 'vdp'
```

The MATLAB command prompt `>>` changes to the Simulink debugger prompt (`sldebug @0`): `>>`.

- 2 Enter:

```
quit
```

See Also

`stop`

Introduced before R2006a

rbreak

Break simulation before solver reset

Syntax

```
rbreak  
rb
```

Description

`rbreak` enables (or disables) a solver reset breakpoint if the breakpoint is disabled (or enabled). The breakpoint causes the debugger to halt the simulation whenever an event requires a solver reset. The halt occurs before the solver resets.

`rb` is the short form of the command.

Examples

Start Simulink debugger for the model `vdp` and a set breakpoint before a solver reset.

- 1 In the MATLAB Command Window, enter:

```
sldebug 'vdp'
```

The MATLAB command prompt `>>` is replaced with the Simulink debugger prompt (`sldebug @0`): `>>`.

- 2 Enter:

```
rbreak
```

The MATLAB Command Window displays:

```
Break on solver reset request           : enabled
```

See Also

`break` | `bafter` | `nanbreak` | `ebreak` | `tbreak` | `xbreak` | `zcbreak`

Introduced before R2006a

run

Run simulation to completion

Syntax

```
run  
r
```

Description

`run` starts the simulation from the current breakpoint to its final time step. It ignores breakpoints and display points.

`r` is the short form of the command

Examples

Continue the simulation for the model `vdp` using the Simulink debugger.

- 1 In the MATLAB Command Window, enter:

```
sldebug 'vdp'
```

The MATLAB command prompt `>>` changes to the Simulink debugger prompt `(sldebug @0): >>`.

- 2 Enter:

```
run
```

See Also

`continue` | `stop` | `quit`

Introduced before R2006a

slist

Sorted list of model blocks

Syntax

```
slist
sli
```

Description

`slist` displays a list of blocks for the root system and each nonvirtual subsystem sorted according to data dependencies and other criteria.

For each system (root or nonvirtual), `slist` displays:

- Title line specifying the name of the system, the number of nonvirtual blocks that the system contains, and the number of blocks in the system that have direct feedthrough ports.
- Entry for each block in the order in which the blocks appear in the sorted list.

For each block entry, `slist` displays the block ID and the name and type of the block. The block ID consists of a system index and a block index separated by a colon (`sysIdx:blkIdx`).

- Block index is the position of the block in the sorted list.
- System index is the order in which the Simulink software generated the system sorted list. The system index has no special significance. It simply allows blocks that appear in the same position in different sorted lists to have unique identifiers.

Simulink software uses sorted lists to create block method execution lists (see `elist`) for root system and nonvirtual subsystem methods. In general, root system and nonvirtual subsystem methods invoke the block methods in the same order as the blocks appear in the sorted list.

Exceptions occur in the execution order of block methods. For example, execution lists for multicast models group together all blocks operating at the same rate and in the same task. Slower groups appear later than faster groups. The grouping of methods by task can result in a block method execution order that is different from the block sorted order. However, within groups, methods execute in the same order as the corresponding blocks appear in the sorted list.

`sli` is the short form of the command.

Examples

Display a sorted list of the root system in the `vdp` model using the Simulink debugger.

- 1 In the MATLAB Command Window, enter:

```
sldebug 'vdp'
```

The MATLAB command prompt `>>` changes to the Simulink debugger prompt (`sldebug @0`): `>>`.

- 2 Enter:

slist

When 'Signal storage reuse' in the Configuration Parameters is enabled, block I/O values displayed in the debugger may not be correct. In order to preserve block output signal values, disable 'Signal storage reuse' in the Configuration Parameters dialog box. The MATLAB Command Window displays:

```
---- Sorted list for 'vdp' [11 nonvirtual block(s), directFeed=0]
      Total number of tasks = 2
- Sorted list of task index [0], 10 nonvirtual block(s)
(0)0:1  'vdp/x1' (Integrator)
      Input ports: [0]
      Output ports: [0]
(0)0:2  'vdp/Out1' (Outport)
      Input ports: [0]
      Output ports: []
(0)0:3  'vdp/x2' (Integrator)
      Input ports: [0]
      Output ports: [0]
(0)0:4  'vdp/Out2' (Outport)
      Input ports: [0]
      Output ports: []
(0)0:5  'vdp/Scope' (Scope)
      Input ports: [0]
      Output ports: []
(0)0:6  'vdp/Square' (Math)
      Input ports: [0]
      Output ports: [0]
(0)0:7  'vdp/Sum1' (Sum)
      Input ports: [0 1]
      Output ports: [0]
(0)0:8  'vdp/Product' (Product)
      Input ports: [0 1]
      Output ports: [0]
(0)0:9  'vdp/Mu' (Gain)
      Input ports: [0]
      Output ports: [0]
(0)0:10 'vdp/Sum' (Sum)
      Input ports: [0 1]
      Output ports: [0]

----- Task Index Legend -----
Task Index [0]: Cont
-----
```

See Also

systems | elist

Introduced before R2006a

states

Current state values

Syntax

states

Description

states displays a list of the current states of the model. The list includes the index, current value, system:block:element ID, state vector name, and block name for each state.

Examples

Display information about the states for the vdp model.

- 1 In the MATLAB Command Window, enter:

```
sldebug 'vdp'
```

The MATLAB command prompt >> changes to the Simulink debugger prompt (sldebug @0): >>.

- 2 Enter:

```
states
```

The MATLAB Command Window displays:

```
Continuous States:
Idx  Value                                     (system:block:element Name  'BlockName')
  0   0                                     (0:0:0  CSTATE  'vdp/x1')
  1   0                                     (0:2:0  CSTATE  'vdp/x2')
```

Introduced before R2006a

status

Debugging options in effect

Syntax

Description

Display a list of the debugging options in effect.

Examples

View Debugger Status for vdp

Start the debugger with vdp. The command prompt changes to the Simulink debugger prompt (sldebug @0): >>.

```
sldebug 'vdp'
```

Display the debugging status.

```
status

%------%
Current simulation time           : 0 (MajorTimeStep)
Solver needs reset                : no
Solver derivatives cache needs reset : no
Zero crossing signals cache needs reset : no
Default command to execute on return/enter : ""
Break at zero crossing events     : disabled
Break on solver error             : disabled
Break on failed integration step  : disabled
Time break point                 : disabled
Break on non-finite (NaN,Inf) values : disabled
Break on solver reset request    : disabled
Display level for disp, trace, probe : 1 (i/o, states)
Solver trace level               : 0
Algebraic loop tracing level     : 0
Animation Mode                  : off
Execution Mode                  : Normal
Display level for etrace         : 0 (disabled)
Break points                    : none installed
Display points                   : none installed
```

Introduced before R2006a

step

Advance simulation by one or more methods

Syntax

```
step
step in
step over
step out
step top
step blockmth
s
```

Description

`step` or `step in` advances the simulation to the next method in the current time step.

`step over` advances the simulation over the next method.

`step out` advances the simulation the end of the current simulation point hierarchy.

`step top` advances the simulation to the first method executed in the next time step.

`step blockmth` advances the simulation to the next method that operates on a block.

`s` is the short form of the command.

If `step` advances the simulation to the start of a block method, the debugger points at the block on which the method operates.

.

Examples

The following diagram illustrates the effect of various forms of the `step` command for the model `vdp`.

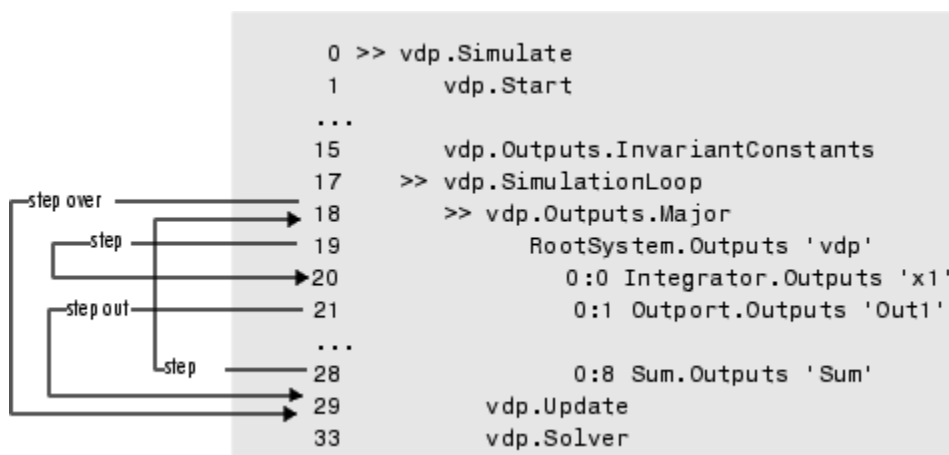

See Also

next | where | elist

Introduced in R2007a

stimes

Model sample times

Syntax

```
stimes  
sti
```

Description

`stimes` displays information about the model sample times, including the sample time period, offset, and task ID.

`sti` is the short form of the command.

Examples

Display sample times for the model `vdp` using the Simulink debugger.

- 1 In the MATLAB Command Window, enter:

```
sldebug 'vdp'
```

The MATLAB command prompt `>>` changes to the Simulink debugger prompt (`sldebug @0`): `>>`.

- 2 Enter:

```
stimes
```

The MATLAB Command Window displays:

```
--- Sample times for 'vdp' [Number of sample times = 2]  
  1. tid=0 (continuous)  
  2. tid=1 (value = inf in ModelWideParameterChangeEvent)
```

Introduced before R2006a

stop

Stop simulation

Syntax

```
stop
```

Description

`stop` stops the simulation of the model you are debugging.

Examples

Start and stop a simulation for the model `vdp` using the Simulink debugger.

- 1 Start a debugger session. In the MATLAB Command Window, enter:

```
sldebug 'vdp'
```

The MATLAB command prompt `>>` changes to the Simulink debugger prompt (`sldebug @0`): `>>`.

- 2 Start a simulation of the model. Enter:

```
run
```

- 3 Stop the simulation. Enter:

```
stop
```

See Also

`continue` | `run` | `quit`

Introduced before R2006a

strace

Set solver trace level

Syntax

```
strace level
i
```

Description

`strace level` causes the solver to display diagnostic information in the MATLAB Command Window, depending on the value of `level`. Values are 0 (no information) or 4 (maximum information about time steps, integration steps, zero crossings, and solver resets).

`i` is the short form of the command.

Examples

Display maximum information about a simulation for the model `vdp` using the Simulink debugger.

- 1 In the MATLAB Command Window, enter:

```
sldebug 'vdp'
```

The MATLAB command prompt `>>` changes to the Simulink debugger prompt (`sldebug @0`): `>>`.

- 2 Get information about the notation. Enter:

```
help time
```

The MATLAB Command Window displays:

```
Time is displayed as:
TM = <time while in MajorTimeStep>
Tm = <time while in MinorTimeStep>
Tr = <time while in solver reset>
Tz = <time at or just after zero crossing>
TzL = <time while in major step just before (at left post of) zero crossing>
TzR = <time while in major step at or just after (at right post of) zero crossing>
Ts = <time of successful integration step>
Tf = <time of failed integration step>
Tn = <time while in Newton iteration> (when using implicit solvers)
Tj = <time during Jacobian evaluation> (when using implicit solvers)

Step size is displayed as:
Hm = <step size at the start of solver phase>
Hs = <successful integration step size>
Hf = <failed integration step size>
Hn = <step size during Newton iteration> (when using implicit solvers)
Hz = <value of 'TM - TzL' during zero crossing search>
Iz = <value of 'Tz - TzL' during zero crossing search>
```

- 3 Set trace to display all information. Enter:

```
strace 1
```

When diagnostic tracing is on, the debugger displays the start of major and minor time steps.

```
[TM = 13.21072088374186 ] Start of Major Time Step
[Tm = 13.21072088374186 ] Start of Minor Time Step
```

The debugger displays integration information. This information includes the time step of the integration method, step size of the integration method, outcome of the integration step, normalized error, and index of the state.

```
[Tm = 13.21072088374186 ] [H = 0.2751116230148764 ] Begin Integration Step
[Tf = 13.48583250675674 ] [Hf = 0.2751116230148764 ] Fail [Er = 1.0404e+000]
  [Ix = 1]
[Tm = 13.21072088374186 ] [H = 0.2183536061326544 ] Retry
[Ts = 13.42907448987452 ] [Hs = 0.2183536061326539 ] Pass [Er = 2.8856e-001]
  [Ix = 1]
```

For zero crossings, the debugger displays information about the iterative search algorithm when the zero crossing occurred. This information includes the time step of the zero crossing, step size of the zero crossing detection algorithm, length of the time interval bracketing the zero crossing, and a flag denoting the rising or falling direction of the zero crossing.

```
[Tz = 3.615333333333301 ] Detected 1 Zero Crossing Event 0[F]
  Begin iterative search to bracket zero crossing event
[Tz = 3.621111157580072 ] [Hz = 0.005777824246771424 ] [Iz = 4.2222e-003] 0[F]
[Tz = 3.621116982080098 ] [Hz = 0.005783648746797265 ] [Iz = 4.2164e-003] 0[F]
[Tz = 3.621116987943544 ] [Hz = 0.005783654610242994 ] [Iz = 4.2163e-003] 0[F]
[Tz = 3.621116987943544 ] [Hz = 0.005783654610242994 ] [Iz = 1.1804e-011] 0[F]
[Tz = 3.621116987949452 ] [Hz = 0.005783654616151157 ] [Iz = 5.8962e-012] 0[F]
[Tz = 3.621116987949452 ] [Hz = 0.005783654616151157 ] [Iz = 5.1514e-014] 0[F]
  End iterative search to bracket zero crossing event
```

When solver resets occur, the debugger displays the time at which the solver was reset.

```
[Tr = 6.246905153573676 ] Process Solver Reset
[Tr = 6.246905153573676 ] Reset Zero Crossing Cache
[Tr = 6.246905153573676 ] Reset Derivative Cache
```

See Also

[atrace](#) | [etrace](#) | [states](#) | [trace](#) | [zclist](#)

Introduced before R2006a

systems

List nonvirtual systems of model

Syntax

```
systems  
sys
```

Description

systems displays the nonvirtual subsystems for a model in the MATLAB Command Window.

sys is the short form of the command.

Examples

Display the nonvirtual systems for the model `sldemo_enginewc` using the Simulink debugger.

- 1 In the MATLAB Command Window, enter:

```
sldebug 'sldemo_enginewc'
```

The MATLAB command prompt `>>` changes to the Simulink debugger prompt (`sldebug @0`): `>>`.

- 2 Enter:

```
systems
```

The MATLAB Command Window displays the nonvirtual subsystems.

```
Nonvirtual subsystems in model 'sldemo_enginewc':  
0 'sldemo_enginewc/Compression'  
1 'sldemo_enginewc/Controller'  
2 'sldemo_enginewc/Throttle & Manifold/Throttle/TmpAtomicSubsysAtSwitchInport1'  
3 'sldemo_enginewc/valve timing/positive edge to dual edge conversion'  
4 'sldemo_enginewc'
```

See Also

slist

Introduced before R2006a

tbreak

Set or clear time breakpoint

Syntax

`tbreak`

`tb`

`tbreak t`

Description

The `tbreak` command sets a breakpoint at the specified time step. If a breakpoint already exists at the specified time, `tbreak` clears the breakpoint. If you do not specify a time, `tbreak` toggles a breakpoint at the current time step.

Instead of `tbreak`, you can use the short form of `tb`, with or without `t`.

See Also

`break` | `bafter` | `xbreak` | `nanbreak` | `zcbreak` | `rbreak`

Topics

`ebreak`

Introduced before R2006a

trace

Display block's I/O each time block executes

Syntax

```
trace gcb  
trace (t)s:b
```

```
tr gcb  
trace (t)s:b
```

Arguments

(t)s:b The block whose task index is t, system index is s and block index is b.
gcb Current block.

Description

The trace command registers a block as a trace point. The debugger displays the I/O of each registered block each time the block executes.

See Also

disp | probe | untrace | slist | strace

Introduced before R2006a

undisp

Remove block from debugger's list of display points

Syntax

```
undisp gcb
```

```
und gcb
```

```
undisp (t)s:b
```

```
und (t)s:b
```

Arguments

(t)s:b The block whose task index is **t**, system index is **s** and block index is **b**.

gcb Current block.

Description

The `undisp` command removes the specified block from the debugger's list of display points.

See Also

`disp` | `slist`

Introduced before R2006a

untrace

Remove block from debugger's list of trace points

Syntax

```
untrace gcb
```

```
unt gcb
```

```
untrace (t)s:b
```

```
unt (t)s:b
```

Arguments

(t)s:b The block whose task index is *t*, system index is *s* and block index is *b*.

gcb Current block.

Description

The `untrace` command removes the specified block from the debugger's list of trace points.

See Also

`trace` | `slist`

Introduced before R2006a

where

Display current location of simulation in simulation loop

Syntax

where [detail]

w [detail]

Description

The where command displays the current location of the simulation in the simulation loop, for example,

```
sldebug 07): where
0 >> vdp.Simulate
1 >> vdp.Start
2 >> RootSystem.Start 'vdp'
7 >| 0:8 Sum.Start 'Sum'
```

The display consists of a list of simulation nodes with the last entry being the node that is about to be entered or exited. Each entry contains the following information:

- Method ID
 - The method ID identifies a specific invocation of a method.
- A symbol specifying its state:
 - >> (active)
 - >| (about to be entered)
 - <| (about to be exited)
- Name of the method invoked (e.g., RootSystem.Start)
- Name of the block or system on which the method is invoked (e.g., Sum)
- System and block ID (sysIdx:blkIdx) of the block on which the method is invoked

For example, 0:8 indicates that the specified method operates on block 8 of system 0.

where detail, where detail is any nonnegative integer, includes inactive nodes in the display.

```
0 >> vdp.Simulate
  1   >> vdp.Start
  2     >> RootSystem.Start 'vdp'
  3       0:4 Scope.Start 'Scope'
  4         0:5 Fcn.Start 'Fcn'
  5         0:6 Product.Start
'Product '
  6         0:7 Gain.Start 'Mu'
  7         >| 0:8 Sum.Start 'Sum'
```

See Also

step

Introduced before R2006a

xbreak

Break when debugger encounters step-size-limiting state

Syntax

```
xbreak
```

```
x
```

Description

The `xbreak` command pauses execution of the model when the debugger encounters a state that limits the size of the steps that the solver takes. If `xbreak` mode is already on, `xbreak` turns the mode off.

See Also

`break` | `bafter` | `zcbreak` | `tbreak` | `nanbreak` | `rbreak`

Topics

`ebreak`

Introduced before R2006a

zcbreak

Toggle breaking at nonsampled zero-crossing events

Syntax

zcbreak

zcb

Description

The `zcbreak` command causes the debugger to break when a nonsampled zero-crossing event occurs. If zero-crossing break mode is already on, `zcbreak` turns the mode off.

See Also

`break` | `bafter` | `xbreak` | `tbreak` | `nanbreak` | `zclist`

Introduced before R2006a

zclist

List blocks containing nonsampled zero crossings

Syntax

`zclist`

`zcl`

Description

The `zclist` command displays a list of blocks in which nonsampled zero crossings can occur. The command displays the list in the MATLAB Command Window.

See Also

`zcbreak`

Introduced before R2006a

Classes

| | |
|---|--|
| eventData | Provide information about block method execution events |
| Simulink.BlockCompDworkData | Provide postcompilation information about block's DWork vector |
| Simulink.BlockCompInputPortData | Provide postcompilation information about block input port |
| Simulink.BlockCompOutputPortData | Provide postcompilation information about block output port |
| Simulink.BlockData | Provide run-time information about block-related data, such as block parameters |
| Simulink.BlockPortData | Describe block input or output port |
| Simulink.BlockPreCompInputPortData | Provide precompilation information about block input port |
| Simulink.BlockPreCompOutputPortData | Provide precompilation information about block output port |
| Simulink.GlobalDataTransfer | Configure concurrent execution data transfers |
| Simulink.ModelDataLogs | Container for signal data logs of a model |
| Simulink.SimState.ModelSimState | (Not recommended) Access SimState snapshot data |
| Simulink.MSFcnRunTimeBlock | Get run-time information about Level-2 MATLAB S-function block |
| Simulink.RunTimeBlock | Allow Level-2 MATLAB S-function and other MATLAB programs to get information about block while simulation is running |
| Simulink.SampleTime | Object containing sample time information |
| Simulink.SimulationData.BlockPath | Fully specified Simulink block path |
| Simulink.SimulationData.DataStoreMemory | Container for data store logging information |
| Simulink.SimulationData.LoggingInfo | Signal logging override settings |
| Simulink.SimulationData.ModelLoggingInfo | Signal logging override settings for a model |
| Simulink.SimulationData.SignalLoggingInfo | Signal logging override settings for signal |
| Simulink.SimulationData.Signal | Container for signal logging information |
| Simulink.SimulationData.State | State logging element |
| Simulink.SimulationMetadata | Access metadata of simulation runs |
| Simulink.SubsysDataLogs | Container for subsystem signal data logs |
| Simulink.TimeInfo | Provide information about time data in Simulink.Timeseries object |
| Simulink.Timeseries | Store data for any signal except mux or bus signal |
| Simulink.TsArray | Store data for mux or bus signal |
| Simulink.Variant | Specify conditions that control variant selection |
| Simulink.Mask | Control masks programmatically |

io.reader class

Package: io

Base class used to define custom variable or file reader for Simulation Data Inspector

Description

Use the `io.reader` base class to specify how to import custom variable and file formats into the **Simulation Data Inspector**. Write a class definition file that uses the `io.reader` methods to specify how to extract information like time and data values from the variable or file. Use this syntax as the first line in the class definition file to inherit from the `io.reader` class, where `MyReader` is the name of your subclass:

```
classdef MyReader < io.reader
```

For an example that shows how to write and use a custom file reader, see “Import Data Using a Custom File Reader”.

For an example that shows how to write and use a custom workspace data reader, see “Import Workspace Variables Using a Custom Data Reader”.

The `io.reader` class is a `handle` class.

Class Attributes

| | |
|------------------|------|
| Abstract | true |
| HandleCompatible | true |

For information on class attributes, see “Class Attributes”.

Properties

FileName — Name of imported file

'' (default) | character array

Name of imported file when using the subclass to import a file, specified as a character array.

Example: 'MyCustomFile'

Attributes:

| | |
|-----------|--------|
| GetAccess | public |
| SetAccess | public |

VariableName — Name of imported variable

'' (default) | character array

Name of imported variable or signal, specified as a character array.

Example: 'MyVar'

Attributes:

| | |
|-----------|--------|
| GetAccess | public |
| SetAccess | public |

VariableValue — Imported variable

variable

Imported variable. The VariableValue property has the same data type as the variable in the workspace or file. Use the VariableValue property to access the variable data inside method definitions.

Example: MyVar

Attributes:

| | |
|-----------|--------|
| GetAccess | public |
| SetAccess | public |

Data Types: single | double | int8 | int16 | int32 | int64 | uint8 | uint16 | uint32 | uint64 | logical | char | string | struct | enumerated | bus | table | cell | categorical | datetime | duration | calendarDuration | fi

Methods**Public Methods****Abstract Methods**

| | |
|---------------|--|
| getName | Get names for data imported using a custom reader |
| getDataValues | Return data values for data imported using a custom reader |
| getTimeValues | Return time values for data imported using a custom reader |

Commonly Used Methods

| | |
|---------------------------|---|
| getChildren | Return custom reader object for each node and signal in data imported using a custom reader |
| supportsFile | Return logical indication of whether custom reader supports file |
| registerFileReader | Register custom file reader for use in the Simulation Data Inspector |
| unregisterFileReader | Unregister custom file reader for the Simulation Data Inspector |
| supportsVariable | Return logical indication of whether custom reader supports variable |
| registerWorkspaceReader | Register custom workspace reader for the Simulation Data Inspector |
| unregisterWorkspaceReader | Unregister custom workspace reader for the Simulation Data Inspector |

Static Methods

| | |
|---|--|
| io.reader.getRegisteredFileReaders | Return all custom file readers registered for the Simulation Data Inspector |
| io.reader.getSupportedReadersForFile | Return all readers available to import file |
| io.reader.getRegisteredWorkspaceReaders | Return all custom workspace readers registered for the Simulation Data Inspector |

Additional Public Methods

| | |
|-----------------------------------|--|
| <code>getDescription</code> | <pre>desc = getDescription(obj)</pre> <p>Return a character array or string that provides a description of the custom file reader to display in the import dialog in the Simulation Data Inspector.</p> |
| <code>getSampleDimensions</code> | <pre>dims = getSampleDimensions(obj)</pre> <p>Return a vector that represents the dimensions of a single sample. For a scalar signal, return [1]. Return a single value for wide signals ([3]).</p> |
| <code>getSignalDescription</code> | <pre>desc = getSignalDescription(obj)</pre> <p>Return a character array or string to use as the value for the <code>Description</code> property of the imported <code>Simulink.sdi.Signal</code> object.</p> |
| <code>getBlockPath</code> | <pre>blkPath = getBlockPath(obj)</pre> <p>Return a character array, string, or <code>Simulink.SimulationData.BlockPath</code> object that represents the source of the signal.</p> |
| <code>getPortIndex</code> | <pre>portInd = getPortIndex(obj)</pre> <p>Return an integer that corresponds to the index of the block output port that produces the signal.</p> |
| <code>getInterpolation</code> | <pre>int = getInterpolation(obj)</pre> <p>Return a character array or string that contains <code>zoh</code> to use zero-order hold interpolation or <code>linear</code> to use linear interpolation.</p> |
| <code>getUnit</code> | <pre>sigUnit = getUnit(obj)</pre> <p>Return a character array or string that contains the unit of measure for the signal.</p> |
| <code>isEventBasedSignal</code> | <pre>eventBased = isEventBasedSignal(obj)</pre> <p>Return true when the signal is event-based or a message.</p> |

See Also**Functions**

`Simulink.sdi.createRun`

Objects

`Simulink.sdi.Run` | `Simulink.sdi.Signal`

Topics

“Import Data Using a Custom File Reader”

“Import Workspace Variables Using a Custom Data Reader”
“Microsoft Excel Import, Export, and Logging Format”
“Inspect Simulation Data”
“Compare Simulation Data”

Introduced in R2020b

getChildren

Class: `io.reader`

Package: `io`

Return custom reader object for each node and signal in data imported using a custom reader

Syntax

```
childObj = getChildren(obj)
```

Description

`childObj = getChildren(obj)` returns an array of custom reader objects that correspond to hierarchical nodes and signals in data imported into the Simulation Data Inspector using a custom file or workspace reader. Use the `getChildren` method to preserve the hierarchy for imported data. When you import multiple signals from a file, you can use the `getChildren` method to import the data as a flat list of signals contained under a top-level node that corresponds to the file.

Input Arguments

obj — Custom data reader

`io.reader` subclass object

Custom data reader, specified as an object of a class that inherits from the `io.reader` base class.

Example: `MyCustomFileReader`

Output Arguments

childObj — Hierarchical nodes and signals

cell array of `io.reader` subclass objects

Hierarchical nodes and signals in imported data, returned as a cell array of `io.reader` subclass objects.

Examples

Structure Data Imported from File

This example uses the `getChildren` method to import multiple signals from a file as a flat list of signals contained in a top-level node that represents the file. Specify code for the `getChildren` method in the class definition file.

This example does not show a complete class definition. All custom readers must define behavior for the `getName`, `getTimeValues`, and `getDataValues` methods. For an example that shows the complete class definition and import workflow, see “Import Data Using a Custom File Reader”.

In this example, the `getChildren` method reads the data from the file using the `readtable` function. The custom reader in this example always uses the data in the first column as time, so the

first variable name is cleared and not used. The `getChildren` method creates a custom reader object for the top-level node that corresponds to the file and for each signal in the file and assigns values to the `FileName` and `VariableName` properties.

```
classdef ExcelFirstColumnTimeReader < io.reader
    methods
        % ...

        function childObj = getChildren(obj)
            childObj = {};
            if isempty(obj.VariableName)
                t = readtable(obj.FileName);
                vars = t.Properties.VariableNames;
                vars(1) = [];
                childObj = cell(size(vars));
                for idx = 1:numel(vars)
                    childObj{idx} = ExcelFirstColumnTimeReader;
                    childObj{idx}.FileName = obj.FileName;
                    childObj{idx}.VariableName = vars{idx};
                end
            end
        end
    end

    % ...
end
end
```

Structure Data Imported from Workspace

This example uses the `getChildren` method to import an array of structures stored in a variable in the base workspace. Specify code for the `getChildren` method in the class definition file.

This example does not show a complete class definition. All custom readers must define behavior for the `getName`, `getTimeValues`, and `getDataValues` methods, and workspace data readers need to define the `supportsVariable` method. For an example that shows the complete class definition and import workflow for a workspace data reader, see “Import Workspace Variables Using a Custom Data Reader”.

In this example, the `getChildren` method creates a custom reader object for each structure in the input variable when the variable is an array of structures. The workspace reader in this example defines a `ChannelIndex` property that the `getChildren` method uses to identify each object it creates.

```
classdef SimpleStructReader < io.reader

    properties
        ChannelIndex
    end

    methods
        % ...

        function childObj = getChildren(obj)
            childObj = {};
            if ~isscalar(obj.VariableValue) && isempty(obj.ChannelIndex)
```

```
numChannels = numel(obj.VariableValue);
childObj = cell(numChannels,1);
for idx = 1:numChannels
    childObj{idx} = SimpleStructReader;
    childObj{idx}.VariableName = sprintf('%s(%d)',obj.VariableName,idx);
    childObj{idx}.VariableValue = obj.VariableValue;
    childObj{idx}.ChannelIndex = idx;
end
end
end
% ...
end
end
```

See Also

Functions

[getDataValues](#) | [getName](#) | [getTimeValues](#) | [supportsFile](#) | [supportsVariable](#)

Topics

“Import Data Using a Custom File Reader”

“Import Workspace Variables Using a Custom Data Reader”

“Microsoft Excel Import, Export, and Logging Format”

Introduced in R2020b

getDataValues

Class: `io.reader`

Package: `io`

Return data values for data imported using a custom reader

Syntax

```
dataVals = getDataValues(obj)
```

Description

`dataVals = getDataValues(obj)` returns data values to use for data imported into the Simulation Data Inspector using a custom file or workspace variable reader. Specify code for the `getDataValues` method to extract signal values from a proprietary file or variable format.

Input Arguments

obj — Custom data reader

`io.reader` subclass object

Custom data reader, specified as an object of a class that inherits from the `io.reader` base class.

Example: `MyCustomFileReader`

Output Arguments

dataVals — Signal values

numeric array | enum array | logical array | string array

Signal values, returned as an array of numeric, enumeration, logical, or string values. For scalar signals and wide signals, the first dimension of the array aligns with time and must match the length of the time vector returned by `getTimeValues`. For multidimensional signals, the last dimension aligns with time and must match the length of the time vector returned by `getTimeValues`.

Attributes

Abstract true

To learn about attributes of methods, see [Method Attributes](#).

Examples

Get Signal Values for Data Imported from File

Write the function definition for the `getDataValues` method to return signal values to use for data imported from a file. The custom reader in this example imports the data from the file with a

hierarchical structure, treating the file as the top node. Specify the code for the `getDataValues` method in the class definition file.

This example does not show a complete class definition. All custom readers must define behavior for the `getName`, `getTimeValues`, and `getDataValues` methods. For an example that shows the complete class definition and import workflow, see “Import Data Using a Custom File Reader”.

In this example, the `getChildren` method reads the data from the file using the `readtable` function and returns an array of custom reader objects for the top-level node that corresponds to the file and for each signal in the file. Then, the `getDataValues` method reads the data using the `readtable` function and selects the signal data to return for each signal in the file using the `VariableName` property of each custom reader object.

```
classdef ExcelFirstColumnTimeReader < io.reader
    methods
        % ...

        function childObj = getChildren(obj)
            childObj = {};
            if isempty(obj.VariableName)
                t = readtable(obj.FileName);
                vars = t.Properties.VariableNames;
                vars(1) = [];
                childObj = cell(size(vars));
                for idx = 1:numel(vars)
                    childObj{idx} = ExcelFirstColumnTimeReader;
                    childObj{idx}.FileName = obj.FileName;
                    childObj{idx}.VariableName = vars{idx};
                end
            end
        end

        function dataVals = getDataValues(obj)
            dataVals = [];
            if ~isempty(obj.VariableName)
                t = readtable(obj.FileName);
                dataVals = t.(obj.VariableName);
            end
        end

        % ...
    end
end
```

Get Signal Values from Workspace Variable

Write the function definition for the `getDataValues` method to return signal values from a workspace variable. Specify the code executed by the `getDataValues` method in the class definition file.

This example does not show a complete class definition. All custom readers must define behavior for the `getName`, `getTimeValues`, and `getDataValues` methods, and workspace data readers need to define the `supportsVariable` method. For an example that shows the complete class definition and import workflow for a workspace data reader, see “Import Workspace Variables Using a Custom Data Reader”.

The custom reader in this example imports a structure or an array of structures from the workspace. The structures must contain fields for the signal data (*d*), the time data (*t*), and the signal name (*n*). When the variable to import is a scalar structure, the `getDataValues` method returns the data from the *d* field of the structure.

When the variable is an array of structures, the custom reader uses both the `getDataValues` and `getChildren` methods to import the data. The `getChildren` method creates a custom reader object for each structure in the array and sets the `ChannelIndex` property to identify the index of the signal data within the array. Then, the `getDataValues` method uses the `ChannelIndex` property value to select the appropriate structure from the `VariableValue` property value, which is the array of structures.

```
classdef SimpleStructReader < io.reader

    properties
        ChannelIndex
    end

    methods
        % ...

        function childObj = getChildren(obj)
            childObj = {};
            if ~isscalar(obj.VariableValue) && isempty(obj.ChannelIndex)
                numChannels = numel(obj.VariableValue);
                childObj = cell(numChannels,1);
                for idx = 1:numChannels
                    childObj{idx} = SimpleStructReader;
                    childObj{idx}.VariableName = sprintf('%s(%d)',obj.VariableName,idx);
                    childObj{idx}.VariableValue = obj.VariableValue;
                    childObj{idx}.ChannelIndex = idx;
                end
            end
        end

        function dataVals = getDataValues(obj)
            if isscalar(obj.VariableValue)
                dataVals = obj.VariableValue.d;
            elseif ~isempty(obj.ChannelIndex)
                varVal = obj.VariableValue(obj.ChannelIndex);
                dataVals = varVal.d;
            else
                dataVals = [];
            end
        end

        % ...
    end
end
```

See Also

Functions

[getName](#) | [getTimeValues](#) | [supportsFile](#) | [getChildren](#) | [supportsVariable](#)

Topics

“Import Data Using a Custom File Reader”

“Import Workspace Variables Using a Custom Data Reader”

“Microsoft Excel Import, Export, and Logging Format”

Introduced in R2020b

getName

Class: `io.reader`

Package: `io`

Get names for data imported using a custom reader

Syntax

```
retName = getName(obj)
```

Description

`retName = getName(obj)` returns the name to use in the **Simulation Data Inspector** for a signal or hierarchical node in data imported from the workspace or a file.

Input Arguments

obj — Custom data reader

`io.reader` subclass object

Custom data reader, specified as an object of a class that inherits from the `io.reader` base class.

Example: `MyCustomFileReader`

Output Arguments

retName — Signal name

character array

Signal name used by the **Simulation Data Inspector**, returned as a character array.

Attributes

Abstract

true

To learn about attributes of methods, see Method Attributes.

Examples

Get Names for Data Imported from File

Write the function definition for the `getName` method to return names for signals imported from a file. The custom reader in this example imports the data from the file with a hierarchical structure, treating the file as the top node. Specify code for the `getName` method in the class definition file.

This example does not show a complete class definition. All custom readers must define behavior for the `getName`, `getTimeValues`, and `getDataValues` methods. For an example that shows the complete class definition and import workflow, see “Import Data Using a Custom File Reader”.

In this example, the `getName` and `getChildren` methods work together to assign the appropriate name to each imported signal. The `getChildren` method reads the data from the file using the `readtable` function. The method then constructs a cell array that contains a custom reader object for each signal read from the file.

The `getName` method uses the `FileName` property of the custom reader object to return the file name as the name for the top-level node. The `getName` method uses the `VariableName` property to return the signal name extracted from the file to use as the signal name for each imported signal.

```
classdef ExcelFirstColumnTimeReader < io.reader
    methods
        % ...

        function childObj = getChildren(obj)
            childObj = {};
            if isempty(obj.VariableName)
                t = readtable(obj.FileName);
                vars = t.Properties.VariableNames;
                vars(1) = [];
                childObj = cell(size(vars));
                for idx = 1:numel(vars)
                    childObj{idx} = ExcelFirstColumnTimeReader;
                    childObj{idx}.FileName = obj.FileName;
                    childObj{idx}.VariableName = vars{idx};
                end
            end
        end

        function retName = getName(obj)
            if isempty(obj.VariableName)
                fullName = obj.FileName;
                splitName = split(fullName,["\" "/""]);
                retName = splitName{end};
            else
                retName = obj.VariableName;
            end
        end

        % ...
    end
end
```

Get Names for Data Imported from Workspace

Write the function definition for the `getName` method to return signal names for data imported from the workspace. Specify code for the `getName` method in the class definition file.

This example does not show a complete class definition. All custom readers must define behavior for the `getName`, `getTimeValues`, and `getDataValues` methods, and workspace data readers need to define the `supportsVariable` method. For an example that shows the complete class definition and import workflow for a workspace data reader, see “Import Workspace Variables Using a Custom Data Reader”.

The custom reader in this example imports a structure or an array of structures from the workspace. The structures must contain fields for the signal data (`d`), the time data (`t`), and the signal name (`n`).

When the variable to import is a scalar structure, the `getName` method returns the value in the `n` field of the imported structure.

When the variable is an array of structures, the custom reader uses both the `getName` and `getChildren` methods to return signal names. The `getChildren` method creates a custom reader object for each structure in the array and sets the `ChannelIndex` property to identify the index of the signal data within the array. Then, the `getName` method uses the `ChannelIndex` property value to select the appropriate structure from the `VariableValue` property value, which is the array of structures.

```
classdef SimpleStructReader < io.reader

    properties
        ChannelIndex
    end

    methods
        % ...

        function childObj = getChildren(obj)
            childObj = {};
            if ~isscalar(obj.VariableValue) && isempty(obj.ChannelIndex)
                numChannels = numel(obj.VariableValue);
                childObj = cell(numChannels,1);
                for idx = 1:numChannels
                    childObj{idx} = SimpleStructReader;
                    childObj{idx}.VariableName = sprintf('%s(%d)',obj.VariableName,idx);
                    childObj{idx}.VariableValue = obj.VariableValue;
                    childObj{idx}.ChannelIndex = idx;
                end
            end
        end

        function retName = getName(obj)
            if isscalar(obj.VariableValue)
                retName = char(obj.VariableValue.n);
            elseif ~isempty(obj.ChannelIndex)
                varVal = obj.VariableValue(obj.ChannelIndex);
                retName = char(varVal.n);
            else
                retName = 'Signal Array';
            end
        end

        % ...
    end
end
```

See Also

Functions

`getName` | `getTimeValues` | `supportsFile` | `getChildren` | `supportsVariable`

Topics

“Import Data Using a Custom File Reader”

“Import Workspace Variables Using a Custom Data Reader”

“Microsoft Excel Import, Export, and Logging Format”

Introduced in R2020b

io.reader.getRegisteredFileReaders

Class: io.reader

Package: io

Return all custom file readers registered for the Simulation Data Inspector

Syntax

```
readers = io.reader.getRegisteredFileReaders
```

Description

`readers = io.reader.getRegisteredFileReaders` returns an array of strings that indicate all custom file readers registered for the Simulation Data Inspector.

Output Arguments

readers — Custom file readers registered for the Simulation Data Inspector

array of strings

Custom file readers registered for the Simulation Data Inspector, returned as an array of strings.

Attributes

Static true

To learn about attributes of methods, see Method Attributes.

Examples

Register Custom File Reader for the Simulation Data Inspector

This example shows how to register a custom file reader with the Simulation Data Inspector, verify registration was successful, and unregister a file reader.

Register the Custom File Reader

This example registers the file reader `ExcelFirstColumnTime`. For an example that shows how to author the custom file reader, see “Import Data Using a Custom File Reader”. As the name suggests, the custom file reader for this example supports Microsoft Excel™ files. Register the reader for the `.xlsx` and `.xls` extensions.

```
registerFileReader(ExcelFirstColumnTimeReader, [".xlsx" ".xls"]);
```

Verify Custom Reader Registration

To verify registration of a custom reader, you can use the `io.reader.getRegisteredFileReaders` method or the `io.reader.getSupportedReadersForFile` method.

The `io.reader.getRegisteredFileReaders` returns a string array that contains the names of all registered custom file readers.

```
io.reader.getRegisteredFileReaders
```

```
ans = 1x2 string
    "ExcelFirstColumnTimeReader"    "ExcelFirstColumnTimeReader"
```

You can also use the `io.reader.getSupportedReadersForFile` method to see all reader options for a specific file. The `built-in` option in the returned string array indicates that the Simulation Data Inspector has a built-in Excel file reader.

```
io.reader.getSupportedReadersForFile('CustomFile.xlsx')
```

```
ans = 1x2 string
    "ExcelFirstColumnTimeReader"    "built-in"
```

Unregister a Custom File Reader

To unregister a custom file reader, use the `unregisterFileReader` method. All custom readers are unregistered when you close a MATLAB™ session.

```
unregisterFileReader(ExcelFirstColumnTimeReader, [".xlsx" ".xls"])
```

See Also

Functions

[Simulink.sdi.createRun](#) | [io.reader.getSupportedReadersForFile](#) | [registerFileReader](#) | [unregisterFileReader](#)

Topics

[“Import Data Using a Custom File Reader”](#)
[“Microsoft Excel Import, Export, and Logging Format”](#)

Introduced in R2020b

io.reader.getRegisteredWorkspaceReaders

Class: io.reader

Package: io

Return all custom workspace readers registered for the Simulation Data Inspector

Syntax

```
readers = io.reader.getRegisteredWorkspaceReaders
```

Description

`readers = io.reader.getRegisteredWorkspaceReaders` returns an array of strings that indicate all custom workspace readers registered for the Simulation Data Inspector.

Output Arguments

readers — Custom workspace readers registered for the Simulation Data Inspector

array of strings

Custom workspace readers registered for the Simulation Data Inspector, returned as an array of strings.

Attributes

Static true

To learn about attributes of methods, see Method Attributes.

Examples

Register Custom Workspace Reader for the Simulation Data Inspector

This example shows how to register a custom workspace data reader with the Simulation Data Inspector, verify registration was successful, and unregister the workspace reader.

This example registers a custom workspace data reader called `SimpleStructReader`. For an example that shows how to author the custom workspace reader, see “Import Workspace Variables Using a Custom Data Reader”.

```
registerWorkspaceReader(SimpleStructReader);
```

To verify registration of a custom workspace reader, use the `io.reader.getRegisteredWorkspaceReaders` method, which returns a string array that contains the names of all registered custom workspace readers.

```
io.reader.getRegisteredWorkspaceReaders
```



```
ans =  
"SimpleStructReader"
```

To unregister a custom workspace reader, use the `unregisterWorkspaceReader` method. All readers are unregistered when you close the MATLAB™ session.

```
unregisterWorkspaceReader(SimpleStructReader);
```

See Also

Functions

`Simulink.sdi.createRun` | `io.reader.getSupportedReadersForFile` |
`io.reader.getRegisteredFileReaders` | `registerWorkspaceReader` |
`unregisterWorkspaceReader`

Topics

"Import Workspace Variables Using a Custom Data Reader"
"View Data in the Simulation Data Inspector"

Introduced in R2020b

io.reader.getSupportedReadersForFile

Class: io.reader

Package: io

Return all readers available to import file

Syntax

```
readers = io.reader.getSupportedReadersForFile(filename)
```

Description

`readers = io.reader.getSupportedReadersForFile(filename)` returns all readers in the Simulation Data Inspector that support importing the file specified by `filename`.

Input Arguments

filename — Name of or path to file to import

character array | string

Name of or path to file to import, specified as a character array or string.

Example: 'MyDataFile.csv'

Data Types: char | string

Output Arguments

readers — File readers available to import file

array of strings

File readers available to import file, returned as an array of strings. When the Simulation Data Inspector has a built-in reader for the file, the array contains "built-in".

Attributes

Static true

To learn about attributes of methods, see Method Attributes.

Examples

Register Custom File Reader for the Simulation Data Inspector

This example shows how to register a custom file reader with the Simulation Data Inspector, verify registration was successful, and unregister a file reader.

Register the Custom File Reader

This example registers the file reader `ExcelFirstColumnTime`. For an example that shows how to author the custom file reader, see “Import Data Using a Custom File Reader”. As the name suggests, the custom file reader for this example supports Microsoft Excel™ files. Register the reader for the `.xlsx` and `.xls` extensions.

```
registerFileReader(ExcelFirstColumnTimeReader, [".xlsx" ".xls"]);
```

Verify Custom Reader Registration

To verify registration of a custom reader, you can use the `io.reader.getRegisteredFileReaders` method or the `io.reader.getSupportedReadersForFile` method.

The `io.reader.getRegisteredFileReaders` returns a string array that contains the names of all registered custom file readers.

```
io.reader.getRegisteredFileReaders

ans = 1x2 string
    "ExcelFirstColumnTimeReader"    "ExcelFirstColumnTimeReader"
```

You can also use the `io.reader.getSupportedReadersForFile` method to see all reader options for a specific file. The `built-in` option in the returned string array indicates that the Simulation Data Inspector has a built-in Excel file reader.

```
io.reader.getSupportedReadersForFile('CustomFile.xlsx')

ans = 1x2 string
    "ExcelFirstColumnTimeReader"    "built-in"
```

Unregister a Custom File Reader

To unregister a custom file reader, use the `unregisterFileReader` method. All custom readers are unregistered when you close a MATLAB™ session.

```
unregisterFileReader(ExcelFirstColumnTimeReader, [".xlsx" ".xls"]);
```

See Also

Functions

`Simulink.sdi.createRun` | `io.reader.getRegisteredFileReaders` | `registerFileReader` | `unregisterFileReader`

Topics

“Import Data Using a Custom File Reader”
 “Microsoft Excel Import, Export, and Logging Format”

Introduced in R2020b

getTimeValues

Class: `io.reader`

Package: `io`

Return time values for data imported using a custom reader

Syntax

```
timeVals = getTimeValues(obj)
```

Description

`timeVals = getTimeValues(obj)` returns time values to use for data imported into the **Simulation Data Inspector** using a custom file or workspace variable reader. Specify code for the `getTimeValues` method to extract the data from a proprietary file or variable format.

Input Arguments

obj — Custom data reader

`io.reader` subclass object

Custom data reader, specified as an object of a class that inherits from the `io.reader` base class.

Example: `MyCustomFileReader`

Output Arguments

timeVals — Time values for imported data

column vector

Time values for imported data, returned as a column vector.

Attributes

Abstract true

To learn about attributes of methods, see [Method Attributes](#).

Examples

Get Time Values for Data Imported from File

Write the function definition for the `getTimeValues` method to return time values to use for data imported from a file. The custom reader in this example always uses the data in the first column of the file as time. Specify the code for the `getTimeValues` method in the class definition file.

This example does not show a complete class definition. All custom readers must define behavior for the `getName`, `getTimeValues`, and `getDataValues` methods. For an example that shows the complete class definition and import workflow, see “Import Data Using a Custom File Reader”.

In this example, the `getTimeValues` method reads the data from the file using the `readtable` function and returns the data from the first column to use as the time values for imported signals.

```
classdef ExcelFirstColumnTimeReader < io.reader
    methods
        % ...

        function timeVals = getTimeValues(obj)
            timeVals = [];
            if ~isempty(obj.VariableName)
                t = readtable(obj.FileName);
                timeName = t.Properties.VariableNames{1};
                timeVals = t.(timeName);
            end
        end
    end

    % ...
end
end
```

Get Time Values for Data Imported from Workspace

Write the function definition for the `getTimeValues` method to return time values for data imported from the workspace. Specify the code executed by the `getTimeValues` method in the class definition file.

This example does not show a complete class definition. All custom readers must define behavior for the `getName`, `getTimeValues`, and `getDataValues` methods, and workspace data readers need to define the `supportsVariable` method. For an example that shows the complete class definition and import workflow for a workspace data reader, see “Import Workspace Variables Using a Custom Data Reader”.

The custom reader in this example imports a structure or an array of structures from the workspace. The structures must contain fields for the signal data (`d`), the time data (`t`), and the signal name (`n`). When the variable to import is a scalar structure, the `getTimeValues` method returns the value in the `t` field of the imported structure.

When the variable is an array of structures, the custom reader uses both the `getTimeValues` and `getChildren` methods to return time data. The `getChildren` method creates a custom reader object for each structure in the array and sets the `ChannelIndex` property to identify the index of the signal data within the array. Then, the `getTimeData` method uses the `ChannelIndex` property value to select the appropriate structure from the `VariableValue` property value, which is the array of structures.

```
classdef ExcelFirstColumnTimeReader < io.reader

    properties
        ChannelIndex
    end
end
```

```
methods
% ...

function childObj = getChildren(obj)
    childObj = {};
    if ~isscalar(obj.VariableValue) && isempty(obj.ChannelIndex)
        numChannels = numel(obj.VariableValue);
        childObj = cell(numChannels,1);
        for idx = 1:numChannels
            childObj{idx} = SimpleStructReader;
            childObj{idx}.VariableName = sprintf('%s(%d)',obj.VariableName,idx);
            childObj{idx}.VariableValue = obj.VariableValue;
            childObj{idx}.ChannelIndex = idx;
        end
    end
end

function timeVals = getTimeValues(obj)
    if isscalar(obj.VariableValue)
        timeVals = obj.VariableValue.t;
    elseif ~isempty(obj.ChannelIndex)
        varVal = obj.VariableValue(obj.ChannelIndex);
        timeVals = varVal.t;
    else
        timeVals = [];
    end
end

% ...
end
end
```

See Also

Functions

[getDataValues](#) | [getName](#) | [supportsFile](#) | [getChildren](#) | [supportsVariable](#)

Topics

“Import Data Using a Custom File Reader”

“Import Workspace Variables Using a Custom Data Reader”

“Microsoft Excel Import, Export, and Logging Format”

Introduced in R2020b

registerFileReader

Class: `io.reader`

Package: `io`

Register custom file reader for use in the Simulation Data Inspector

Syntax

```
registerFileReader(obj,ext)
```

Description

`registerFileReader(obj,ext)` registers the custom file reader `obj` with the Simulation Data Inspector to use for files with extensions specified by `ext`. To use a custom file reader in the Simulation Data Inspector, you must register the reader at the start of each MATLAB session.

Tip To verify registration, use the `io.reader.getRegisteredFileReaders` method or the `io.reader.getSupportedReadersForFile` method.

Input Arguments

obj — Custom data reader

`io.reader` subclass object

Custom data reader, specified as an object of a class that inherits from the `io.reader` base class.

Example: `MyCustomFileReader`

ext — File extensions supported by custom reader

character vector | string | cell array of character vectors | cell array of strings

File extensions supported by custom reader, specified as a character vector, string, cell array of character vectors, or cell array of strings.

Example: `[".xlsx" ".xls"]`

Data Types: `char` | `string` | `cell`

Examples

Register Custom File Reader for the Simulation Data Inspector

This example shows how to register a custom file reader with the Simulation Data Inspector, verify registration was successful, and unregister a file reader.

Register the Custom File Reader

This example registers the file reader `ExcelFirstColumnTime`. For an example that shows how to author the custom file reader, see “Import Data Using a Custom File Reader”. As the name suggests,

the custom file reader for this example supports Microsoft Excel™ files. Register the reader for the .xlsx and .xls extensions.

```
registerFileReader(ExcelFirstColumnTimeReader, [".xlsx" ".xls"]);
```

Verify Custom Reader Registration

To verify registration of a custom reader, you can use the `io.reader.getRegisteredFileReaders` method or the `io.reader.getSupportedReadersForFile` method.

The `io.reader.getRegisteredFileReaders` returns a string array that contains the names of all registered custom file readers.

```
io.reader.getRegisteredFileReaders  
  
ans = 1×2 string  
    "ExcelFirstColumnTimeReader"    "ExcelFirstColumnTimeReader"
```

You can also use the `io.reader.getSupportedReadersForFile` method to see all reader options for a specific file. The `built-in` option in the returned string array indicates that the Simulation Data Inspector has a built-in Excel file reader.

```
io.reader.getSupportedReadersForFile('CustomFile.xlsx')  
  
ans = 1×2 string  
    "ExcelFirstColumnTimeReader"    "built-in"
```

Unregister a Custom File Reader

To unregister a custom file reader, use the `unregisterFileReader` method. All custom readers are unregistered when you close a MATLAB™ session.

```
unregisterFileReader(ExcelFirstColumnTimeReader, [".xlsx" ".xls"]);
```

See Also

Functions

`Simulink.sdi.createRun` | `io.reader.getRegisteredFileReaders` |
`io.reader.getSupportedReadersForFile` | `unregisterFileReader`

Topics

“Import Data Using a Custom File Reader”
“Microsoft Excel Import, Export, and Logging Format”

Introduced in R2020b

registerWorkspaceReader

Class: `io.reader`

Package: `io`

Register custom workspace reader for the Simulation Data Inspector

Syntax

```
registerWorkspaceReader(obj)
```

Description

`registerWorkspaceReader(obj)` registers the custom workspace reader specified by `obj` for the Simulation Data Inspector. To use a custom workspace reader, you must register the reader at the start of each MATLAB session.

Tip To verify registration, use the `io.reader.getRegisteredWorkspaceReaders` method.

Input Arguments

obj — Custom data reader

`io.reader` subclass object

Custom data reader, specified as an object of a class that inherits from the `io.reader` base class.

Example: `MyCustomReader`

Examples

Register Custom Workspace Reader for the Simulation Data Inspector

This example shows how to register a custom workspace data reader with the Simulation Data Inspector, verify registration was successful, and unregister the workspace reader.

This example registers a custom workspace data reader called `SimpleStructReader`. For an example that shows how to author the custom workspace reader, see “Import Workspace Variables Using a Custom Data Reader”.

```
registerWorkspaceReader(SimpleStructReader);
```

To verify registration of a custom workspace reader, use the `io.reader.getRegisteredWorkspaceReaders` method, which returns a string array that contains the names of all registered custom workspace readers.

```
io.reader.getRegisteredWorkspaceReaders
```

```
ans =  
"SimpleStructReader"
```

To unregister a custom workspace reader, use the `unregisterWorkspaceReader` method. All readers are unregistered when you close the MATLAB™ session.

```
unregisterWorkspaceReader(SimpleStructReader);
```

See Also

Functions

`Simulink.sdi.createRun` | `registerWorkspaceReader` | `unregisterWorkspaceReader` | `registerFileReader`

Topics

“Import Workspace Variables Using a Custom Data Reader”

“View Data in the Simulation Data Inspector”

Introduced in R2020b

supportsFile

Class: `io.reader`

Package: `io`

Return logical indication of whether custom reader supports file

Syntax

```
supported = supportsFile(obj, filename)
```

Description

`supported = supportsFile(obj, filename)` returns the logical value `supported` that indicates whether the custom reader specified by `obj` supports the file specified by `filename`. The Simulation Data Inspector always checks whether a file is supported based on the file extension alone. Use the `supportsFile` method to specify code for additional support validation.

Input Arguments

obj — Custom data reader

`io.reader` subclass object

Custom data reader, specified as an object of a class that inherits from the `io.reader` base class.

Example: `MyCustomFileReader`

filename — Name of file to import

character vector | string

Name of file to import, specified as a character vector or string.

Example: `'MyDataFile.xlsx'`

Data Types: `char` | `string`

Output Arguments

supported — Whether custom reader supports file

logical

Whether custom reader supports file, returned as a logical value.

Examples

Determine Whether Custom File Reader Supports File

Write the function definition for the `supportsFile` method to determine whether the custom reader supports the data in the file. This example does not show a complete class definition. All custom readers must define behavior for the `getName`, `getTimeValues`, and `getDataValues` methods. For

an example that shows the complete class definition and import workflow, see “Import Data Using a Custom File Reader”.

In this example, the `supportsFile` method reads the data in the file using the `readtable` function and checks that the file contains data in more than one column.

```
classdef ExcelFirstColumnTimeReader < io.reader
    methods
        % ...

        function childObj = getChildren(obj)
            try
                t = readtable(filename);
                supported = height(t) > 0 && numel(t.Properties.VariableNames) > 1;
            catch
                supported = false;
            end
        end
    end
    % ...
end
end
```

See Also

Functions

`getDataValues` | `getName` | `getTimeValues` | `supportsFile`

Topics

“Import Data Using a Custom File Reader”

“Microsoft Excel Import, Export, and Logging Format”

Introduced in R2020b

supportsVariable

Class: `io.reader`

Package: `io`

Return logical indication of whether custom reader supports variable

Syntax

```
supported = supportsVariable(obj,var)
```

Description

`supported = supportsVariable(obj,var)` returns the logical value `supported` that indicates whether the custom workspace reader specified by `obj` supports the variable specified by `var`. When you write a custom workspace reader, you must implement the `supportsVariable` method in the class definition.

Input Arguments

obj — Custom data reader

`io.reader` subclass object

Custom data reader, specified as an object of a class that inherits from the `io.reader` base class.

Example: `MyCustomReader`

var — Workspace variable to import

variable

Workspace variable to import, specified as a variable in the base workspace.

Example: `myVar`

Data Types: `single` | `double` | `int8` | `int16` | `int32` | `int64` | `uint8` | `uint16` | `uint32` | `uint64` | `logical` | `char` | `string` | `struct` | `table` | `cell` | `categorical` | `datetime` | `duration` | `calendarDuration` | `fi`

Complex Number Support: Yes

Output Arguments

supported — Whether custom reader supports variable

logical

Whether the custom reader supports variable, returned as a logical value.

Examples

Determine Whether Custom Reader Supports Variable

Write the function definition for the `supportsVariable` method to return true only when the reader can import the input variable. Specify the code for the `supportsVariable` method in the class definition file.

This example does not show a complete class definition. All custom readers must define behavior for the `getName`, `getTimeValues`, and `getDataValues` methods, and workspace data readers need to define the `supportsVariable` method. For an example that shows the complete class definition and import workflow for a workspace data reader, see “Import Workspace Variables Using a Custom Data Reader”.

The custom reader in this example imports a structure or an array of structures from the workspace. The structures must contain fields for the signal data (`d`), the time data (`t`), and the signal name (`n`). The `supportsVariable` method returns true when:

- 1 The input variable is a structure or array of structures that contains the appropriate fields.
- 2 The `n` field of each structure contains a character array or string to represent the signal name.
- 3 The `t` field of each structure is a column vector of double data.
- 4 The `d` field of each structure contains numeric data and is the same size as the `t` field, meaning there is a sample value for each time step.

```
classdef ExcelFirstColumnTimeReader < io.reader

    methods
        % ...

        function supported = supportsVariable(~, val)
            % Support structure with fields t (time), d (data), and n (name)
            supported = ...
                isstruct(val) && ...
                isfield(val,'t') && ...
                isfield(val,'d') && ...
                isfield(val,'n');
            if supported
                for idx = 1:numel(val)
                    varName = val(idx).n;
                    time = val(idx).t;
                    varData = val(idx).d;

                    % Name must be string or character array
                    if ~ischar(varName) && ~isstring(varName)
                        supported = false;
                    end

                    % Time must be double column vector
                    elseif ~isa(time,'double') || ~iscolumn(time)
                        supported = false;
                    end

                    % Data size must match time size
                    else
                        timeSz = size(time);
                        dataSz = size(varData);

                        if ~isnumeric(varData) || ~isequal(dataSz, timeSz)
                            supported = false;
                        end
                    end
                end
            end
        end
    end
end
```

```
        end
    end
end
end

% ...
end
end
```

See Also

Functions

[getName](#) | [getTimeValues](#) | [supportsFile](#) | [getChildren](#)

Topics

[“Import Workspace Variables Using a Custom Data Reader”](#)

[“Microsoft Excel Import, Export, and Logging Format”](#)

Introduced in R2020b

unregisterFileReader

Class: `io.reader`

Package: `io`

Unregister custom file reader for the Simulation Data Inspector

Syntax

```
unregisterFileReader(obj, ext)
```

Description

`unregisterFileReader(obj, ext)` unregisters the custom file reader specified by `obj` for the extensions specified by `ext`. All custom file and workspace variable readers are unregistered when you close MATLAB.

Tip To verify the unregister operation, use the `io.reader.getRegisteredFileReaders` method or the `io.reader.getSupportedReadersForFile` method.

Input Arguments

obj — Custom data reader

`io.reader` subclass object

Custom data reader, specified as an object of a class that inherits from the `io.reader` base class.

Example: `MyCustomFileReader`

ext — File extensions supported by custom reader

character vector | string | cell array of character vectors | cell array of strings

File extensions supported by custom reader, specified as a character vector, string, cell array of character vectors, or cell array of strings.

Example: `[".xlsx" ".xls"]`

Data Types: `char` | `string` | `cell`

Examples

Register Custom File Reader for the Simulation Data Inspector

This example shows how to register a custom file reader with the Simulation Data Inspector, verify registration was successful, and unregister a file reader.

Register the Custom File Reader

This example registers the file reader `ExcelFirstColumnTime`. For an example that shows how to author the custom file reader, see “Import Data Using a Custom File Reader”. As the name suggests,

the custom file reader for this example supports Microsoft Excel™ files. Register the reader for the .xlsx and .xls extensions.

```
registerFileReader(ExcelFirstColumnTimeReader, [".xlsx" ".xls"]);
```

Verify Custom Reader Registration

To verify registration of a custom reader, you can use the `io.reader.getRegisteredFileReaders` method or the `io.reader.getSupportedReadersForFile` method.

The `io.reader.getRegisteredFileReaders` returns a string array that contains the names of all registered custom file readers.

```
io.reader.getRegisteredFileReaders
ans = 1x2 string
    "ExcelFirstColumnTimeReader"    "ExcelFirstColumnTimeReader"
```

You can also use the `io.reader.getSupportedReadersForFile` method to see all reader options for a specific file. The `built-in` option in the returned string array indicates that the Simulation Data Inspector has a built-in Excel file reader.

```
io.reader.getSupportedReadersForFile('CustomFile.xlsx')
ans = 1x2 string
    "ExcelFirstColumnTimeReader"    "built-in"
```

Unregister a Custom File Reader

To unregister a custom file reader, use the `unregisterFileReader` method. All custom readers are unregistered when you close a MATLAB™ session.

```
unregisterFileReader(ExcelFirstColumnTimeReader, [".xlsx" ".xls"]);
```

See Also

Functions

`registerFileReader` | `io.reader.getRegisteredFileReaders` | `io.reader.getSupportedReadersForFile`

Topics

“Import Data Using a Custom File Reader”
 “Microsoft Excel Import, Export, and Logging Format”

Introduced in R2020b

unregisterWorkspaceReader

Class: `io.reader`

Package: `io`

Unregister custom workspace reader for the Simulation Data Inspector

Syntax

```
unregisterWorkspaceReader(obj)
```

Description

`unregisterWorkspaceReader(obj)` unregisters the custom workspace reader specified by `obj` from the Simulation Data Inspector. All custom file and workspace variable readers are unregistered when you close MATLAB.

Input Arguments

obj — Custom data reader

`io.reader` subclass object

Custom data reader, specified as an object of a class that inherits from the `io.reader` base class.

Example: `MyCustomReader`

Examples

Register Custom Workspace Reader for the Simulation Data Inspector

This example shows how to register a custom workspace data reader with the Simulation Data Inspector, verify registration was successful, and unregister the workspace reader.

This example registers a custom workspace data reader called `SimpleStructReader`. For an example that shows how to author the custom workspace reader, see “Import Workspace Variables Using a Custom Data Reader”.

```
registerWorkspaceReader(SimpleStructReader);
```

To verify registration of a custom workspace reader, use the `io.reader.getRegisteredWorkspaceReaders` method, which returns a string array that contains the names of all registered custom workspace readers.

```
io.reader.getRegisteredWorkspaceReaders
```

```
ans =  
"SimpleStructReader"
```

To unregister a custom workspace reader, use the `unregisterWorkspaceReader` method. All readers are unregistered when you close the MATLAB™ session.

```
unregisterWorkspaceReader(SimpleStructReader);
```

See Also

Functions

[registerWorkspaceReader](#) | [unregisterWorkspaceReader](#) | [unregisterFileReader](#)

Topics

[“Import Workspace Variables Using a Custom Data Reader”](#)

[“View Data in the Simulation Data Inspector”](#)

Introduced in R2020b

matlab.io.datastore.sd datastore class

Package: matlab.io.datastore

Datastore for Simulation Data Inspector signals

Description

A `matlab.io.datastore.sd datastore` object provides access to signals logged to the Simulation Data Inspector that are too large to fit into memory. An `sd datastore` object references the data for a single signal. The `read` method loads the signal data referenced by an `sd datastore` object in a chunk-wise manner such that each chunk always fits into memory. You can use an `sd datastore` object to create a tall timetable for your signal data. For more information about working with tall arrays, see “Tall Arrays”.

Note `matlab.io.datastore.sd datastore` does not support parallel computations. If you have a Parallel Computing Toolbox license, use `mapreducer(0)` to set the execution environment to the local MATLAB client before creating a tall timetable from the `matlab.io.datastore.sd datastore`.

Construction

`ds = dsrObj.getAsDatastore(arg)` creates the `sd datastore`, `ds`, for the signal in the `Simulink.sdi.DatasetRef` object selected by the search criterion `arg`. You can specify `arg` as an integer representing the index of the desired signal within the `Simulink.sdi.DatasetRef` object, or as a character vector containing the name of the signal.

`ds = matlab.io.datastore.sd datastore(signalID)` creates the `sd datastore`, `ds`, for the signal corresponding to the specified `signalID`.

Input Arguments

arg — Element selection criterion

character vector | integer

Search criterion used to retrieve the element from the `Simulink.sdi.DatasetRef` object. For name-based searches, specify `arg` as a character vector. For index-based searches, `arg` is an integer, representing the index of the desired element.

Example: 'MySignal'

Example: 3

signalID — Numeric signal identifier

integer

Numeric signal identifier generated for the signal by the Simulation Data Inspector. You can get the signal ID for a signal using methods of the `Simulink.sdi.Run` object containing the signal or as a return from the `Simulink.sdi.createRun` function.

Properties

Name — Signal name

character vector

Name of the signal specified as a character vector.

Example: 'My Signal'

Signal — Simulink.sdi.Signal object

Simulink.sdi.Signal object

Simulink.sdi.Signal object associated with the sdidatastore. The Signal property provides access to the signal data and metadata.

Methods

| | |
|---------|---|
| hasdata | Determine if data is available to read |
| preview | Return preview of data in sdidatastore |
| read | Read a chunk of data from an sdidatastore |
| readall | Read all data from an sdidatastore |
| reset | Reset the read position |

Copy Semantics

Handle. To learn how handle classes affect copy operations, see Copying Objects.

Examples

Create a Tall Timetable for a Simulation Data Inspector Signal

This example shows how to create a tall timetable for a signal in the Simulation Data Inspector repository. You can create the tall timetable using a Simulink.sdi.Signal object or by first creating a matlab.io.datastore.sdidatastore for the signal. You can use a matlab.io.datastore.sdidatastore to incrementally read and process signal data for signals that do not fit into memory. A tall timetable handles the data chunking and processing in the background. In general, you can work with tall timetables very similarly to how you work with in-memory data.

Create Data and Access Signal ID

Whether you create your tall timetable using a Simulink.sdi.Signal object or a matlab.io.datastore.sdidatastore, start by creating data and accessing the signal ID for a signal of interest. The sldemo_fuelsys model is configured to log signals which stream to the Simulation Data Inspector repository when you simulate the model.

```
open_system('sldemo_fuelsys')
sim('sldemo_fuelsys')
```

Then, use the Simulation Data Inspector programmatic interface to access the signal ID for a signal of interest. For example, access the ego signal.

```
runCount = Simulink.sdi.getRunCount;
latestRunID = Simulink.sdi.getRunIDByIndex(runCount);
latestRun = Simulink.sdi.getRun(latestRunID);

egoSigID = latestRun.getSignalIDByIndex(7);
```

Create a Tall Timetable Using a `matlab.io.datastore.sdidatastore`

In general, tall timetables are backed by datastores. Create a `matlab.io.datastore.sdidatastore` object to reference the signal data in the Simulation Data Inspector repository.

```
egoDs = matlab.io.datastore.sdidatastore(egoSigID);
```

Check the name of the datastore to verify you have the signal you expect.

```
egoDs.Name
```

```
ans =
'fuel'
```

Create a tall timetable from the `matlab.io.datastore.sdidatastore` to use for processing the signal data. When you have a Parallel Computing Toolbox™ license, you need to explicitly set the execution environment to the local MATLAB® session using `mapreducer` before creating the tall timetable. The `matlab.io.datastore.sdidatastore` object does not support parallel computations.

```
mapreducer(0);
```

```
egoTt = tall(egoDs)
```

```
egoTt =
```

```
Mx1 tall timetable
```

| Time | Data |
|----------------|--------|
| 0 sec | 1.209 |
| 0.00056199 sec | 1.209 |
| 0.0033719 sec | 1.209 |
| 0.01 sec | 1.1729 |
| 0.02 sec | 1.1409 |
| 0.03 sec | 1.1124 |
| 0.04 sec | 1.0873 |
| 0.05 sec | 1.0652 |
| ⋮ | ⋮ |
| ⋮ | ⋮ |

Create a Tall Timetable Using a `Simulink.sdi.Signal` Object

The `Simulink.sdi.Signal` class has a method to create a tall timetable directly, allowing you to skip the step of creating a datastore by creating it behind the scenes. Use the signal ID to access the `Simulink.sdi.Signal` object for the ego signal. Then, use the `getTable` method to create the tall timetable.

```
egoSig = Simulink.sdi.getSignal(egoSigID);
```

```
egoTt = egoSig.getAsTall
```

```
egoTt =
```

```
Mx1 tall timetable
```

| Time | Data |
|----------------|--------|
| 0 sec | 1.209 |
| 0.00056199 sec | 1.209 |
| 0.0033719 sec | 1.209 |
| 0.01 sec | 1.1729 |
| 0.02 sec | 1.1409 |
| 0.03 sec | 1.1124 |
| 0.04 sec | 1.0873 |
| 0.05 sec | 1.0652 |
| : | : |
| : | : |

Use the Tall Timetable to Process Your Signal Data

When you use the tall timetable `egoTt`, its underlying datastore reads chunks of data and passes them to the tall timetable to process. Neither the datastore nor the tall timetable retain any of the data in memory after processing. Also, the tall timetable defers processing for many operations. For example, calculate the mean value of the signal.

```
egoMean = mean(egoTt.Data)
```

```
egoMean =
```

```
tall double
```

```
?
```

You can use the `gather` function to evaluate a variable and write its value to the workspace, or you can use the `write` function to write the results to disc. When you use `gather`, be sure the results fit into memory.

```
egoMean = gather(egoMean)
```

```
Evaluating tall expression using the Local MATLAB Session:
```

```
- Pass 1 of 1: Completed in 35 sec
```

```
Evaluation completed in 36 sec
```

```
egoMean = 1.3292
```

When you perform multiple operations on a tall timetable, evaluation of the results for each step is deferred until you explicitly request the results with `write` or `gather`. During evaluation, MATLAB optimizes the number of passes it makes through the tall timetable, which can significantly speed up processing time for analyzing very large signals. For more information about working with tall arrays, see “Tall Arrays for Out-of-Memory Data”.

Process Signal Data Using a `matlab.io.datastore.sdidatastore`

A `matlab.io.datastore.sdidatastore` references signal data in the Simulation Data Inspector repository. When the signal is too large to fit into memory, you can use the

`matlab.io.datastore.sd datastore` to incrementally process the data manually or to create a tall timetable for the signal that handles the incremental processing for you. This example shows how to process data using a `matlab.io.datastore.sd datastore`.

Create a `matlab.io.datastore.sd datastore` for a Signal

Simulate the `sldemo_fuelsys` model, which is configured to log several signals, to create data in the Simulation Data Inspector repository.

```
sim('sldemo_fuelsys')
```

Use the Simulation Data Inspector programmatic interface to get the signal ID for the signal.

```
runCount = Simulink.sdi.getRunCount;
latestRunID = Simulink.sdi.getRunIDByIndex(runCount);
latestRun = Simulink.sdi.getRun(latestRunID);
speedSigID = latestRun.getSignalIDByIndex(4);
```

Use the signal ID to create a `matlab.io.datastore.sd datastore` for the speed signal.

```
speedSDIDs = matlab.io.datastore.sd datastore(speedSigID);
```

Verify the Contents of the Datastore

Check the `Name` property of the `matlab.io.datastore.sd datastore` to verify that it matches your expectations.

```
speedSDIDs.Name
```

```
ans =
'map'
```

You can also use the `preview` method to check that the first ten samples in the signal look correct.

```
speedSDIDs.preview
```

```
ans=10x1 timetable
      Time      Data
-----
0 sec          0.589
0.00056199 sec 0.58772
0.0033719 sec  0.58148
0.01 sec       0.56765
0.02 sec       0.54897
0.03 sec       0.53264
0.04 sec       0.51837
0.05 sec       0.50594
0.055328 sec   0.5
0.055328 sec   0.5
```

Process Signal Data with the `matlab.io.datastore.sd datastore`

When your signal is too large to fit into memory, you can use the `readData` method to read chunks of data from the Simulation Data Inspector repository to incrementally process your data. Use the

hasdata method as the condition for a while loop to incrementally process the whole signal. For example, find the maximum signal value.

```
latestMax = [];  
  
while speedSDIds.hasdata  
    speedChunk = speedSDIds.read;  
    speedChunkData = speedChunk.Data;  
    latestMax = max([speedChunkData; latestMax]);  
  
end  
  
latestMax  
latestMax = 0.8897
```

On each read operation, the read method updates the read position for the start of the next read operation. After reading some or all of the `matlab.io.datastore.sd datastore`, you can reset the read position to start again from the beginning of the signal.

```
speedSDIds.reset
```

Process Signal Data in Memory

When the signal referenced by your `matlab.io.datastore.sd datastore` fits into memory, you can use the `readall` method to read all the signal data into memory for processing, rather than reading and processing the data incrementally with the `read` method. The `readall` method returns a `timetable` with all the signal data.

```
speedTimetable = speedSDIds.readall;  
  
speedMax = max(speedTimetable.Data)  
  
speedMax = 0.8897
```

See Also

[Simulink.sdi.DatasetRef | getAsDatastore](#) | [matlab.io.datastore.SimulationDatastore](#) | [Simulink.sdi.Signal](#)

Topics

“Tall Arrays”
“Datastore”

Introduced in R2017b

hasdata

Class: `matlab.io.datastore.sd datastore`

Package: `matlab.io.datastore`

Determine if data is available to read

Syntax

```
tf = sdi_ds.hasdata
```

Description

`tf = sdi_ds.hasdata` returns logical 1 if the `matlab.io.datastore.sd datastore`, `sdi_ds`, has data available to read. When `sdi_ds` does not have data available to read, `hasdata` returns 0.

Output Arguments

tf — Data availability indication

logical

Logical indication of whether the `matlab.io.datastore.sd datastore` has data available to read. When data is available, `tf` is 1. When data is not available, `tf` is 0.

Examples

Process Signal Data Using a `matlab.io.datastore.sd datastore`

A `matlab.io.datastore.sd datastore` references signal data in the Simulation Data Inspector repository. When the signal is too large to fit into memory, you can use the `matlab.io.datastore.sd datastore` to incrementally process the data manually or to create a tall timetable for the signal that handles the incremental processing for you. This example shows how to process data using a `matlab.io.datastore.sd datastore`.

Create a `matlab.io.datastore.sd datastore` for a Signal

Simulate the `sldemo_fuelsys` model, which is configured to log several signals, to create data in the Simulation Data Inspector repository.

```
sim('sldemo_fuelsys')
```

Use the Simulation Data Inspector programmatic interface to get the signal ID for the signal.

```
runCount = Simulink.sdi.getRunCount;
```

```
latestRunID = Simulink.sdi.getRunIDByIndex(runCount);
```

```
latestRun = Simulink.sdi.getRun(latestRunID);
```

```
speedSigID = latestRun.getSignalIDByIndex(4);
```

Use the signal ID to create a `matlab.io.datastore.sd datastore` for the speed signal.

```
speedSDIds = matlab.io.datastore.sd datastore(speedSigID);
```

Verify the Contents of the Datastore

Check the Name property of the `matlab.io.datastore.sd datastore` to verify that it matches your expectations.

```
speedSDIds.Name
```

```
ans =  
'map'
```

You can also use the `preview` method to check that the first ten samples in the signal look correct.

```
speedSDIds.preview
```

```
ans=10x1 timetable  
      Time      Data  
-----  
0 sec          0.589  
0.00056199 sec 0.58772  
0.0033719 sec  0.58148  
0.01 sec       0.56765  
0.02 sec       0.54897  
0.03 sec       0.53264  
0.04 sec       0.51837  
0.05 sec       0.50594  
0.055328 sec   0.5  
0.055328 sec   0.5
```

Process Signal Data with the `matlab.io.datastore.sd datastore`

When your signal is too large to fit into memory, you can use the `readData` method to read chunks of data from the Simulation Data Inspector repository to incrementally process your data. Use the `hasdata` method as the condition for a while loop to incrementally process the whole signal. For example, find the maximum signal value.

```
latestMax = [];  
  
while speedSDIds.hasdata  
    speedChunk = speedSDIds.read;  
    speedChunkData = speedChunk.Data;  
    latestMax = max([speedChunkData; latestMax]);  
  
end  
  
latestMax  
  
latestMax = 0.8897
```

On each read operation, the `read` method updates the read position for the start of the next read operation. After reading some or all of the `matlab.io.datastore.sd datastore`, you can reset the read position to start again from the beginning of the signal.

```
speedSDIds.reset
```

Process Signal Data in Memory

When the signal referenced by your `matlab.io.datastore.sd datastore` fits into memory, you can use the `readall` method to read all the signal data into memory for processing, rather than reading and processing the data incrementally with the `read` method. The `readall` method returns a `timetable` with all the signal data.

```
speedTimetable = speedSDIds.readall;  
  
speedMax = max(speedTimetable.Data)  
  
speedMax = 0.8897
```

See Also

`matlab.io.datastore.sd datastore`

Topics

“Tall Arrays”
“Datastore”

Introduced in R2017b

preview

Class: `matlab.io.datastore.sd datastore`

Package: `matlab.io.datastore`

Return preview of data in `sd datastore`

Syntax

```
dataPreview = sdi_ds.preview
```

Description

`dataPreview = sdi_ds.preview` returns the first 10 samples of signal data in the `matlab.io.datastore.sd datastore`, `sdi_ds`. The `preview` method does not change the read position. Use the `preview` method to verify that the data in your `matlab.io.datastore.sd datastore` appears as you expect.

Output Arguments

dataPreview — Preview of the data

`timetable`

First 10 samples of the signal referenced by the `matlab.io.datastore.sd datastore` in a `timetable`.

Examples

Process Signal Data Using a `matlab.io.datastore.sd datastore`

A `matlab.io.datastore.sd datastore` references signal data in the Simulation Data Inspector repository. When the signal is too large to fit into memory, you can use the `matlab.io.datastore.sd datastore` to incrementally process the data manually or to create a tall `timetable` for the signal that handles the incremental processing for you. This example shows how to process data using a `matlab.io.datastore.sd datastore`.

Create a `matlab.io.datastore.sd datastore` for a Signal

Simulate the `sldemo_fuelsys` model, which is configured to log several signals, to create data in the Simulation Data Inspector repository.

```
sim('sldemo_fuelsys')
```

Use the Simulation Data Inspector programmatic interface to get the signal ID for the signal.

```
runCount = Simulink.sdi.getRunCount;
```

```
latestRunID = Simulink.sdi.getRunIDByIndex(runCount);
```

```
latestRun = Simulink.sdi.getRun(latestRunID);
```

```
speedSigID = latestRun.getSignalIDByIndex(4);
```

Use the signal ID to create a `matlab.io.datastore.sd datastore` for the speed signal.

```
speedSDIds = matlab.io.datastore.sd datastore(speedSigID);
```

Verify the Contents of the Datastore

Check the `Name` property of the `matlab.io.datastore.sd datastore` to verify that it matches your expectations.

```
speedSDIds.Name
```

```
ans =  
'map'
```

You can also use the `preview` method to check that the first ten samples in the signal look correct.

```
speedSDIds.preview
```

```
ans=10x1 timetable  
      Time      Data  
-----  
0 sec          0.589  
0.00056199 sec 0.58772  
0.0033719 sec  0.58148  
0.01 sec       0.56765  
0.02 sec       0.54897  
0.03 sec       0.53264  
0.04 sec       0.51837  
0.05 sec       0.50594  
0.055328 sec   0.5  
0.055328 sec   0.5
```

Process Signal Data with the `matlab.io.datastore.sd datastore`

When your signal is too large to fit into memory, you can use the `readData` method to read chunks of data from the Simulation Data Inspector repository to incrementally process your data. Use the `hasdata` method as the condition for a while loop to incrementally process the whole signal. For example, find the maximum signal value.

```
latestMax = [];
```

```
while speedSDIds.hasdata
```

```
    speedChunk = speedSDIds.read;  
    speedChunkData = speedChunk.Data;  
    latestMax = max([speedChunkData; latestMax]);
```

```
end
```

```
latestMax
```

```
latestMax = 0.8897
```

On each read operation, the `read` method updates the read position for the start of the next read operation. After reading some or all of the `matlab.io.datastore.sd datastore`, you can reset the read position to start again from the beginning of the signal.

```
speedSDIds.reset
```

Process Signal Data in Memory

When the signal referenced by your `matlab.io.datastore.sd datastore` fits into memory, you can use the `readall` method to read all the signal data into memory for processing, rather than reading and processing the data incrementally with the `read` method. The `readall` method returns a `timetable` with all the signal data.

```
speedTimetable = speedSDIds.readall;
```

```
speedMax = max(speedTimetable.Data)
```

```
speedMax = 0.8897
```

See Also

`matlab.io.datastore.sd datastore`

Topics

“Timetables”

Introduced in R2017b

read

Class: `matlab.io.datastore.sd datastore`

Package: `matlab.io.datastore`

Read a chunk of data from an `sd datastore`

Syntax

```
data = sdi_ds.read
```

Description

`data = sdi_ds.read` reads a chunk of samples from the `matlab.io.datastore.sd datastore`, `sdi_ds`, and updates the read position for `sdi_ds` to the point following the endpoint of the returned data. The samples are returned in the `timetable`, `data`. The number of samples read by the `read` method vary, and the returned `timetable` always fits into memory. Use the `read` method to incrementally process signals that are too large to fit into memory.

Output Arguments

data — Chunk of data read from `sd datastore`

`timetable`

Chunk of samples read from the `matlab.io.datastore.simulationdatastore`, returned as a `timetable`.

Examples

Process Signal Data Using a `matlab.io.datastore.sd datastore`

A `matlab.io.datastore.sd datastore` references signal data in the Simulation Data Inspector repository. When the signal is too large to fit into memory, you can use the `matlab.io.datastore.sd datastore` to incrementally process the data manually or to create a tall `timetable` for the signal that handles the incremental processing for you. This example shows how to process data using a `matlab.io.datastore.sd datastore`.

Create a `matlab.io.datastore.sd datastore` for a Signal

Simulate the `sldemo_fuelsys` model, which is configured to log several signals, to create data in the Simulation Data Inspector repository.

```
sim('sldemo_fuelsys')
```

Use the Simulation Data Inspector programmatic interface to get the signal ID for the signal.

```
runCount = Simulink.sdi.getRunCount;
```

```
latestRunID = Simulink.sdi.getRunIDByIndex(runCount);
```

```
latestRun = Simulink.sdi.getRun(latestRunID);
```



```
speedSigID = latestRun.getSignalIDByIndex(4);
```

Use the signal ID to create a `matlab.io.datastore.sd datastore` for the speed signal.

```
speedSDIds = matlab.io.datastore.sd datastore(speedSigID);
```

Verify the Contents of the Datastore

Check the `Name` property of the `matlab.io.datastore.sd datastore` to verify that it matches your expectations.

```
speedSDIds.Name
```

```
ans =  
'map'
```

You can also use the `preview` method to check that the first ten samples in the signal look correct.

```
speedSDIds.preview
```

```
ans=10x1 timetable
      Time      Data
-----
0 sec          0.589
0.00056199 sec 0.58772
0.0033719 sec  0.58148
0.01 sec       0.56765
0.02 sec       0.54897
0.03 sec       0.53264
0.04 sec       0.51837
0.05 sec       0.50594
0.055328 sec   0.5
0.055328 sec   0.5
```

Process Signal Data with the `matlab.io.datastore.sd datastore`

When your signal is too large to fit into memory, you can use the `readData` method to read chunks of data from the Simulation Data Inspector repository to incrementally process your data. Use the `hasdata` method as the condition for a while loop to incrementally process the whole signal. For example, find the maximum signal value.

```
latestMax = [];
while speedSDIds.hasdata
    speedChunk = speedSDIds.read;
    speedChunkData = speedChunk.Data;
    latestMax = max([speedChunkData; latestMax]);
end
latestMax
latestMax = 0.8897
```

On each read operation, the `read` method updates the read position for the start of the next read operation. After reading some or all of the `matlab.io.datastore.sd datastore`, you can reset the read position to start again from the beginning of the signal.

```
speedSDIds.reset
```

Process Signal Data in Memory

When the signal referenced by your `matlab.io.datastore.sd datastore` fits into memory, you can use the `readall` method to read all the signal data into memory for processing, rather than reading and processing the data incrementally with the `read` method. The `readall` method returns a `timetable` with all the signal data.

```
speedTimetable = speedSDIds.readall;
```

```
speedMax = max(speedTimetable.Data)
```

```
speedMax = 0.8897
```

Alternatives

You can use your `matlab.io.datastore.sd datastore` to create a tall `timetable` to process signals too large to fit into memory. The tall `timetable` handles loading and processing the chunks of signal data for you. The `matlab.io.datastore.sd datastore` reference page includes an example that shows how to process your data using a tall `timetable`. For more information about working with tall `timetables`, see “Tall Arrays”.

See Also

`matlab.io.datastore.sd datastore`

Topics

“Datastore”

Introduced in R2017b

readall

Class: `matlab.io.datastore.sd datastore`

Package: `matlab.io.datastore`

Read all data from an `sd datastore`

Syntax

```
data = sdi_ds.readall
```

Description

`data = sdi_ds.readall` reads all the data in the `matlab.io.datastore.sd datastore`, `sdi_ds`, into memory, returning the `timetable`, `data`. Use `readall` only when the signal referenced by the `matlab.io.datastore.sd datastore` fits into memory.

Output Arguments

data — **timetable of data**

`timetable`

All the data in the `matlab.io.datastore.sd datastore`, returned in a `timetable`.

Examples

Process Signal Data Using a `matlab.io.datastore.sd datastore`

A `matlab.io.datastore.sd datastore` references signal data in the Simulation Data Inspector repository. When the signal is too large to fit into memory, you can use the `matlab.io.datastore.sd datastore` to incrementally process the data manually or to create a tall `timetable` for the signal that handles the incremental processing for you. This example shows how to process data using a `matlab.io.datastore.sd datastore`.

Create a `matlab.io.datastore.sd datastore` for a Signal

Simulate the `sldemo_fuelsys` model, which is configured to log several signals, to create data in the Simulation Data Inspector repository.

```
sim('sldemo_fuelsys')
```

Use the Simulation Data Inspector programmatic interface to get the signal ID for the signal.

```
runCount = Simulink.sdi.getRunCount;
```

```
latestRunID = Simulink.sdi.getRunIDByIndex(runCount);
```

```
latestRun = Simulink.sdi.getRun(latestRunID);
```

```
speedSigID = latestRun.getSignalIDByIndex(4);
```

Use the signal ID to create a `matlab.io.datastore.sd datastore` for the speed signal.

```
speedSDIds = matlab.io.datastore.sd datastore(speedSigID);
```

Verify the Contents of the Datastore

Check the Name property of the `matlab.io.datastore.sd datastore` to verify that it matches your expectations.

```
speedSDIds.Name
```

```
ans =  
'map'
```

You can also use the `preview` method to check that the first ten samples in the signal look correct.

```
speedSDIds.preview
```

```
ans=10x1 timetable  
      Time      Data  
-----  
0 sec          0.589  
0.00056199 sec 0.58772  
0.0033719 sec  0.58148  
0.01 sec       0.56765  
0.02 sec       0.54897  
0.03 sec       0.53264  
0.04 sec       0.51837  
0.05 sec       0.50594  
0.055328 sec   0.5  
0.055328 sec   0.5
```

Process Signal Data with the `matlab.io.datastore.sd datastore`

When your signal is too large to fit into memory, you can use the `readData` method to read chunks of data from the Simulation Data Inspector repository to incrementally process your data. Use the `hasdata` method as the condition for a while loop to incrementally process the whole signal. For example, find the maximum signal value.

```
latestMax = [];  
  
while speedSDIds.hasdata  
    speedChunk = speedSDIds.read;  
    speedChunkData = speedChunk.Data;  
    latestMax = max([speedChunkData; latestMax]);  
  
end  
  
latestMax  
  
latestMax = 0.8897
```

On each read operation, the `read` method updates the read position for the start of the next read operation. After reading some or all of the `matlab.io.datastore.sd datastore`, you can reset the read position to start again from the beginning of the signal.

```
speedSDIds.reset
```

Process Signal Data in Memory

When the signal referenced by your `matlab.io.datastore.sd datastore` fits into memory, you can use the `readall` method to read all the signal data into memory for processing, rather than reading and processing the data incrementally with the `read` method. The `readall` method returns a `timetable` with all the signal data.

```
speedTimetable = speedSDIds.readall;  
  
speedMax = max(speedTimetable.Data)  
  
speedMax = 0.8897
```

Alternatives

When your signals fit into memory, you can use other classes and functions of the Simulation Data Inspector programmatic interface, like the `Simulink.sdi.Signal` class, to access and process simulation data.

See Also

`matlab.io.datastore.sd datastore`

Topics

"Datastore"

Introduced in R2017b

reset

Class: `matlab.io.datastore.sd datastore`

Package: `matlab.io.datastore`

Reset the read position

Syntax

```
sdi_ds.reset
```

Description

`sdi_ds.reset` resets the read position for the `matlab.io.datastore.sd datastore`, `sdi_ds`, to the beginning.

Examples

Process Signal Data Using a `matlab.io.datastore.sd datastore`

A `matlab.io.datastore.sd datastore` references signal data in the Simulation Data Inspector repository. When the signal is too large to fit into memory, you can use the `matlab.io.datastore.sd datastore` to incrementally process the data manually or to create a tall timetable for the signal that handles the incremental processing for you. This example shows how to process data using a `matlab.io.datastore.sd datastore`.

Create a `matlab.io.datastore.sd datastore` for a Signal

Simulate the `sldemo_fuelsys` model, which is configured to log several signals, to create data in the Simulation Data Inspector repository.

```
sim('sldemo_fuelsys')
```

Use the Simulation Data Inspector programmatic interface to get the signal ID for the signal.

```
runCount = Simulink.sdi.getRunCount;  
latestRunID = Simulink.sdi.getRunIDByIndex(runCount);  
latestRun = Simulink.sdi.getRun(latestRunID);  
speedSigID = latestRun.getSignalIDByIndex(4);
```

Use the signal ID to create a `matlab.io.datastore.sd datastore` for the speed signal.

```
speedSDIDs = matlab.io.datastore.sd datastore(speedSigID);
```

Verify the Contents of the Datastore

Check the Name property of the `matlab.io.datastore.sd datastore` to verify that it matches your expectations.

```
speedSDIDs.Name
```

```
ans =
'map'
```

You can also use the `preview` method to check that the first ten samples in the signal look correct.

```
speedSDIds.preview
```

```
ans=10x1 timetable
      Time      Data
-----
0 sec          0.589
0.00056199 sec 0.58772
0.0033719 sec  0.58148
0.01 sec       0.56765
0.02 sec       0.54897
0.03 sec       0.53264
0.04 sec       0.51837
0.05 sec       0.50594
0.055328 sec   0.5
0.055328 sec   0.5
```

Process Signal Data with the `matlab.io.datastore.sd datastore`

When your signal is too large to fit into memory, you can use the `readData` method to read chunks of data from the Simulation Data Inspector repository to incrementally process your data. Use the `hasdata` method as the condition for a while loop to incrementally process the whole signal. For example, find the maximum signal value.

```
latestMax = [];
while speedSDIds.hasdata
    speedChunk = speedSDIds.read;
    speedChunkData = speedChunk.Data;
    latestMax = max([speedChunkData; latestMax]);
end
```

```
latestMax
latestMax = 0.8897
```

On each read operation, the `read` method updates the read position for the start of the next read operation. After reading some or all of the `matlab.io.datastore.sd datastore`, you can reset the read position to start again from the beginning of the signal.

```
speedSDIds.reset
```

Process Signal Data in Memory

When the signal referenced by your `matlab.io.datastore.sd datastore` fits into memory, you can use the `readall` method to read all the signal data into memory for processing, rather than reading and processing the data incrementally with the `read` method. The `readall` method returns a `timetable` with all the signal data.

```
speedT timetable = speedSDIds.readall;  
speedMax = max(speedT timetable.Data)  
speedMax = 0.8897
```

See Also

matlab.io.datastore.sd datastore

Topics

“Datastore”

Introduced in R2017b

matlab.io.datastore.SimulationDatastore class

Package: matlab.io.datastore

Datastore for inputs and outputs of Simulink models

Description

A `matlab.io.datastore.SimulationDatastore` object enables a Simulink model to interact with big data. You can load big data as simulation input and log big output data from a simulation. To simulate models with big data, you store the data in a MAT-file and refer to the data through a `SimulationDatastore` object. See “Work with Big Data for Simulations”.

A `SimulationDatastore` object refers to big simulation data (which a MAT-file stores) for one signal. If the MAT-file stores simulation data for a bus signal, a `SimulationDatastore` object refers to the data for one leaf signal element in the bus. You can use the datastore object to inspect and access the data and, through a parent object such as `Simulink.SimulationData.Signal`, simulate a Simulink model with the data.

To analyze the datastore data, you can use the methods and properties of the `SimulationDatastore` object as well as MATLAB tools such as the `tall` function. For more information about the MATLAB tools, see “Getting Started with Datastore”.

Construction

After you store big simulation data in a `Simulink.SimulationData.Dataset` object in a MAT-file, a signal element in the `Dataset` object points to the big data. To create a `matlab.io.datastore.SimulationDatastore` object that refers to the big data:

- 1 At the command prompt or in a script, create a `Simulink.SimulationData.DatasetRef` object that refers to the `Dataset` object in the MAT-file.
- 2 Use one of these techniques:
 - Use one-based, curly-brace indexing (for example, `{1}`) to return an object that represents the target signal element, such as `Simulink.SimulationData.Signal` or `Simulink.SimulationData.State`. For example, for a `DatasetRef` object named `logout_ref`, to create a `Signal` object that refers to the second signal element, use this code:

```
myLoggedSig = logout_ref{2}
```
 - Use the `getAsDatastore` method of the `DatasetRef` object to return an object that represents the target signal element. For more information, see `getAsDatastore`.

The `SimulationDatastore` object resides in the `Values` property of the returned object.

Properties

FileName — Name and path of file that contains big data

character vector

Name and path of the file that contains the big data, returned as a character vector. This property is read-only.

Data Types: `char`

NumSamples — Total number of samples (time steps) in the datastore

`integer`

Total number of samples (time steps) in the datastore, returned as an integer. The `readall` method extracts this many samples from the big data. This property is read-only.

Data Types: `uint64`

ReadSize — Amount of data to read at a time

`100` (default) | `scalar double`

Amount of data to read at a time, in number of samples (time steps), specified as a scalar double. The `read` method extracts this many samples from the big data.

Data Types: `double`

Methods

| | |
|------------------------------|---|
| <code>hasdata</code> | Determine if data is available to read |
| <code>isPartitionable</code> | Determine whether datastore is partitionable |
| <code>isShuffleable</code> | Determine whether datastore is shuffleable |
| <code>preview</code> | Return subset of data from datastore |
| <code>progress</code> | Return percentage of data that you have read from a datastore |
| <code>read</code> | Read data in datastore |
| <code>readall</code> | Read all data in datastore |
| <code>reset</code> | Reset datastore to initial state |

Copy Semantics

Handle. To learn how handle classes affect copy operations, see [Copying Objects](#).

Limitations

- `SimulationDatastore` does not support using a parallel pool with Parallel Computing Toolbox installed. To analyze data using tall arrays or run MapReduce algorithms, set the global execution environment to be the local MATLAB session using `mapreducer`. Enter this code:

```
mapreducer(0)
```

For information about controlling parallel resources, see “Run mapreduce on a Parallel Pool” (Parallel Computing Toolbox).

- You cannot use a MATLAB tall variable as simulation input data.

Examples

Inspect and Analyze Data in Simulation Datastore

This example shows how to log big data from a simulation and inspect and analyze portions of that data by interacting with a `matlab.io.datastore.SimulationDatastore` object.

Log Big Data from Model

Open the example model `sldemo_fuelsys`.

```
open_system('sldemo_fuelsys')
```

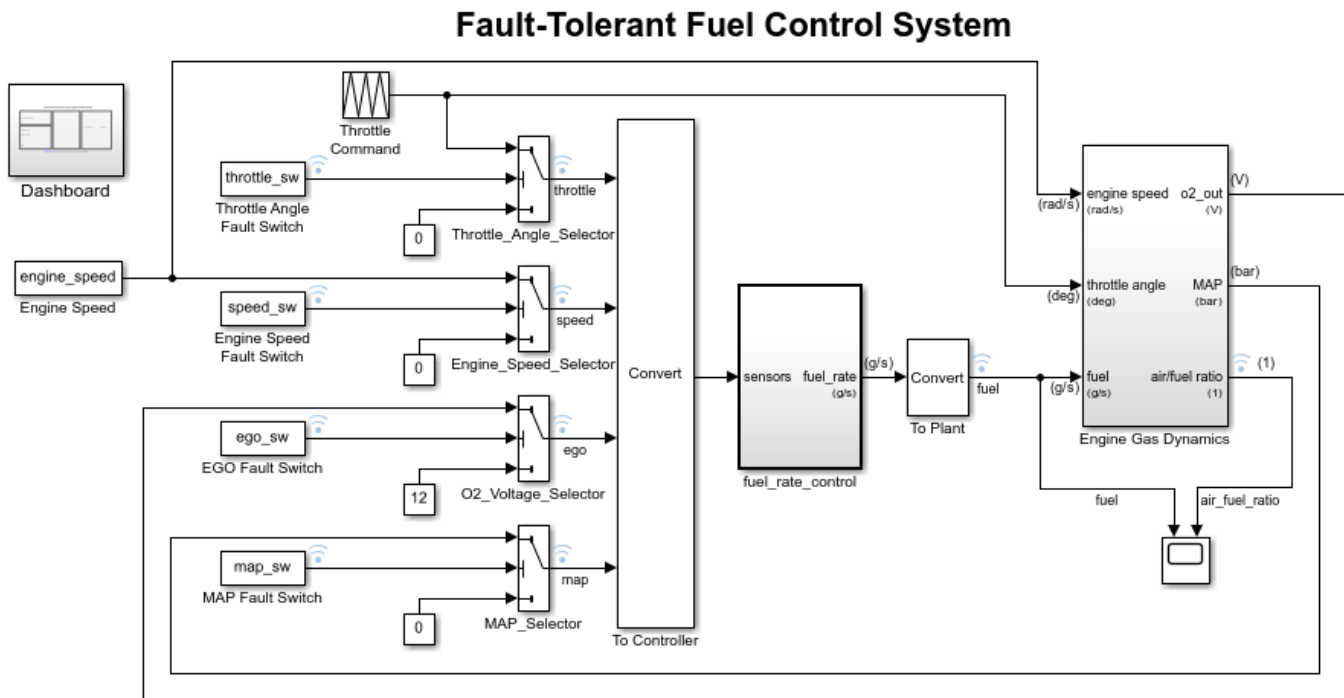

[Open the Dashboard](#) subsystem to simulate any combination of sensor failures.

Copyright 1990-2017 The MathWorks, Inc.

Select **Configuration Parameters > Data Import/Export > Log Dataset data to file.**

```
set_param('sldemo_fuelsys', 'LoggingToFile', 'on')
```

Simulate the model.

```
sim('sldemo_fuelsys')
```

The MAT-file `out.mat` appears in your current folder. The file contains data for logged signals such as `fuel` (which is at the root level of the model).

At the command prompt, create a `DatasetRef` object that refers to the logging variable by name, `sldemo_fuelsys_output`.

```
DSRef = Simulink.SimulationData.DatasetRef('out.mat', 'sldemo_fuelsys_output');
```

Preview Big Data

Use curly braces (`{` and `}`) to extract the signal element `fuel`, which is the tenth element in `DSRef`, as a `Simulink.SimulationData.Signal` object that contains a `SimulationDatastore` object.

```
SimDataSig = DSRef{10};
```

To more easily interact with the `SimulationDatastore` object that resides in the `Values` property of the `Signal` object, store a handle in a variable named `DStore`.

```
DStore = SimDataSig.Values;
```

Use the `preview` method to inspect the first five samples of logged data for the `fuel` signal.

```
preview(DStore)
```

```
ans =
```

```
10x1 timetable
```

| Time | Data |
|----------------|--------|
| 0 sec | 1.209 |
| 0.00056199 sec | 1.209 |
| 0.0033719 sec | 1.209 |
| 0.01 sec | 1.1729 |
| 0.02 sec | 1.1409 |
| 0.03 sec | 1.1124 |
| 0.04 sec | 1.0873 |
| 0.05 sec | 1.0652 |
| 0.055328 sec | 1.0652 |
| 0.055328 sec | 1.0652 |

Inspect Specific Sample

Inspect the 603rd sample of logged `fuel` data.

Set the `ReadSize` property of `DStore` to a number that, considering memory resources, your computer can tolerate. For example, set `ReadSize` to 200.

```
DStore.ReadSize = 200;
```

Read from the datastore three times. Each read operation advances the reading position by 200 samples.

```
read(DStore);
read(DStore);
read(DStore);
```

Now that you are very close to the 603rd sample, set `ReadSize` to a smaller number. For example, set `ReadSize` to 5.

```
DStore.ReadSize = 5;
```

Read from the datastore again.

```
read(DStore)
```

```
ans =
```

```
5x1 timetable
```

| Time | Data |
|----------|--------|
| 5.79 sec | 1.6097 |
| 5.8 sec | 1.6136 |
| 5.81 sec | 1.6003 |
| 5.82 sec | 1.5904 |
| 5.83 sec | 1.5832 |

The third sample of read data is the 603rd sample in the datastore.

Inspect Earlier Sample

Inspect the 403rd sample of logged `fuel` data. Due to previous read operations, the datastore now reads starting from the 606th sample, so you must reset the datastore. Then, you can read from the first sample up to the 403rd sample.

Use the `reset` method to reset `DStore`.

```
reset(DStore);
```

Set `ReadSize` to 200 again.

```
DStore.ReadSize = 200;
```

Read from the datastore twice to advance the read position to the 401st sample.

```
read(DStore);
read(DStore);
```

Set `ReadSize` to 5 again.

```
DStore.ReadSize = 5;
```

Read from the datastore.

```
read(DStore)
```

```
ans =
```

```
5x1 timetable
```

| Time | Data |
|----------|---------|
| 3.85 sec | 0.999 |
| 3.86 sec | 0.99219 |
| 3.87 sec | 0.98538 |
| 3.88 sec | 0.97858 |

3.89 sec 0.97179

Extract Multiple Samples

Extract samples 1001 through 1020 (a total of 20 samples).

Reset the datastore.

```
reset(DStore)
```

Advance to sample 1001.

```
DStore.ReadSize = 200;
```

```
for i = 1:5  
    read(DStore);  
end
```

Prepare to extract 20 samples from the datastore.

```
DStore.ReadSize = 20;
```

Extract samples 1001 through 1020. Store the extracted data in a variable named `targetSamples`.

```
targetSamples = read(DStore)
```

```
targetSamples =
```

```
20x1 timetable
```

| Time | Data |
|----------|--------|
| 9.7 sec | 1.5828 |
| 9.71 sec | 1.5733 |
| 9.72 sec | 1.5664 |
| 9.73 sec | 1.5614 |
| 9.74 sec | 1.5579 |
| 9.75 sec | 1.5553 |
| 9.76 sec | 1.5703 |
| 9.77 sec | 1.582 |
| 9.78 sec | 1.5913 |
| 9.79 sec | 1.5988 |
| 9.8 sec | 1.605 |
| 9.81 sec | 1.6101 |
| 9.82 sec | 1.6145 |
| 9.83 sec | 1.6184 |
| 9.84 sec | 1.6049 |
| 9.85 sec | 1.595 |
| 9.86 sec | 1.5877 |
| 9.87 sec | 1.5824 |
| 9.88 sec | 1.5785 |
| 9.89 sec | 1.5757 |

Find Maximum Value of Data in Datastore

Reset the datastore.

```
reset(DStore)
```

Write a while loop, using the `hasdata` method, to incrementally analyze the data in chunks of 200 samples.

```
DStore.ReadSize = 200;
runningMax = [];
while hasdata(DStore)
    tt = read(DStore);
    rawChunk = tt.Data;
    runningMax = max([rawChunk; runningMax]);
end
```

Now, the variable `runningMax` stores the maximum value in the entire datastore.

```
runningMax
```

```
runningMax =
```

```
    1.6423
```

See Also

Topics

“Work with Big Data for Simulations”

Introduced in R2017a

hasdata

Class: `matlab.io.datastore.SimulationDatastore`

Package: `matlab.io.datastore`

Determine if data is available to read

Syntax

```
tf = hasdata(dst)
```

Description

`tf = hasdata(dst)` returns logical 1 (true) if there is data available to read from the datastore (`matlab.io.datastore.SimulationDatastore` object) specified by `dst`. Otherwise, it returns logical 0 (false).

Input Arguments

dst — Input datastore

`matlab.io.datastore.SimulationDatastore` object

Input datastore, specified as a `matlab.io.datastore.SimulationDatastore` object. To create a `SimulationDatastore` object, see `matlab.io.datastore.SimulationDatastore`.

Examples

Inspect and Analyze Data in Simulation Datastore

This example shows how to log big data from a simulation and inspect and analyze portions of that data by interacting with a `matlab.io.datastore.SimulationDatastore` object.

Log Big Data from Model

Open the example model `sldemo_fuelsys`.

```
open_system('sldemo_fuelsys')
```

Fault-Tolerant Fuel Control System

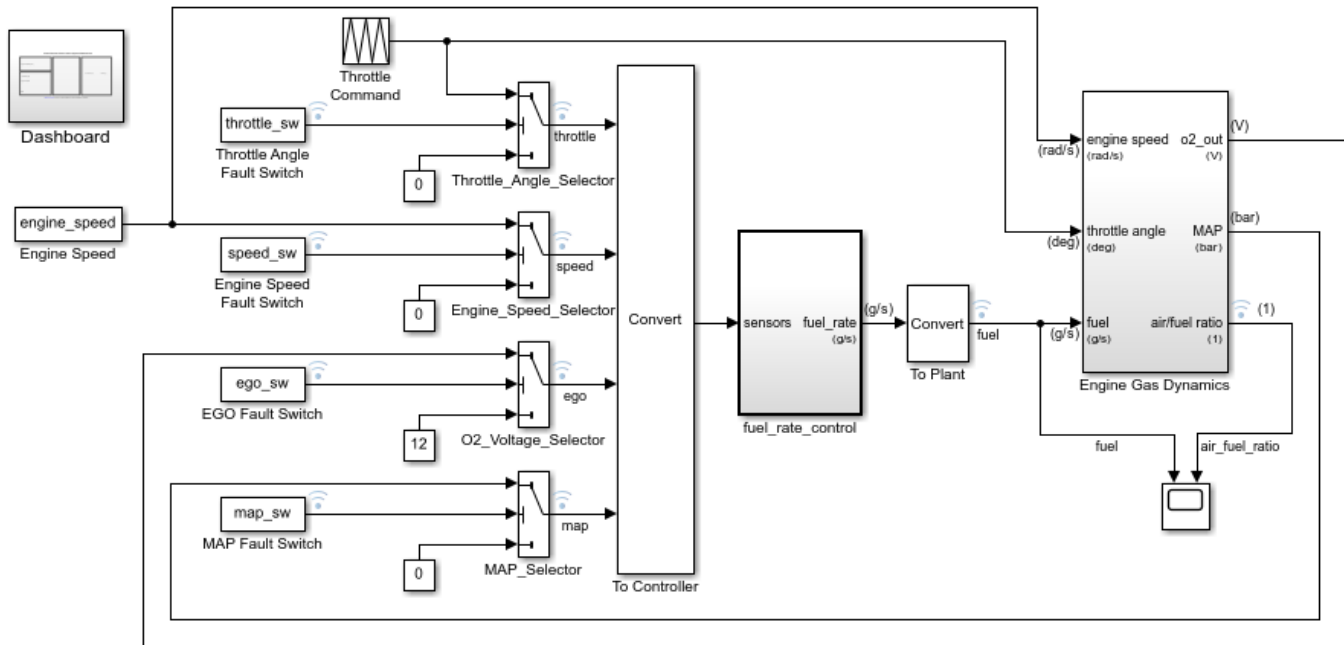

[Open the Dashboard](#) subsystem to simulate any combination of sensor failures.

Copyright 1990-2017 The MathWorks, Inc.

Select **Configuration Parameters > Data Import/Export > Log Dataset data to file.**

```
set_param('sldemo_fuelsys', 'LoggingToFile', 'on')
```

Simulate the model.

```
sim('sldemo_fuelsys')
```

The MAT-file `out.mat` appears in your current folder. The file contains data for logged signals such as `fuel` (which is at the root level of the model).

At the command prompt, create a `DatasetRef` object that refers to the logging variable by name, `sldemo_fuelsys_output`.

```
DSRef = Simulink.SimulationData.DatasetRef('out.mat', 'sldemo_fuelsys_output');
```

Preview Big Data

Use curly braces (`{}` and `}`) to extract the signal element `fuel`, which is the tenth element in `DSRef`, as a `Simulink.SimulationData.Signal` object that contains a `SimulationDatastore` object.

```
SimDataSig = DSRef{10};
```

To more easily interact with the `SimulationDatastore` object that resides in the `Values` property of the `Signal` object, store a handle in a variable named `DStore`.

```
DStore = SimDataSig.Values;
```

Use the `preview` method to inspect the first five samples of logged data for the `fuel` signal.

```
preview(DStore)
```

```
ans =
```

```
10x1 timetable
```

| Time | Data |
|----------------|--------|
| 0 sec | 1.209 |
| 0.00056199 sec | 1.209 |
| 0.0033719 sec | 1.209 |
| 0.01 sec | 1.1729 |
| 0.02 sec | 1.1409 |
| 0.03 sec | 1.1124 |
| 0.04 sec | 1.0873 |
| 0.05 sec | 1.0652 |
| 0.055328 sec | 1.0652 |
| 0.055328 sec | 1.0652 |

Inspect Specific Sample

Inspect the 603rd sample of logged fuel data.

Set the `ReadSize` property of `DStore` to a number that, considering memory resources, your computer can tolerate. For example, set `ReadSize` to 200.

```
DStore.ReadSize = 200;
```

Read from the datastore three times. Each read operation advances the reading position by 200 samples.

```
read(DStore);  
read(DStore);  
read(DStore);
```

Now that you are very close to the 603rd sample, set `ReadSize` to a smaller number. For example, set `ReadSize` to 5.

```
DStore.ReadSize = 5;
```

Read from the datastore again.

```
read(DStore)
```

```
ans =
```

```
5x1 timetable
```

| Time | Data |
|----------|--------|
| 5.79 sec | 1.6097 |
| 5.8 sec | 1.6136 |
| 5.81 sec | 1.6003 |
| 5.82 sec | 1.5904 |

```
5.83 sec    1.5832
```

The third sample of read data is the 603rd sample in the datastore.

Inspect Earlier Sample

Inspect the 403rd sample of logged `fuel` data. Due to previous read operations, the datastore now reads starting from the 606th sample, so you must reset the datastore. Then, you can read from the first sample up to the 403rd sample.

Use the `reset` method to reset `DStore`.

```
reset(DStore);
```

Set `ReadSize` to 200 again.

```
DStore.ReadSize = 200;
```

Read from the datastore twice to advance the read position to the 401st sample.

```
read(DStore);
read(DStore);
```

Set `ReadSize` to 5 again.

```
DStore.ReadSize = 5;
```

Read from the datastore.

```
read(DStore)
```

```
ans =
```

```
5x1 timetable
```

| Time | Data |
|----------|---------|
| 3.85 sec | 0.999 |
| 3.86 sec | 0.99219 |
| 3.87 sec | 0.98538 |
| 3.88 sec | 0.97858 |
| 3.89 sec | 0.97179 |

Extract Multiple Samples

Extract samples 1001 through 1020 (a total of 20 samples).

Reset the datastore.

```
reset(DStore)
```

Advance to sample 1001.

```
DStore.ReadSize = 200;
```

```
for i = 1:5
    read(DStore);
end
```

Prepare to extract 20 samples from the datastore.

```
DStore.ReadSize = 20;
```

Extract samples 1001 through 1020. Store the extracted data in a variable named `targetSamples`.

```
targetSamples = read(DStore)
```

```
targetSamples =
```

```
20x1 timetable
```

| Time | Data |
|----------|--------|
| 9.7 sec | 1.5828 |
| 9.71 sec | 1.5733 |
| 9.72 sec | 1.5664 |
| 9.73 sec | 1.5614 |
| 9.74 sec | 1.5579 |
| 9.75 sec | 1.5553 |
| 9.76 sec | 1.5703 |
| 9.77 sec | 1.582 |
| 9.78 sec | 1.5913 |
| 9.79 sec | 1.5988 |
| 9.8 sec | 1.605 |
| 9.81 sec | 1.6101 |
| 9.82 sec | 1.6145 |
| 9.83 sec | 1.6184 |
| 9.84 sec | 1.6049 |
| 9.85 sec | 1.595 |
| 9.86 sec | 1.5877 |
| 9.87 sec | 1.5824 |
| 9.88 sec | 1.5785 |
| 9.89 sec | 1.5757 |

Find Maximum Value of Data in Datastore

Reset the datastore.

```
reset(DStore)
```

Write a `while` loop, using the `hasdata` method, to incrementally analyze the data in chunks of 200 samples.

```
DStore.ReadSize = 200;
runningMax = [];
while hasdata(DStore)
    tt = read(DStore);
    rawChunk = tt.Data;
    runningMax = max([rawChunk; runningMax]);
end
```

Now, the variable `runningMax` stores the maximum value in the entire datastore.

```
runningMax
```

```
runningMax =
```

```
  1.6423
```

See Also

Topics

“Work with Big Data for Simulations”

Introduced in R2017a

isPartitionable

Class: `matlab.io.datastore.SimulationDatastore`

Package: `matlab.io.datastore`

Determine whether datastore is partitionable

Syntax

```
tf = isPartitionable(ds)
```

Description

`tf = isPartitionable(ds)` returns logical 1 (true) if the datastore `ds` is partitionable. Otherwise, the result is logical 0 (false).

Input Arguments

ds — Input datastore

datastore

Input datastore. You can use these datastores as input:

- MATLAB datastores — Datastores created using MATLAB datastore functions. For a complete list of datastores, see “Select Datastore for File Format or Application”.
- Combined and transformed datastores — Datastores created using the `combine` and `transform` functions.
- Custom datastores — Datastores created using the custom datastore framework. Any datastore that subclasses from `matlab.io.Datastore` supports the `isPartitionable` function. See “Develop Custom Datastore” for more information.

Examples

Test Partitionability of Simulation Datastore

This example shows how to determine the partitionability of a `matlab.io.datastore.SimulationDatastore` object that contains big data from a simulation.

Log Big Data from Model

Open the example model `sldemo_fuelsys`.

```
open_system('sldemo_fuelsys')
```

Fault-Tolerant Fuel Control System

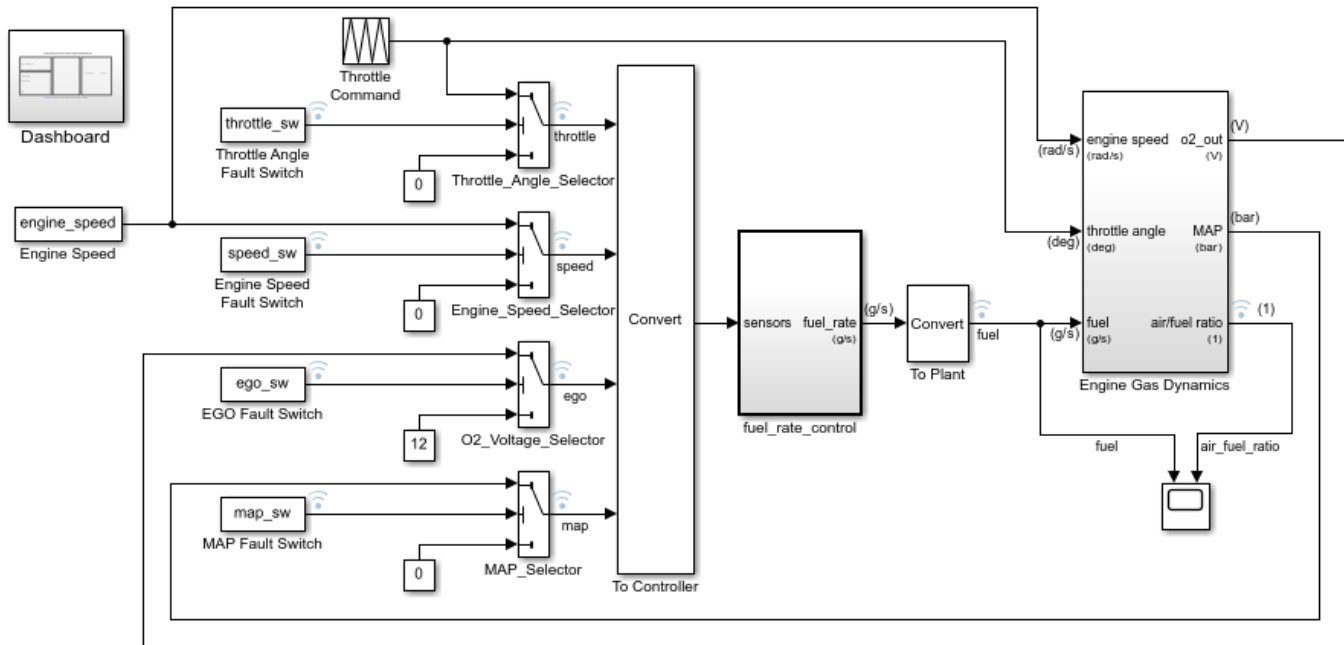

[Open the Dashboard](#) subsystem to simulate any combination of sensor failures.

Copyright 1990-2017 The MathWorks, Inc.

Select **Configuration Parameters > Data Import/Export > Log Dataset data to file.**

```
set_param('sldemo_fuelsys', 'LoggingToFile', 'on')
```

Simulate the model.

```
sim('sldemo_fuelsys')
```

The MAT-file `out.mat` appears in your current folder. The file contains data for logged signals such as `fuel` (which is at the root level of the model).

At the command prompt, create a `DatasetRef` object that refers to the logging variable by name, `sldemo_fuelsys_output`.

```
DSRef = Simulink.SimulationData.DatasetRef('out.mat', 'sldemo_fuelsys_output');
```

Preview Big Data

Use curly braces (`{}` and `}`) to extract the signal element `fuel`, which is the tenth element in `DSRef`, as a `Simulink.SimulationData.Signal` object that contains a `SimulationDatastore` object.

```
SimDataSig = DSRef{10};
```

To more easily interact with the `SimulationDatastore` object that resides in the `Values` property of the `Signal` object, store a handle in a variable named `DStore`.

```
DStore = SimDataSig.Values;
```

Determine if the datastore is partitionable.

```
if isPartitionable(DStore)
    disp('Datastore is partitionable.')
else
    disp('Datastore is not partitionable.')
end
```

Datastore is not partitionable.

See Also

[partition](#) | [numpartitions](#) | [datastore](#) | [matlab.io.Datastore](#)

Topics

[“Getting Started with Datastore”](#)

[“Set Up Datastore for Processing on Different Machines or Clusters”](#)

Introduced in R2020a

isShuffleable

Class: `matlab.io.datastore.SimulationDatastore`

Package: `matlab.io.datastore`

Determine whether datastore is shuffleable

Syntax

```
tf = isShuffleable(ds)
```

Description

`tf = isShuffleable(ds)` returns logical 1 (true) if the datastore `ds` is shuffleable. Otherwise, the result is logical 0 (false).

You can use the `shuffle` function on shuffleable datastores to randomize the ordering of files, while preserving the row associations of files in different datastores.

Input Arguments

ds — Input datastore

datastore

Input datastore. You can use these datastores as input:

- MATLAB datastores — Datastores created using MATLAB `datastore` functions. For a complete list of datastores, see “Select Datastore for File Format or Application”.
- Combined and transformed datastores — Datastores created using the `combine` and `transform` functions.
- Custom datastores — Datastores created using the custom datastore framework. Any datastore that subclasses from `matlab.io.Datastore` supports the `isShuffleable` function. See “Develop Custom Datastore” for more information.

Examples

Test Shuffleability of Simulation Datastore

This example shows how to determine the shuffleability of a `matlab.io.datastore.SimulationDatastore` object that contains big data from a simulation.

Log Big Data from Model

Open the example model `sldemo_fuelsys`.

```
open_system('sldemo_fuelsys')
```

Fault-Tolerant Fuel Control System

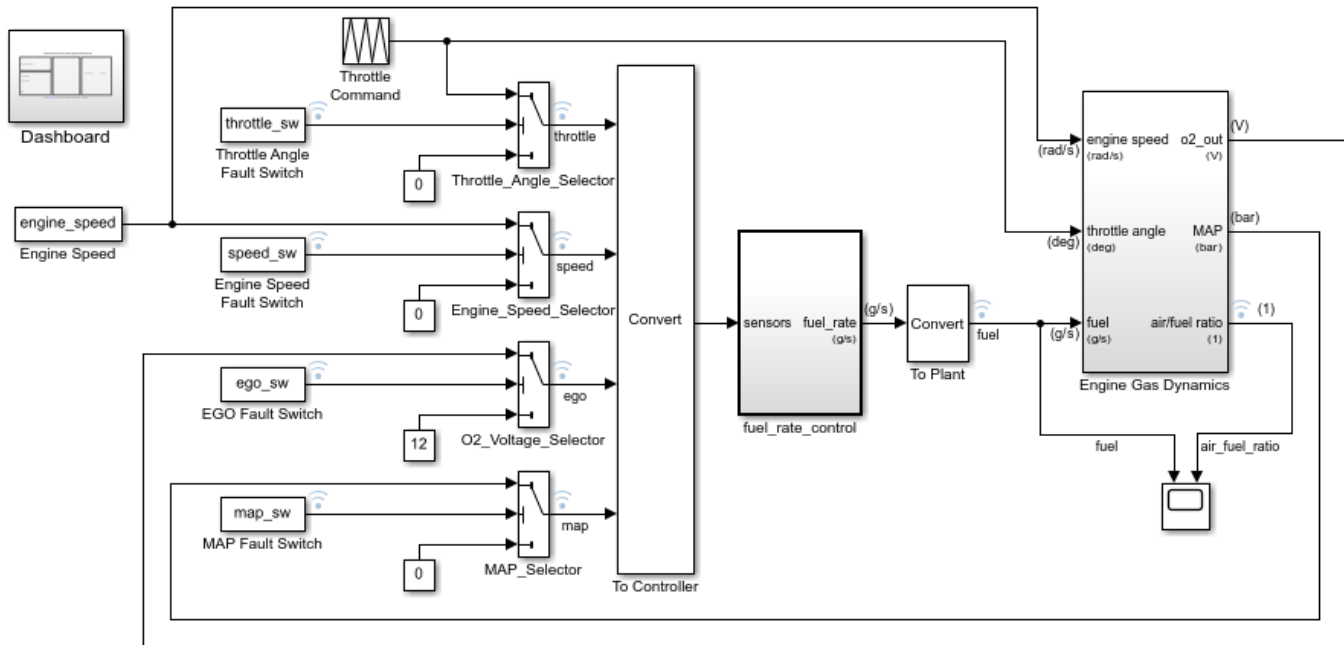

[Open the Dashboard](#) subsystem to simulate any combination of sensor failures.

Copyright 1990-2017 The MathWorks, Inc.

Select **Configuration Parameters > Data Import/Export > Log Dataset data to file.**

```
set_param('sldemo_fuelsys', 'LoggingToFile', 'on')
```

Simulate the model.

```
sim('sldemo_fuelsys')
```

The MAT-file `out.mat` appears in your current folder. The file contains data for logged signals such as `fuel` (which is at the root level of the model).

At the command prompt, create a `DatasetRef` object that refers to the logging variable by name, `sldemo_fuelsys_output`.

```
DSRef = Simulink.SimulationData.DatasetRef('out.mat', 'sldemo_fuelsys_output');
```

Preview Big Data

Use curly braces (`{}` and `}`) to extract the signal element `fuel`, which is the tenth element in `DSRef`, as a `Simulink.SimulationData.Signal` object that contains a `SimulationDatastore` object.

```
SimDataSig = DSRef{10};
```

To more easily interact with the `SimulationDatastore` object that resides in the `Values` property of the `Signal` object, store a handle in a variable named `DStore`.

```
DStore = SimDataSig.Values;
```

Determine if the datastore is shuffleable.

```
if isShuffleable(DStore)
    disp('Datastore is shuffleable.')
else
    disp('Datatstore is not shuffleable.')
end
```

Datatstore is not shuffleable.

See Also

[datastore](#) | [shuffle](#) | [matlab.io.Datastore](#)

Topics

“Getting Started with Datastore”

Introduced in R2020a

preview

Class: `matlab.io.datastore.SimulationDatastore`

Package: `matlab.io.datastore`

Return subset of data from datastore

Syntax

```
data = preview(dst)
```

Description

`data = preview(dst)` returns a subset of data from datastore (`matlab.io.datastore.SimulationDatastore` object) `dst` without changing its current read position. `preview` returns only the first ten samples (time steps) of data in the datastore. Use this method to quickly inspect and verify that the data appears as you expect.

Input Arguments

dst — Input datastore

`matlab.io.datastore.SimulationDatastore` object

Input datastore, specified as a `matlab.io.datastore.SimulationDatastore` object. To create a `SimulationDatastore` object, see `matlab.io.datastore.SimulationDatastore`.

Output Arguments

data — Subset of data

`timetable` object

Subset of data, returned as a `timetable` object. For information about `timetable`, see “Timetables”.

Examples

Inspect and Analyze Data in Simulation Datastore

This example shows how to log big data from a simulation and inspect and analyze portions of that data by interacting with a `matlab.io.datastore.SimulationDatastore` object.

Log Big Data from Model

Open the example model `sldemo_fuelsys`.

```
open_system('sldemo_fuelsys')
```

Fault-Tolerant Fuel Control System

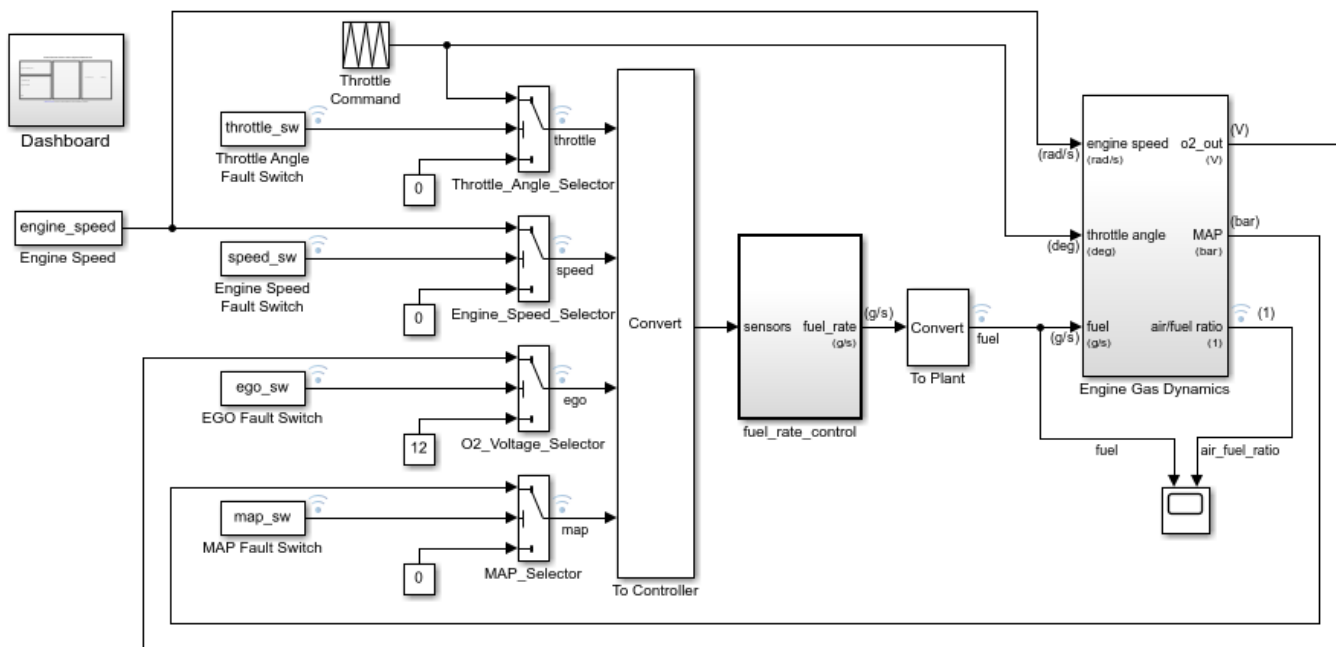

[Open the Dashboard](#) subsystem to simulate any combination of sensor failures.

Copyright 1990-2017 The MathWorks, Inc.

Select **Configuration Parameters > Data Import/Export > Log Dataset data to file.**

```
set_param('sldemo_fuelsys', 'LoggingToFile', 'on')
```

Simulate the model.

```
sim('sldemo_fuelsys')
```

The MAT-file `out.mat` appears in your current folder. The file contains data for logged signals such as `fuel` (which is at the root level of the model).

At the command prompt, create a `DatasetRef` object that refers to the logging variable by name, `sldemo_fuelsys_output`.

```
DSRef = Simulink.SimulationData.DatasetRef('out.mat', 'sldemo_fuelsys_output');
```

Preview Big Data

Use curly braces (`{}` and `}`) to extract the signal element `fuel`, which is the tenth element in `DSRef`, as a `Simulink.SimulationData.Signal` object that contains a `SimulationDatastore` object.

```
SimDataSig = DSRef{10};
```

To more easily interact with the `SimulationDatastore` object that resides in the `Values` property of the `Signal` object, store a handle in a variable named `DStore`.

```
DStore = SimDataSig.Values;
```

Use the `preview` method to inspect the first five samples of logged data for the `fuel` signal.

```
preview(DStore)
```

```
ans =
```

```
10x1 timetable
```

| Time | Data |
|----------------|--------|
| 0 sec | 1.209 |
| 0.00056199 sec | 1.209 |
| 0.0033719 sec | 1.209 |
| 0.01 sec | 1.1729 |
| 0.02 sec | 1.1409 |
| 0.03 sec | 1.1124 |
| 0.04 sec | 1.0873 |
| 0.05 sec | 1.0652 |
| 0.055328 sec | 1.0652 |
| 0.055328 sec | 1.0652 |

Inspect Specific Sample

Inspect the 603rd sample of logged fuel data.

Set the `ReadSize` property of `DStore` to a number that, considering memory resources, your computer can tolerate. For example, set `ReadSize` to 200.

```
DStore.ReadSize = 200;
```

Read from the datastore three times. Each read operation advances the reading position by 200 samples.

```
read(DStore);
read(DStore);
read(DStore);
```

Now that you are very close to the 603rd sample, set `ReadSize` to a smaller number. For example, set `ReadSize` to 5.

```
DStore.ReadSize = 5;
```

Read from the datastore again.

```
read(DStore)
```

```
ans =
```

```
5x1 timetable
```

| Time | Data |
|----------|--------|
| 5.79 sec | 1.6097 |
| 5.8 sec | 1.6136 |
| 5.81 sec | 1.6003 |
| 5.82 sec | 1.5904 |

```
5.83 sec    1.5832
```

The third sample of read data is the 603rd sample in the datastore.

Inspect Earlier Sample

Inspect the 403rd sample of logged fuel data. Due to previous read operations, the datastore now reads starting from the 606th sample, so you must reset the datastore. Then, you can read from the first sample up to the 403rd sample.

Use the `reset` method to reset `DStore`.

```
reset(DStore);
```

Set `ReadSize` to 200 again.

```
DStore.ReadSize = 200;
```

Read from the datastore twice to advance the read position to the 401st sample.

```
read(DStore);
read(DStore);
```

Set `ReadSize` to 5 again.

```
DStore.ReadSize = 5;
```

Read from the datastore.

```
read(DStore)
```

```
ans =
```

```
5x1 timetable
```

| Time | Data |
|----------|---------|
| 3.85 sec | 0.999 |
| 3.86 sec | 0.99219 |
| 3.87 sec | 0.98538 |
| 3.88 sec | 0.97858 |
| 3.89 sec | 0.97179 |

Extract Multiple Samples

Extract samples 1001 through 1020 (a total of 20 samples).

Reset the datastore.

```
reset(DStore)
```

Advance to sample 1001.

```
DStore.ReadSize = 200;
```

```
for i = 1:5
    read(DStore);
end
```

Prepare to extract 20 samples from the datastore.

```
DStore.ReadSize = 20;
```

Extract samples 1001 through 1020. Store the extracted data in a variable named `targetSamples`.

```
targetSamples = read(DStore)
```

```
targetSamples =
```

```
20x1 timetable
```

| Time | Data |
|----------|--------|
| 9.7 sec | 1.5828 |
| 9.71 sec | 1.5733 |
| 9.72 sec | 1.5664 |
| 9.73 sec | 1.5614 |
| 9.74 sec | 1.5579 |
| 9.75 sec | 1.5553 |
| 9.76 sec | 1.5703 |
| 9.77 sec | 1.582 |
| 9.78 sec | 1.5913 |
| 9.79 sec | 1.5988 |
| 9.8 sec | 1.605 |
| 9.81 sec | 1.6101 |
| 9.82 sec | 1.6145 |
| 9.83 sec | 1.6184 |
| 9.84 sec | 1.6049 |
| 9.85 sec | 1.595 |
| 9.86 sec | 1.5877 |
| 9.87 sec | 1.5824 |
| 9.88 sec | 1.5785 |
| 9.89 sec | 1.5757 |

Find Maximum Value of Data in Datastore

Reset the datastore.

```
reset(DStore)
```

Write a `while` loop, using the `hasdata` method, to incrementally analyze the data in chunks of 200 samples.

```
DStore.ReadSize = 200;
runningMax = [];
while hasdata(DStore)
    tt = read(DStore);
    rawChunk = tt.Data;
    runningMax = max([rawChunk; runningMax]);
end
```

Now, the variable `runningMax` stores the maximum value in the entire datastore.

```
runningMax
```

```
runningMax =
```

```
    1.6423
```

See Also

Topics

“Work with Big Data for Simulations”

Introduced in R2017a

progress

Class: `matlab.io.datastore.SimulationDatastore`

Package: `matlab.io.datastore`

Return percentage of data that you have read from a datastore

Syntax

```
p = progress(dst)
```

Description

`p = progress(dst)` returns the percentage, as a number between 0 and 1, of the data that you have read from a datastore (`matlab.io.datastore.SimulationDatastore` object). For example, a return value of 0.55 means you have read 55% of the data. Use the `progress` method and the `NumSamples` property to determine the current read position.

You read data from a `SimulationDatastore` object by using the `read` method.

Input Arguments

dst — Input datastore

`matlab.io.datastore.SimulationDatastore` object

Input datastore, specified as a `matlab.io.datastore.SimulationDatastore` object. To create a `SimulationDatastore` object, see `matlab.io.datastore.SimulationDatastore`.

Output Arguments

p — Percentage of data that you have read from the datastore

scalar double

Percentage of data that you have read from the datastore, returned as a scalar double.

Data Types: double

See Also

Topics

“Work with Big Data for Simulations”

Introduced in R2017a

read

Class: `matlab.io.datastore.SimulationDatastore`

Package: `matlab.io.datastore`

Read data in datastore

Syntax

```
data = read(dst)
[data,info] = read(dst)
```

Description

`data = read(dst)` returns data from a datastore (`matlab.io.datastore.SimulationDatastore` object). Subsequent calls to the `read` function continue reading from the endpoint of the previous call. Use the `ReadSize` property of the `SimulationDatastore` object to specify the amount of data, in samples (time steps), to read at a time. Use the `progress` method and the `NumSamples` property to determine the current read position.

`[data,info] = read(dst)` also returns information about the extracted data in `info`.

Input Arguments

dst — Input datastore

`matlab.io.datastore.SimulationDatastore` object

Input datastore, specified as a `matlab.io.datastore.SimulationDatastore` object. To create a `SimulationDatastore` object, see `matlab.io.datastore.SimulationDatastore`.

Output Arguments

data — Output data

`timetable` object

Output data, returned as a `timetable` object. For information about `timetable`, see “Timetables”.

info — Information about read data

structure array

Information about read data, returned as a structure. The structure has one field, `FileName`, which is a fully resolved path containing the path string, the name of the file, and the file extension.

Examples

Inspect and Analyze Data in Simulation Datastore

This example shows how to log big data from a simulation and inspect and analyze portions of that data by interacting with a `matlab.io.datastore.SimulationDatastore` object.

Log Big Data from Model

Open the example model `sldemo_fuelsys`.

```
open_system('sldemo_fuelsys')
```

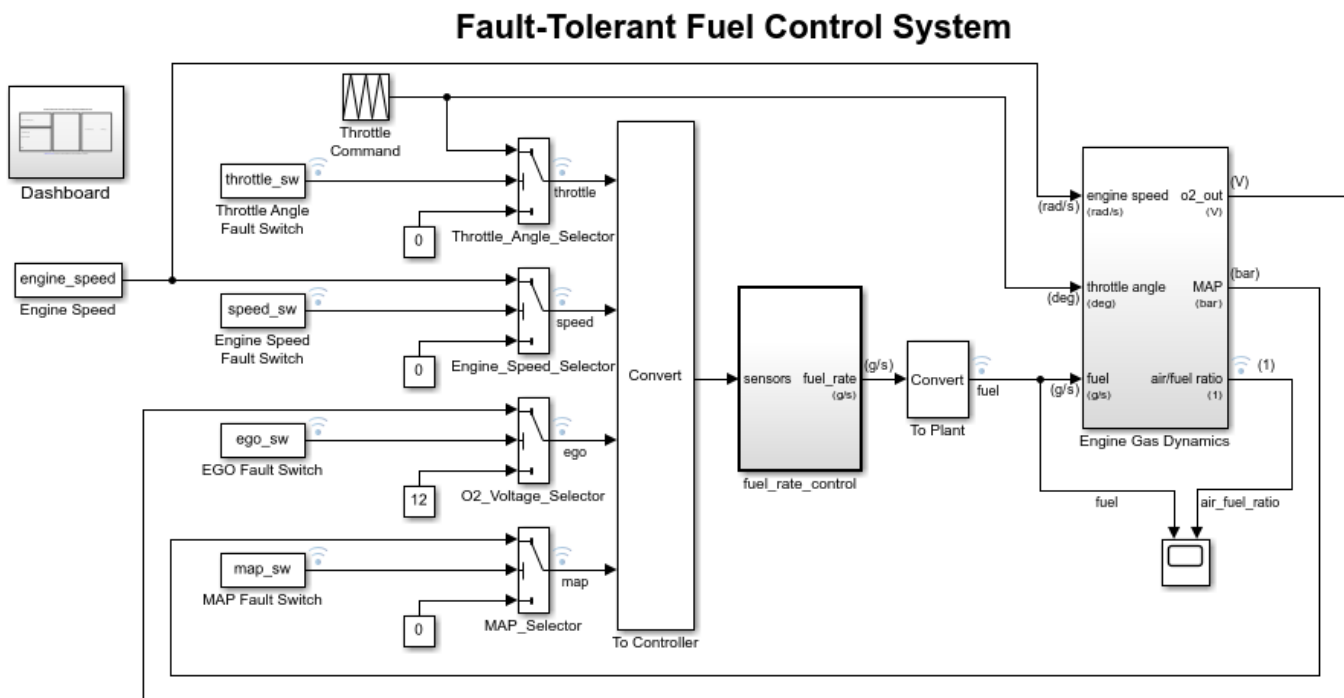

[Open the Dashboard](#) subsystem to simulate any combination of sensor failures.

Copyright 1990-2017 The MathWorks, Inc.

Select **Configuration Parameters > Data Import/Export > Log Dataset data to file.**

```
set_param('sldemo_fuelsys', 'LoggingToFile', 'on')
```

Simulate the model.

```
sim('sldemo_fuelsys')
```

The MAT-file `out.mat` appears in your current folder. The file contains data for logged signals such as `fuel` (which is at the root level of the model).

At the command prompt, create a `DatasetRef` object that refers to the logging variable by name, `sldemo_fuelsys_output`.

```
DSRef = Simulink.SimulationData.DatasetRef('out.mat', 'sldemo_fuelsys_output');
```

Preview Big Data

Use curly braces (`{` and `}`) to extract the signal element `fuel`, which is the tenth element in `DSRef`, as a `Simulink.SimulationData.Signal` object that contains a `SimulationDatastore` object.

```
SimDataSig = DSRef{10};
```

To more easily interact with the `SimulationDatastore` object that resides in the `Values` property of the `Signal` object, store a handle in a variable named `DStore`.

```
DStore = SimDataSig.Values;
```

Use the `preview` method to inspect the first five samples of logged data for the `fuel` signal.

```
preview(DStore)
```

```
ans =
```

```
10x1 timetable
```

| Time | Data |
|----------------|--------|
| 0 sec | 1.209 |
| 0.00056199 sec | 1.209 |
| 0.0033719 sec | 1.209 |
| 0.01 sec | 1.1729 |
| 0.02 sec | 1.1409 |
| 0.03 sec | 1.1124 |
| 0.04 sec | 1.0873 |
| 0.05 sec | 1.0652 |
| 0.055328 sec | 1.0652 |
| 0.055328 sec | 1.0652 |

Inspect Specific Sample

Inspect the 603rd sample of logged `fuel` data.

Set the `ReadSize` property of `DStore` to a number that, considering memory resources, your computer can tolerate. For example, set `ReadSize` to 200.

```
DStore.ReadSize = 200;
```

Read from the datastore three times. Each read operation advances the reading position by 200 samples.

```
read(DStore);
read(DStore);
read(DStore);
```

Now that you are very close to the 603rd sample, set `ReadSize` to a smaller number. For example, set `ReadSize` to 5.

```
DStore.ReadSize = 5;
```

Read from the datastore again.

```
read(DStore)
```

```
ans =
```

```
5x1 timetable
```

| Time | Data |
|----------|--------|
| 5.79 sec | 1.6097 |
| 5.8 sec | 1.6136 |
| 5.81 sec | 1.6003 |
| 5.82 sec | 1.5904 |
| 5.83 sec | 1.5832 |

The third sample of read data is the 603rd sample in the datastore.

Inspect Earlier Sample

Inspect the 403rd sample of logged `fuel` data. Due to previous read operations, the datastore now reads starting from the 606th sample, so you must reset the datastore. Then, you can read from the first sample up to the 403rd sample.

Use the `reset` method to reset `DStore`.

```
reset(DStore);
```

Set `ReadSize` to 200 again.

```
DStore.ReadSize = 200;
```

Read from the datastore twice to advance the read position to the 401st sample.

```
read(DStore);  
read(DStore);
```

Set `ReadSize` to 5 again.

```
DStore.ReadSize = 5;
```

Read from the datastore.

```
read(DStore)
```

```
ans =
```

```
5x1 timetable
```

| Time | Data |
|----------|---------|
| 3.85 sec | 0.999 |
| 3.86 sec | 0.99219 |
| 3.87 sec | 0.98538 |
| 3.88 sec | 0.97858 |

3.89 sec 0.97179

Extract Multiple Samples

Extract samples 1001 through 1020 (a total of 20 samples).

Reset the datastore.

```
reset(DStore)
```

Advance to sample 1001.

```
DStore.ReadSize = 200;
```

```
for i = 1:5
    read(DStore);
end
```

Prepare to extract 20 samples from the datastore.

```
DStore.ReadSize = 20;
```

Extract samples 1001 through 1020. Store the extracted data in a variable named `targetSamples`.

```
targetSamples = read(DStore)
```

```
targetSamples =
```

```
20x1 timetable
```

| Time | Data |
|----------|--------|
| 9.7 sec | 1.5828 |
| 9.71 sec | 1.5733 |
| 9.72 sec | 1.5664 |
| 9.73 sec | 1.5614 |
| 9.74 sec | 1.5579 |
| 9.75 sec | 1.5553 |
| 9.76 sec | 1.5703 |
| 9.77 sec | 1.582 |
| 9.78 sec | 1.5913 |
| 9.79 sec | 1.5988 |
| 9.8 sec | 1.605 |
| 9.81 sec | 1.6101 |
| 9.82 sec | 1.6145 |
| 9.83 sec | 1.6184 |
| 9.84 sec | 1.6049 |
| 9.85 sec | 1.595 |
| 9.86 sec | 1.5877 |
| 9.87 sec | 1.5824 |
| 9.88 sec | 1.5785 |
| 9.89 sec | 1.5757 |

Find Maximum Value of Data in Datastore

Reset the datastore.

```
reset(DStore)
```

Write a while loop, using the `hasdata` method, to incrementally analyze the data in chunks of 200 samples.

```
DStore.ReadSize = 200;
runningMax = [];
while hasdata(DStore)
    tt = read(DStore);
    rawChunk = tt.Data;
    runningMax = max([rawChunk; runningMax]);
end
```

Now, the variable `runningMax` stores the maximum value in the entire datastore.

```
runningMax
```

```
runningMax =
```

```
    1.6423
```

See Also

Topics

“Work with Big Data for Simulations”

Introduced in R2017a

readall

Class: `matlab.io.datastore.SimulationDatastore`

Package: `matlab.io.datastore`

Read all data in datastore

Syntax

```
data = readall(dst)
```

Description

`data = readall(dst)` returns all the data in the datastore (`matlab.io.datastore.SimulationDatastore` object) specified by `dst`.

If all the data in the datastore does not fit in memory, `readall` returns an error. To determine how many samples (time steps) a datastore holds, inspect the `NumSamples` property of the `SimulationDatastore` object.

Input Arguments

dst — Input datastore

`matlab.io.datastore.SimulationDatastore` object

Input datastore, specified as a `matlab.io.datastore.SimulationDatastore` object. To create a `SimulationDatastore` object, see `matlab.io.datastore.SimulationDatastore`.

Output Arguments

data — All data in the datastore

`timetable` object

All data in the datastore, returned as a `timetable` object. For information about `timetable`, see “Timetables”.

See Also

Topics

“Work with Big Data for Simulations”

Introduced in R2017a

reset

Class: `matlab.io.datastore.SimulationDatastore`

Package: `matlab.io.datastore`

Reset datastore to initial state

Syntax

```
reset(dst)
```

Description

`reset(dst)` sets the read position of the datastore (`matlab.io.datastore.SimulationDatastore` object) specified by `dst` to the first sample in the datastore. Use `reset` to reread data from a datastore. You read from a datastore by using the `read` method.

Input Arguments

dst — Input datastore

`matlab.io.datastore.SimulationDatastore` object

Input datastore, specified as a `matlab.io.datastore.SimulationDatastore` object. To create a `SimulationDatastore` object, see `matlab.io.datastore.SimulationDatastore`.

Examples

Inspect and Analyze Data in Simulation Datastore

This example shows how to log big data from a simulation and inspect and analyze portions of that data by interacting with a `matlab.io.datastore.SimulationDatastore` object.

Log Big Data from Model

Open the example model `sldemo_fuelsys`.

```
open_system('sldemo_fuelsys')
```

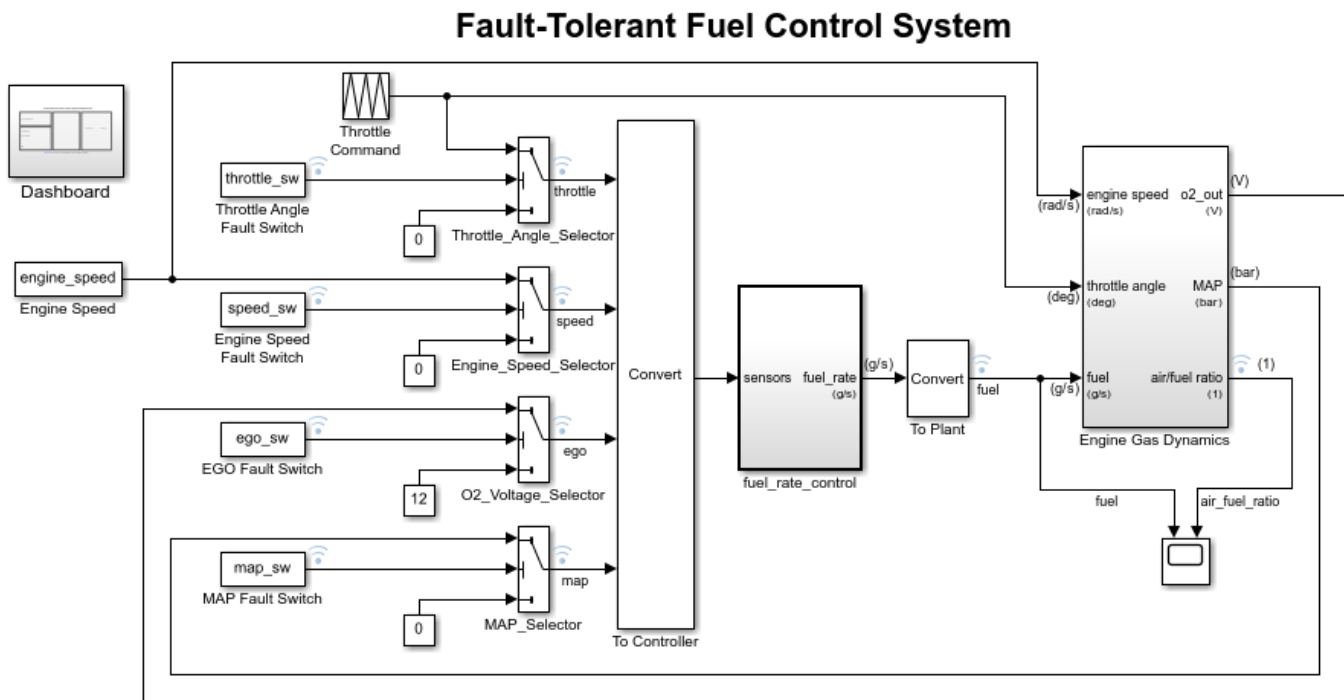

[Open the Dashboard](#) subsystem to simulate any combination of sensor failures.

Copyright 1990-2017 The MathWorks, Inc.

Select **Configuration Parameters > Data Import/Export > Log Dataset data to file.**

```
set_param('sldemo_fuelsys', 'LoggingToFile', 'on')
```

Simulate the model.

```
sim('sldemo_fuelsys')
```

The MAT-file `out.mat` appears in your current folder. The file contains data for logged signals such as `fuel` (which is at the root level of the model).

At the command prompt, create a `DatasetRef` object that refers to the logging variable by name, `sldemo_fuelsys_output`.

```
DSRef = Simulink.SimulationData.DatasetRef('out.mat', 'sldemo_fuelsys_output');
```

Preview Big Data

Use curly braces (`{` and `}`) to extract the signal element `fuel`, which is the tenth element in `DSRef`, as a `Simulink.SimulationData.Signal` object that contains a `SimulationDatastore` object.

```
SimDataSig = DSRef{10};
```

To more easily interact with the `SimulationDatastore` object that resides in the `Values` property of the `Signal` object, store a handle in a variable named `DStore`.

```
DStore = SimDataSig.Values;
```

Use the `preview` method to inspect the first five samples of logged data for the `fuel` signal.

```
preview(DStore)
```

```
ans =
```

```
10x1 timetable
```

| Time | Data |
|----------------|--------|
| 0 sec | 1.209 |
| 0.00056199 sec | 1.209 |
| 0.0033719 sec | 1.209 |
| 0.01 sec | 1.1729 |
| 0.02 sec | 1.1409 |
| 0.03 sec | 1.1124 |
| 0.04 sec | 1.0873 |
| 0.05 sec | 1.0652 |
| 0.055328 sec | 1.0652 |
| 0.055328 sec | 1.0652 |

Inspect Specific Sample

Inspect the 603rd sample of logged fuel data.

Set the `ReadSize` property of `DStore` to a number that, considering memory resources, your computer can tolerate. For example, set `ReadSize` to 200.

```
DStore.ReadSize = 200;
```

Read from the datastore three times. Each read operation advances the reading position by 200 samples.

```
read(DStore);
read(DStore);
read(DStore);
```

Now that you are very close to the 603rd sample, set `ReadSize` to a smaller number. For example, set `ReadSize` to 5.

```
DStore.ReadSize = 5;
```

Read from the datastore again.

```
read(DStore)
```

```
ans =
```

```
5x1 timetable
```

| Time | Data |
|----------|--------|
| 5.79 sec | 1.6097 |
| 5.8 sec | 1.6136 |
| 5.81 sec | 1.6003 |
| 5.82 sec | 1.5904 |

```
5.83 sec    1.5832
```

The third sample of read data is the 603rd sample in the datastore.

Inspect Earlier Sample

Inspect the 403rd sample of logged fuel data. Due to previous read operations, the datastore now reads starting from the 606th sample, so you must reset the datastore. Then, you can read from the first sample up to the 403rd sample.

Use the `reset` method to reset `DStore`.

```
reset(DStore);
```

Set `ReadSize` to 200 again.

```
DStore.ReadSize = 200;
```

Read from the datastore twice to advance the read position to the 401st sample.

```
read(DStore);
read(DStore);
```

Set `ReadSize` to 5 again.

```
DStore.ReadSize = 5;
```

Read from the datastore.

```
read(DStore)
```

```
ans =
```

```
5x1 timetable
```

| Time | Data |
|----------|---------|
| 3.85 sec | 0.999 |
| 3.86 sec | 0.99219 |
| 3.87 sec | 0.98538 |
| 3.88 sec | 0.97858 |
| 3.89 sec | 0.97179 |

Extract Multiple Samples

Extract samples 1001 through 1020 (a total of 20 samples).

Reset the datastore.

```
reset(DStore)
```

Advance to sample 1001.

```
DStore.ReadSize = 200;
```

```
for i = 1:5
    read(DStore);
end
```

Prepare to extract 20 samples from the datastore.

```
DStore.ReadSize = 20;
```

Extract samples 1001 through 1020. Store the extracted data in a variable named `targetSamples`.

```
targetSamples = read(DStore)
```

```
targetSamples =
```

```
20x1 timetable
```

| Time | Data |
|----------|--------|
| 9.7 sec | 1.5828 |
| 9.71 sec | 1.5733 |
| 9.72 sec | 1.5664 |
| 9.73 sec | 1.5614 |
| 9.74 sec | 1.5579 |
| 9.75 sec | 1.5553 |
| 9.76 sec | 1.5703 |
| 9.77 sec | 1.582 |
| 9.78 sec | 1.5913 |
| 9.79 sec | 1.5988 |
| 9.8 sec | 1.605 |
| 9.81 sec | 1.6101 |
| 9.82 sec | 1.6145 |
| 9.83 sec | 1.6184 |
| 9.84 sec | 1.6049 |
| 9.85 sec | 1.595 |
| 9.86 sec | 1.5877 |
| 9.87 sec | 1.5824 |
| 9.88 sec | 1.5785 |
| 9.89 sec | 1.5757 |

Find Maximum Value of Data in Datastore

Reset the datastore.

```
reset(DStore)
```

Write a `while` loop, using the `hasdata` method, to incrementally analyze the data in chunks of 200 samples.

```
DStore.ReadSize = 200;
runningMax = [];
while hasdata(DStore)
    tt = read(DStore);
    rawChunk = tt.Data;
    runningMax = max([rawChunk; runningMax]);
end
```

Now, the variable `runningMax` stores the maximum value in the entire datastore.

```
runningMax
```

```
runningMax =
```

```
    1.6423
```

See Also

Topics

“Work with Big Data for Simulations”

Introduced in R2017a

eventData

Provide information about block method execution events

Description

Simulink software creates an instance of this class when a block method execution event occurs during simulation and passes it to any listeners registered for the event (see `add_exec_event_listener`). The instance specifies the type of event that occurred and the block whose method execution triggered the event. See “Access Block Data During Simulation” for more information.

Parent

None

Children

None

Property Summary

| Name | Description |
|------------------------|---|
| “Type” on page 5-100 | Type of method execution event that occurred. |
| “Source” on page 5-101 | Block that triggered the event. |

Properties

Type

Description

Type of method execution event that occurred. Possible values are:

| event | Occurs... |
|--------------------|---|
| 'PreOutputs ' | Before a block's Outputs method executes. |
| 'PostOutputs ' | After a block's Outputs method executes. |
| 'PreUpdate ' | Before a block's Update method executes. |
| 'PostUpdate ' | After a block's Update method executes. |
| 'PreDerivatives ' | Before a block's Derivatives method executes. |
| 'PostDerivatives ' | After a block's Derivatives method executes. |

Data Type

character vector

Access

R0

Source**Description**

Block that triggered the event

Data Type

Simulink.RunTimeBlock

Access

R0

Introduced in R2009b

allowModelReferenceDiscreteSampleTimeInheritanceImpl

Model reference sample time inheritance status for discrete sample times

Syntax

```
flag = allowModelReferenceDiscreteSampleTimeInheritanceImpl(obj)
```

Description

`flag = allowModelReferenceDiscreteSampleTimeInheritanceImpl(obj)` specifies whether a System object in a referenced model is allowed to inherit the sample time of the parent model. Use this method only for System objects that use discrete sample time and are intended for inclusion in Simulink via the MATLAB System block.

Run-Time Details

During model compilation, Simulink sets the referenced model sample time inheritance before the System object `setupImpl` method is called.

Method Authoring Tips

You must set `Access = protected` for this method.

Input Arguments

obj — System object

System object

System object handle used to access properties, states, and methods specific to the object. If your `allowModelReferenceDiscreteSampleTimeInheritanceImpl` method does not use the object, you can replace this input with `~`.

Output Arguments

flag — discrete sample time inheritance flag

true | false

Flag indicating whether model reference discrete sample time inheritance is allowed for the MATLAB System block containing the System object, returned as a logical value.

The default value for this argument depends on the number of inputs to the System object. If you want to use the default value, you do not need to include this method in your System object class definition file.

| Number of System object Inputs | Default Value and Override Effects |
|--------------------------------|---|
| No inputs | <p>Default: <code>false</code> — Model reference discrete sample time inheritance is not allowed.</p> <p>If your System object uses discrete sample time in its algorithm, override the default by returning <code>true</code> from <code>allowModelReferenceDiscreteSampleTimeInheritanceImpl</code>.</p> |
| One or more inputs | <p>Default: <code>true</code> — If no other Simulink constraint prevents it, model reference sample time inheritance is allowed.</p> |

Examples

Set Sample Time Inheritance for System Object

For a System object that has one or more inputs, to disallow model reference discrete sample time inheritance for that object, set the sample time inheritance to `false`. Include this code in your class definition file for the object.

```
methods (Access = protected)
    function flag = allowModelReferenceDiscreteSampleTimeInheritanceImpl(~)
        flag = false;
    end
end
```

See Also

`matlab.System`

Topics

“Set Model Reference Discrete Sample Time Inheritance”

“Model Reference Basics”

“Referenced Model Sample Times”

Introduced in R2016a

getInputNamesImpl

Names of MATLAB System block input ports

Syntax

```
names = getInputNamesImpl(obj)
```

Description

`names = getInputNamesImpl(obj)` specifies the names of the input ports from System object, `obj` implemented in a MATLAB System block. The size of `names` matches the number of inputs returned by the `getNumInputs` method. If you change a property value that changes the number of inputs, the names of those inputs also change.

Class Information

This method is part of the `matlab.System` class.

Run-Time Details

`getInputNamesImpl` is called by the MATLAB System block.

Method Authoring Tips

You must set `Access = protected` for this method.

Input Arguments

obj — System object

System object

System object handle used to access properties, states, and methods specific to the object. If your `getInputNamesImpl` method does not use the object, you can replace this input with `~`.

Output Arguments

names — Names of inputs

empty string array (default) | string array

Names of the inputs for the specified object, returned as a string array whose length equals the number of inputs.

Examples

“Customize MATLAB System Block Appearance”

See Also

`getNumInputsImpl` | `getOutputNamesImpl`

Topics

“Specify Input and Output Names”

“Customize MATLAB System Block Appearance”

Introduced in R2013b

getOutputNamesImpl

Names of MATLAB System block output ports

Syntax

```
names = getOutputNamesImpl(obj)
```

Description

`names = getOutputNamesImpl(obj)` specifies the names of the output ports from System object, `obj` implemented in a MATLAB System block. The size of `names` matches the number of outputs returned by the `getNumOutputs` method. If you change a property value that affects the number of outputs, the names of those outputs also change.

Class Information

This method is part of the `matlab.System` class.

Run-Time Details

`getOutputNamesImpl` is called by the MATLAB System block.

Method Authoring Tips

You must set `Access = protected` for this method.

Input Arguments

obj — System object

System object

System object handle used to access properties, states, and methods specific to the object. If your `getOutputNamesImpl` method does not use the object, you can replace this input with `~`.

Output Arguments

names — Names of outputs

empty string array (default) | string array

Names of the outputs for the specified object, returned as a string array whose length equals the number of outputs.

Examples

“Customize MATLAB System Block Appearance”

See Also

`getNumOutputsImpl` | `getInputNamesImpl`

Topics

“Specify Input and Output Names”

Introduced in R2013b

getPropertyGroupsImpl

Property groups for System object display

Syntax

```
group = getPropertyGroupsImpl
```

Description

`group = getPropertyGroupsImpl` specifies how to display properties in the block dialog of a MATLAB System block. You can specify:

- Sections — Arrange properties into sections (panel on the MATLAB System block dialog) with `matlab.system.display.Section`.
- Section Groups — Arrange properties and sections into groups (tabs on the MATLAB System block dialog) with `matlab.system.display.SectionGroup`.
- Order of properties — Specify the order of properties within sections/groups
- Order of sections — Specify the order of sections within groups.

If you create a section, but that section is not in a section group, its properties appear above the block dialog tab panels.

Run-Time Details

In Simulink, `getPropertyGroupsImpl` modifies the MATLAB System block dialog.

In MATLAB, `getPropertyGroupsImpl` modifies how properties appear when the System object is displayed at the MATLAB command line. `getPropertyGroupsImpl` defines the order and groupings of properties. If your `getPropertyGroupsImpl` defines multiple section groups, only properties from the first section group are displayed at the command line. To display properties in other sections, a link is provided at the end of a System object property display. Group titles are also displayed at the command line.

Method Authoring Tips

- You must set `Access = protected` for this method.
- If you include a `getPropertyGroupsImpl` method but do not list all properties, the excluded properties do not appear in the dialog box.
- To omit the `Main` title for the first group of properties, in `matlab.system.display.SectionGroup`, set `TitleSource` to `'Auto'`.
- By default if you do not customize this method in your System object, the MATLAB System block dialog displays all public properties in the order specified in the System object class file.
- To customize property names, add comments above each property. For an example, see “System Object to Block Dialog Box Default Mapping”.

Output Arguments

group — Property sections and groups

array of `SectionGroup` or `Section` objects

Property groups and sections to pass to the MATLAB System block, specified as an array of `matlab.system.display.Section` and `matlab.system.display.SectionGroup` objects.

Examples

“Customize System Block Dialog Box”

See Also

`matlab.system.display.Header` | `matlab.system.display.Section` |
`matlab.system.display.SectionGroup`

Topics

“Customize System Block Dialog Box”

“Mapping System Object Code to MATLAB System Block Dialog Box”

Introduced in R2013b

getSimulateUsingImpl

Specify value for Simulate using parameter

Syntax

```
simmode = getSimulateUsingImpl
```

Description

`simmode = getSimulateUsingImpl` specifies the simulation mode of the System object implemented in a MATLAB System block. The simulation mode restricts your System object to simulation using either code generation or interpreted execution. The associated `showSimulateUsingImpl` method controls whether the **Simulate using** option is displayed on the dialog box.

Run-Time Details

`getSimulateUsingImpl` is called by the MATLAB System block.

Method Authoring Tips

You must set `Access = protected` and `Static` for this method.

Output Arguments

simmode — Simulation mode

"Code generation" | "Interpreted execution"

Simulation mode, returned as the string "Code generation" or "Interpreted execution". If you do not include the `getSimulateUsingImpl` method in your class definition file, the simulation mode is unrestricted. Depending on the value returned by the associated `showSimulateUsingImpl` method, the simulation mode is displayed on the dialog box as either a dropdown list or not at all.

Examples

Specify the Simulation Mode

In the class definition file of your System object, define the simulation mode to display in the MATLAB System block. To prevent **Simulate using** from displaying, see `showSimulateUsingImpl`.

```
methods (Static, Access = protected)
    function simMode = getSimulateUsingImpl
        simMode = "Interpreted execution";
    end
end
```

See Also

`showSimulateUsingImpl`

Topics

“Control Simulation Type in MATLAB System Block”

Introduced in R2015a

getSimulinkFunctionNamesImpl

Register Simulink function names used in your System object

Syntax

```
names = getSimulinkFunctionNamesImpl(obj)
```

Description

`names = getSimulinkFunctionNamesImpl(obj)` specifies the Simulink function names used in the System object `obj`.

If you use a Simulink function in your System object, you can only call a Simulink function from the `stepImpl`, `updateImpl`, or `outputImpl` method.

Run-Time Details

`getSimulinkFunctionNamesImpl` is invoked by the MATLAB System during model compilation to obtain the list of Simulink functions being called from the System object. Simulink uses this information to resolve the function names to a Simulink function declared in a Simulink Function block. If `getSimulinkFunctionNamesImpl` does not return the name of a function being called in the System object methods, Simulink attempts to resolve the function to a function on the MATLAB path.

Method Authoring Tips

You must set `Access = protected` for this method.

Input Arguments

obj — System object

System object

System object handle used to access properties, states, and methods specific to the object. If your `getSimulinkFunctionNamesImpl` method does not use the object, you can replace this input with `~`.

Output Arguments

names — Simulink function names

{ ' ' } (default) | cell array of character vectors | string array

The names of the Simulink function you want to call from your System object.

Examples

“Call Simulink Functions from a MATLAB System Block”

See Also

Classes

matlab.System

Blocks

Simulink Function | MATLAB System

Topics

“Simulink Functions Overview”

“Call Simulink Functions from MATLAB System Block”

Introduced in R2019a

getInterfaceImpl

Set System object as message or data

Syntax

```
interface = getInterfaceImpl(obj)
```

Description

MATLAB `interface = getInterfaceImpl(obj)` specifies the inputs and outputs of a System block as either data or a message.

Run-Time Details

`getInterfaceImpl` is part of the `matlab.System` class and is called before the `setupImpl` method.

Method Authoring Tips

You must set `Access = protected` for this method.

You cannot modify any properties in this method.

Input Arguments

obj — System object

System object

System object handle used to access properties, states, and methods specific to the object. If your `getInterfaceImpl` method does not use the object, you can replace this input with `~`.

Output Arguments

interface — MATLAB System block interface

scalar of interface objects | vector of interface objects

MATLAB System block interface, returned as a scalar or vector of `matlab.system.interface.*` objects. Use `matlab.system.interface.Input(signalName,signalType)` to define input signal types. Use `matlab.system.interface.Output(signalName,signalType)` to define output signal types.

- `signalName` - Defines the name of the port. Represented by a character array.
- `signalType` - Defines the type of port. The value is either `matlab.system.interface.Data` or `matlab.system.interface.Message`.

Examples

Process Message Payload Using MATLAB System Block

This example shows how to send, receive, and process messages using the MATLAB System block. Use System objects to author blocks to model custom behavior to send and receive messages and manipulate the message payload.

Load and Open the Model

Open the model of the Message Send and Receive system. This model contains a random number generator as a data source. Based on that data, the Message Sender sends a message with a sine wave payload to a queue block. The queue block stores the messages, and the Message Receiver converts the message back to data.

```
open_system('slexMessageArrivalExample');
```

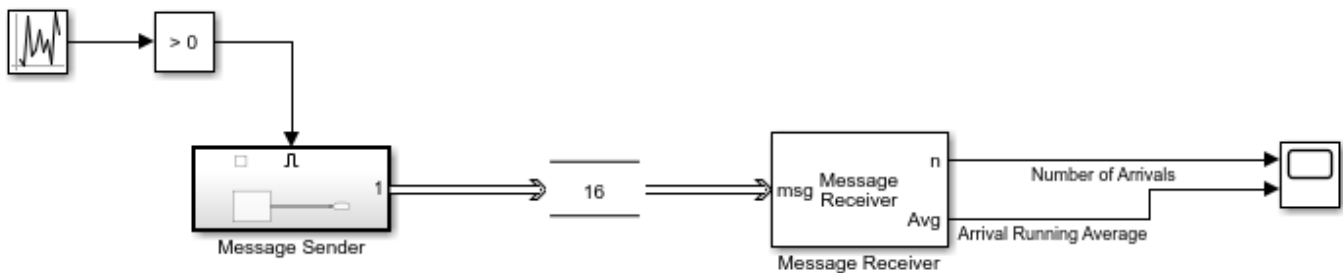

Use getInterfaceImpl System Object API to Specify Message Ports

`getInterfaceImpl` is used in this example to specify the input and output message ports in the MATLAB System block for both the Message Sender and the Message Receiver. For the Message Sender, `getInterfaceImpl` is used to define the output of the MATLAB System block as a message. This action prompts the System object to create a message output. For the Message Receiver, `getInterfaceImpl` is used to define the input of the System object as a message and the output as data.

```
%Function to send messages
function interface = getInterfaceImpl(~)
    import matlab.system.interface.*;
    interface = Output("Out1", Message);
end

%Function to receive messages and output as data
function interface = getInterfaceImpl(obj)
    import matlab.system.interface.*;
    interface = [Input("In1", Message), ...
                Output("Out1", Data), Output("out2", Data)];
end
```

Set the Propagators and Sample time

The following four propagators need to be set in the Message Sender: `getOutputSizeImpl`, `getOutputDataTypeImpl`, `isOutputComplexImpl`, `isOutputFixedSizeImpl`.

In this example, the message queue has a maximum capacity of 16 messages. The random number generator has a sample time of 0.1. The receiver has a sample time of 1. The Message Receiver sample time is set in the MATLAB System block using the `getSampleTimeImpl` API.

```
function sts = getSampleTimeImpl(obj)
    sts = createSampleTime(obj, 'Type', 'Discrete', ...
        'SampleTime', obj.SampleTime);
end
```

Simulate the Model and Review Results

The Scope block displays the results. These results show that as you run more simulations, the random number generator produces a number greater than zero 50% of the time, as expected.

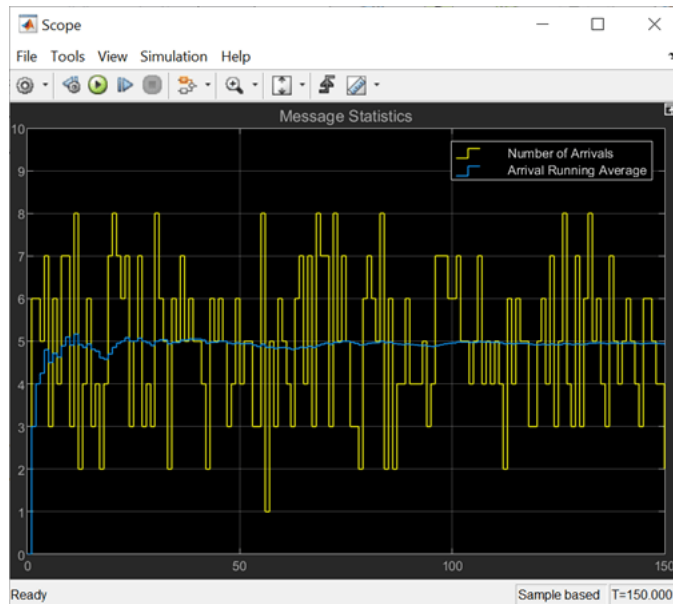

See Also

Classes

matlab.System

Blocks

MATLAB System

Topics

"Messages"

Introduced in R2021a

showFiSettingsImpl

Fixed point data type tab visibility for System objects

Syntax

```
flag = showFiSettingsImpl
```

Description

`flag = showFiSettingsImpl` specifies whether the Data Types tab appears on the MATLAB System block dialog box. The Data Types tab includes parameters to control processing of fixed point data the MATLAB System block. You cannot specify which parameters appear on the tab. If you implement `showFiSettingsImpl`, the simulation mode is set to code generation.

The parameters that appear on the Data Types tab, which cannot be customized, are:

- **Saturate on integer overflow** — a check box to control the action to take on integer overflow for built-in integer types. The default is that the box is checked, which indicates to saturate. This is also the default for when **Same as MATLAB** is selected as the **MATLAB System fimath** option.
- **Treat these inherited Simulink signal types as fi objects** — a pull down that indicates which inherited data types to treat as fi data types. Valid options are:
 - Fixed point (default)
 - Fixed point & integer
- **MATLAB System fimath** has two radio button options:
 - **Same as MATLAB** (default) — uses the current MATLAB fixed-point math settings.
 - **Specify Other** — enables the edit box for specifying the desired fixed-point math settings.

For information on setting fixed-point math, see `fimath`.

Run-Time Details

`showFiSettingsImpl` is called by the MATLAB System block. For more information, see “Simulink Engine Phases Mapped to System Object Methods”.

Method Authoring Tips

- If you do not want to display the tab, you do not need to implement this method in your class definition file.
- You must set `Access = protected` for this method.

Output Arguments

flag — Display Data Types tab

false (default) | true

Flag indicating whether to display the Data Types tab on the MATLAB System block mask, returned as a logical scalar value. Returning a `true` value displays the tab. A `false` value does not display the tab.

Examples

Show the Data Types Tab

Show the Data Types tab on the MATLAB System block dialog box.

```
methods (Static, Access = protected)
    function isVisible = showFiSettingsImpl
        isVisible = true;
    end
end
```

If you set the flag, `isVisible`, to `true`, the tab appears as follows when you add the object to Simulink with the MATLAB System block.

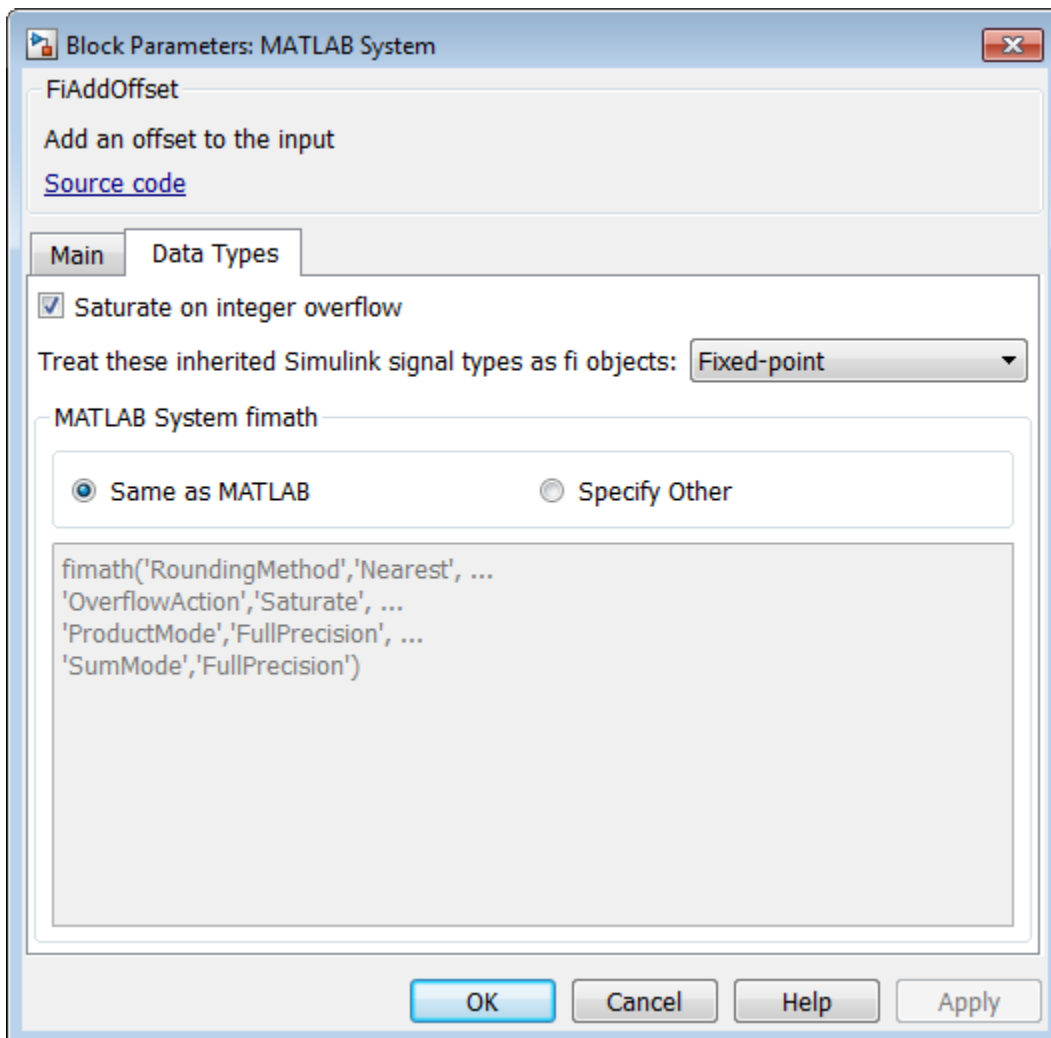

See Also

Topics

“Customize System Block Dialog Box”

Introduced in R2016a

showSimulateUsingImpl

Visibility of Simulate using parameter

Syntax

```
flag = showSimulateUsingImpl
```

Description

`flag = showSimulateUsingImpl` specifies whether **Simulate using** appears on the MATLAB System block dialog box.

Run-Time Details

`showSimulateUsingImpl` is called by the MATLAB System block.

Method Authoring Tips

You must set `Access = protected` and `Static` for this method.

Output Arguments

flag — Display parameter on block dialog box

`true` (default) | `false`

Flag indicating whether to display the **Simulate using** parameter and dropdown list on the MATLAB System block mask. `true` displays the parameter and dropdown list. `false` hides the parameter and dropdown list.

Examples

Hide the Simulate using Parameter

Hide the **Simulate using** parameter on the MATLAB System block dialog box.

```
methods (Static, Access = protected)
    function flag = showSimulateUsingImpl
        flag = false;
    end
end
```

If you set the `flag` to `true` or omit the `showSimulateUsingImpl` method, which defaults to `true`, the dialog appears as follows when you add the object to Simulink with the MATLAB System block.

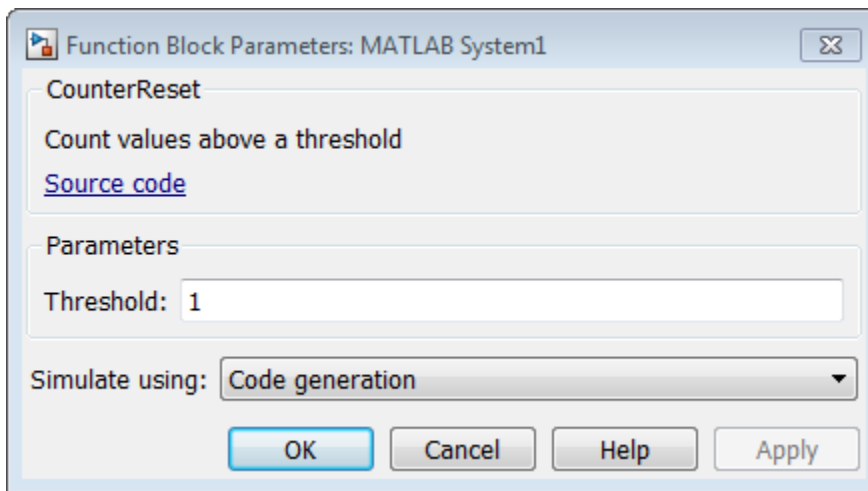

If you also specify a single value for `getSimulateUsingImpl`, the dialog appears as follows when you add the object to Simulink with the MATLAB System block.

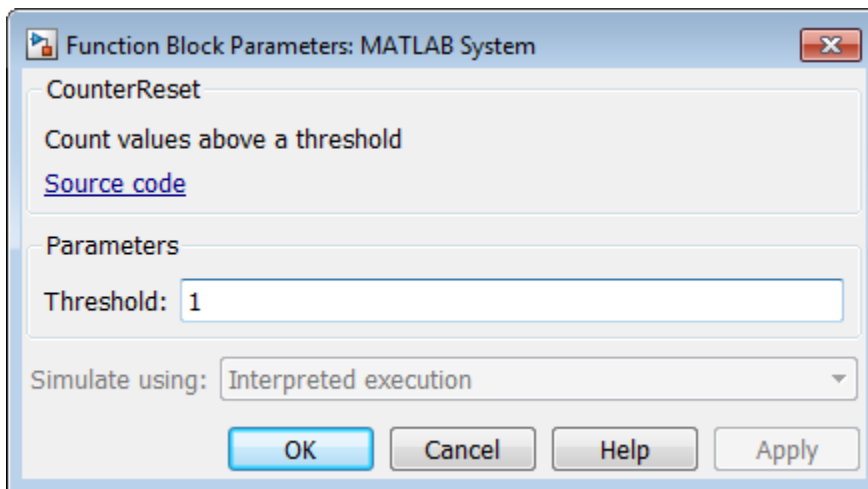

See Also

`getSimulateUsingImpl`

Topics

“Control Simulation Type in MATLAB System Block”

Introduced in R2015a

getGlobalNamesImpl

Global variable names for MATLAB System block

Syntax

```
name = getGlobalNamesImpl(obj)
```

Description

`name = getGlobalNamesImpl(obj)` specifies the names of global variables that are declared in a System object for use in a Simulink P-code file. For P-code files, in addition to declaring your global variables in `stepImpl`, `outputImpl`, or `updateImpl`, you must include the `getGlobalNamesImpl` method. You declare global variables in a cell array in the `getGlobalNamesImpl` method. System objects that contain these global variables are included in Simulink using a MATLAB System block. To enable a global variable in Simulink, your model also must include a Data Store Memory block with a **Data Store Name** that matches the global variable name.

Run-Time Details

`getGlobalNamesImpl` is called by the MATLAB System block.

Method Authoring Tips

You must set `Access = protected` for this method.

Input Arguments

obj — System object

System object

System object handle used to access properties, states, and methods specific to the object. If your `getGlobalNamesImpl` method does not use the object, you can replace this input with `~`.

Output Arguments

name — Global variable names

cell array of character vectors

Cell array containing the global variable names. The elements of the cell array are character vectors.

Examples

Specify Global Names

Specify two global names in your class definition file.

```
methods(Access = protected)
    function glnames = getGlobalNamesImpl(obj)
```

```
    glnames = {'FEE','OTHERFEE'};
end

function y = stepImpl(obj,u)
    global FEE
    global OTHERFEE
    y = u - FEE * obj.lastData + OTHERFEE;
    obj.lastData = u;
end
end
```

See Also

[stepImpl](#) | [updateImpl](#) | [outputImpl](#)

Topics

“System Object Global Variables in Simulink”

Introduced in R2016b

getHeaderImpl

Header for System object display

Syntax

```
header = getHeaderImpl
```

Description

`header = getHeaderImpl` specifies the dialog header to display on the MATLAB System block dialog box. If you do not specify the `getHeaderImpl` method, no title or text appears for the header in the block dialog box.

Run-Time Details

`getHeaderImpl` is called by the MATLAB System block.

Method Authoring Tips

You must set `Access = protected` for this method.

Output Arguments

header — Header text

`matlab.system.display.Header` class

Header text specified as a `matlab.system.display.Header` class.

Examples

Define Header for System Block Dialog Box

Define a header in your class definition file for the `EnhancedCounter` System object.

```
methods (Static, Access = protected)
    function header = getHeaderImpl
        header = matlab.system.display.Header('EnhancedCounter', ...
            'Title', 'Enhanced Counter');
    end
end
```

See Also

`getPropertyGroupsImpl`

Topics

“Add Header Description”

Introduced in R2013b

getDiscreteStateImpl

Discrete state property values

Syntax

```
s = getDiscreteStateImpl(obj)
```

Description

`s = getDiscreteStateImpl(obj)` returns a struct `s` of internal state value properties, which have the `DiscreteState` attribute. The field names of the struct are the object's `DiscreteState` property names. To restrict or change the values returned by `getDiscreteState` method, you can override this `getDiscreteStateImpl` method.

Run-Time Details

`getDiscreteStateImpl` is called by the `setup` method. For details, see

“Detailed Call Sequence”.

Method Authoring Tips

- You must set `Access = protected` for this method.
- You cannot modify any properties in this method.

Input Arguments

obj — System object

System object

System object handle used to access properties, states, and methods specific to the object. If your `getDiscreteStateImpl` method does not use the object, you can replace this input with `~`.

Output Arguments

s — State values

struct

State values, returned as a struct.

Examples

Get Discrete State Values

Use the `getDiscreteStateImpl` method in your class definition file to get the discrete states of the object.

```
methods (Access = protected)
    function s = getDiscreteStateImpl(obj)
```

```
end  
end
```

See Also

setupImpl

Topics

“Define Property Attributes”

Introduced in R2012b

supportsMultipleInstanceImpl

Support System object in Simulink For Each subsystem

Syntax

```
flag = supportsMultipleInstanceImpl(obj)
```

Description

`flag = supportsMultipleInstanceImpl(obj)` specifies whether the System object can be used in a Simulink For Each subsystem via the MATLAB System block. To enable For Each support, you must include the `supportsMultipleInstanceImpl` in your class definition file and have it return `true`. Do not enable For Each support if your System object allocates exclusive resources that may conflict with other System objects, such as allocating file handles, memory by address, or hardware resources.

Run-Time Details

During Simulink model compilation and propagation, the MATLAB System block calls the `supportsMultipleInstance` method, which then calls the `supportsMultipleInstanceImpl` method to determine For Each support.

Method Authoring Tips

- You must set `Access = protected` for this method.
- You cannot modify any properties in this method.

Input Arguments

obj — System object

System object

System object handle used to access properties, states, and methods specific to the object. If your `supportsMultipleInstanceImpl` method does not use the object, you can replace this input with `~`.

Output Arguments

flag — Support for For Each subsystem flag

false (default) | true

Boolean value indicating whether the System object can be used in a For Each subsystem. The default value, if you do not include the `supportsMultipleInstanceImpl` method, is `false`.

Examples

Enable For-Each Support for System Object

Specify in your class definition file that the System object can be used in a Simulink For Each subsystem.

```
methods (Access = protected)
    function flag = supportsMultipleInstanceImpl(obj)
        flag = true;
    end
end
```

See Also

matlab.System

Topics

“Enable For Each Subsystem Support”

Introduced in R2014b

processTunedPropertiesImpl

Action when tunable properties change

Syntax

```
processTunedPropertiesImpl(obj)
```

Description

`processTunedPropertiesImpl(obj)` specifies the algorithm to perform when one or more tunable property values change. This method is called as part of the next call to the System object after a tunable property value changes. A property is tunable only if its `Nontunable` attribute is `false`, which is the default.

Run-Time Details

`processTunedPropertiesImpl` is called when you run the System object.

In MATLAB when multiple tunable properties are changed before running the System object, `processTunedPropertiesImpl` is called only once for all the changes. `isChangedProperty` returns `true` for all the changed properties.

In Simulink, when a parameter is changed in a MATLAB System block dialog, the next simulation step calls `processTunedPropertiesImpl` before calling `stepImpl`. All tunable parameters are considered changed and `processTunedPropertiesImpl` method is called for each of them. `isChangedProperty` returns `true` for all the dialog properties.

For details, see “Detailed Call Sequence”.

Method Authoring Tips

- You must set `Access = protected` for this method.
- Use this method when a tunable property affects the value of a different property.
- If the System object will be used in the Simulink MATLAB System block, you cannot modify any tunable properties in this method.
- To check if a property has changed since `stepImpl` was last called, use `isChangedProperty` within `processTunedPropertiesImpl`. See “Specify Action When Tunable Property Changes” on page 5-130 for an example.

Input Arguments

obj — System object

System object

System object handle used to access properties, states, and methods specific to the object. If your `processTunedPropertiesImpl` method does not use the object, you can replace this input with `~`.

Examples

Specify Action When Tunable Property Changes

Use `processTunedPropertiesImpl` to recalculate the lookup table if the value of either the `NumNotes` or `MiddleC` property changes before the next call to the System object. `propChange` indicates if either property has changed.

```
methods (Access = protected)
function processTunedPropertiesImpl(obj)
    propChange = isChangedProperty(obj, 'NumNotes') || ...
                isChangedProperty(obj, 'MiddleC')
    if propChange
        obj.pLookupTable = obj.MiddleC * (1+log(1:obj.NumNotes)/log(12));
    end
end
end
```

See Also

`validatePropertiesImpl` | `setProperties`

Topics

“Process Tuned Properties”

“Validate Property and Input Values”

“Define Property Attributes”

Introduced in R2013b

matlab.system.mixin.CustomIcon class

Package: matlab.system.mixin

Custom icon mixin class

Note The `matlab.system.mixin.CustomIcon` mixin will be removed in a future release. You no longer need to inherit from this mixin in your `System` object. The associated `getIcon` method has been moved to the `matlab.System` class.

Description

`matlab.system.mixin.CustomIcon` is a class that specifies the `getIcon` method. This method customizes the name of the icon used for the `System` object implemented through a MATLAB System block.

To use this method, you must subclass from this class in addition to the `matlab.System` base class. Type the following syntax as the first line of your class definition file, where `ObjectName` is the name of your object:

```
classdef ObjectName < matlab.system &...  
    matlab.system.mixin.CustomIcon
```

The `matlab.system.mixin.CustomIcon` class is a handle class.

Compatibility Considerations

matlab.system.mixin.CustomIcon will be removed

Not recommended starting in R2020a

The `matlab.system.mixin.CustomIcon` mixin will be removed in a future release. You no longer need to inherit from this mixin in your `System` object. The associated method has been moved to the `matlab.System` class.

Remove `matlab.system.mixin.CustomIcon` from the `classdef` line of your `System` object.

See Also

`matlab.System` | `matlab.system.display.Icon`

Topics

“Add Text to Block Icon”

Introduced in R2017a

getIconImpl

Name to display as block icon

Syntax

```
icon = getIconImpl(obj)
```

Description

`icon = getIconImpl(obj)` specifies the text or image to display on the block icon of the MATLAB System block. If you do not specify the `getIconImpl` method, the block displays the class name of the System object as the block icon. For example, if you specify `pkg.MyObject` in the MATLAB System block, the default icon is labeled `MyObject`.

Run-Time Details

`getIconImpl` is called by the MATLAB System block during Simulink model compilation.

Method Authoring Tips

You must set `Access = protected` for this method.

Input Arguments

obj — System object

System object

System object handle used to access properties, states, and methods specific to the object. If your `getIconImpl` method does not use the object, you can replace this input with `~`.

Output Arguments

icon — Block icon

character vector | cell array of character vectors | string | string array |
`matlab.system.display.Icon` object

The text or image to display as the block icon. Each cell is displayed as a separate line.

Examples

Add System Block Icon Name

Specify in your class definition file the name of the block icon as 'Enhanced Counter' using two lines.

```
methods (Access = protected)
    function icon = getIconImpl(~)
        icon = {'Enhanced', 'Counter'};
```

```
end  
end
```

Add Image to MATLAB System Block

Define an image in your class definition file.

```
methods(Access = protected)  
    function icon = getIconImpl(~)  
        % Define icon for System block  
        icon = matlab.system.display.Icon('my_icon.png');  
    end  
end
```

The image now appears on the System block icon.

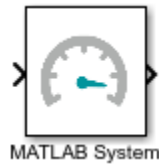

See Also

[matlab.system.mixin.CustomIcon](#) | [matlab.system.display.Icon](#)

Topics

“Customize System Block Appearance”

“Customize MATLAB System Block Appearance”

Introduced in R2017a

matlab.system.display.Header class

Package: matlab.system.display

Header for System objects properties

Syntax

```
matlab.system.display.Header(N1,V1,...Nn,Vn)
matlab.system.display.Header(Obj,...)
```

Description

`matlab.system.display.Header(N1,V1,...Nn,Vn)` specifies a header for the System object, with the header properties defined in Name-Value (N,V) pairs. You use `matlab.system.display.Header` within the `getHeaderImpl` method. The available header properties are

- **Title** — Header title. The default value is an empty character vector.
- **Text** — Header description. The default value is an empty character vector.
- **ShowSourceLink** — Show link to source code for the object.

`matlab.system.display.Header(Obj,...)` creates a header for the specified System object (`Obj`) and sets the following property values:

- **Title** — Set to the `Obj` class name.
- **Text** — Set to help summary for `Obj`.
- **ShowSourceLink** — Set to `true` if `Obj` is MATLAB code. In this case, the **Source Code** link is displayed. If `Obj` is P-coded and the source code is not available, set this property to `false`.

You can use `mfilename('class')` from within this method to get the name of the System object. If you set any Name-Value pairs, those property values override the default settings.

Examples

Define System Block Header

Define a header in your class definition file.

```
methods (Static, Access = protected)
    function header = getHeaderImpl
        header = matlab.system.display.Header(mfilename('class'), ...
            'Title','AlternativeTitle',...
            'Text','An alternative class description');
    end
end
```

The resulting output appears as follows. In this case, **Source code** appears because the `ShowSourceLink` property was set to `true`.

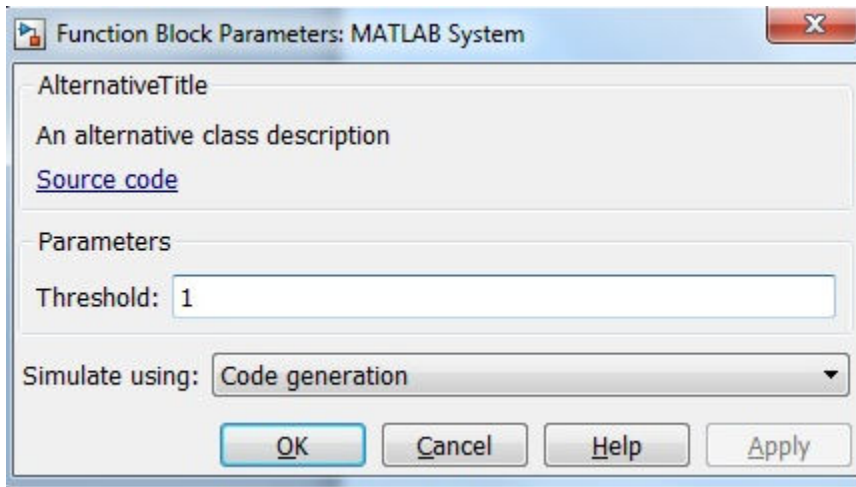

See Also

`getHeaderImpl` | `matlab.system.display.Section` |
`matlab.system.display.SectionGroup`

Topics

"Classes"

"Add Header Description"

matlab.system.display.Section class

Package: matlab.system.display

Property group section for System objects

Syntax

```
matlab.system.display.Section(N1,V1,...Nn,Vn)
matlab.system.display.Section(Obj,...)
```

Description

`matlab.system.display.Section(N1,V1,...Nn,Vn)` creates a property group section for displaying System object properties, which you define using property Name-Value pairs (N,V). You use `matlab.system.display.Section` to define property groups using the `getPropertyGroupsImpl` method. The available Section properties are:

- **Title** — Section title. The default value is an empty character vector.
- **TitleSource** — Source of section title. Valid values are 'Property' and 'Auto'. The default value is 'Property', which uses the character vector from the Title property. If the Obj name is given, the default value is Auto, which uses the Obj name.
- **Description** — Section description. The default value is an empty character vector.
- **PropertyList** — Section property list as a cell array of property names. The default value is an empty array. If the Obj name is given, the default value is all eligible display properties.
- **Type** — Container type. For example, tab, group, panel, and collapsible panel.
- **Row**— Specify the row in which the containers need to be placed (current/new). You can specify the row using the enum class `matlab.system.display.internal.Row`.
- **AlignPrompts**— Specify a boolean value to control align prompts within the containers.

Note Certain properties are not eligible for display either in a dialog box or in the System object summary on the command-line. Property types that cannot be displayed are: hidden, abstract, private or protected access, discrete state, and continuous state. Dependent properties do not display in a dialog box, but do display in the command-line summary.

`matlab.system.display.Section(Obj,...)` creates a property group section for the specified System object (Obj) and sets the following property values:

- **TitleSource** — Set to 'Auto', which uses the Obj name.
- **PropertyList** — Set to all publicly-available properties in the Obj.

You can use `mfilename('class')` from within this method to get the name of the System object. If you set any Name-Value pairs, those property values override the default settings.

Examples

Define Property Groups

Define two property groups in your class definition file by specifying their titles and property lists.

```
classdef MultipleGroupsWithSection < matlab.System
    % MultipleGroupsWithTabs Customize block dialog with multiple tabs and parameter groups.

    % Public, tunable properties
    properties
        %StartValue Start Value
        StartValue = 0

        %EndValue End Value
        EndValue = 10

        Threshold = 1
    end
    % Public Nontunable
    properties(Nontunable)
        %UseThreshold Use threshold
        UseThreshold (1,1) logical = true
    end

    methods (Static, Access = protected)
        function groups = getPropertyGroupsImpl
            valueGroup = matlab.system.display.Section(...
                'Title', 'Value parameters', ...
                'PropertyList', {'StartValue', 'EndValue'}, ...
                'SectionType', matlab.system.display.SectionType.tab);

            thresholdGroup = matlab.system.display.Section(...
                'Title', 'Threshold parameters', ...
                'PropertyList', {'Threshold', 'UseThreshold'}, ...
                'SectionType', matlab.system.display.SectionType.tab);
            groups = [valueGroup, thresholdGroup];
        end
    end
end
```

When you specify the System object in the MATLAB System block, the resulting dialog box appears as follows.

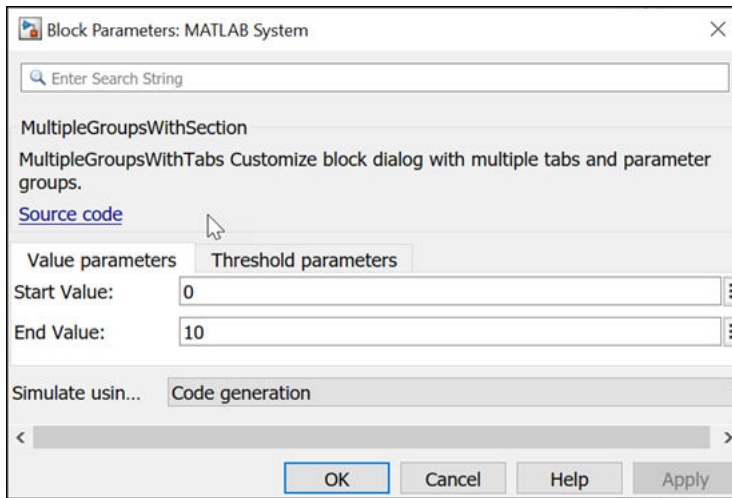

See Also

`matlab.system.display.Header` | `matlab.system.display.SectionGroup` | `getPropertyGroupsImpl`

Topics

“Customize System Block Dialog Box”

matlab.system.display.Action class

Package: matlab.system.display

Custom button

Syntax

```
matlab.system.display.Action(action)
matlab.system.display.Action(action,Name,Value)
```

Description

`matlab.system.display.Action(action)` specifies a button to display on the MATLAB System block. This button executes a function by launching a System object method or invoking any MATLAB function or code.

A typical button function launches a figure. The launched figure is decoupled from the block dialog box. Changes to the block are not synced to the displayed figure.

You define `matlab.system.display.Action` within the `getPropertyGroupsImpl` method in your class definition file. You can define multiple buttons using separate instances of `matlab.system.display.Action` in your class definition file.

`matlab.system.display.Action(action,Name,Value)` includes `Name,Value` pair arguments, which you can use to specify any properties.

Input Arguments

action

Action taken when the user presses the specified button on the MATLAB System block dialog. The action is defined as a function handle or as a MATLAB command. If you define the action as a function handle, the function definition must define two inputs. These inputs are a `matlab.system.display.ActionData` object and a System object instance, which can be used to invoke a method.

A `matlab.system.display.ActionData` object is the callback object for a display action. You use the `UserData` property of `matlab.system.display.ActionData` to store persistent data, such as a figure handle.

Name-Value Pair Arguments

Specify optional comma-separated pairs of `Name,Value` arguments. `Name` is the argument name and `Value` is the corresponding value. `Name` must appear inside quotes. You can specify several name and value pair arguments in any order as `Name1,Value1,...,NameN,ValueN`.

Properties

You specify these properties as part of the input using `Name,Value` pair arguments. Optionally, you can define them using `object.property` syntax.

- **ActionCalledFcn** — Action to take when the button is pressed. You cannot specify this property using a Name-Value pair argument.
- **Label** — Text to display on the button. The default value is an empty character vector.
- **Description** — Text for the button tooltip. The default value is an empty character vector.
- **Placement** — Character vector indicating where on a separate row in the property group to place the button. Valid values are 'first', 'last', or a property name. If you specify a property name, the button is placed above that property. The default value is 'last'.
- **Alignment** — Character vector indicating how to align the button. Valid values are 'left' and 'right'. The default value is 'left'.

Examples

Define Button on MATLAB System Block

Define a **Visualize** button and its associated function to open a figure that plots a ramp using the parameter values in the block dialog.

```
methods(Static,Access = protected)
    function group = getPropertyGroupsImpl
        group = matlab.system.display.Section(mfilename('class'));
        group.Actions = matlab.system.display.Action(@(~,obj)...
            visualize(obj),'Label','Visualize');
    end
end

methods
    function obj = PlotRamp(varargin)
        setProperties(obj,nargin,varargin{:});
    end

    function visualize(obj)
        figure;
        d = 1:obj.RampLimit;
        plot(d);
    end
end
```

When you specify the System object in the MATLAB System block, the resulting block dialog box appears as follows.

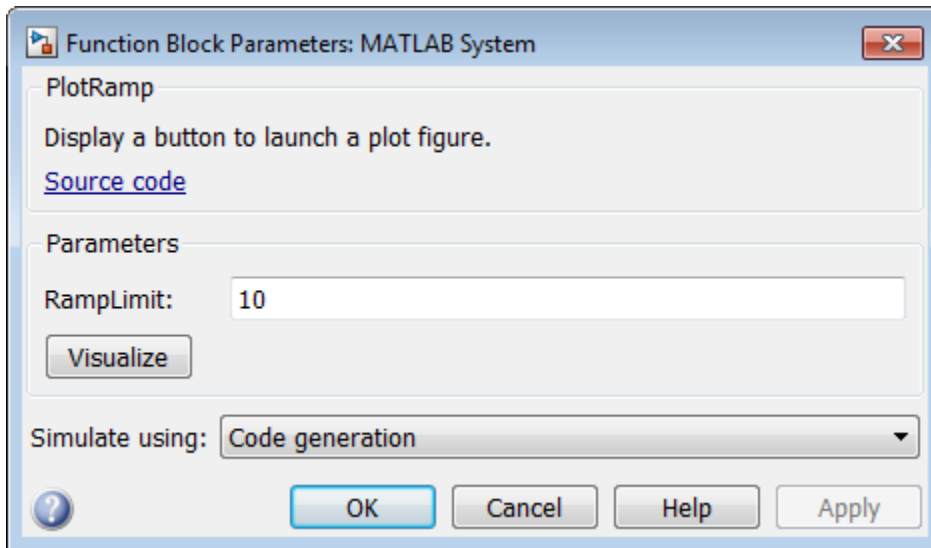

To open the same figure, rather than multiple figures, when the button is pressed more than once, use this code instead.

```

methods(Static,Access = protected)
    function group = getPropertyGroupsImpl
        group = matlab.system.display.Section(mfilename('class'));
        group.Actions = matlab.system.display.Action(@(actionData,obj)...
            visualize(obj,actionData),'Label','Visualize');
    end
end

methods
    function obj = ActionDemo(varargin)
        setProperties(obj,nargin,varargin{:});
    end

    function visualize(obj,actionData)
        f = actionData.UserData;
        if isempty(f) || ~ishandle(f)
            f = figure;
            actionData.UserData = f;
        else
            figure(f); % Make figure current
        end

        d = 1:obj.RampLimit;
        plot(d);
    end
end

```

See Also

getPropertyGroupsImpl | matlab.system.display.Section |
matlab.system.display.SectionGroup

Topics

“Classes”

Class Attributes

Property Attributes

“Add Custom Button to MATLAB System Block”

matlab.system.display.SectionGroup class

Package: matlab.system.display

Section group for System objects

Syntax

```
matlab.system.display.SectionGroup(N1,V1,...Nn,Vn)
matlab.system.display.SectionGroup(Obj,...)
```

Description

`matlab.system.display.SectionGroup(N1,V1,...Nn,Vn)` creates a group for displaying System object properties and display sections created with `matlab.system.display.Section`. You define such sections or properties using property Name-Value pairs (N,V). A section group can contain both properties and sections. You use `matlab.system.display.SectionGroup` to define section groups using the `getPropertyGroupsImpl` method. Section groups display as separate tabs in the MATLAB System block. The available Section properties are:

- **Title** — Group title. The default value is an empty character vector.
- **TitleSource** — Source of group title. Valid values are 'Property' and 'Auto'. The default value is 'Property', which uses the character vector from the Title property. If the Obj name is given, the default value is Auto, which uses the Obj name. In the System object property display at the MATLAB command line, you can omit the default "Main" title for the first group of properties by setting TitleSource to 'Auto'.
- **Description** — Group or tab description that appears above any properties or panels. The default value is an empty character vector.
- **PropertyList** — Group or tab property list as a cell array of property names. The default value is an empty array. If the Obj name is given, the default value is all eligible display properties.
- **Sections** — Group sections as an array of section objects. If the Obj name is given, the default value is the default section for the Obj.
- **Type** — Container type. For example, tab, group, panel, and collapsible panel.
- **Row** — Specify the row in which the containers need to be placed (current/new). You can specify the row using the enum class `matlab.system.display.internal.Row`.
- **AlignPrompts** — Specify a boolean value to control align prompts within the containers.

`matlab.system.display.SectionGroup(Obj,...)` creates a section group for the specified System object (Obj) and sets the following property values:

- **TitleSource** — Set to 'Auto'.
- **Sections** — Set to `matlab.system.display.Section` object for Obj.

You can use `mfilename('class')` from within this method to get the name of the System object. If you set any Name-Value pairs, those property values override the default settings.

Examples

Define Block Dialog Containers

Define in your class definition file two tabs, each containing specific properties. For this example, you use the `matlab.system.display.SectionGroup`, `matlab.system.display.Section`, and `getPropertyGroupsImpl` methods.

```
classdef MultipleGroupsWithSectionGroup < matlab.System
    % MultipleGroupsWithTabs Customize block dialog with multiple tabs and parameter groups.

    % Public, tunable properties
    properties
        %StartValue Start Value
        StartValue = 0

        %EndValue End Value
        EndValue = 10

        Threshold = 1

        %BlockLimit Limit
        BlockLimit = 55
    end
    % Public Nontunable
    properties(Nontunable)
        %IC1 First initial condition
        IC1 = 0

        %IC2 Second initial condition
        IC2 = 10

        %IC3 Third initial condition
        IC3 = 100

        %UseThreshold Use threshold
        UseThreshold (1,1) logical = true
    end

    methods (Static, Access = protected)
        function groups = getPropertyGroupsImpl
            % Section to always display above any tabs.
            alwaysSection = matlab.system.display.Section(...
                'Title', '', 'PropertyList', {'BlockLimit'});

            % Group with no sections
            initTab = matlab.system.display.SectionGroup(...
                'Title', 'Initial conditions', ...
                'PropertyList', {'IC1', 'IC2', 'IC3'}, ...
                'GroupType', matlab.system.display.SectionType.group);

            % Section for the value parameters
            valueSection = matlab.system.display.Section(...
                'Title', 'Value parameters', ...
                'PropertyList', {'StartValue', 'EndValue'}, ...
                'SectionType', matlab.system.display.SectionType.collapsiblepanel);

            % Section for the threshold parameters
            thresholdSection = matlab.system.display.Section(...
                'Title', 'Threshold parameters', ...
```

```

        'PropertyList',{ 'Threshold', 'UseThreshold'},...
        'SectionType', matlab.system.display.SectionType.collapsiblepanel);

% Group with two sections: the valueSection and thresholdSection sections
mainTab = matlab.system.display.SectionGroup(...
    'Title', 'Main', ...
    'Sections', [valueSection, thresholdSection],...
    'GroupType', matlab.system.display.SectionType.group);

% Return an array with the group-less section, the group with
% two sections, and the group with no sections.
groups = [alwaysSection, mainTab, initTab];
end
end
end

```

The resulting dialog appears as follows when you add the object to Simulink with the MATLAB System block.

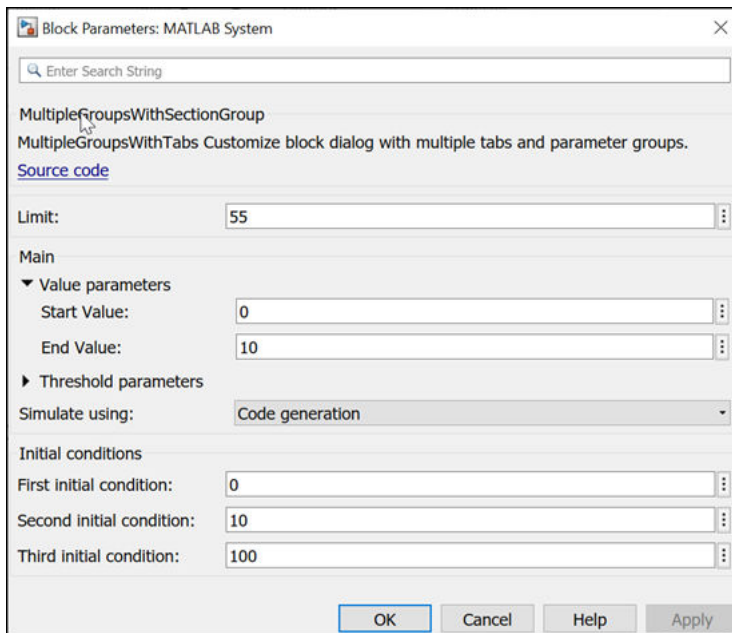

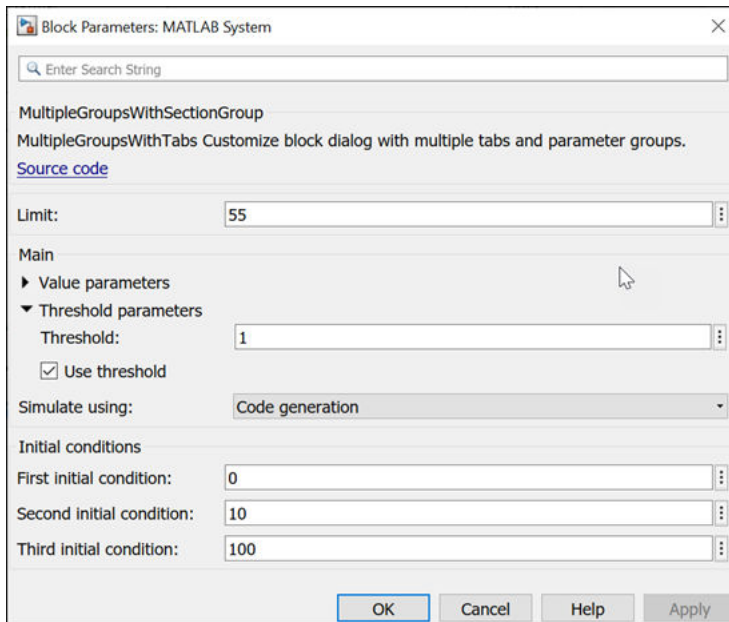

See Also

`matlab.system.display.Header` | `matlab.system.display.Section` | `getPropertyGroupsImpl`

Topics

“Customize System Block Dialog Box”

matlab.system.display.Icon class

Package: matlab.system.display

Custom icon image

Syntax

```
icon = matlab.system.display.Icon(imageFile)
```

Description

`icon = matlab.system.display.Icon(imageFile)` sets the `imageFile` image as the MATLAB System block icon. To set the icon image, use the `icon` output argument from `getIconImpl`.

Input Arguments

imageFile — Image file

character array

Image file to display on the block icon, specified as a character array. If the image is not on the path, use the full path to your image file.

The image file must be in a file format supported for block masks. See “Draw Static Icon”.

Example: "image.png"

Examples

Add Image to MATLAB System Block

Define an image in your class definition file.

```
methods(Access = protected)
    function icon = getIconImpl(~)
        % Define icon for MATLAB System block
        icon = matlab.system.display.Icon("my_icon.png");
    end
end
```

The image now appears on the MATLAB System block icon.



See Also

`getIconImpl` | `matlab.system.mixin.CustomIcon`

Topics

Class Attributes

Property Attributes

“Customize System Block Appearance”

Introduced in R2017a

matlab.system.mixin.Propagates class

Package: matlab.system.mixin

Signal characteristics propagation mixin class

Note The `matlab.system.mixin.Propagates` mixin will be removed in a future release. You no longer need to inherit from this mixin in your System object. The associated propagation methods have been moved to the `matlab.System` class.

Description

`matlab.system.mixin.Propagates` specifies the output size, data type, and complexity of a System object. Use this mixin class and its methods when you will include your System object in Simulink via the MATLAB System block. This mixin is called by the MATLAB System block during Simulink model compilation.

Note If your System object has exactly one input and one output and no discrete property states, or if you do not need bus support, you do not have to implement any of these methods. The `matlab.system.mixin.Propagates` provides default values in these cases.

Implement the methods of this class when Simulink cannot infer the output specifications directly from the inputs or when you want bus support. If you do not include this mixin, Simulink cannot propagate the output or bus data type, an error occurs.

To use this mixin, subclass from this `matlab.system.mixin.Propagates` in addition to subclassing from the `matlab.System` base class. Type the following syntax as the first line of your class definition file. `ObjectName` is the name of your System object.

```
classdef ObjectName < matlab.System &...  
    matlab.system.mixin.Propagates
```

The `matlab.system.mixin.Propagates` class is a handle class.

Compatibility Considerations

matlab.system.mixin.Propagates will be removed

Not recommended starting in R2020a

The `matlab.system.mixin.Propagates` mixin will be removed in a future release. You no longer need to inherit from this mixin in your System object. The associated propagation methods have been moved to the `matlab.System` class.

Remove `matlab.system.mixin.Propagates` from the `classdef` line of your System object.

See Also

`matlab.System`

Topics

“Set Output Data Type”

“Set Output Size”

“Set Output Complexity”

“Set Fixed- or Variable-Size Output”

“Set Discrete State Output Specification”

Introduced in R2014a

getDiscreteStateSpecificationImpl

Discrete state size, data type, and complexity

Syntax

```
[size,dataType,complexity] = getDiscreteStateSpecificationImpl(obj,  
propertyName)
```

Description

[size,dataType,complexity] = getDiscreteStateSpecificationImpl(obj, propertyName) returns the size, data type, and complexity of the discrete state property. This property must be a discrete state property. You must define this method if your System object has discrete state properties and is used in the MATLAB System block.

Run-Time Details

getDiscreteStateSpecificationImpl is called by the MATLAB System block during Simulink model compilation.

Method Authoring Tips

- You must set Access = protected for this method.
- You cannot modify any properties in this method.

Input Arguments

obj — System object

System object

System object handle used to access properties, states, and methods specific to the object. If your getDiscreteStateSpecificationImpl method does not use the object, you can replace this input with ~.

propertyName — Discrete state property name

property name

Name of discrete state property of the System object

Output Arguments

size — Property size

[1 1] (default) | numeric vector

Vector containing the length of each dimension of the property.

dataType — Property data type

double (default) | character vector

Data type of the property. For built-in data types, `dataType` is a character vector. For fixed-point data types, `dataType` is a numeric type object.

complexity — Complexity of the property

`false` (default) | `true`

Complexity of the property as a scalar, logical value:

- `true` — complex
- `false` — real

Examples

Specify Discrete State Property Size, Data Type, and Complexity

Specify in your class definition file the size, data type, and complexity of a discrete state property.

```
methods (Access = protected)
    function [sz,dt,cp] = getDiscreteStateSpecificationImpl(~,name)
        sz = [1 1];
        dt = "double";
        cp = false;
    end
end
```

See Also

Topics

“Set Discrete State Output Specification”

Introduced in R2013b

getOutputDataTypeImpl

Data types of output ports

Syntax

```
[dt_1,dt_2,...,dt_n] = getOutputDataTypeImpl(obj)
```

Description

`[dt_1,dt_2,...,dt_n] = getOutputDataTypeImpl(obj)` returns the data type of each output port as a character vector for built-in data types or as a numeric object for fixed-point data types. The number of outputs must match the value returned from the `getNumOutputsImpl` method or the number of output arguments listed in the `stepImpl` method.

For System objects with one input and one output and where you want the input and output data types to be the same, you do not need to implement this method. In this case, `getOutputDataTypeImpl` assumes the input and output data types are the same and returns the data type of the input.

If your System object has more than one input or output, and you use propagation, you must set the output data types in the `getOutputDataTypeImpl` method. For Simulink, if the input and output data types are different, you might have to cast the output value to the data type of the appropriate `dt_n` output argument. You specify this casting in the `stepImpl` method. For bus output, you must specify the name of the output bus in `getOutputDataTypeImpl`.

If needed to determine the output data type, you can use `propagatedInputDataType` within the `getOutputDataTypeImpl` method to obtain the input type.

Run-Time Details

`getOutputDataTypeImpl` is called by the MATLAB System block.

Method Authoring Tips

- You must set `Access = protected` for this method.
- You cannot modify any properties in this method.
- If you are debugging your code and examine the data types before Simulink completes propagation, you might see outputs with empty, `[]`, data types. This occurs because Simulink has not completed setting the output data types.

Input Arguments

obj — System object

System object

System object handle used to access properties, states, and methods specific to the object. If your `getOutputDataTypeImpl` method does not use the object, you can replace this input with `~`.

Output Arguments

dt_1, dt_2, ... — Property data type

character vector | numeric type object

Data type of the property. For built-in data types, dt is a character vector. For fixed-point data types, dt is a numeric type object.

Examples

Specify Output Data Type

Specify, in your class definition file how to control the output data type from a MATLAB System block. This example shows how to use the `getOutputDataTypeImpl` method to change the output data type from single to double, or propagate the input as a double. It also shows how to cast the data type to change the output data type in the `stepImpl` method.

```
classdef DataTypeChange < matlab.System & ...
    matlab.system.mixin.Propagates

    properties(Nontunable)
        Quantize = false
    end

    methods(Access = protected)
        function y = stepImpl(obj,u)
            if obj.Quantize == true
                % Cast for output data type to differ from input.
                y = single(u);
            else
                % Propagate output data type.
                y = u;
            end
        end

        function out = getOutputDataTypeImpl(obj)
            if obj.Quantize == true
                out = "single";
            else
                out = propagatedInputDataType(obj,1);
            end
        end
    end
end
end
```

Specify Bus Output

Specify, in your class definition file, that the System object data type is a bus. You must also include a property to specify the bus name.

```
properties(Nontunable)
    OutputBusName = "myBus";
end
```

```
methods (Access = protected)
    function out = getOutputDataTypeImpl(obj)
        out = obj.OutputBusName;
    end
end
```

The data type of the output bus must be defined upfront. The `propagatedInputDataType` method does not support propagation of bus data types to the output data type.

See Also

`propagatedInputDataType`

Topics

“Set Output Data Type”

Introduced in R2013b

getOutputSizeImpl

Sizes of output ports

Syntax

```
[sz_1,sz_2,...,sz_n] = getOutputSizeImpl(obj)
```

Description

`[sz_1,sz_2,...,sz_n] = getOutputSizeImpl(obj)` returns the size of each output port. The number of outputs must match the value returned from the `getNumOutputs` method or the number of output arguments listed in the `stepImpl` method.

If your System object has only one input and one output and you want the input and output sizes to be the same, you do not need to implement this method. In this case `getOutputSizeImpl` assumes that the input and output sizes are the same and returns the size of the input. For variable-size inputs in MATLAB, the size varies each time you run your object. For variable-size inputs in Simulink, the output size is the maximum input size.

You must implement the `getOutputSizeImpl` method to define the output size, if:

- Your System object has more than one input or output
- You need the output and input sizes to be different.

If the output size differs from the input size, you must also use the `propagatedInputSize` method

Run-Time Details

During Simulink model compilation and propagation, the MATLAB System block calls the `getOutputSizeImpl` method to determine the output size.

All inputs default to variable-size inputs. For these inputs, the output size is the maximum input size.

Method Authoring Tips

- You must set `Access = protected` for this method.
- In this method, you cannot modify any properties.

Input Arguments

obj — System object

System object

System object handle used to access properties, states, and methods specific to the object. If your `getOutputSizeImpl` method does not use the object, you can replace this input with `~`.

Output Arguments

sz_1, sz_2, ... — Output size

numeric vector

Vector containing the size of each output port.

Examples

Specify Output Size

Specify in your class definition file the size of a System object output.

```
methods (Access = protected)
    function sz_1 = getOutputSizeImpl(obj)
        sz_1 = [1 1];
    end
end
```

Specify Multiple Output Ports

Specify in your class definition file the sizes of multiple System object outputs.

```
methods (Access = protected)
    function [sz_1, sz_2] = getOutputSizeImpl(obj)
        sz_1 = propagatedInputSize(obj, 1);
        sz_2 = [1 1];
    end
end
```

Specify Output When Using Propagated Input Size

Specify in your class definition file the size of System object output when it depends on the propagated input size.

```
methods (Access = protected)
    function varargout = getOutputSizeImpl(obj)
        varargout{1} = propagatedInputSize(obj, 1);
        if obj.HasSecondOutput
            varargout{2} = [1 1];
        end
    end
end
```

See Also

`propagatedInputSize`

Topics

“Set Output Size”

Introduced in R2013b

isOutputComplexImpl

Complexity of output ports

Syntax

```
[cp_1, cp_2, ..., cp_n] = isOutputComplexImpl(obj)
```

Description

[cp_1, cp_2, ..., cp_n] = isOutputComplexImpl(obj) returns whether each output port has complex data. The number of outputs must match the value returned from the `getNumOutputs` method or the number of output arguments listed in the `stepImpl` method.

For System objects with one input and one output and where you want the input and output complexities to be the same, you do not need to implement this method. In this case `isOutputComplexImpl` assumes the input and output complexities are the same and returns the complexity of the input.

If your System object has more than one input or output or you need the output and input complexities to be different, you must implement the `isOutputComplexImpl` method to define the output complexity. You also must use the `propagatedInputComplexity` method if the output complexity differs from the input complexity.

Run-Time Details

During Simulink model compilation and propagation, the MATLAB System block calls the `isOutputComplex` method, which then calls the `isOutputComplexImpl` method to determine the output complexity.

Method Authoring Tips

- You must set `Access = protected` for this method.
- You cannot modify any properties in this method.

Input Arguments

obj — System object

System object

System object handle used to access properties, states, and methods specific to the object. If your `isOutputComplexImpl` method does not use the object, you can replace this input with `~`.

Output Arguments

cp_1, cp_2, ... — Complexity flag

true | false

Logical, scalar value indicating whether the specific output port is complex (`true`) or real (`false`).

Examples

Specify Output as Real-Valued

Specify in your class definition file that the output from a System object is a real value.

```
methods (Access = protected)
    function c1 = isOutputComplexImpl(obj)
        c1 = false;
    end
end
```

See Also

propagatedInputComplexity

Topics

“Set Output Complexity”

Introduced in R2013b

isOutputFixedSizeImpl

Fixed- or variable-size output ports

Syntax

```
[flag_1,flag_2,...flag_n] = isOutputFixedSizeImpl(obj)
```

Description

[flag_1,flag_2,...flag_n] = isOutputFixedSizeImpl(obj) returns whether each output port is fixed size. The number of outputs must match the value returned from the `getNumOutputs` method, which is the number of output arguments listed in the `stepImpl` method.

For System objects with one input and one output and where you want the input and output fixed sizes to be the same, you do not need to implement this method. In this case `isOutputFixedSizeImpl` assumes the input and output fixed sizes are the same and returns the fixed size of the input.

If your System object has more than one input or output or you need the output and input fixed sizes to be different, you must implement the `isOutputFixedSizeImpl` method to define the output fixed size. You also must use the `propagatedInputFixedSize` method if the output fixed size status differs from the input fixed size status.

Run-Time Details

During Simulink model compilation and propagation, the MATLAB System block calls the `isOutputFixedSize` method, which then calls the `isOutputFixedSizeImpl` method to determine the output fixed size.

All inputs default to variable-size inputs. For these inputs, the output size is the maximum input size.

Method Authoring Tips

- You must set `Access = protected` for this method.
- You cannot modify any properties in this method.

Input Arguments

obj — System object

System object

System object handle used to access properties, states, and methods specific to the object. If your `isOutputFixedSizeImpl` method does not use the object, you can replace this input with `~`.

Output Arguments

flag_1, flag2, ... — Fixed size flag

true | false

Logical, scalar value indicating whether the specific output port is fixed size (`true`) or variable size (`false`).

Examples

Specify Output as Fixed Size

Specify in your class definition file that the output from a System object is of fixed size.

```
methods (Access = protected)
    function c1 = isOutputFixedSizeImpl(obj)
        c1 = true;
    end
end
```

See Also

`propagatedInputFixedSize`

Topics

“Set Fixed- or Variable-Size Output”

Introduced in R2013b

propagatedInputComplexity

Complexity of input during Simulink propagation

Syntax

```
flag = propagatedInputComplexity(obj, index)
```

Description

`flag = propagatedInputComplexity(obj, index)` returns `true` or `false` to indicate whether the input argument for the indicated System object is complex. `index` specifies the input for which to return the complexity flag.

You can use `propagatedInputComplexity` only from within the `isOutputComplexImpl` method in your class definition file. Use `isOutputComplexImpl` when:

- Your System object has more than one input or output.
- The input complexity determines the output complexity.
- The output complexity must differ from the input complexity.

Input Arguments

obj — System object

System object

System object handle used to access properties, states, and methods specific to the object. If your `propagatedInputComplexity` method does not use the object, you can replace this input with `~`.

index — Input index

positive integer

Index of the specified input. Do not count the `obj` in the `index`. The first input is always `obj`.

Output Arguments

flag — Complexity flag

`true` | `false`

Complexity of the specified input, returned as `true` or `false`

Examples

Match Input and Output Complexity

Get the complexity of the second input when you run the object and set the output to match it. Assume that the first input has no impact on the output complexity.

```
methods (Access = protected)
  function outcomplx = isOutputComplexImpl(obj)
    outcomplx = propagatedInputComplexity(obj,2);
  end
end
```

See Also

isOutputComplexImpl

Topics

“Set Output Complexity”

Introduced in R2014a

propagatedInputDataType

Data type of input during Simulink propagation

Syntax

```
dt = propagatedInputDataType(obj,index)
```

Description

`dt = propagatedInputDataType(obj,index)` returns the data type of an input argument for a System object. `index` specifies the input for which to return the data type.

You can use `propagatedInputDataType` only from within `getOutputDataTypeImpl`. Use `getOutputDataTypeImpl` when:

- Your System object has more than one input or output.
- The input data type status determines the output data type.
- The output data type must differ from the input data type.

Input Arguments

obj — System object

System object

System object handle used to access properties, states, and methods specific to the object. If your `propagatedInputDataType` method does not use the object, you can replace this input with `~`.

index — Input index

positive integer

Index of the specified input. Do not count the `obj` in the `index`. The first input is always `obj`.

Output Arguments

dt — Input data type

character vector | numeric type object

Data type of the specified input, returned as a character vector for floating-point input or as a numeric type for fixed-point input.

Examples

Match Input and Output Data Type

Get the data type of the second input. If the second input data type is `double`, then the output data type is `int32`. For all other cases, the output data type matches the second input data type. Assume that the first input has no impact on the output.

```
methods (Access = protected)
    function dt = getOutputDataTypeImpl(obj)
        if strcmpi(propagatedInputDataType(obj,2), 'double')
            dt = 'int32';
        else
            dt = propagatedInputDataType(obj,2);
        end
    end
end
```

See Also

getOutputDataTypeImpl

Topics

“Set Output Data Type”

“Data Type Propagation”

Introduced in R2014a

propagatedInputFixedSize

Fixed-size status of input during Simulink propagation

Syntax

```
flag = propagatedInputFixedSize(obj,index)
```

Description

`flag = propagatedInputFixedSize(obj,index)` returns `true` or `false` to indicate whether an input argument of a System object is fixed size. `index` specifies the input for which to return the fixed-size flag.

You can use `propagatedInputFixedSize` only from within `isOutputFixedSizeImpl`. Use `isOutputFixedSizeImpl` when:

- Your System object has more than one input or output.
- The input fixed-size status determines the output fixed-size status.
- The output fixed-size status must differ from the input fixed-size status.

Input Arguments

obj — System object

System object

System object handle used to access properties, states, and methods specific to the object. If your `propagatedInputFixedSize` method does not use the object, you can replace this input with `~`.

index — Input index

positive integer

Index of the specified input. Do not count the `obj` in the `index`. The first input is always `obj`.

Output Arguments

flag — Fixed size flag

`true` | `false`

Fixed-size status of the specified input, returned as `true` or `false`.

Examples

Match Fixed-Size Status of Input and Output

Get the fixed-size status of the third input and set the output to match it. Assume that the first and second inputs have no impact on the output.

```
methods (Access = protected)
  function outtype = isOutputFixedSizeImpl(obj)
    outtype = propagatedInputFixedSize(obj,3)
  end
end
```

See Also

isOutputFixedSizeImpl

Topics

“Set Fixed- or Variable-Size Output”

Introduced in R2014a

propagatedInputSize

Size of input during Simulink propagation

Syntax

```
size = propagatedInputSize(obj,index)
```

Description

`size = propagatedInputSize(obj,index)` returns, as a vector, the input size of the specified System object. The `index` specifies the input for which to return the size information. (Do not count the `obj` in the `index`. The first input is always `obj`.)

You can use `propagatedInputSize` only from within the `getOutputSizeImpl` method in your class definition file. Use `getOutputSizeImpl` when:

- Your System object has more than one input or output.
- The input size determines the output size.
- The output size must differ from the input size.

Note For variable-size inputs, the propagated input size from `propagatedInputSize` differs depending on the environment.

- MATLAB — `propagatedInputSize` returns the size of the inputs used when you run the object for the first time.
 - Simulink — `propagatedInputSize` returns the upper bound of the input sizes.
-

Input Arguments

obj — System object

System object

System object handle used to access properties, states, and methods specific to the object. If your `propagatedInputSize` method does not use the object, you can replace this input with `~`.

index — Input index

integer

Index of the specified input

Output Arguments

size — Input size

numeric vector

Size of the specified input, returned as a vector

Examples

Match Size of Input and Output

Get the size of the second input. If the first dimension of the second input has a size greater than 1, then set the output size to a 1 x 2 vector. For all other cases, the output is a 2 x 1 matrix. Assume that the first input has no impact on the output size.

```
methods (Access = protected)
    function outsize = getOutputSizeImpl(obj)
        size = propagatedInputSize(obj,2);
        if size(1) == 1
            outsize = [1,2];
        else
            outsize = [2,1];
        end
    end
end
```

See Also

getOutputSizeImpl

Topics

“Set Output Size”

Introduced in R2014a

matlab.system.mixin.Nondirect class

Package: matlab.system.mixin

Nondirect feedthrough mixin class

Note The `matlab.system.mixin.Nondirect` mixin will be removed in a future release. You no longer need to inherit from this mixin in your System object. The associated methods have been moved to the `matlab.System` class.

Description

`matlab.system.mixin.Nondirect` is a class that uses the `output` and `update` methods to process nondirect feedthrough data through a System object.

For System objects that use direct feedthrough, the object's input is needed to generate the output at that time. For these direct feedthrough objects, running the System object calculates the output and updates the state values. For nondirect feedthrough, however, the object's output depends only on the internal states at that time. The inputs are used to update the object states. For these objects, calculating the output with `outputImpl` is separated from updating the state values with `updateImpl`. If you use the `matlab.system.mixin.Nondirect` mixin and include the `stepImpl` method in your class definition file, an error occurs. In this case, you must include the `updateImpl` and `outputImpl` methods instead.

The following cases describe when System objects in Simulink use direct or nondirect feedthrough.

- System object supports code generation and does not inherit from the `Propagates` mixin — Simulink automatically infers the direct feedthrough settings from the System object code.
- System object supports code generation and inherits from the `Propagates` mixin — Simulink does not automatically infer the direct feedthrough settings. Instead, it uses the value returned by the `isInputDirectFeedthroughImpl` method.
- System object does not support code generation — Default `isInputDirectFeedthroughImpl` method returns `false`, indicating that direct feedthrough is not enabled. To override the default behavior, implement the `isInputDirectFeedthroughImpl` method in your class definition file.

Use the `Nondirect` mixin to allow a System object to be used in a Simulink feedback loop. A delay object is an example of a nondirect feedthrough object.

To use this mixin, you must subclass from this class in addition to subclassing from the `matlab.System` base class. Type the following syntax as the first line of your class definition file, where `ObjectName` is the name of your object:

```
classdef ObjectName < matlab.system & matlab.system.mixin.Nondirect
```

Compatibility Considerations

matlab.system.mixin.Nondirect will be removed

Not recommended starting in R2020a

The `matlab.system.mixin.Nondirect` mixin will be removed in a future release. You no longer need to inherit from this mixin in your `System` object. The associated methods have been moved to the `matlab.System` class.

Remove `matlab.system.mixin.Nondirect` from the `classdef` line of your `System` object

See Also

`matlab.System`

Topics

“Use Update and Output for Nondirect Feedthrough”

Introduced in R2013b

isInputDirectFeedthroughImpl

Direct feedthrough status of input

Syntax

```
[flag1,...,flagN] = isInputDirectFeedthroughImpl(obj)
[flag1,...,flagN] = isInputDirectFeedthroughImpl(obj,input,input2,...)
```

Description

[flag1,...,flagN] = isInputDirectFeedthroughImpl(obj) specifies whether each input is a direct feedthrough input. If direct feedthrough is true, the output depends on the input at each time instant.

[flag1,...,flagN] = isInputDirectFeedthroughImpl(obj,input,input2,...) uses one or more of the System object input specifications to determine whether inputs have direct feedthrough.

If you do not include the isInputDirectFeedthroughImpl method in your System object class definition file, all inputs are assumed to be direct feedthrough.

Code Generation

The following cases describe when System objects in Simulink code generation use direct or nondirect feedthrough.

| System object's code generation support | Uses a propagation Impl method | Simulink Code Generation Result |
|---|--------------------------------|--|
| Y | N | Simulink automatically infers the direct feedthrough settings from the System object code. |
| Y | Y | Simulink does not automatically infer the direct feedthrough settings. Instead, it uses the value returned by the isInputDirectFeedthroughImpl method. |
| N | — | Default isInputDirectFeedthroughImpl method returns false, indicating that direct feedthrough is not enabled. To override the default behavior, implement the isInputDirectFeedthroughImpl method in your class definition file. |

Run-Time Details

isInputDirectFeedthroughImpl is called by the MATLAB System block.

Method Authoring Tips

- You must set Access = protected for this method.
- You cannot modify, implement, or access tunable properties in this method.

Input Arguments

obj — System object

System object

System object handle used to access properties, states, and methods specific to the object. If your `isInputDirectFeedthroughImpl` method does not use the object, you can replace this input with `~`.

input1, input2, ... — Inputs to the System object

inputs to the System object algorithm

Inputs to the algorithm (`stepImpl`) of the System object. The inputs list must match the order of inputs in the `stepImpl` signature.

Output Arguments

flag1, ..., flagN — Output flag for each input to the System object

logical

Logical value, either `true` or `false` indicating whether the input is direct feedthrough. The number of output flags must match the number of inputs to the System object (inputs to `stepImpl`, `outputImpl`, or `updateImpl`).

Examples

Specify Input as Nondirect Feedthrough

Use `isInputDirectFeedthroughImpl` in your class definition file for marking all inputs as nondirect feedthrough.

```
methods (Access = protected)
    function flag = isInputDirectFeedthroughImpl(~)
        flag = false;
    end
end
```

Complete Class Definition

```
classdef intDelaySysObj < matlab.System
    % intDelaySysObj Delay input by specified number of samples.

    properties
        InitialOutput = 0;
    end
    properties (Nontunable)
        NumDelays = 1;
    end
    properties (DiscreteState)
        PreviousInput;
    end

    methods (Access = protected)
        function validatePropertiesImpl(obj)
```

```
    if ((numel(obj.NumDelays)>1) || (obj.NumDelays <= 0))
        error('Number of delays must be > 0 scalar value.');
```

```
    end
    if (numel(obj.InitialOutput)>1)
        error('Initial Output must be scalar value.');
```

```
    end
end

function setupImpl(obj)
    obj.PreviousInput = ones(1,obj.NumDelays)*obj.InitialOutput;
end

function resetImpl(obj)
    obj.PreviousInput = ones(1,obj.NumDelays)*obj.InitialOutput;
end

function [y] = outputImpl(obj,~)
    y = obj.PreviousInput(end);
end
function updateImpl(obj, u)
    obj.PreviousInput = [u obj.PreviousInput(1:end-1)];
end
function flag = isInputDirectFeedthroughImpl(~)
    flag = false;
end
end
end
```

See Also

[updateImpl](#) | [outputImpl](#)

Topics

“Use Update and Output for Nondirect Feedthrough”

Introduced in R2013b

outputImpl

Output calculation from input or internal state of System object

Syntax

```
[y1,y2,...,yN] = outputImpl(obj,u1,u2,...,uN)
```

Description

`[y1,y2,...,yN] = outputImpl(obj,u1,u2,...,uN)` specifies the algorithm to output the System object states. The output values are calculated from the states and property values. Any inputs that you set to nondirect feedthrough are ignored during output calculation.

Run-Time Details

`outputImpl` is called by the internal `output` method. It is also called before the `updateImpl` method. For sink objects, calling `updateImpl` before `outputImpl` locks the object. For all other types of objects, calling `updateImpl` before `outputImpl` causes an error.

Method Authoring Tips

- You must set `Access = protected` for this method.
- If the System object will be used in the Simulink MATLAB System block, you cannot modify any tunable properties in this method.

Input Arguments

obj — System object

System object

System object handle used to access properties, states, and methods specific to the object. If your `outputImpl` method does not use the object, you can replace this input with `~`.

u1,u2,...,uN — Inputs to the algorithm

inputs

Inputs from the algorithm. The number of inputs must match the number of inputs returned by the `getNumInputs` method. Nondirect feedthrough inputs are ignored during normal execution of the System object. However, for code generation, you must provide these inputs even if they are empty.

Output Arguments

y1,y2,...,yN — Outputs of the algorithm

outputs

Outputs calculated from the specified algorithm. The number of outputs must match the number of outputs returned by the `getNumOutputs` method.

Examples

Set Up Output that Does Not Depend on Input

Specify in your class definition file that the output does not directly depend on the current input with the `outputImpl` method. `PreviousInput` is a property of the `obj`.

```
methods (Access = protected)
  function [y] = outputImpl(obj, ~)
    y = obj.PreviousInput(end);
  end
end
```

See Also

`updateImpl` | `isInputDirectFeedthroughImpl`

Topics

“Use Update and Output for Nondirect Feedthrough”

Introduced in R2013b

updateImpl

Update object states based on inputs

Syntax

```
updateImpl(obj, input1, input2, ...)
```

Description

`updateImpl(obj, input1, input2, ...)` specifies the algorithm to update the System object states. You implement this method when your algorithm outputs depend only on the object's internal state and internal properties.

Run-Time Details

`updateImpl` is called by the `update` method and after the `outputImpl` method.

For sink objects, calling `updateImpl` before `outputImpl` locks the object. For all other types of objects, calling `updateImpl` before `outputImpl` causes an error.

Method Authoring Tips

- Do not use this method to update the outputs from the inputs.
- You must set `Access = protected` for this method.
- If the System object will be used in the Simulink MATLAB System block, you cannot modify any tunable properties in this method.

Input Arguments

obj — System object

System object

System object handle used to access properties, states, and methods specific to the object. If your `updateImpl` method does not use the object, you can replace this input with `~`.

input1, input2, ... — Inputs to the System object

inputs to the System object

List the inputs to the System object. The order of inputs must match the order of inputs defined in the `stepImpl` method.

Examples

Set Up Output that Does Not Depend on Current Input

Update the object with previous inputs. Use `updateImpl` in your class definition file. This example saves the `u` input and shifts the previous inputs.

```
methods (Access = protected)
    function updateImpl(obj,u)
        obj.PreviousInput = [u obj.PreviousInput(1:end-1)];
    end
end
```

See Also

outputImpl | isInputDirectFeedthroughImpl

Topics

“Use Update and Output for Nondirect Feedthrough”

Introduced in R2013b

matlab.system.mixin.SampleTime class

Control sample time for System objects in Simulink

Note The `matlab.system.mixin.SampleTime` mixin will be removed in a future release. You no longer need to inherit from this mixin in your System object. The associated sample time methods have been moved to the `matlab.System` class.

Description

`matlab.system.mixin.SampleTime` specifies the sample time specifications for a System object when it is included in a MATLAB System block. Inherit from this mixin class and use its methods to control the sample time of your System object in Simulink, via the MATLAB System block.

With this mixin, you can:

- Specify the sample time type
- Specify the sample time
- Customize the sample time with offsets and tick times
- Get the current simulation time

System objects that inherit from this mixin class must also inherit from `matlab.System`. For example:

```
classdef MySystemObject < matlab.System & matlab.system.mixin.SampleTime
```

The `matlab.system.mixin.SampleTime` class is a handle class.

Methods

Compatibility Considerations

matlab.system.mixin.SampleTime will be removed

Not recommended starting in R2020a

The `matlab.system.mixin.SampleTime` mixin will be removed in a future release. You no longer need to inherit from this mixin in your System object. The associated sample time methods have been moved to the `matlab.System` class.

Remove `matlab.system.mixin.SampleTime` from the `classdef` line of your System object.

See Also

Classes

`matlab.System`

Blocks

MATLAB System

Topics

“Specify Sample Time for MATLAB System Block System Objects”

Introduced in R2017b

getSampleTimeImpl

Specify sample time type, offset time, and sample time

Syntax

```
sts = getSampleTimeImpl(obj)
```

Description

`sts = getSampleTimeImpl(obj)` returns the sample time specification created within the method body, `sts`, for the System object `obj`. Specify the sample time specification within the body of `getSampleTimeImpl` by calling `createSampleTime`. The sample time specification affects the simulation time when the System object is included in a MATLAB System block.

Run-Time Details

`getSampleTimeImpl` is called during setup by `setupImpl`.

Method Authoring Tips

You must set `Access = protected` for this method.

Default Behavior

If you do not include this method in your System object definition, the sample time is inherited.

Input Arguments

obj — System object

System object

System object handle used to access properties, states, and methods specific to the object. If your `getSampleTimeImpl` method does not use the object, you can replace this input with `~`.

Output Arguments

sts — Sample time specification object

sample time specification object

An object defining the sample time specification values. You create this object with the `createSampleTime` function.

Examples

Specify Inherited Sample Time

Specify that the MATLAB System block should inherit the sample from upstream blocks, except if the sample time type is controllable.

```
function sts = getSampleTimeImpl(obj)
    sts = createSampleTime(obj, 'ErrorOnPropagation', 'Controllable');
end
```

Specify Discrete Sample Time

Specify a discrete sample time for the MATLAB System block.

```
function sts = getSampleTimeImpl(obj)
    sts = createSampleTime(obj, 'Type', 'Discrete', ...
        'SampleTime', 10.2, 'OffsetTime', 0.5);
end
```

See Also

[createSampleTime](#) | [getCurrentTime](#) | [getSampleTime](#)

Topics

“Specify Sample Time for MATLAB System Block System Objects”

Introduced in R2017b

getSampleTime

Query sample time

Syntax

```
sts = getSampleTime(obj)
```

Description

`sts = getSampleTime(obj)` returns the sample time specification for the System object `obj` when the System object is included in a MATLAB System block. You can call `getSampleTime` in the `stepImpl` method to change the algorithm based on the sample time.

Before sample time has propagated throughout the MATLAB System block model, `getSampleTime` returns the `getSampleTimeImpl` sample time specification. If your system object does not override `getSampleTimeImpl`, the default Inherited sample time specification is returned.

After sample time has propagated, `getSampleTime` returns the sample time specification populated with the actual MATLAB System block sample time type, sample time, and offset time.

Input Arguments

obj — System object

System object

System object included in a MATLAB System block that you want to query.

Output Arguments

sts — Sample time specification object

sample time specification object

The sample time specification for the System object. For more details about sample time specification objects, see `createSampleTime`.

Examples

Return Sample Time

This example of `stepImpl` returns a count value `y`, the current simulation time `ct`, and the sample time `st`. The sample time is obtained by calling `getSampleTime`.

```
function [y,ct,st] = stepImpl(obj,u)
    y = obj.Count + u;
    obj.Count = y;
    ct = getCurrentTime(obj);
    sts = getSampleTime(obj);
    st = sts.SampleTime;
end
```

For a complete class definition, see “Specify Sample Time for MATLAB System Block System Objects”.

See Also

`createSampleTime` | `getCurrentTime` | `getSampleTimeImpl`

Topics

“Specify Sample Time for MATLAB System Block System Objects”

Introduced in R2017b

getCurrentTime

Current simulation time in MATLAB System block

Syntax

```
time = getCurrentTime(obj)
```

Description

`time = getCurrentTime(obj)` returns the current simulation time in the MATLAB System block. Call this method in the `stepImpl` method of your System object.

Dependencies

If the MATLAB System block is operating in continuous sample time, `getCurrentTime` may return non-monotonic times due to solver operation.

Input Arguments

obj – System object

system object

System object included in a MATLAB System block that you want to query.

Output Arguments

time – Current simulation time

double

The current simulation time of the MATLAB System block that contains the System object.

Examples

Return Current Simulation Time

This example of `stepImpl` returns a count value `y` and the current simulation time `ct`. The simulation time is obtained by calling `getCurrentTime`.

```
function [y,ct] = stepImpl(obj,u)
    y = obj.Count + u;
    obj.Count = y;
    ct = getCurrentTime(obj);
end
```

For a complete class definition, see “Specify Sample Time for MATLAB System Block System Objects”.

See Also

`createSampleTime` | `getSampleTime` | `getSampleTimeImpl`

Topics

“Specify Sample Time for MATLAB System Block System Objects”

Introduced in R2017b

createSampleTime

Create sample time specification object

Syntax

```
sts = createSampleTime(obj)
sts = createSampleTime(obj, 'Type', Type)
sts = createSampleTime(obj, 'Type', Type, Name, Value)
```

Description

`sts = createSampleTime(obj)` creates a sample time specification object for inherited sample time for the System object `obj`. Use this sample time specification object in the `getSampleTimeImpl` method of your System object. The sample time specification affects the simulation time when the System object is included in a MATLAB System block. If you do not include this method in your System object definition, the sample time is inherited.

`sts = createSampleTime(obj, 'Type', Type)` creates a sample time specification object with the specified sample time type.

`sts = createSampleTime(obj, 'Type', Type, Name, Value)` creates a sample time specification object with additional options specified by one or more `Name, Value` pair arguments. `Name` is a property name and `Value` is the corresponding value. `Name` must appear inside quotes. You can specify several name-value pair arguments in any order as `Name1, Value1, ..., NameN, ValueN`.

Dependencies

You can only call `createSampleTime` from the `getSampleTimeImpl` method of your System object.

Input Arguments

obj — System object

System object

System object that you want to specify the sample time.

Name-Value Pair Arguments

Specify optional comma-separated pairs of `Name, Value` arguments. `Name` is the argument name and `Value` is the corresponding value. `Name` must appear inside quotes. You can specify several name and value pair arguments in any order as `Name1, Value1, ..., NameN, ValueN`.

Example: `'Type', 'Fixed In Minor Step'`

Type — Sample time type

`'Inherited'` (default) | `'Controllable'` | `'Discrete'` | `'Fixed In Minor Step'`

Type of sample time you want the System object to use in Simulink. For descriptions of the different types of sample times, see:

- 'Inherited' - "Inherited Sample Time"
- 'Controllable' - "Controllable Sample Time"
- 'Discrete' - "Discrete Sample Time"
- 'Fixed In Minor Step' - "Fixed-in-Minor-Step"

Example: `createSampleTime('Type','Fixed In Minor Step')`

AllowPropagation — Allow the propagated sample time

'Controllable' | 'Constant' | 'Continuous' | cell array of character vectors | string array

For Inherited sample time only.

Specify one or more sample times you want to allow your object to use. When the sample time type is set to `Inherited` and the MATLAB System block receives the specified sample time, the block allows the sample time to propagate. You can specify multiple sample time types as a cell array or string array.

Example: `createSampleTime('Type','Inherited','AllowPropagation',{'Controllable','Continuous'})`

AlternatePropagation — Alter the propagated sample time

'Controllable' | 'Constant' | 'Continuous' | cell array of character vectors | string array

For Inherited sample time only.

Specify one or more sample times you do not want your object to use. When the sample time type is set to `Inherited` and you do not want the MATLAB System block to use the specified inherited sample time type, an alternative sample time is used by the block instead. You can specify multiple sample time types. For each sample time type, Simulink substitutes a different sample time type:

- 'Controllable' — The base rate of the controlled sample is propagated instead. Use this option if your System object depends on having constant time between each sample-time hit.
- 'Constant' — The base rate of the model is propagated instead, either the fastest discrete rate or fixed in minor step.
- 'Continuous' — The fastest discrete rate is propagated instead.

Example:

`createSampleTime('Type','Inherited','AlternatePropagation','Controllable')`

ErrorOnPropagation — Error on the propagated sample time

'Controllable' | 'Constant' | 'Continuous' | cell array of character vectors | string array

For Inherited sample time only.

Specify one or more sample times you do not want your object to use. When the sample time type is set to `Inherited` and the MATLAB System block receives the specified sample time, Simulink throws an error.

Example:

`createSampleTime('Type','Inherited','ErrorOnPropagation','Controllable')`

SampleTime — Time between samples

1 (default) | positive number

For Discrete sample time only.

Specify the time between sample hits in Simulink.

Example: `createSampleTime('Type','Discrete','SampleTime',1)`

Data Types: `single` | `double`

OffsetTime — Offset from sample time

0 (default) | nonnegative number less than `SampleTime`

For `Discrete` sample time only.

Specify the offset time for the sample hit. The offset is a time interval indicating an update delay. The block is updated later in the sample interval than other blocks operating at the same sample rate.

The offset time must be nonnegative and less than `SampleTime`.

Example: `createSampleTime('Type','Discrete','SampleTime',2,'OffsetTime',1)`

Data Types: `single` | `double`

TickTime — Time between sample time hits

-1 (default) | positive scalar

Required for `Controllable` sample time only.

Specify the time between controllable sample time hits. The tick time must be a positive scalar.

Example: `createSampleTime('Type','Controllable','TickTime',obj.TickTime)`

Data Types: `single` | `double`

Output Arguments

sts — Sample time specification object

sample time specification object

The sample time specification object. This object has the following properties:

- `Type` — Type of sample time
- `SampleTime` — Time between samples
- `OffsetTime` — Offset from sample time

Use this object as the return value of `getSampleTimeImpl`.

Examples

Create Inherited Sample Time Specification Object

Specify that the MATLAB System block inherits the sample from upstream blocks. Inherited sample time is the default, so no additional arguments are needed.

```
function sts = getSampleTimeImpl(obj)
    sts = createSampleTime(obj);
end
```

Create Discrete Sample Time Object

Specify a discrete sample time specification for the MATLAB System block, including offset time and the sample time.

```
function sts = getSampleTimeImpl(obj)
    sts = createSampleTime(obj, 'Type', 'Discrete', ...
        'SampleTime', 10.2, 'OffsetTime', 0.5);
end
```

See Also

[getCurrentTime](#) | [getSampleTime](#) | [getSampleTimeImpl](#) | [setNumTicksUntilNextHit](#)

Topics

“Specify Sample Time for MATLAB System Block System Objects”

Introduced in R2017b

setNumTicksUntilNextHit

Set the number of ticks in Simulink sample time

Syntax

```
setNumTicksUntilNextHit(obj,ticks)
```

Description

`setNumTicksUntilNextHit(obj,ticks)` sets the number of ticks in Simulink sample time to wait until the next call to `stepImpl`, or `outputImpl/updateImpl`.

Dependencies

To use this method, set your System object to controllable sample time with `createSampleTime('Type','Controllable')`. Otherwise, your System object gives a compilation error.

You can only call this method from `stepImpl`, `outputImpl`, `updateImpl`, or `resetImpl`.

Input Arguments

obj — System object

System object

System object that you want to specify the sample time.

ticks — Number of ticks in Simulink sample time

positive integer scalar

Number of ticks in Simulink sample time to wait until the next call to `stepImpl` or `outputImpl/updateImpl`. Specify this number as a positive integer scalar less than `intmax('uint64')`.

The number of sample time ticks to wait until the next hit is persistent. If you don't update this number, Simulink uses the previously set value of number of ticks to wait.

See Also

`getCurrentTime` | `getSampleTime` | `getSampleTimeImpl` | `createSampleTime`

Topics

"Specify Sample Time for MATLAB System Block System Objects"

Introduced in R2018a

ModelAdvisor.Preferences class

Package: ModelAdvisor

Set Model Advisor window preferences by specifying which folders and tabs to display

Description

Use instances of this class to set Model Advisor preferences.

Construction

The constructor `ModelAdvisor.Preferences` creates an instance of this class with default property values.

Create an instance `modelPreferences` of the `ModelAdvisor.Preferences` class.

```
modelPreferences = ModelAdvisor.Preferences;
```

Properties

DeselectByProduct — Deselect the By Product folder

(default) | true

Selection of the **By Product** folder in the Model Advisor window. The default value is `true`.

Example: `true`

Data Types: `logical`

ShowAccordion — Display advisors

(default) | true

Display of the **Code Generation Advisor**, **Upgrade Advisor**, and **Performance Advisor** in the Model Advisor window. You can use these advisors to help configure your model for code generation, upgrade your model for the current release, or improve performance.

Example: `true`

Data Types: `logical`

ShowByProduct — Display the By Product folder

(default) | true

Display of the **By Product** folder in the Model Advisor window. The default value is `true`.

Example: `true`

Data Types: `logical`

ShowByTask — Display the By Task folder

(default) | true

Display of the **By Task** folder in the Model Advisor window. The default value is `true`.

Example: `true`

Data Types: `logical`

ShowExclusionsInRpt — Include exclusions in report

(default) | `true`

Include exclusions in the Model Advisor report. The default value is `true`.

Example: `true`

Data Types: `logical`

ShowExclusionTab — Display the Exclusions tab

(default) | `false`

Display of the **Exclusions** tab in the Model Advisor window. The default value is `false`. When you click the **Exclusions** tab, the Model Advisor window displays checks that are excluded from the Model Advisor analysis.

Example: `true`

Data Types: `logical`

ShowSourceTab — Display the Source tab

(default) | `false`

Display of the **Source** tab in the Model Advisor window. The default value is `false`. When you click the **Source** tab, the Model Advisor window displays the check Title, TitleID, and location of the MATLAB source code for the check.

Example: `true`

Data Types: `logical`

Examples

Turn Off Display Of By Product Folder

This example shows how to not display the **By Product** folder in the Model Advisor window:

```
mp = ModelAdvisor.Preferences;
mp.load;
mp.ShowByProduct = false;
mp.save
```

Alternatives

You can set the Model Advisor preferences by using the Model Advisor Preferences dialog box:

- On the Model Advisor menu, select **Settings > Preferences**.
- From the Model Editor, from the **Modeling** tab, select **Model Advisor > Preferences**.

See Also

“Run Model Advisor Checks”

Introduced in R2014b

Simulink.AliasType

Create alias for signal and parameter data type

Description

Use a `Simulink.AliasType` to create an alias of a built-in data type such as `int8`.

The name of the object is the alias. The data type to which an alias refers, such as `int8`, is the base type. Alias names cannot be:

- Floating-point types: `half`, `single`, `double`
- Integer types: `int8`, `uint8`, `int16`, `uint16`, `int32`, `uint32`, `int64`, or `uint64`.
- Fixed-Point Designer types beginning with `sfix`, `ufix`, or `flt`.

You create the object in the base workspace or a data dictionary. To use the alias, you use the name of the object to set data types for signals, states, and parameters in a model.

Using aliases to specify signal and parameter data types can greatly simplify global changes to the data types that a model specifies. In particular, changing the data type of all signals, states, and parameters whose data type is specified by an alias requires changing only the base type of the alias. By contrast, changing the data types of signals, states, and parameters whose data types are specified by an actual type name requires respecifying the data type of each signal and parameter individually.

You can use objects of this class to create an alias for Simulink built-in data types, fixed-point data types, enumerated data types, `Simulink.NumericType` objects, and other `Simulink.AliasType` objects. The code that you generate from a model (Simulink Coder) uses the alias only if you use an ERT-based system target file (Embedded Coder).

Alternatively, to define and name a numeric data type, you can use an object of the class `Simulink.NumericType`.

Creation

You can use either the Model Explorer or MATLAB commands to create a data type alias.

To use the Model Explorer to create an alias:

- 1 On the Model Explorer **Model Hierarchy** pane, select **Base Workspace**.

You must create data type aliases in the MATLAB workspace or in a data dictionary. If you attempt to create an alias in a model workspace, Simulink software displays an error.

- 2 From the Model Explorer **Add** menu, select **Simulink.AliasType**.

Simulink software creates an instance of a `Simulink.AliasType` object and assigns it to a variable named `Alias` in the MATLAB workspace.

- 3 Rename the variable to a more appropriate name, for example, a name that reflects its intended usage.

To change the name, edit the name displayed in the **Name** field on the Model Explorer **Contents** pane.

- 4 On the Model Explorer **Dialog** pane, in the **Base type** field, enter the name of the data type that this alias represents.

You can specify the name of any existing standard or user-defined data type in this field. Skip this step if the base type is `double` (the default).

To generate `Simulink.AliasType` objects that correspond to `typedef` statements in your external C code, consider using the `Simulink.importExternalCTypes` function.

To create a data type alias programmatically, use the `Simulink.AliasType` function described below.

Syntax

```
aliasObj = Simulink.AliasType
aliasObj = Simulink.AliasType(baseType)
```

Description

`aliasObj = Simulink.AliasType` returns a `Simulink.AliasType` object with default property values.

`aliasObj = Simulink.AliasType(baseType)` returns a `Simulink.AliasType` object and initializes the value of the `BaseType` property by using `baseType`.

Properties

For information about properties in the property dialog box of a `Simulink.AliasType` object, see “`Simulink.AliasType` Property Dialog Box”.

BaseType — Name of base data type

'double' (default) | character vector | string scalar

Name of the base data type that this alias renames, specified as a character vector or string scalar. You can specify the name of a standard data type, such as `int8` or `half`, or the name of a custom data type, such as the name of another `Simulink.AliasType` object or the name of an enumeration.

To specify a fixed-point data type, you can use a call to the `fixdt` function, such as `'fixdt(0,16,7)'`.

You can, with one exception, specify a nonstandard data type, e.g., a data type defined by a `Simulink.NumericType` object, by specifying the data type name. The exception is a `Simulink.NumericType` whose `DataTypeMode` is `Fixed-point: unspecified scaling`.

Note `Fixed-point: unspecified scaling` is a partially specified type whose definition is completed by the block that uses the `Simulink.NumericType`. Forbidding its use in alias types avoids creating aliases that have different base types depending on where they are used.

Corresponds to **Base type** in the property dialog box.

Example: 'int8'

Example: 'myOtherAlias'

Data Types: char | string

DataScope — Specification to generate or import type definition in the generated code

'Auto' (default) | 'Exported' | 'Imported'

Specification to generate or import the type definition (typedef) in the generated code (Simulink Coder), specified as 'Auto', 'Exported', or 'Imported'.

The table shows the effect of each option.

| Value | Action |
|------------------|---|
| 'Auto' (default) | If no value is specified for <code>HeaderFile</code> , export the type definition to <code>model_types.h</code> , where <code>model</code> is the model name. If you have an Embedded Coder license, and you have specified a data type replacement, then export the type definition to <code>rtwtypes.h</code> . If a value is specified for <code>HeaderFile</code> , import the data type definition from the specified header file. |
| 'Exported' | Export the data type definition to a header file, which can be specified in the <code>HeaderFile</code> property. If no value is specified for <code>HeaderFile</code> , the header file name defaults to <code>type.h</code> . <code>type</code> is the data type name. |
| 'Imported' | Import the data type definition from a header file, which can be specified in the <code>HeaderFile</code> property. If no value is specified for <code>HeaderFile</code> , the header file name defaults to <code>type.h</code> . <code>type</code> is the data type name. |

For more information, see “Control File Placement of Custom Data Types” (Embedded Coder).

Corresponds to **Data scope** in the property dialog box.

Description — Custom description of data type alias

'' (empty character vector) (default) | character vector

Custom description of the data type alias, specified as a character vector.

Corresponds to **Description** in the property dialog box.

Example: 'This type alias corresponds to a floating-point implementation.'

Data Types: char

HeaderFile — Name of header file that contains type definition in the generated code

'' (empty character vector) (default) | character vector

Name of the header file that contains the type definition (typedef) in the generated code, specified as a character vector.

If this property is specified, the specified name is used during code generation for importing or exporting. If this property is empty, the value defaults to `type.h` if `DataScope` equals 'Imported' or 'Exported', or defaults to `model_types.h` if `DataScope` equals 'Auto'.

By default, the generated `#include` directive uses the preprocessor delimiter " instead of < and >. To generate the directive `#include <myTypes.h>`, specify `HeaderFile` as '<myTypes.h>'.

For more information, see “Control File Placement of Custom Data Types” (Embedded Coder).

Corresponds to **Header file** in the property dialog box.

Example: 'myHdr.h'

Example: 'myHdr'

Example: 'myHdr.hpp'

Data Types: char

Examples

Create Alias for Enumerated Data Type

To create an alias for an enumerated type called `SLDemoSign`:

```
myEnumAlias = Simulink.AliasType('Enum: SLDemoSign');
```

Create Alias for Fixed-Point Data Type

To create an alias for a fixed-point data type by using a `Simulink.AliasType` object, set the `BaseType` property of the object by using a call to the `fixdt` function. The value of `BaseType` must be specified as a character vector.

For example, this code creates an alias for an unsigned fixed-point data type with word length 16 and fraction length 7.

```
myFixptAlias = Simulink.AliasType;  
myFixptAlias.BaseType = 'fixdt(0,16,7)';
```

Extended Capabilities

C/C++ Code Generation

Generate C and C++ code using MATLAB® Coder™.

A `Simulink.AliasType` object appears in the generated code as a `typedef` statement. The generated code uses the named type to define and declare data (variables).

The `Simulink.AliasType` class does not support multiword base data types for code generation.

Fixed-Point Conversion

Design and simulate fixed-point systems using Fixed-Point Designer™.

See Also

`Simulink.NumericType`

Topics

“Control Data Types of Signals”

“Control Data Type Names in Generated Code” (Embedded Coder)

“About Data Types in Simulink”

Introduced before R2006a

Simulink.BlockCompDworkData

Provide postcompilation information about block's DWork vector

Description

Simulink software returns an instance of this class when a MATLAB program, e.g., a Level-2 MATLAB S-function, invokes the “Dwork” on page 5-450 method of a block's run-time object after the model containing the block has been compiled.

Parent

Simulink.BlockData

Children

None

Property Summary

| Name | Description |
|---------------------------------|---|
| “Usage” on page 5-202 | Usage type of this DWork vector. |
| “UsedAsDiscState” on page 5-203 | True if this DWork vector is being used to store the values of a block's discrete states. |

Properties

Usage

Description

Returns a character vector indicating how this DWork vector is used. Permissible values are:

- DWork
- DState
- Scratch
- Mode

Data Type

character vector

Access

RW for MATLAB S-function blocks, RO for other blocks.

UsedAsDiscState**Description**

True if this DWork vector is being used to store the values of a block's discrete states.

Data Type

Boolean

Access

RW for MATLAB S-Function blocks, R0 for other blocks.

Introduced before R2006a

Simulink.BlockCompInputPortData

Provide postcompilation information about block input port

Description

Simulink software returns an instance of this class when a MATLAB program, e.g., a Level-2 MATLAB S-function, invokes the “InputPort” on page 5-451 method of a block's run-time object after the model containing the block has been compiled.

Parent

Simulink.BlockPortData

Children

None

Property Summary

| Name | Description |
|-----------------------------------|---|
| “DirectFeedthrough” on page 5-204 | True if this port has direct feedthrough. |
| “Overwritable” on page 5-204 | True if this port is overwritable. |

Properties

DirectFeedthrough

Description

True if this input port has direct feedthrough.

Data Type

Boolean

Access

RW for MATLAB S functions, RO for other blocks.

Overwritable

Description

True if this input port is overwritable.

Data Type

Boolean

Access

RW for MATLAB S functions, RO for other blocks.

Introduced before R2006a

Simulink.BlockCompOutputPortData

Provide postcompilation information about block output port

Description

Simulink software returns an instance of this class when a MATLAB program, e.g., a Level-2 MATLAB S-function, invokes the “OutputPort” on page 5-452 method of a block's run-time object after the model containing the block has been compiled.

Parent

Simulink.BlockPortData

Children

None

Property Summary

| Name | Description |
|--------------------------|--|
| “Reusable” on page 5-216 | Specifies whether an output port's memory is reusable. |

Properties

Reusable

Description

Specifies whether an output port's memory is reusable. Options are: `NotReusableAndGlobal` and `ReusableAndLocal`.

Data Type

character vector

Access

RW for MATLAB S functions, RO for other blocks.

Introduced before R2006a

Simulink.BlockData

Provide run-time information about block-related data, such as block parameters

Description

This class defines properties that are common to objects that provide run-time information about a block's ports and work vectors.

Parent

None

Children

Simulink.BlockPortData, Simulink.BlockCompDworkData

Property Summary

| Name | Description |
|--|---|
| "AliasedThroughDataType" on page 5-207 | Fundamental base data type. |
| "AliasedThroughDataTypeID" on page 5-208 | Fundamental base data type ID. |
| "Complexity" on page 5-208 | Numeric type (real or complex) of the block data. |
| "Data" on page 5-208 | The block data. |
| "DataAsDouble" on page 5-209 | The block data in double form. |
| "Datatype" on page 5-209 | Data type of the block data. |
| "DatatypeID" on page 5-209 | Index of the data type of the block data. |
| "Dimensions" on page 5-210 | Dimensions of the block data. |
| "Name" on page 5-210 | Name of the block data. |
| "Type" on page 5-210 | Type of block data (e.g., a parameter). |

Properties

AliasedThroughDataType

Description

Data type aliases allow a data type (B) to be recursively aliased to another alias type or `BaseType` (A). If alias type A is aliased to another alias type that is aliased to another alias type and so forth, this property allows the alias type to be iteratively searched (aliased through) until the type is no longer an alias type and that final result is the value of the property returned. For example, assume that you have created the Simulink Alias types A and B as follows:

```
A=Simulink.AliasType('double')
```

A =

```
Simulink.AliasType
    Description: ''
    HeaderFile: ''
    BaseType: 'double'
B=Simulink.AliasType('A')

B =
Simulink.AliasType
    Description: ''
    HeaderFile: ''
    BaseType: 'A'
```

If the data type of an item of block data is B, this property returns the base type A instead of B.

Data Type

character vector

Access

R0

AliasedThroughDataTypeID**Description**

Index of the data type alias returned by the `AliasedThroughDataType` property.

Data Type

integer

Access

R0

Complexity**Description**

Numeric type (real or complex) of the block data.

Data Type

character vector

Access

RW for MATLAB S functions, R0 for other blocks.

Data**Description**

The block data.

Data Type

The data type specified by the “Datatype” on page 5-209 or “DatatypeID” on page 5-209 properties of this object.

Access

RW

DataAsDouble**Description**

The block data's in double form.

Data Type

double

Access

R0

Datatype**Description**

Data type of the values of the block-related object.

Data Type

character vector

Access

R0

DatatypeID**Description**

Index of the data type of the values of the block-related object. enter the numeric value for the desired data type, as follows:

| Data Type | Value |
|-------------------------------------|-------|
| 'inherited' | -1 |
| 'double' | 0 |
| 'single' | 1 |
| 'int8' | 2 |
| 'uint8' | 3 |
| 'int16' | 4 |
| 'uint16' | 5 |
| 'int32' | 6 |
| 'uint32' | 7 |
| 'boolean' or fixed-point data types | 8 |

Data Type

integer

Access

RW for MATLAB S functions, R0 for other blocks

Dimensions**Description**

Dimensions of the block-related object, e.g., parameter or DWork vector.

Data Type

array

Access

RW for MATLAB S functions, R0 for other blocks

Name**Description**

Name of block-related object, e.g., a block parameter or DWork vector.

Data Type

character vector

Access

RW for MATLAB S functions, R0 for other blocks

Type**Description**

Type of block data. Possible values are:

| Type | Description |
|-------------------------------|--|
| 'BlockPreCompInputPortData ' | This object contains data for an input port before the model is compiled. |
| 'BlockPreCompOutputPortData ' | This object contains data for an output port before the model is compiled. |
| 'BlockCompInputPortData ' | This object contains data for an input port after the model is compiled. |
| 'BlockCompOutputPortData ' | This object contains data for an output port after the model is compiled. |
| 'BlockPreCompDworkData ' | This object contains data for a DWork vector before the model is compiled. |
| 'BlockCompDworkData ' | This object contains data for a DWork vector after the model is compiled. |
| 'BlockDialogPrmData ' | This object describes a dialog box parameter of a Level-2 MATLAB S-function. |

| Type | Description |
|---------------------------|--|
| 'BlockRuntimePrmData' | This object describes a run-time parameter of a Level-2 MATLAB S-function. |
| 'BlockCompContStatesData' | This object describes the continuous states of the block at the current time step. |
| 'BlockDerivativesData' | This object describes the derivatives of the block's continuous states at the current time step. |

Data Type

character vector

Access

R0

Introduced before R2006a

Simulink.BlockPortData

Describe block input or output port

Description

This class defines properties that are common to objects that provide run-time information about a block's ports.

Parent

Simulink.BlockData

Children

Simulink.BlockPreCompInputPortData, Simulink.BlockPreCompOutputPortData, Simulink.BlockCompInputPortData, Simulink.BlockCompOutputPortData

Property Summary

| Name | Description |
|---------------------------------|---|
| "IsBus" on page 5-212 | True if this port is connected to a bus. |
| "IsSampleHit" on page 5-212 | True if this port produces output or accepts input at the current simulation time step. |
| "SampleTime" on page 5-213 | Sample time of this port. |
| "SampleTimeIndex" on page 5-213 | Sample time index of this port. |

Properties

IsBus

Description

True if this port is connected to a bus.

Data Type

Boolean

Access

R0

IsSampleHit

Description

True if this port produces output or accepts input at the current simulation time step.

Data Type

Boolean

Access

R0

SampleTime**Description**

Sample time of this port.

Data Type

[period offset] where period and offset are values of type double. See “Specify Sample Time” for more information.

Access

RW for MATLAB S functions, R0 for other blocks

SampleTimeIndex**Description**

Sample time index of this port.

Data Type

integer

Access

R0

Introduced before R2006a

Simulink.BlockPreComplInputPortData

Provide precompilation information about block input port

Description

Simulink software returns an instance of this class when a MATLAB program, e.g., a Level-2 MATLAB S-function, invokes the “InputPort” on page 5-451 method of a block's run-time object before the model containing the block has been compiled.

Parent

Simulink.BlockPortData

Children

None

Property Summary

| Name | Description |
|-----------------------------------|---|
| “DirectFeedthrough” on page 5-214 | True if this port has direct feedthrough. |
| “Overwritable” on page 5-214 | True if this port is overwritable. |

Properties

DirectFeedthrough

Description

True if this input port has direct feedthrough.

Data Type

Boolean

Access

RW for MATLAB S functions, R0 for other blocks

Overwritable

Description

True if this input port is overwritable.

Data Type

Boolean

Access

RW for MATLAB S functions, RO for other blocks

Introduced before R2006a

Simulink.BlockPreCompOutputPortData

Provide precompilation information about block output port

Description

Simulink software returns an instance of this class when a MATLAB program, e.g., a Level-2 MATLAB S-function, invokes the “OutputPort” on page 5-452 method of a block's run-time object before the model containing the block has been compiled.

Parent

Simulink.BlockPortData

Children

none

Property Summary

| Name | Description |
|--------------------------|--|
| “Reusable” on page 5-216 | Specifies whether an output port's memory is reusable. |

Properties

Reusable

Description

Specifies whether an output port's memory is reusable. Options are: `NotReusableAndGlobal` and `ReusableAndLocal`.

Data Type

character vector

Access

RW for MATLAB S functions, RO for other blocks

Introduced before R2006a

Simulink.Breakpoint class

Package: Simulink

Store and share data for a breakpoint set, configure the data for ASAP2 and AUTOSAR code generation

Description

An object of the `Simulink.Breakpoint` class stores breakpoint set data for a lookup table. You can use that data in one or more Prelookup blocks. With the object, you can specify a data type and code generation settings for the breakpoint set and share the set between multiple lookup tables. Use `Simulink.Breakpoint` objects and `Simulink.LookupTable` objects to configure COM_AXIS code generation for calibration.

The code generated for a `Simulink.Breakpoint` object is an array or a structure with two fields. If you configure the object to appear as a structure, one field stores the specified breakpoint set data and one scalar field stores the number of elements in the breakpoint set data. You can configure the structure type name, the field name, and other characteristics by using the properties of the object.

To package lookup table and breakpoint set data into a single structure in the generated code, for example, for STD_AXIS code generation, use a `Simulink.LookupTable` object to store all of the data. See “Package Shared Breakpoint and Table Data for Lookup Tables”.

To subclass from `Simulink.Breakpoint` and inherit from this base class, type this syntax as the first line of your class definition file, where *myBreakpoint* is the name of your new class:

```
classdef myBreakpoint < Simulink.Breakpoint
```

For an example on subclassing, see “Define Data Classes”.

If you add properties to the subclass, you can see them by displaying the subclass object at the MATLAB command line. In the property dialog box, these properties display in a new tab.

Construction

`BpSet = Simulink.Breakpoint` returns a `Simulink.Breakpoint` object named `BpSet` with default property values.

To create a `Simulink.Breakpoint` object by using the Model Explorer, use the button  on the toolbar. The default name for the object is `Object`.

Property Dialog Box

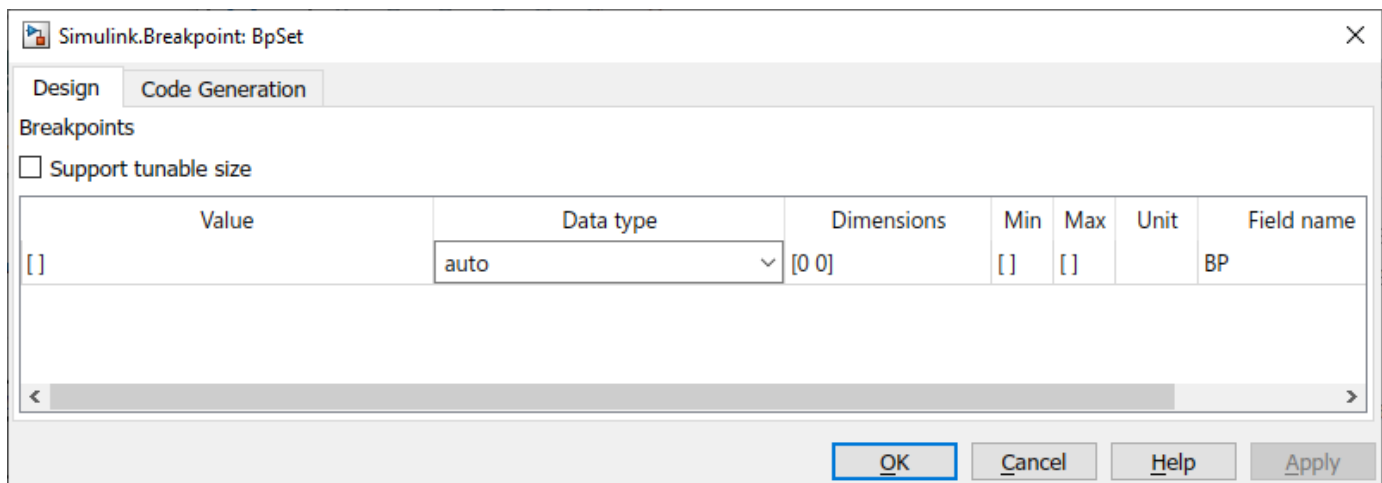

Breakpoints

The breakpoint set information. You can configure these characteristics:

Support tunable size

Specification to enable tuning the effective size of the table in the generated code. If you select this option, in the generated code, the `Simulink.Breakpoint` object appears as a structure variable. The structure has one field to store the breakpoint vector data and one field to store the number of elements in the breakpoint vector. You can change the value of the second field to adjust the effective size of the table.

If you clear this option, the `Simulink.Breakpoint` object appears in the generated code as a separate array variable instead of a structure.

Value

Breakpoint set data. Specify a vector with at least two elements.

You can also use an expression with mathematical operators such as `sin(1:0.5:30)` as long as the expression returns a numeric vector. When you click **Apply** or **OK**, the object executes the expression and uses the result to set the value of this property.

When you set **Data type** to `auto`, to set **Value**, use a typed expression such as `single([1 2 3])` or use the `fi` constructor to embed an `fi` object.

You can edit this data by using a more intuitive interface in a lookup table block. See “Import Lookup Table Data from MATLAB”.

Data type

Data type of the breakpoint set. The default setting is `auto`, which means that the breakpoint set acquires a data type from the value that you specify in **Value**. If you use an untyped expression such as `[1 2 3]` to set **Value**, the breakpoint data use the data type `double`. If you specify a typed expression such as `single([1 2 3])` or an `fi` object, the breakpoint data use the data type specified by the expression or object. Enumerated data types are also supported.

You can explicitly specify an integer data type, half data type, a floating-point data type, a fixed-point data type, or a data type expression such as the name of a `Simulink.AliasType` object.

For more information about data types in Simulink, see “Data Types Supported by Simulink”. To decide how to control the data types of table and breakpoint data in `Simulink.LookupTable` and `Simulink.Breakpoint` objects, see “Control Data Types of Lookup Table Objects” (Simulink Coder).

Dimensions

Dimension lengths of the breakpoint set.

To use symbolic dimensions, specify a character vector. See “Implement Dimension Variants for Array Sizes in Generated Code” (Embedded Coder).

Min

Minimum value of the elements in the breakpoint set. The default value is empty, `[]`. You can specify a numeric, real value.

For more information about how Simulink uses this property, see “Specify Minimum and Maximum Values for Block Parameters”.

Max

Maximum value of the elements in the breakpoint set. The default value is empty, `[]`. You can specify a numeric, real value.

For more information about how Simulink uses this property, see “Specify Minimum and Maximum Values for Block Parameters”.

Stored Int Min

For `Simulink.Breakpoint` objects with a fixed-point data type, the minimum value of the elements in the breakpoint set, specified as a stored integer value. The value is derived from the real-world value **Min**. This property is available only in the property dialog box.

Stored Int Max

For `Simulink.Breakpoint` objects with a fixed-point data type, the maximum value of the elements in the breakpoint set, specified as a stored integer value. The value is derived from the real-world value **Max**. This property is available only in the property dialog box.

Unit

Physical unit of the elements in the breakpoint set. You can specify text such as `degC`. See “Unit Specification in Simulink Models”.

Field name

Name of a structure field in the generated code. This field stores the breakpoint set data. The default value is `BP`. To change the field name, specify text.

This column appears only if you select **Support tunable size**.

Tunable size name

Name of a structure field in the generated code. This scalar field stores the length of the breakpoint set (the number of elements), which the generated code algorithm uses to determine the size of the table. To tune the effective size of the table during code execution, change the value of this structure field in memory. The default name is `N`. To change the field name, specify text.

This column appears only if you select **Support tunable size**.

Description

Description of the breakpoint set. You can specify text such as `This breakpoint set represents the pressure input`.

Data definition: Storage class

Storage class of the structure variable (if you select **Support tunable size**) or array variable in the generated code. The variable stores the breakpoint set data. The default setting is `Auto`.

For more information about storage classes, see “C Code Generation Configuration for Model Interface Elements” (Simulink Coder).

If you have Embedded Coder, you can choose a custom storage class. For information about custom storage classes, see “Organize Parameter Data into a Structure by Using Struct Storage Class” (Embedded Coder).

Data definition: Identifier

Alternative name for the variable in the generated code. The default value is empty, in which case the generated code uses the name of the `Simulink.Breakpoint` object as the name of the variable. To set the identifier, specify text.

To enable this property, set **Data definition: Storage class** to a setting other than `Auto`.

Data definition: Alignment

Data alignment boundary in the generated code. The starting memory address for the data allocated for the structure or array variable is a multiple of the value that you specify. The default value is `-1`, which allows the code generator to determine an optimal alignment based on usage.

Specify a positive integer that is a power of 2, not exceeding 128. For more information about using data alignment for code replacement, see “Data Alignment for Code Replacement” (Embedded Coder).

Struct Type definition: Name

Name of the structure type that the structure variable uses in the generated code. The default value is empty. Specify text.

This property appears only if you select **Support tunable size**.

Struct Type definition: Data scope

Scope of the structure type definition (imported from your handwritten code or exported from the generated code). The default value is `Auto`. When you select `Auto`:

- If you do not specify a value in the **Struct Type definition: Header file** box, the generated code exports the structure type definition to the file `model_types.h`. `model` is the name of the model.
- If you specify a value in the **Struct Type definition: Header file** box, such as `myHdr.h`, the generated code imports the structure type definition from `myHdr.h`.

To explicitly specify the data scope:

- To import the structure type definition into the generated code from your custom code, select `Imported`.
- To export the structure type definition from the generated code, select `Exported`.

If you do not specify a value in the **Struct Type definition: Header file** box, the generated code imports or exports the type definition from or to *StructName.h*. *StructName* is the name that you specify with the property **Struct Type definition: Name**.

This property appears only if you select **Support tunable size**.

Struct Type definition: Header file

Name of the header file that contains the structure type definition. You can import the definition from a header file that you create, or export the definition into a generated header file. To control the scope of the structure type, adjust the setting for the **Struct Type definition: Data scope** property.

This property appears only if you select **Support tunable size**.

Properties

Breakpoints — Breakpoint set data

`Simulink.lookuptable.Breakpoint` object

Breakpoint set data, specified as a `Simulink.lookuptable.Breakpoint` object. Use this embedded object to configure the structure field names and characteristics of the breakpoint set data such as breakpoint values, data type, and dimensions.

CoderInfo — Code generation settings for variable

`Simulink.CoderInfo` object

Code generation settings for the structure variable (if you set `SupportTunableSize` to `true`) or array variable (`false`) that stores the breakpoint set data, specified as a `Simulink.CoderInfo` object. You can specify a storage class or custom storage class by using this embedded object. For more information, see `Simulink.CoderInfo`.

StructTypeInfo — Settings for structure type in the generated code

`Simulink.lookuptable.StructTypeInfo` object

Settings for the structure type that the structure variable uses in the generated code, specified as a `Simulink.lookuptable.StructTypeInfo` object.

If you set `SupportTunableSize` to `false`, the `Simulink.Breakpoint` object does not appear in the generated code as a structure. The code generator ignores this property.

SupportTunableSize — Option to generate code that enables tunability of table size

`false` (default) | `true`

Option to generate code that enables tunability of the effective size of the table, specified as `true` or `false`. See the **Support Tunable Size** parameter.

Data Types: `logical`

Copy Semantics

Handle. To learn how handle classes affect copy operations, see [Copying Objects](#).

Examples

Share Breakpoint Data Between One-Dimensional Lookup Tables

- 1 Create a `Simulink.Breakpoint` object named `myBpSet`.

```
myBpSet = Simulink.Breakpoint
```

- 2 Specify the breakpoint data.

```
myBpSet.Breakpoints.Value = [-2 -1 0 1 2];
```

- 3 Create a `Simulink.LookupTable` object named `FirstLUTObj`.

```
FirstLUTObj = Simulink.LookupTable;
```

- 4 Specify the table data.

```
FirstLUTObj.Table.Value = [1.1 2.2 3.3 4.4 5.5];
```

- 5 Set first `FirstLUTObj` to Reference.

```
FirstLUTObj.BreakpointsSpecification = 'Reference';
```

- 6 Configure the lookup table object to refer to the breakpoint set object.

```
FirstLUTObj.Breakpoints = {'myBpSet'};
```

- 7 Create another `Simulink.LookupTable` object to store a different set of table data. Configure the lookup table object to refer to the same breakpoint set object.

```
SecondLUTObj = Simulink.LookupTable;
SecondLUTObj.Table.Value = [1.2 2.3 3.4 4.5 5.6];
SecondLUTObj.BreakpointsSpecification = 'Reference';
SecondLUTObj.Breakpoints = {'myBpSet'};
```

You can use `FirstLUTObj` and `SecondLUTObj` to specify the table data in two different Interpolation Using Prelookup blocks. Use `myBpSet` to specify the breakpoint set data in one or two Prelookup blocks that provide the inputs for the Interpolation Using Prelookup blocks.

Limitations

- You cannot use `Simulink.Breakpoint` objects or `Simulink.LookupTable` objects that refer to `Simulink.Breakpoint` objects as instance-specific parameter data for reusable components. For example, you cannot use one of these objects as:
 - A model argument in a model workspace or a model argument value in a Model block.
 - The value of a mask parameter on a CodeReuse Subsystem block.
 - The value of a mask parameter on a subsystem that you reuse by creating a custom library.

However, you can use standalone `Simulink.LookupTable` objects, which do not refer to `Simulink.Breakpoint` objects, in these ways.

- You cannot generate code according to the `FIX_AXIS` style.
- When blocks in a subsystem use `Simulink.LookupTable` or `Simulink.Breakpoint` objects, you cannot set data type override (see “Control Fixed-Point Instrumentation and Data Type Override”) only on the subsystem. Instead, set data type override on the entire model.

See Also

`Simulink.lookuptable.Breakpoint` | `Simulink.lookuptable.StructTypeInfo` |
`Simulink.lookuptable.Table` | `Simulink.Parameter` | `Simulink.LookupTable`

Topics

“Configure Lookup Tables for AUTOSAR Measurement and Calibration” (AUTOSAR Blockset)
“About Lookup Table Blocks”
“Package Shared Breakpoint and Table Data for Lookup Tables”
“Create Tunable Calibration Parameter in the Generated Code” (Simulink Coder)

Introduced in R2016b

Simulink.CodeImporter class

Package: Simulink

Import custom C/C++ code into Simulink

Description

Use the `Simulink.CodeImporter` class to import custom C/C++ code into Simulink for modeling, verification, and validation. Instances of this class are used to specify custom code to import into Simulink.

The `Simulink.CodeImporter` class is a handle class.

Creation

Description

`obj = Simulink.CodeImporter()` creates an instance of the `CodeImporter` with the `LibraryFileName` property set to "untitled".

`obj = Simulink.CodeImporter(LibName)`, where `LibName` is a file name chosen by the user and specified as a string or character vector, creates an instance of the `CodeImporter` with the `LibraryFileName` property set to `LibName`.

Properties

LibraryFileName — Name of Simulink library file and generated artifacts

"untitled" (default) | string | character vector

Name of Simulink library file and generated artifacts created for the imported code, specified as a string or a character vector. Name must be a valid MATLAB variable name. The same file name is used with different extensions for the data dictionary and other artifacts generated when code is imported.

Example: "pumpController"

Data Types: string | character vector

OutputFolder — Location of generated library file and generated artifacts

"" (default) | string | character vector

Location of generated library file and generated artifacts, specified as a string or a character vector. If left blank, the current MATLAB folder is used.

File locations that are part of the `CustomCode` property can be specified relative to this folder.

Example: "C:\HeatPump\Controller"

Data Types: string | character vector

CustomCode — Custom C or C++ code files and associated properties to import

CustomCode object

C or C++ code files and associated properties to import, specified as an object of class `Simulink.CodeImporter.CustomCode`. Use this property to specify code importing options, such as source and header files, folder paths, libraries, and compiler and linker flags. For information, see `Simulink.CodeImporter.CustomCode`.

```
%% Create code importer object
```

```
obj = Simulink.CodeImporter;
```

```
%% Set the custom code to import
```

```
obj.CustomCode.InterfaceHeaders = ["pumpController.h"];
```

```
obj.CustomCode.IncludePaths = ["/include"];
```

```
obj.CustomCode.SourceFiles = ["src/pumpController.c" "src/utils.c"];
```

```
obj.CustomCode
```

```
ans =
```

```
CustomCode with properties:
```

```

    SourceFiles: ["src/pumpController.c" "src/utils.c"]
  InterfaceHeaders: "pumpController.h"
    IncludePaths: "./include"
      Libraries: [1x0 string]
        Defines: [1x0 string]
      Language: "C"
    CompilerFlags: [1x0 string]
      LinkerFlags: [1x0 string]
GlobalVariableInterface: 0
  FunctionArrayLayout: NotSpecified
```

ParseInfo — Information regarding parsed custom code

Simulink.CodeImporter.ParseInfo object

Information regarding the parsed custom code, specified as an object of class `Simulink.CodeImporter.ParseInfo`. This property is read-only. Parsing needs to be successful to obtain information regarding custom code. For information, see `Simulink.CodeImporter.ParseInfo`.

Example:

```
s = obj.parse;
```

```
obj.ParseInfo
```

```
ans =
```

```
ParseInfo with properties:
```

```

      Success: 1
AvailableFunctions: ["Controller" "setFanTempThreshold" "setPumpTempThreshold"]
  EntryFunctions: ["Controller" "setFanTempThreshold" "setPumpTempThreshold"]
  AvailableTypes: "pump_control_bus"
      Errors: []
```

Options — Additional options used by Code Importer during import for library creation

Options object

Additional options used by Code Importer during import for library creation, specified as an object of class `Simulink.CodeImporter.Options`. Use this object to change the default values for the size of an argument passed by a pointer to a function, and the Simulink library browser name. For information, see `Simulink.CodeImporter.Options`.

Example:

```
>> obj.Options

ans =

Options with properties:

    PassByPointerDefaultSize: "-1"
        CreateTestHarness: 0
    LibraryBrowserName: ""

>> obj.Options.LibraryBrowserName = "Controller Library";
>> obj.Options

ans =

Options with properties:

    PassByPointerDefaultSize: "-1"
        CreateTestHarness: 0
    LibraryBrowserName: "Controller Library"
```

Methods

Public Methods

| | |
|--------------------------------------|--|
| <code>parse</code> | Analyze custom code for functions, types, global variables, and their dependencies |
| <code>import</code> | Import custom code, functions, and types into Simulink |
| <code>addToProject</code> | Add custom code and imported artifacts to MATLAB project |
| <code>view</code> | Launch Simulink Code Importer wizard |
| <code>save</code> | Save import settings to JSON format text file |
| <code>load</code> | Load import settings from saved import settings file |
| <code>computeInterfaceHeaders</code> | Compute interface headers from specified source files |

Examples

Import Custom Code

Specify location and options for custom code.

```
%% Create code importer object
obj = Simulink.CodeImporter('PumpController');

%% Set the custom code to import
obj.CustomCode.InterfaceHeaders = ["pumpController.h"];
obj.CustomCode.IncludePaths = ["/include"];
obj.CustomCode.SourceFiles = ["src/pumpController.c" "src/utils.c"];

%% Specify name for Library Browser
obj.Options.LibraryBrowserName = "Controller Library";
```

Parse custom code and examine results.

```
%% Parse custom code
s = obj.parse;
obj.ParseInfo

ans =

    ParseInfo with properties:

        Success: 1
    AvailableFunctions: ["Controller"      "setFanTempThreshold"      "setPumpTempThreshold"]
    EntryFunctions: ["Controller"      "setFanTempThreshold"      "setPumpTempThreshold"]
    AvailableTypes: "pump_control_bus"
    Errors: []
```

Import parsed code into Simulink

```
%% Import code
s = obj.import;
```

See Also

[Simulink.CodeImporter.CustomCode](#) | [Simulink.CodeImporter.Options](#) | [Simulink.CodeImporter.ParseInfo](#) | [Simulink.CodeImporter.Function](#) | [Simulink.CodeImporter.SimulinkPortSpecification](#)

Topics

“Import Custom C/C++ Code Using the Simulink Code Importer”

Introduced in R2021a

Simulink.CodeImporter.CustomCode class

Package: Simulink.CodeImporter

Specify custom code settings for Simulink.CodeImporter and sltest.CodeImporter classes

Description

The Simulink.CodeImporter.CustomCode class is a handle class.

Creation

When you create an object of class Simulink.CodeImporter, an object of class Simulink.CodeImporter.CustomCode is automatically created as the CustomCode property of that object. Do not create an object of class Simulink.CodeImporter.CustomCode directly.

Properties

Note The first four properties listed below (SourceFiles, InterfaceHeaders, IncludePaths, and Libraries) let you specify file path information about the location of your custom code. To enable portability, specify this information as a file path relative to the folder specified in the OutputFolder property of the relevant Simulink.CodeImporter object rather than as an absolute path.

SourceFiles — Source files to be imported

cell array of character vectors | string array

Source files to be imported, specified as a cell array of character vector or a string array. Supported files include .c and .cpp files. Each file name can be specified as a path relative to the folder specified in the OutputFolder property of the relevant Simulink.CodeImporter object or as an absolute path.

Providing a value for SourceFiles is optional for Simulink.CodeImporter and optional for sltest.CodeImporter when the TestType is IntegrationTest.

Example: {'foo.c', 'bar.c'}

Example: ['.\\foo.c', '..\\bar.c']

Example: fullfile(pwd, 'Src', 'foo.c')

Data Types: cell array of character vectors | string array

InterfaceHeaders — Interface headers to be imported

cell array of character vectors | string array

Interface headers to be imported, specified as a cell array of character vectors or a string array. Supported files include .h and .hpp files. Each file name can be specified as a path relative to the folder specified in the OutputFolder property of the relevant Simulink.CodeImporter object or

as an absolute path. Interface headers should contain the function declarations and type definitions that you want to bring into Simulink. These declarations and definitions are usually contained in the export header of your C code library.

Example: {'foo.h', 'bar.h'}

Example: [".\foo.h", "..\bar.h"]

Example: fullfile(pwd, 'Hdr', 'foo.h')

Data Types: cell array of character vectors | string array

IncludePaths — Folders containing included header files

cell array of character vectors | string array

Folders containing included header files for the parser to find, specified as a cell array of character vectors or a string array. Each folder path can be specified as a path relative to the folder specified in the `OutputFolder` property of the relevant `Simulink.CodeImporter` object or as an absolute path.

Example: {'.', '..\..\'}

Example: [".\Include1", "..\Include2"]

Example: fullfile(pwd, 'Include1')

Data Types: cell array of character vectors | string array

Libraries — Libraries that contain custom object code to link

cell array of character vectors | string array

Libraries that contain custom object code to link, specified as a cell array of character vectors or a string array. Supported files include `.obj`, `.dll`, `.lib`, `.so`, `.o`, `.a`, and `.dylib` files. Each file name can be specified as a path relative to the folder specified in the `OutputFolder` property of the relevant `Simulink.CodeImporter` object or as an absolute path.

Providing libraries is optional.

Example: {'foo.lib', 'foo.dll'}

Example: [".\foo.so", "..\bar.so"]

Data Types: cell array of character vectors | string array

Defines — Preprocessor macro definitions to be added to the compiler command line

cell array of character vectors | string array

Preprocessor macro definitions to be added to the compiler command line, specified as a cell array of character vectors or a string array. `'-D'` is optional in defines.

Example: {'-D DEF1', '-D DEF2'}

Example: ["DEF1", "DEF2"]

Data Types: cell array of character vectors | string array

Language — Custom code language

'C' (default) | 'C++'

Custom code language, specified as `'C'` or `'C++'`. C and C++ are the only supported languages.

Data Types: character vector | string scalar

CompilerFlags — Additional compiler flags

cell array of character vectors | string array

Additional compiler flags to be added to the compiler command line, specified as a cell array of character vectors or a string array.

Example: {'/O2' , '/Og'}

Example: "-g"

Data Types: cell array of character vectors | string array

LinkerFlags — Additional linker flags

cell array of character vectors | string array

Additional linker flags to be added to the linker command line, specified as a cell array of character vectors or a string array.

Example: {'/WX'}

Data Types: cell array of character vectors | string array

GlobalVariableInterface — Option to enable global variables as function interfaces

false (default) | true

Option to enable global variables as function interfaces, specified as a logical scalar. If set to true, global variables accessed by the custom code functions will be treated as function interfaces in the generated Simulink library. See “Call C Caller Block and Specify Ports” and “Enable global variables as function interfaces”.

Data Types: logical scalar

FunctionArrayLayout — Default array layout for custom code functions

NotSpecified (default) | RowMajor | ColumnMajor | Any

Default array layout for custom code functions to use to access input argument arrays, specified as **NotSpecified**, **RowMajor**, **ColumnMajor**, or **Any**. You can override the default for an individual function by using the `ArrayLayout` property of the `Simulink.CodeImporter.Function` object corresponding to that function. Matrix data passed to and from your C functions is converted to the function array layout you specify. See “Integrate C Code Using C Caller Blocks” and “Default function array layout”.

Data Types: enum

Examples

Specify Custom Code for Import

Create an object of class `Simulink.CodeImporter`. Set the properties of its `CustomCode` property to specify custom code to import into Simulink.

```
obj = Simulink.CodeImporter("pumpController");
```

```
obj.OutputFolder = ".";
```

```
obj.CustomCode.InterfaceHeaders = ["pumpController.h"];  
obj.CustomCode.IncludePaths = ["/include"];  
obj.CustomCode.SourceFiles = ["src/pumpController.c" "src/utils.c"];
```

See Also

[Simulink.CodeImporter](#) | [Simulink.CodeImporter.Options](#) |
[Simulink.CodeImporter.ParseInfo](#) | [Simulink.CodeImporter.Function](#) |
[Simulink.CodeImporter.SimulinkPortSpecification](#)

Introduced in R2021a

Simulink.CodeImporter.Options class

Package: Simulink.CodeImporter

Specify additional import options for Simulink.CodeImporter and sltest.CodeImporter classes

Description

Use the Simulink.CodeImporter class to specify options for importing custom code beyond what is specified in the CustomCode property of the relevant Simulink.CodeImporter object.

The Simulink.CodeImporter.Options class is a handle class.

Creation

When you create an object of class Simulink.CodeImporter, an object of class Simulink.CodeImporter.Options is automatically created as the Options property of that object. Do not create an object of class Simulink.CodeImporter.Options directly.

Properties

PassByPointerDefaultSize — Default size of C argument passed by pointer to function

'-1' (default) | character vector | string scalar

Default size of C argument passed by pointer to function in the generated C Caller block port specifications, specified as a character vector or string scalar. By default, the value is set to '-1', meaning that the size is inherited. A value of '1' indicates that arguments passed by address to functions are scalars, unless you override this setting in the Simulink.CodeImporter.SimulinkPortSpecification corresponding to a particular function.

Data Types: character vector | string scalar

CreateTestHarness — Automatic creation of test harness during import

true (default) | false

Automatic creation of test harness during import, specified as a logical scalar. Specify whether the Simulink Code Importer should automatically create a test harness for each block in the generated Simulink library (Simulink Test license required).

Data Types: logical

LibraryBrowserName — Name by which generated Simulink library appears in Simulink Library Browser

"" (default) | character vector | string scalar

Name by which generated Simulink library appears in Simulink Library Browser, specified as a character vector or string scalar. By default, the value is an empty string, meaning that the generated library does not appear in the Simulink Library Browser. If you specify a name, the Simulink Code Importer generates the file slblocks.m as part of the artifacts the Code Importer creates.

Example: "Controller Library"

Data Types: character vector | string scalar

Examples

Set Custom Code Options

Create a `Simulink.CodeImporter` object and set options.

```
obj = Simulink.CodeImporter;  
obj.CustomCode.InterfaceHeaders = ["pumpController.h"];  
obj.CustomCode.IncludePaths = [".include"];  
obj.CustomCode.SourceFiles = ["src/pumpController.c" "src/utils.c"];  
obj.Options.LibraryBrowserName="Controller Library";
```

`obj.Options`

ans =

Options with properties:

```
PassByPointerDefaultSize: "-1"  
CreateTestHarness: 0  
LibraryBrowserName: "Controller Library"
```

See Also

`Simulink.CodeImporter` | `Simulink.CodeImporter.CustomCode` |
`Simulink.CodeImporter.ParseInfo` | `Simulink.CodeImporter.Function` |
`Simulink.CodeImporter.SimulinkPortSpecification`

Introduced in R2021a

Simulink.CodeImporter.ParseInfo class

Package: Simulink.CodeImporter

Information about parsed custom code

Description

The `Simulink.CodeImporter.ParseInfo` class has read-only properties that store more information about the parsed custom code. Parsing needs to be successful to obtain information regarding custom code.

The `Simulink.CodeImporter.ParseInfo` class is a handle class.

Creation

When you create an object of class `Simulink.CodeImporter`, an object of class `Simulink.CodeImporter.ParseInfo` is automatically created as the `ParseInfo` property of that object. Do not create an object of class `Simulink.CodeImporter.ParseInfo` directly.

Properties

Success — Whether parsing of custom code is successful

`true` | `false`

Whether parsing of custom code is successful, specified as a logical scalar with value `false` before successful parsing of specified custom code, then `true` after successful parsing.

Data Types: `logical` scalar

AvailableFunctions — Functions compatible with Simulink in custom code

string array

Functions compatible with Simulink in custom code, returned as a string array.

Example: `["myCustomFcn1", "myCustomFcn2", "myCustomFcn3"]`

Data Types: `string` array

EntryFunctions — Entry-point functions in custom code

string array

Entry-point functions in custom code, returned as a string array. Entry-point functions are not called by other custom code functions. `EntryFunctions` is a subset of `AvailableFunctions`.

Example: `["myCustomFcn1", "myCustomFcn3"]`

Data Types: `string` array

AvailableTypes — Data types compatible with Simulink in custom code

string array

Data types compatible with Simulink in custom code, returned as a string array. Types are user-defined, such as struct and enum.

Example: ["myStruct1", "myStruct2"]

Data Types: string array

Errors — Error messages from failed parse

character vector

Error messages from failed parse of the specified custom code (Success is equal to false), returned as a character vector. Multiple error message are concatenated into a single character vector. If the parsing is successful (Success is equal to true), Errors is a null vector.

Data Types: character vector

Methods

Public Methods

Simulink.CodeImporter.ParseInfo.getFunctions Obtain detailed information regarding functions in custom code

Examples

Parse Custom Code

```
obj = Simulink.CodeImporter;

%% Set library file name and output folder
obj.LibraryFileName = "pumpController";
obj.OutputFolder = ".";

%% Set the custom code to import
obj.CustomCode.InterfaceHeaders = ["pumpController.h"];
obj.CustomCode.IncludePaths = [".include"];
obj.CustomCode.SourceFiles = ["src/pumpController.c" "src/utils.c"];
obj.parse;
obj.ParseInfo

ans =

    ParseInfo with properties:

        Success: 1
    AvailableFunctions: ["Controller"      "setFanTempThreshold"      "setPumpTempThreshold"]
    EntryFunctions: ["Controller"      "setFanTempThreshold"      "setPumpTempThreshold"]
    AvailableTypes: "pump_control_bus"
    Errors: []
```

See Also

`Simulink.CodeImporter` | `Simulink.CodeImporter.CustomCode` |
`Simulink.CodeImporter.Options` | `Simulink.CodeImporter.Function` |
`Simulink.CodeImporter.SimulinkPortSpecification`

Introduced in R2021a

addToProject

Package: Simulink

Add custom code and imported artifacts to MATLAB project

Syntax

```
success = obj.addToProject(ProjectFilePath)
```

Description

`success = obj.addToProject(ProjectFilePath)`, where `obj` is an object of class `Simulink.CodeImporter` or `sltest.CodeImporter`, adds the specified custom C/C++ code and the artifacts generated when importing custom code (using the `import` method) to an existing MATLAB project. Generated artifacts include a Simulink library and a data dictionary, and for objects of class `sltest.CodeImporter`, a sandbox folder. If you choose to generate a test harness and test files for the imported blocks, generated artifacts also include Simulink Test files (Simulink Test license required).

Invoke `addToProject` only after a successful import of custom code.

Input Arguments

ProjectFilePath — Name of existing MATLAB project

character vector | string scalar

Name of existing MATLAB project, specified as a character vector or string scalar. The path can be a full path or a path relative to the current MATLAB folder. For `addToProject` to be successful, all custom code files and the Simulink library and other generated artifacts must be located in either the same folder as the MATLAB project or in direct or indirect subfolders of that folder.

Data Types: character vector | string scalar

Output Arguments

success — Success indicator

logical scalar

Success indicator of whether code and artifacts are added to project, returned as a logical scalar. If not successful, Simulink throws an error.

See Also

`Simulink.CodeImporter`

Introduced in R2021a

import

Package: Simulink

Import custom code, functions, and types into Simulink

Syntax

```
success = obj.import()  
success = obj.import(Name1,Value1,...,NameN,ValueN)
```

Description

`success = obj.import()`, where `obj` is an object of class `Simulink.CodeImporter`, parses the specified custom code and imports it into Simulink with default import options. If the custom code was not previously parsed or if the custom code or the settings of `obj.CustomCode` have changed since the custom code was parsed, then the `ParseInfo` property of `obj` is populated or repopulated with the information resulting from the parse.

`success = obj.import(Name1,Value1,...,NameN,ValueN)` parses the specified custom code and imports it into Simulink with options based on the specified name-value arguments.

Examples

Import Custom Code

Specify location and options for custom code, then import the code into Simulink.

```
%% Create code importer object  
obj = Simulink.CodeImporter;  
  
%% Set library file name and output folder  
obj.LibraryFileName = "pumpController";  
obj.OutputFolder = ".";  
  
%% Set the custom code to import  
obj.CustomCode.InterfaceHeaders = ["pumpController.h"];  
obj.CustomCode.IncludePaths = ["/include"];  
obj.CustomCode.SourceFiles = ["src/pumpController.c" "src/utils.c"];  
  
%% Parse custom code and configure function  
obj.parse();  
fcn = obj.ParseInfo.getFunctions("Controller");  
fcn.PortSpecification.ReturnArgument.Label = "control_out";  
  
%% Import function "Controller"  
obj.import('Functions', ["Controller"]);
```

Input Arguments

Name-Value Pair Arguments

Specify optional comma-separated pairs of `Name`, `Value` arguments. `Name` is the argument name and `Value` is the corresponding value. `Name` must appear inside quotes. You can specify several name and value pair arguments in any order as `Name1, Value1, ..., NameN, ValueN`.

Example: `obj.import('Functions', ["Controller"], 'EntryFunctionsOnly', 'On');`

EntryFunctionsOnly — Option to limit import to entry-point functions

'On' (default) | 'Off'

Option to limit import to entry-point functions, specified as 'On' or 'Off'. If specified as 'On', only entry-point functions from the custom code, that is, functions not called by other functions in the custom code, are imported into the Simulink library. Otherwise, all available custom code functions are imported.

Data Types: char | string

Functions — Functions to import

"" (default) | cell array of character vectors | string array

Functions to import, specified as a cell array of character vectors or a string array. Specify this argument to limit import to the named custom code functions. Otherwise, all available custom code functions or all available entry-point custom code functions are imported.

Data Types: char | string

Types — Additional types to import

"" (default) | cell array of character vectors | string array

Additional types to import, specified as a cell array of character vectors or a string array. All types required by the imported functions are imported. Additional types are defined in the interface headers.

Data Types: char | string

Overwrite — Option to overwrite existing Simulink library

'Off' (default) | 'On'

Option to overwrite existing Simulink library with the same name as the name specified in the `LibraryFileName` property, specified as 'On' or 'Off'. If set to 'Off' and there is an existing Simulink library with the same name, custom code is imported into the existing library without changing block settings applied in the library after previous imports of custom code. If set to 'On', the existing library is overwritten by the library created from the custom code import, and any prior changes to the existing library are lost. If there is no existing Simulink library with the same name, a new library is created.

Data Types: char | string

AddToProject — Option to add custom code and generated artifacts to existing MATLAB project

project file path

Option to add custom code and generated artifacts to existing MATLAB project, specified as a file path. Artifacts include a library file for imported functions and a data dictionary for imported types. If `obj.Options.CreateTestHarness` is set to `true` and Simulink Test is installed, artifacts also include a Simulink Test file.

Data Types: `char` | `string`

Output Arguments

success — Whether import is successful

logical scalar

Whether import is successful, specified as a logical scalar. Simulink throws an exception if the import is unsuccessful.

See Also

`Simulink.CodeImporter.ParseInfo` | `Simulink.CodeImporter.Options` |
`Simulink.CodeImporter.CustomCode` | `Simulink.CodeImporter`

Introduced in R2021a

parse

Package: Simulink

Analyze custom code for functions, types, global variables, and their dependencies

Syntax

```
success = obj.parse()
success = obj.parse('Force', 'On')
success = obj.parse('Force', 'Off')
```

Description

`success = obj.parse()`, where `obj` is an object of `Simulink.CodeImporter` or `sltest.CodeImporter` class, parses the custom code, but does not re-parse the custom code if the custom code has been parsed previously and neither the custom code nor the settings of `obj.CustomCode` have changed since the previous parse. Results of a successful parse or error information from an unsuccessful parse are stored in the `ParseInfo` property of `obj`.

`success = obj.parse('Force', 'On')` parses the custom code irrespective of whether any changes have been made since a previous parse.

`success = obj.parse('Force', 'Off')` has the same effect as `success = obj.parse()`.

Examples

Parse Custom Code

```
%% Create code importer object
obj = Simulink.CodeImporter;

%% Set the custom code to import
obj.CustomCode.InterfaceHeaders = ["pumpController.h"];
obj.CustomCode.IncludePaths = [".\include"];
obj.CustomCode.SourceFiles = ["src/pumpController.c" "src/utils.c"];

%% Parse custom code
s = obj.parse;
obj.ParseInfo

ans =

    ParseInfo with properties:

        Success: 1
    AvailableFunctions: ["Controller"      "setFanTempThreshold"      "setPumpTempThreshold"]
        EntryFunctions: ["Controller"      "setFanTempThreshold"      "setPumpTempThreshold"]
        AvailableTypes: "pump_control_bus"
        Errors: []
```

Output Arguments

success — Indicator of whether parsing is successful

logical scalar

Indicator of whether parsing is successful, returned as a logical scalar. Simulink throws an exception if parsing is unsuccessful.

See Also

`Simulink.CodeImporter`

Introduced in R2021a

view

Package: Simulink

Launch Simulink Code Importer wizard

Syntax

`obj.view`

Description

`obj.view`, where `obj` is an object of `Simulink.CodeImporter` class, launches the Simulink Code Importer wizard, a graphical user interface for the Simulink Code Importer. A series of screens leads you through the process of creating a Simulink library from your custom code.

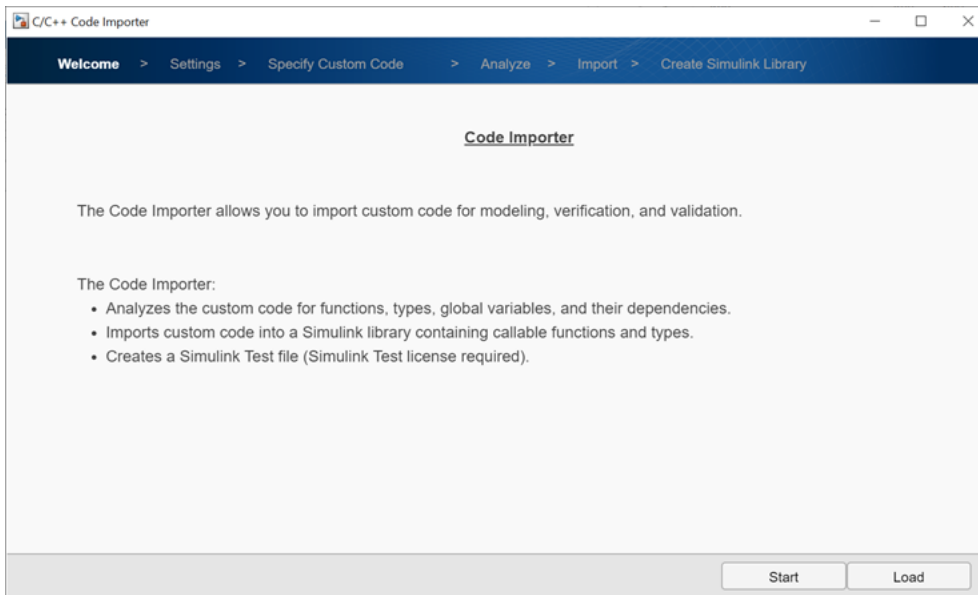

Note You can also launch the Simulink Code Importer wizard from within Simulink. On the Simulink toolstrip, go to the **Modeling** tab. From **Design**, select Code Importer.

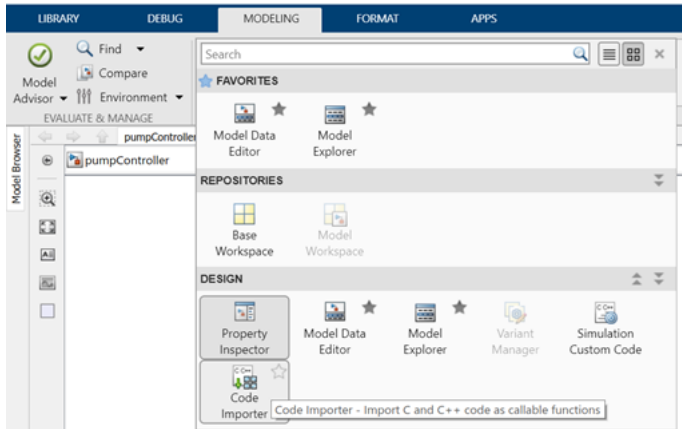

See Also

`Simulink.CodeImporter`

Introduced in R2021a

save

Save import settings to JSON format text file

Syntax

```
filepath = obj.save(filename)
filepath = obj.save(filename, 'Overwrite', 'Off')
filepath = obj.save(filename, 'Overwrite', 'On')
```

Description

`filepath = obj.save(filename)` or `filepath = obj.save(filename, 'Overwrite', 'Off')`, where `obj` is an object of class `Simulink.CodeImporter`, saves import settings in JSON format to the specified file `filename` and returns the full path to the saved file. Import settings include `LibraryFileName`, `OutputFolder`, `CustomCode`, `Options`, selected functions and types, and function configurations. You can subsequently load the settings from this file using the `load` method.

`filepath = obj.save(filename, 'Overwrite', 'On')` overwrites the specified file `filename` if the file already exists.

Input Arguments

filename — Name or path of file to be used to save import settings

character vector | string scalar

Name or path of file to be used to save import settings, specified as a character vector or string scalar.

Example: `'importsettings.json'`

Data Types: `char` | `string`

Output Arguments

filepath — Full path to saved file

character vector

Full path to saved file, returned as a character vector.

See Also

`Simulink.CodeImporter`

Introduced in R2020a

load

Load import settings from saved import settings file

Syntax

```
success = obj.load(filename)
```

Description

`success = obj.load(filename)`, where `obj` is an object of class `Simulink.CodeImporter`, loads import settings from a saved import settings JSON file, `filename`, created using the `save` method.

Input Arguments

filename — Name or path of file with saved import settings

character vector | string scalar

Name or path of JSON file with saved import settings, specified as a character vector or string scalar.

Example: `'importsettings.json'`

Data Types: `char` | `string`

Output Arguments

success — Indicator of whether loading import settings is successful

logical scalar

Indicator of whether loading import settings is successful, returned as a logical scalar.

See Also

`Simulink.CodeImporter`

Introduced in R2020a

computeInterfaceHeaders

Class: Simulink.CodeImporter

Package: Simulink

Compute interface headers from specified source files

Syntax

```
listOfHdr = obj.computeInterfaceHeaders()
```

Description

`listOfHdr = obj.computeInterfaceHeaders()`, where `obj` is an object of class `Simulink.CodeImporter`, computes the interface header information for the custom code specified in the `CustomCode` of `obj`.

Output Arguments

listOfHdr — List of interface header files

string array

List of interface header files computed from specified custom code, returned as a string array. This value can be used to populate the `InterfaceHeader` property of the `CustomCode` property of `obj`.

See Also

`Simulink.CodeImporter` | `Simulink.CodeImporter.CustomCode`

Introduced in R2021b

Simulink.CodeImporter.ParseInfo.getFunctions

Package: Simulink.CodeImporter

Obtain detailed information regarding functions in custom code

Syntax

```
fcnobjs = obj.ParseInfo.getFunctions()
fcnobjs = obj.ParseInfo.getFunctions(fcnlist)
```

Description

`fcnobjs = obj.ParseInfo.getFunctions()`, where `obj` is an object of class `Simulink.CodeImporter` or `sltest.CodeImporter`, returns an array of objects of class `Simulink.CodeImporter.Function` with detailed information on all Simulink compatible functions in the custom code.

Note If your code has a function with a pointer output, specify the size of the output by setting the port specification in the returned function object.

`fcnobjs = obj.ParseInfo.getFunctions(fcnlist)` returns an array of objects of class `Simulink.CodeImporter.Function` with detailed information on the custom code functions specified in `fcnlist`.

Examples

Get Custom Code Function Information

Specify and parse custom code, then query information regarding custom code functions.

```
obj = Simulink.CodeImporter;

%% Set library file name and output folder
obj.LibraryFileName = "pumpController";
obj.OutputFolder = ".";

%% Set the custom code to import
obj.CustomCode.InterfaceHeaders = ["pumpController.h"];
obj.CustomCode.IncludePaths = [".include"];
obj.CustomCode.SourceFiles = ["src/pumpController.c" "src/utils.c"];

%% Parse code
obj.parse;
parseobj = obj.ParseInfo

ans =

    ParseInfo with properties:
```

```

        Success: 1
    AvailableFunctions: ["Controller"      "setFanTempThreshold"      "setPumpTempThreshold"]
    EntryFunctions: ["Controller"      "setFanTempThreshold"      "setPumpTempThreshold"]
    AvailableTypes: "pump_control_bus"
    Errors: []

fcnobjs = parseobj.getFunctions()
fcnobjs =

    1×3 Function array with properties:

        Name
        CPrototype
        PortSpecification
        IsEntry
        IsDefined
        IsStub
        ArrayLayout
        IsDeterministic

>> fcnobjs(1)
ans =

    Function with properties:

        Name: "Controller"
        CPrototype: "pump_control_bus Controller(real_T Tset, real_T Troom_in);"
        PortSpecification: [1×1 Simulink.CodeImporter.SimulinkPortSpecification]
        IsEntry: 1
        IsDefined: 1
        IsStub: 0
        ArrayLayout: NotSpecified
        IsDeterministic: 0

```

Input Arguments

fcnlist — Names of functions

cell array of character vectors | string array

Names of functions in custom code about which to obtain information, specified as a cell array of character vectors or a string array. **fcnlist** must be limited to names contained in `obj.ParseInfo.AvailableFunctions`, that is, functions compatible with Simulink in the specified custom code.

Data Types: cell array of character vectors | string array

Output Arguments

fcnobjs — Information about functions in custom code

array of `Simulink.CodeImporter.Function` objects

Information about functions in custom code, returned as an array of `Simulink.CodeImporter.Function` objects, where each object corresponds to one function. Each

object includes the function name, C prototype, port specification, whether function is an entry-point function, and whether function is defined in the custom code. See `Simulink.CodeImporter.Function`.

See Also

`Simulink.CodeImporter.ParseInfo` | `Simulink.CodeImporter`

Introduced in R2021a

Simulink.CodeImporter.Function class

Package: Simulink.CodeImporter

Access and configure detailed information about parsed custom code functions

Description

Access detailed information about parsed custom code functions obtained from `Simulink.CodeImporter` or `sltest.CodeImporter` class instance. Configure information about custom code functions for importing into Simulink.

The `Simulink.CodeImporter.Function` class is a handle class.

Creation

One or more objects of this class are automatically created when you invoke the `getFunctions` method of an object of class `Simulink.CodeImporter.ParseInfo`. A `Simulink.CodeImporter.Function` object is created for each function in the parsed custom code for which `getFunctions` is invoked. Do not create an object of class `Simulink.CodeImporter.Function` directly.

Properties

Name — Function name

string scalar

Function name, returned as a string scalar.

Example: "Controller"

Data Types: string scalar

CPrototype — C prototype

string scalar

C prototype for function, returned as a string scalar.

Example: "pump_control_bus Controller(real_T Tset, real_T Troom_in);"

Data Types: string scalar

PortSpecification — Port specification of function

SimulinkPortSpecification object

Port specification of function, specified as an object of class `Simulink.CodeImporter.SimulinkPortSpecification`.

IsEntry — Whether function is entry-point function

logical scalar

Whether function is an entry-point function, returned as a logical scalar. An entry-point function is not called by other functions in the custom code.

IsDefined — Whether function is defined

logical scalar

Whether function is defined, returned as a logical scalar. This scalar indicates whether custom code contains a function body defining the function in addition to a function prototype defined in a header.

IsDeterministic — Whether function is deterministic

logical scalar

Whether function is deterministic, specified as a logical scalar. A deterministic function always produces the same outputs for the same input values. Specifying a function as deterministic enables the corresponding C Caller block to be used in a For Each subsystem and with continuous sample time, and optimizes the use of the block in conditional input branch execution. See “Deterministic functions”.

IsStub — Whether function is stubbed

logical scalar

Whether function is stubbed, returned as a logical scalar. This scalar indicates whether, for a unit test, a stub for undefined symbols was generated for the function (Simulink Test license required).

ArrayLayout — Array layout for function

NotSpecified (default) | ColumnMajor | RowMajor | Any

Array layout for function, returned as NotSpecified, ColumnMajor, RowMajor, or Any. If NotSpecified, then the default setting for the custom code as specified in the FunctionArrayLayout property of the relevant SimulinkCode.CustomCode object is used. Otherwise, the value specified for the function overrides the default.

Data Types: enum

Methods

Public Methods

| | |
|-----------------|--|
| gotoDefinition | Display function definition in the MATLAB editor with function name highlighted. Syntax: fcobj.gotoDefinition or fcobj.gotoDefinition(), where fcobj is an object of class Function |
| gotoDeclaration | Display function declaration in MATLAB editor with function name highlighted. Syntax: fcobj.gotoDeclaration or fcobj.gotoDeclaration(), where fcobj is an object of class Function |

Examples

Parse Custom Code Functions

Specify and parse custom code, then query information regarding custom code functions.

```
obj = Simulink.CodeImporter;

%% Set library file name and output folder
obj.LibraryFileName = "pumpController";
obj.OutputFolder = ".";

%% Set the custom code to import
obj.CustomCode.InterfaceHeaders = ["pumpController.h"];
obj.CustomCode.IncludePaths = ["/include"];
obj.CustomCode.SourceFiles = ["src/pumpController.c" "src/utils.c"];

%% Parse code
obj.parse;
parseobj = obj.ParseInfo

ans =

    ParseInfo with properties:

        Success: 1
    AvailableFunctions: ["Controller"      "setFanTempThreshold"      "setPumpTempThreshold"]
    EntryFunctions: ["Controller"      "setFanTempThreshold"      "setPumpTempThreshold"]
    AvailableTypes: "pump_control_bus"
    Errors: []

fcnobj = parseobj.getFunctions(["Controller"])

fcnobj =

    Function with properties:

        Name: "Controller"
    CPrototype: "pump_control_bus Controller(real_T Tset, real_T Troom_in);"
    PortSpecification: [1x1 Simulink.CodeImporter.SimulinkPortSpecification]
    IsEntry: 1
    IsDefined: 1
    IsStub: 0
    ArrayLayout: NotSpecified
    IsDeterministic: 0
```

See Also

[Simulink.CodeImporter](#) | [Simulink.CodeImporter.CustomCode](#) |
[Simulink.CodeImporter.Options](#) | [Simulink.CodeImporter.ParseInfo](#) |
[Simulink.CodeImporter.SimulinkPortSpecification](#)

Introduced in R2021a

Simulink.CodeImporter.SimulinkPortSpecification class

Package: Simulink.CodeImporter

Configure port specification for imported custom code

Description

Configure port specification for custom code function arguments imported as C Caller blocks via `Simulink.CodeImporter` or `sltest.CodeImporter` class instances, that is, configure how C/C++ interfaces map to Simulink interfaces for custom code functions.

This class is analogous to the `FunctionPortSpecification` class that is used to configure C Caller block properties outside the context of the Simulink Code Importer. The properties and methods of this class behave similarly to the like-named properties and methods of the `FunctionPortSpecification` class.

The `SimulinkPortSpecification` class is a handle class.

Creation

One or more objects of this class are automatically created when you invoke the `getFunctions` method of an object of class `Simulink.CodeImporter.ParseInfo`. One `Simulink.CodeImporter.SimulinkPortSpecification` object is created for each function in the parsed custom code for which `getFunctions` is invoked as the `PortSpecification` property of the `Function` object corresponding to that function. Do not create an object of class `Simulink.CodeImporter.SimulinkPortSpecification` directly.

Properties

InputArguments — Port specification for input arguments

`FunctionArgument` object

Port specification for input arguments, specified as a `FunctionArgument` Object.

ReturnArgument — Port specification for function return argument

`FunctionArgument` object | scalar

Port specification for function return argument, specified as a scalar or an empty `FunctionArgument` Object.

GlobalArguments — Port specification for custom code global variables used as function arguments

`FunctionArgument` object | scalar

Port specification for custom code global variables used as function arguments, specified as a scalar or an empty `FunctionArgument` Object.

Methods

Public Methods

`getGlobalArg` Get an object definition of a global variable in a C Caller block

Examples

Configure Port Specifications for Custom Code Library Blocks

Specify and parse custom code, then customize port specification before importing into Simulink.

```
%% Create code importer object
obj = Simulink.CodeImporter;

%% Set library file name and output folder
obj.LibraryFileName = "pumpController";
obj.OutputFolder = ".";

%% Set the custom code to import
obj.CustomCode.InterfaceHeaders = ["pumpController.h"];
obj.CustomCode.IncludePaths = ["/include"];
obj.CustomCode.SourceFiles = ["src/pumpController.c" "src/utils.c"];

%% Parse custom code and configure function
obj.parse();
fcn = obj.ParseInfo.getFunctions("Controller");
fcn.PortSpecification.ReturnArgument.Label = "control_out";

fcn.PortSpecification.ReturnArgument

ans =

    FunctionArgument with properties:

        Name: 'out'
    PortNumber: 1
        Size: '1'
        Type: 'Bus: pump_control_bus'
        Label: 'control_out'
        Scope: 'Output'
```

See Also

[Simulink.CodeImporter](#) | [Simulink.CodeImporter.CustomCode](#) |
[Simulink.CodeImporter.Options](#) | [Simulink.CodeImporter.ParseInfo](#) |
[Simulink.CodeImporter.Function](#)

Introduced in R2021a

getGlobalArg

Class: Simulink.CodeImporter.SimulinkPortSpecification

Package: Simulink.CodeImporter

Get an object definition of a global variable in a C Caller block

Syntax

```
output_args = getGlobalArg(input_args,Name,Value)
```

Description

`output_args = getGlobalArg(input_args,Name,Value)` <verb phrase> with additional options specified by one or more `Name, Value` pair arguments.

Input Arguments

input_args —
(default) |

Example:

Data Types: `single` | `double` | `int8` | `int16` | `int32` | `int64` | `uint8` | `uint16` | `uint32` | `uint64` | `logical` | `char` | `string` | `struct` | `table` | `cell` | `function_handle` | `categorical` | `datetime` | `duration` | `calendarDuration` | `fi`
Complex Number Support: Yes

Name-Value Pair Arguments

Specify optional comma-separated pairs of `Name, Value` arguments. `Name` is the argument name and `Value` is the corresponding value. `Name` must appear inside quotes. You can specify several name and value pair arguments in any order as `Name1, Value1, ..., NameN, ValueN`.

Example:

Name —
(default) |

Example:

Data Types: `single` | `double` | `int8` | `int16` | `int32` | `int64` | `uint8` | `uint16` | `uint32` | `uint64` | `logical` | `char` | `string` | `struct` | `table` | `cell` | `function_handle` | `categorical` | `datetime` | `duration` | `calendarDuration` | `fi`
Complex Number Support: Yes

Output Arguments

output_args –

Attributes

To learn about attributes of methods, see [Method Attributes](#).

Examples

Get definition of global variable

See Also

Introduced in R2021a

Simulink.CoderInfo

Specify information needed to generate code for signal, state, or parameter data

Description

Use a `Simulink.CoderInfo` object to specify code generation settings for signal, state, and parameter data in a model.

Simulink creates a `Simulink.CoderInfo` object for each data object that you create. Data objects represent signal, state, or parameter data. The `Simulink.CoderInfo` object exists in the `CoderInfo` property of each data object.

Data objects include objects of these classes:

- `Simulink.Parameter`
- `Simulink.Signal`
- `Simulink.LookupTable`
- `Simulink.Breakpoint`
- `Simulink.DualScaledParameter`

Use the properties of the `Simulink.CoderInfo` object to configure the representation of the parent data object in the generated code.

You can set the properties of a `Simulink.CoderInfo` object through the `CoderInfo` property or the property dialog box of the parent data object. For example, the following MATLAB expression sets the `StorageClass` property of a `Simulink.CoderInfo` object used by a signal object named `mysignal`.

```
mysignal.CoderInfo.StorageClass = 'ExportedGlobal';
```

Creation

When you create a data object, Simulink sets the value of the `CoderInfo` property by creating a `Simulink.CoderInfo` object. You do not need to create a `Simulink.CoderInfo` object explicitly.

Properties

Identifier — Alternative name for code generation

' ' (empty character vector) (default) | character vector

Alternative name for the data in the generated code, specified as a character vector.

Example: `'myOtherName'`

Data Types: `char`

Alignment — Data alignment boundary

-1 (default) | positive integer

Data alignment boundary for this data, specified as a positive integer that is a power of 2, not exceeding 128. Specify an integer number of double data type. See “Data Alignment for Code Replacement” (Embedded Coder) for more information.

Example: 8

Data Types: double

Complex Number Support: Yes

CustomAttributes — Custom storage class attributes of this data

SimulinkCSC.AttribClass_Simulink_Default object (default) | custom attributes object

Custom storage class attributes of this data, returned as a custom attributes object. You must set the property `StorageClass` to 'Custom' to enable this property.

Depending on the custom storage class that you apply by using the `CustomStorageClass` property of the `Simulink.CoderInfo` object, Simulink sets the value of this property by creating a custom attributes object. Then, you can set the values of the properties of the custom attributes object. See “Organize Parameter Data into a Structure by Using Struct Storage Class” (Embedded Coder) for more information.

CustomStorageClass — Custom storage class of this data

'Default' (default) | character vector

Custom storage class of this data, specified as a character vector. You must set the property `StorageClass` to 'Custom' to enable this property.

For a list of valid custom storage classes (Embedded Coder) when you create the data object from the `Simulink` package, see “Choose Storage Class for Controlling Data Representation in Generated Code” (Embedded Coder).

Example: 'ExportToFile'

Data Types: char

StorageClass — Storage class of this data

'Auto' (default) | character vector

Storage class of this data, specified as a character vector. For more information, see “C Code Generation Configuration for Model Interface Elements” (Simulink Coder).

Example: 'ExportedGlobal'

Data Types: char

Examples

Configure Code Generation Settings Programmatically

For examples that show how to configure code generation settings for a data item programmatically, see “C Code Generation Configuration for Model Interface Elements” (Simulink Coder) and “Organize Parameter Data into a Structure by Using Struct Storage Class” (Embedded Coder).

Extended Capabilities

C/C++ Code Generation

Generate C and C++ code using MATLAB® Coder™.

See Also

Topics

“C Code Generation Configuration for Model Interface Elements” (Simulink Coder)

“Create Tunable Calibration Parameter in the Generated Code” (Simulink Coder)

“Data Objects”

“Organize Parameter Data into a Structure by Using Struct Storage Class” (Embedded Coder)

Introduced in R2015a

Simulink.GlobalDataTransfer class

Package: Simulink

Configure concurrent execution data transfers

Description

The `Simulink.GlobalDataTransfer` object contains the data transfer information for the concurrent execution of a model. To access the properties of this class, use the `get_param` function to get the handle for this class, and then use dot notation to access the properties. For example:

```
dt=get_param(gcs,'DataTransfer');
dt.DefaultTransitionBetweenContTasks
```

ans =

Ensure deterministic transfer (minimum delay)

Properties

DefaultTransitionBetweenSyncTasks

Global setting for data transfer handling option when the source and destination of a signal are in two different and periodic tasks.

Data Type: Enumeration. Can be one of:

- 'Ensure data integrity only'
- 'Ensure deterministic transfer (maximum delay)'
- 'Ensure deterministic transfer (minimum delay)'

Access: Read/write

DefaultTransitionBetweenContTasks

Global setting for the data transfer handling option for signals that have a continuous sample time.

Data Type: Enumeration. Can be one of:

- 'Ensure data integrity only'
- 'Ensure deterministic transfer (maximum delay)'
- 'Ensure deterministic transfer (minimum delay)'

Access: Read/write

DefaultExtrapolationMethodBetweenContTasks

Global setting for the data transfer extrapolation method for signals that have a continuous sample time.

Data Type: Enumeration. Can be one of:

- 'None'
- 'Zero Order Hold'
- 'Linear'
- 'Quadratic'

Access: Read/write

Copy Semantics

Handle. To learn how handle classes affect copy operations, see Copying Objects.

Examples

Access the properties of this class.

```
dt=get_param(gcs, 'DataTransfer');  
dt.DefaultTransitionBetweenContTasks
```

ans =

Ensure deterministic transfer (minimum delay)

See Also

[Simulink.architecture.get_param](#) | [Simulink.architecture.add](#) |
[Simulink.architecture.delete](#) | [Simulink.architecture.find_system](#) |
[Simulink.architecture.importAndSelect](#) | [Simulink.architecture.profile](#) |
[Simulink.architecture.register](#) | [Simulink.architecture.set_param](#)

Topics

“Configure Data Transfer Settings Between Concurrent Tasks”

Simulink.LookupTable class

Package: Simulink

Store and share lookup table and breakpoint data, configure the data for ASAP2 and AUTOSAR code generation

Description

An object of the `Simulink.LookupTable` class stores lookup table and breakpoint data. You can use that data in a lookup table block such as the n-D Lookup Table block. With the object, you can specify data types and code generation settings for the table and the breakpoint sets.

When you store all of the table and breakpoint set data in a single `Simulink.LookupTable` object, all of the data appears in a single structure in the generated code. To configure `STD_AXIS` code generation for calibration, use this technique.

To share a breakpoint set between multiple lookup tables, for example for `COM_AXIS` code generation, use a `Simulink.Breakpoint` object in one or more Prelookup blocks. Use `Simulink.LookupTable` objects in Interpolation Using Prelookup blocks. Then, configure the lookup table objects to refer to the breakpoint object. For more information, see “Package Shared Breakpoint and Table Data for Lookup Tables”.

To subclass from `Simulink.LookupTable` and inherit from this base class, type this syntax as the first line of your class definition file, where *myLookuptable* is the name of your new class:

```
classdef myLookuptable < Simulink.LookupTable
```

For an example on subclassing, see “Define Data Classes”.

If you add properties to the subclass, you can see them by displaying the subclass object at the MATLAB command line. In the property dialog box, these properties display in a new tab.

Construction

`LUTObj = Simulink.LookupTable` returns a `Simulink.LookupTable` object `LUTObj` with default property values.

To create a `Simulink.LookupTable` object by using the Model Explorer, use the button  on the toolbar. The default name for the object is `Object`.

Property Dialog Box

Setting **Breakpoints specification** to `Explicit` (default) displays this view of the property dialog box.

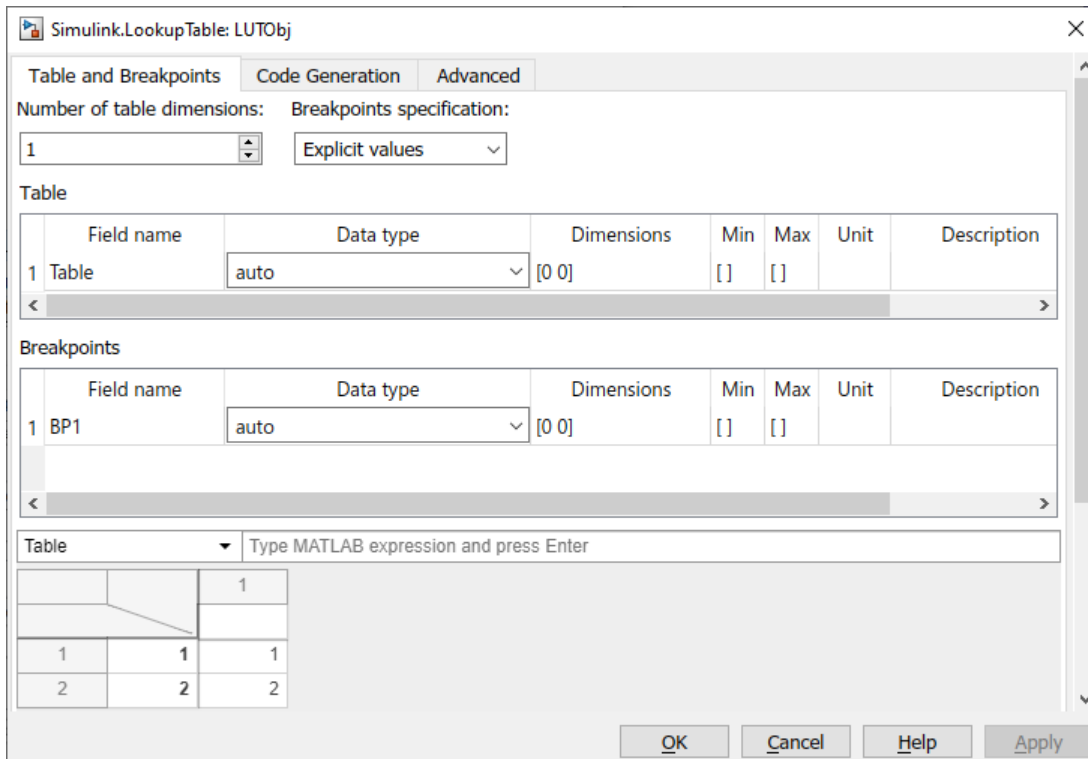

The bottom of the dialog box contains the table and breakpoint data values. For more information on this tabular area, see “View Lookup Table Data”. The contents of this table are equivalent to the **Value** property, visible when the **Breakpoints specification** property is set to Even spacing or Reference.

Number of table dimensions

Number of dimensions of the lookup table. Specify an integer value up to 30 (inclusive). For example, to represent a three-dimensional lookup table, specify the integer 3.

Table

Information for the table data. You can configure these characteristics:

Value

Table data. Specify a numeric vector or multidimensional array with at least two elements.

The **Value** table data is the same as the contents of the tabular interface visible at the bottom of the dialog box when the **Breakpoints specification** property is set to **Explicit**. For more information on this tabular area, see “View Lookup Table Data”.

Note This property appears only if **Breakpoints specification** is set to Even spacing or Reference.

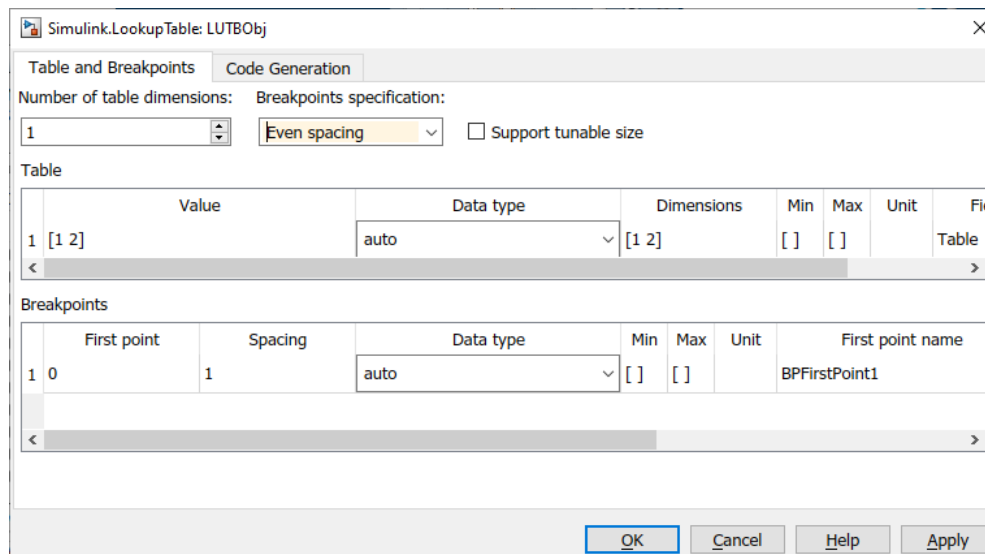

You can also use an expression with mathematical operators such as `sin(1:0.5:30)` as long as the expression returns a numeric vector or multidimensional array. When you click **Apply** or **OK**, the object executes the expression and uses the result to set the value of this property.

When you set **Data type** to `auto`, to set **Value**, use a typed expression such as `single([1 2 3])` or use the `fi` constructor to embed an `fi` object.

When you specify table data with three or more dimensions, **Value** displays the data as an expression that contains a call to the `reshape` function. To edit the values in the data, modify the first argument of the `reshape` call, which contains all of the values in a serialized vector. When you add or remove elements along a dimension, you must also correct the argument that represents the length of the modified dimension.

You can edit this data by using a more intuitive interface in a lookup table block. See “Import Lookup Table Data from MATLAB”.

Data type

Data type of the table data. The default setting is `auto`, which means that the table data acquire a data type from the value that you specify in **Value**. If you use an untyped expression such as `[1 2 3]` to set **Value**, the table data use the data type `double`. If you specify a typed expression such as `single([1 2 3])` or an `fi` object, the table data use the data type specified by the expression or object. Enumerated data types are also supported.

You can explicitly specify an integer data type, half data type, a floating-point data type, a fixed-point data type, or a data type expression such as the name of a `Simulink.AliasType` object.

For more information about data types in Simulink, see “Data Types Supported by Simulink”. To decide how to control the data types of table and breakpoint data in `Simulink.LookupTable` and `Simulink.Breakpoint` objects, see “Control Data Types of Lookup Table Objects” (Simulink Coder).

Dimensions

Dimension lengths of the lookup table data.

To use symbolic dimensions, specify a character vector. See “Implement Dimension Variants for Array Sizes in Generated Code” (Embedded Coder).

Min

Minimum value of the elements in the table data. The default value is empty, []. You can specify a numeric, real value.

For more information about how Simulink uses this property, see “Specify Minimum and Maximum Values for Block Parameters”.

Max

Maximum value of the elements in the table data. The default value is empty, []. You can specify a numeric, real value.

For more information about how Simulink uses this property, see “Specify Minimum and Maximum Values for Block Parameters”.

Stored Int Min

For `Simulink.LookupTable` objects with a fixed-point data type, the minimum value of the elements in the table data, specified as a stored integer value. The value is derived from the real-world value **Min**. This property is available only in the property dialog box.

Stored Int Max

For `Simulink.LookupTable` objects with a fixed-point data type, the maximum value of the elements in the table data, specified as a stored integer value. The value is derived from the real-world value **Max**. This property is available only in the property dialog box.

Unit

Physical units of the elements in the lookup table. You can specify text such as `degC`. See “Unit Specification in Simulink Models”.

Field name

Name of a structure field in the generated code. This field stores the table data if you configure the `Simulink.LookupTable` object to appear in the generated code as a structure. The default value is `Table`. To change the field name, specify text.

Description

Description of the lookup table. You can specify text such as `This lookup table describes the action of a pump`.

Breakpoints

Breakpoint set information. Each row is one breakpoint set. To configure additional breakpoint sets, specify an integer value in the **Number of table dimensions** box.

For the breakpoint sets, you can configure these characteristics:

Specification

Source for the information of the breakpoint sets, specified as `Explicit values` (default), `Reference`, or `Even spacing`.

- To store all of the table and breakpoint set data in the `Simulink.LookupTable` object, set **Specification** to `Explicit values`.

The `Simulink.LookupTable` object appears in the generated code as a single structure variable.

- To store the table data in the `Simulink.LookupTable` object and store the breakpoint set data in `Simulink.Breakpoint` objects, set **Specification** to `Reference`.

The `Simulink.LookupTable` object appears in the generated code as a separate array variable that contains the table data. Each `Simulink.Breakpoint` object appears as a separate array or structure variable that contains the breakpoint set data.

- To store the table data and evenly spaced breakpoints in the `Simulink.LookupTable` object, set **Specification** to `Even spacing`. Use the **First point** and **Spacing** parameters to generate a set of evenly spaced breakpoints.

Note When **Specification** is set to `Explicit values` or `Even spacing`, you can change the order of the tunable size, breakpoint, and table entries in a lookup table object-generated structure.

Support tunable size

Specification to enable tuning the effective size of the table in the generated code. In the code, the structure that corresponds to the object has an extra field for each breakpoint vector. Each extra field stores the length of the corresponding breakpoint vector. You can change the value of each field to adjust the effective size of the table.

This property appears only if you set **Specification** to `Explicit values` or `Even spacing`.

Note If you store breakpoint data in `Simulink.Breakpoint` objects by setting **Specification** to `Reference`, to enable tuning of the table size in the generated code, use the **Support tunable size** property of each `Simulink.Breakpoint` object.

Value

Data for the breakpoint set. Specify a numeric vector with at least two elements.

Note This property appears only if **Breakpoints specification** is set to `Even spacing` or `Reference`. The **Value** breakpoint set data is the same as the contents of the tabular interface visible at the bottom of the dialog box when the **Breakpoints specification** property is set to `Explicit`. For more information on this tabular area, see “View Lookup Table Data”.

You can also use an expression with mathematical operators such as `sin(1:0.5:30)` as long as the expression returns a numeric vector. When you click **Apply** or **OK**, the object executes the expression and uses the result to set the value of this property.

When you set **Data type** to `auto`, to set **Value**, use a typed expression such as `single([1 2 3])` or use the `fi` constructor to embed an `fi` object.

You can edit this data by using a more intuitive interface in a lookup table block. See “Import Lookup Table Data from MATLAB”.

Data type

Data type of the breakpoint set. The default setting is `auto`, which means that the breakpoint set acquires a data type from the value that you specify in **Value**. If you use an untyped

expression such as `[1 2 3]` to set **Value**, the breakpoint data use the data type `double`. If you specify a typed expression such as `single([1 2 3])` or an `fi` object, the breakpoint data use the data type specified by the expression or object.

You can explicitly specify an integer data type, a floating-point data type, a fixed-point data type, or a data type expression such as the name of a `Simulink.AliasType` object.

For more information about data types in Simulink, see “Data Types Supported by Simulink”. To decide how to control the data types of table and breakpoint data in `Simulink.LookupTable` and `Simulink.Breakpoint` objects, see “Control Data Types of Lookup Table Objects” (Simulink Coder).

Dimensions

Dimension lengths of the breakpoint set.

To use symbolic dimensions, specify a character vector. See “Implement Dimension Variants for Array Sizes in Generated Code” (Embedded Coder).

Min

Minimum value of the elements in the breakpoint set. The default value is empty, `[]`. You can specify a numeric, real value.

For more information about how Simulink uses this property, see “Specify Minimum and Maximum Values for Block Parameters”.

Max

Maximum value of the elements in the breakpoint set. The default value is empty, `[]`. You can specify a numeric, real value.

For more information about how Simulink uses this property, see “Specify Minimum and Maximum Values for Block Parameters”.

Unit

Physical unit of the elements in the breakpoint set. You can specify text such as `degF`. See “Unit Specification in Simulink Models”.

Field name

Name of a structure field in the generated code. This field stores the breakpoint set data. The default value is `BP1` for the first breakpoint set and `BP2` for the second set. To change the field name, specify text.

Tunable size name

Name of a structure field in the generated code. This field stores the length (number of elements) of the breakpoint set, which the generated code algorithm uses to determine the size of the table. To tune the effective size of the table during code execution, change the value of this structure field in memory. The default name is `N1` for the first breakpoint set and `N2` for the second set. To change the field name, specify text.

This column appears only if you select **Support tunable size**.

Description

Description of the breakpoint set. You can specify text such as `This breakpoint set represents the pressure input`.

First point

First point in evenly spaced breakpoint data. This parameter is available when **Specification** is set to `Even spacing`.

Spacing

Spacing between points in evenly spaced breakpoint data. This parameter is available when **Specification** is set to `Even spacing`.

Name

Name of the `Simulink.Breakpoint` object that stores the information for this breakpoint set.

This column appears only if you set **Specification** to `Reference`.

First point name

Name of the `Simulink.Breakpoint` object that stores the information for the first point. This parameter is available when **Specification** is set to `Even spacing`.

Spacing name

Name of the `Simulink.Breakpoint` object that stores the information for the spacing. This parameter is available when **Specification** is set to `Even spacing`.

Data definition: Storage class

Storage class of the structure variable (if you set **Specification** to `Explicit values` or `Even spacing`) or array variable (`Reference`) in the generated code. The variable stores the table data and, if the variable is a structure, the breakpoint set data. The default setting is `Auto`.

For more information about storage classes, see “C Code Generation Configuration for Model Interface Elements” (Simulink Coder).

If you have Embedded Coder, you can choose a custom storage class. For information about custom storage classes, see “Organize Parameter Data into a Structure by Using Struct Storage Class” (Embedded Coder).

Data definition: Identifier

Alternative name for the structure variable (if you set **Specification** to `Explicit values` or `Even spacing`) or array variable (`Reference`) in the generated code. The default value is empty, in which case the generated code uses the name of the `Simulink.LookupTable` object as the name of the structure or array variable. To set the identifier, specify text.

To enable this property, set **Data definition: Storage class** to a setting other than `Auto`.

Data definition: Alignment

Data alignment boundary in the generated code. The starting memory address for the data allocated for the structure or array variable is a multiple of the value that you specify. The default value is `-1`, which allows the code generator to determine an optimal alignment based on usage.

Specify a positive integer that is a power of 2, not exceeding 128. For more information about using data alignment for code replacement, see “Data Alignment for Code Replacement” (Embedded Coder).

Struct Type definition: Name

Name of the structure type that the structure variable uses in the generated code. The default value is empty. Specify text.

This property appears only if you set **Specification** to `Explicit values` or `Even spacing`.

Struct Type definition: Data scope

Scope of the structure type definition (imported from your custom code or exported from the generated code). The default value is `Auto`. When you select `Auto`:

- If you do not specify a value in the **Struct Type definition: Header file** box, the generated code exports the structure type definition to the file `model_types.h`. `model` is the name of the model.
- If you specify a value in the **Struct Type definition: Header file** box, such as `myHdr.h`, the generated code imports the structure type definition from `myHdr.h`.

To explicitly specify the data scope:

- To import the structure type definition into the generated code from your custom code, select `Imported`.
- To export the structure type definition from the generated code, select `Exported`.

If you do not specify a value in the **Struct Type definition: Header file** box, the generated code imports or exports the type definition from or to `StructName.h`. `StructName` is the name that you specify by using the property **Struct Type definition: Name**.

This property appears only if you set **Specification** to `Explicit` values or `Even spacing`.

Struct Type definition: Header file

Name of the header file that contains the structure type definition. You can import the definition from a header file that you create, or export the definition into a generated header file. To control the scope of the structure type, adjust the setting for the **Struct Type definition: Data scope** property.

This property appears only if you set **Specification** to `Explicit` values or `Even spacing`.

Table and breakpoint value edit area

Information for table and breakpoint data. You can enter a MATLAB expression in the associated text box or add data directly in the accompanying table. Select the desired data type:

- **Table** — Table data. Specify a numeric vector or multidimensional array with at least two elements.

You can also use an expression with mathematical operators such as `sin(1:0.5:30)` as long as the expression returns a numeric vector or multidimensional array. When you press **Enter**, the object executes the expression and uses the result to set the value of this property.

When you specify table data with three or more dimensions, the table displays the data as an expression that contains a call to the `reshape` function. To edit the values in the data, modify the first argument of the `reshape` call, which contains all of the values in a serialized vector. When you add or remove elements along a dimension, you must also correct the argument that represents the length of the modified dimension.

You can edit this data using a more intuitive interface in a lookup table block. See “Import Lookup Table Data from MATLAB”.

- **BPN** — Data for the breakpoint set.

Specify a numeric vector with at least two elements.

You can also use an expression with mathematical operators such as `sin(1:0.5:30)` as long as the expression returns a numeric vector. When you press **Enter**, the object executes the expression and uses the result to set the value of this property.

You can edit this data by using a more intuitive interface in a lookup table block. See “Import Lookup Table Data from MATLAB”.

Entering or manipulating data in the table is simple and intuitive. Like Microsoft Excel spreadsheets, you can work with the table with operations such as:

- Select table elements
- Use standard keyboard shortcuts such as:
 - Copy — **Ctrl+C**
 - Paste — **Ctrl+V**
 - Undo — **Ctrl+Z**
 - Delete
 - Redo — **Shift+Ctrl+Z**

Properties

Breakpoints — Breakpoint set information

vector of `Simulink.lookupable.Breakpoint` objects | cell array of character vectors

Breakpoint set information, specified as a vector of `Simulink.lookupable.Breakpoint` objects, a cell array of character vectors, or a vector of `Simulink.lookupable.Evenspacing` objects.

If you use a vector of `Simulink.lookupable.Breakpoint` objects, each object represents a breakpoint set. To use a vector of `Simulink.lookupable.Breakpoint` objects, set the property `BreakpointsSpecification` to 'Explicit values'.

If you use a cell array of character vectors, each character vector represents the name of a `Simulink.Breakpoint` object. To use a cell array of character vectors, set the property `BreakpointsSpecification` to 'Reference'.

If you use a vector of `Simulink.lookupable.Evenspacing` objects, each object represents a breakpoint set. To use a vector of `Simulink.lookupable.Evenspacing` objects, set the property `BreakpointsSpecification` to 'Even Spacing'.

BreakpointsSpecification — Source of breakpoint set information

'Explicit values' (default) | 'Reference' | 'Even spacing'

Source of the breakpoint set information, specified as 'Explicit values' (default), 'Even spacing', or 'Reference'. See the **Breakpoints > Specification** parameter.

Data Types: char

CoderInfo — Code generation settings for structure or array variable

`Simulink.CoderInfo` object

Code generation settings for the structure variable (if you set `BreakpointsSpecification` to 'Explicit values' or 'Even spacing') or array variable ('Reference') that stores the lookup

table and breakpoint sets, specified as a `Simulink.CoderInfo` object. You can specify a storage class or custom storage class by using this embedded object. See `Simulink.CoderInfo`.

StructTypeInfo — Settings for structure type in the generated code

`Simulink.lookuptable.StructTypeInfo` object

Settings for the structure type that the structure variable uses in the generated code, specified as a `Simulink.lookuptable.StructTypeInfo` object.

If you set `BreakpointsSpecification` to 'Reference', the `Simulink.LookupTable` object does not appear in the generated code as a structure. The code generator ignores this property.

SupportTunableSize — Option to generate code that enables tunability of table size

`false` (default) | `true`

Option to generate code that enables tunability of the effective size of the table, specified as `true` or `false`. See the **Support Tunable Size** parameter.

Data Types: `logical`

Table — Information for table data

`Simulink.lookuptable.Table` object

Information for the table data, specified as a `Simulink.lookuptable.Table` object.

Copy Semantics

Handle. To learn how handle classes affect copy operations, see [Copying Objects](#).

Examples

Represent a One-Dimensional Lookup Table

- 1 Create a `Simulink.LookupTable` object named `LUTObj`.

```
LUTObj = Simulink.LookupTable;
```

- 2 Specify the table data.

```
LUTObj.Table.Value = [1.1 2.2 3.3 4.4 5.5];
```

- 3 Specify the breakpoint set data.

```
LUTObj.Breakpoints(1).Value = [-2 -1 0 1 2];
```

- 4 Specify a name for the structure type in the generated code.

```
LUTObj.StructTypeInfo.Name = 'myLUTStruct';
```

You can use `LUTObj` in a 1-D Lookup Table block dialog box. In the block, set **Data specification** to `Lookup table object` and **Name** to `LUTObj`.

To view the data, use the property dialog as described in “View Lookup Table Data”.

Represent a Two-Dimensional Lookup Table

- 1 Create a `Simulink.LookupTable` object named `LUTObj`.

```
LUTObj = Simulink.LookupTable;
```

- 2 Specify the table data.

```
LUTObj.Table.Value = [1.1 2.2 3.3 4.4 5.5; ...
                    6.6 7.7 8.8 9.9 10.1];
```

- 3 Specify the breakpoint set data. In the Breakpoints property, use the vector index 2 to set the values in the second breakpoint set.

```
LUTObj.Breakpoints(1).Value = [-1 1];
```

```
LUTObj.Breakpoints(2).Value = [-2 -1 0 1 2];
```

LUTObj creates a Simulink.lookuptable.Breakpoint object as the second vector element in the value of the Breakpoints property. Except for the Value property, the new object has default property values.

- 4 Specify a name for the structure type in the generated code.

```
LUTObj.StructTypeInfo.Name = 'myLUTStruct';
```

You can use LUTObj in a 2-D Lookup Table block dialog box.

To view the data, use the property dialog as described in “View Lookup Table Data”.

Evenly Space Every Second Value Starting from 1

To evenly space every second value starting from 1, use the Breakpoint object.

- 1 Create a Simulink.LookupTable object named LUTObj.

```
LUTObj=Simulink.LookupTable
```

```
LUTObj =
```

```
LookupTable with properties:
```

```

        Table: [1x1 Simulink.lookuptable.Table]
BreakpointsSpecification: 'Explicit values'
        Breakpoints: [1x1 Simulink.lookuptable.Breakpoint]
SupportTunableSize: 0
        CoderInfo: [1x1 Simulink.CoderInfo]
        StructTypeInfo: [1x1 Simulink.lookuptable.StructTypeInfo]
```

- 2 Set up the breakpoint property to even spacing.

```
LUTObj.BreakpointsSpecification='Even spacing'
```

```
LUTObj =
```

```
LookupTable with properties:
```

```

        Table: [1x1 Simulink.lookuptable.Table]
BreakpointsSpecification: 'Even spacing'
        Breakpoints: [1x1 Simulink.lookuptable.Evenspacing]
SupportTunableSize: 0
        CoderInfo: [1x1 Simulink.CoderInfo]
        StructTypeInfo: [1x1 Simulink.lookuptable.StructTypeInfo]
```

- 3 Get the properties of the breakpoint.

```
LUTObj.Breakpoints(1)
```

```
ans =
```

```
    Evenspacing with properties:
```

```
        FirstPoint: 0
           Spacing: 1
        DataType: 'auto'
           Min: []
           Max: []
           Unit: ''
    FirstPointName: 'BPFirstPoint1'
       SpacingName: 'BPSpacing1'
    TunableSizeName: 'N1'
       Description: ''
```

- 4 To set the first point property, use the Breakpoint object FirstPoint property.

```
LUTObj.Breakpoints(1).FirstPoint=1
```

- 5 To set the spacing property, use the Breakpoint object.

```
LUTObj.Breakpoints(1).Spacing=2
```

- 6 Get the properties of the breakpoint.

```
LUTObj.Breakpoints(1)
```

```
ans =
```

```
    Evenspacing with properties:
```

```
        FirstPoint: 1
           Spacing: 2
        DataType: 'auto'
           Min: []
           Max: []
           Unit: ''
    FirstPointName: 'BPFirstPoint1'
       SpacingName: 'BPSpacing1'
    TunableSizeName: 'N1'
       Description: ''
```

Control Code Generation for Lookup Table and Breakpoint Sets

Create a Simulink.LookupTable object named LUTObj.

```
LUTObj = Simulink.LookupTable;
```

Specify the table data.

```
LUTObj.Table.Value = [1.00 2.25 3.50 4.75 6.00; ...
                    7.25 8.50 9.75 11.00 12.25];
```

Specify the breakpoint set data. In the Breakpoints property, use the array index 2 to create an additional Simulink.lookuptable.BreakpointInfo object, which represents the second breakpoint set.

```
LUTObj.Breakpoints(1).Value = [-1 1];
LUTObj.Breakpoints(2).Value = [-2 -1 0 1 2];
```

Specify data types for the lookup table and each breakpoint set.

```
LUTObj.Table.DataType = 'fixdt(1,16,2)';
LUTObj.Breakpoints(1).DataType = 'int16';
LUTObj.Breakpoints(2).DataType = 'int16';
```

Specify unique names for the structure fields that store the table data and breakpoint sets in the generated code.

```
LUTObj.Table.FieldName = 'myTable';
LUTObj.Breakpoints(1).FieldName = 'myBPSet1';
LUTObj.Breakpoints(2).FieldName = 'myBPSet2';
```

Export the structure variable definition from the generated code by using the storage class ExportedGlobal.

```
LUTObj.CoderInfo.StorageClass = 'ExportedGlobal';
```

Name the structure type in the generated code LUTStructType. Export the structure type definition to a generated header file named myLUTHdr.h.

```
LUTObj.StructTypeInfo.Name = 'LUTStructType';
LUTObj.StructTypeInfo.DataScope = 'Exported';
LUTObj.StructTypeInfo.HeaderFileName = 'myLUTHdr.h';
```

In an n-D Lookup Table block in a model, set **Data specification** to Lookup table object and **Name** to LUTObj.

```
load_system('myModel_LUTObj')
set_param('myModel_LUTObj/Lookup Table','DataSpecification','Lookup table object',...
          'LookupTableObject','LUTObj')
```

Generate code from the model.

```
slbuild('myModel_LUTObj')

### Starting build procedure for: myModel_LUTObj
### Generated code for 'myModel_LUTObj' is up to date because no structural, parameter or code re
### Successful completion of code generation for: myModel_LUTObj
```

Build Summary

```
0 of 1 models built (1 models already up to date)
Build duration: 0h 0m 2.141s
```

The generated code defines the structure type LUTStructType in the generated header file myLUTHdr.h.

```

file = fullfile('myModel_LUTObj_ert_rtw','myLUTHdr.h');
rtwdemodbtpe(file,'typedef struct {'','} LUTStructType;',1,1)

typedef struct {
    int16_T myBPSet1[2];
    int16_T myBPSet2[5];
    int16_T myTable[10];
} LUTStructType;

```

The code uses the global structure variable LUTObj to store the table and breakpoint set data. The table data is scaled based on the specified fixed-point data type.

```

file = fullfile('myModel_LUTObj_ert_rtw','myModel_LUTObj.c');
rtwdemodbtpe(file,'LUTStructType LUTObj = {'','/* Variable: LUTObj',1,1)

LUTStructType LUTObj = {
    { -1, 1 },

    { -2, -1, 0, 1, 2 },

    { 4, 29, 9, 34, 14, 39, 19, 44, 24, 49 }
}; /* Variable: LUTObj

```

Generate Code That Uses Conditionally Compiled Dimension Lengths

Suppose your handwritten code conditionally allocates memory and initializes a lookup table based on dimension lengths that you specify as `#define` macros. This example shows how to generate code that uses your external table and breakpoint data.

Symbolic dimensions require that you use an ERT-based system target file, which requires Embedded Coder®.

Explore External Code

In your current folder, copy these macro definitions into a header file named `ex_myHdr_LUT.h`.

```

#include "rtwtypes.h"

#ifndef _HEADER_MYHDR_H_
#define _HEADER_MYHDR_H_

#define bp1Len 2
#define bp2Len 2

typedef struct {
    real_T BP1[bp1Len];
    real_T BP2[bp2Len];
    real_T Table[bp1Len * bp2Len];
} LUTObj_Type;

extern LUTObj_Type LUTObj;

#endif

```

Copy this static initialization code into a source file named `ex_mySrc_LUT.c`.

```

#include "ex_myHdr_LUT.h"

#if bp1Len == 2 && bp2Len == 2
LUTObj_Type LUTObj = {
    { 1.0, 2.0 },

    { 3.0, 4.0 },

    { 3.0, 2.0, 4.0, 1.0 }
};
#endif

#if bp1Len == 3 && bp2Len == 3
LUTObj_Type LUTObj = {
    { 1.0, 2.0, 3.0 },

    { 4.0, 5.0, 6.0 },

    { 1.0, 6.0, 2.0, 3.0, 8.0, 9.0, 5.0, 4.0, 7.0 }
};
#endif

```

To generate code that imports this data, create `bp1Len` and `bp2Len` as `Simulink.Parameter` objects in MATLAB. Create `LUTObj` as a `Simulink.LookupTable` object. Use the parameter objects to specify the dimension lengths for the table and breakpoint set data in the `Simulink.LookupTable` object.

Create Example Model

Create the example model `ex_LUTObj` by using an n-D Lookup Table block. In the Lookup Table block dialog box, on the **Table and Breakpoints** tab, set **Number of table dimensions** to 2.

```
open_system('ex_LUTObj')
```

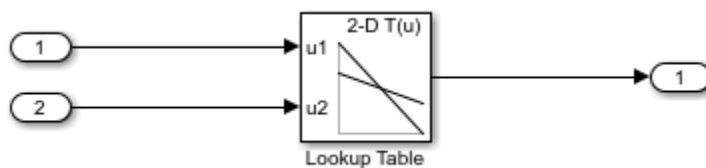

Create Simulink.LookupTable Object

In the Model Explorer **Model Hierarchy** pane, select **Base Workspace**.

On the toolbar, click the **Add Simulink LookupTable** button. A `Simulink.LookupTable` object named `Object` appears in the base workspace.

In the **Contents** pane (the middle pane), rename the object as `LUTObj`.

Alternatively, create the object at the command prompt:

```
LUTObj = Simulink.LookupTable;
```

Configure Simulink.LookupTable Object

In the **Contents** pane, select the new object LUTObj. The property dialog box appears in the **Dialog** pane (the right pane).

Set **Number of table dimensions** to 2.

Under **Table**, set **Value** to [3 4; 2 1].

In the first row under **Breakpoints**, set **Value** to [1 2].

In the second row under **Breakpoints**, set **Value** to [3 4]. Click **Apply**.

Under **Struct Type definition**, set **Data scope** to Imported. Set **Header file** to ex_myHdr_LUT.h. Set **Name** to LUTObj_Type.

In the Lookup Table block dialog box, set **Data specification** to Lookup table object. Set **Name** to LUTObj. Click **Apply**.

Alternatively, to configure the object and the blocks, use these commands:

```
LUTObj.Breakpoints(1).Value = [1 2];
LUTObj.Breakpoints(2).Value = [3 4];
LUTObj.Table.Value = [3 4; 2 1];
LUTObj.StructTypeInfo.DataScope = 'Imported';
LUTObj.StructTypeInfo.HeaderFileName = 'ex_myHdr_LUT.h';
LUTObj.StructTypeInfo.Name = 'LUTObj_Type';
set_param('ex_LUTObj/Lookup Table', 'LookupTableObject', 'LUTObj')
set_param('ex_LUTObj/Lookup Table', ...
    'DataSpecification', 'Lookup table object')
```

Enable the code generator to use Simulink.Parameter objects as macros that specify dimension lengths. Select the configuration parameter **Allow symbolic dimension specification**.

```
set_param('ex_LUTObj', 'AllowSymbolicDim', 'on')
```

Create the Simulink.Parameter objects that represent the macros bp1Len and bp2Len. To generate code that imports the macros from your header file ex_myHdr_LUT.h, apply the storage class ImportedDefine.

```
bp1Len = Simulink.Parameter(2);
bp1Len.Min = 2;
bp1Len.Max = 3;
bp1Len.DataType = 'int32';
bp1Len.CoderInfo.StorageClass = 'Custom';
bp1Len.CoderInfo.CustomStorageClass = 'ImportedDefine';
bp1Len.CoderInfo.CustomAttributes.HeaderFile = 'ex_myHdr_LUT.h';

bp2Len = Simulink.Parameter(2);
bp2Len.Min = 2;
bp2Len.Max = 3;
bp2Len.DataType = 'int32';
bp2Len.CoderInfo.StorageClass = 'Custom';
bp2Len.CoderInfo.CustomStorageClass = 'ImportedDefine';
bp2Len.CoderInfo.CustomAttributes.HeaderFile = 'ex_myHdr_LUT.h';
```

Configure the existing `Simulink.LookupTable` object `LUTObj` to use the `Simulink.Parameter` objects. Set the dimension lengths of the breakpoint set data and the table data by using the names of the parameter objects.

```
LUTObj.Breakpoints(1).Dimensions = '[1 bp1Len]';
LUTObj.Breakpoints(2).Dimensions = '[1 bp2Len]';
LUTObj.Table.Dimensions = '[bp1Len bp2Len]';
```

Configure `LUTObj` as imported data by applying the storage class `ImportFromFile`. To import your definition of `LUTObj`, add the name of the file `ex_mySrc_LUT.c` to the model configuration parameter **Configuration Parameters > Code Generation > Custom Code > Additional Build Information > Source files**.

```
LUTObj.CoderInfo.StorageClass = 'Custom';
LUTObj.CoderInfo.CustomStorageClass = 'ImportFromFile';
LUTObj.CoderInfo.CustomAttributes.HeaderFile = 'ex_myHdr_LUT.h';
```

```
set_param('ex_LUTObj', 'CustomSource', 'ex_mySrc_LUT.c')
```

Generate and Inspect Code

Configure the model to compile an executable from the generated code.

```
set_param('ex_LUTObj', 'GenCodeOnly', 'off')
```

Generate code from the model.

```
slbuild('ex_LUTObj')
```

```
### Starting build procedure for: ex_LUTObj
### Successful completion of build procedure for: ex_LUTObj
```

Build Summary

Top model targets built:

| Model | Action | Rebuild Reason |
|-----------|-----------------------------|--|
| ex_LUTObj | Code generated and compiled | Code generation information file does not exist. |

```
1 of 1 models built (0 models already up to date)
Build duration: 0h 0m 43.348s
```

In the code generation report, view the generated file `ex_LUTObj.h`. The file imports the macro definitions and the structure type definition by including your header file `ex_myHdr_LUT.h`.

```
file = fullfile('ex_LUTObj_ert_rtw', 'ex_LUTObj.h');
rtwdemodbtype(file, '#include "ex_myHdr_LUT.h"', '#include "ex_myHdr_LUT.h"', 1, 1)
```

```
#include "ex_myHdr_LUT.h"
```

In the source file `ex_LUTObj.c`, the code algorithm in the model `step` function passes the breakpoint and table data to the function that performs the table lookup. The algorithm also passes `bp1Len` so the lookup function can traverse the rows and columns of the table data, which appear in the generated code as a serialized 1-D array.

```
file = fullfile('ex_LUTObj_ert_rtw', 'ex_LUTObj.c');
rtwdemodbtype(file, '/* Model step function */', '/* Model initialize function */', 1, 0)
```

```

/* Model step function */
void ex_LUTObj_step(void)
{
    /* Outport: '<Root>/Out1' incorporates:
     * Inport: '<Root>/In1'
     * Inport: '<Root>/In2'
     * Lookup_n-D: '<Root>/Lookup Table'
     */
    ex_LUTObj_Y.Out1 = look2_binlcapw(ex_LUTObj_U.In1, ex_LUTObj_U.In2,
        (&(LUTObj.BP1[0])), (&(LUTObj.BP2[0])), (&(LUTObj.Table[0])),
        ex_LUTObj_ConstP.LookupTable_maxIndex, (uint32_T)bplLen);
}

```

Limitations

- You cannot use `Simulink.Breakpoint` objects or `Simulink.LookupTable` objects that refer to `Simulink.Breakpoint` objects as instance-specific parameter data for reusable components. For example, you cannot use one of these objects as:
 - A model argument in a model workspace or a model argument value in a Model block.
 - The value of a mask parameter on a CodeReuse Subsystem block.
 - The value of a mask parameter on a subsystem that you reuse by creating a custom library.

However, you can use standalone `Simulink.LookupTable` objects, which do not refer to `Simulink.Breakpoint` objects, in these ways.

- When blocks in a subsystem use `Simulink.LookupTable` or `Simulink.Breakpoint` objects, you cannot set data type override only on the subsystem. Instead, set data type override on the entire model.

See Also

[Simulink.lookuptable.Breakpoint](#) | [Simulink.lookuptable.Evenspacing](#) | [Simulink.lookuptable.StructTypeInfo](#) | [Simulink.lookuptable.Table](#) | [Simulink.Parameter](#) | [Simulink.Breakpoint](#)

Topics

“Configure Lookup Tables for AUTOSAR Measurement and Calibration” (AUTOSAR Blockset)
 “About Lookup Table Blocks”
 “View Lookup Table Data”
 “Package Shared Breakpoint and Table Data for Lookup Tables”
 “Create Tunable Calibration Parameter in the Generated Code” (Simulink Coder)

Introduced in R2016b

Simulink.io.BaseWorkspace class

Package: Simulink.io

Read data in format used by base workspace

Description

Simulink.io.BaseWorkspace inherits from the Simulink.io.FileType base class. It reads data formatted in a format used by the base workspace. Use base workspace file types to move data to and from the base workspace to a function, automated process, or user interface. To import data from the base workspace, use this command.

```
classdef BaseWorkspace < Simulink.io.FileType
```

The Simulink.io.BaseWorkspace class is a handle class.

Class Attributes

| | |
|------------------|-------|
| Abstract | false |
| HandleCompatible | true |

For information on class attributes, see “Class Attributes”.

Properties

iofile.BaseWorkspace — Base workspace reader

character array

Base workspace reader, specified as a character array.

Attributes:

| | |
|-----------|--------|
| GetAccess | public |
| SetAccess | public |

Data Types: char | string

Methods

Specialized Operators and Functions

These methods specialize standard MATLAB operators and functions for objects in this class.

| | |
|--------------------|---|
| isFileSupported | This method always returns true because it operates only on data in the base workspace. |
| getFileDescription | This method returns the base workspace file reader description. |

Examples

Read Data in Base Workspace Format

Read data in base workspace format from file, `foo.mat`.

Set up a timeseries variable, `ts`. If `ts` is a variable in the workspace, the object ignores `fileName`.

```
ts = timeseries([0;9]);
```

Set up reader.

```
aReader = Simulink.io.BaseWorkspace();  
resultOfWhos = whos( aReader );
```

Load the reader, which has no inputs.

```
varsOnFileStruct = load(aReader);
```

Load one variable.

```
var = loadAVariable(aReader, 'ts');
```

Import the file.

```
importedVars = import(aReader);
```

Export to a file.

```
ds = Simulink.SimulationData.Dataset;  
ds = ds.addElement(timeseries([1:10]',[1:10]'), 'Signal1');  
ds = ds.addElement(timeseries([1:10]',[11:20]'), 'Signal2');  
ds = ds.addElement(timeseries([1:10]',[21:30]'), 'Signal3');  
%filePath is ignored, must be provided because the API ruleset  
filePath = '';  
didWrite = aReader.export(filePath, {'ds'}, {ds}, 0);
```

See Also

[Simulink.io.FileType](#) | [Simulink.io.MatFile](#) |
[Simulink.io.SignalBuilderSpreadsheet](#) | [exportImpl](#) | [getFileTypesDescription](#) |
[Simulink.io.FileType.isFileSupported](#) | [loadImpl](#) | [loadAVariableImpl](#) |
[validateFileNameImpl](#) | [whosImpl](#)

Topics

“Import Custom File Type”

“Create Custom File Type for Import to Signal Editor”

Introduced in R2021a

Simulink.io.FileType class

Package: Simulink.io

Base class for file type readers for Simulink interfaces such as Signal Editor

Description

Simulink.io.FileType is the base class for Simulink.io.FileType objects. In your class definition file, you must subclass your object from this base class. Simulink requires direct inheritance from FileType. Subclassing allows you to use the implementation methods and service methods provided by this class to build your object. Type this syntax as the first line of your class definition file to directly inherit from the Simulink.io.FileType base class, where ObjectName is the name of your object:

```
classdef ObjectName < Simulink.io.FileType
```

The Simulink.io.FileType class is a handle class.

Class Attributes

| | |
|------------------|------|
| Abstract | true |
| HandleCompatible | true |

For information on class attributes, see “Class Attributes”.

Properties

FileName — File name

character array

File name of file that contains custom signals for import to Signal Editor, specified as a character array.

Attributes:

| | |
|-----------|--------|
| GetAccess | public |
| SetAccess | public |

Methods

Public Methods

| | |
|---|---|
| exportImpl | Export signals to file |
| Simulink.io.FileType.getFileTypeDescription | Get custom file reader description |
| Simulink.io.FileType.isFileSupported | Check if file type is supported in Simulink |
| Simulink.io.FileType.isInput | Check if input is acceptable Simulink input |
| Simulink.io.FileType.isSimulinkParameter | Check if input is Simulink parameter |
| loadImpl | Load signal names from custom FileType object |
| loadAVariableImpl | Load specified variable from MAT-file |
| validateFileNameImpl | Validate contents of custom MAT-file |

whosImpl

Determine contents of MAT-file associated with Simulink.io.FileType object

Specialized Operators and Functions

These methods specialize standard MATLAB operators and functions for objects in this class.

| | |
|-----------------|--|
| export | <p>This method calls the <code>exportImpl</code> method.</p> <p>From Signal Editor, write the structure of signals to a MAT-file. The structure must contain two cell arrays; one for signal names and one for signal values. Specify if the method appends to or overwrites the contents of the MAT-file. The method indicates if it succeeded in writing to the MAT-file and returns any error messages.</p> |
| import | <p><code>[importedData, warnStr] = import(reader)</code></p> <p>To import custom signals for a custom file type, identify the custom file type <i>reader</i> as a <code>Simulink.io.FileType</code> object. The method returns the found variable as a cell array of signal variables of supported types. For more information on supported types, see “Choose a Base Workspace and MAT-File Format”. The method returns a structure with two fields, <code>Data</code> and <code>Name</code>. <code>Data</code> is a cell array of signals and <code>Name</code> is a cell array of character vectors of the corresponding signal names.</p> |
| importAVariable | <p><code>varOut = importAVariable(reader,variableName)</code></p> <p>To import a specified variable for a custom file type, identify the custom file type reader as a <code>Simulink.io.FileType</code> object. Use <i>VariableName</i>, specified as a character array, to extract the desired signal from the file of custom format signals. The method returns the found variable, returned as a cell array of signal variables of supported types. For more information on supported types, see “Choose a Base Workspace and MAT-File Format”.</p> |
| load | <p>This method calls the <code>loadImpl</code> method.</p> <p>Load the signal listed in the custom file type.</p> |
| loadAVariable | <p>This method calls the <code>loadAVariableImpl</code> method.</p> <p>Validate the format of the signals in the custom MAT-file <code>fileName</code> with the associated <code>Simulink.io.FileType</code> reader.</p> |

| | |
|------------------|---|
| validateFileName | This method calls the validateFileNameImpl method. Validate the format of the signals in the custom MAT-file fileName with the associated Simulink.io.FileType reader. |
| whos | This method calls the whosImpl method. Return the contents of the custom file type MAT-file. |

Examples

Subclass FileType

Define a Simulink.io.FileType class.

```
classdef MySignalMatFile < Simulink.io.FileType
end
```

Interact with FileType Using Specialized Functions

Interact with FileType using specialized functions. This example refers to the open('Simulink.io.CreateSignals') sample file.

Get contents of foo.mat.

```
fileName = 'foo.mat';
aReader = Simulink.io.CreateSignals(fileName);
resultOfWhos = whos(aReader);
```

Import custom signals from foo.mat.

```
aFileType = Simulink.io.CreateSignals('foo.mat');
out = import(aFileType);
```

Load the custom signals in foo.mat.

```
aFileType = Simulink.io.CreateSignals('foo.mat');
out = load(aFileType);
```

Load a variable from foo.mat.

```
aFileType = Simulink.io.CreateSignals('foo.mat');
out = loadAVariable( aFileType, 'bar');
```

Export the signals from Signal Editor.

```
ds = Simulink.SimulationData.Dataset;
ds = ds.addElement(timeseries([1:10]', [1:10]'), 'Siganl1');
ds = ds.addElement(timeseries([1:10]', [11:20]'), 'Siganl2');
ds = ds.addElement(timeseries([1:10]', [21:30]'), 'Siganl3');
```

```
aReader = Simulink.io.CreateSignals('myFileToExport.mat');  
didWrite = aReader.export(filePath,{'ds'},{ds},0);
```

See Also

[Simulink.io.BaseWorkspace](#) | [Simulink.io.MatFile](#) | [Simulink.io.ModelWorkspace](#) | [Simulink.io.PluggableNamespace](#) | [Simulink.io.SignalBuilderSpreadsheet](#)

Topics

“Import Custom File Type”

“Create Custom File Type for Import to Signal Editor”

Introduced in R2020a

exportImpl

Class: Simulink.io.FileType

Package: Simulink.io

Export signals to file

Syntax

```
[didWrite,errMsg] = exportImpl(exportFileName,varNames,varValues,isAppend)
```

Description

`[didWrite,errMsg] = exportImpl(exportFileName,varNames,varValues,isAppend)` exports signals from Signal Editor using the specified variables and returns `didWrite` and `errMsg` and saves them to `exportFileName`.

Input Arguments

exportFileName — File name for exported signals

character array

File name for exported signals, specified as a character array.

Data Types: `char`

varNames — Signal names

cell array of character vectors

Signal names, specified as a cell array of character vectors.

Data Types: `cell`

varValues — Signal values

cell array of signal variables

Signal values associated with the signals in `varNames`, specified as a cell array of signal variables of supported types. For more information on supported types, see “Choose a Base Workspace and MAT-File Format”.

Data Types: `cell`

isAppend — Append or overwrite signal file

false or 0 (default) | true or 1

Append or overwrite signal file, specified as true (1) or false (0).

Data Types: `logical`

Output Arguments

didWrite — Whether signals were successfully written

false or 0 | true or 1

Whether the signals were successfully written to `exportFileName`, returned as true (1) or false (0).

errMsg — Error message

character array

Error message, indicating errors with the reporting process, returned as a character array.

Examples

Subclass FileType Class and Implement exportImpl Method

Subclass `FileType` class and implement `exportImpl` method.

```
classdef MySignalMatFile < Simulink.io.FileType
```

Implement the static method `exportImpl`.

methods

```
function [didWrite,errMsg] = exportImpl(obj,fileName,cellOfVarNames, ...
    cellOfVarValues,isAppend)
    didWrite = false;
    errMsg = '';

    saveStruct = struct;

    for k = 1: length (cellOfVarNames)
        saveStruct.(cellOfVarNames{k}) = cellOfVarValues{k};
    end

    try
        if isAppend
            save(fileName,'-struct','saveStruct','-append');
        else
            save(fileName,'-struct','saveStruct');
        end
        didWrite = true;
    catch ME

        % Optional, return errMsg or throw hard error.
        % Returning an error message allows your automated
        % processes to carry on while allowing you to report the
        % error at a later time.
        errMsg = ME.message;
    end
end
end
end
```

See Also

[Simulink.io.FileType](#) | [Simulink.io.FileType.getFileTypeDescription](#) | [Simulink.io.FileType.isFileSupported](#) | [loadImpl](#) | [loadAVariableImpl](#) | [validateFileNameImpl](#) | [whosImpl](#)

Topics

“Import Custom File Type”
 “Export Signals to Custom Registered File Types”
 “Create Custom File Type for Import to Signal Editor”
 “Choose a Base Workspace and MAT-File Format”

Introduced in R2020a

Simulink.io.FileType.getFileTypeDescription

Class: Simulink.io.FileType

Package: Simulink.io

Get custom file reader description

Syntax

```
FileReaderDescription = getFileTypeDescription()
```

Description

FileReaderDescription = getFileTypeDescription() returns the file reader description.

Output Arguments

FileReaderDescription — FileType description

character array

FileType description, returned as a character array. When writing the file type description, consider describing the data layout of the file.

Examples

Subclass FileType Class and Implement getFileTypeDescription Method

Subclass FileType class and implement the getFileTypeDescription method.

```
classdef MySignalMatFile < Simulink.io.FileType
```

Implement the static method getFileTypeDescription.

```
methods ( Static )
    function aFileReaderDescription = getFileTypeDescription( )
        aFileReaderDescription = ['Return a char array describing your reader.'];
    end
end
```

See Also

Simulink.io.FileType | exportImpl | Simulink.io.FileType.isFileSupported | loadAVariableImpl | loadImpl | validateFileNameImpl | whosImpl

Topics

“Import Custom File Type”

“Create Custom File Type for Import to Signal Editor”

Introduced in R2020a

Simulink.io.FileType.isFileSupported

Class: Simulink.io.FileType

Package: Simulink.io

Check if file type is supported in Simulink

Syntax

```
isSupported = isFileSupported(fullFile)
```

Description

`isSupported = isFileSupported(fullFile)` checks if the file located at `fullFile` is supported in Simulink.

Input Arguments

fullFile — Fully qualified file name

character array

Fully qualified file name, specified as a character array.

Example: `C:\mydir\mySignals.csv`

Data Types: `char`

Output Arguments

isSupported — File supported indicator

true (1) | false (0)

File support indicator, returned as true (1) or false (0).

Examples

Subclass FileType Class and Implement isFileSupported Method

Subclass `FileType` class and implement the `isFileSupported` method.

```
classdef MySignalMatFile < Simulink.io.FileType
```

Implement the static method `isFileSupported`.

```
methods ( Static )
```

```
    function isSupported = isFileSupported( fileLocation )
        isSupported = false;
        if exist( fileLocation, 'file' )
            isSupported = true;
        end
```

```
end  
end
```

See Also

`Simulink.io.FileType` | `exportImpl` | `Simulink.io.FileType.getFileTypeDescription` | `loadImpl` | `loadAVariableImpl` | `validateFileNameImpl` | `whosImpl`

Topics

“Import Custom File Type”

“Create Custom File Type for Import to Signal Editor”

Introduced in R2020a

Simulink.io.FileType.isInput

Class: Simulink.io.FileType

Package: Simulink.io

Check if input is acceptable Simulink input

Syntax

```
isSimulinkInput = Simulink.io.FileType.isInput(ts)
```

Description

`isSimulinkInput = Simulink.io.FileType.isInput(ts)` checks if the `ts` argument is a MATLAB variable that can be used as Simulink simulation input.

Input Arguments

ts — Simulink input

MATLAB variable

Simulink input, specified as a MATLAB variable. This variable must be an acceptable Simulink input, such as the data formats listed at “Data Format or Type”.

Example: `timeseries([0;9])`

Data Types: `char` | `string`

Output Arguments

isSimulinkInput — File input indicator

't' (true) | 'f' (false)

File input indicator, returned as 't' (true) or 'f' (false).

Examples

Check Appropriateness of Input

Check if the `timeseries` `ts` is an input supported by Simulink.

Create `timeseries` variable `ts`.

```
ts = timeseries([sin(0:.01:100)'])
```

```
timeseries
```

Common Properties:

```
    Name: 'unnamed'
```

```
    Time: [10001x1 double]
```



```
TimeInfo: [1x1 tsdata.timemetadata]  
Data: [10001x1 double]  
DataInfo: [1x1 tsdata.datametadata]
```

More properties, Methods

Check if *ts* is accepted by Simulink.

```
Simulink.io.FileType.isInput(ts)
```

```
ans =
```

```
logical
```

```
1
```

See Also

[Simulink.io.FileType](#) | [exportImpl](#) | [Simulink.io.FileType.getFileTypeDescription](#) | [Simulink.io.FileType.isSimulinkParameter](#) | [loadImpl](#) | [loadAVariableImpl](#) | [validateFileNameImpl](#) | [whosImpl](#)

Topics

“Data Format or Type”

“Import Custom File Type”

“Create Custom File Type for Import to Signal Editor”

Introduced in R2021b

Simulink.io.FileType.isSimulinkParameter

Class: Simulink.io.FileType

Package: Simulink.io

Check if input is Simulink parameter

Syntax

```
isParameter = Simulink.io.FileType.isSimulinkParameter(aParam)
```

Description

`isParameter = Simulink.io.FileType.isSimulinkParameter(aParam)` checks if the `aParam` argument is a supported Simulink.Parameter type:

- Simulink.Simulation.ModelParameter
- Simulink.Simulation.BlockParameter
- Simulink.Simulation.Variable
- Simulink.op.ModelOperatingPoint

Input Arguments

aParam — Simulink parameter

vector of Simulink parameters | Simulink parameter as scalar

Simulink parameter, specified as a vector or scalar of one of these types:

- Simulink.Simulation.ModelParameter (can be scalar or vector)
- Simulink.Simulation.BlockParameter (can be scalar or vector)
- Simulink.Simulation.Variable (can be scalar or vector)
- Simulink.op.ModelOperatingPoint (must be scalar)

Data Types: single | double | int8 | int16 | int32 | int64 | uint8 | uint16 | uint32 | uint64 | logical | char | string | struct | table | cell | function_handle | categorical | datetime | duration | calendarDuration | fi

Complex Number Support: Yes

Output Arguments

isParameter — Simulink parameter indicator

true (1) | false (0)

Simulink parameter indicator, returned as true (1) or false (0).

Examples

Check if Input Parameter Is Simulink Parameter

Check if the parameter *aParam* is a Simulink parameter.

Create parameter *aParam*.

```
aParam = Simulink.Simulation.BlockParameter('f/g', 'Gain', '5')
```

```
aParam =
```

```
BlockParameter with properties:
```

```
BlockPath: 'f/g'  
Name: 'Gain'  
Value: '5'
```

Check if the parameter *aParam* is a Simulink parameter.

```
Simulink.io.FileType.isSimulinkParameter(aParam)
```

```
ans =
```

```
logical
```

```
1
```

See Also

[Simulink.io.FileType](#) | [exportImpl](#) | [Simulink.io.FileType.getFileTypeDescription](#) | [Simulink.io.FileType.isInput](#) | [loadImpl](#) | [loadAVariableImpl](#) | [validateFileNameImpl](#) | [whosImpl](#)

Topics

“Data Format or Type”

“Import Custom File Type”

“Create Custom File Type for Import to Signal Editor”

Introduced in R2021b

loadImpl

Class: Simulink.io.FileType

Package: Simulink.io

Load signal names from custom FileType object

Syntax

```
matFileData = loadImpl(reader)
```

Description

`matFileData = loadImpl(reader)` loads the signal names listed in the custom FileType object.

Run-Time Details

`loadImpl` is called via `load` when you run the `Simulink.io.FileType` object. You can also run the application, which calls `load`. For details, see “Create Custom File Type for Import to Signal Editor”.

Input Arguments

reader — Signals to load

`Simulink.io.FileType`

Signals to load, specified as a `Simulink.io.FileType` object.

Data Types: `char`

Output Arguments

matFileData — Signals

cell array of signal variables

Variables of signals to load, returned as a cell array of signal variables of supported types. For more information on supported types, see “Choose a Base Workspace and MAT-File Format”.

Examples

Subclass FileType Class and Implement loadImpl Method

Subclass `FileType` class and implement the `loadImpl` method.

```
classdef MySignalMatFile < Simulink.io.FileType
```

Implement the static method `loadImpl`.

methods

```
function structOut = loadImpl(obj)
```

```
structOut = struct;

%assume mat-file
data = load(obj.FileName);
varsOnFile = fieldnames(data);

for k = 1: length(varsOnFile)

    if isSimulinkSignalFormat(data.(varsOnFile{k}))
        structOut.(varsOnFile{k}) = ...
            data.(varsOnFile{k});
    end
end
end
end
```

See Also

[Simulink.io.FileType](#) | [exportImpl](#) | [Simulink.io.FileType.getFileTypeDescription](#) | [Simulink.io.FileType.isFileSupported](#) | [loadAVariableImpl](#) | [validateFileNameImpl](#) | [whosImpl](#)

Topics

“Import Custom File Type”
“Create Custom File Type for Import to Signal Editor”
“Choose a Base Workspace and MAT-File Format”

Introduced in R2020a

loadAVariableImpl

Class: Simulink.io.FileType

Package: Simulink.io

Load specified variable from MAT-file

Syntax

```
varOut = loadAVariableImpl(MATfile,varName)
```

Description

`varOut = loadAVariableImpl(MATfile,varName)` loads the specified variable from the MAT-file.

Input Arguments

MATfile — File name of MAT-file

character array

File name of the MAT-file that contains signals to load, specified as a character array.

Data Types: char

varName — Variable name

character array

Variable name to load, specified as a character array.

Data Types: char

Output Arguments

varOut — Found variable

cell array of signal variables

Found variables to load, returned as a cell array of signal variables of supported types. For more information on supported types, see “Choose a Base Workspace and MAT-File Format”.

Examples

Subclass FileType Class and Implement loadAVariableImpl Method

Subclass `FileType` class and implement `loadAVariableImpl` method.

```
classdef MySignalMatFile < Simulink.io.FileType
```

Implement the static method `loadAVariableImpl`.

```
methods
```

```
function structOut = loadAVariableImpl(obj,varName)

    % Assume loading a variable from a MAT-file.
    data = load(obj.FileName,varName);

    if isempty(fieldnames(data))
        error([varName ' was not found on the file.']);
    end

    if isSimulinkSignalFormat(data.(varName))
        structOut.(varName) = ...
            data.(varName);
    else
        error([varName ' is not a Simulink signal format.']);
    end
end
end
```

See Also

[Simulink.io.FileType](#) | [exportImpl](#) | [Simulink.io.FileType.getFileTypeDescription](#) | [Simulink.io.FileType.isFileSupported](#) | [loadImpl](#) | [validateFileNameImpl](#) | [whosImpl](#)

Topics

“Import Custom File Type”

“Create Custom File Type for Import to Signal Editor”

“Choose a Base Workspace and MAT-File Format”

Introduced in R2020a

validateFileNameImpl

Class: Simulink.io.FileType

Package: Simulink.io

Validate contents of custom MAT-file

Syntax

```
validateFileNameImpl(reader, fileName)
```

Description

`validateFileNameImpl(reader, fileName)` validates the format of the signals in the custom MAT-file `fileName` with the associated `Simulink.io.FileType` reader.

Input Arguments

reader — Reader

`Simulink.io.FileType` object

Reader, specified as a `Simulink.io.FileType` object.

fileName — File name of MAT-file

character array

File name of a MAT-file that contains custom signals, specified as a character array.

Data Types: `char`

Examples

Subclass FileType Class and Implement validateFileNameImpl Method

Subclass `FileType` class and implement the `validateFileNameImpl` method.

```
classdef MySignalMatFile < Simulink.io.FileType
```

Implement static method `validateFileNameImpl`.

```
function validateFileNameImpl(aFile, filename) %#ok<INUSL>
%validateFileNameImpl

[-, ~, fileExt] = fileparts( filename );
isSupported = strcmpi(fileExt, '.mat');

if ~isSupported
    error('This file format is not supported by application. ');
end
```

end

See Also

`Simulink.io.FileType` | `exportImpl` | `Simulink.io.FileType.getFileTypeDescription` | `Simulink.io.FileType.isFileSupported` | `loadAVariableImpl` | `loadImpl` | `whosImpl`

Introduced in R2020a

whosImpl

Class: Simulink.io.FileType

Package: Simulink.io

Determine contents of MAT-file associated with Simulink.io.FileType object

Syntax

```
signals = whosImpl(reader)
```

Description

`signals = whosImpl(reader)` returns a structure containing the contents of the MAT-file associated with the `Simulink.io.FileType` object.

Run-Time Details

`whosImpl` is called via `whos` when you run the application. For details, see “Create Custom File Type for Import to Signal Editor”.

Input Arguments

reader — Reader

Simulink.io.FileType object

Reader, specified as a `Simulink.io.FileType` object.

Output Arguments

signals — Contents of MAT-file

array of structures

Contents of the MAT-file, returned as an array of structures. This structure has a signal name ['char array'] and an optional signal type of a supported type. For more information on supported types, see “Choose a Base Workspace and MAT-File Format”.

Examples

Subclass FileType Class and Implement whosImpl Method

Subclass `FileType` class and implement the `whosImpl` method.

```
classdef MySignalMatFile < Simulink.io.FileType
```

Implement the static method `whosImpl`.

methods

```
function outOnFile = whosImpl(obj)  
    onFile = whos(obj.FileName);
```

```
numVars = length(onFile);  
outOnFile(1).name = [];  
outOnFile(1).type = [];  
for k = 1: length(numVars)  
    outOnFile(k).name = onFile(k).name;  
    if strcmpi( onFile(k).class, 'Simulink.SimulationData.Dataset' )  
        outOnFile(k).type = 'Dataset';  
    else  
        % Assume Signal(timeseries or timetable)  
        % other acceptable types  
        % - Bus      : for bus signals  
        % - Ground: for grounds (empty double)  
        % - FunctionCall: for single column double data arrays  
        outOnFile(k).type = 'Signal';  
    end  
end  
end  
end
```

See Also

[Simulink.io.FileType](#) | [exportImpl](#) | [Simulink.io.FileType.getFileTypeDescription](#) | [Simulink.io.FileType.isFileSupported](#) | [loadImpl](#) | [loadAVariableImpl](#) | [validateFileNameImpl](#)

Topics

“Create Custom File Type for Import to Signal Editor”

“Choose a Base Workspace and MAT-File Format”

Introduced in R2020a

Simulink.io.MatFile class

Package: Simulink.io

Read data in MAT-file format

Description

Simulink.io.MatFile inherits from the Simulink.io.FileType base class. It reads data formatted in a format used by MAT-files. To import data from a MAT-file, use this class.

```
classdef MatFile < Simulink.io.FileType
```

The Simulink.io.MatFile class is a handle class.

Class Attributes

| | |
|------------------|-------|
| Abstract | false |
| HandleCompatible | true |

For information on class attributes, see “Class Attributes”.

Properties

iofile.STAMatFile — MAT-file reader

character array

MAT-file reader, specified as a character array.

Attributes:

| | |
|-----------|--------|
| GetAccess | public |
| SetAccess | public |

Data Types: char | string

Methods

Specialized Operators and Functions

These methods specialize standard MATLAB operators and functions for objects in this class.

| | |
|-----------------|---|
| isFileSupported | This method always returns true because it operates only on data in the MAT-file. |
| getFileTypeId | This method returns the MAT-file reader description for MAT-files containing data with loading and logging signal formats that Simulink supports. |

Examples

Read Data in MAT-File Format

Read data in MAT-file format from file, `foo.mat`.

```
fileName = 'foo.mat';  
aReader = Simulink.io.MatFile(fileName);  
resultOfWhos = whos(aReader);
```

Load the reader, which has no inputs.

```
varsOnFileStruct = load(aReader);
```

Load one variable.

```
var = loadAVariable(aReader, 'ts');
```

Import all the variables from the MAT-file, `foo.mat`.

```
importedVars = import(aReader);
```

Export to a MAT-file, `bar.mat`.

```
ds = Simulink.SimulationData.Dataset;  
ds = ds.addElement(timeseries([1:10]', [1:10]'), 'Signal1');  
ds = ds.addElement(timeseries([1:10]', [11:20]'), 'Signal2');  
ds = ds.addElement(timeseries([1:10]', [21:30]'), 'Signal3');
```

```
filePath = 'bar.mat';  
didWrite = aReader.export(filePath, {'ds'}, {ds}, 0);
```

See Also

[Simulink.io.BaseWorkspace](#) | [Simulink.io.FileType](#) |
[Simulink.io.SignalBuilderSpreadsheet](#) | [exportImpl](#) | [getFileTypeIdDescription](#) |
[Simulink.io.FileType.isFileSupported](#) | [loadImpl](#) | [loadAVariableImpl](#) |
[validateFileNameImpl](#) | [whosImpl](#)

Topics

“Import Custom File Type”

“Create Custom File Type for Import to Signal Editor”

Introduced in R2021a

Simulink.io.ModelWorkspace class

Package: Simulink.io

Read data in format used by model workspace

Description

Simulink.io.ModelWorkspace inherits from the Simulink.io.FileType base class. It reads data formatted in a format used by the model workspace. Use model workspace file types to move data to and from the model workspace to a function, an automated process, or a user interface. To import data from the model workspace, use this command.

```
classdef ModelWorkspace < Simulink.io.FileType
```

The Simulink.io.ModelWorkspace class is a handle class.

Class Attributes

| | |
|------------------|-------|
| Abstract | false |
| HandleCompatible | true |

For information on class attributes, see “Class Attributes”.

Properties

DataSource — Source for initializing variables in model workspace

'Model File' (default) | 'MAT-File' | 'MATLAB Code' | 'MATLAB File'

Source for initializing the variables in the model workspace, specified as one of these character vectors:

Attributes:

| | |
|-----------|--------|
| GetAccess | public |
| SetAccess | public |

Data Types: char | string

FileName — Name of external file that stores or creates variables

' ' (empty character vector) (default) | character vector

Name of the external file that stores or creates variables, specified as a character vector. To enable this property, set DataSource to 'MAT-File' or 'MATLAB File'.

Attributes:

| | |
|-----------|--------|
| GetAccess | public |
| SetAccess | public |

Data Types: char | string

MATLABCode — MATLAB code for initializing variables

'' (empty character vector) (default) | character vector

MATLAB code for initializing variables, specified as a character vector. To enable this property, set `DataSource` to 'MATLAB Code'.

Attributes:

| | |
|------------------------|--------|
| <code>GetAccess</code> | public |
| <code>SetAccess</code> | public |

Data Types: char | string

Methods**Specialized Operators and Functions**

These methods specialize standard MATLAB operators and functions for objects in this class.

| | |
|---------------------------------|---|
| <code>isFileSupported</code> | This method always returns true because it operates only on data in the base workspace. |
| <code>getFileDescription</code> | This method returns the base workspace file reader description. |

Examples**Read Data in Model Workspace Format**

Set up `myExample` to use with the model workspace and perform basic operations.

Set up the model workspace for the `myExample`. Assign `timeseries([1;3])` as the value of `aSignal`.

```
myExample;
```

```
mWS = get_param('myExample','ModelWorkspace');
assignin(mWS, 'aSignal', timeseries([1;3]));
```

Determine the contents of the MAT-file `aFileType` associated with the `Simulink.io.ModelWorkspace` object.

```
aFileType = Simulink.io.ModelWorkspace('myExample.slx');
```

```
%whos on file
```

```
out = whos(aFileType)
```

```
out =
```

```
struct with fields:
```

```
name: 'aSignal'
type: 'Signal'
```

Load signal names from the `aFileType` of the `myExample` model workspace.

```

aFileType = Simulink.io.ModelWorkspace( 'myExample.slx' );
%load
out = load( aFileType )

out =

    struct with fields:

        aSignal: [1x1 timeseries]

aFileType = Simulink.io.ModelWorkspace( 'myExample.slx' );
%import all
out = import( aFileType )

out =

    struct with fields:

        Data: {[1x1 timeseries]}
        Names: {'aSignal'}

out =

    struct with fields:

        Data: {[1x1 timeseries]}
        Names: {'aSignal'}

```

Import the specified variable *aSignal* from the model workspace.

```

aFileType = Simulink.io.ModelWorkspace( 'myExample.slx' );
var = importAVariable( aFileType, 'aSignal' )

```

timeseries

```

Common Properties:
    Name: 'unnamed'
    Time: [2x1 double]
    TimeInfo: [1x1 tsdata.timemetadadata]
    Data: [2x1 double]
    DataInfo: [1x1 tsdata.datametadadata]

```

More properties, Methods

Write a structure of signals to a MAT-file.

```

ts = timeseries([11112;36532415]);
aFileType = Simulink.io.ModelWorkspace( 'minportsOnly_withOutputs.slx' );
[didWrite, errMsg ] = export( aFileType, 'minportsOnly_withOutputs.slx', ...
    {'ts'}, {ts}, ...
    false )

```

didWrite =

logical

1

errMsg =

0×0 empty char array

See Also

Simulink.io.FileType | Simulink.io.MatFile |
Simulink.io.SignalBuilderSpreadsheet | exportImpl | getFileTypeDescription |
Simulink.io.FileType.isFileSupported | loadImpl | loadAVariableImpl |
validateFileNameImpl | whosImpl

Topics

“Import Custom File Type”

“Create Custom File Type for Import to Signal Editor”

Introduced in R2021b

Simulink.io.PluggableNamespace class

Package: Simulink.io

Register Simulink.io.FileType objects from different name space

Description

Use the Simulink.io.PluggableNamespace class interface to implement a name space to register Simulink.io.FileType objects from custom name spaces.

In your class definition file, you must subclass your object from this base class. Simulink requires direct inheritance from PluggableNamespace.

The process to contain the new class is similar to the one to create a custom file type. To contain your class, create a folder and add that folder path to the MATLAB path. In that folder, create a +Simulink folder, and inside that folder, create a +io folder.

To examine issues with the registration of these objects, use the Simulink.io.getFileTypeDiagnostics function.

The Simulink.io.PluggableNamespace class is a handle class.

Class Attributes

| | |
|------------------|-------|
| Abstract | false |
| HandleCompatible | true |

For information on class attributes, see “Class Attributes”.

Creation

Description

`classdef SimulinkIOPlugin < Simulink.io.PluggableNamespace` creates a name space.

Properties

NameSpace — Name space to register

character array

Name space to register, specified as a character array.

Example: `Namespace = 'Simulink.io'`

Attributes:

| | |
|-----------|--------|
| GetAccess | public |
|-----------|--------|

Data Types:

Examples

Create Pluggable Name Space

Create a pluggable name space, MyNamespace.

Inherit from the `Simulink.io.PluggableNamespace` base class.

```
classdef MyNamespace < Simulink.io.PluggableNamespace
```

Implement the property, `Namespace`, as `MyNamespace`.

```
    properties (Access = public, Constant)
        Namespace = 'MyNamespace';
    end
end
```

You can now create a folder on the MATLAB path, create a folder such as `+MyNamespace` and place your file types in that folder.

See Also

`Simulink.io.FileType` | `Simulink.io.getFileTypeDiagnostics`

Introduced in R2021a

Simulink.io.SignalBuilderSpreadsheet class

Package: Simulink.io

Read spreadsheet in format used by Signal Builder

Description

Simulink.io.SignalBuilderSpreadsheet inherits from the Simulink.io.FileType base class. It reads spreadsheets formatted in a format used by Signal Builder. To import spreadsheets used in Signal Builder, use this class.

```
classdef SignalBuilderSpreadsheet < Simulink.io.FileType
```

The Simulink.io.SignalBuilderSpreadsheet class is a handle class.

Class Attributes

| | |
|------------------|-------|
| Abstract | false |
| HandleCompatible | true |

For information on class attributes, see “Class Attributes”.

Properties

Public Properties

FileName — File name

character array

File name of file that contains signals to import to Signal Editor, specified as a character array.

Attributes:

| | |
|-----------|--------|
| GetAccess | public |
| SetAccess | public |

Data Types:

Methods

Specialized Operators and Functions

These methods specialize standard MATLAB operators and functions for objects in this class.

| | |
|------------------|--|
| export | <p>This method calls the <code>exportImpl</code> method.</p> <p>From Signal Editor, write the structure of signals to a MAT-file. The structure must contains two cell arrays; one for signal names and one for signal values. Specify if the method appends to or overwrites the contents of the MAT-file. The method indicates if it succeeded in writing to the MAT-file and returns any error messages.</p> |
| import | <p><code>[importedData, warnStr] = import(reader)</code></p> <p>To import custom signals for a custom file type, identify the custom file type <i>reader</i> as a <code>Simulink.io.FileType</code> object. The method returns the found variable as a cell array of signal variables of supported types. For more information on supported types, see “Choose a Base Workspace and MAT-File Format”. The method returns a structure with two fields, <code>Data</code> and <code>Name</code>. <code>Data</code> is a cell array of signals and <code>Name</code> is a cell array of character vectors of the corresponding signal names.</p> |
| importAVariable | <p><code>varOut = importAVariable(reader,variableName)</code></p> <p>To import a specified variable for a custom file type, identify the custom file type reader as a <code>Simulink.io.FileType</code> object. Use <i>VariableName</i>, specified as a character array, to extract the desired signal from the file of custom format signals. The method returns the found variable, returned as a cell array of signal variables of supported types. For more information on supported types, see “Choose a Base Workspace and MAT-File Format”.</p> |
| load | <p>This method calls the <code>loadImpl</code> method.</p> <p>Load the signal listed in the custom file type.</p> |
| loadAVariable | <p>This method calls the <code>loadAVariableImpl</code> method.</p> <p>Validate the format of the signals in the custom MAT-file <code>fileName</code> with the associated <code>Simulink.io.FileType</code> reader.</p> |
| validateFileName | <p>This method calls the <code>validateFileNameImpl</code> method.</p> <p>Validate the format of the signals in the custom MAT-file <code>fileName</code> with the associated <code>Simulink.io.FileType</code> reader.</p> |

| | |
|------|---|
| whos | This method calls the whosImpl method. Return the contents of the custom file type MAT-file. |
|------|---|

Examples

Interact with SignalBuilderSpreadsheet Using Specialized Functions

Interact with FileType using specialized functions. This example refers to the open('Simulink.io.CreateSignals') sample file.

Get contents of Signal Builder format foo.xlsx spreadsheet.

```
fileName = 'foo.xlsx';
aReader = Simulink.io.SignalBuilderSpreadsheet(fileName);
resultOfWhos = whos( aReader );
```

Load the custom signals in foo.xlsx.

```
fileName = 'foo.xlsx';

aReader = Simulink.io.SignalBuilderSpreadsheet(fileName);
varsOnFileStruct = load(aReader, 'myGroup1');
```

Load a variable from foo.xlsx.

```
fileName = 'foo.xlsx';

aReader = Simulink.io.SignalBuilderSpreadsheet(fileName);
var = loadAVariable(aReader, 'myGroup1');
```

Import custom signals from foo.xlsx.

```
fileName = 'foo.xlsx';

aReader = Simulink.io.SignalBuilderSpreadsheet(fileName);
importedVars = import(aReader, 'myGroup1');
```

Export the signals from Signal Editor.

```
ds = Simulink.SimulationData.Dataset;
ds = ds.addElement(timeseries([1:10]', [1:10]'), 'Signal1'); %#ok<*NBRAK>
ds = ds.addElement(timeseries([1:10]', [11:20]'), 'Signal2');
ds = ds.addElement(timeseries([1:10]', [21:30]'), 'Signal3');

aReader = Simulink.io.SignalBuilderSpreadsheet('myFileToExport.xls');
didWrite = aReader.export(filePath, {'ds'}, {ds}, 0);
```

See Also

Simulink.io.FileType | exportImpl | getFileTypeDescription |
Simulink.io.FileType.isFileSupported | loadImpl | loadAVariableImpl |
validateFileNameImpl | whosImpl

Topics

“Import Custom File Type”
“Create Custom File Type for Import to Signal Editor”

Introduced in R2020a

Simulink.lookuptable.Breakpoint class

Package: Simulink.lookuptable

Configure breakpoint set data for lookup table object

Description

An object of the Simulink.lookuptable.Breakpoint class stores breakpoint set information for a lookup table. The object resides in the Breakpoints property of a Simulink.LookupTable object or Simulink.Breakpoint object.

You can use Simulink.LookupTable and Simulink.Breakpoint objects to store and configure a lookup table for ASAP2 and AUTOSAR code generation.

To represent multiple breakpoint sets for a multidimensional lookup table, store a vector of Simulink.lookuptable.Breakpoint objects in the Breakpoints property of a Simulink.LookupTable object.

To share a breakpoint set between multiple lookup tables, use a Simulink.Breakpoint object to store and configure the breakpoint set information. Use the object in a Prelookup block and create Simulink.LookupTable objects to use in Interpolation Using Prelookup blocks.

Construction

When you create a Simulink.LookupTable object or Simulink.Breakpoint object, a Simulink.lookuptable.Breakpoint object appears as the value of the Breakpoints property.

To create more Simulink.lookuptable.Breakpoint objects for a Simulink.LookupTable object, use this technique:

Access the Breakpoints property by specifying a vector index.

To create a Simulink.lookuptable.Breakpoint object, you can set the value of any of the object properties. The Simulink.LookupTable object creates the Simulink.lookuptable.Breakpoint object with default property values, and sets the property that you specified.

The value of the Breakpoints property is an array of Simulink.lookuptable.Breakpoint objects. Each embedded object represents one breakpoint set.

For example, suppose that you create a Simulink.LookupTable object named LUTObj. To create more breakpoint sets, access the Breakpoints property by specifying vector indices:

```
LUTObj.Breakpoints(1).Value = [-1 1];  
LUTObj.Breakpoints(2).Value = [-2 -1 0 1 2];  
LUTObj.Breakpoints(3).Value = [-5 -3 0 3 5];
```

The object LUTObj creates additional Simulink.lookuptable.Breakpoint objects and sets the Value property of each object. LUTObj now stores information for three breakpoint sets.

Properties

Data Type — Data type of breakpoint set elements

'auto' (default) | character vector

Data type of breakpoint set elements, specified as a character vector. You can explicitly specify an integer, half data type, a floating-point, a fixed-point data type, or a data type expression such as the name of a `Simulink.AliasType` object.

The default value, 'auto', means that the breakpoint set acquires a data type from the value that you specify in the `Value` property. If you use an untyped expression such as `[1 2 3]` to set `Value`, the breakpoint data use the data type `double`. If you specify a typed expression such as `single([1 2 3])` or an `fi` object, the breakpoint data use the data type specified by the expression or object.

For more information about data types in Simulink, see “Data Types Supported by Simulink”. To decide how to control the data types of table and breakpoint data in `Simulink.LookupTable` and `Simulink.Breakpoint` objects, see “Control Data Types of Lookup Table Objects” (Simulink Coder).

Example: 'int16'

Example: 'myTypeAlias'

Data Types: char

Description — Description of breakpoint set

' ' (default) | character vector

Description of the breakpoint set, specified as a character vector.

Example: 'This breakpoint set represents the pressure input.'

Data Types: char

Dimensions — Dimension lengths of breakpoint set

[0 0] (default) | numeric vector

Dimension lengths of the breakpoint set, returned as a numeric vector or specified as a character vector.

To use symbolic dimensions, specify a character vector.

FieldName — Name of structure field that stores breakpoint set data

'BP' (default) | character vector

Name of a structure field in the generated code, specified as a character vector. This field stores the breakpoint set data.

The code generator uses this property only under these circumstances, which cause the breakpoint data to appear in the generated code as a structure field:

- The `Simulink.lookupable.Breakpoint` object exists in a `Simulink.LookupTable` object and in the `Simulink.LookupTable` object you set `BreakpointsSpecification` to 'Explicit values'.
- The `Simulink.lookupable.Breakpoint` object exists in a `Simulink.Breakpoint` object and in the `Simulink.Breakpoint` object you set `SupportTunableSize` to true.

Example: 'MyBkptSet1'

Data Types: char

Max — Maximum value of breakpoint set elements

[] (default) | numeric double value

Maximum value of the elements of the breakpoint set, specified as a numeric, real value of the data type double.

Example: 17.23

Data Types: double

Min — Minimum value of breakpoint set elements

[] (default) | numeric double value

Minimum value of the elements of the breakpoint set, specified as a numeric, real value of the data type double.

Example: -52.6

Data Types: double

TunableSizeName — Name of structure field that stores length of breakpoint set

'N' (default) | character vector

Name of a structure field in the generated code, specified as a character vector. This field stores the length of the breakpoint set, which the generated code algorithm uses to determine the size of the table. To tune the effective size of the table during code execution, change the value of this structure field in memory.

The code generator uses this property only under these circumstances, which enable a tunable table size in the generated code:

- The `Simulink.lookuptable.Breakpoint` object exists in a `Simulink.LookupTable` object and in the `Simulink.LookupTable` object you set:
 - `BreakpointsSpecification` to 'Explicit values'.
 - `SupportTunableSize` to true.
- The `Simulink.lookuptable.Breakpoint` object exists in a `Simulink.Breakpoint` object and in the `Simulink.Breakpoint` object you set `SupportTunableSize` to true.

Example: 'LengthForDim1'

Data Types: char

Unit — Physical unit of breakpoint set

' ' (default) | character vector

Physical unit of the elements of the breakpoint set, specified as a character vector.

Example: 'inches'

Data Types: char

Value — Breakpoint set data

[] (default) | numeric vector

The breakpoint set data, specified as a numeric vector with at least two elements. To control the data type of the breakpoint set, use the `DataType` property of the `Simulink.lookupable.Breakpoint` object.

When you set `DataType` to `'auto'`, to set the `Value` property, use a typed expression such as `single([1 2 3])` or use the `fi` constructor to embed an `fi` object.

Example: `[10 20 30]`

Data Types: `single` | `double` | `half` | `int8` | `int16` | `int32` | `uint8` | `uint16` | `uint32` | `fi`

Copy Semantics

Value. To learn how value classes affect copy operations, see [Copying Objects](#).

See Also

[Simulink.LookupTable](#) | [Simulink.Breakpoint](#)

Introduced in R2016b

Simulink.lookupable.Evenspacing class

Package: Simulink.lookupable

Configure even spacing set data for lookup table object

Description

An object of the Simulink.lookupable.Evenspacing class stores event spacing set information for a lookup table. The object resides in the Evenspacing property of a Simulink.LookupTable object.

You can use Simulink.LookupTable objects to store and configure a lookup table for ASAP2 and AUTOSAR code generation.

To represent multiple breakpoint sets for a multidimensional lookup table, store a vector of Simulink.lookupable.Evenspacing objects in the Evenspacing property of a Simulink.LookupTable object.

Construction

When you create a Simulink.LookupTable object and set BreakpointSpecification to 'Even spacing', a Simulink.lookupable.Evenspacing object appears as the value of the Breakpoints property.

To create more Simulink.lookupable.Evenspacing objects for a Simulink.LookupTable object, use this technique:

Access the Breakpoints property by specifying a vector index.

To create a Simulink.lookupable.Evenspacing object, you can set the value of any of the object properties. The Simulink.LookupTable object creates the Simulink.lookupable.Evenspacing object with default property values, and sets the property that you specified.

The value of the Breakpoints property is an array of Simulink.lookupable.Evenspacing objects. Each embedded object represents one breakpoint set.

For example, suppose that you create a Simulink.LookupTable object named myLUTObj. To create more breakpoint sets, access the Breakpoints property by specifying scalar indices for FirstPoint and Spacing properties. To create more even spacing breakpoint sets, update the object with this pair of properties:

```
LUTObj.Breakpoints(1).FirstPoint=-1;
LUTObj.Breakpoints(1).Spacing=2;
LUTObj.Breakpoints(1).FirstPoint=-2;
LUTObj.Breakpoints(1).Spacing=1;
LUTObj.Breakpoints(1).FirstPoint=-5;
LUTObj.Breakpoints(1).Spacing=2;
```

The object `myLUTObj` creates additional `Simulink.lookupable.Evenspacing` objects and sets the `FirstPoint` and `Spacing` properties of each object. `LUTObj` now stores information for three breakpoint sets.

Properties

FirstPoint — First point in evenly spaced breakpoint data

[] (default) | numeric scalar

First point in evenly spaced breakpoint data, specified as a numeric scalar. To control the data type of the breakpoint set, use the `DataType` property of the `Simulink.lookupable.Evenspacing` object.

When you set `DataType` to 'auto', to set the `FirstPoint` property, use a typed expression such as `single(1)` or use the `fi` constructor to embed a `fi` object.

Example: -1

Data Types: `single` | `double` | `int8` | `int16` | `int32` | `uint8` | `uint16` | `uint32` | `fi`

Spacing — Spacing between points in evenly spaced breakpoint data

[] (default) | numeric, positive, monotonically increasing scalar

Spacing between points in evenly spaced breakpoint data, specified as a numeric scalar. To control the data type of the breakpoint set, use the `DataType` property of the `Simulink.lookupable.Evenspacing` object.

When you set `DataType` to 'auto', to set the `Spacing` property, use a typed expression such as `single(1)` or use the `fi` constructor to embed an `fi` object.

Example: -1

Data Types: `single` | `double` | `int8` | `int16` | `int32` | `uint8` | `uint16` | `uint32` | `fi`

DataType — Data type of breakpoint set elements

'auto' (default) | character vector

Data type of breakpoint set elements, specified as a character vector. You can explicitly specify an integer, a floating-point, a fixed-point data type, or a data type expression such as the name of a `Simulink.AliasType` object.

The default value, 'auto', means that the breakpoint set acquires a data type from the value that you specify in the `Value` property. If you use an untyped expression such as `[1 2 3]` to set `Value`, the breakpoint data use the data type `double`. If you specify a typed expression such as `single([1 2 3])` or an `fi` object, the breakpoint data use the data type specified by the expression or object.

For more information about data types in Simulink, see “Data Types Supported by Simulink”. To decide how to control the data types of table and breakpoint data in `Simulink.LookupTable` and `Simulink.Breakpoint` objects, see “Control Data Types of Lookup Table Objects” (Simulink Coder).

Example: 'int16'

Example: 'myTypeAlias'

Data Types: `char`

Min — Minimum value of breakpoint set elements

[] (default) | numeric double value

Minimum value of the elements of the breakpoint set, specified as a numeric, real value of the data type `double`.

Example: `-52.6`

Data Types: `double`

Max — Maximum value of breakpoint set elements

[] (default) | numeric double value

Maximum value of the elements of the breakpoint set, specified as a numeric, real value of the data type `double`.

Example: `17.23`

Data Types: `double`

Unit — Physical unit of breakpoint set

' ' (default) | character vector

Physical unit of the elements of the breakpoint set, specified as a character vector.

Example: `'inches'`

Data Types: `char`

FirstPointName — Name of the Simulink.LookupTable.Evenspacing object that stores the information for the first point

'BPFIRSTPOINT1' (default) | character vector

Name of the `Simulink.Breakpoint` object that stores the information for the first point, specified as a character vector. Generated code uses this name to display the first point.

Example: `'myFirstPointName'`

Data Types: `char`

SpacingName — Name of the Simulink.LookupTable.Evenspacing object that stores the information for the spacing

'auto' (default) | character vector

Name of the `Simulink.Breakpoint` object that stores the information for the spacing, specified as a character vector. Generated code uses this name to display the spacing.

Example: `'mySpacing'`

Data Types: `char`

TunableSizeName — Name of structure field that stores length of breakpoint set

'N' (default) | character vector

Name of a structure field in the generated code, specified as a character vector. This field stores the length of the breakpoint set, which the generated code algorithm uses to determine the size of the table. To tune the effective size of the table during code execution, change the value of this structure field in memory.

The code generator uses the property only under these circumstances, which enable a tunable table size in the generated code:

- The `Simulink.lookupable.Evenspacing` object exists in a `Simulink.LookupTable` object, in which you set `BreakpointsSpecification` to `'Even spacing'` and `SupportTunableSize` to `true`.

Example: `'LengthForDim1'`

Data Types: `char`

Description — Description of breakpoint set

`''` (default) | character vector

Description of the breakpoint set, specified as a character vector.

Example: `'This breakpoint set represents the pressure input.'`

Data Types: `char`

Copy Semantics

Value. To learn how value classes affect copy operations, see [Copying Objects](#).

See Also

`Simulink.LookupTable` | `Simulink.lookupable.Breakpoint`

Introduced in R2017b

Simulink.lookupable.StructTypeInfo class

Package: Simulink.lookupable

Configure settings for structure type that lookup table object uses in the generated code

Description

An object of the `Simulink.lookupable.StructTypeInfo` class controls the structure type that the generated code creates to store data for lookup table objects. The `Simulink.lookupable.StructTypeInfo` object resides in the `StructTypeInfo` property of a `Simulink.LookupTable` object or `Simulink.Breakpoint` object. Use these parent objects to store and configure a lookup table for ASAP2 and AUTOSAR code generation.

A `Simulink.LookupTable` object appears as a structure in the generated code when you set the `Specification` property to 'Explicit values'. A `Simulink.Breakpoint` object appears as a structure in the generated code when you set the `SupportTunableSize` property to true.

Construction

When you create a `Simulink.LookupTable` or `Simulink.Breakpoint` object, a `Simulink.lookupable.StructTypeInfo` object appears as the value of the `StructTypeInfo` property.

Properties

DataScope — Scope of structure type definition

'Auto' (default) | 'Exported' | 'Imported'

Scope of structure type definition, specified as a character vector.

Data Types: char

HeaderFileName — Name of header file that contains structure type definition

' ' (default) | character vector

Name of the header file that contains the structure type definition, specified as a character vector.

Example: 'myHdr.h'

Data Types: char

Name — Name of structure type

' ' (default) | character vector

Name of the structure type, specified as a character vector.

Data Types: char

Copy Semantics

Value. To learn how value classes affect copy operations, see Copying Objects.

See Also

`Simulink.LookupTable` | `Simulink.Breakpoint`

Introduced in R2016b

Simulink.lookuptable.Table class

Package: Simulink.lookuptable

Configure table data for lookup table object

Description

An object of the Simulink.lookuptable.Table class stores table information for a lookup table. The object resides in the Table property of a Simulink.LookupTable object. You can use the Simulink.LookupTable object to store and configure a lookup table for ASAP2 and AUTOSAR code generation.

Construction

When you create a Simulink.LookupTable object, a Simulink.lookuptable.Table object appears as the value of the Table property.

Properties

Data Type — Data type of table data elements

'auto' (default) | character vector

Data type of the table data elements, specified as a character vector. You can explicitly specify an integer data type, half data type, a floating-point data type, a fixed-point data type, or a data type expression such as the name of a Simulink.AliasType object.

The default value, 'auto', means that the table data acquire a data type from the value that you specify in the Value property. If you use an untyped expression such as [1 2 3] to set Value, the table data use the data type double. If you specify a typed expression such as single([1 2 3]) or an fi object, the table data use the data type specified by the expression or object.

For more information about data types in Simulink, see “Data Types Supported by Simulink”. To decide how to control the data types of table and breakpoint data in Simulink.LookupTable and Simulink.Breakpoint objects, see “Control Data Types of Lookup Table Objects” (Simulink Coder).

Example: 'int16'

Example: 'myTypeAlias'

Data Types: char

Description — Description of table data

' ' (default) | character vector

Description of the table data, specified as a character vector.

Example: 'This lookup table describes the action of a pump.'

Data Types: char

Dimensions — Dimension lengths of table data

[0 0] (default) | numeric vector

Dimension lengths of the table data, returned as a numeric vector or specified as a character vector.

To use symbolic dimensions, specify a character vector.

FieldName — Name of a structure field in the generated code

'Table' (default) | character vector

Name of a structure field in the generated code, specified as a character vector. This field stores the table data if you configure the `Simulink.LookupTable` object to appear in the generated code as a structure.

Example: 'MyPumpTable'

Data Types: char

Max — Maximum value of table data elements

[] (default) | numeric double value

Maximum value of the elements of the table data, specified as a numeric, real value of the data type `double`.

Example: 17.23

Data Types: double

Min — Minimum value of table data elements

[] (default) | numeric double value

Minimum value of the elements of the table data, specified as a numeric, real value of the data type `double`.

Example: -52.6

Data Types: double

Unit — Physical unit of table elements

' ' (default) | character vector

Physical unit of the elements of the table data, specified as a character vector.

Example: 'degC'

Data Types: char

Value — Table data

[] (default) | numeric vector or multidimensional array

The table data, specified as a numeric vector or multidimensional array with at least two elements. To control the data type of the table data, use the `DataType` property of the `Simulink.lookupTable.Table` object.

When you set `DataType` to 'auto', to set the `Value` property, use a typed expression such as `single([1 2 3])` or use the `fi` constructor to embed an `fi` object.

Example: [10 20 30; 40 50 60]

Data Types: single | double | half | int8 | int16 | int32 | uint8 | uint16 | uint32 | fi

Copy Semantics

Value. To learn how value classes affect copy operations, see Copying Objects.

See Also

`Simulink.LookupTable` | `Simulink.Breakpoint`

Introduced in R2016b

Simulink.ModelAdvisor

Run Model Advisor from MATLAB file

Description

To run the Model Advisor, use instances of this class in MATLAB programs. For example, you can perform a standard set of checks.

Many `Simulink.ModelAdvisor` object methods require or return IDs. An *ID* is a unique identifier for a Model Advisor check, task, or group. IDs must remain constant. A `Simulink.ModelAdvisor` object includes methods that enable you to retrieve the ID or IDs for:

- All checks, tasks, and groups
- Checks belonging to groups and tasks
- The active check
- Selected checks, tasks, and groups

To find check IDs in the Model Advisor, use the check context menu.

| Find | Action |
|---|---|
| Check ID | <ol style="list-style-type: none"> 1 In the left pane of the Model Advisor, select the check. 2 Right-click the check name and select Send Check ID to Workspace. The ID is displayed in the Command Window and sent to the base workspace. |
| Check IDs for selected checks in a folder | <ol style="list-style-type: none"> 1 In the left pane of the Model Advisor, select the checks for which you want IDs. Clear the other checks in the folder. 2 Right-click the folder and select Send Check ID to Workspace. An array of the selected check IDs are sent to the base workspace. |

If you have a Simulink Check license, consider using the `ModelAdvisor.run` function or the `Advisor.Application.run` method instead of the `Simulink.ModelAdvisor.runCheck` or `runTask` functions.

Consider using `Advisor.Application` class if you have a large model with subsystems and model references. `Advisor.Application` does not run checks on library models. If you want to run checks on multiple independent models that are not in a model reference hierarchy or you want to leverage parallel processing, use `ModelAdvisor.run` to run Model Advisor checks on your model.

Creation

Syntax

```
ma = Simulink.ModelAdvisor.getModelAdvisor(system)
```

Description

MATLAB creates an instance of this object for each model that you open in the current MATLAB session. To get a handle to a model's Model Advisor object, execute this command: `ma = Simulink.ModelAdvisor.getModelAdvisor(system)` where `system` is the name of the model or subsystem that you want to check. Your program can then use the Model Advisor object methods to initialize and run the Model Advisor checks.

Input Arguments

system — Model or subsystem name

character vector

Model or subsystem that the Model Advisor checks.

Data Types: `char`

Properties

EmitInputParametersToReport — Display check input parameters in Model Advisor report

`true` (default) | `false`

A value of `true` displays input parameters in the Model Advisor report. A value of `false` does not display input parameters in the Model Advisor report.

Data Types: `char`

Object Functions

| | |
|--|--|
| <code>closeReport</code> | Close Model Advisor report |
| <code>deselectCheck</code> | Clear Model Advisor check |
| <code>deselectCheckAll</code> | Clear Model Advisor checks |
| <code>deselectCheckForGroup</code> | Clear Model Advisor checks for groups |
| <code>deselectCheckForTask</code> | Clear Model Advisor checks that belong to a specified task or set of tasks |
| <code>deselectTask</code> | Clear Model Advisor checks that belong to a specified task or set of tasks |
| <code>deselectTaskAll</code> | Clear all Model Advisor tasks |
| <code>displayReport</code> | Display report in Model Advisor window |
| <code>exportReport</code> | Create copy of Model Advisor report |
| <code>filterResultWithExclusion</code> | Filter excluded objects |
| <code>getBaselineMode</code> | Determine whether Model Advisor is in baseline data generation mode |
| <code>getCheckAll</code> | Get check IDs of all Model Advisor checks |
| <code>getCheckForGroup</code> | Get checks belonging to Model Advisor check group |
| <code>getCheckForTask</code> | Get checks belonging to a task |
| <code>getCheckResult</code> | Get Model Advisor check results |
| <code>getCheckResultData</code> | Obtain Model Advisor check result data |
| <code>getCheckResultStatus</code> | Obtain Model Advisor check result status |
| <code>getGroupAll</code> | Get all groups of checks that Model Advisor runs |
| <code>getInputParameters</code> | Get Model Advisor check input parameters |
| <code>Simulink.ModelAdvisor.getModelAdvisor</code> | Get Model Advisor object for system or subsystem |
| <code>getSelectedCheck</code> | Get currently selected Model Advisor checks |
| <code>getSelectedSystem</code> | Get system that Model Advisor targets |

| | |
|------------------------------------|---|
| getSelectedTask | Get selected Model Advisor tasks |
| getTaskAll | Get tasks run by Model Advisor |
| Simulink.ModelAdvisor.openConfigUI | Starts Model Advisor Configuration Editor |
| Simulink.ModelAdvisor.reportExists | Determine whether Model Advisor report exists for model or subsystem |
| runCheck | Run currently selected checks |
| runTask | Run currently selected tasks |
| selectCheck | Select checks |
| selectCheckAll | Select all checks |
| selectCheckForGroup | Select check group |
| selectCheckForTask | Select checks for a specific task or tasks |
| selectTask | Select Model Advisor task |
| selectTaskAll | Select all Model Advisor tasks |
| setActionEnable | Set status for check action |
| setBaselineMode | Set Model Advisor baseline mode |
| setCheckErrorSeverity | Set severity of check failure |
| setCheckResult | Set result for currently running check |
| setCheckResultData | Set result data for currently running check |
| setCheckResultStatus | Set status for currently running check |
| setInputParameters | Specify input parameters |
| verifyCheckRan | Verify that Model Advisor ran a set of checks |
| verifyCheckResult | Generate baseline Model Advisor check results file or compare current check results to baseline check results |
| verifyCheckResultStatus | Verify that a model passed or failed a set of checks |
| verifyHTML | Generate baseline Model Advisor report or compare current report to baseline report |

See Also

Topics

“Run Model Advisor Checks”

Introduced in R2006a

closeReport

Package: Simulink

Close Model Advisor report

Syntax

```
closeReport(ma)
```

Description

For a Model Advisor object, use the `closeReport(ma)` method to close a Model Advisor Report.

Input Arguments

ma — Model Advisor object

`Simulink.ModelAdvisor` object

`Simulink.ModelAdvisor` object for which you want to close the corresponding Model Advisor report.

See Also

`Simulink.ModelAdvisor`

Introduced in R2006a

deselectCheck

Package: Simulink

Clear Model Advisor check

Syntax

```
output = deselectCheck(ma,checkID)
```

Description

For a Model Advisor object, use the `output = deselectCheck(ma,checkID)` method to clear a Model Advisor check. This method cannot clear disabled checks.

Input Arguments

ma — Model Advisor object

Simulink.ModelAdvisor object

Simulink.ModelAdvisor object that you want to clear Model Advisor check(s).

checkID — Check IDs associated with Model Advisor check(s)

character vector | cell array of character vectors

Model Advisor Check IDs for which you want to clear from the Model Advisor.

Example: 'mathworks.design.UnconnectedLinesPorts'

Output Arguments

output — Logical value

boolean

A logical value indicating whether Simulink cleared the specified check. A value of 1 indicates success. A value of 0 indicates that Simulink was not able to clear the specified check.

See Also

Simulink.ModelAdvisor

Introduced in R2006a

deselectCheckAll

Package: Simulink

Clear Model Advisor checks

Syntax

```
output = deselectCheckAll(ma)
```

Description

For a Model Advisor object, use the `output = deselectCheckAll(ma)` method to clear all selected Model Advisor checks. This method cannot clear disabled checks.

Input Arguments

ma — Model Advisor object

`Simulink.ModelAdvisor` object

`Simulink.ModelAdvisor` object for which you want to clear all selected Model Advisor checks.

Output Arguments

output — Logical value

`boolean`

A logical value indicating whether Simulink cleared all selected checks. A value of 1 indicates success. A value of 0 indicates that Simulink did not clear all checks.

See Also

`Simulink.ModelAdvisor`

Introduced in R2006a

deselectCheckForGroup

Package: Simulink

Clear Model Advisor checks for groups

Syntax

```
output = deselectCheckForGroup(ma,groupName)
```

Description

For a Model Advisor object, use the `output = deselectCheckForGroup(ma,groupName)` method to clear all selected Model Advisor checks for one or more groups. To locate the group name, use the `getGroupAll` method.

Input Arguments

ma — Model Advisor object

`Simulink.ModelAdvisor` object

`Simulink.ModelAdvisor` object for which you want to clear all selected Model Advisor checks for one or more groups.

groupName — Check group names

character vector | cell array of character vectors

Name of group or groups that contain the selected Model Advisor checks that you want to clear.

Output Arguments

output — Logical value

boolean

A logical value indicating whether Simulink cleared the checks for the specified group. A value of 1 indicates success. A value of 0 indicates that Simulink did not clear the specified checks.

See Also

`Simulink.ModelAdvisor`

Introduced in R2006a

deselectCheckForTask

Package: Simulink

Clear Model Advisor checks that belong to a specified task or set of tasks

Syntax

```
output = deselectCheckForTask(ma,task)
```

Description

For a Model Advisor object, use the `output = deselectCheckForTask(ma,task)` method to clear all selected Model Advisor checks for one or more tasks. To locate the task name, use the `getTaskAll` method.

Input Arguments

ma — Model Advisor object

`Simulink.ModelAdvisor` object

`Simulink.ModelAdvisor` object for which you want to clear all selected Model Advisor checks for a task or tasks

task — Task name

character vector | cell array of character vectors

Name of task or tasks that contain selected Model Advisor checks that you want to clear.

Output Arguments

output — Logical value

boolean

A logical value indicating whether Simulink cleared the checks for the specified group. A value of 1 indicates success. A value of 0 indicates that Simulink did not clear the specified checks.

See Also

`Simulink.ModelAdvisor`

Introduced in R2006a

deselectTask

Package: Simulink

Clear Model Advisor checks that belong to a specified task or set of tasks

Syntax

```
output = deselectTask(ma,task)
```

Description

For a Model Advisor object, use the `output = deselectTask(ma,task)` method to clear all selected Model Advisor checks for one or more tasks. To locate the task name, use the `getTaskAll` method.

Input Arguments

ma — Model Advisor object

Simulink.ModelAdvisor object

Simulink.ModelAdvisor object for which you want to clear all selected Model Advisor checks for a task or tasks

task — Task name

character vector | cell array of character vectors

Name of task or tasks that contain selected Model Advisor checks that you want to clear.

Output Arguments

output — Logical value

boolean

A logical value indicating whether Simulink removed the checks for the specified task. A value of 1 indicates success. A value of 0 indicates that Simulink was not able to clear the checks for the specified task.

See Also

Simulink.ModelAdvisor

Introduced in R2006a

deselectTaskAll

Package: Simulink

Clear all Model Advisor tasks

Syntax

```
output = deselectTaskAll(ma)
```

Description

For a Model Advisor object, use the `output = deselectTaskAll(ma)` method to clear all selected Model Advisor checks for all tasks.

Input Arguments

ma — Model Advisor object

`Simulink.ModelAdvisor` object

`Simulink.ModelAdvisor` object for which you want to clear all selected Model Advisor checks for all tasks

Output Arguments

output — Logical value

`boolean`

A logical value indicating whether Simulink cleared the checks for all tasks. A value of 1 indicates success. A value of 0 indicates that Simulink did not clear the checks.

See Also

`Simulink.ModelAdvisor`

Introduced in R2006a

displayReport

Package: Simulink

Display report in Model Advisor window

Syntax

```
displayReport(ma)
```

Description

For a Model Advisor object, use the `displayReport(ma)` method to display a Model Advisor report in the Model Advisor window. The report includes the most recent results of running checks on the system corresponding to the Model Advisor object and the current selection status of checks, groups, and tasks for the system.

Input Arguments

ma — Model Advisor object

`Simulink.ModelAdvisor` object

`Simulink.ModelAdvisor` object for which you want to open the corresponding Model Advisor report.

See Also

`Simulink.ModelAdvisor`

Introduced in R2006a

exportReport

Package: Simulink

Create copy of Model Advisor report

Syntax

```
[output, message] = exportReport(ma, destination)
```

Description

For a Model Advisor object, use the `[output, message] = exportReport(ma, destination)` method to create a copy of a Model Advisor report. The report includes the most recent results of running checks on the system corresponding to the Model Advisor object and the current selection status of checks, groups, and tasks for the system.

Input Arguments

ma — Model Advisor object

Simulink.ModelAdvisor object

Simulink.ModelAdvisor object for which you want to export the corresponding Model Advisor report.

destination — Path name

character vector

Path name to report file location.

Output Arguments

output — Logical value

boolean

A logical value indicating whether Simulink created a report in location that you specify by `destination` input argument. A value of 1 indicates success. A value of 0 indicates that Simulink did not create a copy of the report in the specified location.

message — Reason why report was not created

character vector

This output argument is empty if a report is created. If a report was not created, this argument contains the reason why.

See Also

Simulink.ModelAdvisor

Introduced in R2006a

filterResultWithExclusion

Package: Simulink

Filter excluded objects

Syntax

```
filteredResultHandles = filterResultWithExclusion(ma,ResultHandles)
```

Description

Use the `filteredResultHandles = filterResultWithExclusion(ma,ResultHandles)` method to filter objects that have exclusions enabled and cause a check warning or failure.

This method is intended for excluding objects from custom checks that you create by using the Model Advisor customization API, available with Simulink Check.

Input Arguments

ma — Model Advisor object

Simulink.ModelAdvisor object

Simulink.ModelAdvisor object for which you want to filter objects causing exclusion enabled checks to warn or fail.

ResultHandles — Array of model objects causing a check warning or failure

array of model objects

Array of objects causing a check warning or failure.

Output Arguments

filteredResultHandles — Array of objects causing a check warning or failure

array of objects

An array of objects causing exclusion enabled checks to warn or fail.

See Also

Simulink.ModelAdvisor

Topics

“Exclude Blocks From Custom Checks” (Simulink Check)

Introduced in R2006a

getBaselineMode

Package: Simulink

Determine whether Model Advisor is in baseline data generation mode

Syntax

```
mode = getBaselineMode(ma)
```

Description

`mode = getBaselineMode(ma)` returns true if the Model Advisor is in baseline data mode. Baseline data mode causes the verification methods of the Model Advisor, for example, `verifyHTML`, to generate baseline data.

Input Arguments

ma — Model Advisor object

`Simulink.ModelAdvisor` object

`Simulink.ModelAdvisor` object for which you want to determine if it is in baseline data mode.

Output Arguments

mode — Boolean value indicating baseline mode

0 (default)

A value of 1 indicates that the Model Advisor is in baseline data generation mode.

See Also

`Simulink.ModelAdvisor`

Introduced in R2006a

getCheckAll

Package: Simulink

Get check IDs of all Model Advisor checks

Syntax

```
CheckIDs = getCheckAll(ma)
```

Description

The `CheckIDs = getCheckAll(ma)` method returns a cell array of character vectors specifying the Check IDs of all checks that the Model Advisor performs.

Input Arguments

ma — Model Advisor object

`Simulink.ModelAdvisor` object

`Simulink.ModelAdvisor` object for which you want to get the Check IDs of all checks that the Model Advisor performs.

Output Arguments

CheckIDs — Model Advisor Check IDs

cell array of character vectors

Cell array of character vectors specifying the Check IDs of all Model Advisor checks.

See Also

`Simulink.ModelAdvisor`

Introduced in R2006a

getCheckForGroup

Package: Simulink

Get checks belonging to Model Advisor check group

Syntax

```
groupChecks = getCheckForGroup(ma,groupName)
```

Description

For a Model Advisor object, use the `groupChecks = getCheckForGroup(ma,groupName)` method to get all of the Model Advisor checks in a group. To locate the group name, use the `getGroupAll` method.

Input Arguments

ma — Model Advisor object

Simulink.ModelAdvisor object

Simulink.ModelAdvisor object for which you want to get all of the Model Advisor checks corresponding to a check group.

groupName — Check group name

character vector

Name of group that contains the Model Advisor checks.

Example: 'Simulink Coder'

Output Arguments

groupChecks — Model Advisor checks

cell array of character vectors

Checks that belong to a Model Advisor group.

See Also

Simulink.ModelAdvisor

Introduced in R2006a

getCheckForTask

Package: Simulink

Get checks belonging to a task

Syntax

```
taskChecks = getCheckForTask(ma,taskID)
```

Description

For a Model Advisor object, use the `taskChecks = getCheckForTask(ma,taskID)` method to get all of the Model Advisor checks that are part of a task. To locate the task name, use the `getTaskAll` method.

Input Arguments

ma — Model Advisor object

Simulink.ModelAdvisor object

Simulink.ModelAdvisor object for which you want to get all of the Model Advisor checks that are part of a task.

taskID — Task name

character vector

Name of task that contains the Model Advisor checks.

Example: `'_SYSTEM_By Task_Modeling_Physical_Systems'`

Output Arguments

taskChecks — Model Advisor checks

cell array of character vectors

Checks that are part of a Model Advisor task

See Also

Simulink.ModelAdvisor

Introduced in R2006a

getCheckResult

Package: Simulink

Get Model Advisor check results

Syntax

```
results = getCheckResult(ma,checkID)
```

Description

For a Model Advisor object, use the `results = getCheckResult(ma,checkID)` method to get the results of running a check or set of checks.

This method enables you to access results generated by custom checks that you create using the Model Advisor customization API, an optional feature available with Simulink Check software. For more information, see “Define Your Own Custom Model Advisor Checks” (Simulink Check).

Input Arguments

ma — Model Advisor object

Simulink.ModelAdvisor object

Simulink.ModelAdvisor object for which you want to obtain check results.

checkID — Check IDs associated with Model Advisor check

character vector|cell array of character vectors

Model Advisor Check IDs for which you want to obtain results.

Example: 'mathworks.design.UnconnectedLinesPorts'

Output Arguments

results — Check results

cell array

Cell array of check results. The result format depends on the check data.

See Also

Simulink.ModelAdvisor

Introduced in R2006a

getCheckResultData

Package: Simulink

Obtain Model Advisor check result data

Syntax

```
results = getCheckResultData(ma,checkID)
```

Description

For a Model Advisor object, use the `results = getCheckResultData(ma,checkID)` method to get the check result data for a specified set of checks.

This method enables you to access results generated by custom checks that you create using the Model Advisor customization API, an optional feature available with Simulink Check software. For more information, see “Define Your Own Custom Model Advisor Checks” (Simulink Check).

Input Arguments

ma — Model Advisor object

Simulink.ModelAdvisor object

Simulink.ModelAdvisor object for which you want to obtain check result data.

checkID — Check IDs associated with Model Advisor checks

character vector|cell array of character vectors

Model Advisor Check IDs that you want to obtain results

Example: 'mathworks.design.UnconnectedLinesPorts'

Output Arguments

results — Check results

cell array

Data from a check result or cell array of data from check results. The data format depends on the checks that generate the data.

See Also

Simulink.ModelAdvisor

Introduced in R2006a

getCheckResultStatus

Package: Simulink

Obtain Model Advisor check result status

Syntax

```
status = getCheckResultStatus(ma,checkID)
```

Description

After running a set of checks, use the `status = getCheckResultStatus(ma,checkID)` method to determine whether these checks passed or failed.

Input Arguments

ma — Model Advisor object

Simulink.ModelAdvisor object

Simulink.ModelAdvisor object for which you want to determine whether a check or set of checks passed or failed.

checkID — Model Advisor Check IDs

character vector | cell array of character vectors

Model Advisor Check IDs for which you want to obtain results.

Example: 'mathworks.design.UnconnectedLinesPorts'

Output Arguments

status — Pass or fail

Boolean | cell array of Boolean values

Boolean value or cell array of Boolean values indicating the pass or fail status of a check or set of checks.

See Also

Simulink.ModelAdvisor

Introduced in R2006a

getGroupAll

Package: Simulink

Get all groups of checks that Model Advisor runs

Syntax

```
groupChecks = getGroupAll(ma)
```

Description

For a Model Advisor object, use the `groupChecks = getGroupAll(ma)` method to get all groups of checks that the Model Advisor runs.

Input Arguments

ma — Model Advisor object

Simulink.ModelAdvisor object

Simulink.ModelAdvisor object for which you want to determine all Model Advisor check groups.

Output Arguments

groupChecks — Model Advisor check groups

cell array of character vectors

IDs of check groups that the Model Advisor runs.

See Also

Simulink.ModelAdvisor

Introduced in R2006a

getInputParameters

Package: Simulink

Get Model Advisor check input parameters

Syntax

```
params = getInputParameters(ma,CheckID)
```

Description

Use the `params = getInputParameters(ma,CheckID)` method to get the input parameters for a Model Advisor check.

This method enables you to access custom checks that you create using Simulink Check. For more information, see “Define Your Own Custom Model Advisor Checks” (Simulink Check).

Input Arguments

ma — Model Advisor object

`Simulink.ModelAdvisor` object

`Simulink.ModelAdvisor` object for which you determine the input parameters for specific Model Advisor check.

CheckID — Model Advisor check

character vector

Model Advisor check ID for which to obtain its input parameters. If you use the method inside a check callback function, you can omit this argument.

Example: `'mathworks.design.UnconnectedLinesPorts'`

Output Arguments

params — Input parameters

cell array of `ModelAdvisor.InputParameter` objects

Cell array that contains the `ModelAdvisor.InputParameter` objects for a Model Advisor check.

See Also

`Simulink.ModelAdvisor`

Topics

“Run Model Advisor Checks”

Introduced in R2006a

getListViewParameters

Package: Simulink

Get Model Advisor checklist parameters displayed in checklist view

Syntax

```
params = getListViewParameters(ma,CheckID)
```

Description

Use the `params = getListViewParameters(ma,CheckID)` method to get the list view of parameters for a Model Advisor check.

This method enables you to access custom checks that you create by using Simulink Check. For more information, see “Define Your Own Custom Model Advisor Checks” (Simulink Check).

Input Arguments

ma — Model Advisor object

Simulink.ModelAdvisor object

Simulink.ModelAdvisor object for which you determine the list view of parameters for a specific Model Advisor check.

CheckID — Model Advisor check

character vector

Name of Model Advisor check for which to obtain its parameters in list view. You can omit this argument if you use the method inside a check callback function.

Example: 'mathworks.design.UnconnectedLinesPorts'

Output Arguments

params — Input parameters

cell array of ModelAdvisor.ListViewParameter objects

Cell array that contains the ModelAdvisor.ListViewParameter objects for a Model Advisor check.

See Also

Simulink.ModelAdvisor | ModelAdvisor.ListViewParameter

Introduced in R2006a

Simulink.ModelAdvisor.getModelAdvisor

Package: Simulink

Get Model Advisor object for system or subsystem

Syntax

```
ma = Simulink.ModelAdvisor.getModelAdvisor(system,new)
```

Description

Use the `ma = Simulink.ModelAdvisor.getModelAdvisor(system,new)` method to return an instance of a `Simulink.ModelAdvisor` class for the model or subsystem that you specify by using the `system` input argument.

Input Arguments

system — Model or subsystem name

character vector

Name of model or subsystem for which you obtain the corresponding `Simulink.ModelAdvisor` object.

Example: 'sldemo_fuelsys_dd_controller'

Example: 'sldemo_fuelsys_dd_controller/airflow_calc'

Data Types: char

new — New Model Advisor object

character vector

This argument is optional except when changing the Model Advisor working scope from one system to another without closing the previous session. Alternatively, you can close the previous session before invoking the `getModelAdvisor` method.

Data Types: char

Output Arguments

ma — Model Advisor object

`Simulink.ModelAdvisor` object

`Simulink.ModelAdvisor` object for a model or subsystem that you specify by using a `system` input argument.

See Also

`Simulink.ModelAdvisor`

Introduced in R2006a

getSelectedCheck

Package: Simulink

Get currently selected Model Advisor checks

Syntax

```
CheckIDs = getSelectedCheck(ma)
```

Description

Use the `CheckIDs = getSelectedCheck(ma)` method to obtain the selected Model Advisor checks for a corresponding `Simulink.ModelAdvisor` object.

Input Arguments

ma — Model Advisor object

`Simulink.ModelAdvisor` object

`Simulink.ModelAdvisor` object for which you want to obtain the selected Model Advisor checks.

Output Arguments

CheckIDs — Model Advisor checks

cell array of character vectors

Check IDs of currently selected Model Advisor checks.

See Also

`Simulink.ModelAdvisor`

Introduced in R2006a

getSelectedSystem

Package: Simulink

Get system that Model Advisor targets

Syntax

```
system = getSelectedSystem(ma)
```

Description

Use the `system = getSelectedSystem(ma)` method to obtain the model or subsystem that is the target of the `Simulink.ModelAdvisor` object.

Input Arguments

ma — Model Advisor object

`Simulink.ModelAdvisor` object

`Simulink.ModelAdvisor` object for which you want to obtain the model or subsystem that the object targets.

Output Arguments

system — Model or subsystem

character vector

Name of the model or subsystem that the `ModelAdvisor` object `ma` targets.

See Also

`Simulink.ModelAdvisor`

Introduced in R2006a

getSelectedTask

Package: Simulink

Get selected Model Advisor tasks

Syntax

```
TaskIDs = getSelectedTask(ma)
```

Description

Use the `TaskIDs = getSelectedTask(ma)` method to obtain the tasks that are selected for the `Simulink.ModelAdvisor` object `ma`.

Input Arguments

ma — Model Advisor object

`Simulink.ModelAdvisor` object

`Simulink.ModelAdvisor` object for which you want to obtain the currently selected tasks.

Output Arguments

TaskIDs — Model Advisor Task IDs

cell array of character vectors

Cell array of selected Task IDs for the `Simulink.ModelAdvisor` object that you specify as an input.

See Also

`Simulink.ModelAdvisor`

Introduced in R2006a

getTaskAll

Package: Simulink

Get tasks run by Model Advisor

Syntax

```
TaskIDs = getTaskAll(ma)
```

Description

Use the `TaskIDs = getTaskAll(ma)` method to obtain the tasks that are run for the `Simulink.ModelAdvisor` object `ma`.

Input Arguments

ma — Model Advisor object

`Simulink.ModelAdvisor` object

`Simulink.ModelAdvisor` object for which you want to obtain the tasks that the Model Advisor ran.

Output Arguments

TaskIDs — Model Advisor Task IDs

cell array of character vectors

Cell array of Task IDs that are run for the `Simulink.ModelAdvisor` object that you specify as an input.

See Also

`Simulink.ModelAdvisor`

Introduced in R2006a

Simulink.ModelAdvisor.openConfigUI

Package: Simulink

Starts Model Advisor Configuration Editor

Syntax

```
Simulink.ModelAdvisor.openConfigUI(ma)
```

Description

Use the `Simulink.ModelAdvisor.openConfigUI(ma)` method to open the Model Advisor Configuration Editor. Use the Model Advisor Configuration Editor to create custom Model Advisor configurations.

The Model Advisor Configuration Editor is available with Simulink Check. For more information, see “Use the Model Advisor Configuration Editor to Customize the Model Advisor” (Simulink Check).

Before starting the Model Advisor Configuration Editor, make sure that the current folder is writable. If the folder is not writable, you see an error message when you start the Model Advisor Configuration Editor.

The Model Advisor Configuration Editor uses the `slprj` folder in the “Code generation folder” to store reports and other information. If the `slprj` folder does not exist in the code generation folder, the Model Advisor Configuration Editor creates it. For more information, see “Manage Simulation Targets for Referenced Models”.

Input Arguments

ma — Model Advisor object

`Simulink.ModelAdvisor` object

`Simulink.ModelAdvisor` object for which you want to open the Model Advisor Configuration Editor.

See Also

`Simulink.ModelAdvisor`

Introduced in R2006a

Simulink.ModelAdvisor.reportExists

Package: Simulink

Determine whether Model Advisor report exists for model or subsystem

Syntax

```
exists = Simulink.ModelAdvisor.reportExists(system)
```

Description

Use the `exists = Simulink.ModelAdvisor.reportExists(system)` method to determine whether a Model Advisor report exists in the `slprj/modeladvisor` subfolder of the MATLAB working folder.

Input Arguments

system — Model or subsystem

character vector

Model or subsystem for which you want to determine whether a Model Advisor report exists.

Output Arguments

exists — Boolean value indicating whether Model Advisor report exists

Boolean

Boolean value that indicates whether Model Advisor report exists. A value of 1 indicates that the report exists. A value of 0 indicates that the report does not exist.

See Also

Simulink.ModelAdvisor

Introduced in R2006a

runCheck

Package: Simulink

Run currently selected checks

Syntax

```
success = runCheck(ma,checkID)
```

Description

The `success = runCheck(ma,checkID)` method runs selected Model Advisor checks. Invoking this method is equivalent to selecting the **Run Selected Checks** button on the Model Advisor.

If you have a Simulink Check license, consider using the `ModelAdvisor.run` function or the `Advisor.Application.run` method instead of the `Simulink.ModelAdvisor.runCheck` or `runTask` functions.

Consider using `Advisor.Application` class if you have a large model with subsystems and model references. `Advisor.Application` does not run checks on library models. If you want to run checks on multiple independent models that are not in a model reference hierarchy or you want to leverage parallel processing, use `ModelAdvisor.run` to run Model Advisor checks on your model.

Input Arguments

ma — Model Advisor object

`Simulink.ModelAdvisor` object

`Simulink.ModelAdvisor` object for which you want to run Model Advisor.

checkID — Model Advisor check IDs

character vector | cell array of character vectors

If you want to run the Model Advisor on a subset of the currently selected Model Advisor checks, specify this optional input parameter.

Example: `'mathworks.design.UnconnectedLinesPorts'`

Output Arguments

success — Boolean value indicating whether the Model Advisor ran on selected checks

Boolean

Boolean value that indicates whether the Model Advisor ran on the selected checks. A value of 1 indicates that the Model Advisor successfully ran on the selected checks. A value of 0 indicates that the Model Advisor did not run on the selected checks.

See Also

`Simulink.ModelAdvisor`

Introduced in R2006a

runTask

Package: Simulink

Run currently selected tasks

Syntax

```
success = runTask(ma)
```

Description

The `success = runTask(ma)` method runs selected Model Advisor tasks. Invoking this method is equivalent to the **Run Selected Checks** button on the Model Advisor.

If you have a Simulink Check license, consider using the `ModelAdvisor.run` function or the `Advisor.Application.run` method instead of the `Simulink.ModelAdvisor.runCheck` or `runTask` functions.

Consider using `Advisor.Application` class if you have a large model with subsystems and model references. `Advisor.Application` does not run checks on library models. If you want to run checks on multiple independent models that are not in a model reference hierarchy or you want to leverage parallel processing, use `ModelAdvisor.run` to run Model Advisor checks on your model.

Input Arguments

ma — Model Advisor object

`Simulink.ModelAdvisor` object

`Simulink.ModelAdvisor` object for which you want to run the Model Advisor.

Output Arguments

success — Boolean value indicating whether the Model Advisor ran selected tasks

Boolean

Boolean value that indicates whether the Model Advisor ran on the selected tasks. A value of 1 indicates that the Model Advisor successfully ran on the selected tasks. A value of 0 indicates that the Model Advisor did not run on the selected tasks.

See Also

`Simulink.ModelAdvisor`

Introduced in R2006a

selectCheck

Package: Simulink

Select checks

Syntax

```
success = selectCheck(ma,checkID)
```

Description

The `success = selectCheck(ma,checkID)` method selects Model Advisor checks.

Input Arguments

ma — Model Advisor object

Simulink.ModelAdvisor object

Simulink.ModelAdvisor object for which you want to select Model Advisor checks.

checkID — Model Advisor Check IDs

character vector | cell array of character vectors

Model Advisor checks for you to select.

Example: 'mathworks.design.UnconnectedLinesPorts'

Output Arguments

success — Boolean value indicating whether the Model Advisor selected the checks

Boolean

Boolean value that indicates whether the Model Advisor selected the checks. A value of 1 indicates that the Model Advisor successfully selected the specified checks. A value of 0 indicates that the Model Advisor did not select the specified checks.

See Also

Simulink.ModelAdvisor

Introduced in R2006a

selectCheckAll

Package: Simulink

Select all checks

Syntax

```
success = selectCheckAll(ma)
```

Description

The `success = selectCheckAll(ma)` method selects all Model Advisor checks.

Input Arguments

ma — Model Advisor object

`Simulink.ModelAdvisor` object

`Simulink.ModelAdvisor` object for which you want to select all Model Advisor checks.

Output Arguments

success — Boolean value indicating whether all Model Advisor checks are selected

`Boolean`

`Boolean` value that indicates whether all Model Advisor checks are selected. A value of `1` indicates that the Model Advisor successfully selected all checks. A value of `0` indicates that the Model Advisor did not select all checks.

See Also

`Simulink.ModelAdvisor`

Introduced in R2006a

selectCheckForGroup

Package: Simulink

Select check group

Syntax

```
success = selectCheckForGroup(ma,groupName)
```

Description

The `success = selectCheckForGroup(ma,groupName)` method selects all Model Advisor checks in the group that you specify.

Input Arguments

ma — Model Advisor object

`Simulink.ModelAdvisor` object

`Simulink.ModelAdvisor` object for which you want to select the Model Advisor checks.

groupName — Check group name

character vector | cell array of character vectors

Name of groups that contain the Model Advisor checks that you want to select.

Output Arguments

success — Boolean value indicating whether the Model Advisor selected the checks

Boolean

Boolean value that indicates whether the Model Advisor selected the checks. A value of 1 indicates that the Model Advisor successfully selected the specified checks. A value of 0 indicates that the Model Advisor did not select the specified checks.

See Also

`Simulink.ModelAdvisor`

Introduced in R2006a

selectCheckForTask

Package: Simulink

Select checks for a specific task or tasks

Syntax

```
success = selectCheckforTask(ma,taskIDs)
```

Description

Use the `success = selectCheckforTask(ma,taskIDs)` method to select the checks for a task or tasks.

Input Arguments

ma — Model Advisor object

`Simulink.ModelAdvisor` object

`Simulink.ModelAdvisor` object for which you want to select checks for a specific task or tasks.

taskIDs — Model Advisor Task IDs

cell array of character vectors | character vector

Cell array of Task IDs for the `Simulink.ModelAdvisor` object that you specify as an input.

Output Arguments

success — Boolean value indicating whether the checks are selected

Boolean

Boolean value that indicates whether the Model Advisor successfully selected the checks for the specified task or tasks. A value of 1 indicates that the Model Advisor successfully selected the checks. A value of 0 indicates that the Model Advisor did not select the checks.

See Also

`Simulink.ModelAdvisor`

Introduced in R2006a

selectTask

Package: Simulink

Select Model Advisor task

Syntax

```
success = selectTask(ma, TaskIDs)
```

Description

The `success = selectTask(ma, TaskIDs)` method selects the Model Advisor tasks.

Input Arguments

ma — Model Advisor object

Simulink.ModelAdvisor object

Simulink.ModelAdvisor object for which you want to select Model Advisor tasks.

TaskIDs — Model Advisor Task IDs

cell array of character vectors

Cell array of Task IDs that you want to select for the Simulink.ModelAdvisor object, which you specify as an input.

Output Arguments

success — Boolean value indicating whether Model Advisor selected tasks

Boolean

Boolean value that indicates whether the Model Advisor selected tasks. A value of 1 indicates that the Model Advisor successfully selected the tasks. A value of 0 indicates that the Model Advisor did not select the tasks.

See Also

Simulink.ModelAdvisor

Introduced in R2006a

selectTaskAll

Package: Simulink

Select all Model Advisor tasks

Syntax

```
success = selectTaskAll(ma)
```

Description

The `success = selectTaskAll(ma)` method selects all Model Advisor tasks.

Input Arguments

ma — Model Advisor object

`Simulink.ModelAdvisor` object

`Simulink.ModelAdvisor` object for which you want to select the Model Advisor tasks.

Output Arguments

success — Boolean value indicating whether Model Advisor selected tasks

`Boolean`

`Boolean` value that indicates whether the Model Advisor selected tasks. A value of 1 indicates that the Model Advisor successfully selected the tasks. A value of 0 indicates that the Model Advisor did not select the tasks.

See Also

`Simulink.ModelAdvisor`

Introduced in R2006a

setActionEnable

Package: Simulink

Set status for check action

Syntax

```
setActionEnable(ma, value)
```

Description

The `setActionEnable(ma, value)` method enables or disables the Action box. Only a check callback function can invoke this method.

This method enables you to access custom checks that you create by using the Model Advisor customization API, an optional feature that is available with Simulink Check software. For more information, see “Define Your Own Custom Model Advisor Checks” (Simulink Check).

Input Arguments

ma — Model Advisor object

Simulink.ModelAdvisor object

Simulink.ModelAdvisor object for which you want to set check action status.

value — Boolean value indicating whether to enable or disable the Model Advisor Action box

Boolean

Boolean value that indicates whether to enable or disable Model Advisor **Action** box. To enable the box, specify a value of `true`. To disable the box, specify a value of `false`.

See Also

Simulink.ModelAdvisor

Introduced in R2006a

setBaselineMode

Package: Simulink

Set Model Advisor baseline mode

Syntax

```
setBaselineMode(ma,mode)
```

Description

Use the `setBaselineMode(ma,mode)` method to set the Model Advisor baseline mode. Baseline mode causes the Model Advisor verify methods to generate baseline comparison data for verifying the results of a Model Advisor run.

Input Arguments

ma — Model Advisor object

`Simulink.ModelAdvisor` object

`Simulink.ModelAdvisor` object for which you want to set the baseline mode.

mode — Boolean value indicating the Model Advisor baseline mode

`Boolean`

Boolean value that indicates the Model Advisor baseline mode. A value of `true` indicates that baseline mode is on. A value of `false` indicates that baseline mode is off.

See Also

`Simulink.ModelAdvisor`

Introduced in R2006a

setCheckErrorSeverity

Package: Simulink

Set severity of check failure

Syntax

```
setCheckErrorSeverity(ma, value)
```

Description

Use the `setCheckErrorSeverity(ma, value)` method to set the check error severity for the currently running check. Only the callback function of a check can invoke this method.

This method enables you to access custom checks that you create by using the Model Advisor customization API, an optional feature that is available with Simulink Check software. For more information, see “Define Your Own Custom Model Advisor Checks” (Simulink Check).

Input Arguments

***ma* — Model Advisor object**

`Simulink.ModelAdvisor` object

`Simulink.ModelAdvisor` object for which you want to set the check error severity for the currently running check.

***value* — Integer indicating severity of failure**

0 (default) | integer

A value of 0 indicates a warning check result. A value of 1 indicates a failed check result.

See Also

`Simulink.ModelAdvisor`

Introduced in R2006a

setCheckResult

Package: Simulink

Set result for currently running check

Syntax

```
success = setCheckResult(ma,result)
```

Description

Use the `success = setCheckResult(ma,result)` method to set the check result for the currently running check. Only the callback function of a check can invoke this method.

This method enables you to access custom checks that you create using the Model Advisor customization API, an optional feature that is available with Simulink Check software. For more information, see “Define Your Own Custom Model Advisor Checks” (Simulink Check).

Input Arguments

ma — Model Advisor object

Simulink.ModelAdvisor object

Simulink.ModelAdvisor object for which you want to set the result for the currently running check.

result — Result to be set

character vector | cell array of character vectors

Character vector or cell array that specifies the result of the currently running check.

Output Arguments

success — Boolean value indicating whether the result is set

Boolean

Boolean value that indicates whether the Model Advisor successfully set the result for the currently running check. A value of 1 indicates that the Model Advisor successfully set the result. A value of 0 indicates that the Model Advisor did not set the result.

See Also

Simulink.ModelAdvisor

Introduced in R2006a

setCheckResultData

Package: Simulink

Set result data for currently running check

Syntax

```
success = setCheckResultData(ma,data)
```

Description

Use the `success = setCheckResultData(ma,data)` method to set the check result data for the currently running check. Only the callback function of a check can invoke this method.

This method enables you to access custom checks that you create with the Model Advisor customization API, an optional feature that is available with Simulink Check software. For more information, see “Define Your Own Custom Model Advisor Checks” (Simulink Check).

Input Arguments

ma — Model Advisor object

Simulink.ModelAdvisor object

Simulink.ModelAdvisor object for which you want to set result data for the currently running check.

data — Result data

cell array of character vectors

Result data that you specify for a custom check.

Output Arguments

success — Boolean value indicating whether result data is set

Boolean

Boolean value that indicates whether the Model Advisor successfully set result data for the currently running check. A value of 1 indicates that the Model Advisor successfully set the data. A value of 0 indicates that the Model Advisor did not set the data.

See Also

Simulink.ModelAdvisor

Introduced in R2006a

setCheckResultStatus

Package: Simulink

Set status for currently running check

Syntax

```
success = setCheckResultStatus(ma,status)
```

Description

The `success = setCheckResultStatus(ma,status)` method sets the status for the currently running check. Only the callback function of a check can invoke this method.

This method enables you to access custom checks that you create with the Model Advisor customization API, an optional feature that is available with Simulink Check software. For more information, see “Define Your Own Custom Model Advisor Checks” (Simulink Check).

Input Arguments

ma — Model Advisor object

Simulink.ModelAdvisor object

Simulink.ModelAdvisor object for which you want to set the status for the currently running check.

status — Status of currently running check

Char | Boolean

For char type inputs, `pass` | `fail` | `warn` values indicate the status of the check that just ran. If you use `char` as input parameter, you will not need to update the severity of the error in `setCheckResultStatus` function.

Boolean value that indicates the status of the check that just ran. A value of `true` indicates that the check passed. A value of `false` indicates that the check failed.

Output Arguments

success — Boolean value indicating whether the Model Advisor successfully set the status

Boolean

Boolean value that indicates whether the Model Advisor successfully set the status of the currently running check. A value of 1 indicates that the Model Advisor successfully set the status. A value of 0 indicates that the Model Advisor did not set the status.

See Also

Simulink.ModelAdvisor

Introduced in R2006a

setInputParameters

Package: Simulink

Specify input parameters

Syntax

```
success = setInputParameters(ma, checkID, InputParameters)
```

Description

Use the `success = setInputParameters(ma, checkID, InputParameters)` method to specify input parameters for a Model Advisor check.

This method enables you to access custom checks that you create using Simulink Check. For more information, see “Define Your Own Custom Model Advisor Checks” (Simulink Check) .

Input Arguments

ma — Model Advisor object

`Simulink.ModelAdvisor` object

`Simulink.ModelAdvisor` object for which to specify the input parameters for the specific Model Advisor check.

checkID — Model Advisor check

character vector

Model Advisor check ID to which the input parameters apply. If you use this method inside a current active check function, you can omit this argument.

Example: 'mathworks.design.UnconnectedLinesPorts'

InputParameters — Input parameters

cell array of `ModelAdvisor.InputParameter` objects

Cell array that contains the `ModelAdvisor.InputParameter` objects for a Model Advisor check.

Output Arguments

success — Boolean value indicating whether the input parameters were specified for check

Boolean

Boolean value that indicates whether the Model Advisor specified the input parameters. A value of 1 indicates that the Model Advisor successfully specified the input parameters for the check. A value of 0 indicates that the Model Advisor did not specify the input parameters.

See Also

`Simulink.ModelAdvisor` | `ModelAdvisor.InputParameter`

Topics

“Create Model Advisor Checks” (Simulink Check)

“Fix a Model to Comply with Conditions that You Specify with the Model Advisor” (Simulink Check)

“Review a Model Against Conditions that You Specify with the Model Advisor” (Simulink Check)

Introduced in R2006a

setListViewParameters

Package: Simulink

Specify list-view parameters for check

Syntax

```
setListViewParameters(ma,checkID, params)
```

Description

The `setListViewParameters(ma,checkID, params)` method sets the list-view parameters for a check. Only the callback function of a check can invoke this method.

This method enables you to access custom checks that you create with the Model Advisor customization API, an optional feature that is available with Simulink Check software. For more information, see “Define Your Own Custom Model Advisor Checks” (Simulink Check).

Input Arguments

ma — Model Advisor object

`Simulink.ModelAdvisor` object

`Simulink.ModelAdvisor` object for which you want to set list-view parameters.

checkID — Model Advisor Check ID

character vector

Character vector specifying the identifier for a Model Advisor check.

params — Cell array of `ModelAdvisor.ListViewParameter` objects

`ModelAdvisor.ListViewParameter` objects

Set the list-view parameters for the check.

See Also

`Simulink.ModelAdvisor` | `ModelAdvisor.ListViewParameter`

Introduced in R2006a

verifyCheckRan

Package: Simulink

Verify that Model Advisor ran a set of checks

Syntax

```
[success, missingChecks, additionalChecks]= verifyCheckRan(ma,CheckIDs)
```

Description

Use the `[success, missingChecks, additionalChecks]= verifyCheckRan(ma,CheckIDs)` method to verify that the Model Advisor ran a set of checks.

Input Arguments

ma — Model Advisor object

Simulink.ModelAdvisor object

Simulink.ModelAdvisor object for which you want to verify that a set of checks ran

CheckIDs — Model Advisor Check IDs

cell array of character vectors

Cell array of character vectors specifying the identifiers of Model Advisor checks that you want to verify have run.

Output Arguments

success — Boolean value indicating whether the Model Advisor ran checks

Boolean

Boolean value that indicates whether the Model Advisor successfully ran a set of checks. A value of 1 indicates that the Model Advisor successfully ran the checks. A value of 0 indicates that the Model Advisor did not run the checks.

missingChecks — Cell array of Check IDs

cell array of character vectors

Cell array of character vectors specifying the identifiers of specified Model Advisor checks that did not run.

additionalChecks — Model Advisor Check IDs

cell array of character vectors

Cell array of character vectors specifying the identifiers of unspecified Model Advisor checks that ran.

See Also

Simulink.ModelAdvisor

Introduced in R2006a

verifyCheckResult

Package: Simulink

Generate baseline Model Advisor check results file or compare current check results to baseline check results

Syntax

```
[success, message]= verifyCheckResult(ma,baseline,CheckIDs)
```

Description

Use the `[success, message]= verifyCheckResult(ma,baseline,CheckIDs)` method to generate a baseline Model Advisor check results file or compare to current check results to baseline check results. If the Model Advisor is in baseline mode, this method stores the most recent results of running the checks that you specify by the `CheckIDs` argument in a MAT-file. For the MAT-file, use the location that you specify by using the `baseline` input argument.

To generate a baseline report, put the Model Advisor in baseline mode. Then invoke this method with the `baseline` argument set to the location where you want to store the baseline results. To perform a current-to-baseline report comparison, first check that the Model Advisor is not in baseline mode. Then, invoke this method with the path of the baseline report as the value of the `baseline` input argument.

Input Arguments

ma — Model Advisor object

Simulink.ModelAdvisor object

Simulink.ModelAdvisor object for which you want to verify that a set of checks ran.

baseline — Path of the baseline check results MAT-file

character vector

To perform a current-to-baseline report comparison, make sure that the Model Advisor is not in baseline mode and specify a path to the baseline report.

CheckIDs — Model Advisor Check IDs

cell array of character vectors

Cell array of character vectors specifying the identifiers of Model Advisor checks that you want to verify by using check results.

Output Arguments

success — Boolean value indicating whether the method succeeded

Boolean

Boolean value that indicates whether the method ran successfully. A value of 1 indicates that the method verified that the current check results match the baseline results. A value of 0 indicates that

the Model Advisor did not verify check results. If the method is unable to store the check results at the specified location, it returns false in the output variable success. The reason for the failure is in the message argument.

message — Error message

character vector

Error message indicating why Simulink did not verify check result.

See Also

Simulink.ModelAdvisor

Introduced in R2006a

verifyCheckResultStatus

Package: Simulink

Verify that a model passed or failed a set of checks

Syntax

```
[success message]= verifyCheckResultStatus(ma, baseline, checkIDs)
```

Description

Use the `[success message]= verifyCheckResultStatus(ma, baseline, checkIDs)` method to verify that a model has passed or failed a set of checks.

Before invoking the `verifyCheckResultStatus` method, run the checks that you specify with `checkIDs`. Then use the `getCheckResultStatus` method to obtain the boolean values for the baseline argument.

Input Arguments

ma — Model Advisor object

Simulink.ModelAdvisor object

Simulink.ModelAdvisor object for which you want to verify that a set of checks passed.

baseline — Statuses from running most recent round of checks

Cell array of Boolean variables

Statuses from the most recent checks run that you specify by Check IDs.

checkIDs — Model Advisor Check IDs

cell array of character vectors

Cell array of character vectors specifying the identifiers of Model Advisor checks that you want to verify have run.

Output Arguments

success — Boolean value indicating whether the check statuses match the baseline

Boolean

Boolean value that indicates whether the statuses match the baseline. A value of 1 indicates that the statuses match. A value of 0 indicates that the statuses do not match the baseline.

message — Message indicating status

character vector

Message indicating whether the method successfully verified the check result statuses.

See Also

Simulink.ModelAdvisor

Introduced in R2006a

verifyHTML

Package: Simulink

Generate baseline Model Advisor report or compare current report to baseline report

Syntax

```
[success message]= verifyHTML(ma,baseline)
```

Description

Use the `[success message]= verifyHTML(ma,baseline)` method to generate a Model Advisor report or to compare a current report to a baseline report.

This method enables you to compare a Model Advisor report with a baseline report to determine if they differ. You can use the method to generate the baseline report and perform current-to-baseline report comparisons. To generate a baseline report, use the `setBaselineMode` method to put the Model Advisor in baseline mode. Invoke this method with the baseline argument set to the location where you want to store the baseline report. To perform a current-to-baseline report comparison, first make sure that the Model Advisor is not in baseline mode. Then, invoke this method with the path of the baseline report as the value of the `baseline` input argument.

Input Arguments

ma — Model Advisor object

Simulink.ModelAdvisor object

Simulink.ModelAdvisor object for which you want to generate a baseline report or compare current report to baseline report

baseline — Path of Model Advisor report

character vector

Path to baseline Model Advisor report

Output Arguments

success — Boolean value indicating whether the method is successful

Boolean

Boolean value that indicates whether the method is successful. If the Model Advisor is in baseline mode, this method stores the most recently generated Model Advisor report at the location specified by the `baseline` input argument. If the method is unable to store a copy of the report at the specified location, it returns `false` in the output variable `success`. The reason for the failure is in the output variable `message`. If the Model Advisor is not in baseline mode, this method compares the report most recently generated by the Model Advisor with the report specified by `baseline`. If the current report has the same content as the baseline report, this method returns `true` as the value of the `success` output variable.

message — Message indicating status

character vector

Message indicating whether the Model Advisor is able to successfully store a report.

See Also

Simulink.ModelAdvisor

Introduced in R2006a

Simulink.ModelDataLogs

Container for signal data logs of a model

Description

Note The `ModelDataLogs` class is supported for backwards compatibility. Starting in R2016a, you cannot log data in the `ModelDataLogs` format. Signal logging uses the `Dataset` format. In R2016a or later, when you simulate a model from an earlier release that had used `ModelDataLogs` format, the model uses `Dataset` format to log data.

You can convert signal logging data from `ModelDataLogs` to `Dataset` format. Converting to `Dataset` format can facilitate post-processing with other logged data (for example, logged states), which can also use `Dataset` format. For more information, see “Convert Logged Data to Dataset Format”.

If you have legacy code that uses `ModelDataLogs`, you can encounter situations that require updates to your code or model. For more information about updating scripts, see “Migrate Scripts That Use Legacy `ModelDataLogs` API”.

In releases before R2016a, when you set **Configuration Parameters > Data Import/Export > Signal logging format** to `ModelDataLogs`, logging data produces one or more `Simulink.ModelDataLogs` objects that contain logged data. Logging creates an instance of this class for the top model and for each model referenced by the top model that contains logged signals. The `ModelDataLogs` object for the top model is assigned to a variable in the base workspace. The name of the variable is specified by the **Configuration Parameters > Data Import/export > Signal logging name** parameter. The default value is `logout`.

A `ModelDataLogs` object has a variable number of properties. The first property, `Name`, specifies the name of the model whose signal data the object contains or, if the model is a referenced model, the name of the Model block that references the model. The remaining properties reference objects that contain signal data logged during simulation of the model. The objects may be instances of these types of objects:

- `Simulink.ModelDataLogs`
Container for the data logs of a model
- `Simulink.SubsysDataLogs`
Container for the data logs of a subsystem
- `Simulink.Timeseries`
Data log for any signal except a mux or bus signal
- `Simulink.TsArray`
Data log for a mux or bus signal

The names of the properties identify the data being logged as follows:

- For signal data logs, the name of the signal
- For a subsystem or model log container, the name of the subsystem or model, respectively

Consider, for example, the following model.

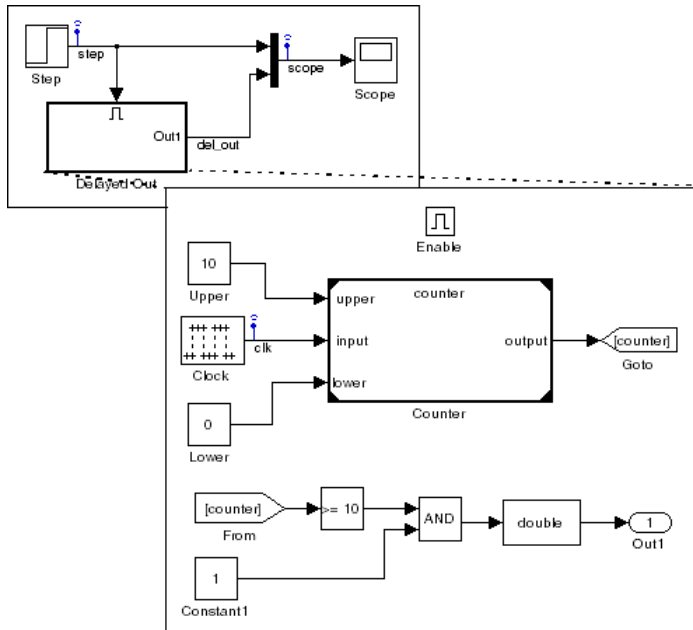

As indicated by the testpoint icons, this model specifies that Simulink software should log the signals named `step` and `scope` in the root system and the signal named `clk` in the subsystem named `Delayed Out`. After you simulate this model in a release earlier than R2016a, the MATLAB workspace contains the following variable:

```
Simulink.ModelDataLogs (siglgex):
  Name                elements  Simulink Class
  scope                2        TsArray
  step                 1        Timeseries
  ('Delayed Out')     2        SubsysDataLogs
```

You can use fully qualified object names or the Simulink `unpack` command to access the signal data. For example, to access the amplitudes of the `clk` signal in the `Delayed Out` subsystem in a `logout` object, enter

```
data = logout('Delayed Out').clk.Data;
```

or

```
>> logout.unpack('all');
>> data = clk.Data;
```

Access Logged Signal Data Saved in ModelDataLogs Format

The `Simulink.ModelDataLogs` object contains signal data objects to capture signal logging information for specific model elements.

| Model Element | Signal Data Object |
|---------------------------------------|-------------------------|
| Top-level or referenced model | Simulink.ModelDataLogs |
| Subsystem in a model | Simulink.SubsysDataLogs |
| Signal other than a bus or Mux signal | Simulink.Timeseries |
| Bus signal or Mux signal | Simulink.TsArray |

Handling Spaces and Newlines in Logged Names

Signal names in data logs can have spaces or newlines in their names when the signal:

- Is named and the name includes a space or newline character.
- Is unnamed and originates in a block whose name includes a space or newline character.
- Exists in a subsystem or referenced model, and the name of the subsystem, Model block, or of any superior block includes a space or newline character.

The following model shows a signal whose name contains a space, a signal whose name contains a newline, and an unnamed signal that originates in a block whose name contains a newline:

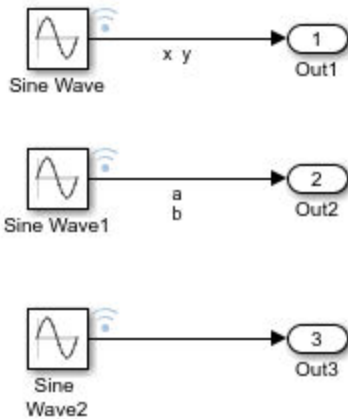

The following example shows how to handle spaces or new lines in logged names, if a model uses `ModelDataLogs` for the signal logging format.

```
logstdout
```

```
logstdout =
```

```
Simulink.ModelDataLogs (model_name):
  Name                Elements  Simulink Class
  ('x y')              1        Timeseries
  ('a
b')                   1        Timeseries
  ('SL_Sine
Wave1')               1        Timeseries
```

You cannot access any of the `Simulink.Timeseries` objects in this log using TAB name completion or by typing the name to MATLAB. This syntax is not recognized because the space or newline in each name appears to the MATLAB parser as a separator between identifiers. For example:

```
logout.x y
```

```
??? logout.x y
```

```
|
Error: Unexpected MATLAB expression.
```

To reference a `Simulink.Timeseries` object whose name contains a space, enclose the element containing the space in single quotes:

```
logout.('x y')
```

```
    Name: 'x y'
  BlockPath: 'model_name/Sine'
   PortIndex: 1
 SignalName: 'x y'
  ParentName: 'x y'
   TimeInfo: [1x1 Simulink.TimeInfo]
         Time: [51x1 double]
         Data: [51x1 double]
```

To reference a `Simulink.Timeseries` object whose name contains a newline, concatenate to construct the element containing the newline:

```
cr=sprintf('\n')
logout.(['a' cr 'b'])
```

The same techniques work when a space or newline in a data log derives from the name of:

- An unnamed logged signal's originating block
- A subsystem or Model block that contains any logged signal
- Any block that is superior to such a block in the model hierarchy

This code can reference logged data for the signal:

```
logout.(['SL_Sine' cr 'Wave1'])
```

For names with multiple spaces, newlines, or both, repeat and combine the two techniques as needed to specify the intended name to MATLAB.

Bus Signals

`ModelDataLogs` format stores each logged bus signal data in a separate `Simulink.TsArray` object.

The hierarchy of a bus signal is preserved in the logged signal data. The logged name of a signal in a virtual bus derives from the name of the source signal. The logged name of a signal in a nonvirtual bus derives from the applicable bus object, and can differ from the name of the source signal. See “Composite Signals” for information about those capabilities.

See Also

“Convert Logged Data to Dataset Format”, “Migrate Scripts That Use Legacy `ModelDataLogs` API”, `Simulink.SubsysDataLogs`, `Simulink.Timeseries`, `Simulink.TsArray`, `who`, `whos`, `unpack`

Introduced before R2006a

Simulink.SimState.ModelSimState class

Package: Simulink.SimState

(Not recommended) Access SimState snapshot data

Note Simulink.SimState.ModelSimState is not recommended. Use Simulink.op.ModelOperatingPoint instead.

Description

The Simulink.SimState.ModelSimState class contains all of the information associated with a “snapshot” of a simulation, including the logged states, the time of the snapshot, and the start time of the simulation. To access these data for a block, use the `getBlockSimState` method or the `loggedStates` property.

Properties

description

Specify a description. By default, Simulink generates a character vector based on your model name.

loggedStates

The logged states are the continuous and discrete states of the blocks in a model. These states represent a subset of the complete simulation state (SimState) of the model.

If `loggedStates` is in Dataset format, you cannot assign a structure or a Simulink.SimulationData.Dataset object with a different number of elements than that of the Dataset object used for `loggedStates`.

If the `loggedStates` is in Structure format, you cannot assign a Dataset object.

Attributes:

`dependent`

`loggedStates` is obtained from the saved states of the block. `loggedStates` depends on the full state being saved in the SimState object, unlike, properties like `description`, which are independent of the save states.

snapshotTime

Time at which Simulink takes a “snapshot” of the complete simulation states. This data is read only.

startTime

Time at which the simulation starts. This data is read only.

Methods

`getBlockSimState` (Not recommended) Access `SimState` of individual Stateflow Chart, MATLAB Function, or S-function block

`setBlockSimState` (Not recommended) Set `SimState` of individual Stateflow Chart, MATLAB Function, or S-function block

Copy Semantics

Value. To learn how value classes affect copy operations, see Copying Objects in the MATLAB Programming Fundamentals documentation.

Simulink.ModelWorkspace

Interact with the model workspace of a model programmatically

Description

Use a `Simulink.ModelWorkspace` object to interact with a model workspace. For example, you can add and remove variables, set the data source of the workspace, and save changes to the workspace.

For more information, see “Model Workspaces”.

Creation

To create a `Simulink.ModelWorkspace`, use the `get_param` function to query the value of the model parameter `ModelWorkspace`. For example, to create an object named `mdlWks` that represents the model workspace of a model named `myModel.slx`:

```
mdlWks = get_param('myModel', 'ModelWorkspace')
```

Properties

DataSource — Source for initializing variables in model workspace

'Model File' (default) | 'MAT-File' | 'MATLAB Code' | 'MATLAB File'

Source for initializing the variables in the model workspace, specified as one of these character vectors:

- 'Model File' — The variables are stored in the model file. When you save the model, you also save the variables.
- 'MATLAB Code' — The variables are created by MATLAB code that you write and store in the model file.
- 'MAT-File' — The variables are stored in a MAT-file, which you can manage and manipulate separately from the model file.
- 'MATLAB File' — The variables are created by MATLAB code in a script file, which you can manage and manipulate separately from the model file.

Data Types: char

FileName — Name of external file that stores or creates variables

' ' (empty character vector) (default) | character vector

Name of the external file that stores or creates variables, specified as a character vector. To enable this property, set `DataSource` to 'MAT-File' or 'MATLAB File'.

Example: 'myFile.mat'

Example: 'myFile.m'

Data Types: char

MATLABCode — MATLAB code for initializing variables

' ' (empty character vector) (default) | character vector

MATLAB code for initializing variables, specified as a character vector. To enable this property, set `DataSource` to 'MATLAB Code'.

Example: `sprintf('% Create variables that this model uses.\n\nK = 0.00983;\n\nP = Simulink.Parameter(5);')`

Data Types: char

Object Functions

| | |
|------------------------------|---|
| <code>getVariable</code> | Return value of variable in the model workspace of a model |
| <code>getVariablePart</code> | Get value of variable property in model workspace |
| <code>setVariablePart</code> | Set property of variable in model workspace |
| <code>hasVariable</code> | Determine whether variable exists in the model workspace of a model |
| <code>whos</code> | Return list of variables in the model workspace of a model |
| <code>saveToSource</code> | Save model workspace changes to the external data source of the model workspace |
| <code>save</code> | Save contents of model workspace to a MAT-file |
| <code>reload</code> | Reinitialize variables from the data source of a model workspace |
| <code>evalin</code> | Evaluate expression in the model workspace of a model |
| <code>clear</code> | Clear variables from the model workspace of a model |
| <code>assignin</code> | Assign value to variable in the model workspace of a model |

Examples**Interact With Model Workspace Programmatically**

Create a variable in the model workspace of a model. Then, modify the variable and query the variable value to confirm the modification.

Open the example model `vdp`.

```
open_system('vdp')
```

Create a `Simulink.ModelWorkspace` object `mdlWks` that represents the model workspace of `vdp`.

```
mdlWks = get_param('vdp', 'ModelWorkspace');
```

Create a variable named `myVar` with value `5.12` in the model workspace.

```
assignin(mdlWks, 'myVar', 5.12)
```

Apply a new value, `7.22`. To do so, first create a temporary copy of the variable by using the `getVariable` function. Then, modify the copy and use it to overwrite the original variable in the model workspace.

```
temp = getVariable(mdlWks, 'myVar');
temp = 7.22;
assignin(mdlWks, 'myVar', temp)
```

Confirm the new value by querying the value of the variable.

```
getVariable(mdlWks, 'myVar')
```

ans =

7.2200

See Also

Topics

“Model Workspaces”

“Manage Design Data”

Introduced before R2006a

assignin

Package: Simulink

Assign value to variable in the model workspace of a model

Syntax

```
assignin mdlWks, varName, varValue)
```

Description

`assignin(mdlWks, varName, varValue)` assigns the value `varValue` to the MATLAB variable `varName` in the model workspace represented by the `Simulink.ModelWorkspace` object `mdlWks`. If the variable does not exist, `assignin` creates it.

Examples

Assign Value to Variable in Model Workspace

Open the example model `vdp`.

```
open_system('vdp')
```

Create a `Simulink.ModelWorkspace` object that represents the model workspace of `vdp`.

```
mdlWks = get_param('vdp', 'ModelWorkspace');
```

Create a variable named `myVar` with value `5.12` in the model workspace.

```
assignin(mdlWks, 'myVar', 5.12)
```

Input Arguments

mdlWks — Target model workspace

`Simulink.ModelWorkspace` object

Target model workspace, specified as a `Simulink.ModelWorkspace` object.

varName — Name of target variable

character vector

Name of the target variable, specified as a character vector.

Example: `'myVar'`

Data Types: `char`

varValue — Value to assign to target variable

valid value

Value to assign to the target value, specified as a valid value. For example, you can specify a literal number, a structure, or an expression that evaluates to a valid value.

If you specify the name of a handle object, such as a `Simulink.Parameter` object, use the `copy` function to create a separate copy of the object.

Example: `5.12`

Example: `struct('a',5.12,'b',7.22)`

Example: `Simulink.Parameter(5.12)`

Example: `copy(myExistingParameterObject)`

Data Types: `single` | `double` | `int8` | `int16` | `int32` | `int64` | `uint8` | `uint16` | `uint32` | `uint64` | `logical` | `char` | `string` | `struct` | `table` | `cell` | `categorical` | `datetime` | `duration` | `calendarDuration` | `fi`

Complex Number Support: Yes

See Also

`Simulink.ModelWorkspace`

Introduced before R2006a

clear

Package: Simulink

Clear variables from the model workspace of a model

Syntax

```
clear mdlWks
```

Description

`clear(mdlWks)` removes all variables from the model workspace represented by the `Simulink.ModelWorkspace` object `mdlWks`.

Examples

Clear Variables From Model Workspace

Open the example model `vdp`.

```
open_system('vdp')
```

Create a `Simulink.ModelWorkspace` object that represents the model workspace of `vdp`.

```
mdlWks = get_param('vdp', 'ModelWorkspace');
```

Create a variable named `myVar` with value `5.12` in the model workspace.

```
assignin(mdlWks, 'myVar', 5.12)
```

Clear all variables from the model workspace, including `myVar`.

```
clear(mdlWks)
```

Input Arguments

mdlWks — Target model workspace

`Simulink.ModelWorkspace` object

Target model workspace, specified as a `Simulink.ModelWorkspace` object.

See Also

`Simulink.ModelWorkspace`

Introduced before R2006a

evalin

Package: Simulink

Evaluate expression in the model workspace of a model

Syntax

```
result = evalin mdlWks, expression)
```

Description

`result = evalin(mdlWks, expression)` evaluates the expression `expression` in the model workspace represented by the `Simulink.ModelWorkspace` object represented by `mdlWks`. The function returns the result of the expression in `result`.

Note For setting and getting variable properties in the model workspace, consider using `setVariablePart` and `getVariablePart` instead of `evalin` because:

- The functions do not create new variables or cause unintended results.
- `getVariablePart` does not dirty the model.

For information on these alternatives, see `Simulink.ModelWorkspace`.

Examples

Evaluate Expression in Model Workspace

Open the example model `vdp`.

```
open_system('vdp')
```

Create a `Simulink.ModelWorkspace` object that represents the model workspace of `vdp`.

```
mdlWks = get_param('vdp', 'ModelWorkspace');
```

Create some variables in the model workspace.

```
assignin(mdlWks, 'myVar', 5.12)  
assignin(mdlWks, 'myOtherVar', 7.22)
```

Evaluate the expression `myLastVar = myVar + myOtherVar` in the model workspace. The expression creates another variable, `myLastVar`, whose value is the sum of the first two variables.

```
evalin(mdlWks, 'myLastVar = myVar + myOtherVar');
```

Input Arguments

mdlWks — Target model workspace

`Simulink.ModelWorkspace` object

Target model workspace, specified as a `Simulink.ModelWorkspace` object.

expression — Expression to evaluate

character vector

Expression to evaluate, specified as a character vector.

Example: `'myLastVar = myVar + myOtherVar'`

Data Types: `char`

Output Arguments

result — Result of expression

number, structure, or other MATLAB value

Result of the evaluated expression, returned as a number, structure, or other MATLAB value.

See Also

`Simulink.ModelWorkspace`

Introduced before R2006a

reload

Package: Simulink

Reinitialize variables from the data source of a model workspace

Syntax

```
reload mdlWks
```

Description

`reload(mdlWks)` reinitializes the variables in the model workspace represented by the `Simulink.ModelWorkspace` object `mdlWks`. When you set the `DataSource` property of the model workspace to `'MAT-File'`, `'MATLAB File'`, or `'MATLAB Code'`, `reload` overwrites variables that exist in the model workspace by loading the associated MAT-file or by running the associated MATLAB code.

Examples

Reinitialize Variables in a Model Workspace

Open the example model `vdp`.

```
open_system('vdp')
```

Create a `Simulink.ModelWorkspace` object that represents the model workspace of `vdp`.

```
mdlWks = get_param('vdp', 'ModelWorkspace');
```

Configure the model workspace to use some MATLAB code as a data source.

```
mdlWks.DataSource = 'MATLAB Code';  
mdlWks.MATLABCode = sprintf('myVar = 5.12;\nmyOtherVar = 7.22;');
```

Create variables in the model workspace by executing the MATLAB code.

```
reload(mdlWks)
```

Assign new values to the variables in the model workspace.

```
assignin(mdlWks, 'myVar', 5.22)  
assignin(mdlWks, 'myOtherVar', 7.33)
```

Overwrite the new values with the values specified by the MATLAB code.

```
reload(mdlWks)
```

Confirm that the variables have the values specified by the MATLAB code.

```
myVarValue = getVariable(mdlWks, 'myVar')  
myOtherVarValue = getVariable(mdlWks, 'myOtherVar')
```

```
myVarValue =
```

```
    5.1200
```

```
myOtherVarValue =
```

```
    7.2200
```

Input Arguments

mdlWks — Target model workspace

Simulink.ModelWorkspace object

Target model workspace, specified as a Simulink.ModelWorkspace object.

See Also

Simulink.ModelWorkspace

Introduced before R2006a

save

Package: Simulink

Save contents of model workspace to a MAT-file

Syntax

```
save mdlWks, fileName)
```

Description

`save mdlWks, fileName)` saves the variables in the model workspace represented by the `Simulink.ModelWorkspace` object `mdlWks` to the MAT-file specified by `fileName`.

When you set the `DataSource` property of the model workspace to 'MAT-File' or 'MATLAB File', to save to the file that acts as the external data source of the model, use `saveToSource` instead of `save`.

Examples

Save Contents of Model Workspace to MAT-File

Open the example model `vdp`.

```
open_system('vdp')
```

Create a `Simulink.ModelWorkspace` object that represents the model workspace of `vdp`.

```
mdlWks = get_param('vdp', 'ModelWorkspace');
```

Create some variables in the model workspace.

```
assignin mdlWks, 'myVar', 5.12)
assignin mdlWks, 'myOtherVar', 7.22)
```

Save the variables to a new MAT-file named `myVars.mat`.

```
save mdlWks, 'myVars.mat')
```

The MAT-file appears in your current folder.

Input Arguments

mdlWks — Target model workspace

`Simulink.ModelWorkspace` object

Target model workspace, specified as a `Simulink.ModelWorkspace` object.

fileName — Name of target MAT-file

character vector

Name of the target MAT-file, specified as a character vector.

Example: 'myFile.mat'

Data Types: char

See Also

Simulink.ModelWorkspace

Introduced before R2006a

saveToSource

Package: Simulink

Save model workspace changes to the external data source of the model workspace

Syntax

```
saveToSource mdlWks
```

Description

`saveToSource mdlWks` saves the variables in the model workspace represented by the `Simulink.ModelWorkspace` object `mdlWks` to the MAT-file or script file specified by the `FileName` property of the model workspace.

When you set the `DataSource` property of the model workspace to 'MAT-File' or 'MATLAB File', the `FileName` property specifies the name of the file that acts as the external data source of the workspace. As you make changes to the variables in the model workspace, use `saveToSource` to permanently save the changes in the external data source.

Examples

Save Variables to External Data Source of Model Workspace

Open the example model `vdp`.

```
open_system('vdp')
```

Create a `Simulink.ModelWorkspace` object that represents the model workspace of `vdp`.

```
mdlWks = get_param('vdp','ModelWorkspace');
```

Create some variables in the model workspace.

```
assignin mdlWks, 'myVar', 5.12  
assignin mdlWks, 'myOtherVar', 7.22
```

Configure the model workspace to use a MAT-file named `myVars.mat` as the data source.

```
mdlWks.DataSource = 'MAT-File';  
mdlWks.FileName = 'myVars.mat';
```

Save the variables to the external data source (the MAT-file).

```
saveToSource mdlWks
```

The file appears in your current folder.

Input Arguments

mdlWks — Target model workspace

Simulink.ModelWorkspace object

Target model workspace, specified as a Simulink.ModelWorkspace object.

See Also

Simulink.ModelWorkspace

Introduced before R2006a

whos

Package: Simulink

Return list of variables in the model workspace of a model

Syntax

```
varList = whos mdlWks)
```

Description

`varList = whos(mdlWks)` returns a list of the variables in the model workspace represented by the `Simulink.ModelWorkspace` object `mdlWks`.

Examples

Return List of Variables in Model Workspace

Open the example model `vdp`.

```
open_system('vdp')
```

Create a `Simulink.ModelWorkspace` object that represents the model workspace of `vdp`.

```
mdlWks = get_param('vdp', 'ModelWorkspace');
```

Create some variables in the model workspace.

```
assignin(mdlWks, 'myVar', 5.12)
assignin(mdlWks, 'myOtherVar', 7.22)
```

Display a list of the variables in the model workspace.

```
whos(mdlWks)
```

| Name | Size | Bytes | Class | Attributes |
|------------|------|-------|--------|------------|
| myOtherVar | 1x1 | 8 | double | |
| myVar | 1x1 | 8 | double | |

Input Arguments

mdlWks — Target model workspace

`Simulink.ModelWorkspace` object

Target model workspace, specified as a `Simulink.ModelWorkspace` object.

Output Arguments

varList — List of variables

nested structure array

List of variables, returned as a nested structure array. For details about the information in the list, see `whos`.

See Also

`Simulink.ModelWorkspace`

Introduced before R2006a

getVariable

Package: Simulink

Return value of variable in the model workspace of a model

Syntax

```
varValue = getVariable mdlWks, varName)
```

Description

`varValue = getVariable(mdlWks, varName)` returns the value of the variable whose name is `varName` that exists in the model workspace represented by the `Simulink.ModelWorkspace` object `mdlWks`.

If the value of the target variable is a handle to a handle object (such as `Simulink.Parameter`), `getVariable` returns a copy of the handle. Changes you make to the variable in the model workspace or to the returned variable (`variableValue`) affect both variables.

To return a deep copy of the handle object, use the `copy` method of the object. To modify a handle object that you store in a model workspace, it is a best practice to use both the `getVariable` and `assignin` methods (see “Modify Property Value of Handle Object” on page 5-409).

Examples

Return Value of Variable in Model Workspace

Open the example model `vdp`.

```
open_system('vdp')
```

Create a `Simulink.ModelWorkspace` object that represents the model workspace of `vdp`.

```
mdlWks = get_param('vdp', 'ModelWorkspace');
```

Create a variable named `myVar` in the model workspace.

```
assignin(mdlWks, 'myVar', 5.12)
```

Return the value of the new variable. Store the value in another variable named `varValue`.

```
varValue = getVariable(mdlWks, 'myVar');
```

Modify Property Value of Handle Object

Modify a property of the `Simulink.Parameter` object `K`, which is defined in model `mdl.slx`. When you call `getVariable`, use the `copy` method because `Simulink.Parameter` is a handle class.

```
wksp = get_param mdl, 'ModelWorkspace';  
value = copy(getVariable(wksp, 'K'));
```

```
value.DataType = 'single';  
assignin(wksp, 'K', value);
```

Input Arguments

mdlWks — Target model workspace

Simulink.ModelWorkspace object

Target model workspace, specified as a Simulink.ModelWorkspace object.

varName — Name of target variable

character vector

Name of the target variable, specified as a character vector.

Example: 'myVariable'

Data Types: char

Output Arguments

varValue — Value of target variable

number, structure, or other MATLAB value

Value of the target variable, returned as a number, structure, or other MATLAB value.

See Also

get_param | Simulink.ModelWorkspace

Introduced in R2012a

getVariablePart

Package: Simulink

Get value of variable property in model workspace

Syntax

```
varValue = getVariablePart mdlWks, varName.Property)
```

Description

`varValue = getVariablePart(mdlWks, varName.Property)` returns the value of the variable property named `varName.Property` that exists in the model workspace represented by the `Simulink.ModelWorkspace` object `mdlWks`.

If the value of the variable property is a handle to a handle object (such as `Simulink.Parameter`), `getVariablePart` returns a copy of the handle.

Using `getVariablePart` is preferable to using `evalin` for getting variable properties in the model workspace because:

- The function does not dirty the model.
- Use of the function does not result in the creation of a new variable or other unintended results.

Examples

Return Value of Variable Properties in Model Workspace

Open the example model `vdp`.

```
open_system('vdp')
```

Create a `Simulink.ModelWorkspace` object that represents the model workspace of `vdp`.

```
mdlWks = get_param('vdp', 'ModelWorkspace');
```

Create a structure named `myStruct` with fields `a`, `b`, and `c`.

```
aStruct.a = 10;  
aStruct.b = {1,2,3,4,5};  
aStruct.c = Simulink.Parameter(7);  
mdlWks.assignin('myStruct', aStruct);
```

Return the values of the structure fields. Store the values in `varValuea`, `varValueb`, and `varValuec`.

```
varValuea = getVariablePart mdlWks, 'myStruct.a');  
varValueb = getVariablePart mdlWks, 'myStruct.b{1}';  
varValuec = getVariablePart mdlWks, 'myStruct.c.Value');
```

Input Arguments

mdlWks — Target model workspace

Simulink.ModelWorkspace object

Target model workspace, specified as a Simulink.ModelWorkspace object.

varName.Property — Name of target variable property

character vector

Name of the target variable property, specified as a character vector.

Example: 'myVariable.Property'

Data Types: char

Output Arguments

varValue — Value of variable property

number, structure, or other MATLAB value

Value of the variable property, returned as a number, structure, or other MATLAB value.

If the value of the variable property is a handle to a handle object (such as Simulink.Parameter), getVariablePart returns a copy of the handle.

See Also

Simulink.ModelWorkspace

Introduced in R2018b

setVariablePart

Package: Simulink

Set property of variable in model workspace

Syntax

```
varValue = setVariablePart mdlWks, varName.Property, varValue)
```

Description

`varValue = setVariablePart mdlWks, varName.Property, varValue)` assigns `varValue` to the MATLAB variable property `varName.Property` in the model workspace represented by the Simulink.ModelWorkspace object `mdlWks`.

Using `setVariablePart` is preferable to using `evalin` for assigning variable properties in the model workspace because the `setVariablePart` function does not create a new variable or cause unintended results.

Examples

Assign Value to Variable Properties in Model Workspace

Open the example model `vdp`.

```
open_system('vdp')
```

Create a Simulink.ModelWorkspace object that represents the model workspace of `vdp`.

```
mdlWks = get_param('vdp', 'ModelWorkspace');
```

Create a structure named `myStruct` with fields `a`, `b`, and `c`.

```
aStruct.a = 10;  
aStruct.b = {1,2,3,4,5};  
aStruct.c = Simulink.Parameter(7);  
mdlWks.assignin('myStruct', aStruct);
```

Assign new values to the structure fields.

```
setVariablePart(mdlWks, 'myStruct.a', 2);  
setVariablePart(mdlWks, 'myStruct.b{1}', 2);  
setVariablePart(mdlWks, 'myStruct.c', Simulink.Parameter(2));
```

Return the new values of the structure fields. Store the values in `varValuea`, `varValueb`, and `varValuec`.

```
varValuea = getVariablePart mdlWks, 'myStruct.a')
varValueb = getVariablePart mdlWks, 'myStruct.b{1}')
varValuec = getVariablePart mdlWks, 'myStruct.c.Value')
```

Input Arguments

mdlWks — Target model workspace

Simulink.ModelWorkspace object

Target model workspace, specified as a Simulink.ModelWorkspace object.

varName.Property — Name of target variable property

character vector

Name of the target variable property, specified as a character vector.

Example: 'myVariable.Property'

Data Types: char | string

varValue — Value to assign to variable property

valid value

Value to assign to the value property, specified as a valid value. For example, you can specify a literal number, a structure, or an expression that evaluates to a valid value.

If you specify the name of a handle object, such as a Simulink.Parameter object, use the copy function to create a separate copy of the object.

Example: 5.12

Example: struct('a',5.12,'b',7.22)

Example: Simulink.Parameter(5.12)

Example: copy(myExistingParameterObject)

Data Types: single | double | int8 | int16 | int32 | int64 | uint8 | uint16 | uint32 | uint64 | logical | char | string | struct | table | cell | categorical | datetime | duration | calendarDuration | fi

Complex Number Support: Yes

See Also

Simulink.ModelWorkspace

Introduced in R2018b

hasVariable

Package: Simulink

Determine whether variable exists in the model workspace of a model

Syntax

```
varExists = hasVariable mdlWks, varName)
```

Description

`varExists = hasVariable(mdlWks, varName)` returns 1 if a variable whose name is `varName` exists in the model workspace represented by the `Simulink.ModelWorkspace` object `mdlWks`.

Examples

Determine Existence of Variable in Model Workspace

Open the example model `vdp`.

```
open_system('vdp')
```

Create a `Simulink.ModelWorkspace` object that represents the model workspace of `vdp`.

```
mdlWks = get_param('vdp', 'ModelWorkspace');
```

Create a variable named `myVar` in the model workspace.

```
assignin(mdlWks, 'myVar', 5.12)
```

Determine whether a variable named `myVar` exists in the model workspace.

```
exists = hasVariable(mdlWks, 'myVar')
```

```
exists =  
    1
```

Input Arguments

mdlWks — Target model workspace

`Simulink.ModelWorkspace` object

Target model workspace, specified as a `Simulink.ModelWorkspace` object.

varName — Name of target variable

character vector

Name of the target variable, specified as a character vector.

Example: `'myVariable'`

Data Types: char

Output Arguments

varExists — Indication of existence

1 | 0

Indication of variable existence, returned as 1 (true) or 0.

See Also

`get_param` | `Simulink.ModelWorkspace`

Introduced in R2012a

Simulink.MSFcnRunTimeBlock

Get run-time information about Level-2 MATLAB S-function block

Description

This class allows a Level-2 MATLAB S-function or other MATLAB program to obtain information from Simulink software and provide information to Simulink software about a Level-2 MATLAB S-Function block. Simulink software creates an instance of this class for each Level-2 MATLAB S-Function block in a model. Simulink software passes the object to the callback methods of Level-2 MATLAB S-functions when it updates or simulates a model, allowing the callback methods to get and provide block-related information to Simulink software. See “Write Level-2 MATLAB S-Functions” for more information.

You can also use instances of this class in MATLAB programs to obtain information about Level-2 MATLAB S-Function blocks during a simulation. See “Access Block Data During Simulation” for more information.

The Level-2 MATLAB S-function template *matlabroot/toolbox/simulink/blocks/msfuntmpl.m* shows how to use a number of the following methods.

Parent Class

Simulink.RunTimeBlock

Derived Classes

None

Property Summary

| Name | Description |
|--|--|
| “AllowSignalsWithMoreThan2D” on page 5-419 | enable Level-2 MATLAB S-function to use multidimensional signals. |
| “DialogPrmsTunable” on page 5-419 | Specifies which of the S-function's dialog parameters are tunable. |
| “NextTimeHit” on page 5-419 | Time of the next sample hit for variable sample time S-functions. |

Method Summary

| Name | Description |
|------------------------------------|---|
| “AutoRegRuntimePrms” on page 5-419 | Register this block's dialog parameters as run-time parameters. |

| Name | Description |
|---|--|
| "AutoUpdateRuntimePrms" on page 5-420 | Update this block's run-time parameters. |
| "IsDoingConstantOutput" on page 5-420 | Determine whether the current simulation stage is the constant sample time stage. |
| "IsMajorTimeStep" on page 5-421 | Determine whether the current simulation time step is a major time step. |
| "IsSampleHit" on page 5-421 | Determine whether the current simulation time is one at which a task handled by this block is active. |
| "IsSpecialSampleHit" on page 5-421 | Determine whether the current simulation time is one at which multiple tasks handled by this block are active. |
| "RegBlockMethod" on page 5-422 | Register a callback method for this block. |
| "RegisterDataTypeFxpBinaryPoint" on page 5-422 | Register fixed-point data type with binary point-only scaling. |
| "RegisterDataTypeFxpFSlopeFixexpBias" on page 5-423 | Register fixed-point data type with [Slope Bias] scaling specified in terms of fractional slope, fixed exponent, and bias. |
| "RegisterDataTypeFxpSlopeBias" on page 5-424 | Register data type with [Slope Bias] scaling. |
| "SetAccelRunOnTLC" on page 5-425 | Specify whether to use this block's TLC file to generate the simulation target for the model that uses it. |
| "SetPreCompInpPortInfoToDynamic" on page 5-426 | Set precompiled attributes of this block's input ports to be inherited. |
| "SetPreCompOutPortInfoToDynamic" on page 5-426 | Set precompiled attributes of this block's output ports to be inherited. |
| "SetPreCompPortInfoToDefaults" on page 5-426 | Set precompiled attributes of this block's ports to the default values. |
| "SetSimViewingDevice" on page 5-426 | Specify whether block is a viewer. |
| "SupportsMultipleExecInstances" on page 5-427 | |
| "WriteRTWParam" on page 5-427 | Write custom parameter information to Simulink Coder file. |

Properties

AllowSignalsWithMoreThan2D

Description

Allow Level-2 MATLAB S-functions to use multidimensional signals. You must set the AllowSignalsWithMoreThan2D property in the setup method.

Data Type

Boolean

Access

RW

DialogPrmsTunable

Description

Specifies whether a dialog parameter of the S-function is tunable. Tunable parameters are registered as run-time parameters when you call the “AutoRegRuntimePrms” on page 5-419 method. Note that SimOnlyTunable parameters are not registered as run-time parameters. For example, the following lines initializes three dialog parameters where the first is tunable, the second in not tunable, and the third is tunable only during simulation.

```
block.NumDialogPrms = 3;
block.DialogPrmsTunable = {'Tunable', 'Nontunable', 'SimOnlyTunable'};
```

Data Type

array

Access

RW

NextTimeHit

Description

Time of the next sample hit for variable sample-time S-functions.

Data Type

double

Access

RW

Methods

AutoRegRuntimePrms

Purpose

Register a block's tunable dialog parameters as run-time parameters.

Syntax

```
AutoRegRuntimePrms;
```

Description

Use in the `PostPropagationSetup` method to register this block's tunable dialog parameters as run-time parameters.

AutoUpdateRuntimePrms**Purpose**

Update a block's run-time parameters.

Syntax

```
AutoUpdateRuntimePrms;
```

Description

Automatically update the values of the run-time parameters during a call to `ProcessParameters`.

See the S-function `matlabroot/toolbox/simulink/simdemos/simfeatures/adapt_lms.m` in the Simulink model `sldemo_msfcn_lms` for an example.

IsDoingConstantOutput**Purpose**

Determine whether this is in the constant sample time stage of a simulation.

Syntax

```
bVal = IsDoingConstantOutput;
```

Description

Returns true if this is the constant sample time stage of a simulation, i.e., the stage at the beginning of a simulation where Simulink software computes the values of block outputs that cannot change during the simulation (see “Constant Sample Time”). Use this method in the `Outputs` method of an S-function with port-based sample times to avoid unnecessarily computing the outputs of ports that have constant sample time, i.e., `[inf, 0]`.

```
function Outputs(block)
.
.
    if block.IsDoingConstantOutput
        ts = block.OutputPort(1).SampleTime;
        if ts(1) == Inf
            %% Compute port's output.
            end
        end
    end
.
.
%% end of Outputs
```

See “Specifying Port-Based Sample Times” for more information.

IsMajorTimeStep**Purpose.**

Determine whether current time step is a major or a minor time step.

Syntax

```
bVal = IsMajorTimeStep;
```

Description

Returns true if the current time step is a major time step; false, if it is a minor time step. This method can be called only from the `Outputs` or `Update` methods.

IsSampleHit**Purpose**

Determine whether the current simulation time is one at which a task handled by this block is active.

Syntax

```
bVal = IsSampleHit(stIdx);
```

Arguments

`stIdx`

Global index of the sample time to be queried.

Description

Use in `Outputs` or `Update` block methods when the MATLAB S-function has multiple sample times to determine whether a sample hit has occurred at `stIdx`. The sample time index `stIdx` is a global index for the Simulink model. For example, consider a model that contains three sample rates of 0.1, 0.2, and 0.5, and a MATLAB S-function block that contains two rates of 0.2 and 0.5. In the MATLAB S-function, `block.IsSampleHit(0)` returns true for the rate 0.1, not the rate 0.2.

This block method is similar to `ssIsSampleHit` for C-MeX S-functions, however `ssIsSampleHit` returns values based on only the sample times contained in the S-function. For example, if the model described above contained a C-MeX S-function with sample rates of 0.2 and 0.5, `ssIsSampleHit(S,0,tid)` returns true for the rate of 0.2.

Use port-based sample times to avoid using the global sample time index for multi-rate systems (see `Simulink.BlockPortData`).

IsSpecialSampleHit**Purpose**

Determine whether the current simulation time is one at which multiple tasks implemented by this block are active.

Syntax

```
bVal = IsSpecialSampleHit(stIdx1,stIdx1);
```

Arguments

stIdx1

Index of sample time of first task to be queried.

stIdx2

Index of sample time of second task to be queried.

Description

Use in `Outputs` or `Update` block methods to ensure the validity of data shared by multiple tasks running at different rates. Returns true if a sample hit has occurred at `stIdx1` and a sample hit has also occurred at `stIdx2` in the same time step (similar to `ssIsSpecialSampleHit` for C-Mex S-functions).

When using the `IsSpecialSampleHit` macro, the slower sample time must be an integer multiple of the faster sample time.

RegBlockMethod**Purpose**

Register a block callback method.

Syntax

```
RegBlockMethod(methName, methHandle);
```

Arguments

methName

Name of method to be registered.

methHandle

MATLAB function handle of the callback method to be registered.

Description

Registers the block callback method specified by `methName` and `methHandle`. Use this method in the `setup` function of a Level-2 MATLAB S-function to specify the block callback methods that the S-function implements.

RegisterDataTypeFxpBinaryPoint**Purpose**

Register fixed-point data type with binary point-only scaling.

Syntax

```
dtID = RegisterDataTypeFxpBinaryPoint(isSigned, wordLength, fractionalLength, obeyDataTypeOverride);
```

Arguments

isSigned

true if the data type is signed.

false if the data type is unsigned.

wordLength

Total number of bits in the data type, including any sign bit.

fractionalLength

Number of bits in the data type to the right of the binary point.

obeyDataTypeOverride

`true` indicates that the **Data Type Override** setting for the subsystem is to be obeyed. Depending on the value of **Data Type Override**, the resulting data type could be `Double`, `Single`, `ScaledDouble`, or the fixed-point data type specified by the other arguments of the function.

`false` indicates that the **Data Type Override** setting is to be ignored.

Description

This method registers a fixed-point data type with Simulink software and returns a data type ID. The data type ID can be used to specify the data types of input and output ports, run-time parameters, and DWork states. It can also be used with all the standard data type access methods defined for instances of this class, such as "DatatypeSize" on page 5-449.

Use this function if you want to register a fixed-point data type with binary point-only scaling. Alternatively, you can use one of the other fixed-point registration functions:

- Use "RegisterDataTypeFxpFSlopeFixexpBias" on page 5-423 to register a data type with [Slope Bias] scaling by specifying the word length, fractional slope, fixed exponent, and bias.
- Use "RegisterDataTypeFxpSlopeBias" on page 5-424 to register a data type with [Slope Bias] scaling.

If the registered data type is not one of the Simulink built-in data types, a Fixed-Point Designer license is checked out.

RegisterDataTypeFxpFSlopeFixexpBias**Purpose**

Register fixed-point data type with [Slope Bias] scaling specified in terms of fractional slope, fixed exponent, and bias

Syntax

```
dtID = RegisterDataTypeFxpFSlopeFixexpBias(isSigned, wordLength,
fractionalSlope, fixedexponent, bias, obeyDataTypeOverride);
```

Arguments**isSigned**

`true` if the data type is signed.

`false` if the data type is unsigned.

wordLength

Total number of bits in the data type, including any sign bit.

fractionalSlope

Fractional slope of the data type.

`fixedexponent`

exponent of the slope of the data type.

`bias`

Bias of the scaling of the data type.

`obeyDataTypeOverride`

`true` indicates that the **Data Type Override** setting for the subsystem is to be obeyed. Depending on the value of **Data Type Override**, the resulting data type could be `True Doubles`, `True Singles`, `ScaledDouble`, or the fixed-point data type specified by the other arguments of the function.

`false` indicates that the **Data Type Override** setting is to be ignored.

Description

This method registers a fixed-point data type with Simulink software and returns a data type ID. The data type ID can be used to specify the data types of input and output ports, run-time parameters, and DWork states. It can also be used with all the standard data type access methods defined for instances of this class, such as “DatatypeSize” on page 5-449.

Use this function if you want to register a fixed-point data type by specifying the word length, fractional slope, fixed exponent, and bias. Alternatively, you can use one of the other fixed-point registration functions:

- Use “RegisterDataTypeFxpBinaryPoint” on page 5-422 to register a data type with binary point-only scaling.
- Use “RegisterDataTypeFxpSlopeBias” on page 5-424 to register a data type with [Slope Bias] scaling.

If the registered data type is not one of the Simulink built-in data types, a Fixed-Point Designer license is checked out.

RegisterDataTypeFxpSlopeBias

Purpose

Register data type with [Slope Bias] scaling.

Syntax

```
dtID = RegisterDataTypeFxpSlopeBias(isSigned, wordLength, totalSlope, bias, obeyDataTypeOverride);
```

Arguments

`isSigned`

`true` if the data type is signed.

`false` if the data type is unsigned.

`wordLength`

Total number of bits in the data type, including any sign bit.

`totalSlope`

Total slope of the scaling of the data type.

bias

Bias of the scaling of the data type.

obeyDataTypeOverride

`true` indicates that the **Data Type Override** setting for the subsystem is to be obeyed. Depending on the value of **Data Type Override**, the resulting data type could be `True Doubles`, `True Singles`, `ScaledDouble`, or the fixed-point data type specified by the other arguments of the function.

`false` indicates that the **Data Type Override** setting is to be ignored.

Description

This method registers a fixed-point data type with Simulink software and returns a data type ID. The data type ID can be used to specify the data types of input and output ports, run-time parameters, and DWork states. It can also be used with all the standard data type access methods defined for instances of this class, such as “DatatypeSize” on page 5-449.

Use this function if you want to register a fixed-point data type with [Slope Bias] scaling. Alternatively, you can use one of the other fixed-point registration functions:

- Use “RegisterDataTypeFxpBinaryPoint” on page 5-422 to register a data type with binary point-only scaling.
- Use “RegisterDataTypeFxpFSlopeFixexpBias” on page 5-423 to register a data type by specifying the word length, fractional slope, fixed exponent, and bias

If the registered data type is not one of the Simulink built-in data types, a Fixed-Point Designer license is checked out.

SetAccelRunOnTLC

Purpose

Specify whether to use block's TLC file to generate code for the Accelerator mode of Simulink software.

Syntax

```
SetAccelRunOnTLC(bVal);
```

Arguments

`bVal`

May be `'true'` (use TLC file) or `'false'` (run block in interpreted mode).

Description

Specify if the block should use its TLC file to generate code that runs with the accelerator. If this option is `'false'`, the block runs in interpreted mode. See the S-function `msfcn_times_two.m` in the Simulink model `msfcndemo_timestwo` for an example.

Note The default JIT Accelerator mode does not support inlining of user-written TLC S-Functions. Please see “How Acceleration Modes Work” and “Control S-Function Execution” for more information.

SetPreCompInPortInfoToDynamic**Purpose**

Set precompiled attributes of this block's input ports to be inherited.

Syntax

```
SetPreCompInPortInfoToDynamic;
```

Description

Initialize the compiled information (dimensions, data type, complexity, and sampling mode) of this block's input ports to be inherited. See the S-function *matlabroot/toolbox/simulink/simdemos/simfeatures/adapt_lms.m* in the Simulink model *sldemo_msfcn_lms* for an example.

SetPreCompOutPortInfoToDynamic**Purpose**

Set precompiled attributes of this block's output ports to be inherited.

Syntax

```
SetPreCompOutPortInfoToDynamic;
```

Description

Initialize the compiled information (dimensions, data type, complexity, and sampling mode) of the block's output ports to be inherited. See the S-function *matlabroot/toolbox/simulink/simdemos/simfeatures/adapt_lms.m* in the Simulink model *sldemo_msfcn_lms* for an example.

SetPreCompPortInfoToDefaults**Purpose**

Set precompiled attributes of this block's ports to the default values.

Syntax

```
SetPreCompPortInfoToDefaults;
```

Description

Initialize the compiled information (dimensions, data type, complexity, and sampling mode) of the block's ports to the default values. By default, a port accepts a real scalar sampled signal with a data type of double.

SetSimViewingDevice**Purpose**

Specify whether this block is a viewer.

Syntax

```
SetSimViewingDevice(bVal);
```

Arguments

bVal

May be 'true' (is a viewer) or 'false' (is not a viewer).

Description

Specify if the block is a viewer/scope. If this flag is specified, the block will be used only during simulation and automatically stubbed out in generated code.

SupportsMultipleExecInstances**Purpose**

Specify whether or not a For Each Subsystem supports an S-function inside of it.

Syntax

```
SupportsMultipleExecInstances(bVal);
```

Arguments

bVal

May be 'true' (S-function is supported) or 'false' (S-function is not supported).

Description

Specify if an S-function can operate within a For Each Subsystem.

WriteRTWParam**Purpose**

Write a custom parameter to the Simulink Coder information file used for code generation.

Syntax

```
WriteRTWParam(pType, pName, pVal)
```

Arguments

pType

Type of the parameter to be written. Valid values are 'string' and 'matrix'.

pName

Name of the parameter to be written.

pVal

Value of the parameter to be written.

Description

Use in the `WriteRTW` method of the MATLAB S-function to write out custom parameters. These parameters are generally settings used to determine how code should be generated in the TLC file for the S-function. See the S-function `matlabroot/toolbox/simulink/simdemos/simfeatures/adapt_lms.m` in the Simulink model `sldemo_msfcn_lms` for an example.

Introduced before R2006a

Simulink.NumericType

Specify floating-point, integer, or fixed-point data type

Description

Use a `Simulink.NumericType` object to set and share numeric data types for signal, state, and parameter data in a model.

- 1 Create an instance of this class in the MATLAB base workspace, a model workspace, or a data dictionary. To create a numeric type in a model workspace, you must clear the **Is alias** property.
- 2 Set the properties of the object to create a custom floating point, integer, or fixed point data type.
- 3 Assign the data type to all signals and parameters of your model that you want to conform to the data type.

Assigning a data type in this way allows you to change the data types of the signals and parameters in your model by changing the properties of the object that describe them. You do not have to change the model itself.

To rename a data type in a model and in the code that you generate from a model (by generating a typedef statement), you can use an object of the class `Simulink.AliasType`.

Creation

To create a `Simulink.NumericType` object interactively, use the Model Explorer:

- 1 On the Model Explorer **Model Hierarchy** pane, select a workspace, such as the base workspace, or a data dictionary.
- 2 From the Model Explorer **Add** menu, select **Simulink.NumericType**.

The Model Explorer creates an instance of a `Simulink.NumericType` object and assigns it to a variable named `Numeric` in the target workspace.

- 3 Rename the variable to a more appropriate name, for example, a name that reflects its intended usage.

To change the name, edit the name displayed in the **Name** field on the Model Explorer **Contents** pane.

- 4 On the Model Explorer **Dialog** pane, use the **Data type mode** property to select a data type that the object represents.

To create a `Simulink.NumericType` object programmatically, use the `Simulink.NumericType` function described below.

Syntax

```
typeObj = Simulink.NumericType
```

Description

`typeObj = Simulink.NumericType` returns a `Simulink.NumericType` object with default property values.

Properties**Bias — Bias for slope and bias scaling**

0 (default) | real number

Bias for slope and bias scaling of a fixed-point data type (Fixed-Point Designer), specified as a real number.

If you use a number with a data type other than `double` to set the value, Simulink converts the value to `double`.

Corresponds to **Bias** in the property dialog box.

Example: 3

Data Types: `single` | `double` | `int8` | `int16` | `int32` | `int64` | `uint8` | `uint16` | `uint32` | `uint64` | `logical`

DataScope — Specification to generate or import type definition in the generated code

'Auto' (default) | 'Exported' | 'Imported'

Specification to generate or import the type definition (typedef) in the generated code (Simulink Coder), specified as 'Auto', 'Exported', or 'Imported'.

The table shows the effect of each option.

| Value | Action |
|------------------|--|
| 'Auto' (default) | If no value is specified for <code>HeaderFile</code> , export the type definition to <code>model_types.h</code> . <code>model</code> is the model name. If a value is specified for <code>HeaderFile</code> , import the data type definition from the specified header file. |
| 'Exported' | Export the data type definition to a header file, which can be specified in the <code>HeaderFile</code> property. If no value is specified for <code>HeaderFile</code> , the header file name defaults to <code>type.h</code> . <code>type</code> is the data type name. |
| 'Imported' | Import the data type definition from a header file, which can be specified in the <code>HeaderFile</code> property. If no value is specified for <code>HeaderFile</code> , the header file name defaults to <code>type.h</code> . <code>type</code> is the data type name. |

For more information, see “Control File Placement of Custom Data Types” (Embedded Coder).

Corresponds to **Data scope** in the property dialog box.

DataTypeMode — Mode of numeric data type

'Double' (default) | 'Single' | 'Half' | 'Boolean' | 'Fixed-point: unspecified scaling' | 'Fixed-point: binary point scaling' | 'Fixed-point: slope and bias scaling'

Mode of the numeric data type, specified as one of these character vectors:

- 'Double' — Same as the MATLAB double type.
- 'Single' — Same as the MATLAB single type.
- 'Half' — Half-precision floating-point type.
- 'Boolean' — Same as the MATLAB boolean type.
- 'Fixed-point: unspecified scaling' — A fixed-point data type with unspecified scaling.
- 'Fixed-point: binary point scaling' — A fixed-point data type with binary-point scaling.
- 'Fixed-point: slope and bias scaling' — A fixed-point data type with slope and bias scaling.

Selecting a half-precision or fixed-point data type mode can, depending on the other dialog box options that you select, cause the model to run only on systems that have a Fixed-Point Designer license.

Corresponds to **Data type mode** in the property dialog box.

Data Types: char

DataTypeOverride — Data type override mode

'Inherit' (default) | 'Off'

Data type override mode, specified as 'Inherit' or 'Off'.

- If you specify 'Inherit', the data type override setting for the context in which this numeric type is used (block, signal, Stateflow chart in Simulink) applies to this numeric type.
- If you specify 'Off', data type override does not apply to this numeric type.

For more information about data type override, see “Control Data Type Override”.

Corresponds to **Data type override** in the property dialog box.

Data Types: char

Description — Custom description of data type

' ' (empty character vector) (default) | character vector

Custom description of the data type, specified as a character vector.

Corresponds to **Description** in the property dialog box.

Example: 'This is a floating-point data type.'

Data Types: char

FixedExponent — Exponent for binary point scaling

0 (default) | real number

Exponent for binary point scaling, specified as a real number. Setting this property causes Simulink software to set the FractionLength and Slope properties accordingly, and vice versa. This property applies only if the DataTypeMode is Fixed-point: binary point scaling or Fixed-point: slope and bias scaling.

If you use a number with a data type other than double to set the value, Simulink converts the value to double.

This property does not appear in the property dialog box.

Example: -8

Data Types: `single` | `double` | `int8` | `int16` | `int32` | `int64` | `uint8` | `uint16` | `uint32` | `uint64` | `logical`

FractionLength — Bit length of the fractional portion of a fixed-point number

0 (default) | real integer

Bit length of the fractional portion of a fixed-point number (Fixed-Point Designer), specified as a real integer. This property equals `-FixedExponent`. Setting this property causes Simulink software to set the `FixedExponent` property accordingly, and vice versa.

If you use a number with a data type other than `double` to set the value, Simulink converts the value to `double`.

Corresponds to **Fraction length** in the property dialog box.

Example: 8

Data Types: `single` | `double` | `int8` | `int16` | `int32` | `int64` | `uint8` | `uint16` | `uint32` | `uint64` | `logical`

HeaderFile — Name of header file that contains type definition in the generated code

' ' (empty character vector) (default) | character vector

Name of the header file that contains the type definition (typedef) in the generated code, specified as a character vector.

If this property is specified, the specified name is used during code generation for importing or exporting. If this property is empty, the value defaults to `type.h` if `DataScope` equals `'Imported'` or `'Exported'`, or defaults to `model_types.h` if `DataScope` equals `'Auto'`.

By default, the generated `#include` directive uses the preprocessor delimiter `"` instead of `<` and `>`. To generate the directive `#include <myTypes.h>`, specify `HeaderFile` as `'<myTypes.h>'`.

For more information, see “Control File Placement of Custom Data Types” (Embedded Coder).

Corresponds to **Header file** in the property dialog box.

Example: `'myHdr.h'`

Example: `'myHdr'`

Example: `'myHdr.hpp'`

Data Types: `char`

IsAlias — Specification to create data type alias using object name

`false` (default) | `true`

Specification to create a data type alias by using the name of the object, specified as `true` (yes) or `false` (no).

If you specify `true`, the object acts as a data type alias in a similar manner to a `Simulink.AliasType` object. For more information, see “Control Data Type Names in Generated Code” (Embedded Coder).

Corresponds to **Is alias** in the property dialog box.

Data Types: `single` | `double` | `int8` | `int16` | `int32` | `int64` | `uint8` | `uint16` | `uint32` | `uint64` | `logical`

Signedness — Signedness of fixed-point data type

'Signed (default)' | 'Unsigned' | 'Auto'

Signedness of a fixed-point data type (Fixed-Point Designer), specified as 'Signed' (signed), 'Unsigned' (unsigned), or 'Auto' (inherit signedness).

Corresponds to **Signedness** in the property dialog box.

Data Types: `char`

SignednessBool — Signedness of fixed-point data type

`false` | `true`

Signedness of a fixed-point data type (Fixed-Point Designer), specified as a Boolean.

Corresponds to **Signedness** in the property dialog box.

Data Types: `logical`

Slope — Slope for slope and bias scaling of fixed-point data type

2^0 (default) | real number

Slope for slope and bias scaling of a fixed-point data type (Fixed-Point Designer), specified as a real number.

This property equals $\text{SlopeAdjustmentFactor} * 2^{\text{FixedExponent}}$. If $\text{SlopeAdjustmentFactor}$ is 1.0, Simulink software displays the value of this field as $2^{\text{SlopeAdjustmentFactor}}$. Otherwise, it displays it as a numeric value. Setting this property causes Simulink software to set the `FixedExponent` and `SlopeAdjustmentFactor` properties accordingly, and vice versa.

If you use a number with a data type other than `double` to set the value, Simulink converts the value to `double`.

This property appears only if `DataTypeMode` is `Fixed-point: slope and bias scaling`.

Corresponds to **Slope** in the property dialog box.

Example: 5.2

Example: 2^9

Data Types: `single` | `double` | `int8` | `int16` | `int32` | `int64` | `uint8` | `uint16` | `uint32` | `uint64` | `logical`

SlopeAdjustmentFactor — Slope for slope and bias scaling of fixed-point data type

1 (default) | real number

Slope for slope and bias scaling of a fixed-point data type (Fixed-Point Designer), specified as a real number in the range [1, 2).

Setting this property causes Simulink software to adjust the `Slope` property accordingly, and vice versa. This property applies only if `DataTypeMode` is `Fixed-point: slope and bias scaling`.

If you use a number with a data type other than `double` to set the value, Simulink converts the value to `double`.

This property does not appear in the property dialog box.

Example: 1.7

Data Types: `single` | `double` | `int8` | `int16` | `int32` | `int64` | `uint8` | `uint16` | `uint32` | `uint64` | `logical`

WordLength — Word size of fixed-point or integer data type

16 (default) | `integer`

Word size of a fixed-point (Fixed-Point Designer) or integer data type, specified as an integer number of bits.

This property appears only if `DataTypeMode` is `Fixed-point`.

If you use a number with a data type other than `double` to set the value, Simulink converts the value to `double`.

Corresponds to **Word length** in the property dialog box.

Example: 8

Data Types: `single` | `double` | `int8` | `int16` | `int32` | `int64` | `uint8` | `uint16` | `uint32` | `uint64` | `logical`

Object Functions

| | |
|-----------------------------------|--|
| <code>isboolean</code> | Determine whether numeric type represents the Boolean data type <code>boolean</code> |
| <code>isdouble</code> | Determine whether numeric type represents the double-precision, floating-point data type <code>double</code> |
| <code>isfixed</code> | Determine whether numeric type represents a fixed-point data type |
| <code>isfloat</code> | Determine whether numeric type represents a floating-point data type |
| <code>isscalingbinarypoint</code> | Determine whether fixed-point numeric type has binary-point scaling |
| <code>isscalingslopebias</code> | Determine whether numeric type represents a fixed-point data type with slope-and-bias scaling |
| <code>isscalingunspecified</code> | Determine whether numeric type represents a data type with unspecified scaling |
| <code>issingle</code> | Determine whether numeric type represents the single-precision, floating-point data type <code>single</code> |
| <code>ishalf</code> | Determine whether numeric type represents the half-precision, floating-point data type <code>half</code> |

Examples

Share a Data Type Between Separate Algorithms, Data Paths, Models, and Bus Elements

See “Share a Data Type Between Separate Algorithms, Data Paths, Models, and Bus Elements”.

Extended Capabilities

C/C++ Code Generation

Generate C and C++ code using MATLAB® Coder™.

When you select the **Is alias** property, a `Simulink.NumericType` object appears in the generated code as a `typedef` statement. The generated code uses the named type to define and declare data (variables).

Fixed-Point Conversion

Design and simulate fixed-point systems using Fixed-Point Designer™.

See Also

`Simulink.AliasType`

Topics

“Validate a Floating-Point Embedded Model”

“Control Data Types of Signals”

“Control Data Type Names in Generated Code” (Embedded Coder)

“Data Types Supported by Simulink”

“About Data Types in Simulink”

Introduced before R2006a

isboolean

Package: Simulink

Determine whether numeric type represents the Boolean data type `boolean`

Syntax

```
indication = isboolean(numericType)
```

Description

`indication = isboolean(numericType)` returns 1 (true) if the `Simulink.NumericType` object `numericType` represents the Boolean data type `boolean` and 0 (false) otherwise.

In Simulink, a `Simulink.NumericType` object represents a data type that you can share between different data items in a model. For more information, see `Simulink.NumericType`.

Input Arguments

numericType — Target numeric type

`Simulink.NumericType` object

Target numeric type, specified as a `Simulink.NumericType` object.

Output Arguments

indication — Indication of whether target object represents `boolean`

1 | 0

Indication of whether the target object represents `boolean`, returned as 1 (true) or 0 (false).

See Also

`Simulink.NumericType`

Topics

“Control Data Types of Signals”

“Control Block Parameter Data Types”

“Control Data Type Names in Generated Code” (Embedded Coder)

Introduced in R2010b

isdouble

Package: Simulink

Determine whether numeric type represents the double-precision, floating-point data type `double`

Syntax

```
indication = isdouble(numericType)
```

Description

`indication = isdouble(numericType)` returns 1 (true) if the `Simulink.NumericType` object `numericType` represents the double-precision, floating-point data type `double` and 0 (false) otherwise.

In Simulink, a `Simulink.NumericType` object represents a data type that you can share between different data items in a model. For more information, see `Simulink.NumericType`.

Input Arguments

numericType — Target numeric type

`Simulink.NumericType` object

Target numeric type, specified as a `Simulink.NumericType` object.

Output Arguments

indication — Indication of whether target object represents double

1 | 0

Indication of whether the target object represents double, returned as 1 (true) or 0 (false).

See Also

`Simulink.NumericType` | `ishalf` | `issingle` | `isfloat`

Topics

“Control Data Types of Signals”

“Control Block Parameter Data Types”

“Control Data Type Names in Generated Code” (Embedded Coder)

Introduced in R2010b

isfixed

Package: Simulink

Determine whether numeric type represents a fixed-point data type

Syntax

```
indication = isfixed(numericType)
```

Description

`indication = isfixed(numericType)` returns 1 (true) if the `Simulink.NumericType` object `numericType` represents a fixed-point data type and 0 (false) otherwise.

In Simulink, a `Simulink.NumericType` object represents a data type that you can share between different data items in a model. For more information, see `Simulink.NumericType`.

Input Arguments

numericType — Target numeric type

`Simulink.NumericType` object

Target numeric type, specified as a `Simulink.NumericType` object.

Output Arguments

indication — Indication of whether target object represents a fixed-point type

1 | 0

Indication of whether the target object represents a fixed-point type, returned as 1 (true) or 0 (false).

See Also

`Simulink.NumericType` | `isscalingbinarypoint` | `isscalingslopebias` | `isscalingunspecified`

Topics

“Control Data Types of Signals”

“Control Block Parameter Data Types”

“Control Data Type Names in Generated Code” (Embedded Coder)

Introduced in R2010b

isfloat

Package: Simulink

Determine whether numeric type represents a floating-point data type

Syntax

```
indication = isfloat(numericType)
```

Description

`indication = isfloat(numericType)` returns 1 (true) if the `Simulink.NumericType` object `numericType` represents a floating-point data type such as `double`, `single`, or `half`, and 0 (false) otherwise.

In Simulink, a `Simulink.NumericType` object represents a data type that you can share between different data items in a model. For more information, see `Simulink.NumericType`.

Input Arguments

numericType — Target numeric type

`Simulink.NumericType` object

Target numeric type, specified as a `Simulink.NumericType` object.

Output Arguments

indication — Indication of whether target object represents a floating-point type

1 | 0

Indication of whether the target object represents a floating-point type, returned as 1 (true) or 0 (false).

See Also

`Simulink.NumericType` | `isdouble` | `issingle` | `ishalf`

Topics

“Control Data Types of Signals”

“Control Block Parameter Data Types”

“Control Data Type Names in Generated Code” (Embedded Coder)

Introduced in R2010b

ishalf

Package: Simulink

Determine whether numeric type represents the half-precision, floating-point data type `half`

Syntax

```
indication = ishalf(numericType)
```

Description

`indication = ishalf(numericType)` returns 1 (true) if the `Simulink.NumericType` object `numericType` represents the half-precision, floating-point data type `half` and 0 (false) otherwise.

In Simulink, a `Simulink.NumericType` object represents a data type that you can share between different data items in a model. For more information, see `Simulink.NumericType`.

Input Arguments

numericType — Target numeric type

`Simulink.NumericType` object

Target numeric type, specified as a `Simulink.NumericType` object.

Output Arguments

indication — Indication of whether target object represents `half`

1 | 0

Indication of whether the target object represents `half`, returned as 1 (true) or 0 (false).

See Also

`Simulink.NumericType` | `isfloat` | `isdouble` | `issingle`

Topics

“Control Data Types of Signals”

“Control Block Parameter Data Types”

“Control Data Type Names in Generated Code” (Embedded Coder)

Introduced in R2020b

isscalingbinarypoint

Package: Simulink

Determine whether fixed-point numeric type has binary-point scaling

Syntax

```
indication = isscalingbinarypoint(numericType)
```

Description

`indication = isscalingbinarypoint(numericType)` returns 1 (true) if the `Simulink.NumericType` object `numericType` represents a fixed-point data type with binary-point scaling and 0 (false) otherwise. A numeric type object can use binary-point scaling if you explicitly specify it or if you specify trivial slope-and-bias scaling (the slope is an integer power of two and the bias is zero).

In Simulink, a `Simulink.NumericType` object represents a data type that you can share between different data items in a model. For more information, see `Simulink.NumericType`.

Input Arguments

numericType — Target numeric type

`Simulink.NumericType` object

Target numeric type, specified as a `Simulink.NumericType` object.

Output Arguments

indication — Indication of whether target object represents fixed-point type with binary-point scaling

1 | 0

Indication of whether the target object represents a fixed-point type with binary-point scaling, returned as 1 (true) or 0 (false).

See Also

`Simulink.NumericType` | `isfixed` | `isscalingslopebias` | `isscalingunspecified`

Topics

“Control Data Types of Signals”

“Control Block Parameter Data Types”

“Control Data Type Names in Generated Code” (Embedded Coder)

Introduced in R2010b

isscalingslopebias

Package: Simulink

Determine whether numeric type represents a fixed-point data type with slope-and-bias scaling

Syntax

```
indication = isscalingslopebias(numericType)
```

Description

`indication = isscalingslopebias(numericType)` returns 1 (true) if the `Simulink.NumericType` object `numericType` represents a fixed-point data type with nontrivial slope-and-bias scaling and 0 (false) otherwise. A slope-and-bias fixed-point type has trivial scaling if the slope is an integer power of two and the bias is zero.

In Simulink, a `Simulink.NumericType` object represents a data type that you can share between different data items in a model. For more information, see `Simulink.NumericType`.

Input Arguments

numericType — Target numeric type

`Simulink.NumericType` object

Target numeric type, specified as a `Simulink.NumericType` object.

Output Arguments

indication — Indication of whether target object represents fixed-point type with slope-and-bias scaling

1 | 0

Indication of whether the target object represents a fixed-point type with nontrivial slope-and-bias scaling, returned as 1 (true) or 0 (false).

See Also

`Simulink.NumericType` | `isfixed` | `isscalingbinarypoint` | `isscalingunspecified`

Topics

“Control Data Types of Signals”

“Control Block Parameter Data Types”

“Control Data Type Names in Generated Code” (Embedded Coder)

Introduced in R2010b

isscalingunspecified

Package: Simulink

Determine whether numeric type represents a data type with unspecified scaling

Syntax

```
indication = isscalingunspecified(numericType)
```

Description

`indication = isscalingunspecified(numericType)` returns 1 (true) if the `Simulink.NumericType` object `numericType` represents a fixed-point or scaled double data type with unspecified scaling and 0 (false) otherwise.

In Simulink, a `Simulink.NumericType` object represents a data type that you can share between different data items in a model. For more information, see `Simulink.NumericType`.

Input Arguments

numericType — Target numeric type

`Simulink.NumericType` object

Target numeric type, specified as a `Simulink.NumericType` object.

Output Arguments

indication — Indication of whether target object represents a type with unspecified scaling

1 | 0

Indication of whether the target object represents a type with unspecified scaling, returned as 1 (true) or 0 (false).

See Also

`Simulink.NumericType` | `isfixed` | `isscalingbinarypoint` | `isscalingslopebias`

Topics

“Control Data Types of Signals”

“Control Block Parameter Data Types”

“Control Data Type Names in Generated Code” (Embedded Coder)

Introduced in R2010b

issingle

Package: Simulink

Determine whether numeric type represents the single-precision, floating-point data type `single`

Syntax

```
indication = issingle(numericType)
```

Description

`indication = issingle(numericType)` returns 1 (true) if the `Simulink.NumericType` object `numericType` represents the single-precision, floating-point data type `single` and 0 (false) otherwise.

In Simulink, a `Simulink.NumericType` object represents a data type that you can share between different data items in a model. For more information, see `Simulink.NumericType`.

Input Arguments

numericType — Target numeric type

`Simulink.NumericType` object

Target numeric type, specified as a `Simulink.NumericType` object.

Output Arguments

indication — Indication of whether target object represents `single`

1 | 0

Indication of whether the target object represents `single`, returned as 1 (true) or 0 (false).

See Also

`Simulink.NumericType` | `ishalf` | `isdouble` | `isfloat`

Topics

“Control Data Types of Signals”

“Control Block Parameter Data Types”

“Control Data Type Names in Generated Code” (Embedded Coder)

Introduced in R2010b

Simulink.RunTimeBlock

Allow Level-2 MATLAB S-function and other MATLAB programs to get information about block while simulation is running

Description

This class allows a Level-2 MATLAB S-function or other MATLAB program to obtain information about a block. Simulink software creates an instance of this class or a derived class for each block in a model. Simulink software passes the object to the callback methods of Level-2 MATLAB S-functions when it updates or simulates a model, allowing the callback methods to get block-related information from and provide such information to Simulink software. See “Write Level-2 MATLAB S-Functions” in Writing S-Functions for more information. You can also use instances of this class in MATLAB programs to obtain information about blocks during a simulation. See “Access Block Data During Simulation” for more information.

Note Simulink.RunTimeBlock objects do not support MATLAB sparse matrices. For example, the following line of code attempts to assign a sparse identity matrix to the run-time object's output port data. This line of code in a Level-2 MATLAB S-function produces an error:

```
block.Outputport(1).Data = speye(10);
```

Parent Class

None

Derived Classes

Simulink.MSFcnRunTimeBlock

Property Summary

| Name | Description |
|------------------------------------|--|
| “BlockHandle” on page 5-446 | Block's handle. |
| “CurrentTime” on page 5-446 | Current simulation time. |
| “NumDworks” on page 5-446 | Number of discrete work vectors used by the block. |
| “NumOutputPorts” on page 5-447 | Number of block output ports. |
| “NumContStates” on page 5-447 | Number of block's continuous states. |
| “NumDworkDiscStates” on page 5-447 | Number of block's discrete states |
| “NumDialogPrms” on page 5-447 | Number of parameters that can be entered on S-function block's dialog box. |
| “NumInputPorts” on page 5-448 | Number of block's input ports. |

| Name | Description |
|--------------------------------|---|
| "NumRuntimePrms" on page 5-448 | Number of run-time parameters used by block. |
| "SampleTimes" on page 5-448 | Sample times at which block produces outputs. |

Method Summary

| Name | Description |
|---------------------------------------|--|
| "ContStates" on page 5-448 | Get a block's continuous states. |
| "DataTypeIsFixedPoint" on page 5-449 | Determine whether a data type is fixed point. |
| "DatatypeName" on page 5-449 | Get name of a data type supported by this block. |
| "DatatypeSize" on page 5-449 | Get size of a data type supported by this block. |
| "Derivatives" on page 5-450 | Get a block's continuous state derivatives. |
| "DialogPrm" on page 5-450 | Get a parameter entered on an S-function block's dialog box. |
| "Dwork" on page 5-450 | Get one of a block's DWork vectors. |
| "FixedPointNumericType" on page 5-451 | Determine the properties of a fixed-point data type. |
| "InputPort" on page 5-451 | Get one of a block's input ports. |
| "OutputPort" on page 5-452 | Get one of a block's output ports. |
| "RuntimePrm" on page 5-452 | Get one of the run-time parameters used by a block. |

Properties

BlockHandle

Description

Block's handle.

Access

R0

CurrentTime

Description

Current simulation time.

Access

R0

NumDworks

Description

Number of data work vectors.

Access

RW

See Also

ssGetNumDWork

NumOutputPorts**Description**

Number of output ports.

Access

RW

See Also

ssGetNumOutputPorts

NumContStates**Description**

Number of continuous states.

Access

RW

See Also

ssGetNumContStates

NumDworkDiscStates**Description**

Number of discrete states. In a MATLAB S-function, you need to use DWorks to set up discrete states.

Access

RW

See Also

ssGetNumDiscStates

NumDialogPrms**Description**

Number of parameters declared on the block's dialog. In the case of the S-function, it returns the number of parameters listed as a comma-separated list in the **S-function parameters** dialog field.

Access

RW

See Also

ssGetNumSFcnParams

NumInputPorts**Description**

Number of input ports.

Access

RW

See Also

ssGetNumInputPorts

NumRuntimePrms**Description**

Number of run-time parameters used by this block. See “Create and Update S-Function Run-Time Parameters” for more information.

Access

RW

See Also

ssGetNumSFcnParams

SampleTimes**Description**

Block's sample times.

Access

RW for MATLAB S-functions, RO for all other blocks.

Methods**ContStates****Purpose**

Get a block's continuous states.

Syntax

```
states = ContStates();
```

Description

Get vector of continuous states.

See Also

ssGetContStates

DataTypesFixedPoint**Purpose**

Determine whether a data type is fixed point.

Syntax

```
bVal = DataTypeIsFixedPoint(dtID);
```

Arguments

dtID

Integer value specifying the ID of a data type.

Description

Returns `true` if the specified data type is a fixed-point data type.

DatatypeName**Purpose**

Get the name of a data type.

Syntax

```
name = DatatypeName(dtID);
```

Arguments

dtID

Integer value specifying ID of a data type.

Description

Returns the name of the data type specified by `dtID`.

See Also

“DatatypeSize” on page 5-449

DatatypeSize**Purpose**

Get the size of a data type.

Syntax

```
size = DatatypeSize(dtID);
```

Arguments

dtID

Integer value specifying the ID of a data type.

Description

Returns the size of the data type specified by dtID.

See Also

“DatatypeName” on page 5-449

Derivatives**Purpose**

Get derivatives of a block's continuous states.

Syntax

```
derivs = Derivatives();
```

Description

Get vector of state derivatives.

See Also

ssGetdX

DialogPrm**Purpose**

Get an S-function's dialog parameters.

Syntax

```
param = DialogPrm(pIdx);
```

Arguments

pIdx

Integer value specifying the index of the parameter to be returned.

Description

Get the specified dialog parameter. In the case of the S-function, each DialogPrm corresponds to one of the elements in the comma-separated list of parameters in the **S-function parameters** dialog field.

See Also

ssGetSFcnParam, “RuntimePrm” on page 5-452

Dwork**Purpose**

Get one of a block's DWork vectors.

Syntax

```
dworkObj = Dwork(dwIdx);
```

Arguments

dwIdx

Integer value specifying the index of a work vector.

Description

Get information about the DWork vector specified by dwIdx where dwIdx is the index number of the work vector. This method returns an object of type `Simulink.BlockCompDworkData`.

See Also

ssGetDWork

FixedPointNumericType**Purpose**

Get the properties of a fixed-point data type.

Syntax

```
eno = FixedPointNumericType(dtID);
```

Arguments

dtID

Integer value specifying the ID of a fixed-point data type.

Description

Returns an object of `embedded.Numeric` class that contains the attributes of the specified fixed-point data type.

Note `embedded.Numeric` is also the class of the `numericType` objects created by Fixed-Point Designer software. For information on the properties defined by `embedded.Numeric` class, see “`numericType` Object Properties” (Fixed-Point Designer).

InputPort**Purpose**

Get an input port of a block.

Syntax

```
port = InputPort(pIdx);
```

Arguments

pIdx

Integer value specifying the index of an input port.

Description

Get the input port specified by pIdx, where pIdx is the index number of the input port. For example,

```
port = rto.InputPort(1)
```

returns the first input port of the block represented by the run-time object `rto`.

This method returns an object of type `Simulink.BlockPreCompInputPortData` or `Simulink.BlockCompInputPortData`, depending on whether the model that contains the port is uncompiled or compiled. You can use this object to get and set the input port's uncompiled or compiled properties, respectively.

See Also

`ssGetInputPortSignalPtrs`, `Simulink.BlockPreCompInputPortData`, `Simulink.BlockCompInputPortData`, “OutputPort” on page 5-452

OutputPort**Purpose**

Get an output port of a block.

Syntax

```
port = OutputPort(pIdx);
```

Arguments

`pIdx`

Integer value specifying the index of an output port.

Description

Get the output port specified by `pIdx`, where `pIdx` is the index number of the output port. For example,

```
port = rto.OutputPort(1)
```

returns the first output port of the block represented by the run-time object `rto`.

This method returns an object of type `Simulink.BlockPreCompOutputPortData` or `Simulink.BlockCompOutputPortData`, depending on whether the model that contains the port is uncompiled or compiled, respectively. You can use this object to get and set the output port's uncompiled or compiled properties, respectively.

See Also

`ssGetInputPortSignalPtrs`, `Simulink.BlockPreCompOutputPortData`, `Simulink.BlockCompOutputPortData`

RuntimePrm**Purpose**

Get an S-function's run-time parameters.

Syntax

```
param = RuntimePrm(pIdx);
```

Arguments

pIdx

Integer value specifying the index of a run-time parameter.

Description

Get the run-time parameter whose index is pIdx. This run-time parameter is a Simulink.BlockData on page 5-207 object of type Simulink.BlockRunTimePrmData.

See Also

ssGetRunTimeParamInfo

Introduced before R2006a

Simulink.SampleTime class

Package: Simulink

Object containing sample time information

Description

The `SampleTime` class represents the sample time information associated with an individual sample time.

Use the methods `Simulink.Block.getSampleTimes` and `Simulink.BlockDiagram.getSampleTimes` to retrieve the values of the `SampleTime` properties for a block and for a block diagram, respectively.

Properties

Value

A two-element array of doubles that contains the period and offset of the sample time

Description

A $1 \times n$ character array that describes the sample time type

ColorRGBValue

A 1×3 array of doubles that contains the red, green and blue (RGB) values of the sample time color

Annotation

A $1 \times n$ character array that represents the annotation of a specific sample time (for example, 'D1')

OwnerBlock

For asynchronous and variable sample times, `OwnerBlock` is a character vector containing the full path to the block that controls the sample time. For all other types of sample times, it is an empty character vector.

ComponentSampleTimes

If the sample time is an async union or if the sample time is hybrid and the component sample times are available, then the array `ComponentSampleTimes` contains `Simulink.SampleTime` objects.

Copy Semantics

Value. To learn how value classes affect copy operations, see [Copying Objects in the MATLAB Programming Fundamentals documentation](#).

Examples

Retrieve the sample time information for the 'vdp' model.

```
ts = Simulink.BlockDiagram.getSampleTimes('vdp')
```

Simulink returns:

```
ts =
```

```
1x2 Simulink.SampleTime  
Package: Simulink
```

```
Properties:
```

```
Value  
Description  
ColorRGBValue  
Annotation  
OwnerBlock  
ComponentSampleTimes
```

```
Methods
```

To examine the values of the properties:

```
ts(1), ts(2)
```

```
ans =
```

```
Simulink.SampleTime  
Package: Simulink
```

```
Properties:
```

```
Value: [0 0]  
Description: 'Continuous'  
ColorRGBValue: [0 0 0]  
Annotation: 'Cont'  
OwnerBlock: []  
ComponentSampleTimes: {}
```

```
Methods
```

```
ans =
```

```
Simulink.SampleTime  
Package: Simulink
```

```
Properties:
```

```
Value: [Inf 0]  
Description: 'Constant'  
ColorRGBValue: [1 0.2600 0.8200]  
Annotation: 'Inf'  
OwnerBlock: []  
ComponentSampleTimes: {}
```

```
Methods
```

See Also

[Simulink.Block.getSampleTimes](#) | [Simulink.BlockDiagram.getSampleTimes](#)

Simulink.sdi.constraints.MatchesSignal class

Package: Simulink.sdi.constraints

Superclasses: matlab.unittest.constraints.Constraint

Constraint that compares time series data with tolerances using the Simulation Data Inspector

Description

Use the `Simulink.sdi.constraints.MatchesSignal` constraint to compare time series data against an expected value as part of a test. You can configure the constraint to use a combination of absolute, relative, and time tolerance values for the comparison. You can also specify additional options to configure the comparison behavior using a `Simulink.sdi.constraints.MatchesSignalOptions` object or using one or more name-value pair arguments on page 5-456. For more information about how tolerances and alignment options affect comparisons, see “How the Simulation Data Inspector Compares Data”.

Note The `MatchesSignal` constraint uses the Simulation Data Inspector to perform comparisons and requires a license for one of these products:

- Simulink
 - Signal Processing Toolbox™
 - MATLAB Coder
 - Fixed-Point Designer
-

Creation

Description

`MatchesSignal(expVal)` creates a constraint that determines whether time series data representing an actual value matches the data specified by the expected value, `expVal` on page 5-0 .

`MatchesSignal(expVal, Name, Value)` creates a constraint with additional properties on page 5-458 specified by one or more `Name, Value` pair arguments.

Input Arguments

Name-Value Pair Arguments

Specify optional comma-separated pairs of `Name, Value` arguments. `Name` is the argument name and `Value` is the corresponding value. `Name` must appear inside quotes. You can specify several name and value pair arguments in any order as `Name1, Value1, . . . , NameN, ValueN`.

Example: `'IgnoringDataTypes', true`

IgnoringDataTypes — Constraint behavior when data types do not match

`false` (default) | `true`

Configure constraint sensitivity to the actual value having a different data type from the expected value.

- `false` — The constraint checks whether the expected value and actual value data types match.
- `true` — The constraint is insensitive to data type mismatches between the expected value and actual value.

Example: `'IgnoringDataTypes', true`

IgnoringSignalsNotAligned — Constraint behavior when signals do not align

`false` (default) | `true`

Configure constraint sensitivity to one or more signals not aligning between the expected value and actual value.

- `false` — The constraint checks for signals that do not align between the expected value and actual value.
- `true` — The constraint is insensitive to one or more signals not aligning between the expected value and actual value.

Example: `'IgnoringSignalsNotAligned', true`

IgnoringExtraData — Constraint behavior when the actual value covers a different time interval from the expected value

`false` (default) | `true`

Configure the constraint sensitivity to the actual value containing data outside of the time interval defined by the expected value.

- `false` — The constraint checks whether the actual value contains data outside the time interval defined by the expected value.
- `true` — The constraint is insensitive to the actual value containing data outside the time interval defined by the expected value.

Example: `'IgnoringExtraData', true`

AligningBy — Signal alignment criteria

string array

Alignment criteria for the comparison. When the expected value contains more than one signal, the Simulation Data Inspector comparison algorithm aligns signals for comparison between the expected and actual values. By default, the Simulation Data Inspector aligns by data source, then by block path, then by SID, and then by signal name. For details about the Simulation Data Inspector alignment algorithm, see “How the Simulation Data Inspector Compares Data”.

Specify alignment criteria as a string array with one or more of these options listed in the order in which you want them considered:

- `BlockPath` — The path to the source block for the signal.
- `SID` — Simulink identifier. For more information, see “Simulink Identifiers”.
- `SignalName` — The name of the signal.
- `DataSource` — Path of the variable.

Example: 'AligningBy', ["SignalName", "BlockPath"] specifies signal alignment by signal name and then by block path.

Properties

Expected — Expected value to use as the baseline for the comparison

time series data | string scalar | character array

Expected value to use as the baseline for the comparison. The data for the expected value must pair data values with time. The data can be in any format supported by the Simulation Data Inspector. The Simulation Data Inspector requires data in a format that associates sample values with time. Supported formats include `timeseries`, `Structure with time`, and `Dataset`.

You can specify the expected value for the constraint using a variable in the workspace that contains the data or by specifying the full path or file name of a file that contains the data, as a string scalar or a character array.

Attributes:

| | |
|-----------|-----------|
| GetAccess | public |
| SetAccess | immutable |

MatchesSignalOptions — Constraint comparison configuration options

`Simulink.sdi.constraints.MatchesSignalOptions`

`Simulink.sdi.constraints.MatchesSignalOptions` object that specifies options to configure the comparison for the constraint. By default, the comparison uses the default alignment settings for the Simulation Data Inspector and has strict acceptance criteria, meaning that the comparison does not ignore any checks. You can use the `MatchesSignalOptions` property to configure how the constraint aligns signals in the expected and actual runs and whether tests using the constraint are sensitive to:

You can specify the `MatchesSignalOptions` property for the constraint using individual name-value pair arguments on page 5-456 or using the name-value pair 'WithOptions' with a `Simulink.sdi.constraints.MatchesSignalOptions` object as the value. When you specify the `MatchesSignalOptions` property using a `MatchesSignalOptions` object, you can use a single name-value pair to configure all the options for comparisons that use the constraint.

Attributes:

| | |
|-----------|-----------|
| GetAccess | public |
| SetAccess | immutable |

Data Types: `Simulink.sdi.constraints.MatchesSignalOptions`

AbsTol — Absolute tolerance for comparison

0 (default) | scalar

Absolute tolerance for comparisons using the constraint. For details about how the Simulation Data Inspector uses tolerance values in comparisons, see “How the Simulation Data Inspector Compares Data”.

Example: 0.1

Example: 2

Attributes:

| | |
|-----------|-----------|
| GetAccess | public |
| SetAccess | immutable |

Data Types: double

RelTol — Relative tolerance for comparison

0 (default) | scalar

Relative tolerance for comparisons using the constraint. For example, specify 0.1 to use a 10% tolerance for the comparison. For details about how the Simulation Data Inspector uses tolerance values in comparisons, see “How the Simulation Data Inspector Compares Data”.

Example: 0.05

Attributes:

| | |
|-----------|-----------|
| GetAccess | public |
| SetAccess | immutable |

Data Types: double

TimeTol — Time tolerance for comparison

0 (default) | scalar

Time tolerance for comparisons using the constraint, in seconds. For details about how the Simulation Data Inspector uses tolerance values in comparisons, see “How the Simulation Data Inspector Compares Data”.

Example: 0.001

Attributes:

| | |
|-----------|-----------|
| GetAccess | public |
| SetAccess | immutable |

Data Types: double

Examples**Create Tests for Time Series Comparisons**

This example shows how to use the `Simulink.sdi.constraints.MatchesSignal` constraint to compare time series data using data generated in the workspace. You can use the `MatchesSignal` constraint to compare data from many sources, including measured test data in a file and logged simulation outputs.

When you use the `MatchesSignal` constraint, you can specify absolute, relative, and time tolerances to use in the comparison. The `MatchesSignal` constraint uses the Simulation Data Inspector comparison algorithm, which includes steps for alignment and synchronization. For more information about the algorithm, see “How the Simulation Data Inspector Compares Data”.

The `MatchesSignal` constraint uses the Simulation Data Inspector for the time series comparison and requires one of these products:

- Simulink®
- Signal Processing Toolbox™
- MATLAB Coder™
- Fixed-Point Designer™

Create Time Series Data

This example generates workspace data in `timeseries` format for illustrative purposes only. You can use the `MatchesSignal` constraint to compare data from other sources, such as simulation outputs or a file containing test data, and the constraint can compare time series data in any format supported by the Simulation Data Inspector.

In this example, the first signal is a `timeseries` object containing data for a sine wave with the name `Wave Data`.

```
time = 0:0.1:20;
sig1vals = sin(2*pi/5*time);
sig1_ts = timeseries(sig1vals,time);
sig1_ts.Name = 'Wave Data';
```

The second signal is also a sine wave at the same frequency, with a slight attenuation and sampled at a different rate. Because the comparison algorithm for the `MatchesSignal` constraint includes a synchronization step, comparing these two signals with different time vectors does not always result in a test failure. The second signal is also named `Wave Data` so the alignment algorithm can pair the signals for comparison.

```
time2 = 0:0.05:20;
sig2vals = 0.98*sin(2*pi/5*time2);
sig2_ts = timeseries(sig2vals,time2);
sig2_ts.Name = 'Wave Data';
```

Create a Test Case and Compare the Signals

This example uses an interactive test for illustrative purposes. You can use the `MatchesSignal` constraint with other types of unit tests in the MATLAB testing framework. For example, to write class-based unit tests, see “Write Simple Test Case Using Classes”.

Create a `TestCase` instance for interactive use.

```
import matlab.unittest.TestCase

testCase = TestCase.forInteractiveUse;
```

Compare `sig1_ts` and `sig2_ts` using the `MatchesSignal` constraint. Use `sig1_ts` for the expected value in the instance of the `MatchesSignal` constraint.

```
import Simulink.sdi.constraints.MatchesSignal

testCase.verifyThat(sig2_ts,MatchesSignal(sig1_ts));
```

```
Verification failed.
-----
Framework Diagnostic:
-----
MatchesSignal(<Value>) failed.
--> The following aligned signals did not match:
```

| Name | ActualSignals | ExpectedSignals |
|-------------|-----------------|-------------------|
| "Wave Data" | "<Actual>.Data" | "<Expected>.Data" |

Comparison results have been saved to:

--> C:\TEMP\Bdoc21b_1757077_3096\ib2EDA31\13\comparisonResults_7b0a0ee3-8bdd-4276-9b99-307df

Stack Information:

In C:\TEMP\Bdoc21b_1757077_3096\ib2EDA31\13\tpabf3cb5a\simulink-ex22803619\TestTimeSeriesData

In B:\matlab\toolbox\matlab\codetools\embeddedoutputs\+matlab\+internal\+editor\evaluateRegion

In B:\matlab\toolbox\matlab\codetools\embeddedoutputs\+matlab\+internal\+editor\EvaluationOut

In B:\matlab\toolbox\matlab\codetools\+matlab\+internal\+liveeditor\@LiveEditorUtilities\exec

In B:\matlab\tools\examples\exampletools\+mwtools\liveCodeToDocbook.m (doRun) at 388

In B:\matlab\tools\examples\exampletools\+mwtools\liveCodeToDocbook.m (doRunConvert) at 338

In B:\matlab\tools\examples\exampletools\+mwtools\liveCodeToDocbook.m (liveCodeToDocbook) at

In B:\matlab\tools\build_using_matlab\BML.m (BML) at 13

The diagnostic information shows that the verification failed. When a test fails, the comparison results and original run data are saved in a Simulation Data Inspector session file. Click the link for the MLDATX file to open the session in the Simulation Data Inspector, where you can investigate the data compared by the test and the comparison results. When you inspect the results, you can see the attenuation creates the difference and causes the comparison to fail.

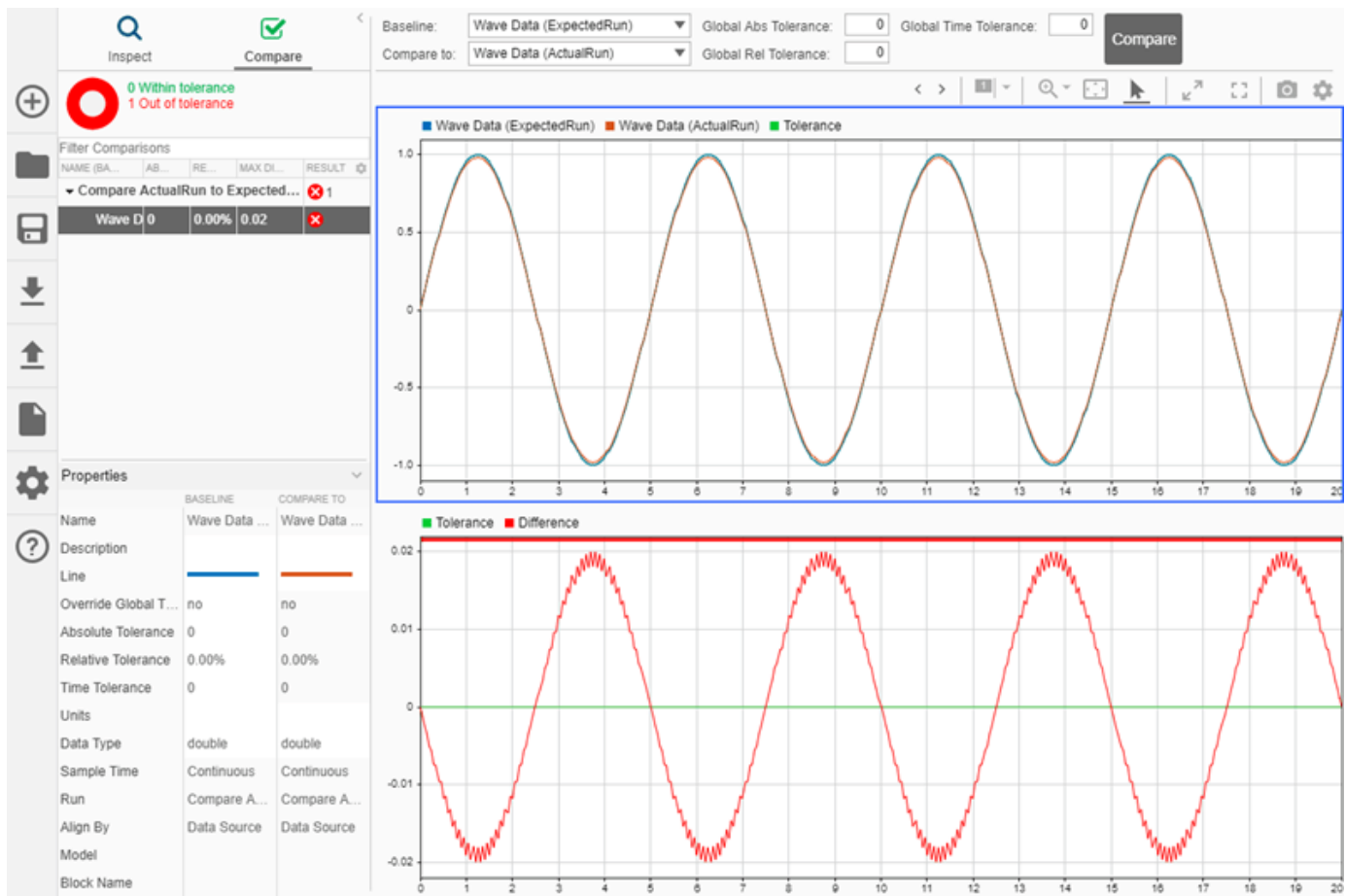

Specify an absolute tolerance of 0.02 for the instance of the `MatchesSignal` constraint to use in the comparison.

```
testCase.verifyThat(sig2_ts,MatchesSignal(sig1_ts,'AbsToL',0.02));
```

Verification passed.

Configure MatchesSignal Constraint Behavior

This example shows how to configure the comparison behavior of a `Simulink.sdi.constraints.MatchesSignal` constraint using a `Simulink.sdi.constraints.MatchesSignalOptions` object. You can use a `MatchesSignalOptions` object to configure multiple comparison properties with a single name-value pair input in the construction of the `MatchesSignal` instance.

Create Time Series Data

This example creates workspace data to use for illustrative purposes only. You can use the `MatchesSignal` constraint to compare data from other sources, such as simulation outputs or a file containing test data, and the constraint can compare time series data in any format supported by the Simulation Data Inspector.

In this example, the first signal is a `timeseries` object with the name `Wave Data` that contains data for a sine wave.

```
time = 0:0.1:20;
sig1vals = sin(2*pi/5*time);
sig1_ts = timeseries(sig1vals,time);
sig1_ts.Name = 'Wave Data';
```

The second signal is also a sine wave at the same frequency, with a slight attenuation and sampled at a different rate. Because the comparison algorithm for the `MatchesSignal` constraint includes a synchronization step, comparing these two signals with different time vectors does not necessarily result in a test failure. The second signal is cast to `single` data type and also named `Wave Data` so the alignment algorithm can pair the signals for comparison.

```
time2 = 0:0.1:22;
sig2vals = single(0.98*sin(2*pi/5*time2));
sig2_ts = timeseries(sig2vals,time2);
sig2_ts.Name = 'Wave Data';
```

Configure a MatchesSignal Instance and Compare the Data

You can use a `MatchesSignalOptions` object to specify how an instance of the `MatchesSignal` constraint handles conditions such as mismatched data types and how signals are aligned between the actual and expected data sets. You can specify the properties of the `MatchesSignalOptions` object to suit the test you want to write. For example, if you want your test to compare data of varying types and a data type match is not functionally relevant, you could set the `IgnoreDataTypes` property to `true`.

Create a `MatchesSignalOptions` object to create a `MatchesSignal` instance that ignores data type mismatches and data samples outside the time interval the actual and expected signals share.

```
import Simulink.sdi.constraints.MatchesSignalOptions
opts = MatchesSignalOptions('IgnoringDataTypes',true,'IgnoringExtraData',true);
```

Create a `TestCase` instance for interactive use and compare `sig1_ts` and `sig2_ts` using the `MatchesSignal` constraint, the `MatchesSignalOptions` object, and an absolute tolerance of `0.02`.

```
import matlab.unittest.TestCase
testCase = TestCase.forInteractiveUse;

import Simulink.sdi.constraints.MatchesSignal
testCase.verifyThat(sig2_ts,MatchesSignal(sig1_ts,'AbsTol',0.02,'WithOptions',opts))
```

Verification passed.

The test passes. When you run the same test again without the options defined by the `MatchesSignalOptions` object, the test fails due to the mismatched data types.

```
testCase.verifyThat(sig2_ts,MatchesSignal(sig1_ts,'AbsTol',0.02))
```

Verification failed.

```
-----
Framework Diagnostic:
-----
```

```
MatchesSignal(<Value>,'AbsTol',0.02) failed.
```

```
--> Data types do not match for the following aligned signals:
```

| Name | ActualSignals | ActualDataType | ExpectedSignals | ExpectedData |
|-------------|-----------------|----------------|-------------------|--------------|
| "Wave Data" | "<Actual>.Data" | {'single'} | "<Expected>.Data" | {'double'} |

```
-----  
Stack Information:  
-----
```

```
In C:\Users\snadeau\AppData\Local\Temp\Editor_oxzoe\LiveEditorEvaluationHelperE1184446395.m  
In E:\jobarchive\Bdoc20b\2020_06_06_h12m11s21_job1400967_pass\matlab\toolbox\matlab\codetool  
In E:\jobarchive\Bdoc20b\2020_06_06_h12m11s21_job1400967_pass\matlab\toolbox\matlab\codetool
```

Compatibility Considerations

Enhanced diagnostic information

Behavior changed in R2020a

Starting in R2020a, when a test that uses the `Simulink.sdi.constraints.MatchesSignal` constraint fails, the diagnostic information provides a path and link to a Simulation Data Inspector session file that includes the comparison results and the original data compared by the test. Open the session file to inspect the data and comparison results in the Simulation Data Inspector.

In previous releases, the diagnostic information included a path and link to a static image of the comparison results. The diagnostic information no longer includes the image.

See Also

`Simulink.sdi.constraints.MatchesSignalOptions` | `matlab.unittest.TestCase` | `matlab.unittest.constraints.Constraint` | `matlab.unittest.constraints` Package | `verifyThat`

Topics

“How the Simulation Data Inspector Compares Data”

“Author Class-Based Unit Tests in MATLAB”

“Write Script-Based Unit Tests”

“Write Simple Test Case Using Classes”

“Write Simple Test Case Using Functions”

Introduced in R2019a

Simulink.sdi.constraints.MatchesSignalOptions class

Package: `Simulink.sdi.constraints`

Specify comparison options for `Simulink.sdi.MatchesSignal` constraint

Description

Use a `Simulink.sdi.constraints.MatchesSignalOptions` object to configure the comparison behavior and acceptance criteria for an instance of the `Simulink.sdi.constraints.MatchesSignal` constraint.

Note The `MatchesSignal` constraint uses the Simulation Data Inspector to perform comparisons and requires a license for one of these products:

- Simulink
 - Signal Processing Toolbox
 - MATLAB Coder
 - Fixed-Point Designer
-

Creation

Description

`MatchesSignalOptions` creates an instance of the `Simulink.sdi.constraints.MatchesSignalOptions` class with properties that correspond to a constraint that does not ignore any checks and uses the default alignment settings for the Simulation Data Inspector.

`MatchesSignalOptions(Name, Value)` creates an instance of the `Simulink.sdi.constraints.MatchesSignalOptions` class with comparison behavior using properties on page 5-465 specified by one or more `Name, Value` pair arguments.

Properties

IgnoreDataTypes — Constraint behavior when data types do not match

`false` (default) | `true`

Constraint sensitivity to the actual value having a different data type from the expected value.

You can specify the `IgnoreDataTypes` property in the constructor using the `'IgnoringDataTypes'` name-value pair argument.

Attributes:

| | |
|-----------|--------|
| GetAccess | public |
| SetAccess | public |

IgnoreSignalsNotAligned – Constraint behavior when signals do not align

false (default) | true

Constraint sensitivity to one or more signals not aligning between the expected value and actual value.

You can specify the `IgnoreSignalsNotAligned` property in the constructor using the 'IgnoringSignalsNotAligned' name-value pair argument.

Attributes:

| | |
|-----------|--------|
| GetAccess | public |
| SetAccess | public |

IgnoreExtraData – Constraint behavior when the actual value covers a different time interval from the expected value

false (default) | true

Constraint sensitivity to the actual value containing data outside of the time interval defined by the expected value.

You can specify the `IgnoreExtraData` property in the constructor using the 'IgnoringExtraData' name-value pair argument.

Attributes:

| | |
|-----------|--------|
| GetAccess | public |
| SetAccess | public |

Alignment – Signal alignment criteria

string array

Alignment criteria for the comparison. When the expected value contains more than one signal, the Simulation Data Inspector comparison algorithm aligns signals for comparison between the expected and actual values. By default, the Simulation Data Inspector aligns by data source, then by block path, then by SID, and then by signal name. For details about the Simulation Data Inspector alignment algorithm, see “How the Simulation Data Inspector Compares Data”.

Specify alignment criteria as a string array with one or more of these options listed in the order in which you want them considered:

You can specify the `Alignment` property in the constructor using the 'AligningBy' name-value pair argument.

Examples

Configure MatchesSignal Constraint Behavior

This example shows how to configure the comparison behavior of a `Simulink.sdi.constraints.MatchesSignal` constraint using a `Simulink.sdi.constraints.MatchesSignalOptions` object. You can use a `MatchesSignalOptions` object to configure multiple comparison properties with a single name-value pair input in the construction of the `MatchesSignal` instance.

Create Time Series Data

This example creates workspace data to use for illustrative purposes only. You can use the `MatchesSignal` constraint to compare data from other sources, such as simulation outputs or a file containing test data, and the constraint can compare time series data in any format supported by the Simulation Data Inspector.

In this example, the first signal is a `timeseries` object with the name `Wave Data` that contains data for a sine wave.

```
time = 0:0.1:20;
sig1vals = sin(2*pi/5*time);
sig1_ts = timeseries(sig1vals,time);
sig1_ts.Name = 'Wave Data';
```

The second signal is also a sine wave at the same frequency, with a slight attenuation and sampled at a different rate. Because the comparison algorithm for the `MatchesSignal` constraint includes a synchronization step, comparing these two signals with different time vectors does not necessarily result in a test failure. The second signal is cast to `single` data type and also named `Wave Data` so the alignment algorithm can pair the signals for comparison.

```
time2 = 0:0.1:22;
sig2vals = single(0.98*sin(2*pi/5*time2));
sig2_ts = timeseries(sig2vals,time2);
sig2_ts.Name = 'Wave Data';
```

Configure a MatchesSignal Instance and Compare the Data

You can use a `MatchesSignalOptions` object to specify how an instance of the `MatchesSignal` constraint handles conditions such as mismatched data types and how signals are aligned between the actual and expected data sets. You can specify the properties of the `MatchesSignalOptions` object to suit the test you want to write. For example, if you want your test to compare data of varying types and a data type match is not functionally relevant, you could set the `IgnoreDataTypes` property to `true`.

Create a `MatchesSignalOptions` object to create a `MatchesSignal` instance that ignores data type mismatches and data samples outside the time interval the actual and expected signals share.

```
import Simulink.sdi.constraints.MatchesSignalOptions
opts = MatchesSignalOptions('IgnoringDataTypes',true,'IgnoringExtraData',true);
```

Create a `TestCase` instance for interactive use and compare `sig1_ts` and `sig2_ts` using the `MatchesSignal` constraint, the `MatchesSignalOptions` object, and an absolute tolerance of `0.02`.

```
import matlab.unittest.TestCase
testCase = TestCase.forInteractiveUse;

import Simulink.sdi.constraints.MatchesSignal
testCase.verifyThat(sig2_ts,MatchesSignal(sig1_ts,'AbsTol',0.02,'WithOptions',opts))
```

Verification passed.

The test passes. When you run the same test again without the options defined by the `MatchesSignalOptions` object, the test fails due to the mismatched data types.

```
testCase.verifyThat(sig2_ts,MatchesSignal(sig1_ts,'AbsTol',0.02))
```

Verification failed.

```
-----  
Framework Diagnostic:  
-----
```

```
MatchesSignal(<Value>,'AbsTol',0.02) failed.
```

```
--> Data types do not match for the following aligned signals:
```

| Name | ActualSignals | ActualDataType | ExpectedSignals | ExpectedData |
|-------------|-----------------|----------------|-------------------|--------------|
| "Wave Data" | "<Actual>.Data" | {'single'} | "<Expected>.Data" | {'double'} |

```
-----  
Stack Information:  
-----
```

```
In C:\Users\snadeau\AppData\Local\Temp\Editor_oxzoe\LiveEditorEvaluationHelperE1184446395.m
```

```
In E:\jobarchive\Bdoc20b\2020_06_06_h12m11s21_job1400967_pass\matlab\toolbox\matlab\codetool
```

```
In E:\jobarchive\Bdoc20b\2020_06_06_h12m11s21_job1400967_pass\matlab\toolbox\matlab\codetool
```

See Also

`Simulink.sdi.constraints.MatchesSignal` | `matlab.unittest.TestCase` |
`matlab.unittest.constraints.Constraint` | `matlab.unittest.constraints` Package |
`verifyThat`

Topics

“How the Simulation Data Inspector Compares Data”

“Author Class-Based Unit Tests in MATLAB”

“Write Script-Based Unit Tests”

“Write Simple Test Case Using Classes”

“Write Simple Test Case Using Functions”

Introduced in R2019a

Simulink.sdi.CustomSnapshot class

Package: Simulink.sdi

Specify settings for a snapshot without opening or affecting the Simulation Data Inspector

Description

Use a `Simulink.sdi.CustomSnapshot` object to specify settings for a snapshot you want to create without opening the Simulation Data Inspector or affecting the open session. Creating a snapshot using a `Simulink.sdi.CustomSnapshot` object is the best option for fully scripted workflows. You can specify the snapshot dimensions in pixels, the subplot layout, and limits for the x- and y- axes. You can use the `clearSignals` and `plotOnSubplot` methods to plot signals you want to include in the snapshot. To capture the snapshot, you can pass the `Simulink.sdi.CustomSnapshot` object as the value for the `settings` name-value pair for the `Simulink.sdi.snapshot` function or use the `snapshot` method.

Construction

`snap = Simulink.sdi.CustomSnapshot` creates a `Simulink.sdi.CustomSnapshot` object.

Properties

Width — Image width

600 (default) | scalar

Image width, in pixels.

Example: 750

Height — Image height

400 (default) | scalar

Image height, in pixels.

Example: 500

Rows — Number of subplot rows

1 (default) | scalar

Number of subplot rows, specified as a scalar between 1 and 8, inclusive. Use `Rows` and `Columns` to set your desired subplot layout.

Example: 2

Columns — Number of subplot columns

1 (default) | scalar

Number of subplot columns, specified as a scalar between 1 and 8, inclusive. Use `Rows` and `Columns` to set your desired subplot layout.

Example: 3

TimeSpan — X-axis limits

2x1 matrix

Limits for the time axis in the snapshot. The time axis limits are the same for all subplots. By default, the time axis adjusts to accommodate the largest time range of the plotted signals.

Example: [0 20]

YRange — Y-axis limits

cell array

Cell array of 1-by-2 matrices specifying the y-axis limits for all subplots in the custom snapshot. By default, YRange is [-3 3] for all subplots.

Example: {[-10 10],[0 100]}

Methods

`clearSignals` Clear signals plotted on subplots of a `Simulink.sdi.CustomSnapshot` object
`plotOnSubPlot` Plot signals on `Simulink.sdi.CustomSnapshot` object subplots
`snapshot` Create a custom snapshot

Copy Semantics

Handle. To learn how handle classes affect copy operations, see Copying Objects.

Examples**Copy View Settings to a Run**

This example shows how to copy view settings from one run to another and how to create figures using the `Simulink.sdi.CustomSnapshot` object.

Simulate Your Model and Get a Run Object

Configure the `vdp` model to save output data, and run a simulation to create data.

```
load_system('vdp')
set_param('vdp','SaveFormat','Dataset','SaveOutput','on')
set_param('vdp/Mu','Gain','1');
sim('vdp');
```

Use the Simulation Data Inspector programmatic interface to access the run data.

```
runIndex = Simulink.sdi.getRunCount;
runID = Simulink.sdi.getRunIDByIndex(runIndex);
vdpRun = Simulink.sdi.getRun(runID);
```

Modify Signal View Settings

Use the `Simulink.sdi.Run` object to access signals in the run. Then, modify the signal view settings. This example specifies the line color and style for each signal. The view settings for the run comprise the view settings for each signal and view settings specified for the plot area.

```
sig1 = vdpRun.getSignalByIndex(1);
sig2 = vdpRun.getSignalByIndex(2);

sig1.LineColor = [0 0 1];
sig1.LineDashed = '-.';

sig2.LineColor = [1 0 0];
sig2.LineDashed = ':';
```

Capture a Snapshot from the Simulation Data Inspector

Create a `Simulink.sdi.CustomSnapshot` object and use the `Simulink.sdi.snapshot` function to programmatically capture a snapshot of the contents of the Simulation Data Inspector.

```
snap = Simulink.sdi.CustomSnapshot;
```

You can use properties of the `Simulink.sdi.CustomSnapshot` object to configure the plot settings, like the subplot layout and axis limits, and to plot signals. When you use a `Simulink.sdi.CustomSnapshot` object to create your figure, these plot settings do not affect the Simulation Data Inspector.

```
snap.Rows = 2;
snap.YRange = {[-2.25 2.25], [-3 3]};
snap.plotOnSubPlot(1,1,sig1,true)
snap.plotOnSubPlot(2,1,sig2,true)
```

Use `Simulink.sdi.snapshot` to generate the figure you specified in the properties of the `Simulink.sdi.CustomSnapshot` object.

```
fig = Simulink.sdi.snapshot("from", "custom", "to", "figure", "settings", snap);
```

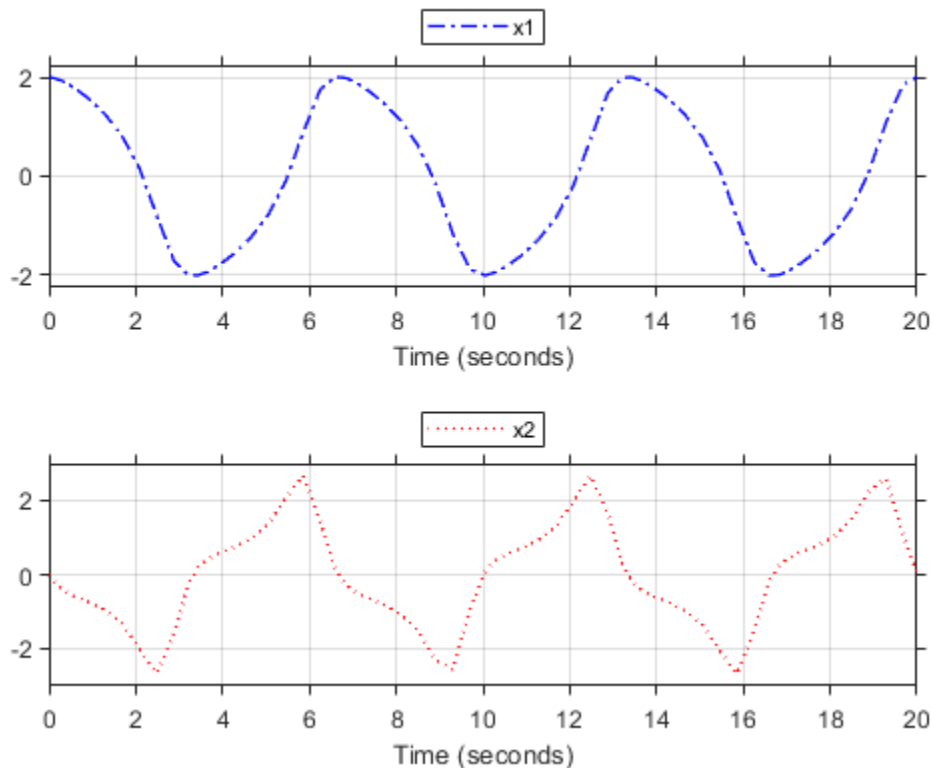

Copy the View Settings to a New Simulation Run

Simulate the model again, with a different Mu value. Use the Simulation Data Inspector programmatic interface to access the simulation data.

```
set_param('vdp/Mu', 'Gain', '5')
sim('vdp');
```

```
runIndex2 = Simulink.sdi.getRunCount;
runID2 = Simulink.sdi.getRunIDByIndex(runIndex2);
run2 = Simulink.sdi.getRun(runID2);
```

To create a plot of the new output data that looks like the one you created in the previous step, you can copy the view settings to the run in a single line of code using `Simulink.sdi.copyRunViewSettings`. The `Simulink.sdi.copyRunViewSettings` function does not automatically update plot settings in `Simulink.sdi.CustomSnapshot` objects, so specify the plot input as `false`.

```
sigIDs = Simulink.sdi.copyRunViewSettings(runID, runID2, false);
```

Capture a Snapshot of the New Simulation Run

Use the `Simulink.sdi.CustomSnapshot` object to capture a snapshot of the new simulation run. First, clear the signals from the subplots. Then, plot the signals from the new run and capture another snapshot.

```
snap.clearSignals
snap.YRange = {[-2.25 2.25], [-8 8]};
```

```
snap.plotOnSubPlot(1,1,sigIDs(1),true)
snap.plotOnSubPlot(2,1,sigIDs(2),true)

fig = snap.snapshot("to","figure");
```

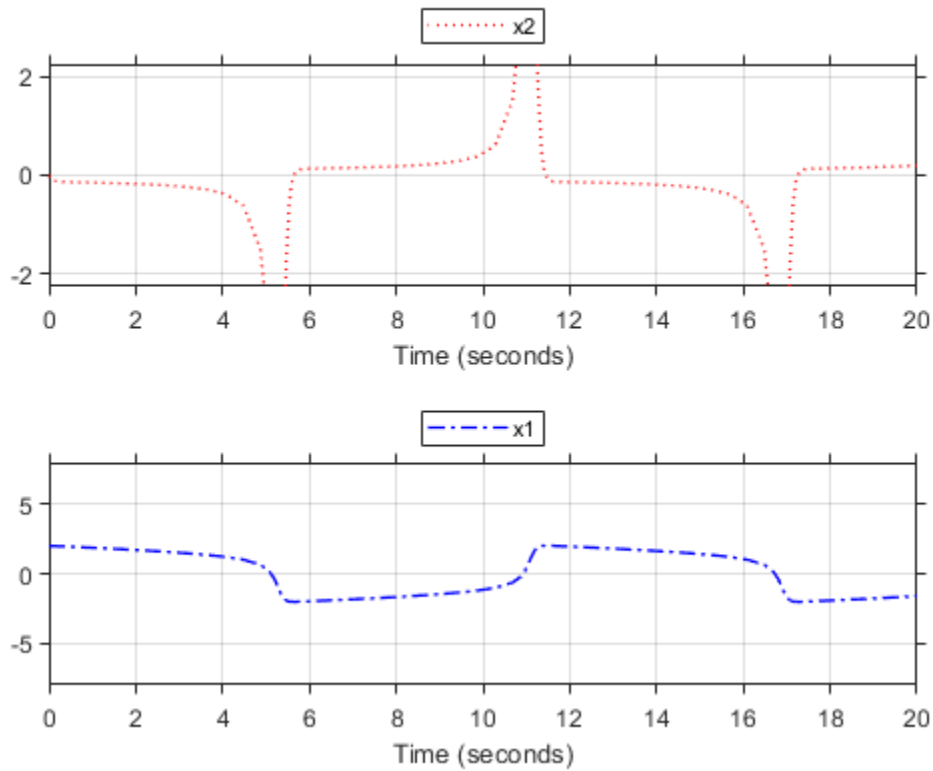

See Also

[Simulink.sdi.snapshot](#) | [Simulink.sdi.Signal](#)

Topics

“Inspect and Compare Data Programmatically”

“Create Plots Using the Simulation Data Inspector”

Introduced in R2018a

clearSignals

Class: Simulink.sdi.CustomSnapshot

Package: Simulink.sdi

Clear signals plotted on subplots of a Simulink.sdi.CustomSnapshot object

Syntax

```
snap.clearSignals
```

Description

`snap.clearSignals` clears plotted signals from all subplots in the Simulink.sdi.CustomSnapshot object, `snap`. Using the `clearSignals` method does not affect any subplots or signals in your open Simulation Data Inspector session.

Examples

Copy View Settings to a Run

This example shows how to copy view settings from one run to another and how to create figures using the Simulink.sdi.CustomSnapshot object.

Simulate Your Model and Get a Run Object

Configure the vdp model to save output data, and run a simulation to create data.

```
load_system('vdp')
set_param('vdp', 'SaveFormat', 'Dataset', 'SaveOutput', 'on')
set_param('vdp/Mu', 'Gain', '1');
sim('vdp');
```

Use the Simulation Data Inspector programmatic interface to access the run data.

```
runIndex = Simulink.sdi.getRunCount;
runID = Simulink.sdi.getRunIDByIndex(runIndex);
vdpRun = Simulink.sdi.getRun(runID);
```

Modify Signal View Settings

Use the Simulink.sdi.Run object to access signals in the run. Then, modify the signal view settings. This example specifies the line color and style for each signal. The view settings for the run comprise the view settings for each signal and view settings specified for the plot area.

```
sig1 = vdpRun.getSignalByIndex(1);
sig2 = vdpRun.getSignalByIndex(2);

sig1.LineColor = [0 0 1];
sig1.LineDashed = '-.';

sig2.LineColor = [1 0 0];
sig2.LineDashed = ':';
```

Capture a Snapshot from the Simulation Data Inspector

Create a `Simulink.sdi.CustomSnapshot` object and use the `Simulink.sdi.snapshot` function to programmatically capture a snapshot of the contents of the Simulation Data Inspector.

```
snap = Simulink.sdi.CustomSnapshot;
```

You can use properties of the `Simulink.sdi.CustomSnapshot` object to configure the plot settings, like the subplot layout and axis limits, and to plot signals. When you use a `Simulink.sdi.CustomSnapshot` object to create your figure, these plot settings do not affect the Simulation Data Inspector.

```
snap.Rows = 2;
snap.YRange = {[-2.25 2.25],[-3 3]};
snap.plotOnSubPlot(1,1,sig1,true)
snap.plotOnSubPlot(2,1,sig2,true)
```

Use `Simulink.sdi.snapshot` to generate the figure you specified in the properties of the `Simulink.sdi.CustomSnapshot` object.

```
fig = Simulink.sdi.snapshot("from","custom","to","figure","settings",snap);
```

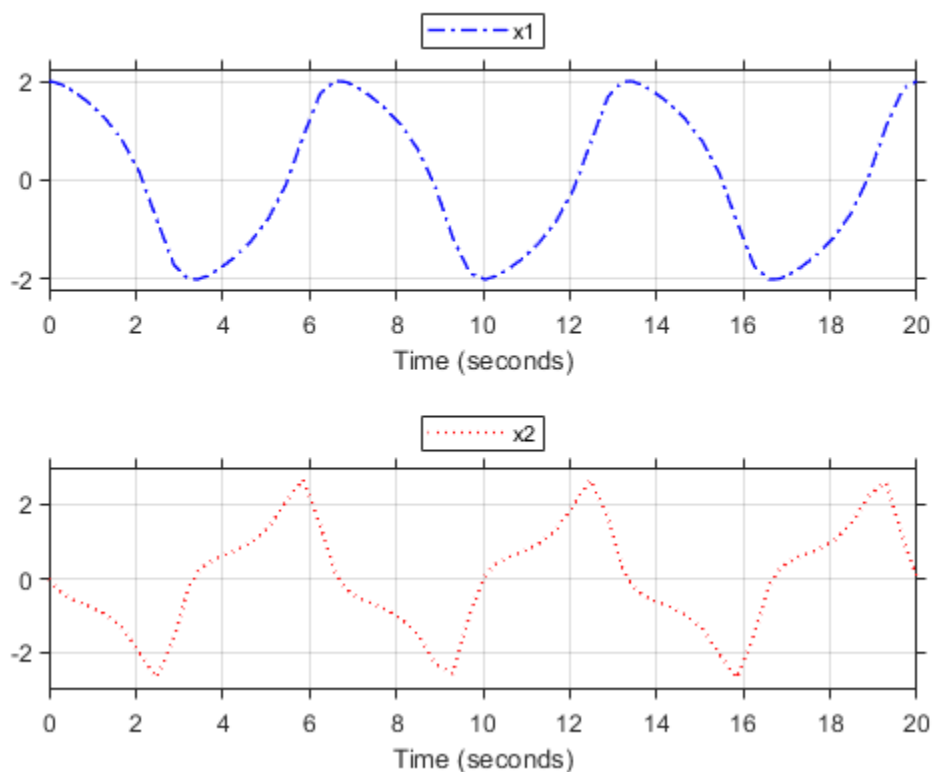

Copy the View Settings to a New Simulation Run

Simulate the model again, with a different `Mu` value. Use the Simulation Data Inspector programmatic interface to access the simulation data.

```
set_param('vdp/Mu', 'Gain', '5')
sim('vdp');
```

```
runIndex2 = Simulink.sdi.getRunCount;
runID2 = Simulink.sdi.getRunIDByIndex(runIndex2);
run2 = Simulink.sdi.getRun(runID2);
```

To create a plot of the new output data that looks like the one you created in the previous step, you can copy the view settings to the run in a single line of code using `Simulink.sdi.copyRunViewSettings`. The `Simulink.sdi.copyRunViewSettings` function does not automatically update plot settings in `Simulink.sdi.CustomSnapshot` objects, so specify the `plot` input as `false`.

```
sigIDs = Simulink.sdi.copyRunViewSettings(runID, runID2, false);
```

Capture a Snapshot of the New Simulation Run

Use the `Simulink.sdi.CustomSnapshot` object to capture a snapshot of the new simulation run. First, clear the signals from the subplots. Then, plot the signals from the new run and capture another snapshot.

```
snap.clearSignals
snap.YRange = {[-2.25 2.25], [-8 8]};
snap.plotOnSubPlot(1, 1, sigIDs(1), true)
snap.plotOnSubPlot(2, 1, sigIDs(2), true)
```

```
fig = snap.snapshot("to", "figure");
```

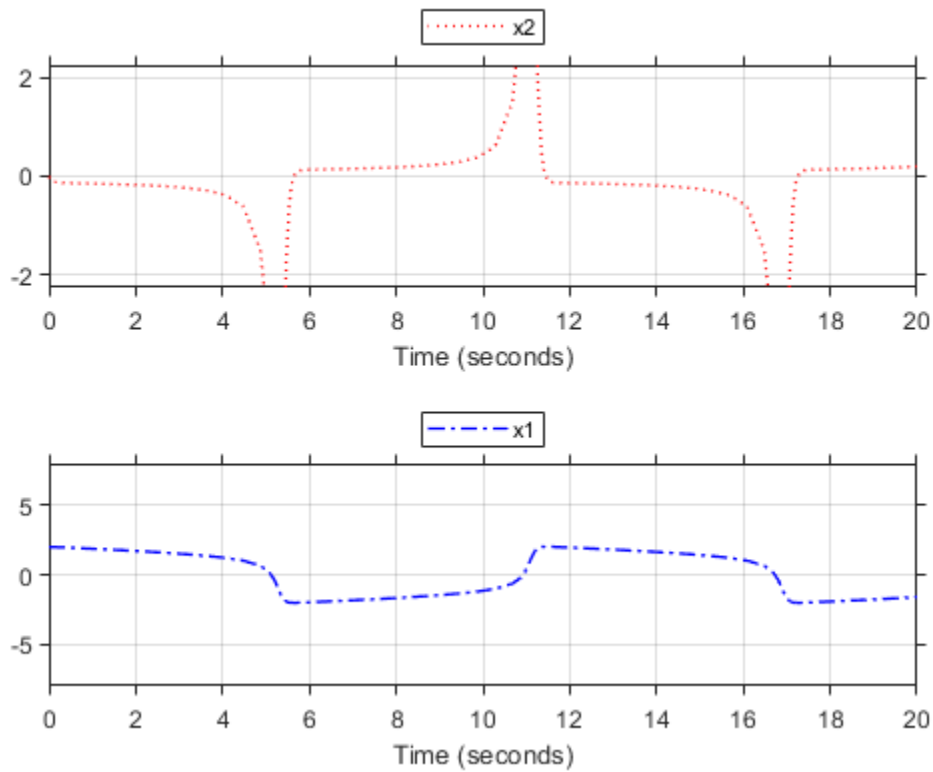
See Also

[Simulink.sdi.CustomSnapshot](#) | [plotOnSubPlot](#) | [snapshot](#) | [Simulink.sdi.snapshot](#) | [Simulink.sdi.clear](#) | [Simulink.sdi.clearPreferences](#)

Topics

“Inspect and Compare Data Programmatically”

“Create Plots Using the Simulation Data Inspector”

Introduced in R2018a

plotOnSubPlot

Class: Simulink.sdi.CustomSnapshot

Package: Simulink.sdi

Plot signals on Simulink.sdi.CustomSnapshot object subplots

Syntax

```
snap.plotOnSubPlot(row, column, signal, plot)
```

Description

`snap.plotOnSubPlot(row, column, signal, plot)` plots the signal on the subplot in the Simulink.sdi.CustomSnapshot object, `snap`, specified by `row` and `column` when `plot` is true. When `plot` is false, `plotOnSubPlot` clears the signal from the subplot.

Input Arguments

row — Subplot row

scalar

Row for subplot on which you want to plot a signal. Specify `row` as a value from 1 through 8, inclusive.

Example: 2

column — Subplot column

scalar

Column for subplot on which you want to plot a signal. Specify `column` as a value from 1 through 8, inclusive.

Example: 3

signal — Signal to plot

Simulink.sdi.Signal | signal ID

Signal ID or Simulink.sdi.Signal object corresponding to the signal you want to plot.

Example: sigID

plot — Plot indicator

logical

Logical indicator of whether to plot or clear the signal from the subplot.

- `true` - Plot the signal.
- `false` - Clear the signal.

Example: true

Data Types: logical

Examples

Copy View Settings to a Run

This example shows how to copy view settings from one run to another and how to create figures using the `Simulink.sdi.CustomSnapshot` object.

Simulate Your Model and Get a Run Object

Configure the vdp model to save output data, and run a simulation to create data.

```
load_system('vdp')
set_param('vdp','SaveFormat','Dataset','SaveOutput','on')
set_param('vdp/Mu','Gain','1');
sim('vdp');
```

Use the Simulation Data Inspector programmatic interface to access the run data.

```
runIndex = Simulink.sdi.getRunCount;
runID = Simulink.sdi.getRunIDByIndex(runIndex);
vdpRun = Simulink.sdi.getRun(runID);
```

Modify Signal View Settings

Use the `Simulink.sdi.Run` object to access signals in the run. Then, modify the signal view settings. This example specifies the line color and style for each signal. The view settings for the run comprise the view settings for each signal and view settings specified for the plot area.

```
sig1 = vdpRun.getSignalByIndex(1);
sig2 = vdpRun.getSignalByIndex(2);

sig1.LineColor = [0 0 1];
sig1.LineDashed = '-.';

sig2.LineColor = [1 0 0];
sig2.LineDashed = ':';
```

Capture a Snapshot from the Simulation Data Inspector

Create a `Simulink.sdi.CustomSnapshot` object and use the `Simulink.sdi.snapshot` function to programmatically capture a snapshot of the contents of the Simulation Data Inspector.

```
snap = Simulink.sdi.CustomSnapshot;
```

You can use properties of the `Simulink.sdi.CustomSnapshot` object to configure the plot settings, like the subplot layout and axis limits, and to plot signals. When you use a `Simulink.sdi.CustomSnapshot` object to create your figure, these plot settings do not affect the Simulation Data Inspector.

```
snap.Rows = 2;
snap.YRange = {[ -2.25 2.25], [ -3 3]};
snap.plotOnSubPlot(1,1,sig1,true)
snap.plotOnSubPlot(2,1,sig2,true)
```

Use `Simulink.sdi.snapshot` to generate the figure you specified in the properties of the `Simulink.sdi.CustomSnapshot` object.

```
fig = Simulink.sdi.snapshot("from","custom","to","figure","settings",snap);
```

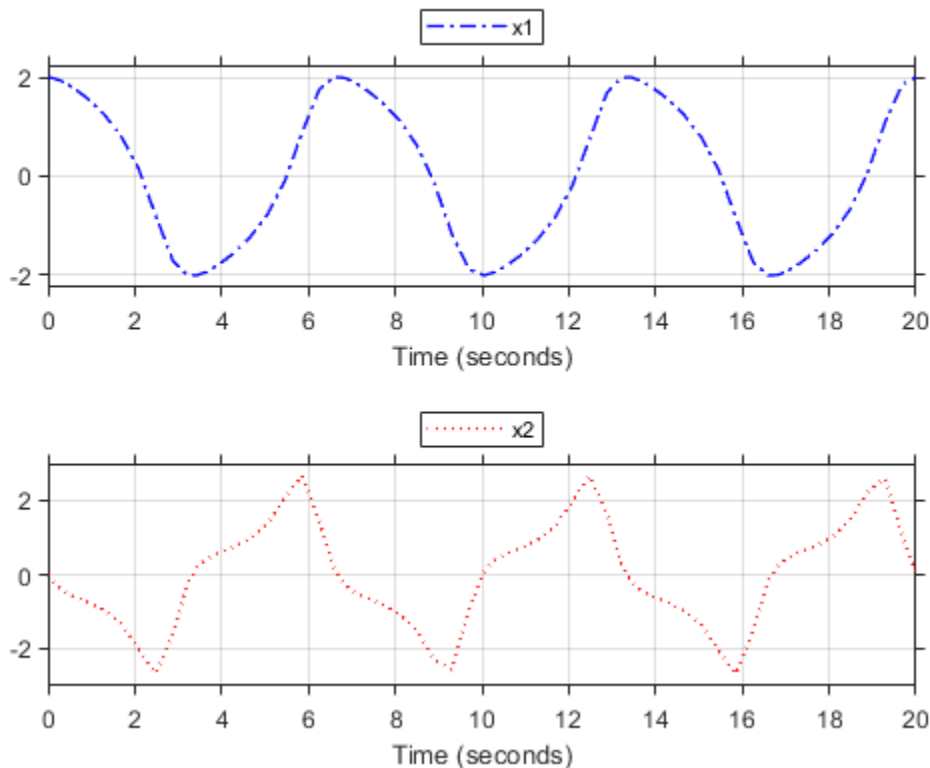

Copy the View Settings to a New Simulation Run

Simulate the model again, with a different Mu value. Use the Simulation Data Inspector programmatic interface to access the simulation data.

```
set_param('vdp/Mu','Gain','5')
sim('vdp');
```

```
runIndex2 = Simulink.sdi.getRunCount;
runID2 = Simulink.sdi.getRunIDByIndex(runIndex2);
run2 = Simulink.sdi.getRun(runID2);
```

To create a plot of the new output data that looks like the one you created in the previous step, you can copy the view settings to the run in a single line of code using `Simulink.sdi.copyRunViewSettings`. The `Simulink.sdi.copyRunViewSettings` function does not automatically update plot settings in `Simulink.sdi.CustomSnapshot` objects, so specify the plot input as `false`.

```
sigIDs = Simulink.sdi.copyRunViewSettings(runID,runID2,false);
```

Capture a Snapshot of the New Simulation Run

Use the `Simulink.sdi.CustomSnapshot` object to capture a snapshot of the new simulation run. First, clear the signals from the subplots. Then, plot the signals from the new run and capture another snapshot.

```
snap.clearSignals
snap.YRange = {[-2.25 2.25],[-8 8]};
```

```
snap.plotOnSubPlot(1,1,sigIDs(1),true)
snap.plotOnSubPlot(2,1,sigIDs(2),true)

fig = snap.snapshot("to","figure");
```

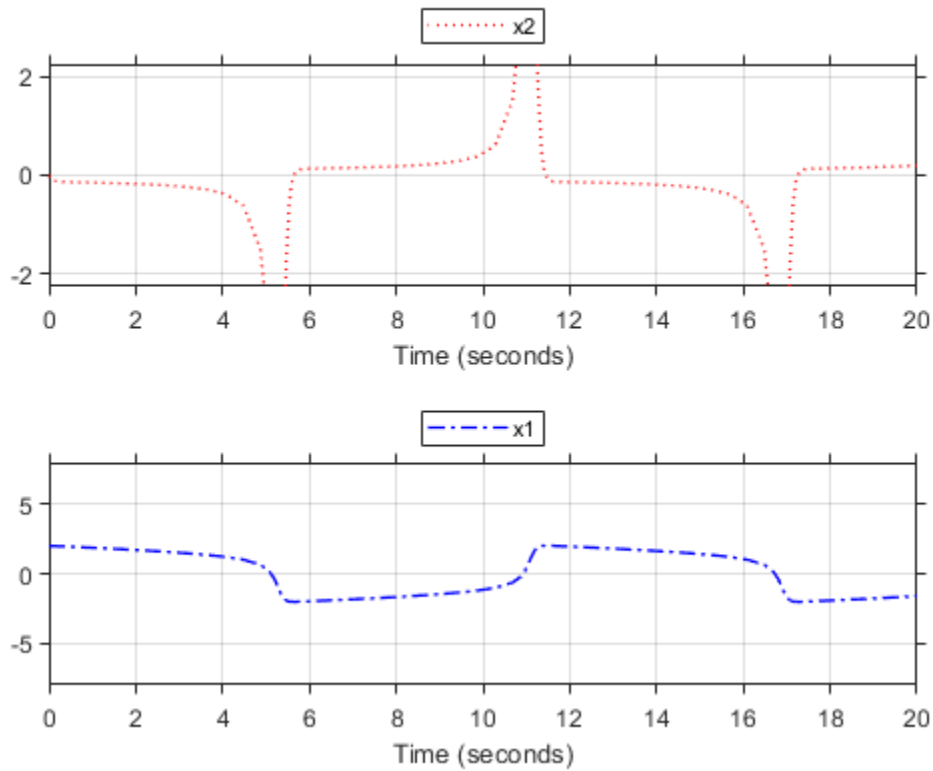

See Also

[Simulink.sdi.CustomSnapshot](#) | [Simulink.sdi.Signal](#) | [clearSignals](#) | [Simulink.sdi.snapshot](#) | [snapshot](#)

Topics

“Inspect and Compare Data Programmatically”

“Create Plots Using the Simulation Data Inspector”

Introduced in R2018a

snapshot

Class: Simulink.sdi.CustomSnapshot

Package: Simulink.sdi

Create a custom snapshot

Syntax

```
fig = snap.snapshot
[fig,image] = snap.snapshot
fig = snap.snapshot(Name,Value)
[fig,image] = snap.snapshot
```

Description

`fig = snap.snapshot` creates a figure according to the properties of the `Simulink.sdi.CustomSnapshot` object, `snap`, and returns the handle for the figure, `fig`.

`[fig,image] = snap.snapshot` creates a figure according to the properties of the `Simulink.sdi.CustomSnapshot` object, `snap`, and returns the handle for the figure, `fig`, and an array of image data, `image`.

`fig = snap.snapshot(Name,Value)` creates a figure according to the properties of the `Simulink.sdi.CustomSnapshot` object, `snap`, with additional options specified by one or more `Name,Value` pair arguments. This syntax returns the figure handle, `fig`.

`[fig,image] = snap.snapshot` creates a figure according to the properties of the `Simulink.sdi.CustomSnapshot` object, `snap`, with additional options specified by one or more `Name,Value` pair arguments. This syntax returns the figure handle, `fig`, and an array of image data, `image`.

Input Arguments

Name-Value Pair Arguments

Specify optional comma-separated pairs of `Name,Value` arguments. `Name` is the argument name and `Value` is the corresponding value. `Name` must appear inside quotes. You can specify several name and value pair arguments in any order as `Name1,Value1,...,NameN,ValueN`.

Example: `'to','figure','props',{'Name','My Data'}`

to — Type of snapshot to create

`'image'` (default) | `'figure'` | `'file'` | `'clipboard'`

Type of snapshot to create.

- `'image'` — Create a figure and return the figure handle and an array of image data. When you specify `'to','image'`, the `fig` and `image` outputs both have value.
- `'figure'` — Create a figure and return the figure handle. When you specify `'to','figure'` the `fig` output has value, and the `image` output is empty.

- `'file'` — Save to a PNG file with the name specified by the `filename` name-value pair. If you do not specify a `filename` name-value pair, the file is named `plots.png`. When you specify `'to', 'file'`, the `fig` and `image` outputs are both empty.
- `'clipboard'` — Copy the plots to your system clipboard. From the clipboard, you can paste the image into another program such as Microsoft Word. When you specify `'to', 'clipboard'`, the `fig` and `image` outputs are both empty.

Example: `'to', 'file'`

Data Types: `char` | `string`

filename — Name for image file

`'plots.png'` (default) | character array | string

Name of the image file to store the snapshot when you specify `'to', 'file'`.

Example: `'filename', 'MyImage.png'`

Data Types: `char` | `string`

props — Properties to customize the figure

cell array

Figure properties, specified as a cell array. You can include settings for the figure properties described in Figure Properties.

Example: `'props', {'Name', 'MyData', 'NumberTitle', 'off'}`

Data Types: `char` | `string`

Output Arguments

fig — Figure handle

figure handle

Handle for the figure. When a figure is not created with your specified options, the `fig` output is empty.

image — Image data

array

Array of image data. The `image` output has value when you use `Simulink.sdi.snapshot` without any input arguments or without a `to` name-value pair and when you specify `'to', 'image'`.

Examples

Copy View Settings to a Run

This example shows how to copy view settings from one run to another and how to create figures using the `Simulink.sdi.CustomSnapshot` object.

Simulate Your Model and Get a Run Object

Configure the `vdp` model to save output data, and run a simulation to create data.

```
load_system('vdp')
set_param('vdp', 'SaveFormat', 'Dataset', 'SaveOutput', 'on')
```

```
set_param('vdp/Mu', 'Gain', '1');  
sim('vdp');
```

Use the Simulation Data Inspector programmatic interface to access the run data.

```
runIndex = Simulink.sdi.getRunCount;  
runID = Simulink.sdi.getRunIDByIndex(runIndex);  
vdpRun = Simulink.sdi.getRun(runID);
```

Modify Signal View Settings

Use the `Simulink.sdi.Run` object to access signals in the run. Then, modify the signal view settings. This example specifies the line color and style for each signal. The view settings for the run comprise the view settings for each signal and view settings specified for the plot area.

```
sig1 = vdpRun.getSignalByIndex(1);  
sig2 = vdpRun.getSignalByIndex(2);  
  
sig1.LineColor = [0 0 1];  
sig1.LineDashed = '-.';  
  
sig2.LineColor = [1 0 0];  
sig2.LineDashed = ':';
```

Capture a Snapshot from the Simulation Data Inspector

Create a `Simulink.sdi.CustomSnapshot` object and use the `Simulink.sdi.snapshot` function to programmatically capture a snapshot of the contents of the Simulation Data Inspector.

```
snap = Simulink.sdi.CustomSnapshot;
```

You can use properties of the `Simulink.sdi.CustomSnapshot` object to configure the plot settings, like the subplot layout and axis limits, and to plot signals. When you use a `Simulink.sdi.CustomSnapshot` object to create your figure, these plot settings do not affect the Simulation Data Inspector.

```
snap.Rows = 2;  
snap.YRange = {[ -2.25 2.25], [ -3 3]};  
snap.plotOnSubPlot(1,1,sig1,true)  
snap.plotOnSubPlot(2,1,sig2,true)
```

Use `Simulink.sdi.snapshot` to generate the figure you specified in the properties of the `Simulink.sdi.CustomSnapshot` object.

```
fig = Simulink.sdi.snapshot("from", "custom", "to", "figure", "settings", snap);
```

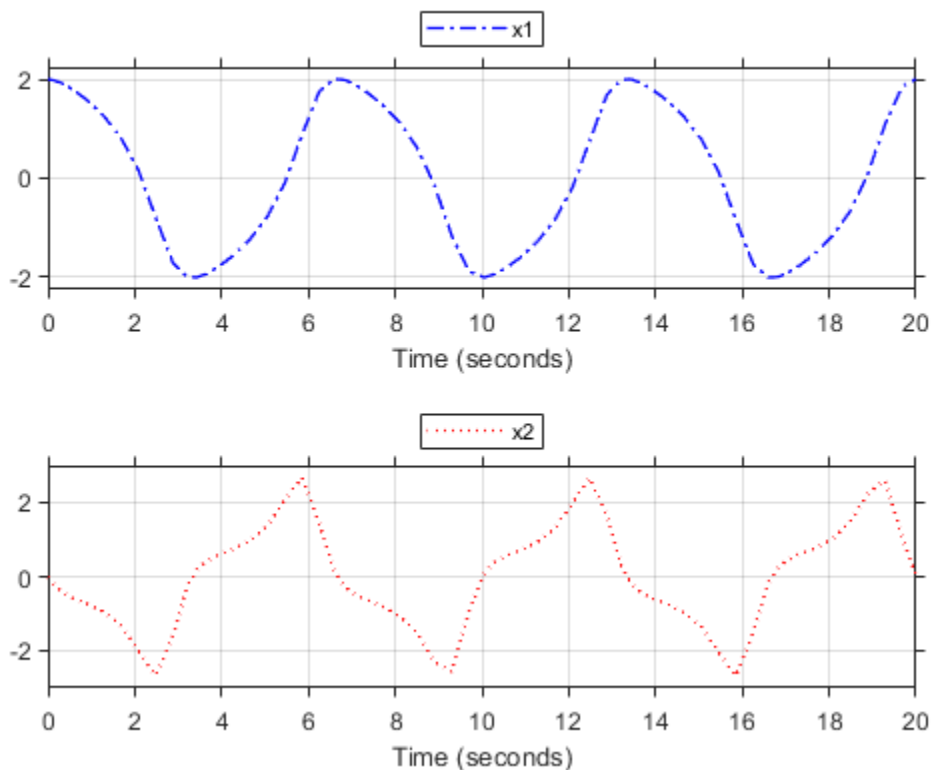
Copy the View Settings to a New Simulation Run

Simulate the model again, with a different Mu value. Use the Simulation Data Inspector programmatic interface to access the simulation data.

```
set_param('vdp/Mu','Gain','5')
sim('vdp');
```

```
runIndex2 = Simulink.sdi.getRunCount;
runID2 = Simulink.sdi.getRunIDByIndex(runIndex2);
run2 = Simulink.sdi.getRun(runID2);
```

To create a plot of the new output data that looks like the one you created in the previous step, you can copy the view settings to the run in a single line of code using `Simulink.sdi.copyRunViewSettings`. The `Simulink.sdi.copyRunViewSettings` function does not automatically update plot settings in `Simulink.sdi.CustomSnapshot` objects, so specify the plot input as `false`.

```
sigIDs = Simulink.sdi.copyRunViewSettings(runID,runID2,false);
```

Capture a Snapshot of the New Simulation Run

Use the `Simulink.sdi.CustomSnapshot` object to capture a snapshot of the new simulation run. First, clear the signals from the subplots. Then, plot the signals from the new run and capture another snapshot.

```
snap.clearSignals
snap.YRange = {[-2.25 2.25],[-8 8]};
```

```
snap.plotOnSubPlot(1,1,sigIDs(1),true)
snap.plotOnSubPlot(2,1,sigIDs(2),true)

fig = snap.snapshot("to","figure");
```

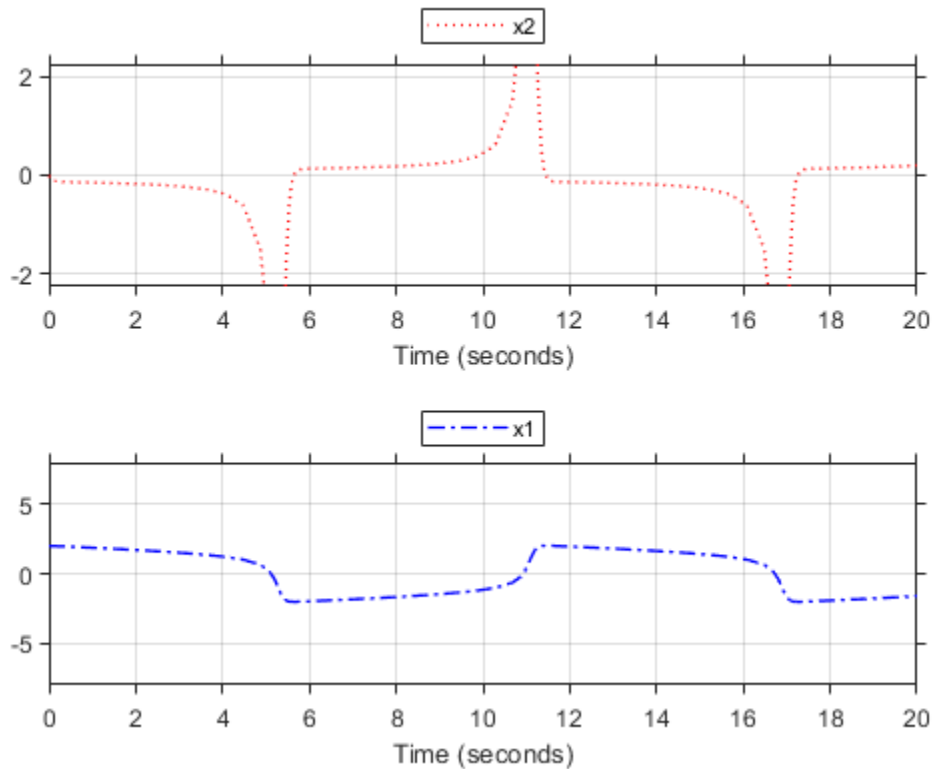

See Also

[Simulink.sdi.CustomSnapshot](#) | [plotOnSubPlot](#) | [clearSignals](#) | [Simulink.sdi.snapshot](#) | [Figure Properties](#)

Topics

“Inspect and Compare Data Programmatically”

“Create Plots Using the Simulation Data Inspector”

Introduced in R2018a

Simulink.sdi.DatasetRef class

Package: Simulink.sdi

Access data in Simulation Data Inspector repository

Description

The `Simulink.sdi.DatasetRef` object provides access to data in the Simulation Data Inspector without loading the entire set of data into memory. The object is compatible with the `Simulink.SimulationData.DatasetRef` class.

Construction

`dsr_array = Simulink.sdi.DatasetRef` constructs an array that contains a `Simulink.sdi.DatasetRef` object that corresponds to each run in the Simulation Data Inspector.

`dsr_array = Simulink.sdi.DatasetRef(domain)` creates an array of `DatasetRef` objects that contains a `Simulink.sdi.DatasetRef` object for each run, with the contents of each run limited to the specified domain.

`dsr = Simulink.sdi.DatasetRef(runID)` creates a `Simulink.sdi.DatasetRef` object that references the run specified by the run identifier, `runID`.

`dsr = Simulink.sdi.DatasetRef(runID, domain)` creates a `Simulink.sdi.DatasetRef` object that references the run specified by `runID` with contents specified by `domain`.

`dsr = Simulink.sdi.DatasetRef(runID, domain, repositoryPath)` creates a `Simulink.sdi.DatasetRef` object that references the run specified by the run identifier, `runID`. The `DatasetRef` object contains the contents specified by `domain` from the repository specified by `repositoryPath`.

Input Arguments

domain — Data to reference in DatasetRef object

'signals' | 'outports' | 'dsm' | 'state' | 'param' | ...

Data to reference in `DatasetRef` object, specified as one of the following:

- 'signals' — Signals produced by signal logging.
- 'outports' — Model output signals, represented by top-level Output blocks.
- 'dsm' — Data Store Memory blocks.
- 'state' — Simulink states.
- 'param' — Parameter data for block parameters and variables tuned using dashboard blocks.
- 'sf_data' — Stateflow local data.
- 'sf_state' — Stateflow states.
- 'sf_state_child' — Stateflow child activity.
- 'sf_state_leaf' — Stateflow leaf activity.

- 'slt_verify' — Assertion blocks and verify assessments in Simulink Test.

runID — Run identifier

integer

Specifies the run containing the data for the `Simulink.sdi.DatasetRef` object.

repositoryPath — Path containing the run

string | character vector

Specifies the location of the run containing the data for the `Simulink.sdi.DatasetRef` object.

Properties

Name — Run name

character vector

The name of the run that corresponds with the `Simulink.sdi.DatasetRef` object.

Example: 'Run 1'

Run — Simulink.sdi.Run object`Simulink.sdi.Run` object

`Simulink.sdi.Run` object associated with the `Simulink.sdi.DatasetRef` object.

numElements — Number of top-level elements in run`Simulink.sdi.Run` object

Number of top-level elements in the `Simulink.sdi.Run` object associated with the `Simulink.sdi.DatasetRef` object.

Methods

| | |
|------------------------------|---|
| <code>compare</code> | Compare runs with <code>DatasetRef</code> objects |
| <code>getAsDatastore</code> | Retrieve element as <code>sdidatastore</code> object |
| <code>getElement</code> | Retrieve <code>DatasetRef</code> element by index |
| <code>getElementNames</code> | Get character vectors of element names |
| <code>getSignal</code> | Return <code>Signal</code> object |
| <code>plot</code> | Open the Simulation Data Inspector to view and compare data |

Copy Semantics

Handle. To learn how handle classes affect copy operations, see [Copying Objects](#).

Examples

Compare Runs with the `Simulink.sdi.DatasetRef` Object

This example shows how to work with the `Simulink.sdi.DatasetRef` object by comparing two runs of the `ex_sl_demo_absbrake` system with different desired slip ratios.

```
% Simulate model ex_sldemo_absbrake to create a run of logged signals
load_system('ex_sldemo_absbrake')
sim('ex_sldemo_absbrake')

% Get the runID
runIDs = Simulink.sdi.getAllRunIDs;
runID = runIDs(end);

% Get the run object
brakeRun = Simulink.sdi.getRun(runID);

% Make a Simulink.sdi.DatasetRef object
run_DSRef = brakeRun.getDatasetRef;

% Get the names of the elements in the object
names = run_DSRef.getElementNames

names = 2x1 cell
    {'yout'}
    {'slp' }

% Get yout bus
[yout, name, index] = run_DSRef.getElement(1);

% View signals in outputs
outputs = yout.Values

outputs = struct with fields:
    Ww: [1x1 timeseries]
    Vs: [1x1 timeseries]
    Sd: [1x1 timeseries]

% Get slp signal
slp = run_DSRef.getSignal('slp');

% Plot signal
slp.Checked = 'true';

% Create another run for a different Desired relative slip
set_param('ex_sldemo_absbrake/Desired relative slip', 'Value', '0.25')
sim('ex_sldemo_absbrake')
DSR_Runs = Simulink.sdi.DatasetRef;

% Compare the results from the two runs
[matches, mismatches, diffResult] = run_DSRef.compare(DSR_Runs(2));

% Open the Simulation Data Inspector to view signals
run_DSRef.plot
```

See Also

Simulink.SimulationData.DatasetRef | Simulink.sdi.Run | Simulink.sdi.WorkerRun | getDatasetRef

Topics

“Inspect and Compare Data Programmatically”

Introduced in R2017b

compare

Class: Simulink.sdi.DatasetRef

Package: Simulink.sdi

Compare runs with DatasetRef objects

Syntax

```
[matches, mismatches, results] = dsrObj.compare(other)
```

Description

`[matches, mismatches, results] = dsrObj.compare(other)` returns the number of matches, number of mismatches, and comparison results for a comparison of data in a `Simulink.sdi.DatasetRef` object. The comparison results are returned as a `Simulink.sdi.DiffRunResult` object.

Input Arguments

other — Comparison data

MAT-file | variable

Comparison data, which can come from another `Simulink.sdi.DatasetRef` object, a Dataset in the workspace, or a MAT-file.

Example: 'data.mat'

Example: var

Output Arguments

matches — Number of matching signals

integer

Number of signals that matched within tolerance in the comparison.

mismatches — Number of mismatched signals

integer

Number of signals that did not match within tolerance in the comparison.

results — Simulink.sdi.DiffRunResult object with comparison results

`Simulink.sdi.DiffRunResult` object

Results of the comparison, returned in a `Simulink.sdi.DiffRunResult` object.

Examples

Compare Runs with the Simulink.sdi.DatasetRef Object

This example shows how to work with the `Simulink.sdi.DatasetRef` object by comparing two runs of the `ex_sl-demo_absbrake` system with different desired slip ratios.

```
% Simulate model ex_sl-demo_absbrake to create a run of logged signals
load_system('ex_sl-demo_absbrake')
sim('ex_sl-demo_absbrake')

% Get the runID
runIDs = Simulink.sdi.getAllRunIDs;
runID = runIDs(end);

% Get the run object
brakeRun = Simulink.sdi.getRun(runID);

% Make a Simulink.sdi.DatasetRef object
run_DSRef = brakeRun.getDatasetRef;

% Get the names of the elements in the object
names = run_DSRef.getElementNames

names = 2x1 cell
    {'yout'}
    {'slp' }

% Get yout bus
[yout, name, index] = run_DSRef.getElement(1);

% View signals in outputs
outputs = yout.Values

outputs = struct with fields:
    Ww: [1x1 timeseries]
    Vs: [1x1 timeseries]
    Sd: [1x1 timeseries]

% Get slp signal
slp = run_DSRef.getSignal('slp');

% Plot signal
slp.Checked = 'true';

% Create another run for a different Desired relative slip
set_param('ex_sl-demo_absbrake/Desired relative slip', 'Value', '0.25')
sim('ex_sl-demo_absbrake')
DSR_Runs = Simulink.sdi.DatasetRef;

% Compare the results from the two runs
[matches, mismatches, diffResult] = run_DSRef.compare(DSR_Runs(2));

% Open the Simulation Data Inspector to view signals
run_DSRef.plot
```

Alternatives

Using the Simulation Data Inspector API, you could create runs for the data you want to compare and use `Simulink.sdi.compareRuns` for the comparison. You can also view runs created from simulation, import data to runs, and compare runs with the Simulation Data Inspector UI.

See Also

`Simulink.sdi.DatasetRef` | `Simulink.sdi.Run` | `Simulink.sdi.DiffRunResult` | `Simulink.sdi.compareRuns` | `Simulink.sdi.compareSignals` | `Simulink.sdi.view`

Topics

“Inspect and Compare Data Programmatically”

“How the Simulation Data Inspector Compares Data”

Introduced in R2017b

getAsDatastore

Class: Simulink.sdi.DatasetRef

Package: Simulink.sdi

Retrieve element as sdatastore object

Syntax

```
[elementDatastore, name, index] = SDIDatasetRef.getAsDatastore(arg)
```

Description

[elementDatastore, name, index] = SDIDatasetRef.getAsDatastore(arg) returns the requested element as a `matlab.io.datastore.sdatastoreobject`, along with the element name and index.

Input Arguments

arg — Element selection criterion

integer | character vector

Search criterion used to retrieve the element from the `Simulink.sdi.DatasetRef` object. For name-based searches, specify `arg` as a character vector. For index-based searches, `arg` is an integer, representing the index of the desired element.

Example: 'MySignal'

Example: 3

Output Arguments

elementDatastore — Element as sdatastore

sdatastore object

Element as `matlab.io.datastore.sdatastore` object.

name — Element name

character vector

The name of the element.

index — Element index in DatasetRef object

integer

The index of the element in the `Simulink.sdi.DatasetRef` object.

Examples

Create an `sdidatastore` Object for a Signal

This example shows how to create a `sdidatastore` object for a signal in a `Simulink.sdi.DatasetRef` object.

```
% Simulate model sldemo_fuelsys to create a run of logged signals
sim('sldemo_fuelsys')

% Get the runID
runIDs = Simulink.sdi.getAllRunIDs;
runID = runIDs(end);

% Get the run object
fuelRun = Simulink.sdi.getRun(runID);

% Make a Simulink.sdi.DatasetRef object
run_DSRef = fuelRun.getDatasetRef;

% Get the names of the elements in the object
names = run_DSRef.getElementNames

names = 16x1 cell
    {'CheckRange'           }
    {'air_fuel_ratio'      }
    {'speed'               }
    {'map'                  }
    {'ego'                  }
    {'throttle'            }
    {'fuel'                 }
    {'EGO Fault Switch:1'  }
    {'Engine Speed Fault Switch:1' }
    {'MAP Fault Switch:1'  }
    {'Throttle Angle Fault Switch:1'}
    {'ego_sw'               }
    {'engine_speed'        }
    {'speed_sw'             }
    {'map_sw'               }
    {'throttle_sw'         }

% Get sdidatastore object for fuel signal
fuel_ds = run_DSRef.getAsDatastore(10);
```

Alternatives

You can construct a `sdidatastore` object for a specified signal using `matlab.io.datastore.sdidatastore`.

See Also

[Simulink.sdi.DatasetRef | getElement | matlab.io.datastore.sdidatastore | matlab.io.datastore.SimulationDatastore](#)

Topics

“Inspect and Compare Data Programmatically”

Introduced in R2017b

getElement

Class: Simulink.sdi.DatasetRef

Package: Simulink.sdi

Retrieve DatasetRef element by index

Syntax

```
[element, name, index] = SDIdatasetRef.getElement(index)
```

Description

`[element, name, index] = SDIdatasetRef.getElement(index)` returns the element within the Run in the Simulink.sdi.DatasetRef object at the specified index.

Input Arguments

index — Index of element

integer

Location of the element in the Simulink.sdi.DatasetRef object.

Output Arguments

element — Run element in the DatasetRef object

signal

Element from the run in the Simulink.sdi.DatasetRef object.

name — Element name

character vector

Name of the element retrieved from the Simulink.sdi.DatasetRef object.

index — Location of element

integer

Location of the element within the Simulink.sdi.DatasetRef object.

Examples

Compare Runs with the Simulink.sdi.DatasetRef Object

This example shows how to work with the Simulink.sdi.DatasetRef object by comparing two runs of the `ex_sl-demo-absbrake` system with different desired slip ratios.

```
% Simulate model ex_sl-demo-absbrake to create a run of logged signals
load_system('ex_sl-demo-absbrake')
sim('ex_sl-demo-absbrake')
```

```
% Get the runID
runIDs = Simulink.sdi.getAllRunIDs;
runID = runIDs(end);

% Get the run object
brakeRun = Simulink.sdi.getRun(runID);

% Make a Simulink.sdi.DatasetRef object
run_DSRef = brakeRun.getDatasetRef;

% Get the names of the elements in the object
names = run_DSRef.getElementNames

names = 2x1 cell
    {'yout'}
    {'slp' }

% Get yout bus
[yout, name, index] = run_DSRef.getElement(1);

% View signals in outputs
outputs = yout.Values

outputs = struct with fields:
    Ww: [1x1 timeseries]
    Vs: [1x1 timeseries]
    Sd: [1x1 timeseries]

% Get slp signal
slp = run_DSRef.getSignal('slp');

% Plot signal
slp.Checked = 'true';

% Create another run for a different Desired relative slip
set_param('ex_sldemo_absbrake/Desired relative slip', 'Value', '0.25')
sim('ex_sldemo_absbrake')
DSR_Runs = Simulink.sdi.DatasetRef;

% Compare the results from the two runs
[matches, mismatches, diffResult] = run_DSRef.compare(DSR_Runs(2));

% Open the Simulation Data Inspector to view signals
run_DSRef.plot
```

See Also

[Simulink.sdi.DatasetRef](#) | [getSignal](#) | [getElementNames](#)

Topics

“Inspect and Compare Data Programmatically”

Introduced in R2017b

getElementNames

Class: Simulink.sdi.DatasetRef

Package: Simulink.sdi

Get character vectors of element names

Syntax

```
names = dsrObj.getElementNames
```

Description

`names = dsrObj.getElementNames` returns a cell array of character vectors containing the names of the elements in `dsrObj`.

Output Arguments

names — Element names

cell array

Names of the top level elements in the `Simulink.sdi.DatasetRef` object in a cell array.

Examples

Compare Runs with the Simulink.sdi.DatasetRef Object

This example shows how to work with the `Simulink.sdi.DatasetRef` object by comparing two runs of the `ex_sl_demo_absbrake` system with different desired slip ratios.

```
% Simulate model ex_sl_demo_absbrake to create a run of logged signals
load_system('ex_sl_demo_absbrake')
sim('ex_sl_demo_absbrake')

% Get the runID
runIDs = Simulink.sdi.getAllRunIDs;
runID = runIDs(end);

% Get the run object
brakeRun = Simulink.sdi.getRun(runID);

% Make a Simulink.sdi.DatasetRef object
run_DSRef = brakeRun.getDatasetRef;

% Get the names of the elements in the object
names = run_DSRef.getElementNames

names = 2x1 cell
    {'yout'}
    {'slp' }
```

```
% Get yout bus
[yout, name, index] = run_DSRef.getElement(1);

% View signals in outputs
outputs = yout.Values

outputs = struct with fields:
    Ww: [1x1 timeseries]
    Vs: [1x1 timeseries]
    Sd: [1x1 timeseries]

% Get slp signal
slp = run_DSRef.getSignal('slp');

% Plot signal
slp.Checked = 'true';

% Create another run for a different Desired relative slip
set_param('ex_sldemo_absbrake/Desired relative slip', 'Value', '0.25')
sim('ex_sldemo_absbrake')
DSR_Runs = Simulink.sdi.DatasetRef;

% Compare the results from the two runs
[matches, mismatches, diffResult] = run_DSRef.compare(DSR_Runs(2));

% Open the Simulation Data Inspector to view signals
run_DSRef.plot
```

See Also

[Simulink.sdi.DatasetRef | getElement | getSignal |](#)
[Simulink.SimulationData.DatasetRef](#)

Topics

“Inspect and Compare Data Programmatically”

Introduced in R2017b

getSignal

Class: Simulink.sdi.DatasetRef

Package: Simulink.sdi

Return Signal object

Syntax

```
sigObj = SDIDatasetRef.getSignal(searchArg)
```

Description

`sigObj = SDIDatasetRef.getSignal(searchArg)` returns the `Simulink.sdi.Signal` object corresponding to the search argument, `searchArg`.

Input Arguments

searchArg — Search parameter

character vector | integer

The search parameters to select the `Simulink.sdi.Signal` object. The `searchArg` can be a character vector or string targeting a signal name or an integer for an index-based search.

Example: 'throttle'

Example: 2

Output Arguments

sigObj — Simulink.sdi.Signal object

Simulink.sdi.Signal object

The `Simulink.sdi.Signal` object corresponding to the search query.

Examples

Compare Runs with the Simulink.sdi.DatasetRef Object

This example shows how to work with the `Simulink.sdi.DatasetRef` object by comparing two runs of the `ex_sl_demo_absbrake` system with different desired slip ratios.

```
% Simulate model ex_sl_demo_absbrake to create a run of logged signals
load_system('ex_sl_demo_absbrake')
sim('ex_sl_demo_absbrake')

% Get the runID
runIDs = Simulink.sdi.getAllRunIDs;
runID = runIDs(end);

% Get the run object
```

```
brakeRun = Simulink.sdi.getRun(runID);

% Make a Simulink.sdi.DatasetRef object
run_DSRef = brakeRun.getDatasetRef;

% Get the names of the elements in the object
names = run_DSRef.getElementNames

names = 2x1 cell
    {'yout'}
    {'slp' }

% Get yout bus
[yout, name, index] = run_DSRef.getElement(1);

% View signals in outputs
outputs = yout.Values

outputs = struct with fields:
    Ww: [1x1 timeseries]
    Vs: [1x1 timeseries]
    Sd: [1x1 timeseries]

% Get slp signal
slp = run_DSRef.getSignal('slp');

% Plot signal
slp.Checked = 'true';

% Create another run for a different Desired relative slip
set_param('ex_slldemo_absbrake/Desired relative slip', 'Value', '0.25')
sim('ex_slldemo_absbrake')
DSR_Runs = Simulink.sdi.DatasetRef;

% Compare the results from the two runs
[matches, mismatches, diffResult] = run_DSRef.compare(DSR_Runs(2));

% Open the Simulation Data Inspector to view signals
run_DSRef.plot
```

Alternatives

If the signal is a top-level element in the `Simulink.sdi.DatasetRef` object, you can use the `getElement` method to get the `Simulink.sdi.Signal` object by index.

See Also

`Simulink.sdi.DatasetRef` | `getElement` | `Simulink.sdi.getSignal`

Topics

“Inspect and Compare Data Programmatically”

Introduced in R2017b

plot

Class: Simulink.sdi.DatasetRef

Package: Simulink.sdi

Open the Simulation Data Inspector to view and compare data

Syntax

```
SDIDatasetRef.plot
```

Description

`SDIDatasetRef.plot` opens the Simulation Data Inspector, where you can view and compare runs and signals.

Examples

Compare Runs with the Simulink.sdi.DatasetRef Object

This example shows how to work with the `Simulink.sdi.DatasetRef` object by comparing two runs of the `ex_sl-demo-absbrake` system with different desired slip ratios.

```
% Simulate model ex_sl-demo-absbrake to create a run of logged signals
load_system('ex_sl-demo-absbrake')
sim('ex_sl-demo-absbrake')

% Get the runID
runIDs = Simulink.sdi.getAllRunIDs;
runID = runIDs(end);

% Get the run object
brakeRun = Simulink.sdi.getRun(runID);

% Make a Simulink.sdi.DatasetRef object
run_DSRef = brakeRun.getDatasetRef;

% Get the names of the elements in the object
names = run_DSRef.getElementNames

names = 2x1 cell
    {'yout'}
    {'slp' }

% Get yout bus
[yout, name, index] = run_DSRef.getElement(1);

% View signals in outputs
outputs = yout.Values

outputs = struct with fields:
    Ww: [1x1 timeseries]
```

```
Vs: [1x1 timeseries]
Sd: [1x1 timeseries]

% Get slp signal
slp = run_DSRef.getSignal('slp');

% Plot signal
slp.Checked = 'true';

% Create another run for a different Desired relative slip
set_param('ex_slldemo_absbrake/Desired relative slip', 'Value', '0.25')
sim('ex_slldemo_absbrake')
DSR_Runs = Simulink.sdi.DatasetRef;

% Compare the results from the two runs
[matches, mismatches, diffResult] = run_DSRef.compare(DSR_Runs(2));

% Open the Simulation Data Inspector to view signals
run_DSRef.plot
```

Alternatives

You can use the `Simulink.sdi.view` function to open the Simulation Data Inspector. For information on using the UI to open the Simulation Data Inspector, see “View Data in the Simulation Data Inspector”.

See Also

`Simulink.sdi.DatasetRef` | `Simulink.sdi.view` | `Simulink.sdi.setSubPlotLayout` | `plotOnSubPlot`

Topics

“Inspect and Compare Data Programmatically”

Introduced in R2017b

Simulink.sdi.WorkerRun class

Package: Simulink.sdi

Access simulation data from parallel workers

Description

The `Simulink.sdi.WorkerRun` class provides access to run data generated on Parallel Computing Toolbox parallel workers. Create a `Simulink.sdi.WorkerRun` object on the worker, and then use the object to access data in your local MATLAB session.

Construction

`workerRun = Simulink.sdi.WorkerRun(runID)` creates a `Simulink.sdi.WorkerRun` object with the run identifier specified by `runID`.

`workerRun = Simulink.sdi.WorkerRun.getLatest` creates a `Simulink.sdi.WorkerRun` object of the most recent run.

Input Arguments

runID — Run identifier

integer

Run identifier

Methods

| | |
|----------------------------|-----------------------------------|
| <code>getDataset</code> | Create Dataset of worker run data |
| <code>getDatasetRef</code> | Create DatasetRef for worker run |
| <code>getLatest</code> | Create worker run for latest run |
| <code>getLocalRun</code> | Create local run from worker run |

Copy Semantics

Handle. To learn how handle classes affect copy operations, see [Copying Objects](#).

Examples

Access Data from a Parallel Simulation

This example executes parallel simulations of the model `slexAircraftExample` with different input filter time constants and shows several ways to access the data using the Simulation Data Inspector programmatic interface.

Setup

Start by ensuring the Simulation Data Inspector is empty and Parallel Computing Toolbox support is configured to import runs created on local workers automatically. Then, create a vector of filter parameter values to use in each simulation.

```
% Make sure the Simulation Data Inspector is empty, and PCT support is
% enabled.
Simulink.sdi.clear
Simulink.sdi.enablePCTSupport('local')
```

```
% Define Ts values
Ts_vals = [0.01, 0.02, 0.05, 0.1, 0.2, 0.5, 1];
```

Initialize Parallel Workers

Use `gcp` to create a pool of local workers to run parallel simulations if you don't already have one. In an `spmd` code block, load the `slexAircraftExample` model and select signals to log. To avoid data concurrency issues using `sim` in `parfor`, create a temporary directory for each worker to use during simulations.

```
p = gcp;
```

```
Starting parallel pool (parpool) using the 'local' profile ...
connected to 4 workers.
```

```
spmd
```

```
% Load system and select signals to log
load_system('slexAircraftExample')
Simulink.sdi.markSignalForStreaming('slexAircraftExample/Pilot', 1, 'on')
Simulink.sdi.markSignalForStreaming('slexAircraftExample/Aircraft Dynamics Model', 4, 'on')

% Create temporary directory on each worker
workDir = pwd;
addpath(workDir)
tempDir = tempname;
mkdir(tempDir)
cd(tempDir)
```

```
end
```

Run Parallel Simulations

Use `parfor` to run the seven simulations in parallel. Select the value for `Ts` for each simulation, and modify the value of `Ts` in the model workspace. Then, run the simulation and build an array of `Simulink.sdi.WorkerRun` objects to access the data with the Simulation Data Inspector. After the `parfor` loop, use another `spmd` segment to remove the temporary directories from the workers.

```
parfor index = 1:7
```

```
% Select value for Ts
Ts_val = Ts_vals(index);

% Change the filter time constant and simulate
modelWorkspace = get_param('slexAircraftExample', 'modelworkspace');
modelWorkspace.assignin('Ts', Ts_val)
sim('slexAircraftExample')
```

```

    % Create a worker run for each simulation
    workerRun(index) = Simulink.sdi.WorkerRun.getLatest

end

spmd

    % Remove temporary directories
    cd(workDir)
    rmdir(tempDir, 's')
    rmpath(workDir)

```

```
end
```

Get Dataset Objects from Parallel Simulation Output

The `getDataset` method puts the data from a `WorkerRun` into a `Dataset` object so you can easily post-process.

```
ds(7) = Simulink.SimulationData.Dataset;
```

```
for a = 1:7
    ds(a) = workerRun(a).getDataset;
```

```
end
```

```
ds(1)
```

```
ans =
Simulink.SimulationData.Dataset '' with 2 elements
```

| | | Name | BlockPath |
|---|--------------|------------|--|
| 1 | [1x1 Signal] | alpha, rad | ...rcraftExample/Aircraft Dynamics Model |
| 2 | [1x1 Signal] | Stick | slexAircraftExample/Pilot |

- Use braces { } to access, modify, or add elements using index.

Get DatasetRef Objects from Parallel Simulation Output

For big data workflows, use the `getDatasetRef` method to reference the data associated with the `WorkerRun`.

```
for b = 1:7
    datasetRef(b) = workerRun(b).getDatasetRef;
```

```
end
```

```
datasetRef(1)
```

```
ans =
DatasetRef with properties:

    Name: 'Run 3: slexAircraftExample'
    Run: [1x1 Simulink.sdi.Run]
 numElements: 2
```

Process Parallel Simulation Data in the Simulation Data Inspector

You can also create local Run objects to analyze and visualize your data using the Simulation Data Inspector API. This example adds a tag indicating the filter time constant value for each run.

```
for c = 1:7

    Runs(c) = workerRun(c).getLocalRun;
    Ts_val_str = num2str(Ts_vals(c));
    desc = strcat('Ts = ', Ts_val_str);
    Runs(c).Description = desc;
    Runs(c).Name = strcat('slexAircraftExample run Ts=', Ts_val_str);

end
```

Clean Up Worker Repositories

Clean up the files used by the workers to free up disk space for other simulations you want to run on your worker pool.

```
Simulink.sdi.cleanupWorkerResources
```

Alternatives

You can also access, view, and analyze simulation data from Parallel Computing Toolbox workers using the Simulation Data Inspector UI.

See Also

`Simulink.sdi.Run`

Topics

“Inspect and Compare Data Programmatically”

Introduced in R2017b

getDataset

Class: Simulink.sdi.WorkerRun

Package: Simulink.sdi

Create Dataset of worker run data

Syntax

```
dataset = workerRun.getDataset  
dataset = workerRun.getDataset(domain)
```

Description

`dataset = workerRun.getDataset` returns a `Simulink.SimulationData.Dataset` object of the data corresponding to the `Simulink.sdi.WorkerRun` object.

`dataset = workerRun.getDataset(domain)` returns a `Simulink.SimulationData.Dataset` object of the data corresponding to the `Simulink.sdi.WorkerRun` object limited to the scope specified by `domain`.

Input Arguments

domain — Scope specifier

'signals' | 'outports'

Scope limiting argument that selects the data to return in the `Simulink.SimulationData.Dataset` object.

- 'signals' limits the data returned in the Dataset to signals in the WorkerRun.
- 'outports' limits the data returned in the Dataset to output data in the WorkerRun.

Output Arguments

dataset — Simulink.SimulationData.Dataset object

`Simulink.SimulationData.Dataset` object

`Simulink.SimulationData.Dataset` object containing the data from the `Simulink.sdi.WorkerRun` object.

Examples

Access Data from a Parallel Simulation

This example executes parallel simulations of the model `slexAircraftExample` with different input filter time constants and shows several ways to access the data using the Simulation Data Inspector programmatic interface.

Setup

Start by ensuring the Simulation Data Inspector is empty and Parallel Computing Toolbox support is configured to import runs created on local workers automatically. Then, create a vector of filter parameter values to use in each simulation.

```
% Make sure the Simulation Data Inspector is empty, and PCT support is
% enabled.
Simulink.sdi.clear
Simulink.sdi.enablePCTSupport('local')
```

```
% Define Ts values
Ts_vals = [0.01, 0.02, 0.05, 0.1, 0.2, 0.5, 1];
```

Initialize Parallel Workers

Use `gcp` to create a pool of local workers to run parallel simulations if you don't already have one. In an `spmd` code block, load the `slexAircraftExample` model and select signals to log. To avoid data concurrency issues using `sim` in `parfor`, create a temporary directory for each worker to use during simulations.

```
p = gcp;
```

```
Starting parallel pool (parpool) using the 'local' profile ...
connected to 4 workers.
```

```
spmd
```

```
% Load system and select signals to log
load_system('slexAircraftExample')
Simulink.sdi.markSignalForStreaming('slexAircraftExample/Pilot', 1, 'on')
Simulink.sdi.markSignalForStreaming('slexAircraftExample/Aircraft Dynamics Model', 4, 'on')

% Create temporary directory on each worker
workDir = pwd;
addpath(workDir)
tempDir = tempname;
mkdir(tempDir)
cd(tempDir)
```

```
end
```

Run Parallel Simulations

Use `parfor` to run the seven simulations in parallel. Select the value for `Ts` for each simulation, and modify the value of `Ts` in the model workspace. Then, run the simulation and build an array of `Simulink.sdi.WorkerRun` objects to access the data with the Simulation Data Inspector. After the `parfor` loop, use another `spmd` segment to remove the temporary directories from the workers.

```
parfor index = 1:7
```

```
% Select value for Ts
Ts_val = Ts_vals(index);

% Change the filter time constant and simulate
modelWorkspace = get_param('slexAircraftExample', 'modelworkspace');
modelWorkspace.assignin('Ts', Ts_val)
sim('slexAircraftExample')
```

```

    % Create a worker run for each simulation
    workerRun(index) = Simulink.sdi.WorkerRun.getLatest

end

spmd

    % Remove temporary directories
    cd(workDir)
    rmdir(tempDir, 's')
    rmpath(workDir)

```

```
end
```

Get Dataset Objects from Parallel Simulation Output

The `getDataset` method puts the data from a `WorkerRun` into a `Dataset` object so you can easily post-process.

```
ds(7) = Simulink.SimulationData.Dataset;
```

```
for a = 1:7
    ds(a) = workerRun(a).getDataset;
end
```

```
ds(1)
```

```
ans =
Simulink.SimulationData.Dataset '' with 2 elements
```

| | | Name | BlockPath |
|---|--------------|------------|--|
| 1 | [1x1 Signal] | alpha, rad | ...rcraftExample/Aircraft Dynamics Model |
| 2 | [1x1 Signal] | Stick | slexAircraftExample/Pilot |

- Use braces { } to access, modify, or add elements using index.

Get DatasetRef Objects from Parallel Simulation Output

For big data workflows, use the `getDatasetRef` method to reference the data associated with the `WorkerRun`.

```
for b = 1:7
    datasetRef(b) = workerRun(b).getDatasetRef;
end
```

```
datasetRef(1)
```

```
ans =
DatasetRef with properties:

    Name: 'Run 3: slexAircraftExample'
     Run: [1x1 Simulink.sdi.Run]
numElements: 2
```

Process Parallel Simulation Data in the Simulation Data Inspector

You can also create local Run objects to analyze and visualize your data using the Simulation Data Inspector API. This example adds a tag indicating the filter time constant value for each run.

```
for c = 1:7

    Runs(c) = workerRun(c).getLocalRun;
    Ts_val_str = num2str(Ts_vals(c));
    desc = strcat('Ts = ', Ts_val_str);
    Runs(c).Description = desc;
    Runs(c).Name = strcat('slexAircraftExample run Ts=', Ts_val_str);

end
```

Clean Up Worker Repositories

Clean up the files used by the workers to free up disk space for other simulations you want to run on your worker pool.

```
Simulink.sdi.cleanupWorkerResources
```

See Also

[Simulink.SimulationData.Dataset | getDatasetRef |](#)
[Simulink.sdi.WorkerRun.getLatest | getLocalRun](#)

Topics

“Inspect and Compare Data Programmatically”

Introduced in R2017b

getDatasetRef

Class: Simulink.sdi.WorkerRun

Package: Simulink.sdi

Create DatasetRef for worker run

Syntax

```
datasetRef = workerRun.getDatasetRef  
datasetRef = workerRun.getDatasetRef(domain)
```

Description

`datasetRef = workerRun.getDatasetRef` returns a `Simulink.SimulationData.DatasetRef` object referencing the data in the `Simulink.sdi.WorkerRun` object, `workerRun`.

`datasetRef = workerRun.getDatasetRef(domain)` returns a `Simulink.SimulationData.DatasetRef` object referencing the data in the `Simulink.sdi.WorkerRun` object, `workerRun`, limited to the scope specified by `domain`.

Input Arguments

domain — Scope limiting input

'signals' | 'outports'

Scope limiting argument that selects the data to reference in the `Simulink.SimulationData.DatasetRef` object.

- 'signals' limits the data referenced in the `DatasetRef` to signals in the `WorkerRun`.
- 'outports' limits the data referenced in the `DatasetRef` to output data in the `WorkerRun`.

Output Arguments

datasetRef — `Simulink.SimulationData.DatasetRef` object

`Simulink.sdi.DatasetRef` object

`Simulink.sdi.DatasetRef` object referencing the data in the Parallel Computing Toolbox worker run.

Examples

Access Data from a Parallel Simulation

This example executes parallel simulations of the model `slexAircraftExample` with different input filter time constants and shows several ways to access the data using the Simulation Data Inspector programmatic interface.

Setup

Start by ensuring the Simulation Data Inspector is empty and Parallel Computing Toolbox support is configured to import runs created on local workers automatically. Then, create a vector of filter parameter values to use in each simulation.

```
% Make sure the Simulation Data Inspector is empty, and PCT support is
% enabled.
Simulink.sdi.clear
Simulink.sdi.enablePCTSupport('local')
```

```
% Define Ts values
Ts_vals = [0.01, 0.02, 0.05, 0.1, 0.2, 0.5, 1];
```

Initialize Parallel Workers

Use `gcp` to create a pool of local workers to run parallel simulations if you don't already have one. In an `spmd` code block, load the `slexAircraftExample` model and select signals to log. To avoid data concurrency issues using `sim` in `parfor`, create a temporary directory for each worker to use during simulations.

```
p = gcp;
```

```
Starting parallel pool (parpool) using the 'local' profile ...
connected to 4 workers.
```

```
spmd
```

```
% Load system and select signals to log
load_system('slexAircraftExample')
Simulink.sdi.markSignalForStreaming('slexAircraftExample/Pilot', 1, 'on')
Simulink.sdi.markSignalForStreaming('slexAircraftExample/Aircraft Dynamics Model', 4, 'on')

% Create temporary directory on each worker
workDir = pwd;
addpath(workDir)
tempDir = tempname;
mkdir(tempDir)
cd(tempDir)
```

```
end
```

Run Parallel Simulations

Use `parfor` to run the seven simulations in parallel. Select the value for `Ts` for each simulation, and modify the value of `Ts` in the model workspace. Then, run the simulation and build an array of `Simulink.sdi.WorkerRun` objects to access the data with the Simulation Data Inspector. After the `parfor` loop, use another `spmd` segment to remove the temporary directories from the workers.

```
parfor index = 1:7
```

```
% Select value for Ts
Ts_val = Ts_vals(index);

% Change the filter time constant and simulate
modelWorkspace = get_param('slexAircraftExample', 'modelworkspace');
modelWorkspace.assignin('Ts', Ts_val)
sim('slexAircraftExample')
```

```

    % Create a worker run for each simulation
    workerRun(index) = Simulink.sdi.WorkerRun.getLatest

end

spmd

    % Remove temporary directories
    cd(workDir)
    rmdir(tempDir, 's')
    rmpath(workDir)

```

```
end
```

Get Dataset Objects from Parallel Simulation Output

The `getDataset` method puts the data from a `WorkerRun` into a `Dataset` object so you can easily post-process.

```
ds(7) = Simulink.SimulationData.Dataset;
```

```
for a = 1:7
    ds(a) = workerRun(a).getDataset;
```

```
end
```

```
ds(1)
```

```
ans =
Simulink.SimulationData.Dataset '' with 2 elements
```

| | | Name | BlockPath |
|---|--------------|------------|--|
| 1 | [1x1 Signal] | alpha, rad | ...rcraftExample/Aircraft Dynamics Model |
| 2 | [1x1 Signal] | Stick | slexAircraftExample/Pilot |

- Use braces { } to access, modify, or add elements using index.

Get DatasetRef Objects from Parallel Simulation Output

For big data workflows, use the `getDatasetRef` method to reference the data associated with the `WorkerRun`.

```
for b = 1:7
    datasetRef(b) = workerRun(b).getDatasetRef;
```

```
end
```

```
datasetRef(1)
```

```
ans =
DatasetRef with properties:

    Name: 'Run 3: slexAircraftExample'
    Run: [1x1 Simulink.sdi.Run]
 numElements: 2
```

Process Parallel Simulation Data in the Simulation Data Inspector

You can also create local Run objects to analyze and visualize your data using the Simulation Data Inspector API. This example adds a tag indicating the filter time constant value for each run.

```
for c = 1:7

    Runs(c) = workerRun(c).getLocalRun;
    Ts_val_str = num2str(Ts_vals(c));
    desc = strcat('Ts = ', Ts_val_str);
    Runs(c).Description = desc;
    Runs(c).Name = strcat('slexAircraftExample run Ts=', Ts_val_str);

end
```

Clean Up Worker Repositories

Clean up the files used by the workers to free up disk space for other simulations you want to run on your worker pool.

```
Simulink.sdi.cleanupWorkerResources
```

See Also

[Simulink.SimulationData.DatasetRef | getDataset |](#)
[Simulink.sdi.WorkerRun.getLatest | getLocalRun](#)

Topics

“Inspect and Compare Data Programmatically”

Introduced in R2017b

Simulink.sdi.WorkerRun.getLatest

Class: Simulink.sdi.WorkerRun

Package: Simulink.sdi

Create worker run for latest run

Syntax

```
runObj = Simulink.sdi.WorkerRun.getLatest
```

Description

`runObj = Simulink.sdi.WorkerRun.getLatest` creates a `Simulink.sdi.WorkerRun` object for the latest run on a Parallel Computing Toolbox worker.

Output Arguments

runObj — Local Simulink.sdi.Run object

Simulink.sdi.WorkerRun object

Simulink.sdi.WorkerRun object to access the data from the latest Parallel Computing Toolbox worker run.

Examples

Access Data from a Parallel Simulation

This example executes parallel simulations of the model `slexAircraftExample` with different input filter time constants and shows several ways to access the data using the Simulation Data Inspector programmatic interface.

Setup

Start by ensuring the Simulation Data Inspector is empty and Parallel Computing Toolbox support is configured to import runs created on local workers automatically. Then, create a vector of filter parameter values to use in each simulation.

```
% Make sure the Simulation Data Inspector is empty, and PCT support is
% enabled.
Simulink.sdi.clear
Simulink.sdi.enablePCTSupport('local')
```

```
% Define Ts values
Ts_vals = [0.01, 0.02, 0.05, 0.1, 0.2, 0.5, 1];
```

Initialize Parallel Workers

Use `gcp` to create a pool of local workers to run parallel simulations if you don't already have one. In an `spmd` code block, load the `slexAircraftExample` model and select signals to log. To avoid data concurrency issues using `sim` in `parfor`, create a temporary directory for each worker to use during simulations.

```
p = gcp;
```

Starting parallel pool (parpool) using the 'local' profile ...
connected to 4 workers.

```
spmd
```

```
% Load system and select signals to log
load_system('slexAircraftExample')
Simulink.sdi.markSignalForStreaming('slexAircraftExample/Pilot', 1, 'on')
Simulink.sdi.markSignalForStreaming('slexAircraftExample/Aircraft Dynamics Model', 4, 'on')

% Create temporary directory on each worker
workDir = pwd;
addpath(workDir)
tempDir = tempname;
mkdir(tempDir)
cd(tempDir)
```

```
end
```

Run Parallel Simulations

Use `parfor` to run the seven simulations in parallel. Select the value for `Ts` for each simulation, and modify the value of `Ts` in the model workspace. Then, run the simulation and build an array of `Simulink.sdi.WorkerRun` objects to access the data with the Simulation Data Inspector. After the `parfor` loop, use another `spmd` segment to remove the temporary directories from the workers.

```
parfor index = 1:7
```

```
% Select value for Ts
Ts_val = Ts_vals(index);

% Change the filter time constant and simulate
modelWorkspace = get_param('slexAircraftExample','modelworkspace');
modelWorkspace.assignin('Ts',Ts_val)
sim('slexAircraftExample')

% Create a worker run for each simulation
workerRun(index) = Simulink.sdi.WorkerRun.getLatest
```

```
end
```

```
spmd
```

```
% Remove temporary directories
cd(workDir)
rmdir(tempDir, 's')
rmpath(workDir)
```

```
end
```

Get Dataset Objects from Parallel Simulation Output

The `getDataset` method puts the data from a `WorkerRun` into a `Dataset` object so you can easily post-process.

```
ds(7) = Simulink.SimulationData.Dataset;
```

```

for a = 1:7
    ds(a) = workerRun(a).getDataset;
end
ds(1)

ans =
Simulink.SimulationData.Dataset '' with 2 elements

           Name           BlockPath
-----
1 [1x1 Signal]   alpha, rad   ...rcraftExample/Aircraft Dynamics Model
2 [1x1 Signal]   Stick       slexAircraftExample/Pilot

- Use braces { } to access, modify, or add elements using index.

```

Get DatasetRef Objects from Parallel Simulation Output

For big data workflows, use the `getDatasetRef` method to reference the data associated with the `WorkerRun`.

```

for b = 1:7
    datasetRef(b) = workerRun(b).getDatasetRef;
end

datasetRef(1)

ans =
DatasetRef with properties:

    Name: 'Run 3: slexAircraftExample'
    Run: [1x1 Simulink.sdi.Run]
 numElements: 2

```

Process Parallel Simulation Data in the Simulation Data Inspector

You can also create local `Run` objects to analyze and visualize your data using the Simulation Data Inspector API. This example adds a tag indicating the filter time constant value for each run.

```

for c = 1:7

    Runs(c) = workerRun(c).getLocalRun;
    Ts_val_str = num2str(Ts_vals(c));
    desc = strcat('Ts = ', Ts_val_str);
    Runs(c).Description = desc;
    Runs(c).Name = strcat('slexAircraftExample run Ts=', Ts_val_str);

end

```

Clean Up Worker Repositories

Clean up the files used by the workers to free up disk space for other simulations you want to run on your worker pool.

Simulink.sdi.cleanupWorkerResources

See Also

Simulink.sdi.WorkerRun | getDataset | getDatasetRef | getLocalRun

Topics

“Inspect and Compare Data Programmatically”

Introduced in R2017b

getLocalRun

Class: Simulink.sdi.WorkerRun

Package: Simulink.sdi

Create local run from worker run

Syntax

```
runObj = workerRun.getLocalRun
```

Description

`runObj = workerRun.getLocalRun` creates the local `Simulink.sdi.Run` object `runObj` for the `Simulink.sdi.WorkerRun` object `workerRun`. Use `getLocalRun` in the client MATLAB to access the `Simulink.sdi.WorkerRun` data.

Output Arguments

runObj — Local `Simulink.sdi.Run` object

`Simulink.sdi.Run` object

Local `Simulink.sdi.Run` object.

Examples

Access Data from a Parallel Simulation

This example executes parallel simulations of the model `slexAircraftExample` with different input filter time constants and shows several ways to access the data using the Simulation Data Inspector programmatic interface.

Setup

Start by ensuring the Simulation Data Inspector is empty and Parallel Computing Toolbox support is configured to import runs created on local workers automatically. Then, create a vector of filter parameter values to use in each simulation.

```
% Make sure the Simulation Data Inspector is empty, and PCT support is
% enabled.
Simulink.sdi.clear
Simulink.sdi.enablePCTSupport('local')
```

```
% Define Ts values
Ts_vals = [0.01, 0.02, 0.05, 0.1, 0.2, 0.5, 1];
```

Initialize Parallel Workers

Use `gcp` to create a pool of local workers to run parallel simulations if you don't already have one. In an `spmd` code block, load the `slexAircraftExample` model and select signals to log. To avoid data concurrency issues using `sim` in `parfor`, create a temporary directory for each worker to use during simulations.

```
p = gcp;
```

Starting parallel pool (parpool) using the 'local' profile ...
connected to 4 workers.

```
spmd
```

```
% Load system and select signals to log
load_system('slexAircraftExample')
Simulink.sdi.markSignalForStreaming('slexAircraftExample/Pilot', 1, 'on')
Simulink.sdi.markSignalForStreaming('slexAircraftExample/Aircraft Dynamics Model', 4, 'on')

% Create temporary directory on each worker
workDir = pwd;
addpath(workDir)
tempDir = tempname;
mkdir(tempDir)
cd(tempDir)
```

```
end
```

Run Parallel Simulations

Use `parfor` to run the seven simulations in parallel. Select the value for `Ts` for each simulation, and modify the value of `Ts` in the model workspace. Then, run the simulation and build an array of `Simulink.sdi.WorkerRun` objects to access the data with the Simulation Data Inspector. After the `parfor` loop, use another `spmd` segment to remove the temporary directories from the workers.

```
parfor index = 1:7
```

```
% Select value for Ts
Ts_val = Ts_vals(index);

% Change the filter time constant and simulate
modelWorkspace = get_param('slexAircraftExample','modelworkspace');
modelWorkspace.assignin('Ts',Ts_val)
sim('slexAircraftExample')

% Create a worker run for each simulation
workerRun(index) = Simulink.sdi.WorkerRun.getLatest
```

```
end
```

```
spmd
```

```
% Remove temporary directories
cd(workDir)
rmdir(tempDir, 's')
rmpath(workDir)
```

```
end
```

Get Dataset Objects from Parallel Simulation Output

The `getDataset` method puts the data from a `WorkerRun` into a `Dataset` object so you can easily post-process.

```
ds(7) = Simulink.SimulationData.Dataset;
```

```

for a = 1:7
    ds(a) = workerRun(a).getDataset;
end
ds(1)

ans =
Simulink.SimulationData.Dataset '' with 2 elements

           Name      BlockPath
-----
1 [1x1 Signal]    alpha, rad    ...rcraftExample/Aircraft Dynamics Model
2 [1x1 Signal]    Stick        slexAircraftExample/Pilot

- Use braces { } to access, modify, or add elements using index.

```

Get DatasetRef Objects from Parallel Simulation Output

For big data workflows, use the `getDatasetRef` method to reference the data associated with the `WorkerRun`.

```

for b = 1:7
    datasetRef(b) = workerRun(b).getDatasetRef;
end

datasetRef(1)

ans =
DatasetRef with properties:

    Name: 'Run 3: slexAircraftExample'
    Run: [1x1 Simulink.sdi.Run]
 numElements: 2

```

Process Parallel Simulation Data in the Simulation Data Inspector

You can also create local `Run` objects to analyze and visualize your data using the Simulation Data Inspector API. This example adds a tag indicating the filter time constant value for each run.

```

for c = 1:7

    Runs(c) = workerRun(c).getLocalRun;
    Ts_val_str = num2str(Ts_vals(c));
    desc = strcat('Ts = ', Ts_val_str);
    Runs(c).Description = desc;
    Runs(c).Name = strcat('slexAircraftExample run Ts=', Ts_val_str);

end

```

Clean Up Worker Repositories

Clean up the files used by the workers to free up disk space for other simulations you want to run on your worker pool.

`Simulink.sdi.cleanupWorkerResources`

See Also

`Simulink.sdi.Run` | `Simulink.sdi.WorkerRun`

Topics

“Inspect and Compare Data Programmatically”

Introduced in R2017b

Simulink.SimulationData.BlockPath class

Package: Simulink.SimulationData

Fully specified Simulink block path

Description

Simulink creates block path objects when creating dataset objects for signal logging and data store logging. `Simulink.SimulationData.Signal` and `Simulink.SimulationData.DataStoreMemory` objects include block path objects.

You can create a block path that you can use with the `getElement` method to access a specific dataset element. If you want to create a dataset in MATLAB to use as a baseline to compare against a signal logging or data store logging dataset, then you need to create the block paths as part of that dataset.

The `Simulink.SimulationData.BlockPath` class is very similar to the `Simulink.BlockPath` class.

You do not have to have Simulink installed to use the `Simulink.SimulationData.BlockPath` class. However, you must have Simulink installed to use the `Simulink.BlockPath` class. If you have Simulink installed, consider using `Simulink.BlockPath` instead of `Simulink.SimulationData.BlockPath`, because the `Simulink.BlockPath` class includes a method for checking the validity of block path objects without you having to update the model diagram.

Property Summary

| Name | Description |
|---------|---|
| SubPath | Individual component within the block specified by the block path |

Method Summary

| Name | Description |
|---------------|--|
| BlockPath | Create a block path. |
| convertToCell | Convert a block path to a cell array of character vectors. |
| getBlock | Get a single block path in the model reference hierarchy. |
| getLength | Get the length of the block path. |

Properties

SubPath

Description

Represents an individual component within the block specified by the block path.

For example, if the block path refers to a Stateflow chart, you can use SubPath to indicate the chart signals. For example:

```
Block Path:
    'sf_car/shift_logic'

SubPath:
    'gear_state.first'
```

Data Type

character vector

Access

RW

Methods

BlockPath

Purpose

Create block path

Syntax

```
blockpath_object = Simulink.SimulationData.BlockPath()
blockpath_object = Simulink.SimulationData.BlockPath(blockpath)
blockpath_object = Simulink.SimulationData.BlockPath(paths)
blockpath_object = Simulink.SimulationData.BlockPath(paths, subpath)
```

Input Arguments

blockpath

The block path object that you want to copy.

paths

A character vector or cell array of character vectors that Simulink uses to build the block path.

Specify each character vector in order, from the top model to the specific block for which you are creating a block path.

Each character vector must be a path to a block within the Simulink model. The block must be:

- A block in a single model
- A Model block (except for the last character vector, which may be a block other than a Model block)
- A block that is in a model that is referenced by a Model block that is specified in the previous character vector

subpath

A character vector that represents an individual component within a block.

Output Arguments`blockpath_object`

The block path that you create.

Description

`blockpath_object = Simulink.SimulationData.BlockPath()` creates an empty block path.

`blockpath_object = Simulink.SimulationData.BlockPath(blockpath)` creates a copy of the block path of the block path object that you specify with the `source_blockpath` argument.

`blockpath = Simulink.SimulationData.BlockPath(paths)` creates a block path from the character vector or cell array of character vectors that you specify with the `paths` argument. Each character vector represents a path at a level of model hierarchy.

`blockpath = Simulink.SimulationData.BlockPath(paths, subpath)` creates a block path from the character vector or cell array of character vectors that you specify with the `paths` argument and creates a path for the individual component (for example, a signal) of the block.

Example

Create a block path object called `bp1`, using a cell array of character vectors representing elements of the block path.

```
bp1 = Simulink.SimulationData.BlockPath(...
{'sldemo_mdref_depgraph/thermostat', ...
'sldemo_mdref_heater/Fahrenheit to Celsius', ...
'sldemo_mdref_F2C/Gain1'})
```

The resulting block path reflects the model reference hierarchy for the block path.

```
bp1 =
```

```
Simulink.BlockPath
Package: Simulink
```

```
Block Path:
'sldemo_mdref_depgraph/thermostat'
'sldemo_mdref_heater/Fahrenheit to Celsius'
'sldemo_mdref_F2C/Gain1'
```

convertToCell**Purpose**

Convert block path to cell array of character vectors

Syntax

```
cellarray = blockPathObject.convertToCell()
```

Output Arguments`cellarray`

The cell array of character vectors representing the elements of the block path.

Description

`cellarray = blockPathObject.convertToCell()` converts a block path to a cell array of character vectors.

Examples

```
bp1 = Simulink.SimulationData.BlockPath(...
{'sldemo_mdref_depgraph/thermostat', ...
'sldemo_mdref_heater/Fahrenheit to Celsius', ...
'sldemo_mdref_F2C/Gain1'})
cellarray_for_bp1 = bp1.convertToCell()
```

The result is a cell array representing the elements of the block path.

```
cellarray_for_bp1 =
    'sldemo_mdref_depgraph/thermostat'
    'sldemo_mdref_heater/Fahrenheit to Celsius'
    'sldemo_mdref_F2C/Gain1'
```

getBlock**Purpose**

Get single block path in model reference hierarchy

Syntax

```
block = blockPathObject.getBlock(index)
```

Input Arguments

`index`

The index of the block for which you want to get the block path. The index reflects the level in the model reference hierarchy. An index of 1 represents a block in the top-level model, an index of 2 represents a block in a model referenced by the block of index 1, and an index of *n* represents a block that the block with index *n*-1 references.

Output Arguments

`block`

The block representing the level in the model reference hierarchy specified by the `index` argument.

Description

`blockpath = Simulink.SimulationData.BlockPath.getBlock(index)` returns the block path of the block specified by the `index` argument.

Example

Get the block for the second level in the model reference hierarchy.

```
bp1 = Simulink.SimulationData.BlockPath(...
{'sldemo_mdref_depgraph/thermostat', ...
'sldemo_mdref_heater/Fahrenheit to Celsius', ...
```

```
'sldemo_mdref_F2C/Gain1'})
blockpath = bp1.getBlock(2)
```

The result is the thermostat block, which is at the second level in the block path hierarchy.

```
blockpath =
sldemo_mdref_heater/Fahrenheit to Celsius
```

getLength

Purpose

Get length of block path

Syntax

```
length = blockPathObject.getLength()
```

Output Arguments

length

The length of the block path. The length is the number of levels in the model reference hierarchy.

Description

`length = Simulink.SimulationData.BlockPath.getLength()` returns a numeric value that corresponds to the number of levels in the model reference hierarchy for the block path.

Example

Get the length of block path `bp1`.

```
bp1 = Simulink.SimulationData.BlockPath(...
{'sldemo_mdref_depgraph/thermostat', ...
'sldemo_mdref_heater/Fahrenheit to Celsius', ...
'sldemo_mdref_F2C/Gain1'})
length_bp1 = bp1.getLength()
```

The result reflects that the block path has three elements.

```
length_bp1 =
```

```
3
```

See Also

[Simulink.BlockPath](#) | [Simulink.SimulationData.Dataset](#)

Introduced in R2012b

Simulink.SimulationData.DatasetRef class

Package: Simulink.SimulationData

Create Simulink.SimulationData.DatasetRef object

Description

To use a reference for accessing a Simulink.SimulationData.Dataset object stored in a MAT-file, create a Simulink.SimulationData.DatasetRef object. You can use this reference to avoid running out of memory, by retrieving data signal by signal, for data that you log to persistent storage. You can stream a DatasetRef object into a root-level input port or you can use it to create a SimulationDatastore object to use for streaming. For details, see “Load Big Data for Simulations”.

For parallel simulations, for which you specify an array of Simulink.SimulationInput objects, if you are logging to file, Simulink:

- Creates Simulink.SimulationData.DatasetRef objects to access output data in the MAT-file and includes those objects in the SimulationOutput object data
- Enables the CaptureErrors argument for simulation

Construction

`DSRefObj = Simulink.SimulationData.DatasetRef(location, identifier)` creates a reference to the contents of a Simulink.SimulationData.Dataset variable stored in a MAT-file.

Input Arguments

location — MAT-file containing Simulink.SimulationData.Dataset object to reference
character vector

MAT-file containing Simulink.SimulationData.Dataset object to reference, specified as a character vector. The character vector is a path to the MAT-file. Do not use a file name from one locale in a different locale.

identifier — Name of variable in MAT-file
character vector

Name of a Simulink.SimulationData.Dataset variable in MAT-file, specified as a character vector. When you log to persistent storage, Simulink uses the variable names specified for each kind of logging.

Suppose that you use the default variable name for signal logging (`logout`) and default MAT-file name for persistent storage logging (`mat.out`). After you simulate the model, then to create a reference to the Dataset object for signal logging, at the MATLAB command line, enter:

```
sigLogRef = Simulink.SimulationData.DatasetRef('out.mat', 'logout');
```

Output Arguments

DSRefObj — Reference to Dataset object

Simulink.SimulationData.DatasetRef object

Reference to logging dataset, returned as a Simulink.SimulationData.DatasetRef object.

Properties

Location — MAT-file containing Simulink.SimulationData.Dataset object to reference

character vector

MAT-file containing Simulink.SimulationData.Dataset object to reference, specified as a character vector. The character vector is a path to the MAT-file. Include the .mat extension in the file name. Do not use a file name from one locale in a different locale.

Identifier — Name of variable in MAT-file

character vector

Name of a Simulink.SimulationData.Dataset variable in MAT-file, specified as a character vector. When you log to persistent storage, Simulink uses the variable names specified for each kind of logging (for example, 'logout' for signal logging data).

Methods

Use the numElements, getElement, and getElementNames methods for a Simulink.SimulationData.DatasetRef object the same way that you use those methods for a Simulink.SimulationData.Dataset object.

| Method | Purpose |
|--|--|
| numElements | Get number of elements from dataset |
| getElementNames | Return names of all elements in dataset |
| get The get method is an alias for the getElement method. | Get element from dataset |
| Note You can use curly braces to streamline indexing syntax to access elements in a dataset reference, instead of using get or getElement methods. To get an element using curly braces, the index must be a scalar that is not greater than the number of elements in the variable. The get and getElement methods support specifying an element by name or block path, as well as by index. | |
| getAsDatastore | Get matlab.io.datastore.SimulationDatastore representation of element from a DatasetRef object |

| Method | Purpose |
|--|---|
| getDatasetVariableNames on page 2-1128 | List names of Dataset variables in MAT-file |
| plot | Plot data in the Simulation Data Inspector |

Tip To get the names of Dataset variables in the MAT-file, using the `Simulink.SimulationData.DatasetRef.getDatasetVariableNames` function processes faster than using the `who` or `whos` functions.

Copy Semantics

You can copy `DatasetRef` object properties by value. However, copying the `DatasetRef` object produces a handle object. Copying the `DatasetRef` object does not copy the data in the MAT-file that the object references. For details about copy operations, see [Copying Objects in the MATLAB documentation](#).

Examples

Create References to Persistent Storage Dataset Objects

This example shows how to construct and use `Simulink.SimulationData.DatasetRef` objects to access data for a model that logs to persistent storage. This simple example shows the basic steps for logging to persistent storage. This example does not represent a realistic situation for logging to persistent storage, because it shows a short simulation with small memory requirements.

Open the `vdv` model.

In the **Configuration Parameters** > **Data Import/Export** pane, select these parameters:

- **States**
- **Log Dataset data to file**

Set the **Format** parameter to `Dataset`.

Leave the other parameter settings as they are and click **Apply**.

In the model, click a signal and from the action bar, select **Enable Data Logging**.

Simulate the model.

Get a list of Dataset variable names in the `out.mat` file.

```
varNames = Simulink.SimulationData.DatasetRef.getDatasetVariableNames('out.mat')
varNames =
    1x2 cell array
    'logout'   'xout'
```

Create a reference to the logged states data that is stored in `out.mat`. The variable for the logged states data is `xout`.

```
statesLogRef = Simulink.SimulationData.DatasetRef('out.mat', 'xout')
```

```
statesLogRef =
```

```
Simulink.SimulationData.DatasetRef
Characteristics:
  Location: out.mat (/my_files/out.mat)
  Identifier: xout
```

```
Resolved Dataset: 'xout' with 2 elements
```

| | Name | BlockPath |
|---|------|-----------|
| 1 | ' ' | vdp/x1 |
| 2 | ' ' | vdp/x2 |

Create a reference to the signal logging data that is stored in `out.mat`. The variable for the signal logging data is `logout`.

```
sigLogRef = Simulink.SimulationData.DatasetRef('out.mat', 'logout')
```

```
sigLogRef =
```

```
Simulink.SimulationData.DatasetRef
Characteristics:
  Location: out.mat (/my_files/out.mat)
  Identifier: logout
```

```
Resolved Dataset: 'logout' with 1 element
```

| | Name | BlockPath |
|---|------|-----------|
| 1 | x1 | vdp/x1 |

Use the `numElements` to access the number of elements in the logged states dataset.

```
statesLogRef.numElements
```

```
ans =
```

```
2
```

Use the `DatasetRef` to access the first element of the signal logging dataset.

```
sigLogRef{1}
```

```
ans =
```

```
Simulink.SimulationData.Signal
Package: Simulink.SimulationData
```

```
Properties:
```

```
  Name: 'x1'
  PropagatedName: ''
  BlockPath: [1x1 Simulink.SimulationData.BlockPath]
  PortType: 'outport'
```

```
PortIndex: 1  
Values: [1x1 timeseries]
```

Methods, Superclasses

Delete the persistent storage MAT-file and try to use one of the `DatasetRef` objects.

```
delete('out.mat');  
statesLogRef.get(1)
```

File does not exist.

The `statesLogRef` still exists, but it is a reference to a `Dataset` object that is in a file that no longer exists.

See Also

[matlab.io.datastore.SimulationDatastore](#) | [Simulink.SimulationData.Dataset](#) | [Simulink.SimulationData.DatasetRef.getDatasetVariableNames](#)

Topics

[“Log Data to Persistent Storage”](#)

[“Load Big Data for Simulations”](#)

[“Convert Logged Data to Dataset Format”](#)

Introduced in R2016a

Simulink.SimulationData.DataStoreMemory

Container for data store logging information

Description

Simulink uses `Simulink.SimulationData.DataStoreMemory` objects to store logging information from Data Store Memory blocks during simulation. The objects contain information about the blocks that write to the data store.

Property Summary

| Name | Description |
|-----------------------------------|--|
| BlockPath on page 5-535 | Location of Data Store Memory block for the logged data store |
| DSMWriterBlockPaths on page 5-535 | Location of Data Store Write blocks that write to the data store |
| DSMWriters on page 5-536 | Data Store Write blocks for each signal value |
| Name on page 5-536 | Name of the data store dataset |
| Scope on page 5-536 | Scope of the data store: 'local' or 'global' |
| Values on page 5-536 | Time and data that were logged |

Properties

BlockPath

Description

Location of Data Store Memory block for the logged data store.

Data Type

character vector

Access

RW

DSMWriterBlockPaths

Description

Location of blocks that write to the data store. Each element of the array contains the full block path of one writer block.

Data Type

Vector of `Simulink.SimulationData.BlockPath` objects

Access

R0

DSM Writers**Description**

The number of writes in the data store.

The *n*th element of `DSM Writers` contains the index of the element in `DSM WriterBlockPaths` that contains the block path of the writer that performed the *n*th write to `Values`.

Data Type

Integer vector

Access

R0

Name**Description**

Name of the data store dataset

Data Type

character vector

Access

R0

Scope**Description**

Scope of the data store: 'local' or 'global'

Data Type

character vector

Access

RW

Values**Description**

Time and data that were logged

Data Type

MATLAB timeseries

Access

RW

See Also

[Simulink.SimulationData.Dataset](#) | [Data Store Memory](#) | [Data Store Write](#) | [plot](#)

Topics

“Log Data Stores”

Simulink.SimulationData.LoggingInfo

Signal logging override settings

Description

This object specifies a set of signal logging override settings.

Use a `Simulink.SimulationData.LoggingInfo` object to specify the signal logging override settings for a signal. You can use this object for the `LoggingInfo` property of a `Simulink.SimulationData.SignalLoggingInfo` object.

Property Summary

| Name | Description |
|--|--|
| <code>DataLogging</code> on page 5-538 | Signal logging mode. |
| <code>NameMode</code> on page 5-539 | Source of signal logging name. |
| <code>LoggingName</code> on page 5-539 | Custom signal logging name. |
| <code>DecimateData</code> on page 5-539 | Use subset of sample points. |
| <code>Decimation</code> on page 5-539 | Decimation value (n): Simulink logs every nth data point. |
| <code>LimitDataPoints</code> on page 5-540 | Limit number of data points to log. |
| <code>MaxPoints</code> on page 5-540 | Maximum number of data points to log (N). The set of logged data points is the last N data points generated by the simulation. |

Method Summary

| Name | Description |
|--|--|
| <code>LoggingInfo</code> on page 5-540 | Create a set of signal logging override settings for a signal. |

Properties

DataLogging

Description

Signal logging mode.

Indicates whether logging is enabled for this signal.

Data Type

logical value — `{true}` | `false`

Access

RW

NameMode**Description**

Source of signal logging name.

Indicates whether the signal logging name is a custom name ('true') or whether the signal logging name is the same as the signal name ('false').

Data Type

logical value — true | {false}

Access

RW

LoggingName**Description**

Custom signal logging name

The custom signal logging name to use for this signal, if the NameMode property is true.

Data Type

character vector

Access

RW

DecimateData**Description**

Log a subset of sample points, selecting data points at a specified interval. The first sample point is always logged.

Data Type

logical value — true | {false}

Access

RW

Decimation**Description**

Decimation value (n). If the DecimateData property is true, then Simulink logs every nth data point.

Data Type

positive integer

Access

RW

LimitDataPoints**Description**

Limit the number of data points to log.

Data Type

logical value — true | {false}

Access

RW

MaxPoints**Description**

Maximum number of data points to log (N). If the `LimitDataPoints` property is `true`, then the set of logged data points includes the last N data points generated by the simulation.

Data Type

positive integer

Access

RW

Methods**LoggingInfo****Purpose**

Create a `Simulink.SimulationData.LoggingInfo` object.

Syntax

```
logging_info_object = Simulink.SimulationData.LoggingInfo()  
logging_info_object = Simulink.SimulationData.LoggingInfo(object)
```

Input Arguments

`object`

A signal logging override settings object whose property values the constructor uses for the new `Simulink.SimulationData.LoggingInfo` object. The signal logging override object that you specify must be one of the following types of objects:

- `Simulink.SimulationData.LoggingInfo` object
- `Simulink.LoggingInfo` object

Output Arguments

`logging_info_object`

A `Simulink.SimulationData.LoggingInfo` object.

Description

`logging_info_object = Simulink.SimulationData.LoggingInfo()` creates a `Simulink.SimulationData.LoggingInfo` object that has default property values.

`logging_info_object = Simulink.SimulationData.LoggingInfo(object)` creates a `Simulink.SimulationData.LoggingInfo` object that copies the property values from the signal logging override object that you specify with the `object` argument.

Examples

The following example creates a `Simulink.SimulationData.LoggingInfo` object with default settings, changes the `DecimateData` and `Decimation` properties, and uses the object for the `LoggingInfo` property of a `Simulink.SimulationData.SignalLoggingInfo` object `mi`.

```
open_system(docpath(fullfile(docroot, 'toolbox', 'simulink', 'examples', 'ex_mdhref_counter_bus', 'ex_mdhref_counter_bus.mat'), 'ex_mdhref_counter_bus'));
open_system(docpath(fullfile(docroot, 'toolbox', 'simulink', 'examples', 'ex_bus_logging'), 'ex_bus_logging'));
log_info = Simulink.SimulationData.LoggingInfo();
log_info.DecimateData = true;
log_info.Decimation = 2;
mi = Simulink.SimulationData.SignalLoggingInfo('ex_bus_logging');
mi.LoggingInfo = log_info
```

```
Simulink.SimulationData.SignalLoggingInfo
  Package: Simulink.SimulationData
```

```
BlockPath:
  'ex_bus_logging'
```

```
OutputPortIndex: 1
```

```
LoggingInfo:
  DataLogging: 1
  NameMode: 0
  LoggingName: ''
  DecimateData: 1
  Decimation: 2
  LimitDataPoints: 0
  MaxPoints: 5000
```

See Also

`Simulink.SimulationData.ModelLoggingInfo` | `Simulink.SimulationData.SignalLoggingInfo` | `Simulink.SimulationData.BlockPath` | `Simulink.SimulationData.Signal` | `Simulink.SimulationData.DataStoreMemory`

Topics

“Override Signal Logging Settings from MATLAB”
 “Export Signal Data Using Signal Logging”
 “Log Data Stores”

Introduced in R2012b

Simulink.SimulationData.ModelLoggingInfo

Signal logging override settings for a model

Description

This class is a collection of `Simulink.SimulationData.SignalLoggingInfo` objects that specify all signal logging override settings for a model.

Use methods and properties of this class to:

- Turn off logging for a signal or a Model block.
- Change logging settings for any signals that are marked for logging within a model.

You can control whether a top model and referenced models override signal logging settings or use the signal logging settings specified by the model. Use the `LoggingMode` and `LogAsSpecifiedByModels` properties to control which logging settings to apply.

| Logging Mode for Models | Property Settings |
|--|---|
| For top model and all referenced models, use logging settings specified in the model. | Set <code>LoggingMode</code> to <code>LogAllAsSpecifiedInModel</code> . |
| For top model and all referenced models, use override signal logging settings. | Set <code>LoggingMode</code> to <code>OverrideSignals</code> . |
| For top model and referenced models, use a mix of override signal logging settings and the signal logging settings specified in the model. | Set <code>LoggingMode</code> to <code>OverrideSignals</code> . Include models you want to ignore override signal logging settings in the <code>LogAsSpecifiedByModels</code> cell array. |

For more information and examples, see “Override Signal Logging Settings from MATLAB”.

Property Summary

| Name | Description |
|---|--|
| <code>LoggingMode</code> on page 5-543 | Signal logging override status |
| <code>LogAsSpecifiedByModels</code> on page 5-543 | Source of signal logging settings for the top model or a top-level Model block |
| <code>Signals</code> on page 5-544 | All signals that have signal override settings |

Method Summary

| Name | Description |
|---------------------------------------|--|
| <code>findSignal</code> on page 5-548 | Find signals within the <code>Signals</code> vector, using block path and output port index. |

| Name | Description |
|--|--|
| <code>verifySignalAndModelPaths</code> on page 5-551 | Verify signal and model paths for the model signal logging override object. |
| <code>getLogAsSpecifiedInModel</code> on page 5-549 | Determine whether the model logs signals as specified in the model or uses override settings. |
| <code>setLogAsSpecifiedInModel</code> on page 5-550 | Set the logging mode for the top model or a top-level Model block. |
| <code>createFromModel</code> on page 5-544 | Create and populate a model signal logging override object with all logged signals in the model hierarchy. |
| <code>ModelLoggingInfo</code> on page 5-547 | Set signals to log or override logging settings. |

Properties

LoggingMode

Description

Signal logging override status. Values are:

- `OverrideSignals` — (Default) Uses the logging settings for signals, as specified in the `Signals` property. For models where `getLogAsSpecifiedInModel` is:
 - `true` — Logs all signals, as specified in the model.
 - `false` — Logs only the signals specified in the `Signals` property.
- `LogAllAsSpecifiedInModel` — Logs signals in the top model and all referenced models, as specified in the model. Simulink honors the signal logging indicators (blue antennae) and ignores the `Signals` property.

To change the logging mode for the top model or for a given referenced model, use the `setLogAsSpecifiedInModel` method.

Data Type

character array

Access

RW

LogAsSpecifiedByModels

Description

When `LoggingMode` is set to `'OverrideSignals'`, the `LogAsSpecifiedByModels` cell array specifies the top models and top-level Model blocks that ignore the `'OverrideSignals'` setting and log signals as specified in the models or Model blocks.

- For the top model and top-level Model blocks that the cell array includes, Simulink ignores the `Signals` property overrides.
- For a model or Model block that the cell array does *not* include, Simulink uses the `Signals` property to determine which signals to log.

When `LoggingMode` is set to `'LogAllAsSpecifiedInModel'`, Simulink ignores the `LogAsSpecifiedByModels` property.

Use the `getLogAsSpecifiedInModel` method to determine whether the top model or top-level Model block logs signals as specified in the model (default logging), and use `setLogAsSpecifiedInModel` to turn default logging on and off.

Data Type

cell array — For the top model, specify the model name. For Model blocks, specify the block path.

Access

RW

Signals

Description

Vector of `Simulink.SimulationData.SignalLoggingInfo` objects for all signals with signal logging override settings.

Data Type

vector of `Simulink.SimulationData.SignalLoggingInfo` objects

Access

RW

Methods

`createFromModel`

Purpose

Create a `Simulink.SimulationData.ModelLoggingInfo` object for a top model, with override settings for each logged signal in the model.

Syntax

```
model_logging_info_object = ...  
Simulink.SimulationData.ModelLoggingInfo.createFromModel(...  
model,options)
```

Input Arguments

`model`

Name of the top model for which to create a `Simulink.SimulationData.ModelLoggingInfo` object.

`options`

You can use any combination of the following option name and value pairs to control the kinds of systems from which to include logged signals.

- `FollowLinks`
 - `on` — (Default) Include logged signals from inside of libraries.

- `off` — Skip all libraries.
- `LookUnderMasks`
 - `all` — (Default) Include logged signals from all masked subsystems.
 - `none` — Skip all masked subsystems.
 - `graphical` — Include logged signals from masked subsystems that do not have a workspace or dialog box.
 - `functional` — Include logged signals from masked subsystems that do not have a dialog box.
- `Variants`
 - `ActiveVariants` — (Default) Include logged signals from only active subsystem and model variants.
 - `AllVariants` — Include logged signals from all subsystem and model variants.
- `RefModels`
 - `on` — (Default) Include logged signals from referenced models.
 - `off` — Skip all referenced models.

If you select more than one option, then the created `Simulink.SimulationData.ModelLoggingInfo` object includes signals that fit the combinations (the “AND”) of the specified options. For example, if you set `FollowLinks` to `on` and set `RefModels` to `off`, then the model signal logging override object does not include signals from library links that exist inside of referenced models.

Output Arguments

`model_logging_override_object`

`Simulink.SimulationData.ModelLoggingInfo` object for the top model.

Description

`model_logging_info_object = Simulink.SimulationData.ModelLoggingInfo.createFromModel(model)` creates a `Simulink.SimulationData.ModelLoggingInfo` object for the model that includes logged signals for the following kinds of systems:

- Libraries
- Masked subsystems
- Referenced models
- Active variants

`model_logging_override_object = Simulink.SimulationData.ModelLoggingInfo.createFromModel(model, options)` creates a `Simulink.SimulationData.ModelLoggingInfo` object for the model. The included logged signals reflect the options settings for the following kinds of systems:

- Libraries
- Masked subsystems

- Referenced models
- Variants

Examples

The following example creates a model logging override object for the `sldemo_mdhref_bus` model and automatically adds each logged signal in the model to that object:

```
mi = Simulink.SimulationData.ModelLoggingInfo.createFromModel(...
'sldemo_mdhref_bus')

mi =

  ModelLoggingInfo with properties:

      Model: 'sldemo_mdhref_bus'
  LoggingMode: 'OverrideSignals'
LogAsSpecifiedByModels: {}
      Signals: [1x3 Simulink.SimulationData.SignalLoggingInfo]
```

To apply the model override object settings, use:

```
set_param(sldemo_mdhref_bus, 'DataLoggingOverride', mi);
```

You can use the options for the `createFromModel` method to specify how the method should handle model components like variants and model references. For example, use the `Variants` option to create a `model_logging_override` object that includes logged signals in all variants of the `sldemo_variant_subsystems` model.

By default, the `sldemo_variant_subsystems` model does not log any signals. Start by configuring the output signals from the `Linear Controller` and `Nonlinear Controller` subsystems for logging.

```
% Open the sldemo_variant_subsystems model
sldemo_variant_subsystems;

% Mark the output of the Linear Controller subsystem for logging
ph = get_param('sldemo_variant_subsystems/Controller/Linear Controller',...
'PortHandles');
set_param(ph.Outputport(1), 'DataLogging', 'on');

% Mark the output of the Nonlinear Controller subsystem for logging
ph1 = get_param('sldemo_variant_subsystems/Controller/Nonlinear Controller',...
'PortHandles');
set_param(ph1.Outputport(1), 'DataLogging', 'on');
```

Then, use the `createFromModel` method to create a `model_logging_override` object that includes signals logged in all variant subsystems of the `sldemo_variant_subsystems` model.

```
% Create a model_logging_override object for the model including all variants
mi = Simulink.SimulationData.ModelLoggingInfo.createFromModel(...
'sldemo_variant_subsystems', 'Variants', 'AllVariants')

mi =

  ModelLoggingInfo with properties:

      Model: 'sldemo_variant_subsystems'
  LoggingMode: 'OverrideSignals'
LogAsSpecifiedByModels: {}
      Signals: [1x2 Simulink.SimulationData.SignalLoggingInfo]
```

ModelLoggingInfo

Purpose

Specify signals to log or override logging settings.

Syntax

```
model_logging_override_object = ...
Simulink.SimulationData.ModelLoggingInfo(model)
```

Input Arguments

`model`

Name of the top model for which to create a `Simulink.SimulationData.ModelLoggingInfo` object

Output Arguments

`model_logging_override_object`

`Simulink.SimulationData.ModelLoggingInfo` object created for the specified top model.

Description

`model_logging_override_object = Simulink.SimulationData.ModelLoggingInfo(model)` creates a `Simulink.SimulationData.ModelLoggingInfo` object for the specified top model.

If you use the `Simulink.SimulationData.ModelLoggingInfo` constructor, specify a `Simulink.SimulationData.SignalLoggingInfo` object for each logged signal for which you want to override logging settings.

To check that you have specified valid signal logging override settings for a model, use the `verifySignalAndModelPaths` method with the `Simulink.SimulationData.ModelLoggingInfo` object for the model.

Examples

The following example shows how to log all signals as specified in the top model and all referenced models.

```
mi = Simulink.SimulationData.ModelLoggingInfo('sldemo_mdref_bus');
mi.LoggingMode = 'LogAllAsSpecifiedInModel'

mi =

    ModelLoggingInfo with properties:

        Model: 'sldemo_mdref_bus'
        LoggingMode: 'LogAllAsSpecifiedInModel'
        LogAsSpecifiedByModels: {}
        Signals: []
```

To apply the model override object settings, use:

```
set_param(sldemo_mdref_bus, 'DataLoggingOverride', mi);
```

The following example shows how to log only signals in the top model:

```
mi = ...
Simulink.SimulationData.ModelLoggingInfo('sldemo_mdref_bus');
```

```
mi.LoggingMode = 'OverrideSignals';  
mi = mi.setLogAsSpecifiedInModel('sldemo_mdref_bus', true);  
set_param('sldemo_mdref_bus', 'DataLoggingOverride', mi);
```

findSignal

Purpose

Find signals within the Signals vector, using a block path and optionally an output port index.

Syntax

```
signal_indices = ...  
    model_logging_override_object.findSignal(block_path)  
signal_indices = ...  
    model_logging_override_object.findSignal(...  
    block_path, port_index)
```

Input Arguments

block_path

Source block to search. The `block_path` must be one of the following:

- Character vector
- Cell array of character vectors
- `Simulink.BlockPath` object

port_index

Index of the output port to search. Specify a scalar greater than, or equal to, 1.

Output Arguments

signal_indices

Vector of numeric indices into the signals vector of the `Simulink.SimulationData.ModelLoggingInfo` object.

Description

`signal_indices = model_logging_override_object.findSignal(block_path)` finds the indices of the signals for the block path that you specify.

To find a *single* instance of a signal within a referenced model, use a `Simulink.BlockPath` object or a cell array with a *full path*.

To find *all* instances of a signal within a referenced model, use a character vector with the *relative* path of the signal within the referenced model.

To find a logged chart signal within a Stateflow chart, use a `Simulink.BlockPath` object and set the `SubPath` property to the name of the Stateflow chart signal.

`signal_indices = model_logging_override_object.findSignal(block_path, port_index)` finds the indices of the output signal for the port that you specify, for the block path that you specify.

Do not use the `port_index` argument for Stateflow chart signals.

Examples

To find a signal that is *not* in a Stateflow chart and that does *not* appear in multiple instances of a referenced model:

```
open_system(docpath(fullfile(docroot, 'toolbox', 'simulink', 'examples', 'ex_bus_logging')))
% Open the referenced model
ex_mdref_counter_bus
mi = Simulink.SimulationData.ModelLoggingInfo.createFromModel(...
    'ex_bus_logging');
% Click the COUNTERBUSCreator block that is the source of
% the logged COUNTERBUS signal
signal_index = mi.findSignal(gcb)
```

```
signal_index =
    1
```

To find a signal in a specific instance of a referenced model that is not in a Stateflow chart, use the following approach:

```
signal_index = mi.findSignal({'ex_bus_logging/CounterA', ...
    'ex_mdref_counter_bus/Bus Creator'})
```

```
signal_index =
    4
```

For an example that uses the `findSignal` method with a Stateflow chart, see “Override Logging Properties with the Command-Line API” (Stateflow).

getLogAsSpecifiedInModel

Purpose

Determine whether the model logs as specified in the model or uses override settings.

Syntax

```
logging_mode = ...
getLogAsSpecifiedInModel(model_logging_override_object, path)
```

Input Arguments

`model_logging_override_object`

A `Simulink.SimulationData.ModelLoggingInfo` object.

`path`

The path is a character vector that specifies one of the following:

- Name of the top model
- Block path of a Model block in the top model

Output Arguments

`logging_mode`

The `logging_mode` is:

- `true`, if the model specified by `path` is logged as specified in the model.

- `false`, if the model specified by `path` is logged using the override settings specified in the `Signals` property.

Description

`logging_mode = model_logging_override_object.getLogAsSpecifiedInModel(path)`
returns:

- `true`, if the model specified by `path` is logged as specified in the model.
- `false`, if the model specified by `path` is logged using the override settings specified in the `Signals` property.

Examples

In the following example, the `Simulink.SimulationData.ModelLoggingInfo` object `mi` uses the override settings specified in its `Signals` property.

```
mi = Simulink.SimulationData.ModelLoggingInfo('sldemo_mdref_bus');  
logging_mode = getLogAsSpecifiedInModel(mi, 'sldemo_mdref_bus')
```

```
logging_mode =
```

```
    0
```

setLogAsSpecifiedInModel**Purpose**

Set logging mode for top model or top-level Model block

Syntax

```
setLogAsSpecifiedInModel(override_object, path)
```

Input Arguments

`override_object`

`Simulink.SimulationData.ModelLoggingInfo` object.

`path`

Character vector that specifies one of the following:

- Name of the top model
- Block path of a Model block in the top model

`value`

Logging mode:

- `true`, if the model specified by `path` is logged as specified in the model
- `false`, if the model specified by `path` is logged using the override settings specified in the `Signals` property.

Description

`setLogAsSpecifiedInModel(override_object, path, value)` sets the `LoggingMode` property for a top model or a Model block in the top model.

Example

The following example shows how to log only signals in the top model, using the logging settings specified in that model:

```
sldemo_mdref_bus;
mi = Simulink.SimulationData.ModelLoggingInfo('sldemo_mdref_bus');
mi.LoggingMode = 'OverrideSignals';
mi = setLogAsSpecifiedInModel(mi, 'sldemo_mdref_bus', true);
set_param('sldemo_mdref_bus', 'DataLoggingOverride', mi);
```

verifySignalAndModelPaths**Purpose**

Verify paths in `Simulink.SimulationData.ModelLoggingInfo` object.

Syntax

```
verified_object = verifySignalAndModelPaths...
(model_logging_override_object, action)
```

Input Arguments

`model_logging_override_object`

The `Simulink.SimulationData.ModelLoggingInfo` object to verify. This argument is required.

`action`

The action that the function performs if verification fails. This argument is optional. Specify one of the following values:

- `error` — (default) Throw an error when verification fails
- `warnAndRemove` — Issue a warning when verification fails and update the `Simulink.SimulationData.ModelLoggingInfo` object.
- `remove` — Silently update the `Simulink.SimulationData.ModelLoggingInfo` object.

Output Arguments

`verified_object`

If the method detects no invalid paths, it returns the validated object. For example:

```
verified_object =
    Simulink.SimulationData.ModelLoggingInfo
    Package: Simulink.SimulationData

    Properties:
        Model: 'logging_top'
        LoggingMode: 'OverrideSignals'
        LogAsSpecifiedByModels: {}
        Signals: [1x11 Simulink.SimulationData.SignalLoggingInfo]
```

If the method detects an invalid path, it performs the action specified by the `action` argument. By default, it issues an error message.

Description

```
verified_object = verifySignalAndModelPaths(model_logging_override_object,
action)
```

For a `Simulink.SimulationData.ModelLoggingInfo` object, verify that:

- All character vectors in the `LogAsSpecifiedByModels` property are either the name of the top model or the block path of a `Model` block in the top model.
- The block paths for signals in the `Signals` property refer to valid blocks within the hierarchy of the top model.
- The `OutputPortIndex` property for all signals in the `Signals` property are valid for the given block.
- All signals in the `Signals` property refer to *logged* signals.

The `action` argument specifies what action the method performs. By default, the method returns an error if it detects an invalid path.

If you use the `Simulink.SimulationData.ModelLoggingInfo` constructor and specify a `Simulink.SimulationData.SignalLoggingInfo` object for each signal, then consider using the `verifySignalAndModelPaths` method to verify that your object definitions are valid.

Example

The following example shows how to validate the signal and block paths in a `Simulink.SimulationData.ModelLoggingInfo` object. Because the `action` argument is `warnAndRemove`, if the validation fails, the `verifySignalAndModelPaths` method issues a warning and updates the `Simulink.SimulationData.ModelLoggingInfo` object.

```
mi = Simulink.SimulationData.ModelLoggingInfo('sldemo mdlref_bus');  
verified_object = verifySignalAndModelPaths...  
    (mi, 'warnAndRemove')
```

See Also

`Simulink.BlockPath` | `Simulink.SimulationData.LoggingInfo` |
`Simulink.SimulationData.SignalLoggingInfo` | `Simulink.SimulationData.Signal` |
`Simulink.SimulationData.DataStoreMemory`

Topics

“Override Signal Logging Settings from MATLAB”
“Export Signal Data Using Signal Logging”
“Log Data Stores”

Introduced in R2012b

Simulink.SimulationData.Parameter class

Package: Simulink.SimulationData

Stores logged parameter data and metadata

Description

The `Simulink.SimulationData.Parameter` object stores data and metadata for logged block parameters. Tunable parameters connected to Dashboard blocks are logged to the Simulation Data Inspector during simulation. To access logged parameter data, you can export the simulation run from the Simulation Data Inspector using the UI or the `Simulink.sdi.exportRun` function. For more information about exporting simulation runs with the Simulation Data Inspector UI, see “Export Data to the Workspace or a File”.

Construction

`dataset = Simulink.sdi.exportRun(runID)` returns a `Simulink.SimulationData.Parameter` object as an element in `dataset` when the run corresponding to `runID` contains logged parameter data.

Input Arguments

runID — Run ID for a run with logged parameter data

integer

Run ID for the run containing logged parameter data. Run IDs are assigned by the Simulation Data Inspector. You can get the run ID for a simulation run using the `Simulink.sdi.getAllRunIDs` or `Simulink.sdi.getRunIDByIndex` function.

Output Arguments

dataset — Dataset containing the run data

`Simulink.SimulationData.Dataset`

`Simulink.SimulationData.Dataset` object containing the run data and metadata. When the run contains logged parameter data, the dataset contains a `Simulink.SimulationData.Parameter` object as an element for each logged parameter. The `Simulink.SimulationData.Parameter` element takes the name of the logged parameter. You can access a `Simulink.SimulationData.Parameter` object using `get`.

Properties

Name — Parameter name in Dashboard label

character vector

Parameter name as it appears in the label for the Dashboard block.

Example: 'Mu:Gain'

BlockPath — Path of the block associated with the parameter

`Simulink.SimulationData.BlockPath`

Path to the block the parameter or variable corresponds to, returned as a `Simulink.SimulationData.BlockPath` object.

Example: `vdp/Mu`

ParameterName — Parameter name

character vector

Name of the logged parameter as it appears in the block dialog box. For variables, the `ParameterName` property is empty.

Example: `'Gain'`

VariableName — Variable name

character vector

Name of the logged variable. For parameters, the `VariableName` property is empty.

Example: `'Zw'`

Values — Timeseries of parameter values

timeseries

timeseries of parameter values. For logged variables, the `timeseries` name is the variable name. For logged parameters, the `timeseries` name is empty.

Methods

`plot` Plot simulation output data in the Simulation Data Inspector

Copy Semantics

Value. To learn how value classes affect copy operations, see [Copying Objects](#).

Examples

Access Logged Parameter Data

This example shows how to access logged parameter data. Parameter data automatically logs to the Simulation Data Inspector when you connect a Dashboard block to a block parameter. Parameter data does not export to the workspace with other simulation data at the end of simulation. You can access the logged parameter data by exporting the run containing it from the Simulation Data Inspector.

Log Parameter Data

Run a simulation of the model `ex_vdp_param`, a modified version of the `vdp` model with an Edit block connected to the gain parameter of the Mu block. The parameter data logs with the signal data for signals marked for logging.

```
sim('ex_vdp_param');
```

Export Run

Use the Simulation Data Inspector programmatic interface to get the run ID for the `ex_vdp_param` simulation, and export the run.

```
index = Simulink.sdi.getRunCount;  
runID = Simulink.sdi.getRunIDByIndex(index);  
  
dataset = Simulink.sdi.exportRun(runID);
```

Access Parameter Data

Use the `get` method to access the `Simulink.SimulationData.Parameter` object for the logged parameter data. The `Values` property contains the timeseries data for the parameter.

```
muGain = dataset.get('Mu:Gain')  
  
muGain =  
    Simulink.SimulationData.Parameter  
    Package: Simulink.SimulationData  
  
    Properties:  
        Name: 'Mu:Gain'  
        BlockPath: [1x1 Simulink.SimulationData.BlockPath]  
        Values: [1x1 timeseries]
```

Methods, Superclasses

See Also

[Simulink.SimulationData.Dataset](#) | [Simulink.SimulationData.BlockPath](#) | [get](#)

Topics

“Tune and Visualize Your Model with Dashboard Blocks”

“View Data in the Simulation Data Inspector”

Introduced in R2018a

Simulink.SimulationData.SignalLoggingInfo

Signal logging override settings for signal

Description

This object contains the signal override signal logging settings for a single logged signal.

Property Summary

| Name | Description |
|-------------------------------|---|
| BlockPath on page 5-556 | Simulink.BlockPath of source block of a signal to log. |
| OutputPortIndex on page 5-556 | Index of an output port to log. |
| LoggingInfo on page 5-557 | Simulink.SimulationData.LoggingInfo object containing all logging override settings for a signal. |

Method Summary

| Name | Description |
|---------------------------------|---|
| SignalLoggingInfo on page 5-557 | Create a signal logging override object for a signal. |

Properties

BlockPath

Description

Simulink.BlockPath of source block of signal to log. The block path represents the full model reference hierarchy.

To specify a specific instance of a signal, use an absolute path, reflecting the model reference hierarchy, starting at the top model. For example:

```
sig_log_info = Simulink.SimulationData.SignalLoggingInfo(...
{'sldemo_mdref_bus/CounterA', ...
'sldemo_mdref_counter_bus/Bus Creator'})
```

Data Type

Simulink.BlockPath

Access

RW

OutputPortIndex

Description

Index of the output port to log. The index is a 1-based numeric value.

Data Type

nonzero integer

Access

RW

LoggingInfo**Description**

`Simulink.SimulationData.LoggingInfo` object containing logging override settings for a signal. The logging settings specify whether signal logging is overridden for this signal. The logging settings also can specify a logging name, a decimation factor, and a maximum number of data points.

Data Type

`Simulink.SimulationData.LoggingInfo` object

Access

RW

Methods**SignalLoggingInfo****Purpose**

Construct a `Simulink.SimulationData.SignalLoggingInfo` object.

Syntax

```
signal_logging_info_object = ...
    Simulink.SimulationData.SignalLoggingInfo()
signal_loggingInfo_object = ...
    Simulink.SimulationData.SignalLoggingInfo(path)
signalLoggingInfo_object = ...
    Simulink.SimulationData.SignalLoggingInfo(path,index)
```

Input Arguments

`path`

The block path of the source block for which the signal logging override settings apply. If you use this argument without also using the `port` argument, then Simulink sets the output port index to 1.

`index`

Output port index to which the signal logging override settings apply.

Output Arguments

`signal_logging_object`

`Simulink.SimulationData.SignalLoggingInfo` object that represents the override settings of a signal.

Description

`signal_logging_override_object = Simulink.SimulationData.SignalLoggingInfo()` creates a `Simulink.SimulationData.LoggingInfo` object that contains default logging settings for a signal.

`signal_logging_override_object = Simulink.SimulationData.SignalLoggingInfo(path)` creates a `Simulink.SimulationData.LoggingInfo` object, using the specified block path, and sets the output port index to 1.

`signal_logging_override_object = Simulink.SimulationData.SignalLoggingInfo(path, port)` creates a `Simulink.SimulationData.LoggingInfo` object that contains default logging settings for the specified block path and output port index.

Examples

The following example creates a `Simulink.SimulationData.SignalLoggingInfo` object for the first output port of the `Bus Creator` block in the `sldemo_mdref_bus` model.

```
sldemo_mdref_bus;
mi = Simulink.SimulationData.ModelLoggingInfo(...
'sldemo_mdref_bus');
mi.LoggingMode = 'OverrideSignals';
mi.Signals = ...
    Simulink.SimulationData.SignalLoggingInfo(...
        {'sldemo_mdref_bus/CounterA', ...
'sldemo_mdref_counter_bus/Bus Creator'}, 1)
```

The output is:

```
mi =
    Data.ModelLoggingInfo with properties:
        Model: 'sldemo_mdref_bus'
        LoggingMode: 'OverrideSignals'
        LogAsSpecifiedByModels: {}
        Signals: [1x1 Simulink.SimulationData.SignalLoggingInfo]

Methods
```

See Also

`Simulink.SimulationData.ModelLoggingInfo` | `Simulink.SimulationData.LoggingInfo` | `Simulink.SimulationData.BlockPath` | `Simulink.SimulationData.Signal` | `Simulink.SimulationData.DataStoreMemory`

Topics

“Override Signal Logging Settings from MATLAB”

“Export Signal Data Using Signal Logging”

“Log Data Stores”

Introduced in R2012b

Simulink.SimulationData.Signal

Container for signal logging information

Description

Simulink uses `Simulink.SimulationData.Signal` objects to store signal logging information during simulation. The objects contain information about the source block for the signal, including the port type and index.

Property Summary

| Name | Description |
|------------------------------|--|
| BlockPath on page 5-559 | Block path for the source block for the signal |
| Name on page 5-559 | Name of signal element to use for name-based access |
| PropagatedName on page 5-559 | Propagated signal name, if any |
| PortIndex on page 5-560 | Numeric index of port that was logged |
| PortType on page 5-560 | Type of port that was logged: for signal logging, the port type is 'outport' |
| Values on page 5-560 | Time and data that were logged |

Properties

BlockPath

Description

Block path for the source block for the signal

Data Type

`Simulink.SimulationData.BlockPath`

Access

RW

Name

Description

Name of signal element to use for name-based access

Data Type

character vector

Access

RW

PropagatedName**Description**

Propagated name of signal element

Signal logging and root Output block logging data for a signal captures the propagated signal name if the logging format is `Dataset` and:

- For signal logging, you:
 - Mark the signal for signal logging and in the Signal Properties dialog box select **Show Propagated Signals**.
 - Enable **Configuration Parameters > Data Import/Export > Signal logging**.
- For root Output block logging, you select **Configuration Parameters > Data Import/Export > Output**.

The propagated signal name does not include angle brackets (<>).

Data Type

character vector

Access

R0

PortIndex**Description**

Numeric index of port that was logged

Data Type

scalar real integer

Access

RW

PortType**Description**

Type of port that was logged: for signal logging, the port type is 'outport'

Data Type

character vector

Access

RW

Values**Description**

Time and data that were logged.

For an example of how to use the `Values` property and plot logged signal data, see “Logging Intervals” on page 13-356.

Data Type

- MATLAB `timeseries` object
- Structure of MATLAB `timeseries` objects (for bus signals)
- Array of structures of MATLAB `timeseries` objects (for array of buses signals)
- Array of MATLAB `timeseries` objects (for nonbus signals in a For Each subsystem)
- MATLAB `timetable` object
- Structure of MATLAB `timetable` objects (for bus signals)
- Array of structures of MATLAB `timetable` objects (for array of buses signals)
- Cell array of MATLAB `timetable` objects (for nonbus signals in a For Each subsystem)

Access

RW

See Also

`Simulink.BlockPath` | `Simulink.SimulationData.Dataset` | `timeseries` | `plot` | `extractTimetable`

Topics

“View and Access Signal Logging Data”

“Loading MATLAB Timeseries Data to Root-Level Inputs”

“Load Bus Data to Root-Level Input Ports”

“Log Signals in For Each Subsystems”

Simulink.SimulationData.State class

Package: Simulink.SimulationData

State logging element

Description

Simulink uses `Simulink.SimulationData.State` objects to store state logging information during simulation. The objects contain state information about which block the state data is coming from and the type of state.

Properties

Name — Name of state element to use for name-based access

character vector

Name of state element to use for name-based access, specified as a character vector. If you do not specify a name, 'CSTATE' or 'DSTATE' is used, depending on whether it is a continuous or discrete state.

BlockPath — Block path for state source block

a `Simulink.SimulationData.BlockPath` object

Block path for state source block, specified as a `Simulink.SimulationData.BlockPath` object

Label — Type of state

'CSTATE' | 'DSTATE'

Type of state, returned as 'CSTATE' or 'DSTATE'. Read-only property.

- 'CSTATE' - Continuous state
- 'DSTATE' - Discrete state

Values — State element information

single MATLAB timeseries object | a structure of MATLAB timeseries objects

State element information, specified as a single MATLAB timeseries object or as a structure of MATLAB timeseries objects.

Methods

`plot` Plot simulation output data in the Simulation Data Inspector

Examples

Access Final State Information Saved Using the Dataset Format

This example shows how to save final state information using the Dataset format and then access the state data after simulation.

Load the model `vdp` and configure the model to log final states using the Dataset format. This example uses the default final states variable name, `xFinal`.

```
load_system('vdp');
set_param('vdp', 'SaveFinalState', 'on', 'SaveFormat', 'Dataset');
```

Simulate the model.

```
out = sim('vdp');
```

By default, models create a single simulation output that contains all logged data in a `Simulink.SimulationOutput` object. Get the `xFinal` Dataset object from the `SimulationOutput` object. The `xFinal` Dataset object contains data for two states.

```
xFinal = get(out, 'xFinal')
```

```
xFinal =
Simulink.SimulationData.Dataset 'xFinal' with 2 elements
```

| | | Name | BlockPath |
|---|-------------|------|-----------|
| 1 | [1x1 State] | '' | vdp/x1 |
| 2 | [1x1 State] | '' | vdp/x2 |

- Use braces `{ }` to access, modify, or add elements using index.

Examine the data for the state that corresponds to the `x1` block.

```
state_x1 = get(xFinal,1)
```

```
state_x1 =
Simulink.SimulationData.State
Package: Simulink.SimulationData

Properties:
  Name: ''
  BlockPath: [1x1 Simulink.SimulationData.BlockPath]
  Label: CSTATE
  Values: [1x1 timeseries]
```

Methods, Superclasses

See Also

`Simulink.SimulationData.Dataset`

Topics

“State Information”

Introduced in R2015a

Simulink.SimulationData.Unit class

Package: Simulink.SimulationData

Store units for simulation data

Description

Simulink creates `Simulink.SimulationData.Unit` objects to store unit information for signals when:

- Performing signal logging, which uses the `Dataset` format
- Logging root Output blocks, if in **Configurations Parameters** you select the **Output** parameter and set **Format** to `Dataset`
- Logging to a To Workspace block or To File block, if you set the **Save format** block parameter to the default of `Timeseries`

Construction

`unitsObj = Simulink.SimulationData.Unit(unitName)` creates a `Simulink.SimulationData.Unit` object with the unit that you specify.

Input Arguments

unitName — Name of logging data units

character vector

Name of logging data units, specified as a character vector.

Output Arguments

unitObj — Logging data units

`Simulink.SimulationData.Unit` object

Logging data units, returned as a `Simulink.SimulationData.Unit` object.

Properties

Name — Name of the units

character vector

Name of the units, specified as a character vector.

Methods

| Method | Purpose |
|----------------------|-----------------------------------|
| <code>setName</code> | Specify name of logging data unit |

Copy Semantics

Value. To learn how value classes affect copy operations, see Copying Objects.

Examples

Create and Use Inches Logging Units

Create a `Simulink.SimulationData.Unit` object representing inches.

```
inchesUnit = Simulink.SimulationData.Unit('inches');
```

Create a MATLAB timeseries object and set its `Units` field to the `Simulink.SimulationData.Unit` object.

```
ts = timeseries(1:10);  
ts.DataInfo.Units = inchesUnit;  
ts.DataInfo.Units
```

```
ans =
```

```
Units with properties:
```

```
    Name: 'inches'
```

See Also

`Simulink.SimulationData.Dataset`

Topics

- “Log Signal Data That Uses Units”
- “Load Signal Data That Uses Units”
- “Convert Logged Data to Dataset Format”
- “Prepare Model Inputs and Outputs”

Introduced in R2016a

Simulink.SimulationInput class

Package: Simulink

Creates SimulationInput objects to make changes to a model for multiple or individual simulations

Description

The Simulink.SimulationInput object allows you to make changes to a model and run simulations with those changes. These changes are temporarily applied to the model. Through Simulink.SimulationInput object, you can change:

- Initial state
- Model parameters
- Block parameters
- External inputs
- Variables

Through the Simulink.SimulationInput object, you can also specify MATLAB functions to run at the start and the end of each simulation by using `in.setPreSimFcn` and `in.setPostSimFcn`, respectively.

Construction

`in = Simulink.SimulationInput('modelName')` creates a SimulationInput object for a model.

Input Arguments

modelName — Name of the model

character vector

Create a Simulink.SimulationInput object by passing the name of the model as an argument.

Example: `in = Simulink.SimulationInput('cstr')`

Properties

modelName — Name of the model

character vector

Name of the model for which the SimulationInput object is created.

InitialState — Initial state

Simulink.op.ModelOperatingPoint object

Initial state of the model for a simulation specified as a Simulink.op.ModelOperatingPoint object.

ExternalInput — External Input

numerical array, dataset object, timeseries, character array

External inputs added to the model for a simulation.

BlockParameters – Block parameters

array of `Simulink.Simulation.BlockParameter`

Block parameters of the model that are modified.

Variables – Variables

array of `Simulink.Simulation.Variable`

Variables of the model that are modified.

ModelParameters – Model parameters

array of `Simulink.Simulation.ModelParameter`

Model parameters of the model that are modified.

PreSimFcn – Function

MATLAB function

MATLAB function to run before the start of the simulation.

PostSimFcn – Function

MATLAB function

MATLAB function to run after each simulation.

UserString – User string

character array

Brief description of the simulation specified as a character array.

Methods

| Method | Purpose |
|--------------------------------|---|
| <code>setModelParameter</code> | Set model parameters to be used for a specific simulation through <code>SimulationInput</code> object. |
| <code>setBlockParameter</code> | Set block parameters to be used for a specific simulation through <code>SimulationInput</code> object. |
| <code>setInitialState</code> | Set initial state to be used for a specific simulation through <code>SimulationInput</code> object. |
| <code>setExternalInput</code> | Set external inputs for a simulation through <code>SimulationInput</code> object. |
| <code>setVariable</code> | Set variables for a simulation through <code>SimulationInput</code> object. |
| <code>setPreSimFcn</code> | Specify a MATLAB function to run before start of each simulation through <code>SimulationInput</code> object. |
| <code>setPostSimFcn</code> | Specify a MATLAB function to run after each simulation is complete through <code>SimulationInput</code> object. |

| Method | Purpose |
|---------------------------------------|---|
| <code>applyToModel</code> | Apply changes to the model specified through a <code>SimulationInput</code> object. |
| <code>validate</code> | Validate the contents of the <code>SimulationInput</code> object. |
| <code>loadVariablesFromMATFile</code> | Load variables from MAT-file into a <code>Simulink.SimulationInput</code> object. |

Examples

Create a `Simulink.SimulationInput` Object

This example shows you how to create a `SimulationInput` object.

Open the model.

```
openExample('simulink/OpenTheModelExample');
open_system('ex_sldemo_househeat');
load_system('ex_sldemo_househeat')
```

Create a single `SimulationInput` object for a model.

```
model = 'ex_sldemo_househeat';
in = Simulink.SimulationInput(model);
```

Create an Array of `Simulink.SimulationInput` Objects

This example shows you how to create an array of `SimulationInput` objects.

Create an array of `SimulationInput` objects by using the for loop.

```
model = 'vdp';
for i = 10:-1:1
    in(i) = Simulink.SimulationInput(model);
end
```

Set Block Parameters using an Array of `Simulink.SimulationInput` Objects

This example modifies the block parameters of a model through the `SimulationInput` object.

Open the model.

```
openExample('simulink/OpenTheModelExample');
open_system('ex_sldemo_househeat');
load_system('ex_sldemo_househeat')
```

Create a `SimulationInput` object for this model.

```
mdl = 'sldemo_househeat';
in = Simulink.SimulationInput(mdl);
```

Modify block parameter.

```
in = in.setBlockParameter('ex_sldemo_househeat/Set Point', 'Value', '300');
```

Simulate the model.

```
out = sim(in)
```

Use Dataset as External Inputs with a Simulink.SimulationInput Objects

This example shows how use Dataset objects to set external inputs with Simulink.SimulationInput objects.

Open the model

```
mdl = 'sldemo_mdlref_counter';  
open_system(mdl);
```

Create a Dataset object for this model.

```
t = (0:0.01:10)';  
ds = Simulink.SimulationData.Dataset;  
ds = ds.setElement(1, timeseries(5*ones(size(t)),t)); % First element  
ds = ds.setElement(2, timeseries(10*sin(t),t)); % Second element  
ds = ds.setElement(3, timeseries(-5*ones(size(t)),t)); % Third element
```

Create a Simulink.SimulationInput object and set the external inputs

```
in = Simulink.SimulationInput('sldemo_mdlref_counter');  
in = in.setExternalInput('ds.getElement(1)',ds.getElement(2),ds.getElement(3)');
```

Add other remaining variables in the expressions. Ensure that the dataset is also on the SimulationInput object.

Simulate the model.

```
in = in.setVariable('ds',ds);
```

Simulate the model

```
out = parsim(in)
```

See Also

[Simulink.SimulationInput](#) | [parsim](#) | [applyToModel](#) | [setModelParameter](#) | [setBlockParameter](#) | [setInitialState](#) | [setExternalInput](#) | [setVariable](#) | [validate](#) | [setPreSimFcn](#) | [setPostSimFcn](#) | [loadVariablesFromMATFile](#) | [Simulation Manager](#)

Topics

“Running Multiple Simulations”

“Run Parallel Simulations for a Thermal Model of a House Using parsim”

Introduced in R2017a

applyToModel

Apply changes to the model specified through a `SimulationInput` object, `in`

Syntax

```
in.applyToModel
in.applyToModel('EnableConfigSetRefUpdate', 'on')
```

Description

`in.applyToModel` applies the changes specified through the `SimulationInput` object to the model. You can use it to debug a model or to interactively analyze a simulation.

`in.applyToModel('EnableConfigSetRefUpdate', 'on')` applies the changes specified through the `SimulationInput` object to the model. You can use it to debug a model or to interactively analyze a simulation.

Examples

Apply Changes Made Through the `Simulink.SimulationInput` Object to the Model

This example shows how to modify a model through a `SimulationInput` object and save those modifications.

Open the model and create a `SimulationInput` object.

```
open_system('sldemo_househeat');
in = Simulink.SimulationInput('sldemo_househeat');
```

Modify block parameter, model parameters and a variable through `SimulationInput` object.

```
in = in.setBlockParameter('sldemo_househeat/Set Point', 'Value', '75');
in = in.setVariable('cost', 50, 'Workspace', 'sldemo_househeat');
in = in.setModelParameter('StartTime', '1', 'StopTime', '5');
```

Apply the modifications made in the above step to the model.

```
in.applyToModel
```

Input Arguments

'EnableConfigSetRefUpdate' — Enables `ConfigSetRef` parameter to be updated in the `Simulink.SimulationInput` object

'off' (default) | 'on'

Specify `EnableConfigSetRefUpdate` flag to 'on' to apply the `ConfigSetRefs` settings to the `Simulink.SimulationInput` object, for the model that uses reference config sets.

See Also

`Simulink.SimulationInput` | `parsim` | `setBlockParameter` | `setModelParameter` | `setInitialState` | `setExternalInput` | `setVariable` | `validate` | `setPreSimFcn` | `setPostSimFcn` | `loadVariablesFromMATFile` | `Simulation Manager`

Topics

“Running Multiple Simulations”

“Run Parallel Simulations for a Thermal Model of a House Using `parsim`”

Introduced in R2017a

Simulink.Simulation.BlockParameter class

Package: Simulink.Simulation

Block parameters in Simulink.SimulationInput objects

Description

The `Simulink.Simulation.BlockParameter` object specifies the block parameter, path of the block, and the value of the block parameter used by the `Simulink.SimulationInput` object during simulation.

In most cases, there is no need to create an object of this class directly. It is recommended that you use the `setBlockParameter` method on the `Simulink.SimulationInput` object to add a block parameter to the `Simulink.SimulationInput` object.

Creation

`bp = Simulink.Simulation.BlockParameter('BlockPath', 'Name', 'Value')` creates a `Simulink.Simulation.BlockParameter` object, `bp`, that specifies the block parameter, `Name`, with a `Value` on its path, `BlockPath`.

Properties

BlockPath — Path of the block

character vector

Path of the block, specified as a character vector.

Name — Name of the block parameter

character vector

Name of the block parameter, specified as a character vector.

Value — Value of the block parameter

character vector

Value of the block parameter, specified as a character vector.

See Also

`Simulink.SimulationInput` | `parsim` | `applyToModel` | `setModelParameter` | `setInitialState` | `setExternalInput` | `setVariable` | `validate` | `setPreSimFcn` | `setPostSimFcn` | `loadVariablesFromMATFile` | Simulation Manager

Topics

“Running Multiple Simulations”

“Run Parallel Simulations for a Thermal Model of a House Using `parsim`”

Introduced in R2020a

Simulink.Simulation.Variable class

Package: Simulink.Simulation

Variables in Simulink.SimulationInput objects

Description

The Simulink.Simulation.Variables object specifies the variable and its value used by the Simulink.SimulationInput object during simulation. By default, this object overrides variables that already exist in the base workspace or the data dictionary.

In most cases, there is no need to create an object of this class directly. To add a variable to the Simulink.SimulationInput object use the setVariable method on the Simulink.SimulationInput object.

Creation

`var = Simulink.Simulation.Variable(variableName,Value)` creates a Simulink.Simulation.Variables object, `var`, that specifies the variable and its value.

`var = Simulink.Simulation.Variable(variableName,Value,'Workspace',WorkspaceName)` creates a Simulink.Simulation.Variables object, `var`, that specifies the variable defined in the specified workspace, `WorkspaceName` and its value. `Workspace` can either be a model's name to indicate that the variable is in a model workspace or 'global-workspace' to indicate that it is either in the base workspace or in a data dictionary.

Properties

variableName — Name of the variable

character vector

Name of the variable, specified as a character vector.

Value — Value of the variable

character vector

Value of the variable, specified as a character vector.

WorkspaceName — Name of the variable

character vector

Name of the workspace that the variable is defined in, specified as a character vector.

See Also

Simulink.SimulationInput | parsim | applyToModel | setModelParameter | setInitialState | setExternalInput | setVariable | validate | setPreSimFcn | setPostSimFcn | loadVariablesFromMATFile | Simulation Manager

Topics

“Running Multiple Simulations”

“Run Parallel Simulations for a Thermal Model of a House Using parsim”

Introduced in R2020a

showContents

View the contents of the `Simulink.SimulationInput` object

Syntax

```
showContents(in)
```

Description

`showContents(in)` displays the contents of the `Simulink.SimulationInput` object as a table. The method, `showContents`, lets you view all the information such as block parameters, variables, model parameters, external Inputs and the initial states that are set in the `Simulink.SimulationInput` object. You can view the contents of a single `Simulink.SimulationInput` object at a given time.

Examples

View the Contents of the `Simulink.SimulationInput` Object

This example shows the contents of the `Simulink.SimulationInput` object by using the `showContents` method on the object.

Open and Load Model

Open and load the model .

```
open_system('ex_sldemo_househeat')  
load_system('ex_sldemo_househeat')
```

Thermal Model of a House

Note: Time given in units of hours

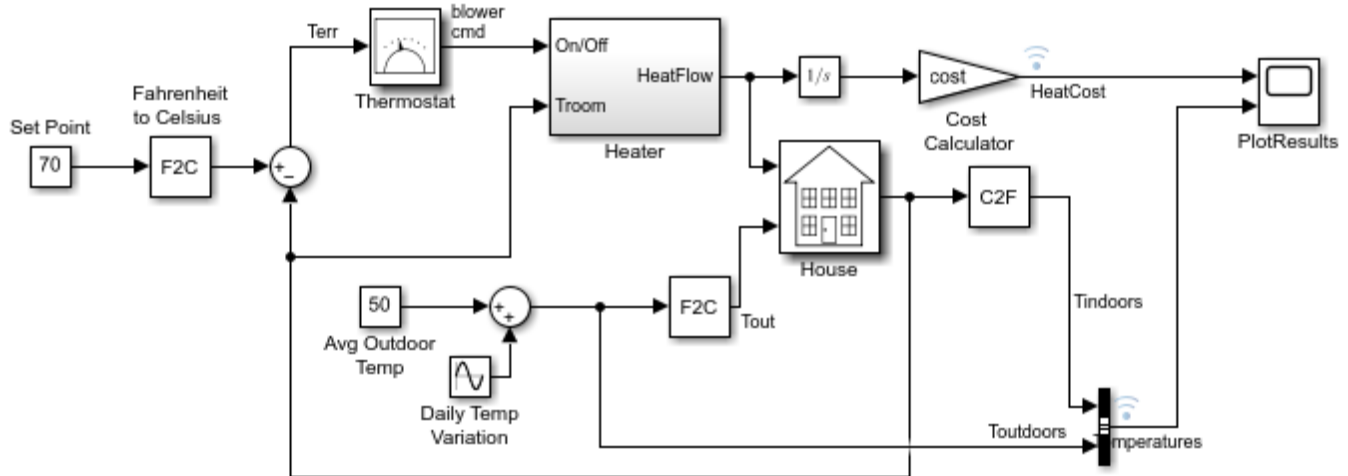

Copyright 1990-2012 The MathWorks, Inc.

Create a SimulationInput Object for a Model

Create a `Simulink.SimulationInput` object for the model `ex_sldemo_househeat`.

```
in = Simulink.SimulationInput('ex_sldemo_househeat');
```

Set a Variable and Model Parameters on the Model

```
in = in.setVariable('cost',50);
in = in.setModelParameter('Start','0','Stop','50');
```

View the Contents of the Simulink.SimulationInput Object, in

```
in.showContents
```

```
ModelName: 'ex_sldemo_househeat'
```

```
ModelParameters:
```

| Index | Name | Value |
|-------|-------|-------|
| 1 | Start | '0' |
| 2 | Stop | '50' |

```
Variables:
```

| Index | Name | Value | Workspace |
|-------|------|-------|------------------|
| 1 | cost | 50 | global-workspace |

Input Arguments

in — **Simulink.SimulationInput** object used to simulate the model
object

A `Simulink.SimulationInput` object that is used to specify changes to the model for a simulation.

See Also

`Simulink.SimulationInput` | `parsim` | `applyToModel` | `setBlockParameter` | `setModelParameter` | `setInitialState` | `setExternalInput` | `validate` | `setPreSimFcn` | `setPostSimFcn` | `loadVariablesFromMATFile` | `Simulation Manager`

Topics

“Running Multiple Simulations”

“Run Parallel Simulations for a Thermal Model of a House Using `parsim`”

Introduced in R2020a

removeVariable

Remove a variable from a `Simulink.SimulationInput` object or an array of `Simulink.SimulationInput` objects

Syntax

```
in = in.removeVariable('VariableName')
in = in.removeVariable('VariableName', 'Workspace', 'ModelName')
```

Description

`in = in.removeVariable('VariableName')` removes all the variables with the name `VariableName` from the `Simulink.SimulationInput` object.

`in = in.removeVariable('VariableName', 'Workspace', 'ModelName')` removes variable specified in base and model workspace by `ModelName` from the `Simulink.SimulationInput` object.

Examples

Modify and Remove a Variable for a Simulation

This example modifies the model parameters through the `SimulationInput` object.

Open the model.

```
openExample('simulink/OpenTheModelExample');
open_system('ex_sl_demo_househeat');
```

Create a `SimulationInput` object for this model

```
in = Simulink.SimulationInput mdl;
```

Set the variable value to 50.

```
in = in.setVariable('cost',50);
```

By default, this variable is placed in the global workspace scope.

Assume that you added the variable accidentally and want to remove it

```
in = in.removeVariable('cost');
```

Input Arguments

'VariableName' — Name of variable

string

Name of the variable present in the `Simulink.SimulationInput` object

Example: 'Gain'

'Workspace' — Workspace for the variable

character vector

Set the scope of the variable by specifying the workspace.

Example: 'Workspace', 'sldemo_househeat'

See Also

[Simulink.SimulationInput](#) | [parsim](#) | [applyToModel](#) | [setBlockParameter](#) | [setModelParameter](#) | [setInitialState](#) | [setExternalInput](#) | [validate](#) | [setPreSimFcn](#) | [setPostSimFcn](#) | [loadVariablesFromMATFile](#) | [Simulation Manager](#)

Topics

["Running Multiple Simulations"](#)

["Run Parallel Simulations for a Thermal Model of a House Using parsim"](#)

Introduced in R2019a

setExternalInput

Set external inputs for a simulation through `SimulationInput` object, `in`

Syntax

```
in = in.setExternalInput([t, u1,..uN])
in = in.setExternalInput(ds)
in = in.setExternalInput(ts)
```

Description

`in = in.setExternalInput([t, u1,..uN])` allows you to directly specify numerical arrays as inputs to a model if a model has root inports.

`in = in.setExternalInput(ds)` allows you to directly specify dataset objects as external inputs to a model if a model has root inports.

`in = in.setExternalInput(ts)` allows you to directly specify timeseries object as external input if a model has a single root inport.

Examples

Set Numerical Arrays as External Inputs Through a `Simulink.SimulationInput` Object

This example shows how to set numerical arrays as external inputs.

Open the model

```
open_system('sldemo_mdlref_counter');
```

Create a `SimulationInput` object for this model.

```
in = Simulink.SimulationInput('sldemo_mdlref_counter');
```

Prepare external inputs.

```
t = (0:0.01:10)';
u1 = 5*ones(size(t));
u2 = 10*sin(t);
u3 = -5*ones(size(t));
```

Set external inputs to the model.

```
in = in.setExternalInput([t, u1, u2, u3]);
```

Simulate the model.

```
out = sim(in);
```

Input Arguments

[t, u1, ..uN] – Numerical array

numerical array

Numerical array to be used as an external input.

ds – Dataset object

`Simulink.SimulationData.Dataset` object

Dataset object to be used as an external input

ts – Time series

time object handle

Time series to be used as an external input

See Also

`Simulink.SimulationInput` | `parsim` | `applyToModel` | `setBlockParameter` | `setModelParameter` | `setInitialState` | `setVariable` | `validate` | `setPostSimFcn` | `setPreSimFcn` | `loadVariablesFromMATFile` | Simulation Manager

Topics

“Running Multiple Simulations”

“Run Parallel Simulations for a Thermal Model of a House Using `parsim`”

Introduced in R2017a

setPostSimFcn

Package: Simulink

Specify a MATLAB function to run after each simulation is complete through `SimulationInput` object, `in`

Syntax

```
in = in.setPostSimFcn(@(y) myfunction(arg1, arg2 ...))
```

Description

`in = in.setPostSimFcn(@(y) myfunction(arg1, arg2 ...))` runs after each simulation is complete. The `Simulink.SimulationOutput` object is passed as the argument `y` to this function. `myfunction` is any MATLAB function and can be used to do the post processing on the output. To return post processed data, you must return it as values in a struct. These values are then packed into the `Simulink.SimulationOutput` output to replace the usual logged data or add new data to the `Simulink.SimulationOutput` object.

Examples

Specify a MATLAB function for Postprocessing of the Output

This example specifies a MATLAB Function through `SimulationInput` object to run after each simulation is complete.

Create a `PostSimFcn` to get the mean of the output.

```
function newout = postsim(out);  
newout.mean = mean(out.yout);  
end
```

Create a `SimulationInput` object for a model.

```
in = Simulink.SimulationInput('vdp');  
in = in.setPostSimFcn(@(x) postsim(x));  
in = in.setModelParameter('SaveOutput','on');
```

Simulate the model.

```
out = sim(in)
```

View your result

```
out.mean
```

It is best practice to avoid using 'ErrorMessage' and 'SimulationMetadata' as field names in the function.

Input Arguments

y — Copy of Simulink.SimulationOutput object for postprocessing

Simulink.SimulationOutput object

This is a Simulink.SimulationOutput object which is an input to myfunction.

arg1, arg2 ... — Function arguments

character vectors object

Arguments specified to pass to the setPostSimFcn.

See Also

Simulink.SimulationInput | parsim | applyToModel | setBlockParameter | setModelParameter | setInitialState | setExternalInput | setVariable | validate | setPreSimFcn | loadVariablesFromMATFile | Simulation Manager

Topics

“Running Multiple Simulations”

“Run Parallel Simulations for a Thermal Model of a House Using parsim”

Introduced in R2017a

setPreSimFcn

Specify a MATLAB function to run before start of each simulation through `SimulationInput` object, `in`

Syntax

```
in = in.setPreSimFcn(@(x) myfunction(arg1, arg2 ...))
```

Description

`in = in.setPreSimFcn(@(x) myfunction(arg1, arg2 ...))` runs before each simulation starts. The `Simulink.SimulationInput` object is passed as an argument `x` to this function. `myfunction` is any MATLAB function and can be used to modify the `Simulink.SimulationInput` object. If you use `myfunction` to modify the `Simulink.SimulationInput` object, you must return `Simulink.SimulationInput` object as the only output argument.

Input Arguments

x — A `Simulink.SimulationInput` object as input to the `myfunction`

`Simulink.SimulationInput` object

This is an input to `myfunction` in which you can modify the `Simulink.SimulationInput` object.

arg1, arg2 ... — Function arguments

character vectors object

Arguments specified to pass to the `setPreSimFcn`.

See Also

`Simulink.SimulationInput` | `parsim` | `applyToModel` | `setBlockParameter` | `setModelParameter` | `setInitialState` | `setExternalInput` | `setVariable` | `validate` | `setPostSimFcn` | `loadVariablesFromMATFile` | `Simulation Manager`

Topics

“Parallel Simulations Using `Parsim`: Test-Case Sweep” on page 13-595

“Running Multiple Simulations”

“Run Parallel Simulations for a Thermal Model of a House Using `parsim`”

Introduced in R2017a

setBlockParameter

Set block parameters to be used for a specific simulation through `SimulationInput` object, `in`

Syntax

```
in = in.setBlockParameter('BlockPath','ParameterName','Value',... 'BlockPathN'
'ParameterNameN','ValueN')
```

Description

`in = in.setBlockParameter('BlockPath','ParameterName','Value',... 'BlockPathN' 'ParameterNameN','ValueN')` sets the parameter on the block specified at `BlockPath` with the properties `ParameterName` and `Value`. You can use the `setBlockParameter` method to specify block parameters in model reference hierarchy. You can set multiple block parameters in a model using the same `SimulationInput` object.

You can use `getBlockParameter('BlockPath','ParameterName')` method to get the value of block parameter and the `removeBlockParameter('BlockPath','ParameterName')` method to remove block parameter from the `Simulink.SimulationInput` object.

Examples

Modify a Block Parameter for a Simulation

This example modifies the block parameters of a model through the `SimulationInput` object.

Open the model

```
mdl = 'sldemo_househeat';
open_system(mdl);
```

Create a `SimulationInput` object for this model.

```
in = Simulink.SimulationInput(mdl);
```

Modify block parameter.

```
in = in.setBlockParameter('sldemo_househeat/Set Point','Value','300');
```

Simulate the model.

```
out = sim(in)
```

Modify Multiple Block Parameters for a Simulation

This example modifies the block parameters of a model through the `SimulationInput` object.

Open the model

```
mdl = 'vdp';  
open_system(mdl);
```

Create a `SimulationInput` object for this model.

```
in = Simulink.SimulationInput(mdl);
```

Modify block parameter.

```
in = in.setBlockParameter('vdp/Mu','Gain','40','vdp/Product','Position',[50 100 110 120]);
```

Simulate the model.

```
out = sim(in)
```

Input Arguments

'BlockPath' — Path of the block

character vector

BlockPath is the path of the block for which the parameter is changed

Example: 'sldemo_househeat/Set Point'

'ParameterName' — Block parameter name

character vector

Specify optional comma-separated pairs of `ParameterName,Value` arguments. `ParameterName` is the parameter name and `Value` is the corresponding value. `ParameterName` must appear inside single quotes (' '). Block parameter values are typically specified as character vectors. You can specify several name and value pair arguments in any order as `Name1,Value1,...,NameN,ValueN`. `ParameterNameN,ValueN` pairs follow the same syntax as `set_param`.

Example: 'Value', '350'

See Also

`Simulink.SimulationInput` | `parsim` | `applyToModel` | `setModelParameter` | `setInitialState` | `setExternalInput` | `setVariable` | `validate` | `setPreSimFcn` | `setPostSimFcn` | `loadVariablesFromMATFile` | `Simulation Manager`

Topics

"Running Multiple Simulations"

"Run Parallel Simulations for a Thermal Model of a House Using `parsim`"

Introduced in R2017a

setInitialState

Set initial state to be used for a specific simulation through `SimulationInput` object, `in`

Syntax

```
in = in.setInitialState(xInitial)
```

Description

`in = in.setInitialState(xInitial)` sets the initial state of a model to `xInitial`, a valid initial state.

Input Arguments

xInitial — Valid initial state

`Simulink.op.ModelOperatingPoint` | structure

You can change the `Initial State` of a model by assigning it to a `Simulink.op.ModelOperatingPoint` object, a structure or a structure with time format.

See Also

`setPostSimFcn` | `Simulink.SimulationInput` | `parsim` | `applyToModel` |
`setBlockParameter` | `setModelParameter` | `setExternalInput` | `setVariable` | `validate` |
`setPreSimFcn` | `loadVariablesFromMATFile` | `Simulation Manager`

Topics

“Running Multiple Simulations”

“Run Parallel Simulations for a Thermal Model of a House Using `parsim`”

Introduced in R2017a

setModelParameter

Set model parameters to be used for a specific simulation through `SimulationInput` object, in

Syntax

```
in = in.setModelParameter('ParameterName', 'Value', ... 'ParameterNameN',  
'ValueN')
```

Description

`in = in.setModelParameter('ParameterName', 'Value', ... 'ParameterNameN', 'ValueN')` sets a model parameter `Name` with a `Value`. You can add multiple model parameters to the model using the same `SimulationInput` object.

You can use `getModelParameter('ParameterName')` method to get the value of model parameter and the `removeModelParameter('ParameterName')` method to remove model parameter from the `Simulink.SimulationInput` object.

Examples

Modify a Model Parameter for a Simulation

This example modifies the model parameters of through the `SimulationInput` object

Open the model.

```
mdl = 'sldemo_househeat';  
open_system(mdl);
```

Create a `SimulationInput` object for this model.

```
in = Simulink.SimulationInput(mdl);
```

Specify a timeout of 5 seconds and modify model parameters, `StartTime` and `StopTime`

```
in = in.setModelParameter('Timeout',5);  
in = in.setModelParameter('StartTime','1','StopTime','4');
```

Simulate the model.

```
out = sim(in)
```

Input Arguments

'ParameterName', 'Value', ... 'ParameterNameN', 'ValueN' — Block parameter name character vector

Specify optional comma-separated pairs of `ParameterName`, `Value` arguments. `ParameterName` is the parameter name and `Value` is the corresponding value. `ParameterName` must appear inside single quotes (' '). Model parameter values are typically specified as character vectors. You can

specify several name and value pair arguments in any order as `Name1, Value1, ..., NameN, ValueN`. `ParameterNameN, ValueN` pairs follow the same syntax as `set_param`.

Example: `'StartTime', '1'`

See Also

`Simulink.SimulationInput` | `parsim` | `applyToModel` | `setBlockParameter` | `setInitialState` | `setExternalInput` | `setVariable` | `validate` | `setPreSimFcn` | `setPostSimFcn` | `loadVariablesFromMATFile` | `Simulation Manager`

Topics

“Running Multiple Simulations”

“Run Parallel Simulations for a Thermal Model of a House Using `parsim`”

Introduced in R2017a

setVariable

Set variables for a simulation through `SimulationInput` object, `in`

Syntax

```
in = in.setVariable('Name', 'Value')
in = in.setVariable('Name', 'Value', 'Workspace', 'ModelName')
```

Description

`in = in.setVariable('Name', 'Value')` assigns a `Value` to variable `Name`. You can add multiple variables to the model using the same `SimulationInput` object.

`in = in.setVariable('Name', 'Value', 'Workspace', 'ModelName')` assigns the `Value` to variable `Name`. Variables that are defined through the `SimulationInput` object are placed in the global workspace scope by default. The term global workspace is specific to the `Simulink.SimulationInput` object and its methods. Variables in the global workspace scope take precedence if a variable with the same name exists in the base workspace or the data dictionary. The variables in the model workspace take precedence over the global workspace scope. To change the value of a model workspace variable, set the scope by specifying the model name when you add the variable to the `SimulationInput` object.

While using the `setVariable` method, you can specify only one variable at a time.

You can use `getVariable('VariableName')` method to get the value of variable and the `removeVariable('VariableName')` method to remove variable from the `Simulink.SimulationInput` object

For information on using nonscalar variables, structure variables and parameter objects, see “Sweep Nonscalars, Structures, and Parameter Objects”.

Examples

Modify a Variable for a Simulation

This example modifies the model parameters of through the `SimulationInput` object.

Open the model.

Open the model.

```
openExample('simulink/OpenTheModelExample');
open_system('ex_sl-demo_househeat');
load_system('ex_sl-demo_househeat')
```

Create a `SimulationInput` object for this model

```
in = Simulink.SimulationInput('ex_sl-demo_househeat');
```

Set the variable value to 50.

```
in = in.setVariable('cost',50);
```

By default, this variable is placed in the global workspace scope.

Simulate the model.

```
out = sim(in)
```

Modify a Variable for a Simulation in the Model Workspace

This example modifies the model parameters of `sldemo_househeat` through the `SimulationInput` object.

Set path and open the model.

```
openExample('simulink/OpenTheModelExample');
open_system('ex_sldemo_househeat');
load_system('ex_sldemo_househeat')
```

Create a `SimulationInput` object for this model

```
in = Simulink.SimulationInput('ex_sldemo_househeat');
```

Set the variable to 50 and set the scope to model workspace.

```
in = in.setVariable('cost',50,'Workspace','ex_sldemo_househeat');
```

Simulate the model.

```
out = sim(in)
```

Input Arguments

'Name', 'Value' — Block parameter name

character vector

Specify optional comma-separated pairs of `Name`, `Value` arguments. `Name` is the argument name and `Value` is the literal value of the variable. `Name` must appear inside single quotes (' ').

Example: 'StartTime','1'

'Workspace' — Workspace for the variable

character vector

Set the scope of the defined variable by specifying the model name

Example: 'Workspace','sldemo_househeat'

See Also

`Simulink.SimulationInput` | `parsim` | `applyToModel` | `setBlockParameter` | `setModelParameter` | `setInitialState` | `setExternalInput` | `validate` | `setPreSimFcn` | `setPostSimFcn` | `loadVariablesFromMATFile` | `Simulation Manager`

Topics

“Running Multiple Simulations”

“Run Parallel Simulations for a Thermal Model of a House Using parsim”

Introduced in R2017a

validate

Validate the contents of the `SimulationInput` object, `in`

Syntax

```
in.validate
```

Description

`in.validate` validates the changes made to the model through the `SimulationInput` object. This method validates all the changes made to the model through the `SimulationInput` object.

Examples

Validate Changes Made Through the SimulationInput Object

This example modifies and validates the variable of the model through the `SimulationInput` object.

Open the model.

```
openExample('simulink/OpenTheModelExample');  
mdl = 'sldemo_househeat';  
open_system(mdl);
```

Create a `SimulationInput` object for this model

```
in = Simulink.SimulationInput(mdl);
```

Modify a model parameter

```
in = in.setModelParameter('InvalidParamName','5');
```

Validate this change

```
in.validate
```

See Also

`Simulink.SimulationInput` | `parsim` | `applyToModel` | `setBlockParameter` | `setModelParameter` | `setInitialState` | `setExternalInput` | `setVariable` | `setPreSimFcn` | `setPostSimFcn` | `loadVariablesFromMATFile` | `Simulation Manager`

Topics

“Running Multiple Simulations”

“Run Parallel Simulations for a Thermal Model of a House Using `parsim`”

Introduced in R2017a

loadVariablesFromMATFile

Load variables from MAT-file into a `Simulink.SimulationInput` object, `in`

Syntax

```
in = in.loadVariablesFromMATFile('filename')
```

Description

`in = in.loadVariablesFromMATFile('filename')` loads variables from the specified MAT-file into the `Variables` property of `Simulink.SimulationInput`.

Examples

Load Variables From MAT-File

This example shows how to load variables from MAT-File into `Simulink.SimulationInput` object using the `loadVariablesFromMATFile` method.

Create a `Simulink.SimulationInput` Object

Create a `Simulink.SimulationInput` object for the example model.

```
mdl = 'ex_loadVar_sldemo_househeat';  
in = Simulink.SimulationInput(mdl);  
in
```

```
in =
```

```
SimulationInput with properties:
```

```
    ModelName: 'ex_loadVar_sldemo_househeat'  
    InitialState: [0x0 Simulink.op.ModelOperatingPoint]  
    ExternalInput: []  
    ModelParameters: [0x0 Simulink.Simulation.ModelParameter]  
    BlockParameters: [0x0 Simulink.Simulation.BlockParameter]  
    Variables: [0x0 Simulink.Simulation.Variable]  
    PreSimFcn: []  
    PostSimFcn: []  
    UserString: ''
```

Load Variables From MAT-File

Use the `loadVariablesFromMATFile` method of the `Simulink.SimulationInput` object.

```
in = in.loadVariablesFromMATFile('sldemo_househeat_data.mat');  
in
```

```
in =
```

SimulationInput with properties:

```

    ModelName: 'ex_loadVar_sldemo_househeat'
    InitialState: [0x0 Simulink.op.ModelOperatingPoint]
    ExternalInput: []
    ModelParameters: [0x0 Simulink.Simulation.ModelParameter]
    BlockParameters: [0x0 Simulink.Simulation.BlockParameter]
    Variables: [1x25 Simulink.Simulation.Variable]
    PreSimFcn: []
    PostSimFcn: []
    UserString: ''

```

Simulate the Model

The model uses the loaded variables for simulation

```
out = sim(in)
```

```
out =
```

```

    Simulink.SimulationOutput:
      sldemo_househeat_output: [1x1 Simulink.SimulationData.Dataset]

      SimulationMetadata: [1x1 Simulink.SimulationMetadata]
      ErrorMessage: [0x0 char]

```

Input Arguments

filename — Name of the MAT file

character vector | string scalar

Name of MAT-file, specified as a character vector or string scalar.

Example: 'myFile'

See Also

[Simulink.SimulationInput](#) | [parsim](#) | [applyToModel](#) | [setBlockParameter](#) | [setModelParameter](#) | [setInitialState](#) | [setExternalInput](#) | [setVariable](#) | [setPreSimFcn](#) | [setPostSimFcn](#) | [Simulation Manager](#)

Topics

“Running Multiple Simulations”

“Run Parallel Simulations for a Thermal Model of a House Using parsim”

Introduced in R2017a

Simulink.Simulation.Future class

Package: Simulink.Simulation

Create Future object for simulation

Description

Create a `Simulink.Simulation.Future` object when you execute `parsim` with the `'RunInBackground'` argument set to `'on'`. The `parsim` command runs multiple simulations in parallel using the inputs specified with an array of `Simulink.SimulationInput` objects. You can use this object to monitor the status of ongoing simulations, fetch outputs of completed simulations, or cancel ongoing simulations.

The `parsim` command uses the Parallel Computing Toolbox license to run the simulations in parallel. `parsim` runs the simulations in serial if a parallel pool cannot be created or if Parallel Computing Toolbox is not used.

Construction

`future = parsim(in, 'RunInBackground', 'on')` creates a `Simulink.Simulation.Future` object, `future`, while running multiple simulations in parallel using the inputs specified in the `Simulink.SimulationInput` object, `in`.

Input Arguments

in — `Simulink.SimulationInput` object array

object (default) | array

A `Simulink.SimulationInput` object or an array of `Simulink.SimulationInput` objects is used to run multiple simulations. Specify parameters and values of a model to run multiple simulations without making it dirty.

Example: `in = Simulink.SimulationInput('vdp'), in(1:10) = Simulink.SimulationInput('vdp')`

'RunInBackground' — `parsim` argument to enable `RunInBackground`

'off' (default) | 'on'

Set to `'on'`, to run simulations asynchronously, keeping the MATLAB command prompt available.

Properties

Diary — Log of outputs from the simulation

text file

Text log of outputs from the simulation.

This property is read-only.

ID — Numeric identifier of the future object

scalar integer

ID of the future object, specified as a scalar integer.

This property is read-only.

Read — Whether the outputs have been read

1 | 0

Whether a call to `fetchNext` or `fetchOutputs` has read the outputs in the `Simulink.Simulation.Future` object array, specified as 1 if true and 0 if false.

This property is read-only.

State — Current state of future object array

'pending' | 'queued' | 'running' | 'finished' | 'failed' | 'unavailable'

Current state of future object array, specified as 'pending', 'queued', 'running', 'finished', 'failed', or 'unavailable'.

This property is read-only.

Methods

| Method | Purpose |
|---------------------------|--|
| <code>cancel</code> | Cancel a pending, queued, or running <code>Simulink.Simulation.Future</code> object |
| <code>fetchNext</code> | Fetch next available unread output from <code>Simulink.Simulation.Future</code> object array |
| <code>fetchOutputs</code> | Retrieve <code>Simulink.SimulationOutput</code> from <code>Simulink.Simulation.Future</code> |
| <code>wait</code> | Wait for <code>Simulink.Simulation.Future</code> objects to complete simulation |

Examples

Create a Simulink.Simulation.Future Object

This example shows how to create a `Simulink.Simulation.Future` object array and use it to retrieve outputs and see the status of simulations.

This example runs several simulations of the `vdp` model, varying the value of the gain `Mu`.

Open the model and define a vector of `Mu` values.

```
open_system('vdp');
Mu_Values = [0.5:0.25:5];
MuVal_length = length(Mu_Values);
```

Using `Mu_Values`, initialize an array of `Simulink.SimulationInput` objects. To preallocate the array, a loop index is made to start from the largest value.

```
for i = MuVal_length:-1:1
    in(i) = Simulink.SimulationInput('vdp');
```

```
        in(i) = in(i).setBlockParameter('vdp/Mu',...  
            'Gain',num2str(Mu_Values(i)));  
end
```

Simulate the model using `parsim`. Set it to 'RunInBackground', to be able to use the command prompt, while simulations are running.

```
Future = parsim(in, 'RunInBackground', 'on');
```

Use the `fetchNext` method on Future simulations.

```
for i = 1:MuVal_length  
    [completedIdx, simOut] = fetchNext(Future)  
end
```

See Also

Functions

`parsim` | `batchsim` | `batch` | `cancel` | `fetchNext` | `fetchOutputs` | `wait`

Classes

`Simulink.SimulationInput`

Introduced in R2018a

cancel

Cancel a pending, queued, or running `Simulink.Simulation.Future` object

Syntax

```
cancel(Future)
```

Description

`cancel(Future)` stops the objects of the `Simulink.Simulation.Future` array, `Future`, that are currently in 'pending', 'queued', or 'running' state. For elements of the Futures in the 'finished' state, no action is taken.

Examples

Cancel Simulations of Future Objects

This example shows how to use the `cancel` method on an array of future objects to stop the simulations.

This example runs several simulations of the `vdp` model, varying the value of the gain `Mu`.

Open the model and define a vector of `Mu` values.

```
open_system('vdp');  
Mu_Values = [0.5:0.25:1000];  
MuVal_length = length(Mu_Values)
```

Using `Mu_Values`, initialize an array of `Simulink.SimulationInput` objects. To preallocate the array, a loop index is made to start from the largest value.

```
for i = MuVal_length:-1:1  
    in(i) = Simulink.SimulationInput('vdp');  
    in(i) = in(i).setBlockParameter('vdp/Mu', ...  
        'Gain', num2str(Mu_Values(i)));  
end
```

Simulate the model using `parsim`. Set to 'RunInBackground' to enable the use the command prompt, while simulations are running.

```
Future = parsim(in, 'RunInBackground', 'on');
```

Now, assume that you want to run simulations with different values of `Mu` and cancel the ongoing simulations.

`cancel(Future)`

Input Arguments

Future — Simulation.Simulink.Future object

array

Array of `Simulation.Simulink.Future` objects. To create `Future`, run `parsim` with `'RunInBackground'` option set to `'on'`.

Example: `Future = parsim(in, 'RunInBackground', 'on')`

See Also

Functions

`parsim` | `batchsim` | `batch` | `fetchOutputs` | `fetchNext` | `wait`

Classes

`Simulink.Simulation.Future` | `Simulink.SimulationInput`

Introduced in R2018a

fetchNext

Fetch next available unread output from `Simulink.Simulation.Future` object array

Syntax

```
[idx,simOut] = fetchNext(Future)
[idx,simOut] = fetchNext(Future, Timeout)
```

Description

`[idx,simOut] = fetchNext(Future)` waits for the unread element of `Simulink.Simulation.Future` array, `Future`, to reach a 'finished' state. It returns the index of the simulation that finished, and the corresponding `Simulink.SimulationOutput` object.

`[idx,simOut] = fetchNext(Future, Timeout)` waits for a maximum of `Timeout` seconds for a result to become available. If the timeout expires before any result is available, `simOut` is returned as an empty array.

An error is reported if there are no elements in `Future` with property `Read` as false. You can check for any unread futures using `anyUnread = ~all([F.Read])`.

`fetchNext` displays an error if any element of `Future` with a 'finished' state encounters an error during execution. The `Read` property of that element becomes `true` allowing any subsequent call to `fetchNext` to proceed.

Examples

Create a Simulink.Simulation.Future Object

This example shows how to create a `Simulink.Simulation.Future` object array and use it to retrieve outputs and see the status of simulations.

This example runs several simulations of the `vdp` model, varying the value of the gain `Mu`.

Open the model and define a vector of `Mu` values.

```
open_system('vdp');
Mu_Values = [0.5:0.25:5];
MuVal_length = length(Mu_Values);
```

Using `Mu_Values`, initialize an array of `Simulink.SimulationInput` objects. To preallocate the array, a loop index is made to start from the largest value.

```
for i = MuVal_length:-1:1
    in(i) = Simulink.SimulationInput('vdp');
    in(i) = in(i).setBlockParameter('vdp/Mu',...
        'Gain',num2str(Mu_Values(i)));
end
```

Simulate the model using `parsim`. Set it to 'RunInBackground' to be able to use the command prompt, while simulations are running.

```
Future = parsim(in, 'RunInBackground', 'on');
```

Use the `fetchNext` method on `Future`.

```
for i = 1:MuVal_length
    [completedIdx, simOut] = fetchNext(Future)
end
```

Input Arguments

Future — `Simulation.Simulink.Future` object

array

Array of `Simulation.Simulink.Future` objects. To create `Future`, run `parsim` with 'RunInBackground' option set to 'on'.

Example: `Future = parsim(in, 'RunInBackground', 'on')`

Timeout — Number of seconds specified for `fetchNext` to time out

scalar

Specify a `Timeout` for `fetchNext` to retrieve the results from the `Simulation.Simulink.Future` array, `Future`.

Example: `[idx, simOut] = fetchNext(Future, 45)`

Output Arguments

idx — Index of the simulation

integer

When `fetchNext` method is used on an array of `Simulink.Simulation.Future` objects, it returns the index of the simulation whose output is being retrieved.

simOut — Simulation object containing logged simulation results

object | array

Array of `Simulink.SimulationOutput` objects that contain all of the logged simulation results. The size of the array is equal to the size of the array of `Simulink.SimulationInput` objects.

All simulation outputs (logged time, states, and signals) are returned in a single `Simulink.SimulationOutput` object. You define the model time, states, and output that are logged using the **Data Import/Export** pane of the Model Configuration Parameters dialog box. You can log signals using blocks such as the To Workspace and Scope blocks. The **Signal & Scope Manager** tool can directly log signals.

See Also

Functions

`parsim` | `batchsim` | `batch` | `cancel` | `fetchOutputs` | `wait`

Classes

Simulink.Simulation.Future | Simulink.SimulationInput

Introduced in R2017b

fetchOutputs

Retrieve `Simulink.SimulationOutput` from `Simulink.Simulation.Future` objects

Syntax

```
simOut = fetchOutputs(Future)
```

Description

`simOut = fetchOutputs(Future)` fetches the output from an array of `Simulink.Simulation.Future` objects, `Future`, after each element of `Future` is in a 'finished' state. `fetchOutputs` returns an array of `Simulink.SimulationOutput` objects.

Examples

Create a Future and Retrieve Outputs Using fetchOutputs

This example shows how to use the `fetchOutputs` method on an array of future objects to retrieve a `Simulink.SimulationOutput` array.

This example runs several simulations of the `vdp` model, varying the value of the gain `Mu`.

Open the model and define a vector of `Mu` values.

```
open_system('vdp');  
Mu_Values = [0.5,0.75,1,1.25];  
MuVal_length = length(Mu_Values);
```

Using `Mu_Values`, initialize an array of `Simulink.SimulationInput` objects. To preallocate the array, a loop index is made to start from the largest value.

```
for i = MuVal_length:-1:1  
    in(i) = Simulink.SimulationInput('vdp');  
    in(i) = in(i).setBlockParameter('vdp/Mu',...  
        'Gain',num2str(Mu_Values(i)));  
end
```

Simulate the model using `parsim`. Set to `'RunInBackground'` to enable the use of command prompt, while simulations are running.

```
Future = parsim(in,'RunInBackground','on');
```

Use the `fetchOutputs` method on `Future`

```
simOut = fetchOutputs(Future)
```

```
simOut =  
1x4 Simulink.SimulationOutput array
```

Input Arguments

Future — `Simulation.Simulink.Future` object
array

Array of `Simulation.Simulink.Future` objects. To create, `Future`, run `parsim` with 'RunInBackground' option set to 'on'.

Example: `Future = parsim(in, 'RunInBackground', 'on')`

Output Arguments

simOut — `Simulation` object containing logged simulation results
object

Array of `Simulink.SimulationOutput` objects that contain all of the logged simulation results. The size of the array is equal to the size of the array of `Simulink.SimulationInput` objects.

All simulation outputs (logged time, states, and signals) are returned in a single `Simulink.SimulationOutput` object. You define the model time, states, and output that are logged using the **Data Import/Export** pane of the Model Configuration Parameters dialog box. You can log signals using blocks such as the To Workspace and Scope blocks. The **Signal & Scope Manager** tool can directly log signals.

See Also

Functions

`parsim` | `batchsim` | `batch` | `cancel` | `fetchNext` | `wait`

Classes

`Simulink.Simulation.Future` | `Simulink.SimulationInput`

Introduced in R2018a

wait

Wait for `Simulink.Simulation.Future` objects to complete simulation

Syntax

```
Ok = wait(Future)
```

Description

`Ok = wait(Future)` blocks the command prompt until each element of the `Simulink.Simulation.Future` array, `Future` is in a 'finished' state.

Examples

Wait for the Future Array to Complete Simulations

This example shows how to use the `wait` method on an array of future objects.

This example runs several simulations of the `vdp` model, varying the value of the gain `Mu`.

Open the model and define a vector of `Mu` values.

```
open_system('vdp');
Mu_Values = [0.5:0.25:5];
MuVal_length = length(Mu_Values);
```

Using `Mu_Values`, initialize an array of `Simulink.SimulationInput` objects. To preallocate the array, a loop index is made to start from the largest value.

```
for i = MuVal_length:-1:1
    in(i) = Simulink.SimulationInput('vdp');
    in(i) = in(i).setBlockParameter('vdp/Mu', ...
        'Gain', num2str(Mu_Values(i)));
end
```

Simulate the model using `parsim`. Set to 'RunInBackground' to enable the use of command prompt while the simulations are running and to create an array of `Simulink.Simulation.Future` objects.

```
Future = parsim(in, 'RunInBackground', 'on');
```

Use the `wait` method on `Future` to block the execution.

```
Ok = wait(Future)
```

Input Arguments

Future — `Simulation.Simulink.Future` object

array

Array of `Simulation.Simulink.Future` objects. To create `Future`, run `parsim` with `'RunInBackground'` option set to `'on'`.

Example: `Future = parsim(in, 'RunInBackground', 'on')`

Output Arguments

Ok — Whether the wait is completed successfully

1 | 0

`Ok` is `true` if the wait completes successfully, `false` if any of the `Future` objects failed execution or were canceled. Specified as 1 if true, 0 if false.

See Also

Functions

`parsim` | `batchsim` | `batch` | `cancel` | `fetchOutputs` | `fetchNext`

Classes

`Simulink.Simulation.Future` | `Simulink.SimulationInput`

Introduced in R2017b

Simulink.SimulationMetadata class

Package: Simulink

Access metadata of simulation runs

Description

The `SimulationMetadata` class contains information about a simulation run including:

- Model information
- Timing information
- Execution and diagnostic information
- Custom character vector to tag the simulation
- Custom data to describe the simulation

`SimulationMetadata` packages this information with the `SimulationOutput` object. To use `SimulationMetadata`, use one of these approaches:

- In **Configuration Parameters > Data Import/Export**, under **Save options**, select **Single simulation output**.
- Use `set_param` to set `ReturnWorkspaceOutputs` to on.

```
set_param(model_name, 'ReturnWorkspaceOutputs', 'on');
```

To retrieve the `SimulationMetadata` object, use the `getSimulationMetadata` method on a `SimulationOutput` object.

Properties

ModelInfo — Information about the model and simulation operating environment

structure

The `ModelInfo` structure has these fields.

| Field Name | Type | Description |
|----------------------------|------|---|
| <code>ModelName</code> | char | Name of the model |
| <code>ModelVersion</code> | char | Version of the model |
| <code>ModelFilePath</code> | char | Absolute location of the <code>.mdl/.slx</code> file |
| <code>UserID</code> | char | System user ID of the machine used for the simulation |
| <code>MachineName</code> | char | Hostname of the machine used for the simulation |
| <code>Platform</code> | char | Operating system of the machine used for the simulation |

| Field Name | Type | Description |
|-------------------------|---------------|--|
| ModelStructuralChecksum | 4-by-1 uint32 | Structural checksum of the model calculated after an update diagram |
| SimulationMode | char | Simulation mode |
| StartTime | double | Simulation start time |
| StopTime | double | Time at which the simulation was terminated |
| SolverInfo | structure | Solver information: <ul style="list-style-type: none"> Fixed-step solvers - Solver type, name, and fixed step size Variable solvers - Solver type, name, and max step size (initial setting) |
| SimulinkVersion | structure | Version of Simulink |
| LoggingInfo | structure | Metadata about logging to persistent storage: <ul style="list-style-type: none"> LoggingToFile field — Indicates whether logging to persistent storage is enabled ('on' or 'off') LoggingFileName field — Specifies the resolved file name for the persistent storage MAT-file (if LoggingToFile is 'on'). |

ExecutionInfo — Structure to store information about a simulation run

structure

Structure to store information about a simulation run, including the reason a simulation stopped and any diagnostics reported during the simulation. The structure has these fields.

| Field Name | Type | Description |
|----------------------|-----------------------------------|--|
| StopEvent | Nontranslated character vector | <p>Reason the simulation stopped, represented by one of the following:</p> <ul style="list-style-type: none"> • ReachedStopTime - Simulation stopped upon reaching stop time and no errors were reported during execution. StopEvent has value ReachedStopTime, even if errors are reported in the stop callbacks, which are executed after the simulation ends. • ModelStop - Simulation stopped by a block or by solver before reaching stop time. • StopCommand - Simulation stopped manually by clicking the Stop button or using the set_param command. • DiagnosticError - Simulation stopped because an error was reported during simulation. • KeyboardControlC - Simulation stopped using keystroke Ctrl+C. • PauseCommand - Simulation paused manually by clicking the Pause button or using the set_param command. • ConditionalPause - Simulation paused using a conditional breakpoint. • PauseTime - Simulation paused at or after specified pause time. • StepForward - Simulation paused after clicking step forward. • StepBackward - Simulation paused after clicking step backward. • Timeout - Simulation stopped because execution time exceeded timeout specified by Timeout. |
| StopEventSource | Simulink.SimulationData.BlockPath | Source of stop event, if it is a valid Simulink object. |
| StopEventDescription | Translated character vector | Superset of information stored in StopEvent and StopEventSource. |

| Field Name | Type | Description |
|--------------------|-----------------|---|
| ErrorDiagnostic | struct | <p>Error reported during simulation, represented by the following fields:</p> <ul style="list-style-type: none"> • Diagnostic - MSLDiagnostic object that includes object paths, ID, message, cause, and stack. • SimulationPhase - Represented by one of these: Initialization, Execution, or Termination. • SimulationTime - Simulation time represented as a double, if reported during Execution; else, represented as []. <p>By passing the name-value pair 'CaptureErrors', 'on' to the sim command, errors generated during simulation are reported in ExecutionInfo.ErrorDiagnostic. The sim command does not capture generated errors.</p> |
| WarningDiagnostics | Array of struct | <p>Array of all warnings reported during the simulation. Each array item is represented by the following fields:</p> <ul style="list-style-type: none"> • Diagnostic - MSLDiagnostic object that includes object paths, ID, message, cause, and stack. • SimulationPhase - Represented as: Initialization, Execution, or Termination. • SimulationTime - Simulation time represented as a double, if reported during Execution; else, represented as []. |

TimingInfo — Structure to store profiling information about the simulation

structure

Structure to store profiling information about the simulation, including the time stamps for the start and end of the simulation. The structure has these fields.

| Field Name | Type | Description |
|-------------------------|------------------|--|
| WallClockTimestampStart | character vector | Wall clock time when the simulation started, in YYYY-MM-DD HH:MI:SS format with microsecond resolution |
| WallClockTimestampStop | character vector | Wall clock time when the simulation stopped, in YYYY-MM-DD HH:MI:SS format with microsecond resolution |

| Field Name | Type | Description |
|-------------------------------|------------------------|--|
| InitializationElapsedWallTime | double | Time spent before execution, in seconds |
| ExecutionElapsedWallTime | double | Time spent during execution, in seconds |
| TerminationElapsedWallTime | double | Time spent after execution, in seconds |
| TotalElapsedWallTime | double | Total time spent in initialization, execution, and termination, in seconds |
| ProfilerData | Simulink.profiler.Data | Profiling results of the model, returned as a Simulink.profiler.Data object Note The ProfilerData field is shown only when the Profile and ReturnWorkspaceOutputs model parameters are enabled |

The ExecutionElapsedWallTime includes the time that Simulink spent to roll back or step back in a simulation. The ExecutionElapsedWallTime does not include the time spent between steps. For example, if you use Stepper to step through a simulation, the ExecutionElapsedWallTime time does not include the time when the simulation is in a paused state. For more information about using Stepper, see “How Simulation Stepper Helps With Model Analysis”.

UserString — Custom character vector to describe the simulation

character vector

Use Simulink.SimulationOutput.setUserString to directly store a character vector in the SimulationMetadata object that is contained in the SimulationOutput object.

UserData — Custom data to store in SimulationMetadata object that is contained in the SimulationOutput object

character vector

Use Simulink.SimulationOutput.setUserData to store custom data in the SimulationMetadata object that is contained in the SimulationOutput object.

Copy Semantics

Value. To learn how value classes affect copy operations, see Copying Objects.

Examples

Get a SimulationMetadata Object for vdp Simulation

Simulate the vdp model. Retrieve metadata from a SimulationMetadata object of the simulation.

Simulate the vdp model. Save the results of the Simulink.SimulationOutput object in simout.

```
open_system('vdp');
simout = sim(bdroot, 'ReturnWorkspaceOutputs', 'on');
```

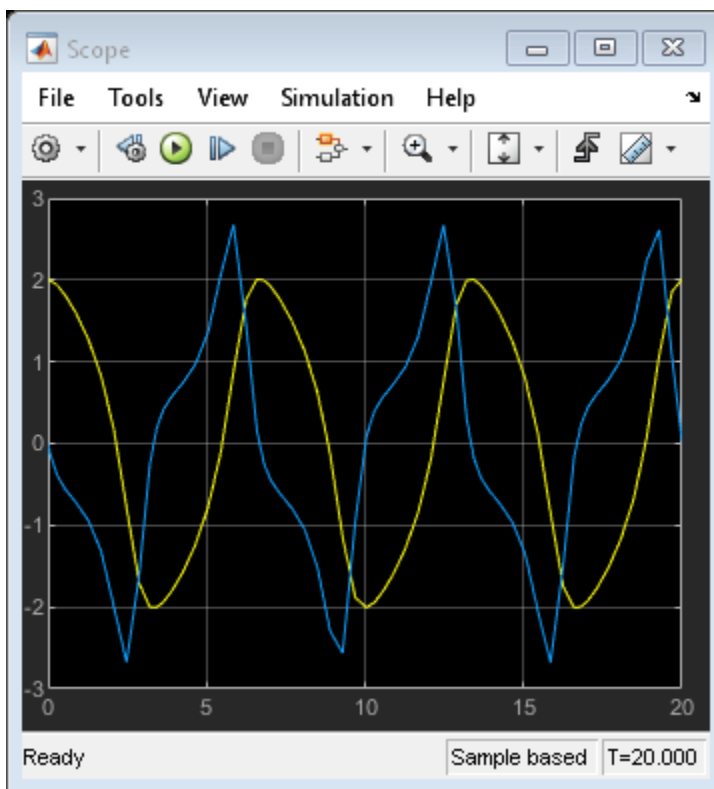
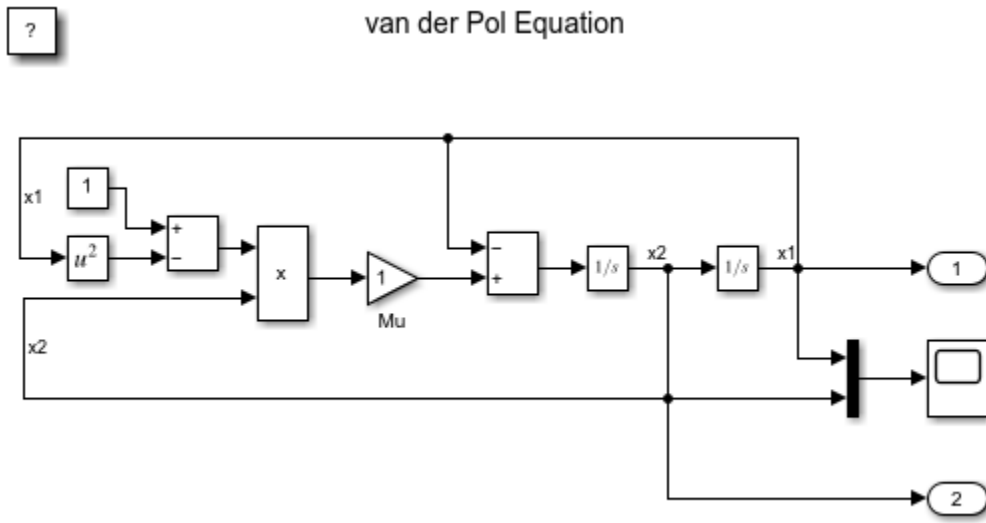

Retrieve metadata information about this simulation using `mData`. This is the `SimulationMetadata` object that `simout` contains.

```
mData=simout.getSimulationMetadata()
```

```
mData =
```

SimulationMetadata with properties:

```
    ModelInfo: [1x1 struct]
    TimingInfo: [1x1 struct]
    ExecutionInfo: [1x1 struct]
    UserString: ''
    UserData: []
```

Store custom data or string in simout.

```
simout=simout.setUserData(struct('param1','value1','param2','value2','param3','value3'));
simout=simout.setUserString('Store first simulation results');
```

Retrieve the custom data you stored from mData.

```
mData=simout.getSimulationMetadata()
disp(mData.UserData)
```

mData =

SimulationMetadata with properties:

```
    ModelInfo: [1x1 struct]
    TimingInfo: [1x1 struct]
    ExecutionInfo: [1x1 struct]
    UserString: 'Store first simulation results'
    UserData: [1x1 struct]

    param1: 'value1'
    param2: 'value2'
    param3: 'value3'
```

Retrieve the custom string you stored from mData.

```
mData=simout.getSimulationMetadata()
disp(mData.UserString)
```

mData =

SimulationMetadata with properties:

```
    ModelInfo: [1x1 struct]
    TimingInfo: [1x1 struct]
    ExecutionInfo: [1x1 struct]
    UserString: 'Store first simulation results'
    UserData: [1x1 struct]
```

Store first simulation results

See Also

[getSimulationMetadata](#) | [setUserString](#) | [setUserString](#)

Introduced in R2015a

Simulink.SimulationOutput

Access simulation results

Description

The `Simulink.SimulationOutput` object includes all logged simulation data and a `SimulationMetadata` object that describes simulation conditions. The `Simulink.SimulationOutput` object also contains useful metadata about the simulation, simulation run time. You can use the `Simulink.SimulationOutput` object to inspect results of the simulation, and you can use the `plot` function on the `Simulink.SimulationOutput` object to visualize the results. For simulation invoked using the **Run** or **Step Forward** buttons in Simulink, the `Simulink.SimulationOutput` object is stored in the base workspace, with the name specified in the model parameters. `Simulink.SimulationOutput` is writable.

Creation

By default, each simulation you run, creates a `Simulink.SimulationOutput` object that contains all data logged in the simulation, and a `Simulink.SimulationMetadata` object with the simulation metadata. You can access the `SimulationOutput` objects in several ways.

- The `Simulink.SimulationOutput` object returns the logged data for the simulation.
- You can use `who`, `get`, and `find` methods to access the output variable names and their respective values.

In the **Configuration Parameters**, the model setting **Single simulation output**, controls whether simulation output is returned in a `Simulink.SimulationOutput` object or if data is expanded in the base workspace. You can also use the command line API for this behavior by setting `ReturnWorkspaceOutputs` to `on` as a name-value argument pair with the `sim` command.

Properties

SimulationMetadata — Metadata for simulations

`Simulink.SimulationMetadata` object

Metadata for simulations, returned as a `Simulink.SimulationMetadata` object. Fields other than the `UserData` and `UserString` fields are read-only.

ErrorMessage — Simulation logging error messages

character vector

This property is read-only.

Simulation logging error messages returned as a character vector. The `ErrorMessage` property is empty when the simulation runs without errors.

Object Functions

| | |
|------------------------------------|---|
| <code>find</code> | Access and display values of simulation results |
| <code>get</code> | Access and display values of simulation results |
| <code>getSimulationMetadata</code> | Return <code>SimulationMetadata</code> object for simulation |
| <code>setUserData</code> | Store custom data in <code>SimulationMetadata</code> object that <code>SimulationOutput</code> object contains |
| <code>setUserString</code> | Store custom character vector in <code>SimulationMetadata</code> object in <code>SimulationOutput</code> object |
| <code>who</code> | Access and display output variable names of simulation |
| <code>plot</code> | Plot simulation output data in the Simulation Data Inspector |

Examples

View Simulation Output and Metadata

Simulate a model, place the results of the `Simulink.SimulationOutput` object in `simOut` and view the simulation metadata.

Simulate the `vdp` model.

```
simOut = sim('vdp','SaveState','on','StateSaveName','xoutNew',...
            'SaveOutput','on','OutputSaveName','youtNew')
```

```
Simulink.SimulationOutput:
```

```
    xoutNew: [65x2 double]
    youtNew: [65x2 double]
```

```
SimulationMetadata: [1x1 Simulink.SimulationMetadata]
ErrorMessage: [0x0 char]
```

Get the values of the variable `youtNew`.

```
simOut.youtNew
```

Simulink returns and displays the values.

Get the timing information for the simulation.

```
myMetadata = simOut.SimulationMetadata
```

```
myMetadata =
```

```
SimulationMetadata with properties:
```

```
    ModelInfo: [1x1 struct]
    TimingInfo: [1x1 struct]
    ExecutionInfo: [1x1 struct]
    UserString: ''
    UserData: []
```

```
myMetadata.TimingInfo
```

```
ans =
```

```
struct with fields:
```

```
    WallClockTimestampStart: '2016-12-30 08:47:51.739935'  
    WallClockTimestampStop: '2016-12-30 08:47:58.185579'  
    InitializationElapsedWallTime: 5.9166  
    ExecutionElapsedWallTime: 0.1910  
    TerminationElapsedWallTime: 0.3380  
    TotalElapsedWallTime: 6.4456
```

See Also

[Simulink.SimulationData.Dataset | loadIntoMemory | Simulink.SimulationMetadata | sim](#)

Topics

“Export Simulation Data”

Introduced in R2010a

Simulink.SubsysDataLogs

Container for subsystem signal data logs

Description

Note Before R2016a, the `Simulink.SubsysDataLogs` class was used in conjunction with the `ModelDataLogs` logging data format. Starting in R2016a, you cannot log data in the `ModelDataLogs` format. Signal logging uses the `Dataset` format.

However, you can use data that was logged in a previous release using `ModelDataLogs` format.

In releases before R2016a, Simulink created instances of this class to contain logs for signals in a subsystem models were logged in `ModelDataLogs` format. Objects of this class have a variable number of properties. The first property, named `Name`, is the name of the subsystem whose log data this object contains. The remaining properties are signal log or signal log container objects containing the data logged for the subsystem specified by this object's `Name` property.

For example, suppose you have this logged data from a model run in a release earlier than R2016a:

```
Simulink.SubsysDataLogs (Gain):
  Name          elements  Simulink Class
  a              1         Timeseries
  m              2         TsArray
```

You can use either fully qualified log names or the `unpack` command to access the signal logs contained by a `SubsysDataLogs` object. For example, to access the amplitudes logged for signal `a` in the preceding example, you could enter the following at the MATLAB command line:

```
data = logout.Gain.a.Data;
```

or

```
>> logout.unpack('all');
data = a.Data;
```

See Also

“Load Signal Data for Simulation”, `Simulink.ModelDataLogs`, `Simulink.Timeseries`, `Simulink.TsArray`, `Simulink.SimulationData.Dataset`, `who`, `whos`, `unpack`

Introduced before R2006a

sldiagviewer class

Generate, display, and log diagnostic messages in the Diagnostic Viewer

Description

Use an instance of `sldiagviewer` class to perform the following operations:

- Create a stage
- Report Error
- Report warning
- Report Info

The `sldiagviewer` class is a `handle` class.

Methods

Public Methods

See Also

[“View Diagnostics”](#) | [“Customize Diagnostic Messages”](#)

Introduced in R2014a

Simulink.SuppressedDiagnostic class

Package: Simulink

Suppress diagnostic messages from a specified block

Description

A `Simulink.SuppressedDiagnostic` object contains information related to diagnostic warnings or errors that are suppressed from being thrown during simulation.

Construction

The Diagnostic Viewer in Simulink includes an option to suppress certain diagnostics. This feature enables you to suppress warnings or errors for specific objects in your model. Click the **Suppress** button next to the warning in the Diagnostic Viewer to suppress the warning from the specified source. This action creates a `Simulink.SuppressedDiagnostic` object. You can access this object at the MATLAB command line using the `Simulink.getSuppressedDiagnostics` function. You can add a comment for the suppressed diagnostic. You can restore the diagnostic by clicking **Restore**.

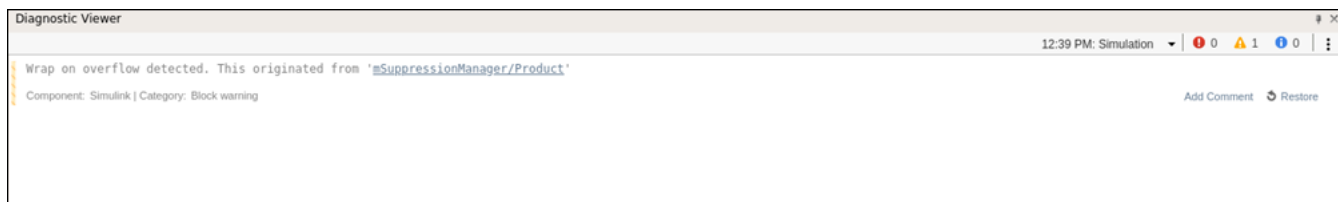

`DiagnosticObject = Simulink.SuppressedDiagnostic(source, message_id)` creates a suppressed diagnostic object. The object suppresses all instances of diagnostics represented by `message_id` thrown by the blocks specified by `source`.

Input Arguments

source — System, block, or model object throwing diagnostic

model | subsystem | block path | block handle

The source of the diagnostic, specified as a model, subsystem, block path, block handle, cell array of block paths, or cell array of block handles.

To get the block path, use the `gcb` function.

To get the block handle, use the `getSimulinkBlockHandle` function.

Data Types: char | cell | string

message_id — message identifier of diagnostic

message identifier

The message identifier of the diagnostic, specified as a character vector or string. You can find the message identifier of diagnostics thrown during simulation by accessing the `ExecutionInfo` property of the `Simulink.SimulationMetadata` object associated with a simulation. You can also use the `lastwarn` function.

Data Types: char | string

Properties

Comments — Comments associated with the suppression object

character vector

Comments associated with the suppression object, specified as a character vector. This property is optional.

Data Types: char

ID — Message identifier of the diagnostic that was suppressed

character vector

The message identifier of the diagnostic that was suppressed, specified as a character vector.

Data Types: char

LastModified — Date and time the suppression object was last modified

character vector

Date and time the suppression object was last modified, specified as a character vector. This property is read-only.

Data Types: char

LastModifiedBy — Name of the user who was last to add or edit the suppression object

character vector

Name of the user who last added or edited the suppression object, specified as a character vector. This property is optional.

Data Types: char

Source — block path of the source of the diagnostic

character vector

The block path of the model object that has a suppressed diagnostic, specified as a character vector.

Data Types: char

Methods

restore Remove specified diagnostic suppressions

suppress Suppress diagnostic specified by Simulink.SuppressedDiagnostic object

Copy Semantics

Handle. To learn how handle classes affect copy operations, see Copying Objects.

Examples

Create a Simulink.SuppressedDiagnostic Object

Using the model from “Suppress Diagnostic Messages Programmatically”, create and then restore a diagnostic suppression.

Create a `Simulink.SuppressedDiagnostic` object, suppression to suppress the parameter precision loss warning thrown by the Constant block, one.

```
suppression = Simulink.SuppressedDiagnostic('Suppressor_CLI_Demo/one',...  
'SimulinkFixedPoint:util:fxpParameterPrecisionLoss');
```

The parameter precision loss warning is no longer thrown in future simulations of this model.

Add accountability information to the object by editing the `LastModifiedBy` and `Comments` properties of the object.

```
suppression.LastModifiedBy = 'John Doe';  
suppression.Comments = 'Reviewed: Joe Schmoie'
```

```
suppression =
```

```
SuppressedDiagnostic with properties:
```

```
Source: 'Suppressor_CLI_Demo/one'  
Id: 'SimulinkFixedPoint:util:fxpParameterPrecisionLoss'  
LastModifiedBy: 'John Doe'  
Comments: 'Reviewed: Joe Schmoie'  
LastModified: '2016-Jun-01 17:25:21'
```

You can restore the diagnostic using the `restore` method.

```
restore(suppression);
```

See Also

[Simulink.getSuppressedDiagnostics](#) | [Simulink.suppressDiagnostic](#) | [Simulink.restoreDiagnostic](#) | [restore](#) | [Simulink.SuppressedDiagnostic](#)

Topics

“Suppress Diagnostic Messages Programmatically”

Class Attributes

Property Attributes

Introduced in R2016b

restore

Class: Simulink.SuppressedDiagnostic

Package: Simulink

Remove specified diagnostic suppressions

Syntax

```
restore(SuppressedDiagnostic)
```

Description

`restore(SuppressedDiagnostic)` removes the specified suppressed diagnostic object.

Input Arguments

SuppressedDiagnostic — Suppressed diagnostic object to restore

Simulink.SuppressedDiagnostic object

Simulink.SuppressedDiagnostic object

Examples

Restore a Suppressed Diagnostic

Using the model from “Suppress Diagnostic Messages Programmatically”, create and then restore a diagnostic suppression.

Create a `Simulink.SuppressedDiagnostic` object, `suppression` to suppress the parameter precision loss warning from the Constant block, `one`.

```
suppression = Simulink.SuppressedDiagnostic('Suppressor_CLI_Demo/one', ...  
'SimulinkFixedPoint:util:fxpParameterPrecisionLoss');
```

You can restore the diagnostic using the `restore` method.

```
restore(suppression);
```

Restore All Suppressed Diagnostics

Using the model from “Suppress Diagnostic Messages Programmatically”, restore all diagnostic suppressions associated with a model.

Use the `Simulink.suppressDiagnostic` function to suppress the parameter precision loss and parameter underflow warnings from the Constant block, `one`.

```
diags = {'SimulinkFixedPoint:util:fxpParameterPrecisionLoss', 'SimulinkFixedPoint:util:fxpParamete  
Simulink.suppressDiagnostic('Suppressor_CLI_Demo/one',diags);
```

Use the `Simulink.getSuppressedDiagnostics` function to get all suppressions associated with the model, returned as an array of `Simulink.SuppressedDiagnostic` objects.

```
suppressed_diagnostics = Simulink.getSuppressedDiagnostics('Suppressor_CLI_Demo')
```

```
suppressed_diagnostics =
```

```
1×2 SuppressedDiagnostic array with properties:
```

```
Source  
Id  
LastModifiedBy  
Comments  
LastModified
```

Restore all diagnostics using the `restore` method and iterating through the `suppressed_diagnostics` array.

```
for iter = 1:numel(suppressed_diagnostics)  
    restore(suppressed_diagnostics(iter));  
end
```

See Also

[Simulink.getSuppressedDiagnostics](#) | [Simulink.suppressDiagnostic](#) | [Simulink.restoreDiagnostic](#) | [Simulink.SuppressedDiagnostic](#)

Topics

“Suppress Diagnostic Messages Programmatically”

Introduced in R2016b

suppress

Class: Simulink.SuppressedDiagnostic

Package: Simulink

Suppress diagnostic specified by Simulink.SuppressedDiagnostic object

Syntax

```
suppress(SuppressedDiagnostic)
```

Description

suppress(SuppressedDiagnostic) suppresses the specified suppressed diagnostic object.

Input Arguments

SuppressedDiagnostic — Suppressed diagnostic object to suppress

Simulink.SuppressedDiagnostic object

Simulink.SuppressedDiagnostic object

See Also

Simulink.getSuppressedDiagnostics | Simulink.suppressDiagnostic |
Simulink.restoreDiagnostic | Simulink.SuppressedDiagnostic

Topics

“Suppress Diagnostic Messages Programmatically”

Introduced in R2018a

Simulink.TimeInfo

Provide information about time data in `Simulink.Timeseries` object

Description

Simulink software creates instances of these objects to describe the time data that it includes in `Simulink.Timeseries` objects.

Note The `Simulink.Timeseries` class is supported for backwards compatibility. The `ModelDataLogs` format created `Simulink.Timeseries` objects for signal logging data. Starting in R2016a, you cannot log data in the `ModelDataLogs` format. Signal logging uses the `Dataset` format. In R2016a or later, when you open a model from an earlier release that had used `ModelDataLogs` format, the model simulated in use `Dataset` format.

You can convert signal logging data from `ModelDataLogs` to `Dataset` format. Converting to `Dataset` format makes it easier to post-process with other logged data (for example, logged states), which can also use `Dataset` format. For more information, see “Convert Logged Data to Dataset Format”.

If you have legacy code that uses the `ModelDataLogs` API, you can encounter situations that require updates to your code or model. See “Migrate Scripts That Use Legacy `ModelDataLogs` API”.

Properties

| Name | Access | Description |
|-----------|--------|---|
| Units | RW | The units, e.g., 'seconds', in which the time series data are expressed in the associated <code>Simulink.Timeseries</code> object. |
| Start | RW | If the associated signal is not in a conditionally executed subsystem, this field contains the simulation time of the first signal value recorded in the associated <code>Simulink.Timeseries</code> object. If the signal is in a conditionally executed subsystem, this field contains an array of times when the system became active. |
| end | RW | If the associated signal is not in a conditionally executed subsystem, this field contains the simulation time of the last signal value recorded in the associated <code>Simulink.Timeseries</code> object. If the signal is in a conditionally executed subsystem, this field contains an array of times when the system became inactive. |
| Increment | RW | The interval between simulation times at which signal data is logged in the associated <code>Simulink.Timeseries</code> object. If the signal is aperiodic (continuous signal with variable-step solver), this property has a value of NaN. A signal is periodic if it has a discrete sample time (not continuous or constant) or is continuous with a fixed-step solver. |

| Name | Access | Description |
|--------|--------|--|
| Length | W | The number of signal samples recorded in the associated <code>Simulink.Timeseries</code> object, i.e., the length of the arrays referenced by the object's <code>Time</code> and <code>Data</code> properties. |

See Also

`Simulink.Timeseries` , `Simulink.SimulationData.Dataset`

Introduced before R2006a

Simulink.Timeseries

Store data for any signal except mux or bus signal

Description

Note The `Simulink.Timeseries` class is supported for backwards compatibility. The `ModelDataLogs` format created `Simulink.Timeseries` objects for signal logging data. Starting in R2016a, you cannot log data in the `ModelDataLogs` format. Signal logging uses the `Dataset` format. In R2016a or later, when you open a model from an earlier release that had used `ModelDataLogs` format, the model simulated in use `Dataset` format.

You can convert signal logging data from `ModelDataLogs` to `Dataset` format. Converting to `Dataset` format makes it easier to post-process with other logged data (for example, logged states), which can also use `Dataset` format. For more information, see “Convert Logged Data to Dataset Format”.

If you have legacy code that uses the `ModelDataLogs` API, you can encounter situations that require updates to your code or model. See “Migrate Scripts That Use Legacy `ModelDataLogs` API”.

Simulink software creates instances of this class to store signal data that it logs for any signal except a mux or bus signal, which are stored in a `Simulink.TsArray`. See “Export Signal Data Using Signal Logging” for more information.

Properties

| Name | Access | Description |
|------------|--------|--|
| Name | RW | Name of this signal log. |
| BlockPath | RW | Path of the block that output the signal logged in this signal log. |
| PortIndex | RW | Index of the output port that emitted the signal logged in this signal log. |
| SignalName | RW | Name of the signal logged in this signal log. |
| ParentName | RW | Name of the parent of the signal recorded in this log, if the signal is an element of a mux or a virtual bus; otherwise, the same as <code>SignalName</code> . |
| TimeInfo | RW | An object of <code>Simulink.TimeInfo</code> class that describes the time data in this log. |
| Time | RW | An array containing the simulation times at which signal data was logged. |
| Data | RW | An array containing the signal data. |

See Also

“Export Signal Data Using Signal Logging”, `Simulink.TimeInfo`, `Simulink.SimulationData.Dataset`, `Simulink.ModelDataLogs`, `Simulink.SubsysDataLogs`, `Simulink.TsArray`, `who`, `whos`, `unpack`

Introduced before R2006a

Simulink.TsArray

Store data for mux or bus signal

Description

Note Before R2016a, the `Simulink.TsArray` class was used in conjunction with the `ModelDataLogs` logging data format. Starting in R2016a, you cannot log data in the `ModelDataLogs` format. Signal logging uses the `Dataset` format.

However, you can use data that was logged in a previous release using `ModelDataLogs` format.

In releases earlier than R2016a, Simulink software created instances of this class to contain the data that it logs for a mux or bus signal. Other types of signals were stored in a `Simulink.Timeseries`.

Objects of the `Simulink.TsArray` class have a variable number of properties. The first property, called `Name`, specifies the log name of the logged signal. The remaining properties reference logs for the elements of the logged signal: `Simulink.Timeseries` objects for elementary signals and `Simulink.TsArray` objects for mux or bus signals. The name of each property is the log name of the corresponding signal.

For example, suppose you have this logged data from a model run in a release earlier than R2016a that was configured to log in `ModelDataLogs` format.

```
logout.b2
```

```
Simulink.TsArray (untitled/Bus Creator1):
  Name          elements  Simulink Class
  x1             1         Timeseries
  b1             2         TsArray
```

The `Simulink.ModelDataLogs` object, named `logout`, contains a `Simulink.TsArray` object, named `b2`, that contains the logs for the elements of `b2` (that is, the elementary signal `x1` and the bus signal `b1`). Entering the fully qualified name of the `Simulink.TsArray` object, (`logout.b2`) at the MATLAB command line reveals the structure of the signal log for this model.

You can use either fully qualified log names or the `unpack` command to access the signal logs contained by a `Simulink.TsArray` object. For example, to access the amplitudes logged for signal `x1` in the preceding example, you can enter the following at the MATLAB command line:

```
data = logout.b2.x1.Data;
```

or

```
logout.unpack('all');
data = x1.Data;
```

See Also

`Simulink.ModelDataLogs`, `Simulink.SubsysDataLogs`, `Simulink.Timeseries`,
`Simulink.SimulationData.Dataset`, `who`, `whos`, `unpack`

Introduced before R2006a

Simulink.Variant class

Package: Simulink

Specify conditions that control variant selection

Description

An object of the `Simulink.Variant` class represents a conditional expression called a variant control. The object allows you to specify a Boolean expression that activates a specific variant choice when it evaluates to `true`.

A variant control comprises one or more variant control variables, specified using MATLAB variables or `Simulink.Parameter` objects.

You specify variant controls for each variant choice represented in a Variant Subsystem or Model Variant block. For a given Variant Subsystem or Model Variant block, only one variant control can evaluate to `true` at a time. When a variant control evaluates to `true`, Simulink activates the variant choice that corresponds to that variant control.

Construction

`variantControl = Simulink.Variant(conditionExpression)` creates a variant control.

Properties

conditionExpression — Variant condition expression

'(default)' | character vector

Variant condition expression, specified as a character vector containing one or more of these operands and operators.

Operands

- Variable names that resolve to MATLAB variables or `Simulink.Parameter` objects with integer or enumerated data type and scalar literal values
- Variable names that resolve to `Simulink.Variant` objects
- Scalar literal values that represent integer or enumerated values

Operators

- Parentheses for grouping
- Arithmetic, relational, logical, or bit-wise operators

The variant condition expression evaluates to a Boolean value. This property has read and write access.

Example: `'(Fuel==2 || Emission==1) && Ratio==2'`

Examples

Create Variant Controls Using MATLAB Variables

Use MATLAB variables when you want to simulate the model but are not considering code generation.

Create MATLAB variables with scalar literal values.

```
Fuel = 3;
Emission = 1;
Ratio = 3;
```

Develop conditional expressions using the variables.

```
Variant1 = Simulink.Variant('Fuel==1 && Emission==2');
Variant2 = Simulink.Variant('(Fuel==2 || Emission==1) && Ratio==2');
Variant3 = Simulink.Variant('Fuel==3 || Ratio==4');
```

Create Variant Controls Using Simulink.Parameter Objects

If you want to generate preprocessor conditionals for code generation, use `Simulink.Parameter` objects.

Create variant `Simulink.Parameter` objects with scalar literal values.

```
Fuel = Simulink.Parameter(3);
Emission = Simulink.Parameter(1);
Ratio = Simulink.Parameter(3);
```

Specify the custom storage class for these objects as `ImportedDefine` so that the values are specified by an external header file.

Other valid values for the custom storage class are `Define` and `CompilerFlag`

Note If you generate code with startup activation time, specify the supported custom storage class for the objects. For more information on built-in and custom storage classes supported with startup activation time see “Storage Classes for Different Variant Activation Times”.

```
Fuel.CoderInfo.StorageClass = 'Custom';
Fuel.CoderInfo.CustomStorageClass = 'ImportedDefine';

Emission.CoderInfo.StorageClass = 'Custom';
Emission.CoderInfo.CustomStorageClass = 'ImportedDefine';

Ratio.CoderInfo.StorageClass = 'Custom';
Ratio.CoderInfo.CustomStorageClass = 'ImportedDefine';
```

Develop conditional expressions using the variables and create variant controls.

```
Variant1 = Simulink.Variant('Fuel==1 && Emission==2');
Variant2 = Simulink.Variant('(Fuel==2 || Emission==1) && Ratio==2');
Variant3 = Simulink.Variant('Fuel==3 || Ratio==4');
```

See Also

“Operators in Variant Condition Expressions”

Topics

“Define, Configure, and Activate Variant Choices in a Variant Subsystem Block”

“Convert Variant Control Variables into Simulink.Parameter Objects”

Simulink.VariantConfigurationData class

Package: Simulink

Class representing a variant configurations data object

Description

The variant configuration data object, stores a collection of variant configurations, constraints, and the name of the default active configuration. The `Simulink.VariantConfigurationData` class has properties that enable you to add, modify, or remove variant configurations, constraints, and control variables. Use an instance of `Simulink.VariantConfigurationData` class to do the following:

- Define and edit variant configurations.
- Add control variables to variant configurations.
- Add copy of variant configuration.
- Delete existing variant configurations, constraints, and sub model configurations.
- Set a specific configuration as default active.
- Validate model using default or a specific variant configuration.
- Query or create variant configurations data object for a given model.

Properties

VariantConfigurations

Set of variant configurations. The names of the configurations must be unique and valid MATLAB variable names.

Constraints

Set of constraints that must always be satisfied by the model for all variant configurations. The name of the constraints must be unique and valid MATLAB variable names.

DefaultConfigurationName

Name of the variant configuration to be used by default for validation.

Methods

| | |
|--|--|
| <code>addConfiguration</code> | Add a new variant configuration to the variant configuration data object |
| <code>addConstraint</code> | Add a constraint to the variant configuration data object |
| <code>addControlVariables</code> | Add control variables to an existing variant configuration |
| <code>addCopyOfConfiguration</code> | Add a copy of an existing variant configuration to the variant configuration data object |
| <code>addSubModelConfigurations</code> | Add to a variant configuration the names of the configurations to be used for submodels |
| <code>getConfiguration</code> | Returns the variant configuration with a given name from a variant configuration data object |
| <code>getDefaultConfiguration</code> | Returns default variant configuration, if any, for a variant configuration data object |
| <code>getFor</code> | Get existing variant configuration data object for a model |
| <code>removeConfiguration</code> | Remove a variant configuration with a given name from the variant configuration data object |
| <code>removeConstraint</code> | Remove a constraint from the variant configuration data object |
| <code>removeControlVariable</code> | Remove a control variable from a variant configuration |
| <code>removeSubModelConfiguration</code> | Remove from a variant configuration, the configuration to be used for a sub model. |
| <code>setDefaultConfigurationName</code> | Set name of the default variant configuration for a variant configuration data object |
| <code>validateModel</code> | Activate and validate all variant blocks in a model hierarchy |
| <code>VariantConfigurationData</code> | Object constructor with optional arguments for variant configurations, constraints, and default configuration name |

Examples

```
load_system(model);  
% Create variant config and associate it with model  
variantConfig = Simulink.VariantConfigurationData;  
set_param(model, 'VariantConfigurationObject', 'variantConfig');
```

See Also

Topics

“Variant Manager Overview”

addConfiguration

Class: Simulink.VariantConfigurationData

Package: Simulink

Add a new variant configuration to the variant configuration data object

Syntax

```
vcdataObj.addConfiguration(name)
vcdataObj.addConfiguration(name,description)
vcdataObj.addConfiguration(name,description,controlVars)
vcdataObj.addConfiguration(name,description,controlVars,
subModelConfigurations)
```

Description

`vcdataObj.addConfiguration(name)` adds a new variant configuration with a given name to the variant configuration data object.

`vcdataObj.addConfiguration(name,description)` adds a new variant configuration with a given name and optional description to the variant configuration data object.

`vcdataObj.addConfiguration(name,description,controlVars)` adds a new variant configuration with a given name, optional description, and control variables to the variant configuration data object.

`vcdataObj.addConfiguration(name,description,controlVars,subModelConfigurations)` adds a new variant configuration with a given name, optional description, control variables, and submodel configurations to the variant configuration data object.

Input Arguments

name

Name of variant configuration being added.

description

Description text for the variant configuration being added.

controlVars

Control variables for the variant configuration being added. This argument must be a vector of structures with required fields: **Name** and **Value**. The values assigned to the **Name** field must be unique and valid MATLAB variable names. The **Value** field can contain either character vectors or `Simulink.Parameter` objects. The values of control variables are checked during validation of the variant configuration.

subModelConfigurations

Vector of structures containing fields: `ModelName`, `ConfigurationName`. The names of submodels must be unique and valid MATLAB variable names and configuration names must be valid MATLAB variables.

Examples

```
% Define the variant configuration data object  
vcdataObj = Simulink.VariantConfigurationData;
```

```
% Add a variant configuration LinInterExp  
vcdataObj.addConfiguration('LinInterExp')
```

See Also

`Simulink.VariantConfigurationData` | `addControlVariables` | `addSubModelConfigurations`

addConstraint

Class: Simulink.VariantConfigurationData

Package: Simulink

Add a constraint to the variant configuration data object

Syntax

```
vcdataObj.addConstraint(nameOfConstraint)
vcdataObj.addConstraint(nameOfConstraint,condition)
vcdataObj.addConstraint(nameOfConstraint,condition,description)
```

Description

`vcdataObj.addConstraint(nameOfConstraint)` adds a new constraint with a given name to `vcdataObj`.

`vcdataObj.addConstraint(nameOfConstraint,condition)` adds a new constraint with a given name and condition expression to `vcdataObj`.

`vcdataObj.addConstraint(nameOfConstraint,condition,description)` adds a new constraint with a given name, condition expression, and description to `vcdataObj`.

Input Arguments

nameOfConstraint

Name of constraint being added. Must be unique and valid MATLAB variable name.

condition

Boolean expression that must evaluate to true. When the expression evaluates to true, it means the constraint is satisfied.

description

Text that describes the constraint.

Examples

```
% Define the variant configuration data object
vcdataObj = Simulink.VariantConfigurationData;

% Add a constraint named LinNotExtern
vcdataObj.addConstraint('LinNotExtern',...
'Ctrl~=1||PlantLocation~=1','Description of the constraint')
```

See Also

Simulink.VariantConfigurationData | removeConstraint | addConfiguration |
removeConfiguration

addControlVariables

Class: Simulink.VariantConfigurationData

Package: Simulink

Add control variables to an existing variant configuration

Syntax

```
vcdataObj.addControlVariables(nameOfConfiguration,controlVars)
```

Description

`vcdataObj.addControlVariables(nameOfConfiguration,controlVars)`, adds control variables to a variant configuration.

Input Arguments

nameOfConfiguration

Specifies the name of an existing configuration.

controlVars

Control variables being added. This argument must be a vector of structures with required fields: Name and Value. The values assigned to the Name field must be unique and valid MATLAB variable names. The Value field can contain either character vectors or Simulink.Parameter objects. The values of control variables are checked during validation of the variant configuration.

Examples

```
% Define the variant configuration data object
vcdataObj = Simulink.VariantConfigurationData;

% Add a variant configuration named LinInterExp
vcdataObj.addConfiguration('LinInterExp',...
'Linear Internal Experimental Plant Controller');

% Add control variables SmartSensor1Mod and PlanLocation
vcdataObj.addControlVariables('LinInterExp',...
    cell2struct({'SmartSensor1Mod', '2';...
                'PlanLocation', '1'},...
                {'Name', 'Value'}, 2))
```

See Also

Simulink.VariantConfigurationData | removeControlVariable | addSubModelConfigurations | removeSubModelConfiguration

addCopyOfConfiguration

Class: Simulink.VariantConfigurationData

Package: Simulink

Add a copy of an existing variant configuration to the variant configuration data object

Syntax

```
vcdataObj.addCopyOfConfiguration(nameOfExistingConfiguration)
vcdataObj.addCopyOfConfiguration(nameOfExistingConfiguration,
nameOfTobeAddedConfiguration)
```

Description

`vcdataObj.addCopyOfConfiguration(nameOfExistingConfiguration)`, adds a new configuration with a default name (default name is based on existing configuration name being copied) as a copy of the existing configuration to the variant configuration data object.

`vcdataObj.addCopyOfConfiguration(nameOfExistingConfiguration, nameOfTobeAddedConfiguration)`, adds a new configuration with a specified name, as a copy of the existing configuration, to the variant configuration data object.

Input Arguments

nameOfExistingConfiguration

Name of existing configuration.

Default:

nameOfTobeAddedConfiguration

Name of new configuration to be added as a copy of the configuration.

Default:

Examples

```
% Define the variant configuration data object
vcdataObj = Simulink.VariantConfigurationData;

% Add the variant configuration LinInterExp
vcdataObj.addConfiguration('LinInterExp',...
    'Linear Internal Experimental Plant Controller');

% Add a copy of variant configuration LinInterExp
% and name the copy as LinExtExp
vcdataObj.addCopyOfConfiguration('LinInterExp', 'LinExtExp')
```

See Also

Simulink.VariantConfigurationData | addConfiguration | removeConfiguration |
setDefaultConfigurationName

addSubModelConfigurations

Class: Simulink.VariantConfigurationData

Package: Simulink

Add to a variant configuration the names of the configurations to be used for submodels

Syntax

```
vcdataObj.addSubModelConfigurations(nameOfConfiguration,  
subModelConfigurations)
```

Description

`vcdataObj.addSubModelConfigurations(nameOfConfiguration, subModelConfigurations)`, specifies names of the configurations to be used for submodels.

Input Arguments

nameOfConfiguration

Name for the configuration of submodels that are model references.

subModelConfigurations

Vector of structures containing fields: `ModelName`, `ConfigurationName`. The names of submodels must be unique and valid MATLAB variable names and configuration names must be valid MATLAB variables.

Examples

- 1 Add the path to the model file.

```
addpath(fullfile(matlabroot,'examples','simulink_variants','main'));
```

- 2 Load the model.

```
load_system('slexVariantManagement');
```

- 3 Obtain variant configuration data object for the model.

```
vcdataObj = Simulink.VariantConfigurationData.getFor('slexVariantManagement');
```

- 4 Add a new submodel configuration to `LinInterExpNoNoise`.

```
vcdataObj.addSubModelConfigurations('LinInterExpNoNoise',...  
[struct('ModelName', 'slexVariantManagementExternalPlantMdlRef',...  
'ConfigurationName', 'LowFid')])
```

See Also

`Simulink.VariantConfigurationData` | `removeSubModelConfiguration` | `addControlVariables` | `removeControlVariable`

getConfiguration

Class: Simulink.VariantConfigurationData

Package: Simulink

Returns the variant configuration with a given name from a variant configuration data object

Syntax

```
vcdataObj.getConfiguration(nameOfConfiguration)
```

Description

`vcdataObj.getConfiguration(nameOfConfiguration)` returns a specific variant configuration that is associated with the variant configuration data object.

Input Arguments

nameOfConfiguration

Name of the variant configuration to be returned.

Examples

```
% Define the variant configuration data object
vcdataObj = Simulink.VariantConfigurationData;

% Add the variant configuration LinInterExp
vcdataObj.addConfiguration('LinInterExp',...
    'Linear Internal Experimental Plant Controller');

% Add a control variable SmartSensor1Mod
vcdataObj.addControlVariables('LinInterExp',...
    [struct('Name','SmartSensor1Mod','Value','2')]);

% Obtain information on the variant configuration..
% LinInterExp from the variant configuration data object
vc = vcdataObj.getConfiguration('LinInterExp')
```

See Also

`Simulink.VariantConfigurationData` | `addConfiguration` | `removeConfiguration` | `getDefaultConfiguration`

getDefaultConfiguration

Class: Simulink.VariantConfigurationData

Package: Simulink

Returns default variant configuration, if any, for a variant configuration data object

Syntax

```
vcdataObj.getDefaultConfiguration
```

Description

`vcdataObj.getDefaultConfiguration` returns the default variant configuration. If no default variant configuration is defined, then `[]` is returned.

Note Setting a default variant configuration for a variant configuration data object is not recommended. Activate and validate the model using a specific variant configuration instead. If you set a default configuration, compiling or simulating the model will apply the default configuration irrespective of the variant control variable values in the global workspace.

Examples

```
% Define the variant configuration data object
vcdataObj = Simulink.VariantConfigurationData;

% Add the variant configuration named LinInterExp
vcdataObj.addConfiguration('LinInterExp',...
    'Linear Internal Experimental Plant Controller');

% Add the variant configuration LinInterStd
vcdataObj.addConfiguration('LinInterStd',...
    'Linear Internal Standard Plant Controller');

% Set LinExtExp as the default variant configuration
vcdataObj.setDefaultConfigurationName('LinInterExp');

% Obtain the default variant configuration
defvc = vcdataObj.getDefaultConfiguration
```

See Also

`Simulink.VariantConfigurationData` | `getConfiguration` | `setDefaultConfigurationName`

getFor

Class: Simulink.VariantConfigurationData

Package: Simulink

Get existing variant configuration data object for a model

Syntax

```
Simulink.VariantConfigurationData.getFor(modelNameOrHandle)
```

Description

`Simulink.VariantConfigurationData.getFor(modelNameOrHandle)`, returns the variant configuration object for the model. If no default variant configuration is defined, then `[]` is returned.

Input Arguments

modelNameOrHandle

Model name or handle.

Examples

```
% Add the path to the model file
addpath(fullfile(matlabroot,'examples','simulink_variants','main'));

% Load the model
load_system('slexVariantManagement');

% Obtain variant configuration data object for the model
% slexVariantManagement
vcdataObj = Simulink.VariantConfigurationData.getFor...
('slexVariantManagement')
```

See Also

`Simulink.VariantConfigurationData`

removeConfiguration

Class: Simulink.VariantConfigurationData

Package: Simulink

Remove a variant configuration with a given name from the variant configuration data object

Syntax

```
vcdataObj.removeConfiguration(nameOfConfiguration)
```

Description

`vcdataObj.removeConfiguration(nameOfConfiguration)` removes the configuration from the variant configuration data object.

Input Arguments

nameOfConfiguration

Name of the configuration to be removed.

Examples

```
% Define the variant configuration data object
vcdataObj = Simulink.VariantConfigurationData;

% Add the LinInterExp variant configuration
% to the variant configuration data object
vcdataObj.addConfiguration('LinInterExp',...
    'Linear Internal Experimental Plant Controller');

% Remove the LinInterExp configuration
% from the variant configuration data object
vcdataObj.removeConfiguration('LinInterExp')
```

See Also

[Simulink.VariantConfigurationData](#) | [addConfiguration](#) | [getConfiguration](#)

removeConstraint

Class: Simulink.VariantConfigurationData

Package: Simulink

Remove a constraint from the variant configuration data object

Syntax

```
vcdataObj.removeConstraint(nameOfConstraint)
```

Description

`vcdataObj.removeConstraint(nameOfConstraint)`, removes the constraint from the variant configuration data object.

Input Arguments

nameOfConstraint

Name of the constraint to be removed.

Examples

```
% Define the variant configuration data object
vcdataObj = Simulink.VariantConfigurationData;

% Add a constraint named LinNotExtern
vcdataObj.addConstraint('LinNotExtern','((Ctrl~=1)...
    || (PlantLocation ~=1))',...
    'Description of the constraint');

% Remove the constraint LinNotExtern
% from the variant configuration
vcdataObj.removeConstraint('LinNotExtern')
```

See Also

Simulink.VariantConfigurationData | addConstraint

removeControlVariable

Class: Simulink.VariantConfigurationData

Package: Simulink

Remove a control variable from a variant configuration

Syntax

```
vcdataObj.removeControlVariable(nameOfConfiguration,nameOfControlVariable)
```

Description

`vcdataObj.removeControlVariable(nameOfConfiguration,nameOfControlVariable)` removes a control variable from a variant configuration.

Input Arguments

nameOfConfiguration

Name of the variant configuration.

nameOfControlVariable

Name of the control variable to be deleted.

Examples

```
% Define the variant configuration data object
vcdataObj = Simulink.VariantConfigurationData;

% Add a variant configuration named LinInterExp
vcdataObj.addConfiguration('LinInterExp',...
    'Linear Internal Experimental Plant Controller');

% Add control variables SmartSensor1Mod and PlanLocation
vcdataObj.addControlVariables('LinInterExp',...
    [struct('Name','SmartSensor1Mod','Value','2')]);

% Remove the control variable SmartSensor1Mod
% from the configuration LinInterExp
vcdataObj.removeControlVariable('LinInterExp',...
    'SmartSensor1Mod')
```

See Also

Simulink.VariantConfigurationData | addControlVariables

removeSubModelConfiguration

Class: Simulink.VariantConfigurationData

Package: Simulink

Remove from a variant configuration, the configuration to be used for a sub model.

Syntax

```
vcdataObj.removeSubModelConfiguration(nameOfConfiguration,nameOfSubModel)
```

Description

`vcdataObj.removeSubModelConfiguration(nameOfConfiguration,nameOfSubModel)`, removes the configuration specified for a submodel.

Input Arguments

nameOfConfiguration

Name of the submodel configuration to be removed.

nameOfSubModel

Name of the submodel from which the configuration must be removed.

Examples

- 1 Add the path to the model file.

```
addpath(fullfile(matlabroot,'examples','simulink_variants','main'));
```

- 2 Load the model.

```
load_system('slexVariantManagement');
```

- 3 Obtain variant configuration data object for the model.

```
vcdataObj = Simulink.VariantConfigurationData.getFor('slexVariantManagement');
```

- 4 Add a new submodel configuration to LinInterExpNoNoise.

```
vcdataObj.addSubModelConfigurations('LinInterExpNoNoise',...
    [struct('ModelName','slexVariantManagementExternalPlantMdlRef',...
        'ConfigurationName','LowFid')]);
```

- 5 Remove the submodel configuration LinInterExpNoNoise from the submodel `slexVariantManagementExternalPlantMdlRef`.

```
vcdataObj.removeSubModelConfiguration('LinInterExpNoNoise',...
    'slexVariantManagementExternalPlantMdlRef')
```

See Also

Simulink.VariantConfigurationData | addSubModelConfigurations

setDefaultConfigurationName

Class: Simulink.VariantConfigurationData

Package: Simulink

Set name of the default variant configuration for a variant configuration data object

Syntax

```
vcdataObj.setDefaultConfigurationName(nameOfConfiguration)
```

Description

`vcdataObj.setDefaultConfigurationName(nameOfConfiguration)` sets the default configuration name. A variant configuration must exist with the same name. If an empty value is passed, then the default configuration name is cleared.

Input Arguments

nameOfConfiguration

Name of the configuration to be set as the default.

Note Setting a default variant configuration for a variant configuration data object is not recommended. Activate and validate the model using a specific variant configuration instead. If you set a default configuration, compiling or simulating the model will apply the default configuration irrespective of the variant control variable values in the global workspace.

Examples

```
% Define the variant configuration data object
vcdataObj = Simulink.VariantConfigurationData;

% Add the LinInterExp variant configuration
vcdataObj.addConfiguration('LinInterExp',...
    'Linear Internal Experimental Plant Controller');

% Set the configuration LinInterExp as default
vcdataObj.setDefaultConfigurationName('LinInterExp');

% Obtain the default variant configuration
dconfig = vcdataObj.getDefaultConfiguration
```

See Also

Simulink.VariantConfigurationData | getDefaultConfiguration

validateModel

Class: Simulink.VariantConfigurationData

Package: Simulink

Activate and validate all variant blocks in a model hierarchy

Syntax

```
Simulink.VariantConfigurationData.validateModel(modelName)  
Simulink.VariantConfigurationData.validateModel(modelName, configName)
```

Description

`Simulink.VariantConfigurationData.validateModel(modelName)`, activates and validates the model and referenced models during simulation.

`Simulink.VariantConfigurationData.validateModel(modelName, configName)`, activates and validates the model and referenced models during simulation optionally using a variant configuration.

Note Activation of a variant configuration performed by this method differs from the Simulink update diagram process. See “Differences Between Variant Manager Activation and the Update Diagram Process”.

Input Arguments

modelName

Name of the model

configName

Name of the configuration to be activated and validated

Examples

- 1 Add the path to the model file.

```
addpath(fullfile(matlabroot, 'examples', 'simulink_variants', 'main'));
```
- 2 Load the model.

```
load_system('slexVariantManagement');
```
- 3 Activate and validate the model `slexVariantManagement` using the configuration `LinInterExpNoNoise`.

```
[valid, errors] = Simulink.VariantConfigurationData.validateModel...  
('slexVariantManagement', 'LinInterExpNoNoise')
```

See Also

Simulink.VariantConfigurationData | getFor

VariantConfigurationData

Class: Simulink.VariantConfigurationData

Package: Simulink

Object constructor with optional arguments for variant configurations, constraints, and default configuration name

Syntax

```
vardataObj = Simulink.VariantConfigurationData(variantConfigurations)
```

Description

`vardataObj = Simulink.VariantConfigurationData(variantConfigurations)`, constructor that creates an empty variant configuration data object. Optionally, can also accept constraints and a default configuration name as inputs.

Input Arguments

variantConfigurations

Configurations that are part of the variant configuration data object.

constraints

Constraints to be satisfied by the model.

defaultConfigurationName

Name of the default configuration

Examples

```
% Create an empty variant configuration data object  
vcdataObj = Simulink.VariantConfigurationData
```

See Also

`Simulink.VariantConfigurationData` | `addConfiguration` | `addConstraint` | `addControlVariables` | `addSubModelConfigurations`

Simulink.VariantManager class

Package: Simulink

Class representing a set of Variant Manager functionality

Description

The variant manager class provides a set of methods to access Variant Manager functionality from the MATLAB command-line. Use an instance of `Simulink.VariantManager` class to:

- Convert the Subsystems or Model block to a Variant Subsystem.
- Find variables used in Variant control expressions.
- Generate a reduced model for specified variant configurations.
- Display or control behavior of a variant condition legend.

Method

| | |
|-------------------------------------|--|
| <code>variantLegend</code> | Display or control behavior of variant condition legend |
| <code>reduceModel</code> | Generate reduced model for specified variant configurations |
| <code>convertToVariant</code> | Convert Subsystem, or Model block, or Variant Model block to a Variant Subsystem block |
| <code>findVariantControlVars</code> | Find variables used in variant control expressions |

See Also

Topics

“Variant Manager Overview”

`variantLegend`

`convertToVariant`

`findVariantControlVars`

variantLegend

Class: Simulink.VariantManager

Package: Simulink

Display or control behavior of variant condition legend

Syntax

```
Simulink.VariantManager.variantLegend(modelName, action)
```

Description

`Simulink.VariantManager.variantLegend(modelName, action)` displays or performs a specified action on the variant condition legend.

Input Arguments

modelName — Model for which the variant legend is displayed

character vector

Model for which the variant legend is displayed, specified as a character vector.

action — Task to be performed on the variant legend

'open' | 'print' | 'showCodeConditions' | 'close'

Task to be performed on the variant condition legend for the model. You can specify the task as:

- 'open' — Displays the variant condition legend for a model. The model must be open. If the legend is opened for the first time, the model is updated.
- 'print' — Prints the data in the variant condition legend. The legend must be open. There is no preview before printing the legend.
- 'showCodeConditions' — Displays code generation conditions column in the variant condition legend. The legend must be open. `showCodeConditions` is used as a name-value pair and accepts 'on' or 'off' as its values.
- 'close' — Closes the variant condition legend belonging to the specified model.

Examples

```
model = 'sldemo_variant_subsystems';  
open_system(model);  
% Open the variant condition legend  
Simulink.VariantManager.variantLegend(model, 'open');  
% Display the code generation conditions  
Simulink.VariantManager.variantLegend(model, 'showCodeConditions', 'on');
```

See Also

Variant Subsystem

Topics

“Create a Simple Variant Model”

“What Are Variants and When to Use Them”

Introduced in R2017b

reduceModel

Class: Simulink.VariantManager

Package: Simulink

Generate reduced model for specified variant configurations

Syntax

```
Simulink.VariantManager.reduceModel(Model)
Simulink.VariantManager.reduceModel(Model, Name, Value)
```

Description

`Simulink.VariantManager.reduceModel(Model)` creates a reduced model for the specified configuration. The referenced models and library blocks are also reduced. By default, the name of the reduced model and any reduced child referenced model name is the original model name suffixed with `_r`.

`Simulink.VariantManager.reduceModel(Model, Name, Value)` specifies the reduction parameters in the `Name` and `Value` arguments form.

Input Arguments

Model — Model to be reduced

character vector

Required field. Model to be reduced, specified as a character vector.

Name-Value Pair Arguments

Specify optional `Name`, `Value` arguments. `Name` is the argument name and `Value` is the corresponding value. You can specify several name and value arguments in any order as `Name1, Value1, ..., NameN, ValueN`.

NamedConfigurations — Variant configuration name

{' '} | character vector | 'cell array'

Specifies the names of variant configurations. By default, current values of variant control variables are used for reduction.

VariableGroups — Variant control variable value

{' '} | 'cell array'

Specifies the variant control variable values to be used for reduction. By default, the current values of variant control variables are used.

The specified values must be a cell array with variant control variable names and their corresponding values.

Note 'VariableGroups' and 'NamedConfigurations' are mutually exclusive.

Consider this example:

```
Simulink.VariantManager.reduceModel('iv_model', ...
    'VariableGroups',...
    {'V',1,'W',1},{V',2,'W',2})
```

FullRangeVariables — Variant control variable value

{'} | 'cell array'

Specifies the full-range variant control variable values to be used for reduction. This allows you to reduce a model for all valid values of the specified variant control variable. Provide a reference value for variant control variable that results in a successful model compilation.

Consider this example:

```
Simulink.VariantManager.reduceModel('slexVariantReducer',...
    'VariableGroups',{'V',1},...
    'FullRangeVariables',{'W',1});
```

You can specify a variant control variable, 'W', as a full-range variant control variable. This allows you to reduce the model for all valid values of variable 'W'. In the example, full-range variant control variable W uses a reference value of 1.

CompileMode — Compilation mode

{'sim'} | 'codegen'

Specifies whether the model should be compiled for simulation or code generation mode as part of reduction. If the model contains variant blocks with the **Variant control mode** parameter set to `sim` `codegen` switching, you can specify the value as `codegen` to retain the code generation branches of the blocks in the reduced model. For the default value `sim`, Variant Reducer compiles and retains the simulation branches in the top-level model.

OutputFolder — Folder to store the reduced model

character vector

Specifies the folder to place the reduced models and related artifacts. By default, the reduced models are generated in `./reducedModel` subfolder in the original model folder.

PreserveSignalAttributes — Preserve the signal attributes in the reduced model

{true} | false

When the value is `true`, the Variant Reducer preserves the compiled signal attributes between the original and reduced models by adding signal specification blocks at appropriate block ports in the reduced model. Compiled signal attributes include signal data types, signal dimensions, compiled sample times, etc.

Verbose — Displays step details

true | {false}

When the value is `true`, the Variant Reducer displays details of the steps performed during model reduction.

ModelSuffix — Reduced model name suffix

{_r}

Specifies the suffix to append to the reduced models and the related artifacts.

GenerateSummary — Generates a summary html file

true | {false}

When the value is `true`, the Variant Reducer generates a html file with details about the reduced model and any modifications that may be required for masks and callbacks.

Note To generate summary, you must have **Simulink Report Generator** license.

Examples

```
% Reduce model based on its variant control variable values in the base workspace.
Simulink.VariantManager.reduceModel('sldemo_variant_subsystems');
```

```
% Reduce the model associated with a variant configuration data object and configurations to be retained in the reduced model.
Simulink.VariantManager.reduceModel('slexVariantManagement', ...
    'NamedConfigurations', {'LinInterStd',
        'NonLinExterHighFid'})
```

```
% Reduce the model by specifying variant control variable values. Here, two groups are specified corresponding to
% {V==1, W==1}, and {V==2, W==2} respectively.
Simulink.VariantManager.reduceModel('iv_model', ...
    'VariableGroups',...
    {'V',1,'W',1},{V',2,'W',2});
```

```
% Reduce the model by specifying variant control variable values where 'W' is a full-range variant control variable and
% automatically maps the specification to correspond to the following four explicit groups: {V==1, W==1}, {V==1, W==2},
% {V==2, W==1}, and {V==2, W==2}.
Simulink.VariantManager.reduceModel('slexVariantReducer',...
    'VariableGroups',...
    {'V',1},...
    'FullRangeVariables',{'W',1});
```

```
% Reduce the model by specifying the compilation mode as code generation.
Simulink.VariantManager.reduceModel...
('slexVariantReducer','NamedConfigurations', {'config1'}, 'CompileMode', 'codegen', 'OutputFolder', 'L:\Models');
```

See Also

Variant Subsystem

Topics

“Create a Simple Variant Model”

“What Are Variants and When to Use Them”

Simulink.VariantManager

variantLegend

Introduced in R2016a

convertToVariant

Class: Simulink.VariantManager

Package: Simulink

Convert Subsystem, or Model block, or Variant Model block to a Variant Subsystem block

Syntax

```
variant_subsystem = Simulink.VariantManager.convertToVariant(block)
variant_subsystem = Simulink.VariantManager.convertToVariant(blockHandle)
```

Description

`variant_subsystem = Simulink.VariantManager.convertToVariant(block)` or `variant_subsystem = Simulink.VariantManager.convertToVariant(blockHandle)` converts a Subsystem, or Model block, or Variant Model block to a Variant Subsystem block. A Variant Subsystem can contain Subsystems, Model blocks, or both as choices.

Consider this model with Subsystem block.



You can convert this Subsystem block to a Variant Subsystem block using the `convertToVariant` method.

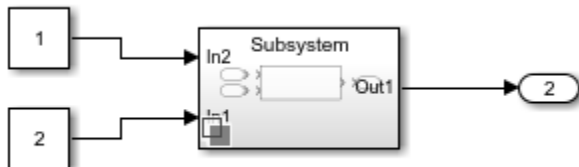

Similarly you can convert a Variant Model block to a Variant Subsystem block.

To convert a Variant Model block to a Variant Subsystem block, you can also use the Upgrade Advisor check, **Identify Variant Model blocks and convert those to Variant Subsystem containing Model block choices**. This check provides a **Fix** button to convert Variant Model blocks to Variant Subsystem blocks. For more information on using Upgrade Advisor check to convert a Variant Model block to a Variant Subsystem block, see “Upgrade Advisor Checks”

If there are inconsistencies in the port name or port number in models referenced by Variant Model block, Simulink corrects these inconsistencies while converting the Variant Model block to Variant Subsystem block.

Consider this model with Variant Model block having different port names.

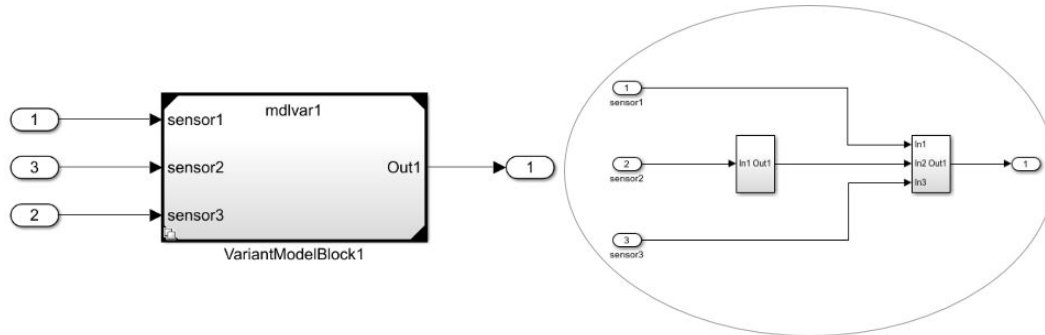

When you convert this Variant Model block to a Variant Subsystem block, the inconsistencies are corrected automatically.

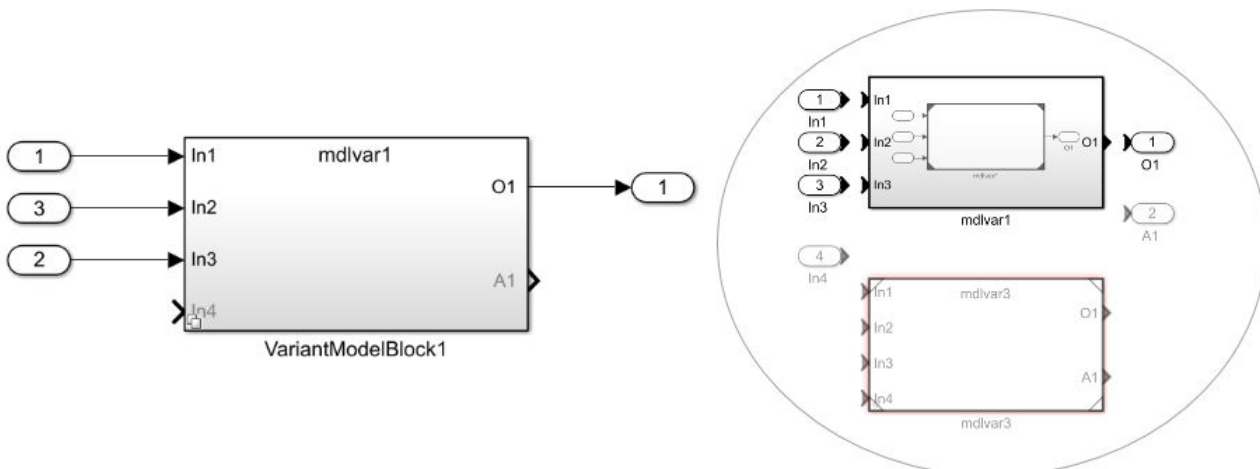

Note Future releases will no longer support using a Model block to contain model variants. You can use the `convertToVariant` method to convert model variants so that Model blocks are contained in a Variant Subsystem. Use of a Variant Subsystem block provides these advantages:

- Allows you to mix Model and Subsystem blocks as variant choices
- Supports flexible I/O, so that all variants do not need to have the same number of input and output ports

For an example of a model that uses a Variant Subsystem block as a container for variant models, see “Model Reference Variants” on page 13-451.

Limitations

You cannot convert a Subsystem block that meets the following condition:

- The Subsystem block is in a Simscape model that has Editing Mode set to **Restricted**.
- The Variant Model block has a mix of control ports or there is a name mismatch in control port types.
- The Variant Model block has control ports with different port numbers and name mapping.

Input Arguments

block — Subsystem or Model block to convert

block path | block handle

The path or block handle of the Subsystem or Model block to convert to a Variant Subsystem block. Specify a block path as a character vector and a block handle as a scalar.

Output Arguments

variant_subsystem — Handle of Variant Subsystem block

scalar returned by Simulink

If you specify an output argument, the method returns the block handle of the Variant Subsystem block created by the conversion.

Examples

```
openExample('sldemo_mdref_conversion');  
Simulink.VariantManager.convertToVariant('sldemo_mdref_conversion/Bus Counter');
```

Alternative Functionality

Simulink Editor

In the Simulink Editor, right-click the Model block and select **Subsystems & Model Reference > Convert to > Variant Subsystem**.

See Also

Variant Subsystem

Topics

“Create a Simple Variant Model”

“What Are Variants and When to Use Them”

Introduced in R2017b

findVariantControlVars

Class: Simulink.VariantManager

Package: Simulink

Find variables used in variant control expressions

Syntax

```
vars = findVariantControlVars(Model)
vars = findVariantControlVars(Model, 'SearchReferencedModels', 'on')
```

Description

`vars = findVariantControlVars(Model)` returns the variant control variables used by variant blocks in the model, `Model`. If the variant control is a `Simulink.Variant` object, then the variables are retrieved from the variant condition within the object.

`vars = findVariantControlVars(Model, 'SearchReferencedModels', 'on')` enables the search in referenced models.

Input Arguments

Model — Model name

character vector

Model name for which variant control variables must be found, specified as character vector.

Data Types: char

'SearchReferencedModels' — Option to search in referenced models

'on' (default) | 'off'

Option to search in referenced models within the given model, specified as 'on' or 'off'. By default, search is enabled for referenced models.

Data Types: char

Output Arguments

vars — Variant control variables for model

struct

Variant control variables for model, returned as an N -by-1 struct with fields:

Name: Name of the variable used in the variant control expression.

Value: Value of the variable. This field will be \emptyset if the variable is not defined in the global workspace of the model.

Exists: Logical value that indicates if the variable is defined in the global workspace of the model. If the variable is defined in the global workspace, value is `true`; otherwise `false`.

Source: Value is either base workspace or the *name* of the data dictionary where the variable is stored.

SourceType: Value is either base workspace or data dictionary depending on where the variable is stored.

Examples

Find Variant Control Variables for a Model

Open the model `slexVariantManagement`.

```
cd(fullfile(matlabroot, 'examples', 'simulink_variants', 'main'));
model = 'slexVariantManagement';
open_system(model);
```

Find the variant control variables.

```
vars = Simulink.VariantManager.findVariantControlVars(model)
```

vars=6x1 struct array with fields:

```
Name
Value
Exists
Source
SourceType
```

Limitations

- `Simulink.VariantManager.findVariantControlVars` does not report the variant control variable objects (created using the `Simulink.VariantControl` class) referred in variant parameters (instance of `Simulink.VariantVariable` class) in a model.

See Also

[convertToVariant](#) | [variantLegend](#) | [reduceModel](#) | [Simulink.VariantManager](#)

Topics

“Introduction to Variant Controls”

Introduced in R2015a

Simulink.WorkspaceVar

Store information about workspace variables and blocks that use them

Note `Simulink.WorkspaceVar` is not recommended. Use `Simulink.VariableUsage` instead.

Description

A `Simulink.WorkspaceVar` object describes attributes of a workspace variable and lists the blocks that use the variable.

Creation

The `Simulink.findVars` function returns one or more `Simulink.WorkspaceVar` objects that embody the results of searching for variables.

Only the `Simulink.WorkspaceVar` function can set any field value in a `Simulink.WorkspaceVar` object. The fields are otherwise read-only.

Syntax

```
varObj = Simulink.WorkspaceVar(varNames, wkspName)
```

Description

`varObj = Simulink.WorkspaceVar(varNames, wkspName)` creates an array of `Simulink.WorkspaceVar` objects to describe the variables `varNames`. The constructor sets the `Name` property of each object to one of the variable names specified by `varNames`, and sets the `Workspace` property of all the objects to the workspace specified by `wkspName`. You can specify `varNames` with variables that are not used in any loaded models.

Input Arguments

varNames — Names of target variables

character vector | cell array of character vectors

Names of target variables, specified as a character vector or a cell array of character vectors. The constructor creates a `Simulink.WorkspaceVar` object for each variable name. You can specify `varNames` with variables that are not used in any loaded models.

Example: 'k'

Example: {'k', 'asdf', 'fuelFlow'}

Data Types: char | cell

wkspName — Name of containing workspace

character vector

Name of the workspace that defines the target variables, specified as a character vector. For example, you can specify the MATLAB base workspace. The constructor also determines and sets the `WorkspaceType` property of each of the returned `Simulink.WorkspaceVar` objects.

Example: 'base workspace'

Example: 'myModel'

Example: 'myDictionary.slidd'

Data Types: char

Properties

Name — Name of variable

' ' (empty character vector) (default) | character vector

This property is read-only.

Name of the variable described by the object, returned as a character vector.

Workspace — Name of workspace that contains variable

' ' (empty character vector) (default) | character vector

This property is read-only.

Name of the workspace that contains the variable, returned as a character vector. For example:

| Workspace value | Meaning |
|------------------|---|
| 'base workspace' | The MATLAB base workspace |
| 'MyModel' | The model workspace for the model MyModel. |
| 'MyModel/Mask1' | The mask workspace for the masked block Mask1 in the model MyModel. |

WorkspaceType — Type of workspace containing variable

'unknown' (default) | 'base' | 'model' | 'mask'

This property is read-only.

Type of workspace that contains the variable, returned as a character vector. The possible values are:

- 'base' — The base workspace
- 'model' — A model workspace
- 'mask' — A mask workspace

UsedByBlocks — Users of variable

{ } (empty cell array) (default) | cell array of character vectors

This property is read-only.

Users of the variable, returned as a cell array of character vectors. Each character vector identifies a block that uses the variable. The `Simulink.findVars` function populates this property.

Object Functions

`intersect` Return intersection of two arrays of `Simulink.VariableUsage` objects
`setdiff` Return difference between two arrays of `Simulink.VariableUsage` objects

Examples

Create Object That Represents Variable in Base Workspace

Return a `Simulink.WorkspaceVar` object for a variable `k` in the base workspace.

```
var = Simulink.WorkspaceVar('k', 'base workspace');
```

Represent All Variables in the Base Workspace

Return an array of `Simulink.WorkspaceVar` objects containing one object for each variable returned by the `whos` command in the base workspace.

```
vars = Simulink.WorkspaceVar(who,WkspName)
```

Represent All Variables in a Model Workspace

Return an array of `Simulink.WorkspaceVar` objects that describes all the variables in a model workspace.

```
hws = get_param('mymodel', 'ModelWorkspace');  
vars=Simulink.WorkspaceVar(hws.whos, 'MyModel')
```

Represent All Variables in a Mask Workspace

Return an array of `Simulink.WorkspaceVar` objects that describes all the variables in a mask workspace.

```
maskVars = get_param('mymodel/maskblock', 'MaskWSVariables');  
vars = Simulink.WorkspaceVar(maskVars, 'mymodel/maskblock');
```

See Also

`Simulink.findVars` | `setdiff` | `intersect`

Introduced in R2010a

Simulink.VariableUsage

Store information about the relationship between variables and blocks in models

Description

A `Simulink.VariableUsage` object describes where a variable is used in models.

Use this information to:

- Prepare to permanently store the variables in files and workspaces. For more information about storing variables for a model, see “Determine Where to Store Variables and Objects for Simulink Models”.
- Reduce the number of variables that you need to store by eliminating unused variables.
- Prepare to partition variables and establish variable ownership when you work in a team.

To analyze variable usage in models, use `Simulink.VariableUsage` objects together with the `Simulink.findVars` function. The function returns and accepts `Simulink.VariableUsage` objects as arguments. For more information, see `Simulink.findVars`.

A `Simulink.VariableUsage` object can also describe the usage of an enumerated data type.

Only a `Simulink.VariableUsage` constructor or the `Simulink.findVars` function can set property values in a `Simulink.VariableUsage` object. The properties are otherwise read only.

Creation

The `Simulink.findVars` function returns `Simulink.VariableUsage` objects.

To create variable usage objects for use as a filter when using `Simulink.findVars`, use the `Simulink.VariableUsage` function described below.

Syntax

```
variableUsageObj = Simulink.VariableUsage(varNames,sourceName)
```

Description

`variableUsageObj = Simulink.VariableUsage(varNames,sourceName)` creates an array of `Simulink.VariableUsage` objects to describe the variables `varNames`. The constructor sets the `Name` property of each object to one of the variable names specified by `varNames`, and sets the `Source` property of all the objects to the source specified by `sourceName`. You can specify `varNames` with variables that are not used in any loaded models.

Input Arguments

varNames — Names of target variables

character vector | cell array of character vectors

Names of target variables, specified as a character vector or a cell array of character vectors. The constructor creates a `Simulink.VariableUsage` object for each variable name.

Example: `'k'`

Example: `{'k','asdf','fuelFlow'}`

Data Types: `char` | `cell`

sourceName — Name of variable source

character vector

Name of the source that defines the target variables, specified as a character vector. For example, you can specify the MATLAB base workspace or a data dictionary as a source. The constructor also determines and sets the `SourceType` property of each of the returned `Simulink.VariableUsage` objects.

Example: `'base workspace'`

Example: `'myModel'`

Example: `'myDictionary.sldd'`

Data Types: `char`

Properties

Name — Name of variable or enumerated type

`''` (empty character vector) (default) | character vector

This property is read-only.

The name of the variable or enumerated data type the object describes, returned as a character vector.

Source — Name of defining workspace

`''` (empty character vector) (default) | character vector

This property is read-only.

The name of the workspace or data dictionary that defines the described variable, returned as a character vector. The table shows some examples.

| Source Value | Meaning |
|--|--|
| <code>'base workspace'</code> | MATLAB base workspace |
| <code>'MyModel'</code> | Model workspace for the model <code>MyModel</code> |
| <code>'MyModel/Mask1'</code> | Mask workspace for the masked block <code>Mask1</code> in the model <code>MyModel</code> |
| <code>'sldemo_fuelsys_dd_controller.sldd'</code> | The data dictionary named <code>'sldemo_fuelsys_dd_controller.sldd'</code> |

The table shows some examples if you created the `Simulink.VariableUsage` object by using the `Simulink.findVars` function to find enumerated data types.

| Source Value | Meaning |
|-------------------------------------|--|
| 'BasicColors.m' | The enumerated type is defined in the MATLAB file 'BasicColors.m'. |
| ' ' | The enumerated type is defined dynamically and has no source. |
| 'sldemo_fuelsys_dd_controller.sldd' | The enumerated type is defined in the data dictionary named 'sldemo_fuelsys_dd_controller.sldd'. |

SourceType — Type of defining workspace

'unknown source' (default) | 'base workspace' | 'model workspace' | 'mask workspace' | 'data dictionary'

This property is read-only.

The type of the workspace that defines the variable, returned as a character vector. The possible values are:

- 'base workspace'
- 'model workspace'
- 'mask workspace'
- 'data dictionary'

If you created the `Simulink.VariableUsage` object by using the `Simulink.findVars` function to find enumerated data types, the possible values are:

- 'MATLAB file'
- 'dynamic class'
- 'data dictionary'

Users — Blocks that use the variable or models that use the enumerated type

{ } (empty cell array) (default) | cell array of character vectors

This property is read-only.

Blocks that use the variable or models that use the enumerated type, returned as a cell array of character vectors. Each character vector names a block or model that uses the variable or enumerated type. The `Simulink.findVars` function populates this property.

Object Functions

`intersect` Return intersection of two arrays of `Simulink.VariableUsage` objects
`setdiff` Return difference between two arrays of `Simulink.VariableUsage` objects
`union` Return union of two arrays of `Simulink.VariableUsage` objects

Examples

Create Object That Represents Variable in Base Workspace

Return a `Simulink.VariableUsage` object for a variable `k` in the base workspace.

```
var = Simulink.VariableUsage('k', 'base workspace');
```

You can use `var` as a filter for the `Simulink.findVars` function.

Represent All Variables in the Base Workspace

Return an array of `Simulink.VariableUsage` objects containing one object for each variable returned by the `whos` command in the base workspace.

```
vars = Simulink.VariableUsage(whos,'base workspace')
```

Represent All Variables in a Model Workspace

Return an array of `Simulink.VariableUsage` objects that describes all the variables in a model workspace.

```
hws = get_param('mymodel','ModelWorkspace');  
vars = Simulink.VariableUsage(hws.whos,'MyModel')
```

Represent All Variables in a Mask Workspace

Return an array of `Simulink.VariableUsage` objects that describes all the variables in a mask workspace.

```
maskVars = get_param('mymodel/maskblock','MaskWSVariables');  
vars = Simulink.VariableUsage(maskVars,'mymodel/maskblock');
```

See Also

`Simulink.findVars` | `Simulink.data.existsInGlobal`

Topics

“Manage Design Data”

Introduced in R2012b

Simulink.VariantConfigurationAnalysis class

Package: Simulink

Class representing a set of Variant Configuration Analysis functionality

Description

The `Simulink.VariantConfigurationAnalysis` class has methods that enable you to analyze or compare model references and libraries for each variant configuration in a model containing variant blocks. Use an instance of `Simulink.VariantConfigurationAnalysis` class to do the following:

- Get a list of active blocks for variant configuration
- Find blocks which are active across all variant configurations
- Find blocks which are inactive in all variant configurations
- Get a list of blocks which differ in active choice between variant configurations
- Get a list of active models for variant configuration
- Get a list of libraries which are used in variant configuration
- View variant configuration analysis in user interface screen
- Hide variant configuration analysis report
- View variant condition for blocks in given variant configuration

Properties

NamedConfigurations

Specifies the names of variant configuration(s) you want to analyze. The names are defined by the Variant Manager and saved in a variant configuration object associated with the model. If the model is associated with a variant configuration object, then the `VariantConfigurationObject` parameter is set to a `Simulink.VariantConfigurationData` object. For example, consider a variant configuration object "vcd", then `NamedConfigurations` must be one or multiple configuration names that is defined in "vcd". `NamedConfigurations` can be a string or a cell array of strings.

Method

| | |
|------------------------------------|--|
| <code>getActiveBlocks</code> | Returns a list of active blocks for variant configuration |
| <code>getAlwaysActiveBlocks</code> | Displays a list of blocks that are always active across all variant configurations |
| <code>getNeverActiveBlocks</code> | Returns a list of blocks that are inactive in all variant configurations |
| <code>getBlockDifferences</code> | Returns a list of blocks that differ in active choice between variant configurations |
| <code>getDependentModels</code> | Returns a list of active models for variant configurations |
| <code>getDependentLibraries</code> | Returns a list of libraries that are used in variant configurations |
| <code>showUI</code> | Displays variant configuration analysis in user interface view |
| <code>hideUI</code> | Hides variant configuration analysis report |
| <code>getVariantCondition</code> | Returns variant conditions for blocks in given variant configuration |

See Also

Topics

“Variant Manager Overview”

getActiveBlocks

Class: Simulink.VariantConfigurationAnalysis

Package: Simulink

Returns a list of active blocks for variant configuration

Syntax

```
activeBlocks = VarConfigObj.getActiveBlocks(ConfigName)
```

Description

`activeBlocks = VarConfigObj.getActiveBlocks(ConfigName)` returns a list of active blocks for variant configuration.

Input Arguments

VarConfigObj — Variant configuration object

character vector

Variant configuration object for a specified configuration. You can use the `Simulink.VariantConfigurationAnalysis` method to obtain this value.

ConfigName — Variant configuration name

character vector | string

Specifies the name of variant configuration.

Output Arguments

activeBlocks — List of active blocks

cell array

Returns a list of active blocks as a cell array.

Examples

```
% Add model to path
addpath(fullfile(matlabroot,'examples','simulink_variants','main'));

% Open model
open_system('slexVariantManagement');

% Get variant configuration object
VarConfigObj = Simulink.VariantConfigurationAnalysis('slexVariantManagement', 'NamedConfigurations', {'LinInterStd', ...
'NonLinExterLowFid', 'NonLinExterHighFid'})

% Get active blocks
ActiveBlocks = VarConfigObj.getActiveBlocks('LinInterStd')
```

See Also

“Analyze Variant Configurations in Models Containing Variant Blocks” | “Variant Manager Overview”

Topics

“Create a Simple Variant Model”

Introduced in R2019a

getAlwaysActiveBlocks

Class: Simulink.VariantConfigurationAnalysis

Package: Simulink

Displays a list of blocks that are always active across all variant configurations

Syntax

```
alwaysActiveBlocks = VarConfigObj.getAlwaysActiveBlocks()
```

Description

`alwaysActiveBlocks = VarConfigObj.getAlwaysActiveBlocks()` displays a list of blocks that are always active across all variant configurations.

Input Arguments

VarConfigObj — Variant configuration object

character vector

Variant configuration object for a specified configuration. You can use the `Simulink.VariantConfigurationAnalysis` method to obtain this value.

Output Arguments

alwaysActiveBlocks — List of always active blocks

cell array

Displays a list of blocks that are always active, as a cell array.

Examples

```
% Add model to path
addpath(fullfile(matlabroot,'examples','simulink_variants','main'));

% Open model
open_system('slexVariantManagement');

% Get variant configuration object
VarConfigObj = Simulink.VariantConfigurationAnalysis('slexVariantManagement', 'NamedConfigurations', {'LinInterStd', ...
'NonLinExterLowFid', 'NonLinExterHighFid'})

% Get always active blocks
alwaysActiveBlocks = VarConfigObj.getAlwaysActiveBlocks()
```

See Also

“Analyze Variant Configurations in Models Containing Variant Blocks” | “Variant Manager Overview”

Topics

“Create a Simple Variant Model”

Introduced in R2019a

getNeverActiveBlocks

Class: Simulink.VariantConfigurationAnalysis

Package: Simulink

Returns a list of blocks that are inactive in all variant configurations

Syntax

```
getNeverActiveBlocks = VarConfigObj.getNeverActiveBlocks()
```

Description

`getNeverActiveBlocks = VarConfigObj.getNeverActiveBlocks()` returns a list of blocks that are inactive in all variant configurations.

Input Arguments

VarConfigObj — Variant configuration object

character vector

Variant configuration object for a specified configuration. You can use the `Simulink.VariantConfigurationAnalysis` method to obtain this value.

Output Arguments

neverActiveBlocks — List of never active blocks

cell array

Returns a list of blocks that are never active, as a cell array.

Examples

```
% Add model to path
addpath(fullfile(matlabroot,'examples','simulink_variants','main'));

% Open model
open_system('slexVariantManagement');

% Get variant configuration object
VarConfigObj = Simulink.VariantConfigurationAnalysis('slexVariantManagement', 'NamedConfigurations', {'LinInterStd', ...
'NonLinExterLowFid', 'NonLinExterHighFid'})

% Get never active blocks
neverActiveBlocks = VarConfigObj.getNeverActiveBlocks()
```

See Also

“Analyze Variant Configurations in Models Containing Variant Blocks” | “Variant Manager Overview”

Topics

“Create a Simple Variant Model”

Introduced in R2019a

getBlockDifferences

Class: Simulink.VariantConfigurationAnalysis

Package: Simulink

Returns a list of blocks that differ in active choice between variant configurations

Syntax

```
getBlockDifferences = VarConfigObj.getBlockDifferences()
```

Description

`getBlockDifferences = VarConfigObj.getBlockDifferences()` returns a list of blocks that are active in some of the analyzed configurations and inactive in other configurations.

Input Arguments

VarConfigObj — Variant configuration object

character vector

Variant configuration object for a specified configuration. You can use the `Simulink.VariantConfigurationAnalysis` method to obtain this value.

Output Arguments

getBlockDifferences — List of blocks that differ in active choice

cell array

Returns a list of blocks that differ in active choice between variant configurations, as a cell array.

Examples

```
% Add model to path
addpath(fullfile(matlabroot,'examples','simulink_variants','main'));

% Open model
open_system('slexVariantManagement');

% Get variant configuration object
VarConfigObj = Simulink.VariantConfigurationAnalysis('slexVariantManagement', 'NamedConfigurations', {'LinInterStd', ...
'NonLinExterLowFid', 'NonLinExterHighFid'})

% Get block differences
getBlockDifferences = VarConfigObj.getBlockDifferences()
```

See Also

“Analyze Variant Configurations in Models Containing Variant Blocks” | “Variant Manager Overview”

Topics

“Create a Simple Variant Model”

Introduced in R2019a

getDependentModels

Class: Simulink.VariantConfigurationAnalysis

Package: Simulink

Returns a list of active models for variant configurations

Syntax

```
dependentModels = VarConfigObj.getDependentModels(ConfigName)
```

Description

`dependentModels = VarConfigObj.getDependentModels(ConfigName)` returns a list of active models for variant configuration.

Input Arguments

VarConfigObj — Variant configuration object

character vector

Variant configuration object for a specified configuration. You can use the `Simulink.VariantConfigurationAnalysis` method to obtain this value.

ConfigName — Variant configuration name

character vector | string

Specifies the name of variant configuration.

Output Arguments

dependentModels — List of models

cell array

Returns a list of active models, as a cell array.

Examples

```
% Add model to path
addpath(fullfile(matlabroot,'examples','simulink_variants','main'));

% Open model
open_system('slexVariantManagement');

% Get variant configuration object
VarConfigObj = Simulink.VariantConfigurationAnalysis('slexVariantManagement', 'NamedConfigurations', {'LinInterStd', ...
'NonLinExterLowFid', 'NonLinExterHighFid'})

% Get dependent models
dependentModels = VarConfigObj.getDependentModels('NonLinExterLowFid')
```

See Also

“Analyze Variant Configurations in Models Containing Variant Blocks” | “Variant Manager Overview”

Topics

“Create a Simple Variant Model”

Introduced in R2019a

getDependentLibraries

Class: Simulink.VariantConfigurationAnalysis

Package: Simulink

Returns a list of libraries that are used in variant configurations

Syntax

```
dependentLibraries = VarConfigObj.getDependentLibraries(ConfigName)
```

Description

`dependentLibraries = VarConfigObj.getDependentLibraries(ConfigName)` returns a list of libraries that are used in variant configuration.

Input Arguments

VarConfigObj — Variant configuration object

character vector

Variant configuration object for a specified configuration. You can use the `Simulink.VariantConfigurationAnalysis` method to obtain this value.

ConfigName — Variant configuration name

character vector | string

Specifies the name of variant configuration.

Output Arguments

dependentLibraries — List of libraries

cell array

Returns a list of libraries, as a cell array.

Examples

```
% Add model to path
addpath(fullfile(matlabroot,'examples','simulink_variants','main'));

% Open model
open_system('slexVariantConfigurationAnalysis');

% Get variant configuration object
VarConfigObj = Simulink.VariantConfigurationAnalysis('slexVariantConfigurationAnalysis', 'NamedConfigurations', {'VendorACtrlNonLinear', 'VendorACtrlFuzzy'})

% Get dependent libraries
dependentLibraries = VarConfigObj.getDependentLibraries('VendorACtrlLinear')
```

See Also

“Analyze Variant Configurations in Models Containing Variant Blocks” | “Variant Manager Overview”

Topics

“Create a Simple Variant Model”

Introduced in R2019a

showUI

Class: Simulink.VariantConfigurationAnalysis

Package: Simulink

Displays variant configuration analysis in user interface view

Syntax

```
VarConfigObj.showUI()
```

Description

`VarConfigObj.showUI()`, displays variant configuration analysis in user interface view.

Examples

```
% Add model to path
addpath(fullfile(matlabroot,'examples','simulink_variants','main'));

% Open model
open_system('slexVariantManagement');

% Get variant configuration object
VarConfigObj = Simulink.VariantConfigurationAnalysis('slexVariantManagement', 'NamedConfigurations', {'LinInterStd', ...
'NonLinExterLowFid', 'NonLinExterHighFid'})

% Show UI
VarConfigObj.showUI()
```

See Also

“Analyze Variant Configurations in Models Containing Variant Blocks” | “Variant Manager Overview”

Topics

“Create a Simple Variant Model”

Introduced in R2019a

hideUI

Class: Simulink.VariantConfigurationAnalysis

Package: Simulink

Hides variant configuration analysis report

Syntax

```
VarConfigObj.hideUI()
```

Description

`VarConfigObj.hideUI()`, hides the variant configuration analysis report.

Examples

```
% Add model to path
addpath(fullfile(matlabroot,'examples','simulink_variants','main'));

% Open model
open_system('slexVariantManagement');

% Get variant configuration object
VarConfigObj = Simulink.VariantConfigurationAnalysis('slexVariantManagement', 'NamedConfigurations', {'LinInterStd', ...
'NonLinExterLowFid', 'NonLinExterHighFid'})

% Hide UI
VarConfigObj.hideUI()
```

See Also

“Analyze Variant Configurations in Models Containing Variant Blocks” | “Variant Manager Overview”

Topics

“Create a Simple Variant Model”

Introduced in R2019b

getVariantCondition

Class: Simulink.VariantConfigurationAnalysis

Package: Simulink

Returns variant conditions for blocks in given variant configuration

Syntax

```
variantCondition = VarConfigObj.getVariantCondition(ConfigName,BlockName)
```

Description

`variantCondition = VarConfigObj.getVariantCondition(ConfigName,BlockName)`, returns the variant condition for block specified by `BlockName` in given variant configuration.

Input Arguments

VarConfigObj — Variant configuration object

character vector

Variant configuration object for a specified configuration. You can use the `Simulink.VariantConfigurationAnalysis` method to obtain this value.

ConfigName — Variant configuration name

character vector | string

Specifies the name of variant configuration.

BlockName — Block name

character vector | string

Name of the block.

Output Arguments

variantCondition — Variant conditions for a block

cell array

Returns variant conditions for blocks in given variant configuration.

Examples

```
% Add model to path
addpath(fullfile(matlabroot,'examples','simulink_variants','main'));

% Open model
open_system('slexVariantManagement');

% Get variant configuration object
VarConfigObj = Simulink.VariantConfigurationAnalysis('slexVariantManagement',...
'NamedConfigurations', {'LinInterStd','NonLinExterLowFid', 'NonLinExterHighFid'})
```

```
% Get variant condition
VariantCondition = VarConfigObj.getVariantCondition('NonLinExterLowFid',...
'slexVariantManagement/Controller/Linear Controller')
```

See Also

“Analyze Variant Configurations in Models Containing Variant Blocks” | “Variant Manager Overview”

Topics

“Create a Simple Variant Model”

Introduced in R2019b

intersect

Package: Simulink

Return intersection of two arrays of Simulink.VariableUsage objects

Syntax

```
VarsOut = intersect(VarsIn1,VarsIn2)
```

Description

`VarsOut = intersect(VarsIn1,VarsIn2)` returns an array that identifies the variables described in `VarsIn1` and in `VarsIn2`, which are arrays of Simulink.VariableUsage objects. If a variable is described by a Simulink.VariableUsage object in `VarsIn1` and in `VarsIn2`, the function returns a Simulink.VariableUsage object that stores the variable usage information from both objects in the `Users` property.

`intersect` compares the `Name`, `Source`, and `SourceType` properties of the Simulink.VariableUsage objects in `VarsIn1` with the same properties of the objects in `VarsIn2`. If `VarsIn1` and `VarsIn2` each contain Simulink.VariableUsage objects that have the same values for these three properties, they both describe the same variable.

To create Simulink.VariableUsage objects that describe the usage of variables in a model, use the Simulink.findVars function.

Examples

Compare Variables Used by Models

Given two models, discover the variables needed by both models.

```
model1Vars = Simulink.findVars('model1');  
model2Vars = Simulink.findVars('model2');  
commonVars = intersect(model1Vars,model2Vars);
```

Input Arguments

VarsIn1 — First array of variables for comparison

array of Simulink.VariableUsage objects

First array of variables for comparison, specified as an array of Simulink.VariableUsage objects.

VarsIn2 — Second array of variables for comparison

array of Simulink.VariableUsage objects

Second array of variables for comparison, specified as an array of Simulink.VariableUsage objects.

Output Arguments

VarsOut — Variables described in both input arrays

array of `Simulink.VariableUsage` objects

Variables that are described in both input arrays, returned as an array of `Simulink.VariableUsage` objects. The function returns an object for each variable that is described in `VarsIn1` and in `VarsIn2`.

See Also

`Simulink.findVars` | `Simulink.VariableUsage` | `setdiff` | `union`

Topics

“Manage Design Data”

Introduced in R2012b

setdiff

Package: Simulink

Return difference between two arrays of `Simulink.VariableUsage` objects

Syntax

```
VarsOut = setdiff(VarsIn1,VarsIn2)
```

Description

`VarsOut = setdiff(VarsIn1,VarsIn2)` returns an array that identifies the variables described in `VarsIn1` but not in `VarsIn2`, which are arrays of `Simulink.VariableUsage` objects. If a variable is described by a `Simulink.VariableUsage` object in `VarsIn1` but not in `VarsIn2`, the function returns a copy of the object.

`setdiff` compares the `Name`, `Source`, and `SourceType` properties of the `Simulink.VariableUsage` objects in `VarsIn1` with the same properties of the objects in `VarsIn2`. If `VarsIn1` and `VarsIn2` each contain a `Simulink.VariableUsage` object with the same values for these three properties, the objects describe the same variable, and `setdiff` does not return an object to describe it.

To create `Simulink.VariableUsage` objects that describe the usage of variables in a model, use the `Simulink.findVars` function.

Examples

Determine Variable Usage Difference Between Models

Given two models, discover the variables that are needed by the first model but not the second model.

```
model1Vars = Simulink.findVars('model1');  
model2Vars = Simulink.findVars('model2');  
differentVars = setdiff(model1Vars,model2Vars);
```

Find Variables Not Used by Model

Locate all variables in the base workspace that are not used by a loaded model that has been recently compiled.

```
models = find_system('type','block_diagram','LibraryType','None');  
base_vars = Simulink.VariableUsage(who,'base workspace');
```

```
used_vars = Simulink.findVars(models, 'WorkspaceType', 'base');  
unusedVars = setdiff(base_vars, used_vars);
```

Input Arguments

VarsIn1 — First array of variables for comparison

array of `Simulink.VariableUsage` objects

First array of variables for comparison, specified as an array of `Simulink.VariableUsage` objects.

VarsIn2 — Second array of variables for comparison

array of `Simulink.VariableUsage` objects

Second array of variables for comparison, specified as an array of `Simulink.VariableUsage` objects.

Output Arguments

VarsOut — Variables described in first array but not second array

array of `Simulink.VariableUsage` objects

Variables that are described in the first input array but not in the second input array, returned as an array of `Simulink.VariableUsage` objects. The function returns an object for each variable that is described in `VarsIn1` but not in `VarsIn2`.

See Also

`Simulink.findVars` | `Simulink.VariableUsage` | `intersect` | `union`

Topics

“Manage Design Data”

Introduced in R2012b

union

Package: Simulink

Return union of two arrays of `Simulink.VariableUsage` objects

Syntax

```
VarsOut = union(VarsIn1,VarsIn2)
```

Description

`VarsOut = union(VarsIn1,VarsIn2)` returns an array that is a combined set of the variables from `VarsIn1` and `VarsIn2`, which are arrays of `Simulink.VariableUsage` objects. The output array does not contain duplicates. If a variable is described by a `Simulink.VariableUsage` object in `VarsIn1` and in `VarsIn2`, the function returns a `Simulink.VariableUsage` object that stores the variable usage information from both objects in the `Users` property.

To create `Simulink.VariableUsage` objects that describe the usage of variables in a model, use the `Simulink.findVars` function.

Examples

Find the Union of Variables Used by Models

Given two models, discover the combined set of variables from both models.

```
model1Vars = Simulink.findVars('model1');  
model2Vars = Simulink.findVars('model2');  
unionVars = union(model1Vars,model2Vars);
```

Input Arguments

VarsIn1 — First array of variables for union

array of `Simulink.VariableUsage` objects

First array of variables for union, specified as an array of `Simulink.VariableUsage` objects.

VarsIn2 — Second array of variables for union

array of `Simulink.VariableUsage` objects

Second array of variables for union, specified as an array of `Simulink.VariableUsage` objects.

Output Arguments

VarsOut — Combined set of variables described in input arrays

array of `Simulink.VariableUsage` objects

Combined set of variables that are described in input arrays, returned as an array of `Simulink.VariableUsage` objects. The function returns an object for each variable that is described in `VarsIn1` or in `VarsIn2`.

See Also

`Simulink.findVars` | `Simulink.VariableUsage` | `setdiff` | `intersect`

Topics

“Manage Design Data”

Introduced in R2019b

Simulink.DualScaledParameter

Specify name, value, units, and other properties of Simulink dual-scaled parameter

Description

Use `Simulink.DualScaledParameter` so that you can define an object that stores two scaled values of the same physical value.

For example, for temperature measurement, you can store a Fahrenheit scale and a Celsius scale with conversion defined by a computation method that you provide. Given one scaled value, the `Simulink.DualScaledParameter` computes the other scaled value using the computation method.

A dual-scaled parameter inherits some properties from the `Simulink.Parameter` class. A dual-scaled parameter has:

- A calibration value. The value that you prefer to use.
- A main value. The real-world value that Simulink uses.
- An internal stored integer value. The value that is used in the embedded code.

You can use `Simulink.DualScaledParameter` objects in your model for both simulation and code generation. The parameter computes the internal value before code generation via the computation method. This offline computation results in leaner generated code.

If you provide the calibration value, the parameter computes the main value using the computation method. This method can be a first-order rational function.

$$y = \frac{ax + b}{cx + d}$$

- x is the calibration value.
- y is the main value.
- a and b are the coefficients of the CalToMain compute numerator.
- c and d are the coefficients of the CalToMain compute denominator.

If you provide the calibration minimum and maximum values, the parameter computes minimum and maximum values of the main value. Simulink performs range checking of parameter values. The software alerts you when the parameter object value lies outside a range that corresponds to its specified minimum and maximum values and data type.

Creation

Create a `Simulink.DualScaledParameter` object:

- By using the **Model Data Editor**. Instead of creating a `Simulink.Parameter` object, create a `Simulink.DualScaledParameter` object.
- By using the **Model Explorer**:

- 1 In the **Model Hierarchy** pane, select a workspace or data dictionary.
 - 2 On the toolbar, select **Add > Add Custom**.
 - 3 In the Model Explorer — Select Object dialog box, set **Object class** to `Simulink.DualScaledParameter`.
- By using the `Simulink.DualScaledParameter` function, described below.

Syntax

```
DSParam = Simulink.DualScaledParameter
```

Description

`DSParam = Simulink.DualScaledParameter` returns a `Simulink.DualScaledParameter` object with default property values.

Properties

For information about properties in the property dialog box of a `Simulink.DualScaledParameter` object, see “`Simulink.DualScaledParameter` Property Dialog Box”.

CalibrationValue — Calibration value of this parameter

[] (default) | finite, real, double number

Calibration value of this parameter, specified as a finite, real, double number. This value represents the value that you prefer to use.

Before specifying `CalibrationValue`, you must specify `CalToMainCompuNumerator` and `CalToMainCompuDenominator` to define the computation method. The parameter uses the computation method and the calibration value to calculate the main value that Simulink uses.

Corresponds to **Calibration value** in the property dialog box.

Example: 5.34

Data Types: double

CalibrationMin — Calibration minimum value of this parameter

[] (default) | finite, real, double, scalar number

Calibration minimum value of this parameter, specified as a finite, real, double, scalar number. The default value, [], means the minimum is unspecified.

Before specifying `CalibrationMin`, you must specify `CalToMainCompuNumerator` and `CalToMainCompuDenominator` to define the computation method. The parameter uses the computation method and the calibration minimum value to calculate the minimum or maximum value that Simulink uses. A first order rational function is strictly monotonic, either increasing or decreasing. If it is increasing, setting the calibration minimum sets the main minimum value. If it is decreasing, setting the calibration minimum sets the main maximum.

If the parameter value is less than the minimum value or if the minimum value is outside the range of the parameter data type, Simulink generates a warning. In these cases, when updating the diagram or starting a simulation, Simulink generates an error.

Corresponds to **Calibration minimum** in the property dialog box.

Example: 10.51

Data Types: double

CalibrationMax — Calibration maximum value of this parameter

[] (default) | finite, real, double, scalar number

Calibration maximum value of this parameter, specified as a finite, real, double, scalar number. The default value, [], means the maximum is unspecified.

Before specifying **CalibrationMax**, you must specify **CalToMainCompuNumerator** and **CalToMainCompuDenominator** to define the computation method. The parameter uses the computation method and the calibration maximum value to calculate the corresponding maximum or minimum value that Simulink uses. A first order rational function is strictly monotonic, either increasing or decreasing. If it is increasing, setting the calibration maximum sets the main maximum value. If it is decreasing, setting the calibration maximum sets the main minimum.

If the parameter value is less than the minimum value or if the minimum value is outside the range of the parameter data type, Simulink generates a warning. In these cases, when updating the diagram or starting a simulation, Simulink generates an error.

Corresponds to **Calibration maximum** in the property dialog box.

Example: -10.51

Data Types: double

CalToMainCompuNumerator — Numerator coefficients of the computation method

[] (default) | finite, real, double scalar | finite, real, double vector

Numerator coefficients of the computation method, specified as a scalar number or vector of values for the numerator coefficients **a** and **b** of the first-order linear equation:

$$y = \frac{ax + b}{cx + d}$$

The default value is [] (unspecified). Specify finite, real, double scalar values for **a** and **b**. For example, [1 1] or, for reciprocal scaling, 1.

Once you have applied **CalToMainCompuNumerator**, you cannot change it.

Corresponds to **CalToMain compute numerator** in the property dialog box.

Example: [1 1]

Example: 1

Data Types: double

CalToMainCompuDenominator — Denominator coefficients of the computation method

[] (default) | finite, real, double scalar | finite, real, double vector

Denominator coefficients of the computation method, specified as a scalar number or vector of values for the denominator coefficients **c** and **d** of the first-order linear equation:

$$y = \frac{ax + b}{cx + d}$$

The default value is `[]` (unspecified). Specify finite, real, double scalar values for `c` and `d`. For example, `[1 1]`.

Once you have applied `CalToMainCompuDenominator`, you cannot change it.

Corresponds to **CalToMain compute denominator** in the property dialog box.

Example: `[1 1]`

Data Types: `double`

CalibrationName — Name of the calibration parameter

`''` (empty character vector) (default) | character vector

Name of the calibration parameter, specified as a character vector.

Corresponds to **Calibration name** in the property dialog box.

Example: `'This is a calibration parameter.'`

Data Types: `char`

CalibrationDocUnits — Measurement units for this calibration parameter's value

`''` (empty character vector) (default) | character vector

Measurement units for this calibration parameter's value, specified as a character vector.

Corresponds to **Calibration units** in the property dialog box.

Example: `'Fahrenheit'`

Data Types: `char`

IsConfigurationValid — Information about validity of configuration

`true` (default) | `false`

This property is read-only.

Information about the validity of the object configuration, returned as `true` (valid) or `false` (invalid). If Simulink detects an issue with the configuration, it sets this field to `false` and provides information in the `DiagnosticMessage` property.

Corresponds to **Is configuration valid** in the property dialog box.

Data Types: `logical`

DiagnosticMessage — Diagnostic information about invalid configuration

`''` (empty character vector) (default) | character vector

This property is read-only.

Diagnostic information about an invalid object configuration, returned as a character vector. If you specify invalid property settings, Simulink displays a message in this field. Use the diagnostic information to help you fix an invalid configuration issue.

Corresponds to **Diagnostic message** in the property dialog box.

Data Types: `char`

Examples

Create and Update a Dual-Scaled Parameter

Create a `Simulink.DualScaledParameter` object that stores a temperature as both Fahrenheit and Celsius.

Create a `Simulink.DualScaledParameter` object.

```
Temp = Simulink.DualScaledParameter;
```

Set the computation method that converts between Fahrenheit and Celsius.

```
Temp.CalToMainCompuNumerator = [1 -32];
Temp.CalToMainCompuDenominator = [1.8];
```

Set the value of the temperature that you want to see in Fahrenheit.

```
Temp.CalibrationValue = 212
```

```
Temp =
```

```
DualScaledParameter with properties:
```

```

    CalibrationValue: 212
    CalibrationMin: []
    CalibrationMax: []
    CalToMainCompuNumerator: [1 -32]
    CalToMainCompuDenominator: 1.8000
    CalibrationName: ''
    CalibrationDocUnits: ''
    IsConfigurationValid: 1
    DiagnosticMessage: ''
    Value: 100
    CoderInfo: [1x1 Simulink.CoderInfo]
    Description: ''
    DataType: 'auto'
    Min: []
    Max: []
    Unit: ''
    Complexity: 'real'
    Dimensions: [1 1]
```

The `Simulink.DualScaledParameter` calculates `Temp.Value` which is the value that Simulink uses. `Temp.CalibrationValue` is 212 (degrees Fahrenheit), so `Temp.Value` is 100 (degrees Celsius).

Name the value and specify the units.

```
Temp.CalibrationName = 'TempF';
Temp.CalibrationDocUnits = 'Fahrenheit';
```

Set calibration minimum and maximum values.

```
Temp.CalibrationMin = 0;
Temp.CalibrationMax = 300;
```

If you specify a calibration value outside this allowable range, Simulink generates a warning.

Specify the units that Simulink uses.

```
Temp.Unit = 'degC';
```

Open the Simulink.DualScaledParameter dialog box.

open `Temp`

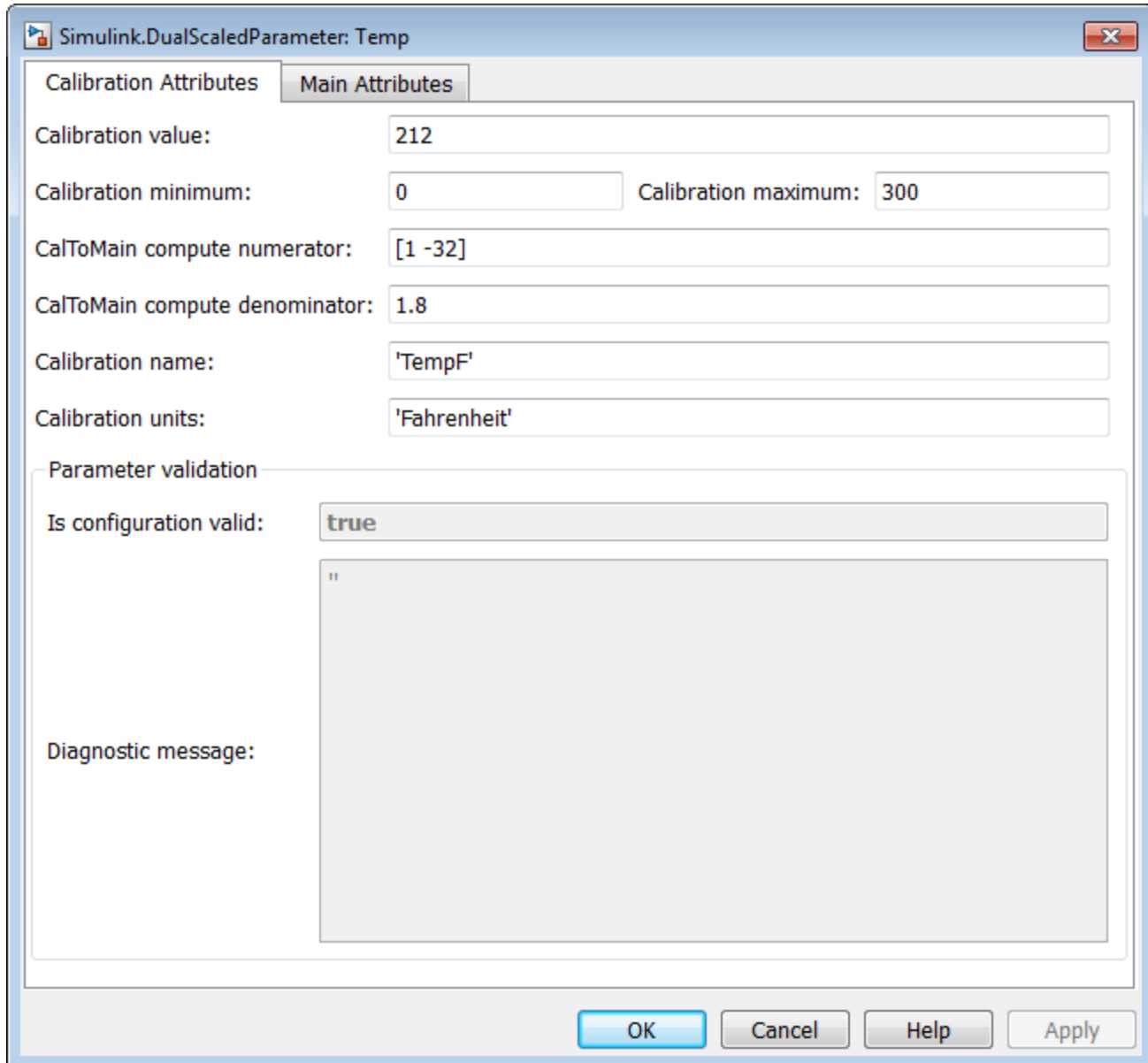

The **Calibration Attributes** tab displays the calibration value and the computation method that you specified.

In the dialog box, click the **Main Attributes** tab.

Simulink.DualScaledParameter: Temp

Calibration Attributes Main Attributes

Value: 100

Data type: auto

Dimensions: [1 1] Complexity: real

Minimum: -17.7778 Maximum: 148.889

Unit: degC

Code generation options

Storage class: Auto

Description:

OK Cancel Help Apply

This tab displays information about the value used by Simulink.

Extended Capabilities

C/C++ Code Generation

Generate C and C++ code using MATLAB® Coder™.

To control the appearance of a `Simulink.DualScaledParameter` object in the generated code, use the **Storage class** property, which the object inherits from `Simulink.Parameter`.

Fixed-Point Conversion

Design and simulate fixed-point systems using Fixed-Point Designer™.

See Also

`Simulink.Parameter` | `AUTOSAR.DualScaledParameter`

Topics

“Configure AUTOSAR Data for Measurement and Calibration” (AUTOSAR Blockset)
“Fixed Point”

Introduced in R2013b

Simulink.Mask class

Package: Simulink

Control masks programmatically

Description

Use an instance of `Simulink.Mask` class to perform the following operations:

- Create, copy, and delete masks.
- Create, edit, and delete mask parameters.
- Determine the block that owns the mask.
- Obtain workspace variables defined for a mask.

Properties

Type

Specifies the mask type of the associated block.

Type: character vector | string scalar

Default: Empty character vector

Description

Specifies the block description of the associated block.

Type: character vector | string scalar

Default: Empty character vector

Help

Specifies the help text that is displayed for the mask.

Type: character vector | string scalar

Default: Empty character vector

Initialization

Specifies the initialization commands for the associated block.

Type: character vector | string scalar

Default: Empty character vector

SelfModifiable

Indicates that the block can modify itself and its content.

Type: boolean

Values: 'on' | 'off'

Default: 'off'

Display

Specifies MATLAB code for drawing the block icon.

Type: character vector | string scalar

Default: Empty character vector

IconFrame

Sets the visibility of the block frame. (Visible is on, Invisible is off).

Type: boolean

Values: 'on' | 'off'

Default: 'on'

IconOpaque

Sets the transparency of the icon (Opaque is on, Transparent is off).

Type: boolean

Values: 'on' | 'off'

Default: 'on'

RunInitForIconRedraw

Specifies whether Simulink must run mask initialization before executing the mask icon commands.

Type: enum

Values: 'auto' | 'on' | 'off'

Default: 'auto'

IconRotate

Sets icon to rotate with the block.

Type: enum

Values: 'none' | 'port'

Default: 'none'

PortRotate

Specifies the port rotation policy for the masked block.

Type: enum

Values: 'default' | 'physical'

Default: 'default'

IconUnits

Specifies the units for the drawing commands.

Type: enum

Values: 'pixel' | 'autoscale' | 'normalized'

Default: 'autoscale'

Methods

| | |
|-------------------------------------|--|
| addParameter | Add a parameter to a mask |
| copy | Copy a mask from one block to another |
| create | Create a mask on a Simulink block |
| delete | Unmask a block and delete the mask from memory |
| get | Get a block mask as a mask object |
| addDialogControl | Add dialog control elements to mask dialog box |
| getDialogControl | Search for a specific dialog control on the mask |
| getOwner | Determine the block that owns a mask |
| getParameter | Get a mask parameter using its name |
| getWorkspaceVariables | Get all the variables defined in the mask workspace for a masked block |
| numParameters | Determine the number of parameters in a mask |
| removeDialogControl | Remove dialog control element from mask dialog box |
| removeParameter | Remove parameter from mask dialog box |
| removeAllParameters | Remove all existing parameters from a mask |
| set | Set the properties of an existing mask |
| addParameterConstraint | Add parameter constraint to a mask |
| removeParameterConstraint | Delete a mask parameter constraint |
| removeCrossParameterConstraint | Delete a cross-parameter constraint |
| removeAllParameterConstraints | Delete all mask parameter constraints |
| removeAllCrossParameterConstraints | Delete all cross-parameter constraints from a mask |
| getParameterConstraint | Get mask parameter constraint properties |
| getCrossParameterConstraint | Get cross-parameter constraint |
| getAssociatedParametersOfConstraint | Get mask parameters associated with a constraint |
| addCrossParameterConstraint | Add cross-parameter constraint |

See Also

Topics

“Control Masks Programmatically”

“Create Block Masks”

addParameter

Class: Simulink.Mask

Package: Simulink

Add a parameter to a mask

Syntax

```
p = Simulink.Mask.get(blockName)
p.addParameter(Name,Value)
```

Description

`p = Simulink.Mask.get(blockName)` gets the mask on the block specified by `blockName` as a mask object.

`p.addParameter(Name,Value)` appends a parameter to the mask. If you do not specify name-value pairs as arguments with this command, Simulink generates name for the mask parameter with control type set to `edit`.

Input Arguments

blockName

The handle to the block or the path to the block inside the model.

Name-Value Pair Arguments

Specify optional comma-separated pairs of `Name,Value` arguments. `Name` is the argument name and `Value` is the corresponding value. `Name` must appear inside quotes. You can specify several name and value pair arguments in any order as `Name1,Value1,...,NameN,ValueN`.

Type

Type of control that is used to specify the value of this parameter. The permitted values are: `edit`, `checkbox`, `popup`, `combobox`, `listbox`, `radiobutton`, `slider`, `dial`, `spinbox`, `unit`, `textarea`, `breakpoint`, `customtable`, `tree`, `unit`, `min`, `max`.

Default: `edit`

TypeOptions

The options that are displayed within a popup control or in a promoted parameter. This field is a cell array.

Default: empty

Name

The name of the mask parameter. This name is assigned to the mask workspace variable created for this parameter.

Default: generated name

Prompt

Text that identifies the parameter on the Mask Parameters dialog box.

Default: empty

Value

The default value of the mask parameter in the Mask Parameters dialog box.

Default: Type specific; depends on the Type of the parameter

Evaluate

Option to specify whether parameter must be evaluated.

Default: 'on'

Tunable

Option to specify whether parameter is tunable.

Default: 'on'

Enabled

Option to specify whether user can set parameter value.

Default: 'on'

Visible

Option to set whether mask parameter is hidden or visible to the user.

Default: 'on'

Callback

Container for MATLAB code that executes when user makes a change in the Mask Parameters dialog box.

Default: empty

Container

Option to specify a container for the child parameters. The permitted values are the names of 'panel', 'group', and 'tab'.

Examples

- 1 Get mask as an object using a masked block's path.

```
p = Simulink.Mask.get('myModel/Subsystem');
```

-
- 2** Add a parameter to the mask without specifying name-value pairs for parameter attributes.

```
p.addParameter;
```

-
-
- 3** Add a mask parameter of type popup that cannot be evaluated.

```
p.addParameter('Type','popup','TypeOptions',...  
{'Red' 'Blue' 'Green'},'Evaluate','off');
```

See Also

[Simulink.Mask](#) | “Create Block Masks”

Simulink.Mask.copy

Class: Simulink.Mask

Package: Simulink

Copy a mask from one block to another

Syntax

```
pSource = Simulink.Mask.get(srcBlockName)
pDest = Simulink.Mask.create(destBlockName)
pDest.copy(pSource)
```

Description

`pSource = Simulink.Mask.get(srcBlockName)` gets the mask on the source block specified by `blockName` as a mask object.

`pDest = Simulink.Mask.create(destBlockName)` creates an empty mask on the destination block specified by `destBlockName`.

`pDest.copy(pSource)` overwrites the destination mask with the source mask.

Input Arguments

`srcBlockName`

The handle to the source block or the path to the source block inside the model.

Note The source block should be masked.

`destBlockName`

The handle to the destination block or the path to the destination block inside the model.

Note The destination block should have an empty mask. Otherwise, the copied mask will overwrite the non-empty mask.

Examples

- 1 Create an empty mask on the destination block using the block's path.

```
pDest = Simulink.Mask.create('myModel/Subsystem');
```
- 2 Get source mask as an object using the source block's path.

```
pSource = Simulink.Mask.get('myModel/Abs');
```
- 3 Make the destination mask a copy of the source mask.

```
pDest.copy(pSource);
```

See Also

Simulink.Mask | “Create Block Masks”

Simulink.Mask.create

Class: Simulink.Mask

Package: Simulink

Create a mask on a Simulink block

Syntax

```
p = Simulink.Mask.create(blockName)
```

Description

`p = Simulink.Mask.create(blockName)` creates an empty mask on the block specified by `blockName`. If the specified block is already masked, an error message appears.

Input Arguments

blockName

The handle to the block or the path to the block inside the model.

Examples

- 1 Create a mask using a block's handle.

Note In the model, select the block to be masked.

```
p = Simulink.Mask.create(gcbh);
```

- 2 Create a mask using the block's path.

```
p = Simulink.Mask.create('myModel/Subsystem');
```

See Also

`Simulink.Mask` | "Create Block Masks"

delete

Class: Simulink.Mask

Package: Simulink

Unmask a block and delete the mask from memory

Syntax

```
p = Simulink.Mask.get(blockName)
p.delete
```

Description

`p = Simulink.Mask.get(blockName)` gets the mask on the block specified by `blockName` as a mask object.

`p.delete` unmask the block and deletes the mask from memory.

Input Arguments

`blockName`

The handle to the block or the path to the block inside the model.

Examples

- 1 Get mask as an object using a masked block's path.

```
p = Simulink.Mask.get('myModel/Subsystem');
```
- 2 Unmask the block using the mask object and delete the mask from memory.

```
p.delete;
```

See Also

`Simulink.Mask` | "Create Block Masks"

Simulink.Mask.get

Class: Simulink.Mask

Package: Simulink

Get a block mask as a mask object

Syntax

```
p = Simulink.Mask.get(blockName)
```

Description

`p = Simulink.Mask.get(blockName)` gets the mask on the block specified by `blockName` as a mask object. If the specified block is not masked, a null value returns.

Input Arguments

blockName

The handle to the block or the path to the block inside the model.

Examples

- 1 Get mask as an object using a masked block's handle.

Note In the model, select the masked block.

```
p = Simulink.Mask.get(gcbh);
```

- 2 Get mask as an object using a masked block's path.

```
p = Simulink.Mask.get('myModel/Subsystem');
```

See Also

`Simulink.Mask` | "Create Block Masks"

addDialogControl

Class: Simulink.Mask

Package: Simulink

Add dialog control elements to mask dialog box

Syntax

```
successIndicator = maskObj.addDialogControl(controlType,controlIdentifier)  
successIndicator = maskObj.addDialogControl(Name,Value)
```

Description

`successIndicator = maskObj.addDialogControl(controlType,controlIdentifier)` adds dialog control elements like text, hyperlinks, or tabs to mask dialog box. First get the mask object and assign it to the variable `maskObj`

`successIndicator = maskObj.addDialogControl(Name,Value)` specifies the `Name` and `Value` arguments for an element on the mask dialog box. You can specify multiple `Name-Value` pairs.

Input Arguments

controlType — Value type of dialog control element

character vector | string scalar

Type of dialog control element, specified

- 'panel'
- 'group'
- 'tabcontainer'
- 'tab'
- 'collapsiblepanel'
- 'text'
- 'image'
- 'hyperlink'
- 'pushbutton'

controlIdentifier — Unique identifier for the element

character vector | string scalar

Specifies the programmatic identifier for the element of mask dialog box. Use a name that is unique and does not have space between words. For more information, see “Variable Names”.

Name-Value Pair Arguments

Specify optional comma-separated pairs of `Name`, `Value` arguments. `Name` is the argument name and `Value` is the corresponding value. `Name` must appear inside single quotes (' ') and is case-sensitive.

You can specify several name and value pair arguments in any order as Name1, Value1, . . . , NameN, ValueN.

Type

Type of control that is used to specify the value of this dialog control element. Type is a required argument. The permitted values are 'panel', 'group', 'tabcontainer', 'tab', 'collapsiblepanel', 'text', 'image', 'hyperlink', and 'pushbutton'.

Default: empty

Name

The identifier of the dialog control element. Name is a required argument. This field is available for all dialog control types.

Default: empty

Prompt

Text that is displayed in the dialog control element on the Mask dialog box. This field is available for all except for panel and image dialog control types.

Default: empty

Tooltip

Tooltip for the dialog control element.

Default: empty

Enabled

Option to specify whether you can set value for the dialog control element. This field is available for all dialog control types.

Default: 'on'

Visible

Option to set whether the dialog control element is hidden or visible to the user. This field is available for all dialog control types.

Default: 'on'

Callback

Container for MATLAB code that executes when you edit the dialog control element and click **Apply**. This field is available only for the hyperlink and pushbutton dialog control types.

Default: empty

Row

Option to set whether the dialog control is placed in the new row or the same row. This field is available for all dialog control types.

Default: empty

Filepath

Contains the path to an image file. This field is available for image, and pushbutton dialog control types.

Default: empty

Container

Option to specify a container for the child dialog control. The permitted values are the names of 'panel', 'group', and 'tab' dialog controls.

Examples

Add Dialog Control Elements to Mask Dialog Box

Get mask object and add dialog control element to it.

```
% Get mask object on model Engine
maskObj = Simulink.Mask.get('Engine/Gain');

% Add hyperlink to mask dialog box

maskLink = maskObj.addDialogControl('hyperlink','link');
maskLink.Prompt = 'Mathworks Home Page';
maskLink.Callback = 'web(''www.mathworks.com'')'

% Alternative method to add hyperlink

maskLink = maskObj.addDialogControl('hyperlink','link');
maskLink.Prompt = 'www.mathworks.com';

% Add text to mask dialog box

maskText = maskObj.addDialogControl('text','text_tag');
maskText.Prompt = 'Enable range checking';

% Add button to mask dialog box

maskButton = maskObj.addDialogControl('pushbutton','button_tag');
maskButton.Prompt = 'Compute';
```

Add Dialog Control Elements to Mask Dialog Box Tabs

Create tabs on the mask dialog box and add elements to these tabs.

```
% Get mask object on a block named 'GainBlock'
maskObj = Simulink.Mask.get('GainBlock/Gain');

% Create a tab container
```

```
maskObj.addDialogControl('tabcontainer','allTabs');
tabs = maskObj.getDialogControl('allTabs');

% Create tabs and name them

maskTab1 = tabs.addDialogControl('tab','First');
maskTab1.Prompt = 'First tab';

maskTab2 = tabs.addDialogControl('tab','Second');
maskTab2.Prompt = 'Second tab';

% Add elements to one of the tabs

firstTab = tabs.getDialogControl('First');
firstTab.addDialogControl('text','textOnFirst');
firstTab.getDialogControl('textOnFirst').Prompt = 'Tab one';
```

Add Dialog Control Element Using Name-Value Pair

Add dialog control element and specify values for it

```
% Get mask object on model Engine

maskObj = Simulink.Mask.get('Engine/Gain');

% Add a dialog box and specify values for it

maskDialog = maskObj.addDialogControl('Type','text',...
'Prompt','hello','Visible','off');
```

See Also

[Simulink.Mask](#) | “Create Block Masks” | [Control Masks Programmatically](#)

Introduced in R2014a

getDialogControl

Class: Simulink.Mask

Package: Simulink

Search for a specific dialog control on the mask

Syntax

```
[control, phandle] = handle.getDialogControl(cname)
```

Description

`[control, phandle] = handle.getDialogControl(cname)` , search for a specific child dialog control recursively on the mask dialog.

Input Arguments

cname

Name of the dialog control being searched on the mask dialog.

Default:

Output Arguments

control

Target dialog control being searched on the mask dialog.

phandle

Parent of the dialog control being searched mask dialog.

Examples

Find a dialog control

Find a text dialog control on the mask dialog box. `maskObj` is the handle to the mask object. The `getDialogControl` method returns the handle to the dialog control (`hdlgctrl`) and handle to the parent dialog control (`phandle`).

```
[hdlgctrl, phandle] = maskObj.getDialogControl('txt_var')
```

See Also

`Simulink.Mask` | “Create Block Masks”

getOwner

Class: Simulink.Mask

Package: Simulink

Determine the block that owns a mask

Syntax

```
p = Simulink.Mask.get(blockName)
p.getOwner
```

Description

`p = Simulink.Mask.get(blockName)` gets the mask on the block specified by `blockName` as a mask object.

`p.getOwner` returns the interface to the block that owns the mask.

Input Arguments

blockName

The handle to the block or the path to the block inside the model.

Examples

- 1 Get mask as an object using a masked block's path.

```
p = Simulink.Mask.get('myModel/Subsystem');
```

- 2 Get the interface to the block that owns the mask.

```
p.getOwner;
```

See Also

`Simulink.Mask` | "Create Block Masks"

getParameter

Class: Simulink.Mask

Package: Simulink

Get a mask parameter using its name

Syntax

```
p = Simulink.Mask.get(blockName)
param = p.getParameter(paramName)
```

Description

`p = Simulink.Mask.get(blockName)` gets the mask on the block specified by `blockName` as a mask object.

`param = p.getParameter(paramName)` returns an array of mask parameters.

Input Arguments

`blockName`

The handle to the block or the path to the block inside the model.

`paramName`

The name of the parameter you want to get.

Examples

- 1 Get mask as an object using a masked block's path.

```
p = Simulink.Mask.get('myModel/Subsystem');
```

- 2 Get a mask parameter by using its name.

```
param = p.getParameter('intercept');
```

See Also

`Simulink.Mask` | “Create Block Masks”

getWorkspaceVariables

Class: Simulink.Mask

Package: Simulink

Get all the variables defined in the mask workspace for a masked block

Syntax

```
p = Simulink.Mask.get(blockName)
vars = p.getWorkspaceVariables
```

Description

`p = Simulink.Mask.get(blockName)` gets the mask on the block specified by `blockName` as a mask object.

`vars = p.getWorkspaceVariables` returns as a structure all the variables defined in the mask workspace for the masked block.

Input Arguments

`blockName`

The handle to the block or the path to the block inside the model.

Examples

- 1 Get mask as an object using a masked block's path.

```
p = Simulink.Mask.get('myModel/Subsystem');
```
- 2 Get all the variables defined in the mask workspace for the masked block.

```
vars = p.getWorkspaceVariables;
```

See Also

`Simulink.Mask` | "Create Block Masks"

numParameters

Class: Simulink.Mask

Package: Simulink

Determine the number of parameters in a mask

Syntax

```
p = Simulink.Mask.get(blockName)
p.numParameters
```

Description

`p = Simulink.Mask.get(blockName)` gets the mask on the block specified by `blockName` as a mask object.

`p.numParameters` returns the number of parameters in the mask.

Input Arguments

blockName

The handle to the block or the path to the block inside the model.

Examples

- 1 Get mask as an object using a masked block's path.

```
p = Simulink.Mask.get('myModel/Subsystem');
```

- 2 Get the number of parameters in the mask.

```
p.numParameters;
```

See Also

`Simulink.Mask` | "Create Block Masks"

removeDialogControl

Class: Simulink.Mask

Package: Simulink

Remove dialog control element from mask dialog box

Syntax

```
successIndicator = maskVariable.removeDialogControl(controlIdentifier)
```

Description

`successIndicator = maskVariable.removeDialogControl(controlIdentifier)` removes dialog control element, specified by `controlIdentifier`, like text, hyperlinks, or tabs from a mask dialog box. First get the mask object and assign it to the variable `maskVariable`.

Successful removal of a dialog control element returns a Boolean value of 1.

Input Arguments

controlIdentifier — Unique identifier for the element

character vector | string scalar

Programmatic identifier for the dialog control element of mask dialog box.

Examples

Remove Dialog Control Element from Mask Dialog Box

```
% Get mask object on the Gain block in the model Engine.
```

```
maskObj = Simulink.Mask.get('Engine/Gain');
```

```
% Remove element named AllTab from mask dialog box.
```

```
p = maskObj.removeDialogControl('AllTab');
```

See Also

Simulink.Mask | “Create Block Masks”

Introduced in R2013b

removeParameter

Class: Simulink.Mask

Package: Simulink

Remove parameter from mask dialog box

Syntax

```
successIndicator = maskVariable.removeParameter(controlIdentifier)
```

Description

`successIndicator = maskVariable.removeParameter(controlIdentifier)` removes parameter, specified by `controlIdentifier`, like edit, check box, popup from an existing mask dialog box. First get the mask object and assign it to the variable `maskVariable`.

Successful removal of a parameter returns a Boolean value of 1.

Input Arguments

controlIdentifier — Unique identifier for the parameter

character vector | string scalar

Programmatic identifier for the parameter of mask dialog box, specified as a character vector.

Examples

Remove Parameter from Mask Dialog Box

```
% Get mask object on the Gain block in the model Engine.  
maskObj = Simulink.Mask.get('Engine/Gain');  
  
% Remove parameter named checkbox1 from mask dialog box.  
p = maskObj.removeParameter('checkbox1');
```

Note You can also use the index number as the `controlIdentifier`.

See Also

Simulink.Mask | “Create Block Masks”

Introduced in R2012b

removeAllParameters

Class: Simulink.Mask

Package: Simulink

Remove all existing parameters from a mask

Syntax

```
p = Simulink.Mask.get(blockName)
p.removeAllParameters
```

Description

`p = Simulink.Mask.get(blockName)` gets the mask on the block specified by `blockName` as a mask object.

`p.removeAllParameters` deletes all existing parameters from the mask.

Input Arguments

blockName

The handle to the block or the path to the block inside the model.

Examples

- 1 Get mask as an object using a masked block's path.

```
p = Simulink.Mask.get('myModel/Subsystem');
```

- 2 Delete all existing parameters from the mask.

```
p.removeAllParameters;
```

See Also

`Simulink.Mask` | “Create Block Masks”

set

Class: Simulink.Mask

Package: Simulink

Set the properties of an existing mask

Syntax

```
p = Simulink.Mask.get(blockName)
p.set(Name,Value)
```

Description

`p = Simulink.Mask.get(blockName)` gets the mask on the block specified by `blockName` as a mask object.

`p.set(Name,Value)` sets mask properties that you specify using name-value pairs as arguments.

Input Arguments

blockName

The handle to the block or the path to the block inside the model.

Name-Value Pair Arguments

Specify optional comma-separated pairs of `Name,Value` arguments. `Name` is the argument name and `Value` is the corresponding value. `Name` must appear inside quotes. You can specify several name and value pair arguments in any order as `Name1,Value1,...,NameN,ValueN`.

Type

Text used as title for mask documentation that user sees on clicking **Help** in the Mask Parameters dialog box.

Default: empty

Description

Text used as summary for mask documentation that user sees on clicking **Help** in the Mask Parameters dialog box.

Default: empty

Help

Text used as body text for mask documentation that user sees on clicking **Help** in the Mask Parameters dialog box.

Default: empty

Initialization

MATLAB code that initializes the mask.

Default: empty

SelfModifiable

Option to set whether the mask can modify itself during simulation.

Default: 'off'

Display

MATLAB code that draws the mask icon.

Default: empty

IconFrame

Option to specify whether the mask icon appears inside a visible block frame.

Default: 'on'

MaskIconOpaque

Option to set the mask icon as opaque or transparent.

Default: 'opaque'

RunInitForIconRedraw

Option to specify whether Simulink should run mask initialization before executing the mask icon commands.

Default: 'off'

IconRotate

Option to specify icon rotation.

Default: 'none'

PortRotate

Option to specify port rotation.

Default: 'default'

IconUnits

Option to specify whether mask icon is autoscaled, normalized, or scaled in pixels.

Default: 'autoscale'

Examples

- 1 Get mask as an object using a masked block's path.

```
p = Simulink.Mask.get('myModel/Subsystem');
```

- 2 Modify the mask so that its mask icon is transparent and its documentation summarizes what it does.

```
p.set('IconOpaque','off','Type','Random number generator','Description',...  
'This block generates random numbers.');
```

See Also

[Simulink.Mask](#) | “Create Block Masks”

addParameterConstraint

Class: Simulink.Mask

Package: Simulink

Add parameter constraint to a mask

Syntax

```
paramConstraint = maskObj.addParameterConstraint(Name,Value)
```

Description

`paramConstraint = maskObj.addParameterConstraint(Name,Value)` adds a constraint to the specified mask. Constraints can only be associated to the **Edit** type mask parameters.

Input Arguments

maskObj — Block mask handle

mask object

Block mask handle, specified as a mask object. You can use the `Simulink.Mask.get` command to get the block mask handle. For more information, see `Simulink.Mask.get`

Data Types: `char` | `cell`

Name-Value Pair Arguments

Specify optional comma-separated pairs of `Name, Value` arguments. `Name` is the argument name and `Value` is the corresponding value. You can specify several name and value pair arguments in any order as `Name1, Value1, ..., NameN, ValueN`.

Name — Mask constraint name

character vector | string

Required field. Must be a valid MATLAB name. Specifies a name for the mask parameter constraint.

Parameters — Mask parameter name

cell array of character vector | string

Optional field. Specifies the **Edit** mask parameter name to which you want to associate the constraint.

Rules — Rule for mask parameter constraint

`Data Type` | `Dimension` | `Complexity` | `Sign` | `Finiteness` | `Minimum` | `Maximum` | `CustomConstraint`

Required field. Rules are defined within curly braces. A constraint can have single or multiple rules.

Name-Value Pairs for Rules

| Name | Value |
|--------------------|--|
| DataType | double, single, numeric, integer, int8, uint8, int16, uint16, int32, uint32, boolean, enum, fixdt |
| Dimension | scalar, rowvector, columnvector, 2dmatrix, ndmatrix |
| Complexity | real, complex |
| Sign | positive, negative, zero |
| Finiteness | finite, inf, -inf, NaN |
| Minimum | character vector |
| Maximum | character vector |
| CustomConstraint | Valid MATLAB expression returning logical true or false. |
| CustomErrorMessage | character vector or a message catalog ID. If you use the message catalog ID to specify an error, the error message must not have any holes in it. This error message is specifically for custom constraint validation failure. |

Output Arguments

paramConstraint — Mask parameter constraint

character vector | string

Handle to the mask parameter constraint, returned as a character vector. You can associate a constraint to the mask parameter either during or after creating the constraint.

Examples

Create Mask Constraint with Single Rule

```
% Get block mask handle.
maskObj = Simulink.Mask.get(gcb);

% Create mask constraint with single rule.
paramConstraint = maskObj.addParameterConstraint('Name','const2',...
'Parameters',{'Parameter2'}, 'Rules', {'DataType', 'uint8'})
```

ans =

Constraints with properties:

```
      Name: 'const2'
ConstraintRules: [1x1 Simulink.Mask.ParameterConstraintRules]
```

Create Mask Constraint with Multiple Rules

```
% Get block mask handle.
maskObj = Simulink.Mask.get(gcb);
```

```
% Create mask constraint with multiple rules.  
paramConstraint = maskObj.addParameterConstraint('Name','const3',...  
'Parameters',{'Parameter3'}, 'Rules', {{'DataType', 'uint8'},{'DataType', {'fixdt(1,8,4)'}}})
```

```
ans =
```

```
Constraints with properties:
```

```
      Name: 'const3'  
ConstraintRules: [1x2 Simulink.Mask.ParameterConstraintRules]
```

See Also

[Simulink.Mask](#) | “Create Block Masks”

Introduced in R2018a

removeParameterConstraint

Class: Simulink.Mask

Package: Simulink

Delete a mask parameter constraint

Syntax

```
maskObj.removeParameterConstraint(paramConstraint)
```

Description

`maskObj.removeParameterConstraint(paramConstraint)` deletes the specified mask parameter constraint.

Input Arguments

maskObj — Block mask handle

mask object

Handle to the block mask, specified as mask object. You can use the `Simulink.Mask.get` command to get the block mask handle. For more information, see `Simulink.Mask.get`.

Data Types: `char` | `cell`

paramConstraint — Mask constraint name

character vector | string

Name of the mask parameter constraint to be deleted, specified as character vector.

Examples

```
% Get block mask handle.
maskObj = Simulink.Mask.get(gcb);

% Remove mask constraint with name 'const1'.
maskObj.removeParameterConstraint('const1')
```

See Also

`Simulink.Mask` | “Create Block Masks”

Introduced in R2018a

removeCrossParameterConstraint

Class: Simulink.Mask

Package: Simulink

Delete a cross-parameter constraint

Syntax

```
maskObj.removeCrossParameterConstraint(CrossConstraint)
```

Description

`maskObj.removeCrossParameterConstraint(CrossConstraint)` deletes the specified cross-constraint.

Input Arguments

maskObj — Block mask handle

mask object

Handle to the block mask, specified as mask object. You can use the `Simulink.Mask.get` command to get the block mask handle. For more information, see `Simulink.Mask.get`.

Data Types: `char` | `cell`

CrossConstraint — Cross constraint name

character vector | string

Name of the cross-constraint to be removed, specified as character vector.

Examples

```
% Get block mask handle.  
maskObj = Simulink.Mask.get(gcb);  
  
% Remove cross-constraint of name 'const1'.  
maskObj.removeCrossParameterConstraint('const1')
```

See Also

`Simulink.Mask` | “Create Block Masks”

Introduced in R2018a

removeAllParameterConstraints

Class: Simulink.Mask

Package: Simulink

Delete all mask parameter constraints

Syntax

```
maskObj.removeAllParameterConstraints()
```

Description

`maskObj.removeAllParameterConstraints()` deletes all the parameter constraints from a mask.

Input Arguments

maskObj — Block mask handle

mask object

Handle to the block mask. You can use the `Simulink.Mask.get` command to get the block mask handle. For more information see, `Simulink.Mask.get`

Examples

```
% Get block mask handle.  
maskObj = Simulink.Mask.get(gcb);  
  
% Remove all constraints from the mask.  
maskObj.removeAllParameterConstraints()
```

See Also

`Simulink.Mask` | “Create Block Masks”

Introduced in R2018a

removeAllCrossParameterConstraints

Class: Simulink.Mask

Package: Simulink

Delete all cross-parameter constraints from a mask

Syntax

```
maskObj.removeAllCrossParameterConstraints()
```

Description

`maskObj.removeAllCrossParameterConstraints()` deletes all cross-constraints from a mask.

Examples

```
% Get block mask handle.  
maskObj = Simulink.Mask.get(gcb);  
  
% Remove all cross constraints from the mask.  
maskObj.removeAllCrossParameterConstraints()
```

See Also

`Simulink.Mask` | “Create Block Masks”

Introduced in R2018a

getParameterConstraint

Class: Simulink.Mask

Package: Simulink

Get mask parameter constraint properties

Syntax

```
paramConstraint = maskObj.getParameterConstraint(paramConstraintName)
```

Description

`paramConstraint = maskObj.getParameterConstraint(paramConstraintName)` gets the properties of a mask parameter constraint.

Input Arguments

maskObj — Block mask handle

mask object

Handle to the block mask, specified as mask object. You can use the `Simulink.Mask.get` command to get the block mask handle. For more information, see `Simulink.Mask.get`.

Data Types: char | cell

paramConstraintName — Mask constraint name

character vector | string

Name of the constraint of which you want get the properties, specified as character vector.

Output Arguments

paramConstraint — Mask constraint property

cell array of character vector

Constraint properties, returned as a cell array.

Examples

```
% Get block mask handle.
```

```
maskObj = Simulink.Mask.get(gcb);
```

```
% Find parameters associated with the constraint.
```

```
paramConstraint = maskObj.getParameterConstraint('const3')
```

```
ans =
```

```
Constraints with properties:
```

Name: 'const3'
ConstraintRules: [1x2 Simulink.Mask.ParameterConstraintRules]

See Also

[Simulink.Mask](#) | “Create Block Masks”

Introduced in R2018a

getCrossParameterConstraint

Class: Simulink.Mask

Package: Simulink

Get cross-parameter constraint

Syntax

```
CrossConstraint = maskObj.getCrossParameterConstraint(CrossConstraintName)
```

Description

`CrossConstraint = maskObj.getCrossParameterConstraint(CrossConstraintName)` gets the properties of a cross parameter constraint on a mask. Apply a cross-parameter constraint to specify rules between mask parameter values.

Input Arguments

maskObj — Block mask handle

mask object

Handle to the block mask, specified as mask object. You can use the `Simulink.Mask.get` command to get the block mask handle. For more information, see `Simulink.Mask.get`.

Data Types: char | cell

CrossConstraintName — Cross-constraint name

character vector | string

Name of the cross-parameter constraint for which you get the constraint properties, specified as the mask object.

Output Arguments

CrossConstraint — Cross-constraint property

cell array

Cross-parameter constraint properties, returned as a cell array.

Examples

```
% Get block mask handle.
maskObj = Simulink.Mask.get(gcb);

% Get cross constraint.
CrossConstraint = maskObj.getCrossParameterConstraint('crossparam1')
```

ans =

```
CrossParameterConstraints with properties:  
    Name: 'crossparam1'  
    Rule: 'Parameter2 > Parameter3'  
    ErrorMessage: ''
```

See Also

[Simulink.Mask](#) | “Create Block Masks”

Introduced in R2018a

getAssociatedParametersOfConstraint

Class: Simulink.Mask

Package: Simulink

Get mask parameters associated with a constraint

Syntax

```
maskParam = maskObj.getAssociatedParametersOfConstraint(paramConstraintName)
```

Description

`maskParam = maskObj.getAssociatedParametersOfConstraint(paramConstraintName)` gets the parameters that are associated with a mask constraint.

Input Arguments

maskObj — Block mask handle

mask object

Handle to the block mask, specified as mask object. You can use the `Simulink.Mask.get` command to get the block mask handle. For more information, see `Simulink.Mask.get`.

Data Types: char | cell

paramConstraintName — Mask constraint name

character vector | string

Name of the constraint for which you want to find the associated mask parameters, specified as character vector.

Output Arguments

maskParam — Mask parameter name

cell array of character vector

Mask parameter, specified as a cell array.

Examples

```
% Get block mask handle.
```

```
maskObj = Simulink.Mask.get(gcb);
```

```
% Find parameters associated with the constraint.
```

```
maskParam = maskObj.getAssociatedParametersOfConstraint('const3')
```

```
ans =
```

```
1×1 cell array
```

```
{'Parameter1'}
```

See Also

[Simulink.Mask](#) | “Create Block Masks”

Introduced in R2018a

addCrossParameterConstraint

Class: Simulink.Mask

Package: Simulink

Add cross-parameter constraint

Syntax

```
CrossConstraint = maskObj.addCrossParameterConstraint(Name,Value)
```

Description

`CrossConstraint = maskObj.addCrossParameterConstraint(Name,Value)` adds a constraint among parameters of a mask.

Input Arguments

maskObj — Block mask handle

mask object

Block mask handle, specified as a mask object. You can use the `Simulink.Mask.get` command to get the block mask handle. For more information, see `Simulink.Mask.get`.

Data Types: char | cell

Name-Value Pair Arguments

Specify optional comma-separated pairs of `Name`, `Value` arguments. `Name` is the property name and `Value` is the corresponding value. You can specify several name and value pair arguments in any order as `Name1,Value1,...,NameN,ValueN`.

Name — Cross-parameter constraint name

character vector | string

Cross-parameter constraint name, specified as a character vector. Must be a valid MATLAB value.

Rule — Cross-parameter constraint rule

MATLAB expression | string

Cross-parameter constraint rule, specified as a valid MATLAB expression that returns logical true or false. You can specify multiple rules by separating them with a logical operators like `&&`. For example, `parameter1 > parameter2 && parameter2 > parameter3`. Here, `parameter1`, `parameter2` and `parameter3` are parameters of a mask.

ErrorMessage — Error message

character vector | string

Optional field. Specifies the error message to be displayed when the cross parameter constraint rule is not satisfied. You can specify the error message as character vector or as a message catalog ID. If you use the message catalog ID to specify an error, the error message must not have any holes in it. Simulink displays a default error message if no user-defined error message is found.

Output Arguments

CrossConstraint — Cross parameter constraint

cell array

Handle to the cross-parameter constraint, returned as a cell array.

Examples

```
% Get block mask handle.
maskObj = Simulink.Mask.get(gcb);

% Add cross parameter constraint.
CrossConstraint = maskObj.addCrossParameterConstraint('Name','crossconstraint1',...
'MATLABexpression','upperbound > lowerbound','ErrorMessage','Incorrect value specified.')
```

ans =

```
    CrossParameterConstraints with properties:
        Name: 'crossconstraint1'
MATLABexpression: 'upperbound > lowerbound'
        ErrorMessage: 'Incorrect value specified.'
```

See Also

[Simulink.Mask](#) | “Create Block Masks”

Introduced in R2018a

Simulink.Mask.Constraints class

Package: Simulink.Mask

Create Mask Constraint

Description

Use an instance of the `Simulink.Mask.Constraint` to add or remove a parameter constraint rule.

Properties

DataType

Specifies the data type associated with the constraint rule.

Type: double, single, numeric, integer, int8, uint8, int16, uint16, int32, uint32, boolean, enum, fixdt, string

Default: Empty

Dimension

Specifies the dimension associated with the constraint rule.

Type: scalar, rowvector, columnvector, 2dmatrix, ndmatrix

Default: Empty

Complexity

Specifies the complexity associated with the constraint rule.

Type: real, complex

Default: Empty

Sign

Specifies the sign associated with the constraint rule.

Type: positive, negative, zero

Default: Empty

Finiteness

Specifies the finiteness associated with the constraint rule.

Type: finite, inf, -inf, NaN

Default: Empty

Range

Specifies the range associated with the constraint rule.

Type: Minimum, Maximum

Default: Empty

CustomConstraint

Specifies the custom constraint associated with the constraint rule.

Type: Valid MATLAB expression

Default: Empty

CustomErrorMessage

Specifies the custom error message associated with the custom constraint rule.

Type: Character vector

Default: Empty

Methods

addParameterConstraintRule

Add rules to a parameter constraint

removeParameterConstraintRule

Delete a mask parameter constraint rule

See Also

Introduced in R2018a

addParameterConstraintRule

Class: Simulink.Mask.Constraints

Package: Simulink.Mask

Add rules to a parameter constraint

Syntax

```
paramConstRule = paramConstraint.addParameterConstraintRule(Name,Value)
```

Description

`paramConstRule = paramConstraint.addParameterConstraintRule(Name,Value)` adds rule to a parameter constraint.

Input Arguments

paramConstraint — Handle to mask constraint

constraint object

Handle to the mask parameter constraint for which you want to add constraint rules, specified as constraint object.

Data Types: char | cell

Name-Value Pair Arguments

Specify optional comma-separated pairs of `Name`, `Value` arguments. `Name` is the argument name and `Value` is the corresponding value. You can specify several name and value pair arguments in any order as `Name1,Value1,...,NameN,ValueN`.

Name-Value Pair for Rules

| Name | Value |
|------------------|---|
| DataType | double, single, numeric, integer, int8, uint8, int16, uint16, int32, uint32, boolean, enum, fixdt |
| Dimension | scalar, rowvector, columnvector, 2dmatrix, ndmatrix |
| Complexity | real, complex |
| Sign | positive, negative, zero |
| Finiteness | finite, inf, -inf, NaN |
| Minimum | string |
| Maximum | string |
| CustomConstraint | Valid MATLAB expression |

Output Arguments

paramConstRule — Mask constraint rule

cell array

Mask constraint rule, specified as a cell array.

Examples

```
% Get mask constraint handle
paramConstraint = maskObj.getParameterConstraint('const3');

% Add rules to the constraint.
paramConstRule = paramConstraint.addParameterConstraintRule('DataType','int8')

ans =

    ParameterConstraintRules with properties:

        DataType: 'int8'
        Dimension: {0x1 cell}
        Complexity: {0x1 cell}
           Sign: {0x1 cell}
        Finiteness: {0x1 cell}
         Minimum: ''
         Maximum: ''
    CustomConstraint: ''
```

See Also

[Simulink.Mask](#) | “Create Block Masks”

Introduced in R2018a

removeParameterConstraintRule

Class: Simulink.Mask.Constraints

Package: Simulink.Mask

Delete a mask parameter constraint rule

Syntax

```
paramConstraint.removeParameterConstraintRule(RuleIndex)
```

Description

`paramConstraint.removeParameterConstraintRule(RuleIndex)` deletes the specified constraint rule from a mask parameter constraint.

Input Arguments

paramConstraint — Handle to constraint

constraint object

Handle to mask parameter constraint of which you want to remove constraint rule, specified as an object.

Data Types: char | cell

RuleIndex — Constraint rule index

integer

Index number of the mask constraint rule, specified as an integer.

Examples

```
% Get block mask handle.  
maskObj = Simulink.Mask.get(gcb);  
  
% Get mask constraint handle.  
paramConstraint = maskObj.getParameterConstraint('const3');  
  
% Remove mask constraint rule.  
paramConstraint.removeParameterConstraintRule(1)
```

See Also

Simulink.Mask | “Create Block Masks”

Introduced in R2018a

addColumn

Class: Simulink.dialog.parameter.CustomTable

Package: Simulink.dialog.parameter

Add new column in the custom table

Syntax

```
tableControl.addColumn(Name, Value)
```

Description

`tableControl.addColumn(Name, Value)` adds a column with the specified properties in the custom table.

Input Arguments

tableControl — Custom table handle

table object

Handle to the custom table, specified as an object. You can use the `getDialogControl` command to get the custom table handle. For more information, see `getDialogControl`.

Consider, for example, `tableControl = maskObj.getDialogControl(TableName)`. Here, `maskObj` is the mask object and `TableName` is the name of the custom table.

Data Types: char vector | cell array

Specify optional comma-separated pairs of `Name, Value` arguments. `Name` is the argument name and `Value` is the corresponding value. `Name` must appear inside quotes. You can specify several name and value pair arguments in any order as `Name1, Value1, ..., NameN, ValueN`.

Examples

```
% Get block mask handle.
maskObj = Simulink.Mask.get(gcb);

% Get custom table handle.
tableControl = maskObj.getDialogControl('myTable');

% Add column.
tableControl.addColumn( 'Name', 'HDL Name', 'Type', 'edit' );
```

See Also

[Simulink.Mask](#) | “Create Block Masks”

Introduced in R2019a

Simulink.Mask.EnumerationBase class

Derive an enumeration class to hold numeric values of any datatype

Description

The members of the enumeration class derived from `Simulink.Mask.EnumerationBase` can hold values of any numeric datatype. The datatype of the enumeration members should be consistent.

Methods

Public Methods

| | |
|--------------------------------------|--|
| <code>getValueArrayName</code> | Simulink creates an internal array which holds the value corresponding to each enumeration members. You can customize the name of the array as the return value of the function. |
| <code>addClassNameToEnumNames</code> | This method belongs to <code>Simulink.IntEnumType</code> . Override this function to return true to prefix the member name with the class name, false otherwise. |

Examples

Derive an enumeration class from `Simulink.Mask.EnumerationBase`

```
classdef XFactor < Simulink.Mask.EnumerationBase
    enumeration
        alpha(.001, 'alpha (.001)')
        beta(.0001, 'beta (.0001)')
        gamma(.00001, 'gamma (.00001)')
    end
end
```

See Also

`Simulink.Mask.EnumerationTypeOptions`

Topics

“Tune Mask Popup Parameters by Referencing an External Enumeration File”

Introduced in R2021a

Simulink.Mask.EnumerationTypeOptions class

Parse information from enumeration file derived from `Simulink.IntEnumType` and `Simulink.Mask.EnumerationBase`

Description

Create an instance of `Simulink.Mask.EnumerationTypeOptions` to parse the information from the enumeration file into the object.

Creation

```
enumObj =Simulink.Mask.EnumerationTypeOptions('ExternalEnumerationClass',  
'XFactor')
```

Properties

Public Properties

ExternalEnumerationClass — Reference external enumeration class

empty (default) | Name of the enumeration file

This property holds the name of the enumeration class file.

Data Types: char

EnumerationMembers — Contains the information parsed from the enumeration file

empty (default) | MemberName | DescriptiveName | Value

This property holds the member name, display name, and numeric value specified in the enumeration file.

Data Types: `Simulink.Mask.EnumerationMember`

Examples

Display the properties of the enumeration members

```
>> obj = Simulink.Mask.EnumerationTypeOptions  
( 'ExternalEnumerationClass', 'XFactor' )
```

```
obj =  
    EnumerationTypeOptions with properties:  
  
    ExternalEnumerationClass: 'XFactor'  
    EnumerationMembers: [1x3 Simulink.Mask.EnumerationMember]
```

```
>> obj.EnumerationMembers(1)
```

```
ans =  
    EnumerationMember with properties:
```

```
MemberName: 'alpha'  
DescriptiveName: 'alpha (.001)'  
Value: 1.0000e-03
```

Note The properties are read only. You can modify the enumeration file to change the properties of the enumeration members .

See Also

Simulink.Mask.EnumerationBase

Topics

“Tune Mask Popup Parameters by Referencing an External Enumeration File”

Introduced in R2021a

Simulink.dialog.LookupTableControl class

Package: Simulink.dialog

Control mask lookup tables programmatically

Description

Create an instance of `Simulink.dialog.LookupTableControl` to add values for table and breakpoints data in the lookup table control.

Properties

Public Properties

Name — Unique name

(default) | empty

Specifies unique name for the LUT control.

Data Types: `String`

Prompt — Display text

(default) | empty

Specifies the text displayed on the lookup table control.

Data Types: `String`

Row — Placement of the LUT control

(default) | new

Specifies whether dialog control is placed on the current row or on a new row.

Data Types: `Character vector`

Enabled — Is LUT control active

(default) | on

Indicates whether lookup table control is active on the mask dialog box.

Data Types: `Logical`

Visible — Visibility of LUT control on mask dialog

(default) | on

Indicates whether lookup table control is displayed on the mask dialog box.

Data Types: `Logical`

HorizontalStretch — Resizing of LUT control along the dialog

(default) | on

Indicates if lookup table control gets resized along with the dialog.

Data Types: Logical

Tooltip — Tooltip text

(default) | empty

Tool tip text for the lookup table control.

Data Types: String

Table — Table data class

(default) | empty

A class that holds the properties of table data.

Data Types: String

Breakpoints — Breakpoint data set class

(default) | empty

A class that holds the properties of an array of breakpoint data.

Data Types: String

LookupTableObject — Name of the object holding data

(default) | empty

Specifies the name of the Simulink.LookupTable object in the base workspace or model workspace that holds the table and breakpoint data.

Data Types: String

DataSpecification — Value array or table object.

(default) | empty

Indicates if the table and breakpoints data is specified explicitly or through a lookup table object.

Data Types: String

Examples

Add Table and Breakpoint Data

```
% LUT widget – Use of mask parameters
% Get mask object
>> maskObj = Simulink.Mask.get(blkhdl);

% Add table data and breakpoint parameters to mask
>> bp1 = maskObj.addParameter('Name', 'torque', 'Prompt', 'Torque:', 'Type', 'edit');
>> bp2 = maskObj.addParameter('Name', 'speed', 'Prompt', 'Engine speed:', 'Type', 'edit');
>> table = maskObj.addParameter('Name', 'fuelflowtable', 'Prompt', 'Fuel Flow Map:', 'Type', 'edit');

% Add lookup table dialog control
>> lutControl = maskObj.addDialogControl('Name', 'fuelflowlut', 'Type', 'lookuptablecontrol');
>> lutControl.Table = 'fuelflowtable';
>> lutControl.TableUnit = 'kg/s';
>> lutControl.BreakPoints = {'torque', 'speed'};
>> lutControl.BreakPointUnits = {'Nm', 'rpm'};
```

```
% Set_param/get_param on individual parameters
>> set_param(gcb, 'table', [0 0 0 0 0;0 0.00016698494399207 0.000215658653290937 0.00027587193333
0.000336081948151398;0 0.000213100798708477 0.000291370180114204 0.000369306019581262 0.00044654
0 0.000267803260011858 0.000364396694333504 0.00046262212716372 0.000558065834783092;0 0.0003227
0.00043943929392966 0.000556792164345244 0.000676348769394681;0 0.000379719832221723 0.000514675
0.000650629392939912 0.000787914000718505;0 0.000452854103193057 0.00059153462628563 0.000746324
>> set_param(gcb, 'bp1', [0;750;1053.57142857143;1357.14285714286;1660.71428571429] );
```

See Also

Simulink.dialog.LookupTableControl.Table |
Simulink.dialog.LookupTableControl.Breakpoints

Topics

“Visualize and Edit N-Dimensional Data Using Mask Lookup Table Control”

Introduced in R2021b

Simulink.dialog.LookupTableControlTable class

Package: Simulink.dialog

Control table data for mask lookup table

Description

Create an instance of `Simulink.dialog.LookupTableControlTable` to specify the properties of the table data in the lookup table control.

Properties

Public Properties

Name — Name of the parameter

(default) | empty

Name of the parameter specifying the table data.

Data Types: String

Units — Units for table data

(default) | empty

Specifies the units for the table data.

Data Types: String

FieldName — Display name

(default) | empty

Specifies the display name for the table data.

Data Types: String

Min — Minimum value

(default) | empty

Control the minimum value that can be specified for any cell in the table. This is a read only field and cannot be set through lookup table control.

Data Types: String

Max — Maximum value

(default) | empty

Control the maximum value that can be specified for any cell in the table. This is a read only field and cannot be set through lookup table control.

Data Types: String

Examples

Add Table Data

```
>>lutControl.Table.Name = 'fuelflowtable';  
>>lutControl.Table.Unit = 'kg/s';  
>>lutControl.Table.FieldName = 'Fuel Flow';
```

See Also

Simulink.dialog.LookupTableControl |
Simulink.dialog.LookupTableControl.Breakpoints

Topics

“Visualize and Edit N-Dimensional Data Using Mask Lookup Table Control”

Introduced in R2021b

Simulink.dialog.LookupTableControlbreakpoints class

Package: Simulink.dialog

Control breakpoint data set for mask lookup table

Description

Create an instance of `Simulink.dialog.LookupTableControl.Breakpoints` to specify the properties of the breakpoint data set in the lookup table control. The value of the `Breakpoints` property is an array of `Simulink.dialog.LookupTableControl.Breakpoints` objects. Each embedded object represents one breakpoint set.

Properties

Name — Name of the parameter

(default) | empty

Name of the parameter specifying the breakpoint data.

Data Types: `String`

Units — Units for the breakpoint data

(default) | empty

Specifies the units for the breakpoint data.

Data Types: `String`

FieldName — Display name

(default) | empty

Specifies the display name for the breakpoint data.

Data Types: `String`

Min — Minimum value

(default) | empty

Control the minimum value that can be specified for any cell in the table. This is a read only field and cannot be set through lookup table control.

Data Types: `String`

Max — Maximum value

(default) | empty

Control the maximum value that can be specified for any cell in the table. This is a read only field and cannot be set through lookup table control.

Data Types: `String`

Examples

Add Breakpoint Data Set

```
Set breakpoint properties of Dimension 1.  
>>lutControl.Breakpoints(1).Name = 'torque';  
>>lutControl.Breakpoints(1).Unit = 'Nm';  
>>lutControl.Breakpoints(1).FieldName = 'Torque';
```

```
Set Breakpoint properties of Dimension 2  
>>lutControl.Breakpoints(2).Name = 'speed';  
>>lutControl.Breakpoints(2).Unit = 'rpm';  
>>lutControl.Breakpoints(2).FieldName = 'Speed';
```

See Also

[Simulink.dialog.LookupTableControl](#) | [Simulink.dialog.LookupTableControl.Table](#)

Topics

“Visualize and Edit N-Dimensional Data Using Mask Lookup Table Control”

Introduced in R2021b

setTableCell

Class: Simulink.dialog.parameter.CustomTable

Package: Simulink.dialog.parameter

Set the properties of a custom table cell

Syntax

```
tableCell = tableControl.setTableCell([rowIdx colIdx], Type customtable, Evaluate, off)
```

Description

`tableCell = tableControl.setTableCell([rowIdx colIdx], Type customtable, Evaluate, off)` sets the specified properties of a cell in a custom table.

Input Arguments

tableControl — Custom table handle

table object

Handle to the custom table, specified as an object. You can use the `getDialogControl` command to get the custom table handle. For more information, see `getDialogControl`.

Consider, for example, `tableControl = maskObj.getDialogControl(TableName)`. Here, `maskObj` is the mask object and `TableName` is the name of the custom table.

Data Types: Numeric Array Name Value Pair

rowIdx — Row index

Row index number of the custom table cell for which the value is being fetched.

For example, '3'.

colIdx — Column index

Column index number of the custom table cell for which the value is being fetched.

For example, '5'.

Examples

```
% Get block mask handle.
maskObj = Simulink.Mask.get(gcb);

% Get custom table handle.
tableControl = maskObj.getDialogControl('myTable');

% Get cell properties.
```

```
tableCell = tableControl.setTableCell([2 2]);
```

See Also

[Simulink.Mask](#) | “Create Block Masks”

Introduced in R2019a

getNumberOfColumns

Class: Simulink.dialog.parameter.CustomTable

Package: Simulink.dialog.parameter

Get value of a table cell

Syntax

```
numberOfColumns = tableControl()
```

Description

`numberOfColumns = tableControl()` gets the number of columns in a custom table.

Output Arguments

numberOfColumns — Table cell value

integer

Number of columns in the custom table returned as an integer.

Examples

```
% Get block mask handle.  
maskObj = Simulink.Mask.get(gcf);  
  
% Get custom table handle.  
tableControl = maskObj.getDialogControl('myTable');  
  
% Get cell value.  
numberOfColumns = tableControl.getNumberOfColumns();
```

See Also

[Simulink.Mask](#) | “Create Block Masks”

Introduced in R2019a

getNumberOfRows

Class: Simulink.dialog.parameter.CustomTable

Package: Simulink.dialog.parameter

Get the number of rows available in a custom table

Syntax

```
numberOfRows = tableControl()
```

Description

`numberOfRows = tableControl()` gets the number of rows in a custom table.

Output Arguments

numberOfRows — Number of Rows

integer

Number of rows in the custom table returned as an integer.

Examples

```
% Get block mask handle.  
maskObj = Simulink.Mask.get(gcf);  
  
% Get custom table handle.  
tableControl = maskObj.getDialogControl('myTable');  
  
% Get number of rows.  
numberOfRows = tableControl.getNumberOfRows();
```

See Also

[Simulink.Mask](#) | “Create Block Masks”

Introduced in R2019a

addRow

Class: Simulink.dialog.parameter.CustomTable

Package: Simulink.dialog.parameter

Add a new row in the custom table

Syntax

```
NewRow = tableControl.addRow(RowValue)
```

Description

`NewRow = tableControl.addRow(RowValue)` adds a row with the specified properties in the custom table.

Input Arguments

tableControl — Custom table handle

table object

Handle to the custom table, specified as an object. You can use the `getDialogControl` command to get the custom table handle. For more information, see `getDialogControl`.

Consider, for example, `tableControl = maskObj.getDialogControl(TableName)`. Here, `maskObj` is the mask object and `TableName` is the name of the custom table.

Data Types: char vector

RowValue — Row Values for each column

table object

Row values specified for the number of columns available. If five values are provided for `RowValue` in a custom table with five columns, one row is added to the table. If 10 row values are added for such a table, then two rows are added.

Consider, for example, `tableControl = maskObj.getDialogControl(TableName)`. Here, `maskObj` is the mask object and `TableName` is the name of the custom table.

Data Types: char vector | cell array

Examples

```
% Get block mask handle.
maskObj = Simulink.Mask.get(gcb);

% Get custom table handle.
tableControl = maskObj.getDialogControl('myTable');

% Add a row with six column values.
tableControl.addRow( 'sig5', 'Input', 'Inherit', 'Inherit', 'on', 'Inherit' );
```

See Also

Simulink.Mask | “Create Block Masks”

Introduced in R2019a

getChangedCells

Class: Simulink.dialog.parameter.CustomTable

Package: Simulink.dialog.parameter

Get all the changed cells of a custom table

Syntax

```
changedCells = tableControl.getChangedCells()
```

Description

`changedCells = tableControl.getChangedCells()` gets the properties of a cell in the custom table.

Output Arguments

changedCells — Cells in a custom table whose values have been changed

cell array

Shows the changed cells in a custom table.

Examples

```
% Get block mask handle.
maskObj = Simulink.Mask.get(gcb);

% Get custom table handle.
tableControl = maskObj.getDialogControl('myTable');

% Get changed cells.
changedCell = tableControl.getchangedCells( );
```

ans =

```
    1x4 cell array

    {1x2 double}    {1x2 double}    {1x2 double}    {1x2 double}
Output: Cell Array
Input: None
```

See Also

Simulink.Mask | “Create Block Masks”

Introduced in R2019a

getColumn

Class: Simulink.dialog.parameter.CustomTable

Package: Simulink.dialog.parameter

Get the column properties

Syntax

```
FetchColumn = tableControl.getColumn(column)
```

Description

`FetchColumn = tableControl.getColumn(column)` fetches the information from the specified column of the custom table.

Input Arguments

tableControl — Custom table handle

table object

Handle to the custom table, specified as an object. You can use the `getDialogControl` command to get the custom table handle. For more information, see `getDialogControl`.

Consider, for example, `tableControl = maskObj.getDialogControl(TableName)`. Here, `maskObj` is the mask object and `TableName` is the name of the custom table.

Data Types: integer

columnIndex — Column Index

string | character array

Index of the column in the custom table.

For example, '4'.

Output Arguments

fetchcolumn — Column properties

column object

Column object

Examples

```
% Get block mask handle.
```

```
maskObj = Simulink.Mask.get(gcb);
```

```
% Get custom table handle.
```

```
tableControl = maskObj.getDialogControl('myTable');
```

```
% Get properties of column 3.  
tableControl.getColumn(3);
```

```
ans =
```

```
TableParamColumnInfo with properties:
```

```
    Name: 'Data Type'  
    Type: 'popup'  
  Enabled: 'on'  
TypeOptions: {4x1 cell}
```

See Also

[Simulink.Mask](#) | “Create Block Masks”

Introduced in R2019a

getSelectedRows

Class: Simulink.dialog.parameter.CustomTable

Package: Simulink.dialog.parameter

Get all the selected rows of a custom table

Syntax

```
selectedRows = tableControl.getSelectedRows()
```

Description

`selectedRows = tableControl.getSelectedRows()` fetches the information from the specified column of a custom table.

Output Arguments

selectedRows — Row information

numeric array

Value of the specified rows, returned as a numeric array.

Examples

```
% Get block mask handle.  
maskObj = Simulink.Mask.get(gcb);  
  
% Get custom table handle.  
tableControl = maskObj.getDialogControl('myTable');  
  
% Get selected rows.  
selectedRows = tableControl.getSelectedRows();
```

```
ans =
```

```
     3     4
```

See Also

[Simulink.Mask](#) | “Create Block Masks”

Introduced in R2019a

getTableCell

Class: Simulink.dialog.parameter.CustomTable

Package: Simulink.dialog.parameter

Get the properties of a custom table cell

Syntax

```
tableCell = tableControl.getTableCell([rowIdx colIdx])
```

Description

`tableCell = tableControl.getTableCell([rowIdx colIdx])` gets the properties of a cell in a custom table.

Input Arguments

tableControl — Custom table handle

table object

Handle to a custom table, specified as an object. You can use the `getDialogControl` command to get the custom table handle. For more information, see `getDialogControl`.

Consider, for example, `tableControl = maskObj.getDialogControl(TableName)`. Here, `maskObj` is the mask object and `TableName` is the name of the custom table.

Data Types: numeric array

rowIdx — Row index

Row index number of the custom table cell for which the value is being fetched.

For example, '3'.

colIdx — Column index

Column index number of the custom table cell for which the value is being fetched.

For example, '5'.

Output Arguments

tableCell — Table cell object

cell object

Properties of the table cell, returned as a cell array.

Examples

```
% Get block mask handle.  
maskObj = Simulink.Mask.get(gcb);
```

```
% Get custom table handle.
tableControl = maskObj.getDialogControl('myTable');

% Get cell properties.
tableCell = tableControl.getTableCell( [2 2] );

tableCell =

    CustomTableParamCellObject with properties:

        Value: 'Inherit'
        Type: 'popup'
        Enabled: 'off'
        TypeOptions: {4x1 cell}

tableCell.Value = 'Value'
```

See Also

[Simulink.Mask](#) | “Create Block Masks”

Introduced in R2019a

getValue

Class: Simulink.dialog.parameter.CustomTable

Package: Simulink.dialog.parameter

Get value of a table cell

Syntax

```
tableCellValue = tableControl.getValue([rowIdx colIdx])
```

Description

`tableCellValue = tableControl.getValue([rowIdx colIdx])` gets the value of a cell in a custom table.

Input Arguments

tableControl — Custom table handle

table object

Handle to the custom table, specified as an object. You can use the `getDialogControl` command to get the custom table handle. For more information, see `getDialogControl`.

Consider, for example, `tableControl = maskObj.getDialogControl(TableName)`. Here, `maskObj` is the mask object and `TableName` is the name of the custom table.

Data Types: numeric array

rowIdx — Row index

|

Row index number of the custom table cell for which the value is being fetched.

For example, [2 2].

colIdx — Column index

|

Column index number of the custom table cell for which the value is being fetched.

For example,[2 2].

Output Arguments

tableCellValue — Table cell value

character vector

Value of the table cell, returned as a character vector.

Examples

```
% Get block mask handle.
maskObj = Simulink.Mask.get(gcf);

% Get custom table handle.
tableControl = maskObj.getDialogControl('myTable');

% Get cell value.
tableCellValue = tableControl.getValue([2 2]);

ans =
    'Input'
```

See Also

[Simulink.Mask](#) | “Create Block Masks”

Introduced in R2019a

insertColumn

Class: Simulink.dialog.parameter.CustomTable

Package: Simulink.dialog.parameter

Insert a column at a specific position in the custom table

Syntax

```
tableControl.insertColumn(columnIndex[Name,Value])
```

Description

`tableControl.insertColumn(columnIndex[Name,Value])` inserts a column with the specified properties at a specified index in a custom table.

Input Arguments

tableControl — Custom table handle

table object

Handle to the custom table, specified as an object. You can use the `getDialogControl` command to get the custom table handle. For more information, see `getDialogControl`.

Consider, for example, `tableControl = maskObj.getDialogControl(TableName)`. Here, `maskObj` is the mask object and `TableName` is the name of the custom table.

Data Types: char vector | cell array

Name-Value Pair Arguments

Specify optional comma-separated pairs of `Name, Value` arguments. `Name` is the argument name and `Value` is the corresponding value. `Name` must appear inside quotes. You can specify several name and value pair arguments in any order as `Name1, Value1, ..., NameN, ValueN`.

Type —

edit | checkbox | popup

Type of control that is used to specify the value of this parameter. The permitted values are: edit (default), checkbox, popup.

TypeOptions —

''

The options that are displayed within a popup control or in a promoted parameter. This field is a cell array.

Enabled —

'on' | 'off'

Option to specify whether the user can set parameter value.

Examples

```
% Get block mask handle.  
maskObj = Simulink.Mask.get(gcb);  
  
% Get custom table handle.  
tableControl = maskObj.getDialogControl('myTable');  
  
% Insert a column at the fifth position.  
tableControl.insertColumn(5, 'Name', 'HDL Name', 'Type', 'edit');
```

See Also

[Simulink.Mask](#) | “Create Block Masks”

Introduced in R2019a

insertRow

Class: Simulink.dialog.parameter.CustomTable

Package: Simulink.dialog.parameter

Insert a row at a specific position in a custom table

Syntax

```
InsertedRow = tableControl.insertRow(rowIndex,string1,string2)
```

Description

`InsertedRow = tableControl.insertRow(rowIndex,string1,string2)` inserts a row with specified properties at the specified index in a custom table.

Input Arguments

tableControl — Custom table handle

table object

Handle to the custom table, specified as an object. You can use the `getDialogControl` command to get the custom table handle. For more information, see `getDialogControl`.

Consider, for example, `tableControl = maskObj.getDialogControl(TableName)`. Here, `maskObj` is the mask object and `TableName` is the name of the custom table.

Data Types: `char` vector | `cell` array

rowIndex — Row Index

Index in table at which the new row is to be inserted.

For example, '4'.

Examples

```
% Get block mask handle.
```

```
maskObj = Simulink.Mask.get(gcb);
```

```
% Get custom table handle.
```

```
tableControl = maskObj.getDialogControl('myTable');
```

```
% Insert Row.
```

```
tableControl.insertRow( rowIndex,'insertSig4', 'Input', 'Inherit', 'Inherit', 'on', 'Inherit' );
```

See Also

`Simulink.Mask` | “Create Block Masks”

Introduced in R2019a

removeColumn

Class: Simulink.dialog.parameter.CustomTable

Package: Simulink.dialog.parameter

Remove an existing column from a specific position in a custom table

Syntax

```
tableControl.removeColumn(columnIndex)
```

Description

`tableControl.removeColumn(columnIndex)` removes a column from the specified index in a custom table.

Input Arguments

tableControl — Custom table handle

table object

Handle to the custom table, specified as an object. You can use the `getDialogControl` command to get the custom table handle. For more information, see `getDialogControl`.

Consider, for example, `tableControl = maskObj.getDialogControl(TableName)`. Here, `maskObj` is the mask object and `TableName` is the name of the custom table.

Data Types: `string`

columnIndex — Column Index

integer

Column index number of the custom table from which the column is to be removed.

For example, '4'.

Examples

```
% Get block mask handle.
maskObj = Simulink.Mask.get(gcb);

% Get custom table handle.
tableControl = maskObj.getDialogControl('myTable');

% Remove the third column.
tableControl.removeColumn(3);
```

See Also

`Simulink.Mask` | “Create Block Masks”

Introduced in R2019a

removeRow

Class: Simulink.dialog.parameter.CustomTable

Package: Simulink.dialog.parameter

Remove an existing row from a specific position in a custom table

Syntax

```
tableControl.removeRow(rowIndex)
```

Description

`tableControl.removeRow(rowIndex)` removes the row from a specified position in a custom table.

Input Arguments

tableControl — Custom table handle

table object

Handle to the custom table, specified as an object. You can use the `getDialogControl` command to get the custom table handle. For more information, see `getDialogControl`.

Consider, for example, `tableControl = maskObj.getDialogControl(TableName)`. Here, `maskObj` is the mask object and `TableName` is the name of the custom table.

Data Types: integer

rowIndex — Row Index

Row index number of the custom table from which the row is to be removed.

For example, '4'.

Examples

```
% Get block mask handle.
maskObj = Simulink.Mask.get(gcb);

% Get custom table handle.
tableControl = maskObj.getDialogControl('myTable');

% Remove row with index number 6.
tableControl.removeRow(6);
```

See Also

`Simulink.Mask` | “Create Block Masks”

Introduced in R2019a

swapRows

Class: Simulink.dialog.parameter.CustomTable

Package: Simulink.dialog.parameter

Swap two existing rows in a custom table

Syntax

```
tableControl.swapRows(rowIndex1, rowIndex2)
```

Description

`tableControl.swapRows(rowIndex1, rowIndex2)` swaps specified rows in a custom table.

Input Arguments

tableControl — Custom table handle

table object

Handle to the custom table, specified as an object. You can use the `getDialogControl` command to get the custom table handle. For more information, see `getDialogControl`.

Consider, for example, `tableControl = maskObj.getDialogControl(TableName)`. Here, `maskObj` is the mask object and `TableName` is the name of the custom table.

Data Types: integer

rowIndex1 — Row Index value

integer

Row index number of the first row to be swapped with another row.

For example, '4'.

rowIndex2 — Row Index value

integer

Row index number of the second row to be swapped with another row.

For example, '5'.

Examples

```
% Get block mask handle.
maskObj = Simulink.Mask.get(gcb);

% Get custom table handle.
tableControl = maskObj.getDialogControl('myTable');

% Swap rows 3 and 6.
```

```
tableControl.swapRows(3,6);
```

See Also

[Simulink.Mask](#) | “Create Block Masks”

Introduced in R2019a

Simulink.dialog.parameter.CustomTable class

Package: Simulink.dialog.parameter

Create custom tables programmatically

Description

Use an instance of `Simulink.dialog.parameter.CustomTable` class to perform the following operations:

- Create and remove custom tables
- Insert, remove, and get values of columns.
- Insert, remove, swap, and add rows.

Methods

| | |
|---------------------------------|--|
| <code>addColumn</code> | Add new column in the custom table |
| <code>setTableCell</code> | Set the properties of a custom table cell |
| <code>getNumberOfColumns</code> | Get value of a table cell |
| <code>getNumberOfRows</code> | Get the number of rows available in a custom table |
| <code>addRow</code> | Add a new row in the custom table |
| <code>getChangedCells</code> | Get all the changed cells of a custom table |
| <code>getColumn</code> | Get the column properties |
| <code>getSelectedRows</code> | Get all the selected rows of a custom table |
| <code>getTableCell</code> | Get the properties of a custom table cell |
| <code>getValue</code> | Get value of a table cell |
| <code>insertColumn</code> | Insert a column at a specific position in the custom table |
| <code>insertRow</code> | Insert a row at a specific position in a custom table |
| <code>removeColumn</code> | Remove an existing column from a specific position in a custom table |
| <code>removeRow</code> | Remove an existing row from a specific position in a custom table |
| <code>swapRows</code> | Swap two existing rows in a custom table |

See Also

Topics

“Control Masks Programmatically”

“Create Block Masks”

Simulink.dialog.ListBoxControl class

Package: Simulink.dialog

Control listbox programmatically

Description

Use an instance of `Simulink.dialog.ListBoxControl` class to perform the following operations:

- Get selected items from the listbox
- Set selected items in the listbox

Properties

Name

Uniquely identifies the dialog control and is a required field.

Type: character vector

Prompt

Specifies the text displayed on the button dialog control.

Type: character vector

Default: empty

Type Options

Specifies the options shown in the listbox.

Type: cell array

Default: empty

Callback

Specifies the MATLAB command (s) to be executed when the dialog control is invoked.

Type: character vector

Default: empty

Row

Specifies whether dialog control is placed on the current row or on a new row.

Type: character vector

Value: 'current' | 'new'

Default: 'current'

Enabled

Indicates whether container is active on the mask dialog box.

Type: boolean

Value: 'on' | 'off'

Default: 'on'

Visible

Indicates whether container is displayed on the mask dialog box.

Type: boolean

Value: 'on' | 'off'

Default: 'on'

Multiselect

Indicates whether container is enabled for multiple selection.

Type: boolean

Value: 'on' | 'off'

Default: 'on'

Methods

| | |
|------------------|---|
| setSelectedItems | Set values for a listbox |
| getSelectedItems | Get the values of selected items from a listbox |

See Also

Topics

“Control Masks Programmatically”

“Create Block Masks”

setSelectedItems

Class: Simulink.dialog.ListBoxControl

Package: Simulink.dialog

Set values for a listbox

Syntax

```
setItems = listBoxControl.setSelectedItems({string1,'string2',...})
```

Description

`setItems = listBoxControl.setSelectedItems({string1,'string2',...})` set the values for the selected items in the listbox.

Input Arguments

listControl — Lisbox handle

table object

Handle to the listbox, specified as an object. You can use the `getDialogControl` command to get the listbox handle. For more information, see `getDialogControl`.

For example, `listboxControl = maskObj.getDialogControl('listboxname')`. Here, `maskObj` is the mask object and `listboxname` is the name of the listbox.

Data Types: cell array

string1 — value to be set

string

Value to be set for selected items in the listbox

For example, 'Hello'.

Examples

```
% Get block mask handle
maskObj = Simulink.Mask.get(gcb);

% Get listbox handle
listboxControl = maskObj.getDialogControl('Control2');

% Set selected items
listboxControl.setSelectedItems({'Hello','World'});
```

See Also

`Simulink.Mask` | “Create Block Masks”

Introduced in R2019a

getSelectedItems

Class: Simulink.dialog.ListBoxControl

Package: Simulink.dialog

Get the values of selected items from a listbox

Syntax

```
getItems = listBoxControl.getSelectedItems()
```

Description

`getItems = listBoxControl.getSelectedItems()` fetches the information of the selected items from the listbox.

Output Arguments

getItems — value of selected items

cell array

Value of the selected items, returned as a cell array.

Examples

```
% Get block mask handle
maskObj = Simulink.Mask.get(gcb);

% Get listbox handle
listBoxControl = maskObj.getDialogControl('Control2');

% Get selected items
getItems = listBoxControl.getSelectedItems();

getItems =
    1x2 cell array
    {'Hello', 'World'}
```

See Also

[Simulink.Mask](#) | “Create Block Masks”

Introduced in R2019a

Simulink.MaskParameter class

Package: Simulink

Control mask parameters programmatically

Description

Use an instance of `Simulink.MaskParameter` to set the properties of mask parameters.

Properties

Type

Specifies the mask parameter type.

Type: character vector

Values:

'edit' | 'checkbox' | 'popup' | 'combobox' | 'listbox' | 'radiobutton' | 'slider' | 'dial' | 'spinbox' | 'unit' | 'textarea' | 'customtable' | 'unidt' | 'min' | 'max' | 'promote'

Default: 'edit'

TypeOptions

Specifies the option for the parameter if it exists, otherwise, it is empty. Applicable for parameters of type popup, radio, textarea, combobox, Datatypestr, and promote .

Type: cell array of character vectors

Default: {''}

Name

Specifies the name of the mask parameter. This name is assigned to the mask workspace variable created for the mask parameter. The mask parameter name must not match the built-in parameter name.

Type: character vector

Default: Auto generated

Prompt

Specifies a character vector that appears as the label associated with the parameter on the mask dialog.

Type: character vector

Default: Empty character vector

Value

Specifies the value of the mask parameter. Masking supports all value types.

Default: Default value depends on the type of mask parameter. For example, the default value for `Checkbox` is 'on' while the default value for `Listbox` is { ' ' } and accepts a cell array of character vectors.

Evaluate

Indicates if the parameter value is to be evaluated in MATLAB or treated as a character vector when the block is evaluated.

Type: boolean

Values: 'on' | 'off'

Default: 'on'

Tunable

Indicates if the parameter value can be changed during simulation.

Type: boolean

Values: 'on' | 'off'

Default: 'on'

NeverSave

Indicates if the parameter value gets saved in the model file.

Type: boolean

Values: 'on' | 'off'

Default: 'off'

Hidden

Indicates if the parameter should never show on the mask dialog box.

Type: boolean

Values: 'on' | 'off'

Default: 'off'

ReadOnly

Indicates if the parameter on the mask dialog box is editable or is read-only.

Type: boolean

Values: 'on' | 'off'

Default: 'off'

Enabled

Indicates if the parameter is enabled in the mask dialog box.

Type: boolean

Values: 'on' | 'off'

Default: 'on'

Visible

Indicates if the parameter is visible in the mask dialog box.

Type: boolean

Values: 'on' | 'off'

Default: 'on'

ShowTooltip

Indicates if tool tip is enabled for the mask parameter.

Type: boolean

Values: 'on' | 'off'

Default: 'on'

Callback

Specifies the MATLAB code that executes when a user changes the parameter value from the mask dialog box.

Type: character vector

Default: Empty character vector

TabName

Specifies the tab name of the mask dialog box where the parameter is displayed.

Type: character vector

Default: Empty character vector

Alias

Specifies the alternate name for mask parameter.

Type: character vector

Default: Empty character vector

DialogControl

Specifies the layout options of mask dialog.

Type: Class of type Simulink.dialog.parameter.<Typeofparameter>

Values:

'Edit' | 'Checkbox' | 'Popup' | 'Combobox' | 'Listbox' | 'RadioButton' | 'Slider' | 'Dial' |
'Spinbox' | 'Unit' | 'TextArea' | 'CustomTable' | 'Min' | 'Max'

Default: Edit

ConstraintName

Indicates the constraint associated with a parameter. To associate a constraint programmatically the constraint must be already available. To associate a constraint from a mat file use the format <matfilename>:<constraintname>.

Type: character vector

Default: Empty character vector

Methods

set Set properties of mask parameters

See Also

Topics

“Control Masks Programmatically”

“Create Block Masks”

set

Class: Simulink.MaskParameter

Package: Simulink

Set properties of mask parameters

Syntax

```
Simulink.MaskParameter.set(Name, Value)
```

Description

`Simulink.MaskParameter.set(Name, Value)` sets the properties of a mask parameter.

Input Arguments

Name-Value Pair Arguments

Specify optional comma-separated pairs of `Name`, `Value` arguments. `Name` is the argument name and `Value` is the corresponding value. `Name` must appear inside quotes. You can specify several name and value pair arguments in any order as `Name1, Value1, . . . , NameN, ValueN`.

Type

Type of control that is used to specify the value of this parameter.

Default: edit

TypeOptions

The options that are displayed within a popup control or in a promoted parameter. This field is a cell array.

Default: empty

Name

The name of the mask parameter. This name is assigned to the mask workspace variable created for this parameter.

Default: empty

Prompt

Text that identifies the parameter on the Mask Parameters dialog.

Default: empty

Value

The default value of the mask parameter in the Mask Parameters dialog.

Default: Type specific; depends on the Type of the parameter

Evaluate

Option to specify whether parameter must be evaluated.

Default: 'on'

Tunable

Option to specify whether parameter is tunable.

Default: 'on'

Enabled

Option to specify whether user can set parameter value.

Default: 'on'

Visible

Option to set whether mask parameter is hidden or visible to the user.

Default: 'on'

Callback

Container for MATLAB code that executes when user makes a change in the Mask Parameters dialog and clicks **Apply**.

Default: empty

Examples

- 1 Get mask as an object using a masked block's path.

```
p = Simulink.Mask.get('myModel/Subsystem');
```

- 2 Get a mask parameter.

```
a = p.Parameters(1);
```

- 3 Edit mask parameter so it is of type popup, cannot be evaluated.

```
a.set('Type','popup','TypeOptions',{'Red' 'Blue' 'Green'},...  
      'Evaluate','off');
```

See Also

[Simulink.Mask](#) | [Simulink.MaskParameter](#) | “Create Block Masks”

Simulink.dialog.Control class

Package: Simulink.dialog

Create instances of dialog control

Description

Use an instance of `Simulink.dialog.Control` class to create, delete, or search dialog controls.

Properties

Name

Uniquely identifies the dialog control element and is a required field.

Type: character vector

See Also

`Simulink.dialog.Button` | `Simulink.dialog.Hyperlink` | `Simulink.dialog.Image` | `Simulink.dialog.Text` | `Simulink.dialog.parameter.Control` | `Simulink.dialog.Container` | "Create Block Masks"

Simulink.dialog.Container class

Package: Simulink.dialog

Create instances of a container dialog control

Description

Use an instance of Simulink.dialog.Container class to add container type dialog control.

Properties

Name

Uniquely identifies the container dialog control and is a required field.

Type: character vector

Enabled

Indicates whether container is active on the mask dialog box.

Type: boolean

Value: 'on' | 'off'

Default: 'on'

Visible

Indicates whether container is displayed on the mask dialog box.

Type: boolean

Value: 'on' | 'off'

Default: 'on'

AlignPrompts

Allows you to align the parameters vertically on the mask dialog box.

Type: boolean

Value: 'on' | 'off'

Default: 'off'

DialogControls

Specifies the child dialog controls contained in the container.

Type: Simulink.dialog.Control

Default: Empty array

Methods

| | |
|----------------------------------|--|
| <code>addDialogControl</code> | Add dialog control elements to mask dialog box |
| <code>removeDialogControl</code> | Remove dialog control element from mask dialog box |
| <code>getDialogControl</code> | Search for a specific dialog control on the mask |

See Also

`Simulink.dialog.Group` | `Simulink.dialog.Panel` | `Simulink.dialog.Tab` | `Simulink.dialog.TabContainer` | `Simulink.dialog.Control` | "Create Block Masks"

addDialogControl

Class: Simulink.dialog.Container

Package: Simulink.dialog

Add dialog control elements to mask dialog box

Syntax

```
successIndicator = maskObj.addDialogControl(controlType,controlIdentifier)  
successIndicator = maskObj.addDialogControl(Name,Value)
```

Description

`successIndicator = maskObj.addDialogControl(controlType,controlIdentifier)` adds dialog control elements like text, hyperlinks, or tabs to mask dialog box. First get the mask object and assign it to the variable `maskObj`

`successIndicator = maskObj.addDialogControl(Name,Value)` specifies the `Name` and `Value` arguments for an element on the mask dialog box. You can specify multiple `Name-Value` pairs.

Input Arguments

controlType — Value type of dialog control element

character vector

Type of dialog control element, specified

- 'panel'
- 'group'
- 'tabcontainer'
- 'tab'
- 'collapsiblepanel'
- 'text'
- 'image'
- 'hyperlink'
- 'pushbutton'

controlIdentifier — Unique identifier for the element

character vector

Specifies the programmatic identifier for the element of mask dialog box. Use a name that is unique and does not have space between words. For more information, see “Variable Names”.

Name-Value Pair Arguments

Specify optional comma-separated pairs of `Name`, `Value` arguments. `Name` is the argument name and `Value` is the corresponding value. `Name` must appear inside single quotes (' ') and is case-sensitive.

You can specify several name and value pair arguments in any order as Name1, Value1, . . . , NameN, ValueN.

Type

Type of control that is used to specify the value of this dialog control element. Type is a required argument. The permitted values are 'panel', 'group', 'tabcontainer', 'tab', 'collapsiblepanel', 'text', 'image', 'hyperlink', and 'pushbutton'. If the parent dialog control type is 'tabcontainer', the child dialog control must be 'tab'.

Name

The identifier of the dialog control element. Name is a required argument. This field is available for all dialog control types.

Prompt

Text that is displayed in the dialog control element on the Mask dialog box. This field is available for all except for panel and image dialog control types.

Default: empty

Enabled

Option to specify whether you can set value for the dialog control element. This field is available for all dialog control types.

Default: 'on'

Visible

Option to set whether the dialog control element is hidden or visible to the user. This field is available for all dialog control types.

Default: 'on'

Callback

Container for MATLAB code that executes when you edit the dialog control element and click **Apply**. This field is available only for the hyperlink and pushbutton dialog control types.

Default: empty

Row

Option to set whether the dialog control is placed in the new row or the same row. This field is available for all dialog control types.

Default: empty

FilePath

Contains the path to an image file. This field is available for image, and pushbutton dialog control types.

Default: empty

Container

Option to specifies a container for the child dialog control. The permitted values are the names of 'panel', 'group', and 'tab' dialog controls.

Examples

Add Dialog Control Elements to Mask Dialog Box

Get mask object and add dialog control element to it.

```
% Get mask object on model Engine
maskObj = Simulink.Mask.get('Engine/Gain');

% Add hyperlink to mask dialog box

maskLink = maskObj.addDialogControl('hyperlink','link_1');
maskLink.Prompt = 'Mathworks Home Page';
maskLink.Callback = 'web(''www.mathworks.com'')'

% Alternative method to add hyperlink

maskLink = maskObj.addDialogControl('hyperlink','link_2');
maskLink.Prompt = 'www.mathworks.com';

% Add text to mask dialog box

maskText = maskObj.addDialogControl('text','text_tag');
maskText.Prompt = 'Enable range checking';

% Add button to mask dialog box

maskButton = maskObj.addDialogControl('pushbutton','button_tag');
maskButton.Prompt = 'Compute';
```

Add Dialog Control Elements to Mask Dialog Box Tabs

Create tabs on the mask dialog box and add elements to these tabs.

```
% Get mask object on a block named 'GainBlock'
maskObj = Simulink.Mask.get('GainBlock/Gain');

% Create a tab container

maskObj.addDialogControl('tabcontainer','allTabs');
tabs = maskObj.getDialogControl('allTabs');

% Create tabs and name them

maskTab1 = tabs.addDialogControl('tab','First');
maskTab1.Prompt = 'First tab';
```

```
maskTab2 = tabs.addDialogControl('tab','Second');
maskTab2.Prompt = 'Second tab';

% Add elements to one of the tabs

firstTab = tabs.getDialogControl('First');
firstTab.addDialogControl('text','textOnFirst');
firstTab.getDialogControl('textOnFirst').Prompt = 'Tab one';
```

Add Dialog Control Element Using Name-Value Pair

Add dialog control element and specify values for it

```
% Get mask object on model Engine

maskObj = Simulink.Mask.get('Engine/Gain');

% Add a dialog box and specify values for it

maskDialog = maskObj.addDialogControl('Type','text',...
'Prompt','hello','Visible','off');
```

See Also

[Simulink.dialog.Container](#) | “Create Block Masks”

Introduced in R2014a

removeDialogControl

Class: Simulink.dialog.Container

Package: Simulink.dialog

Remove dialog control element from mask dialog box

Syntax

```
successIndicator = maskVariable.removeDialogControl(controlIdentifier)
```

Description

`successIndicator = maskVariable.removeDialogControl(controlIdentifier)` removes dialog control element, specified by `controlIdentifier`, like text, hyperlinks, or tabs from a mask dialog box. First get the mask object and assign it to the variable `maskVariable`.

Successful removal of a dialog control element returns a Boolean value of 1.

Input Arguments

controlIdentifier — Unique identifier for the element

character vector

Programmatic identifier for the dialog control element of mask dialog box, specified as a character vector.

Examples

Remove Dialog Control Element from Mask Dialog Box

```
% Get mask object on the Gain block in the model Engine.
```

```
maskObj = Simulink.Mask.get('Engine/Gain');
```

```
% Remove element named AllTab from mask dialog box.
```

```
maskTab = maskObj.removeDialogControl('AllTab');
```

See Also

Simulink.dialog.Container | “Create Block Masks”

Introduced in R2013b

getDialogControl

Class: Simulink.dialog.Container

Package: Simulink.dialog

Search for a specific dialog control on the mask

Syntax

```
[control, phandle] = handle.getDialogControl(controlIdentifier)
```

Description

[control, phandle] = handle.getDialogControl(controlIdentifier), search for a specific child dialog control recursively on the mask dialog box.

Input Arguments

controlIdentifier

Name of the dialog control being searched on the mask dialog box.

Default:

Output Arguments

control

Target dialog control being searched on the mask dialog box.

phandle

Parent of the dialog control being searched mask dialog box.

Examples

Find a dialog control

Find a text dialog control on the mask dialog box. maskObj is the handle to the mask object. The getDialogControl method returns the handle to the dialog control (hdlgctrl) and handle to the parent dialog control (phandle).

```
[hdlgctrl, phandle] = maskObj.getDialogControl('txt_var')
```

See Also

Simulink.dialog.Container | “Create Block Masks”

Simulink.dialog.Panel class

Package: Simulink.dialog

Create an instance of a panel dialog control

Description

Use an instance of `Simulink.dialog.Panel` class to create an instance of panel dialog control.

Properties

Name

Uniquely identifies the panel dialog control and is a required field.

Type: character vector

Row

Specifies whether panel is placed on the current row or on a new row.

Type: character vector

Values: 'current' | 'new'

Default: 'new'

Enabled

Specifies whether panel is active on the mask dialog box.

Type: boolean

Values: 'on' | 'off'

Default: 'on'

Visible

Specifies whether panel is displayed on the mask dialog box.

Type: boolean

Values: 'on' | 'off'

Default: 'on'

DialogControls

Specifies the child dialog controls contained in the panel.

Type: Simulink.dialog.Control

Default: Empty array

Methods

| | |
|----------------------------------|--|
| <code>addDialogControl</code> | Add dialog control elements to mask dialog box |
| <code>removeDialogControl</code> | Remove dialog control element from mask dialog box |
| <code>getDialogControl</code> | Search for a specific dialog control on the mask |

See Also

`Simulink.dialog.Group` | `Simulink.dialog.Tab` | `Simulink.dialog.TabContainer` | `Simulink.dialog.Container` | `Simulink.dialog.Control` | "Create Block Masks"

Simulink.dialog.Group class

Package: Simulink.dialog

Create an instance of a group dialog control

Description

Use an instance of Simulink.dialog.Group class to create an instance of group dialog control.

Properties

Name

Uniquely identifies the group dialog control and is a required field.

Type: character vector

Prompt

Specifies the text displayed on the group.

Type: character vector

Default: Empty character vector

Row

Specifies whether group is placed on the current row or on a new row.

Type: character vector

Values: 'current' | 'new'

Default: 'new'

Enabled

Specifies whether group is active on the mask dialog box.

Type: boolean

Values: 'on' | 'off'

Default: 'on'

Visible

Specifies whether group is displayed on the mask dialog box.

Type: boolean

Values: 'on' | 'off'

Default: 'on'

DialogControls

Specifies the child dialog controls contained in the group.

Type: Simulink.dialog.Control

Default: Empty array

Methods

| | |
|---------------------|--|
| addDialogControl | Add dialog control elements to mask dialog box |
| removeDialogControl | Remove dialog control element from mask dialog box |
| getDialogControl | Search for a specific dialog control on the mask |

See Also

Simulink.dialog.Panel | Simulink.dialog.Tab | Simulink.dialog.TabContainer |
Simulink.dialog.Container | Simulink.dialog.Control | "Create Block Masks"

Simulink.dialog.Tab class

Package: Simulink.dialog

Create an instance of a tab dialog control

Description

Use an instance of Simulink.dialog.Tab class to create an instance of tab dialog control.

Properties

Name

Uniquely identifies the tab dialog control and is a required field.

Type: character vector

Prompt

Specifies the text displayed on the tab.

Type: character vector

Default: Empty character vector

Enabled

Specifies whether tab is active on the mask dialog box.

Type: boolean

Values: 'on' | 'off'

Default: 'on'

Visible

Specifies whether tab is displayed on the mask dialog box.

Type: boolean

Values: 'on' | 'off'

Default: 'on'

DialogControls

Specifies the child dialog controls contained in the tab dialog control.

Type: Simulink.dialog.Control

Default: Empty array

Methods

| | |
|----------------------------------|--|
| <code>addDialogControl</code> | Add dialog control elements to mask dialog box |
| <code>removeDialogControl</code> | Remove dialog control element from mask dialog box |
| <code>getDialogControl</code> | Search for a specific dialog control on the mask |

See Also

`Simulink.dialog.Group` | `Simulink.dialog.Panel` | `Simulink.dialog.TabContainer` | `Simulink.dialog.Container` | `Simulink.dialog.Control` | “Create Block Masks”

Simulink.dialog.TabContainer class

Package: Simulink.dialog

Create an instance of a tab container dialog control

Description

Use an instance of `Simulink.dialog.TabContainer` class to create an instance of tab container dialog control. Tab container dialog box be used to group the tab dialog controls.

Properties

Name

Uniquely identifies the tab container dialog control and is a required field.

Type: character vector

Row

Specifies whether tab container is placed on the current row or on a new row.

Type: enumerated string

Values: 'current' | 'new'

Default: 'new'

Enabled

Specifies whether tab container is active on the mask dialog box.

Type: boolean

Values: 'on' | 'off'

Default: 'on'

Visible

Specifies whether tab container is displayed on the mask dialog box.

Type: boolean

Values: 'on' | 'off'

Default: 'on'

DialogControls

Specifies the child dialog controls contained in the group. `Simulink.dialog.TabContainer` class can only contain `Simulink.dialog.Tab` dialog control.

Type: Simulink.dialog.Tab

Default: Empty array

Methods

| | |
|---------------------|--|
| addDialogControl | Add dialog control elements to mask dialog box |
| removeDialogControl | Remove dialog control element from mask dialog box |
| getDialogControl | Search for a specific dialog control on the mask |

See Also

Simulink.dialog.Group | Simulink.dialog.Panel | Simulink.dialog.Tab |
Simulink.dialog.Container | Simulink.dialog.Control | “Create Block Masks”

Simulink.dialog.Button class

Package: Simulink.dialog

Create a button dialog control

Description

Use an instance of Simulink.dialog.Button class to add a button dialog control.

Properties

Name

Uniquely identifies the dialog control and is a required field.

Type: character vector

Prompt

Specifies the text displayed on the button dialog control.

Type: character vector

Default: empty

FilePath

Specifies the path to the image file to be shown on the button dialog control.

Type: character vector

Default: empty

Callback

Specifies the MATLAB command (s) to be executed when the dialog control is invoked.

Type: character vector

Default: empty

Row

Specifies whether dialog control is placed on the current row or on a new row.

Type: character vector

Value: 'current' | 'new'

Default: 'current'

Enabled

Indicates whether container is active on the mask dialog box.

Type: boolean

Value: 'on' | 'off'

Default: 'on'

Visible

Indicates whether container is displayed on the mask dialog box.

Type: boolean

Value: 'on' | 'off'

Default: 'on'

See Also

[Simulink.dialog.Control](#) | “Create Block Masks”

Simulink.dialog.Hyperlink class

Package: Simulink.dialog

Create a hyperlink dialog control

Description

Use an instance of `Simulink.dialog.Hyperlink` class to add a hyperlink dialog control.

Properties

Name

Uniquely identifies the dialog control and is a required field.

Type: character vector

Prompt

Specifies the text displayed on the hyperlink.

Type: character vector

Default: empty

Callback

Specifies the MATLAB command (s) to be executed when the dialog control is invoked.

Type: character vector

Default: empty

Row

Specifies whether hyperlink is placed on the current row or on a new row.

Type: character vector

Value: 'current' | 'new'

Default: 'new'

Enabled

Indicates whether hyperlink is active on the mask dialog box.

Type: boolean

Value: 'on' | 'off'

Default: 'on'

Visible

Indicates whether hyperlink is displayed on the mask dialog box.

Type: boolean

Value: 'on' | 'off'

Default: 'on'

See Also

Simulink.dialog.Control | “Create Block Masks”

Simulink.dialog.Image class

Package: Simulink.dialog

Create an image dialog control

Description

Use an instance of `Simulink.dialog.Image` class to add an image dialog control.

Properties

Name

Uniquely identifies the dialog control and is a required field.

Type: character vector

FilePath

Specifies the path to the image file to be displayed on the dialog box.

Type: character vector

Default: empty

Row

Specifies whether dialog control is placed on the current row or on a new row.

Type: character vector

Value: 'current' | 'new'

Default: 'new'

Enabled

Indicates whether image is active on the mask dialog box.

Type: boolean

Value: 'on' | 'off'

Default: 'on'

Visible

Indicates whether image is displayed on the mask dialog box.

Type: boolean

Value: 'on' | 'off'

Default: 'on'

See Also

Simulink.dialog.Control | "Create Block Masks"

Simulink.dialog.Text class

Package: Simulink.dialog

Create a text dialog control

Description

Use an instance of `Simulink.dialog.Text` class to add a text dialog control.

Properties

Name

Uniquely identifies the dialog control element and is a required field.

Type: character vector

Prompt

Specifies the text displayed on the mask dialog box.

Type: character vector

Default: empty

WordWrap

Specifies whether to wrap long text to the next line on the mask dialog box.

Type: boolean

Value: 'on' | 'off'

Default: 'on'

Row

Specifies whether dialog control is placed on the current row or on a new row.

Type: character vector

Value: 'current' | 'new'

Default: 'new'

Enabled

Indicates whether dialog control is active on the mask dialog box.

Type: boolean

Value: 'on' | 'off'

Default: 'on'

Visible

Indicates whether dialog control is displayed on the mask dialog box.

Type: boolean

Value: 'on' | 'off'

Default: 'on'

See Also

`Simulink.dialog.Control` | "Create Block Masks"

Simulink.dialog.parameter.Control class

Package: Simulink.dialog.parameter

Create a parameter dialog control

Description

Use an instance of `Simulink.dialog.parameter.Control` class to add a parameter dialog control.

Properties

Name

Uniquely identifies the dialog control element. This is a required field and has the same value as its underlying parameter name.

Type: character vector

Row

Specifies whether the dialog control is placed on the current row or on a new row.

Type: character vector

Value: 'current' | 'new'

Default: 'new'

See Also

`Simulink.dialog.Control` | “Create Block Masks”

Simulink.op.ModelOperatingPoint class

Package: Simulink.op

Access simulation operating point data

Description

The `Simulink.op.ModelOperatingPoint` class contains all of the information associated with an operating point of a simulation, including the logged states, the time of the snapshot, and the start time of the simulation. To access this data for a specific block in the model, use the `get` method or the `loggedStates` property.

Properties

description — Description of the saved operating point

character vector

Description of the saved operating point object, specified as a character vector. By default, Simulink generates a character vector based on your model name.

loggedStates — Continuous and discrete states of the blocks

dataset | structure

Continuous and discrete states of the block that depend on the `SaveFormatSettings` of the model.

If specified as a `Dataset` format, you cannot assign a structure or a `Simulink.SimulationData.Dataset` object with a different number of elements than that of the `Dataset` object used for `loggedStates`.

If specified as a `Structure` format, you cannot assign a `Dataset` object.

With dataset logging format, the answers returned by `ModelOperatingPoint` always match those returned by state logging (non-Operating Point save).

snapshotTime — Simulation time of saving operating point

double

Time at which Simulink takes a snapshot of the complete simulation operating point.

This data is read-only.

startTime — Time at which simulation starts

double

Time at which simulation of the model starts.

This data is read-only.

Methods

Public Methods

| Method | Purpose |
|--------|--|
| set | Set operating point of individual Stateflow chart, MATLAB function, or S-function block |
| get | Access operating point of individual Stateflow chart, MATLAB function, or S-Function block |

Examples

Save and Restore an Operating Point

Use the `sim` command with `set_param`. Set the `SaveOperatingPoint` parameter to 'on'.

```
sldemo_tonegen
set_param('sldemo_tonegen','SaveFinalState','on','FinalStateName',...
'myOperPoint','SaveOperatingPoint','on');
simOut = sim('sldemo_tonegen','StopTime','10');
myOperPoint = simOut.myOperPoint;
```

To configure the simulation to restore the operating point that you saved, use `LoadInitialState`. Simulink® restores the `ModelOperatingPoint` object when you simulate the model.

```
set_param('sldemo_tonegen','LoadInitialState','on','InitialState',...
'myOperPoint');
myOperPoint = simOut.myOperPoint;
```

Tip

Before you save the operating point, disable the **Block Reduction** parameter in **Configuration Settings > Simulation Target > Advanced Parameters**.

See Also

set | get

Topics

“Save and Restore Simulation Operating Point”
“Operating Point Behavior”

Introduced in R2019a

get

Class: Simulink.op.ModelOperatingPoint

Package: Simulink.op

Access operating point of an individual Stateflow chart, MATLAB function, or S-function block

Syntax

```
blockOperatingPoint = get(modelOperatingPoint, 'blockpath')
```

Description

`blockOperatingPoint = get(modelOperatingPoint, 'blockpath')` returns the operating point of the block specified by `blockpath`. The `blockpath` must refer to a Stateflow chart, MATLAB functions, or S-function block. To access states of other types of blocks, see the `loggedStates` property of the `ModelOperatingPoint` class.

Input Arguments

modelOperatingPoint — A `Simulink.op.ModelOperatingPoint` object
object

Operating point object for the model.

blockpath — Path of the block
character vector

Path of the block to set the operating point values, specified as a character vector

Output Arguments

blockOperatingPoint — Operating point of the block specified
string

Name of the operating point to be set to the specified block.

Examples

Get the Operating Point of a Block

To get the operating point of a block that is in a referenced model, specify the full path of the block relative to the root model.

```
model = 'sldemo_fuelsys_dd';
opt = struct('SaveFinalState','on','SaveOperatingPoint','on','StopTime','1');
simOut = sim(model,opt);
modelOp = simOut.xFinal;
blockPath = 'sldemo_fuelsys_dd/Fuel Rate Controller|sldemo_fuelsys_dd_controller/control_logic';
chartOp = get(modelOp, blockPath)
```

This data is read only.

See Also

set | Simulink.op.ModelOperatingPoint | ssSetOperatingPointVisibility

Topics

“Save and Restore Simulation Operating Point”

“Operating Point Behavior”

Introduced in R2019a

set

Class: Simulink.op.ModelOperatingPoint

Package: Simulink.op

Set operating point of an individual Stateflow chart, MATLAB function, or S-function block

Syntax

```
set(modelOperatingPoint, 'blockpath', blockOperatingPoint)
```

Description

`set(modelOperatingPoint, 'blockpath', blockOperatingPoint)` sets the operating point to the block specified by a `blockpath`. The `blockpath` must refer to a Stateflow chart, a MATLAB function, or a S-function block. To modify states of other types of blocks, use the `loggedStates` of the `Simulink.op.ModelOperatingPoint` class.

Input Arguments

modelOperatingPoint — A `Simulink.op.ModelOperatingPoint` object
object

Operating point object for the model.

blockpath — Path of the block
character vector

Path of the block for which to set the operating point values, specified as a character vector

blockOperatingPoint — Operating point of the block specified
object

Operating point to be set to the specified block, specified as an object.

Examples

Set the Operating Point of a Block

This example shows how to set the operating point for a block.

```
newOperPoint = set(myOperPoint, 'myModel/chart', newChartOperPoint)
```

See Also

`get` | `Simulink.op.ModelOperatingPoint` | `ssSetOperatingPointVisibility`

Topics

“Save and Restore Simulation Operating Point”

“Operating Point Behavior”

Introduced in R2019a

Simulink.sfunction.Analyzer class

Package: Simulink.sfunction

Create a Simulink S-function analyzer object

Description

This class enables you to perform checks on S-functions within a model or a library. These checks include MEX compiler setup check, source code check, MEX-file check, parameter robustness check for S-functions. The check result can be accessed either from a MATLAB structure or an HTML report.

The S-function analyzer checks the source code of the S-functions based on the S-function names. The S-function source code can be automatically included in the analysis if the source file is a single .c or .cpp file in the MATLAB path that has the same name as the S-function. Otherwise, the build information can be specified through the S-function Analyzer APIs. If no source code is available on the specified path, the analysis is skipped.

Construction

`sfunAnalyzer = Simulink.sfunction.Analyzer(model)` creates a `Simulink.sfunction.Analyzer` object with the model you specify. In this case, the source code for the S-function can be automatically included in the analysis if the source code file is a single .c or .cpp file in the MATLAB path that has the same name as the S-function. For example, if the specified model contains an S-function called `mysfun`, and the source file for `mysfun` is a single file `mysfun.c` in the MATLAB path, a `Simulink.sfunction.analyzer.BuildInfo` object is automatically created and included in the analysis.

`sfunAnalyzer = Simulink.sfunction.Analyzer(model, 'BuildInfo', {bdInfo})` creates a `Simulink.sfunction.Analyzer` object with the model and a `Simulink.sfunction.analyzer.BuildInfo` object named `bdInfo`.

`sfunAnalyzer = Simulink.sfunction.Analyzer(model, 'Options', {opts})` creates a `Simulink.sfunction.Analyzer` object with the model and a `Simulink.sfunction.analyzer.Options` object named `opts`.

Input Arguments

model — Specify a model in the path

character vector | string

Names of the model in the path, specified as a string or character vector.

Name-Value Pair Arguments

Specify optional comma-separated pairs of `Name`, `Value` arguments. `Name` is the argument name and `Value` is the corresponding value. `Name` must appear inside quotes. You can specify several name and value pair arguments in any order as `Name1, Value1, ..., NameN, ValueN`.

Example: `'BuildInfo', {buildInfo}`

BuildInfo — Specify the buildinfo object

cell array

A cell array of buildinfo objects. See `Simulink.sfunction.analyzer.BuildInfo` for more information.

Options — Specify the S-function analyzer running options

object

An object to specify S-function analyzer running options. These checks include Polyspace Code Prover™ and parameter robustness checks. See `Simulink.sfunction.analyzer.Options` for more information.

Methods

| | |
|-----------------------------|--|
| <code>run</code> | Perform checks on S-functions |
| <code>generateReport</code> | Generate an HTML report of S-function checks |

See Also

`run` | `generateReport` | `Simulink.sfunction.analyzer.BuildInfo` | `Simulink.sfunction.analyzer.Options` | `findSfunctions`

Introduced in R2017b

run

Class: Simulink.sfunction.Analyzer

Package: Simulink.sfunction

Perform checks on S-functions

Syntax

```
result = run()
```

Description

`result = run()` returns a struct containing the result from the analyzer checks. An example result struct has the following fields:

```
TimeGenerated: '19-Jul-2017 19:25:32'  
Platform: 'win64'  
Release: '(R2017b)'  
SimulinkVersion: '9.0'  
ExemptedBlocks: {}  
MexConfiguration: [1x1 mex.CompilerConfiguration]  
Data: [4x4 struct]
```

Output Arguments

result — Sfunction.Analyzer structure

MATLAB structure

MATLAB structure containing the result of S-function analyzer.

See Also

[Simulink.sfunction.Analyzer | generateReport](#) |

[Simulink.sfunction.analyzer.BuildInfo](#) | [Simulink.sfunction.analyzer.Options](#) |

[findSfunctions](#)

Introduced in R2017b

generateReport

Class: Simulink.sfunction.Analyzer

Package: Simulink.sfunction

Generate an HTML report of S-function checks

Syntax

```
generateReport()
```

Description

`generateReport()` generates an HTML report and launches the browser to display the report.

See Also

`Simulink.sfunction.Analyzer` | `run` | `Simulink.sfunction.analyzer.BuildInfo` | `Simulink.sfunction.analyzer.Options` | `findSfunctions`

Introduced in R2017b

Simulink.sfunction.analyzer.BuildInfo class

Package: Simulink.sfunction.analyzer

Create an object to represent build information

Description

Simulink.sfunction.analyzer.BuildInfo object captures the build information for S-functions, such as source files, header files, and linking libraries, for use with the Simulink.sfunction.Analyzer class.

Construction

`bdInfo = Simulink.sfunction.analyzer.BuildInfo(SfcnFile)` creates a Simulink.sfunction.analyzer.BuildInfo object.

`bdInfo = Simulink.sfunction.analyzer.BuildInfo(SfcnFile, 'SrcPath', {srcpaths}, 'ExtraSrcFileList', {srcfilelist})` creates a Simulink.sfunction.analyzer.BuildInfo object for a C-MEX S-function source file, a list of extra source files located in the specified path.

`bdInfo = Simulink.sfunction.analyzer.BuildInfo(SfcnFile, 'ObjFileList', {objfilelist})` creates a Simulink.sfunction.analyzer.BuildInfo object for C-MEX S-function source file and list of extra objective code files.

`bdInfo = Simulink.sfunction.analyzer.BuildInfo(SfcnFile, 'IncPaths', {incpathslist})` creates a Simulink.sfunction.analyzer.BuildInfo object for C-MEX S-function source file and paths to the folders including header files.

`bdInfo = Simulink.sfunction.analyzer.BuildInfo(SfcnFile, 'LibFileList', {libfilelist}, 'LibPaths', {libpaths})` creates a Simulink.sfunction.analyzer.BuildInfo object for C-MEX S-function source file and library files and library file paths used for building.

`bdInfo = Simulink.sfunction.analyzer.BuildInfo(SfcnFile, 'PreProcDefList', {preprocdir})` creates a Simulink.sfunction.analyzer.BuildInfo object for C-MEX S-function source file and pre-processor directives list.

Input Arguments

SfcnFile — S-function source file

character vector | string

S-function source file having the same name as the S-function.

Name-Value Pair Arguments

Specify optional comma-separated pairs of `Name`, `Value` arguments. `Name` is the argument name and `Value` is the corresponding value. `Name` must appear inside quotes. You can specify several name and value pair arguments in any order as `Name1, Value1, ..., NameN, ValueN`.

Example: 'SrcPath', {srcpath}

SrcPath — Source file path

cell array of character vectors | string

Search paths to extra S-function source files that are referenced by `SfcnFile`, specified as a cell array or a string.

ExtraSrcFileList — Extra source file list

cell array of character vectors | string

List of extra S-function source files, specified as a cell array or string.

ObjFileList — Extra objective code

cell array

List of objective files used for building, specified as a cell array.

IncPaths — Search paths for header files

cell array of character vectors | string

Specify paths to include folders for header files, specified as a cell array or a string.

LibFileList — External libraries list

cell array of character vectors | string

List of external library files used for building, specified as a cell array or string.

LibPaths — Search paths for external libraries

cell array of character vectors | string

Search paths for external library files used for building, specified as a cell array or a string.

PreProcDefList — Preprocessor directives

cell array of character vectors | string

List of the preprocessor directives, specified as a cell array or a string.

Output Arguments**bdInfo — BuildInfo object**

object

Build information for the S-functions supplied to the S-function analyzer. Returns a `simulink.sfunction.analyzer.BuildInfo` object.

Examples

Create a `bdInfo` object for an S-function `mysfun` that includes a source file `mysfun.c`:

Basic Use

```
bdInfo = Simulink.sfunction.analyzer.BuildInfo('mysfun.c');
```

The output `bdInfo` has the following fields:

```
bdInfo =
```

```
BuildInfo with properties:
```

```

    SfcnFile: 'mysfun.c'
    SfcnName: 'mysfun'
    SrcType: 'C'
    SrcPaths: {}
    ExtraSrcFileList: {}
    ObjFileList: {}
    IncPaths: {}
    LibFileList: {}
    LibPaths: {}
    PreProcDefList: {}

```

Advanced Use

Create a `bdInfo` object for an S-function `mysfun` that includes a source file `mysfun.c` and also includes:

- List of extra source files, `extra1.c` and `extra2.c`
- Paths to source file folders, `/path1` and `/path2`.
- List of objective files, `o1.obj` and `o2.obj`.
- List of library files, `l1.lib` and `l2.lib`.
- Library paths, `/libpath1`.
- Pre-processor running directives, `-DDEBUG`.

```

Simulink.sfunction.analyzer.BuildInfo('mysfun.c',...
    'ExtraSrcFileList',{extra1.c,extra2.c},... %specify extra s
    'SrcPaths',{/path1,/path2},...           %specify paths t
    'ObjFileList',{o1.obj,o2.obj},...        %specify object
    'LibFileList',{l1.lib,l2.lib},...        %specify library
    'LibPaths',{/libpath1},...              %specify library
    'PreProcDefList',{DEBUG});              %specify prepro

```

See Also

[Simulink.sfunction.Analyzer | run | generateReport](#) |
[Simulink.sfunction.analyzer.Options | findSfunctions](#)

Introduced in R2017b

Simulink.sfunction.analyzer.Options class

Package: Simulink.sfunction.analyzer

Create an object to specify options for running S-function checks

Description

Simulink.sfunction.analyzer.Options object is created through the constructor Simulink.sfunction.analyzer.Options(). Simulink.sfunction.analyzer.Options object captures the options for running S-function checks. These checks include whether to enable Polyspace and Parameter Robustness checks, maximum model simulation time and output path for result report.

Construction

opts= Simulink.sfunction.analyzer.Options() returns a options object with these property values:

```
EnablePolyspace: 0
EnableRobustness: 0
EnableUsePublishedOnly: 0
ReportPath: pwd
ModelSimTimeOut: 10
```

Properties

EnablePolyspace — Polyspace Code Prover check

False (default) | True

Boolean type check to determine whether to include Polyspace Code Prover check.

Note These checks usually take some time to run.

EnableRobustness — Parameter robustness check

False (default) | True

Boolean type check to indicate whether to include Robustness checks.

Note These checks usually take some time to run.

ReportPath — Generated report directory

current working directory (default) | character array

Path to the generated report directory.

ModelSimTimeOut — Maximum model simulation time

10 (default) | scalar

Maximum model simulation time in seconds.

EnableUsePublishedOnly — Check for use of only documented APIs

False (default) | True

Check to indicate if any undocumented S-function APIs are used in the code.

See Also

Simulink.sfunction.Analyzer | run | generateReport |
Simulink.sfunction.analyzer.BuildInfo | findSfunctions

Introduced in R2017b

findSfunctions

Find and return all eligible S-functions in a model

Syntax

```
sfuns = Simulink.sfunction.analyzer.findSfunctions(model)
```

Description

`sfuns = Simulink.sfunction.analyzer.findSfunctions(model)` returns all eligible S-functions in a model for the S-function checks. Rules are applied to filter out all ineligible S-functions.

Input Arguments

model — A Simulink model or library in path

character vector | string vector

A Simulink model or library in path specified as a string or a character vector.

Output Arguments

sfuns — A list of all eligible S-functions

cell array of character vectors

Eligible S-functions in the model, specified as a cell array of character vectors.

See Also

`Simulink.sfunction.Analyzer` | `run` | `generateReport` |

`Simulink.sfunction.analyzer.BuildInfo` | `Simulink.sfunction.analyzer.Options`

Introduced in R2017b

plot

Package: Simulink.SimulationData

Plot simulation output data in the Simulation Data Inspector

Syntax

```
plot(simOutObj)
runObj = plot(simOutObj)
```

Description

`plot(simOutObj)` plots the simulation output data in the simulation output object, `simOutObj`, in the Simulation Data Inspector and opens the Simulation Data Inspector so you can view the plotted simulation output data. You can use the `plot` function to plot simulation results stored in these simulation output objects:

- `Simulink.SimulationOutput`
- `Simulink.SimulationData.DataStoreMemory`
- `Simulink.SimulationData.Parameter`
- `Simulink.SimulationData.Signal`
- `Simulink.SimulationData.State`
- `Stateflow.SimulationData.Data`
- `Stateflow.SimulationData.State`
- `sltest.Assessment`

These simulation output objects also have plot functions that plot the data in and then open the Simulation Data Inspector:

- `Simulink.SimulationData.Dataset`
- `Simulink.SimulationData.DatasetRef`

When a simulation output object contains fewer than eight signals to plot, the Simulation Data Inspector layout changes to 1-by- n , where n is the number of signals to plot, and plots one signal on each subplot. When the simulation output object contains more than eight signals to plot, the Simulation Data Inspector layout changes to 1-by-1 and plots the first signal in the simulation output object.

When some or all of the data in a `Simulink.SimulationOutput` object is in a Simulation Data Inspector run, the `plot` function opens the Simulation Data Inspector and plots all the signals in the run. When the data does not correspond to a run in the Simulation Data Inspector, the `plot` function imports the data to a new run. When you use the `plot` function to plot a single signal, the `plot` function always imports the data for the signal to a new run.

`runObj = plot(simOutObj)` returns the `Simulink.sdi.Run` object corresponding to the plotted data.

Examples

Access and Plot Simulation Output Data

The `ex_vdp_simout_plot` model used in this example is configured to log signals, outputs, and states and return all logged data in a single simulation output. The single simulation output is a `Simulink.SimulationOutput` object that contains one or more types of other simulation output objects, depending on the kinds of data you log. This example shows how to access each type of logged data and use the `plot` function to plot the data in the Simulation Data Inspector. To generate the `SimulationOutput` object containing all the logged data, simulate the model.

```
open_system('ex_vdp_simout_plot.slx')
out = sim('ex_vdp_simout_plot.slx');
```

Plot Data in a SimulationOutput Object

You can pass the single simulation output, stored in a `Simulink.SimulationOutput` object, to the `plot` function to view the data in the Simulation Data Inspector. When you plot data in a `SimulationOutput` object that corresponds to a run in the Simulation Data Inspector, data in the object that also logs to the Simulation Data Inspector is plotted. The model logs data using the `Dataset` format, so all logged data streams to the Simulation Data Inspector.

When you use the `plot` function to plot the data, the Simulation Data Inspector updates to a 1-by-8 layout and plots one signal on each subplot.

```
plot(out)
```

Plot Data for a Single Signal

When you plot the data for a single signal, the Simulation Data Inspector always imports the data for the signal to a new run. Use the `get` function for the `SimulationOutput` object to access the signal logging `Dataset` object, `logsout`.

```
logsout = get(out, 'logsout');
```

Then, use the `get` function for the `Dataset` object to access the data for the first element.

```
sig1 = get(logsout, 1);
```

When you plot the data for the signal, the Simulation Data Inspector imports the signal to a new run, updates the layout to 1-by-1, and plots the signal.

```
plot(sig1)
```

Input Arguments

simOutObj — Simulation output object containing simulation data to plot

`Simulink.SimulationOutput` | `Simulink.SimulationData.DataStoreMemory` |
`Simulink.SimulationData.Parameter` | `Simulink.SimulationData.Signal` |
`Simulink.SimulationData.State` | `sltest.Assessment` |
`Stateflow.SimulationData.Data` | `Stateflow.SimulationData.State`

Simulation output object containing data you want to plot and view in the Simulation Data Inspector. This `plot` function supports these simulation output objects:

- `Simulink.SimulationOutput`
- `Simulink.SimulationData.DataStoreMemory`
- `Simulink.SimulationData.Parameter`
- `Simulink.SimulationData.Signal`
- `Simulink.SimulationData.State`
- `Stateflow.SimulationData.Data`
- `Stateflow.SimulationData.State`
- `sltest.Assessment`

Example: `plot(out)`

Output Arguments

runObj — Run that corresponds to plotted data

`Simulink.sdi.Run` object

Run that corresponds to the plotted data, returned as a `Simulink.sdi.Run` object.

See Also

`plot`

Topics

“View Data in the Simulation Data Inspector”

Introduced in R2019b

addElement

Add element to end of a Dataset object

Syntax

```
dataset = addElement(dataset,element)
dataset = addElement(dataset,element,name)
```

Description

`dataset = addElement(dataset,element)` adds an element to the `Simulink.SimulationData.Dataset` dataset.

`dataset = addElement(dataset,element,name)` adds an element to the `Simulink.SimulationData.Dataset` data set and gives the element the name that you specify with the name argument. If the object already has a name, the element instead uses the name you specify by using the name argument.

Input Arguments

dataset — Data set

`SimulationData.Dataset` object

The data set to which to add the element.

element — Element to add

`Simulink.SimulationData.Signal` object | `Simulink.SimulationData.State` object | `Simulink.SimulationData.DataStoreMemory` object | timeseries object | `matlab.io.datastore.SimulationDatastore` object

Element to add to the data set, specified as a `Simulink.SimulationData.Signal`, `Simulink.SimulationData.DataStoreMemory`, or `matlab.io.datastore.SimulationDatastore` object.

name — Name for element

character vector

Name for element, specified as a character vector.

Output Arguments

dataset — Data set

character vector

The data set to which you add the element, returned as a character vector. The new element is added to the end of the data set.

Examples

Create a Data Set

Create a data set and add three elements to it.

```
time = 0.1*(0:100)';
ds = Simulink.SimulationData.Dataset;
element1 = Simulink.SimulationData.Signal;
element1.Name = 'A';
element1.Values = timeseries(sin(time),time);
ds = addElement(ds,element1);
element2 = Simulink.SimulationData.Signal;
element2.Name = 'B';
element2.Values = timeseries(2*sin(time),time);
ds = addElement(ds,element2);
element3 = Simulink.SimulationData.Signal;
element3.Name = 'C';
element3.Values = timeseries(3*sin(time),time);
ds = addElement(ds,element3);
ds
```

ds =

Simulink.SimulationData.Dataset '' with 3 elements

| | | Name | BlockPath |
|---|--------------|------|-----------|
| 1 | [1x1 Signal] | A | '' |
| 2 | [1x1 Signal] | B | '' |
| 3 | [1x1 Signal] | C | '' |

- Use braces { } to access, modify, or add elements using index.

Create a Run in the Simulation Data Inspector

You can programmatically import data into the Simulation Data Inspector by creating a run from data in the base workspace or a file. This example creates data in the workspace and then illustrates several methods of creating a Simulation Data Inspector run containing the data.

Create Data

Create data in the workspace. The Simulation Data Inspector supports time series data in many formats. This example creates data using the `timeseries` and `Simulink.SimulationData.Dataset` formats and saves the data in a MAT-file.

Create a sine signal and a cosine signal. Store the data for each signal in a `timeseries` object with a descriptive name.

```
time = 0:0.2:20;

sine_vals = sin(2*pi/5*time);
sine_ts = timeseries(sine_vals,time);
sine_ts.Name = 'Sine, T=5';

cos_vals = cos(2*pi/8*time);
cos_ts = timeseries(cos_vals,time);
cos_ts.Name = 'Cosine, T=8';
```

You can use the `Dataset` format to group related signal data together in a single object. The `Dataset` format is the default format for logged data and is supported for loading simulation input data. Create a `Dataset` object that contains the sinusoid timeseries data.

```
sinusoids_ds = Simulink.SimulationData.Dataset;
sinusoids_ds = addElement(sinusoids_ds,cos_ts);
sinusoids_ds = addElement(sinusoids_ds,sine_ts);
```

Scale each signal by a factor of 2 and create a `Dataset` object to contain the signal data for the results.

```
doubSine = 2*sine_ts;
doubCos = 2*cos_ts;

doubSinusoids_ds = Simulink.SimulationData.Dataset;
doubSinusoids_ds = addElement(doubSinusoids_ds,doubSine);
doubSinusoids_ds = addElement(doubSinusoids_ds,doubCos);
```

Finally, save the timeseries data to a MAT-file.

```
save sinusoids.mat sine_ts cos_ts
```

Open the Simulation Data Inspector

To view the runs you create in each section, open the Simulation Data Inspector by entering `Simulink.sdi.view` in the MATLAB™ Command Window.

Create a Run Using a `Simulink.sdi.Run` Object

You can import your data into a run in the Simulation Data Inspector by creating an empty run and then adding data to the run from the workspace or a file. Depending on your task, you can use the `Simulink.sdi.Run.create` function or the `Simulink.sdi.createRun` function to create the empty run. The `Simulink.sdi.Run.create` function returns the `Simulink.sdi.Run` object for the new run, and the `Simulink.sdi.createRun` function returns the run ID for the new run.

This example creates an empty run using the `Simulink.sdi.Run.create` function, gives the run a meaningful name and description, and then adds the sine and cosine timeseries data using the `add` function.

```
sinusoidsRun = Simulink.sdi.Run.create;
sinusoidsRun.Name = 'Sinusoids';
sinusoidsRun.Description = 'Sine and cosine signals of different frequencies';

add(sinusoidsRun,'vars',sine_ts,cos_ts)
```

This example uses the `Simulink.sdi.createRun` function to create a new run in the Simulation Data Inspector called `My Waves` and then uses the `Simulink.sdi.addToRun` function to add the sine and cosine timeseries data to the run.

```
runID = Simulink.sdi.createRun('My Waves');
signalID = Simulink.sdi.addToRun(runID,'vars',sine_ts,cos_ts);
```

Create a Run from a Workspace Variable

You can create a run from a single variable in the workspace. After creating the run, you can add additional data, or you can create another run to contain your other data. The variable you use to create the run can be a `timeseries` object with data that corresponds to only one signal, or it can be a `Dataset` object that contains several signals.

When you use this syntax to create a run from a single workspace variable, the run takes the same name as the object used to create it.

```
runID = Simulink.sdi.createRun(sine_ts);
```

The `Simulink.sdi.createRun` function returns the run ID for the run it creates. You can use the `Simulink.sdi.getRun` function to access the Run object for the run.

```
sineRun = Simulink.sdi.getRun(runID);
sineRun.Name
```

```
ans =
'Sine, T=5'
```

Create a Run from Multiple Workspace Variables

When your data exists in multiple variables in your workspace, you can use the `Simulink.sdi.createRun` function with the `vars` option to import the data from multiple variables into a single run in the Simulation Data Inspector. You can also use this syntax to create a run for a single variable that uses a name you specify.

This example creates a run called `My Sinusoids` that contains data for the sine and cosine `timeseries` objects.

```
runID = Simulink.sdi.createRun('My Sinusoids','vars',sine_ts,cos_ts);
```

Create a Run and Specify Source Names

You can use the `namevalue` option of the `Simulink.sdi.createRun` function to create a run and specify names for the signals in the run. This syntax can be particularly helpful when you import individual leaf signals from hierarchical data.

This example creates a run containing the data for both the `Dataset` objects. Each `Dataset` object contains data for more than one signal, so the imported run data has hierarchy. The name-value syntax in this example specifies a name for the hierarchical node that corresponds to each `Dataset` object.

```
runID = Simulink.sdi.createRun('Waves','namevalue',{'Sinusoids',...
    'BigSinusoids'},{sinusoids_ds,doubSinusoids_ds});
```

Create a Run from Data in a File

You can also use the `Simulink.sdi.createRun` function to import data into the Simulation Data Inspector from a file. Use the `file` option to import the data in the `sinusoids.mat` file.

```
runID = Simulink.sdi.createRun('Wave Data','file','sinusoids.mat');
```

Alternative

To streamline indexing syntax, you can use curly braces (`{}`) to add an element to a dataset, instead of using `addElement`. For the index, use a scalar that is greater than the number of elements by one. The new element becomes the last element of the dataset.

```
time = 0.1*(0:100)';
ds = Simulink.SimulationData.Dataset;
element1 = Simulink.SimulationData.Signal;
element1.Name = 'A';
```

```
element1.Values = timeseries(sin(time),time);  
ds{1} = element1;  
element2 = Simulink.SimulationData.Signal;  
element2.Name = 'B';  
element2.Values = timeseries(2*sin(time),time);  
ds{2} = element2;  
element3 = Simulink.SimulationData.Signal;  
element3.Name = 'C';  
element3.Values = timeseries(3*sin(time),time);  
ds{3} = element3;
```

See Also

[Simulink.SimulationData.BlockPath](#) | [Simulink.SimulationData.Signal](#) | [matlab.io.datastore.SimulationDatastore](#) | [Simulink.SimulationData.DataStoreMemory](#) | [concat](#) | [find](#) | [get](#) | [getElementNames](#) | [numElements](#) | [setElement](#) | [Simulink.SimulationData.Dataset](#)

Topics

[“Migrate Scripts That Use Legacy ModelDataLogs API”](#)
[“Export Signal Data Using Signal Logging”](#)
[“Log Data Stores”](#)
[“Convert Logged Data to Dataset Format”](#)
[“Migrate Scripts That Use Legacy ModelDataLogs API”](#)

Introduced in R2011a

concat

Concatenate dataset to another dataset

Syntax

```
dataset1 = concat(dataset1,dataset2)
```

Description

`dataset1 = concat(dataset1,dataset2)` concatenates the elements of `dataset2` to `dataset1`.

Input Arguments

dataset1 — Dataset to concatenate to

data set

Dataset to concatenate to with `dataset2`, returned as a cell array.

dataset2 — Dataset to concatenate

data set

Data set to concatenate to `dataset1`, specified as a cell array.

Output Arguments

dataset1 — Concatenated dataset

data set

Concatenated dataset from `dataset1` and `dataset2`.

Examples

Concatenate ds1 to ds

Convert output from two To Workspace blocks to Dataset format and concatenate them.

```
mdl = 'myvdp';  
open_system(mdl);  
sim(mdl)  
ds = Simulink.SimulationData.Dataset(simout);  
ds1 = Simulink.SimulationData.Dataset(simout1);  
dsfinal = concat(ds,ds1);
```

See Also

`Simulink.SimulationData.BlockPath` | `Simulink.SimulationData.Signal` | `Simulink.SimulationData.DataStoreMemory` | `addElement` | `find` | `get` | `getElementNames` | `numElements` | `setElement` | `Simulink.SimulationData.Dataset`

Topics

“Migrate Scripts That Use Legacy ModelDataLogs API”

“Export Signal Data Using Signal Logging”

“Log Data Stores”

“Convert Logged Data to Dataset Format”

“Migrate Scripts That Use Legacy ModelDataLogs API”

Introduced in R2015a

exportToPreviousRelease

Package: Simulink.SimulationData

Save a Dataset object to a MAT-file you can open in any release

Syntax

```
exportToPreviousRelease(ds, filename, dsname)
exportToPreviousRelease( ____, version)
exportToPreviousRelease( ____, '-append' )
exportToPreviousRelease( ____, '-nocompression' )
```

Description

`exportToPreviousRelease(ds, filename, dsname)` saves the `Simulink.SimulationData.Dataset` object, `ds`, to the MAT-file specified by the `filename` input, using the name specified by the `dsname` input. You can load the Dataset saved in the file in any release that supports the Dataset format. When you do not use this function to save a Dataset object to a file, you may not be able to load the data in releases prior to R2017a. When you do not need to open and use the Dataset data in a release prior to R2017a, you can use the `save` function.

`exportToPreviousRelease(____, version)` saves data stored in a Dataset object to a MAT-file you can load in a previous release, using the MAT-file version specified by `version`.

`exportToPreviousRelease(____, '-append')` adds data stored in a Dataset object to a MAT-file you can load in a previous release without overwriting the contents of the MAT-file.

`exportToPreviousRelease(____, '-nocompression')` saves the Dataset object to a MAT-file without compression. The `'-nocompression'` option only supports Version 7 and Version 7.3 MAT-files.

Examples

Save a Dataset to a MAT-File to Load in a Prior Release

You can use the `exportToPreviousRelease` function to save data stored in a `Simulink.SimulationData.Dataset` object in a MAT-file that you can load in a previous release. This example saves data logged from a simulation in a MAT-file using the `exportToPreviousRelease` function, and then appends another Dataset object containing data logged from another simulation to the same MAT-file.

Save Dataset Data to a MAT-File

To create a Dataset object containing logged data, run a simulation of the `ex_vdp` model that logs data for signals `x1` and `x2`. The model is configured to generate a single simulation output containing all simulation data, including the signal logging data stored in the Dataset object, `logout`.

```
open_system('ex_vdp.slx')
out = sim('ex_vdp');
logouts = out.logouts;
```

Use the `exportToPreviousRelease` function to save the signal logging data to a MAT-file you can share with colleagues and collaborators who may use different Simulink™ versions.

```
exportToPreviousRelease(logouts, 'vdpLoggedData.mat', 'ex_vdpSim1')
```

Append Additional Data to the MAT-File

You can use the `exportToPreviousRelease` function to add data to a MAT-file. For example, if you run another simulation that logs data and get new results you want to share. You can load the `Dataset` object saved using the `exportToPreviousRelease` function in any release that supports the `Dataset` format.

```
set_param('ex_vdp/Mu', 'Gain', '0.5')
out = sim('ex_vdp');
logouts = out.logouts;

exportToPreviousRelease(logouts, 'vdpLoggedData.mat', 'ex_vdpSim2', '-append')
```

Input Arguments

ds — Dataset object containing data you want to load in an earlier release

`Simulink.SimulationData.Dataset` object

`Simulink.SimulationData.Dataset` object you want to save in a MAT-file and load in a previous release.

Example: `logouts`

filename — Name of file to export data to

string | character array

Name of the file to export data to. If the file does not exist, the `exportToPreviousRelease` function creates the file. When the file exists, you can overwrite the data in the file, or you can use the `'-append'` input to append the `Dataset` data to the file.

Example: `'myfile.mat'`

Data Types: char | string

dsname — Name to use for the saved Dataset object in the MAT-file

string | character array

Name to use for the `Dataset` object saved in the MAT-file. The name does not have to match the name of the `Dataset` object containing the data you want to save in the MAT-file.

Example: `'myLoggedData'`

Data Types: char | string

version — MAT-file version

'-v7' (default) | '-v7.3' | '-v6'

MAT-file version. By default, the `exportToPreviousRelease` function creates Version 7 MAT-files, unless you have changed the preference for the default MAT-file version created by save operations. For more information, see “MAT-File Versions”. You cannot save `Dataset` data to Version 4 MAT-files.

Data Types: `char` | `string`

See Also

`Simulink.SimulationData.Dataset` | `save`

Topics

“MAT-File Versions”

Introduced in R2019b

extractTimetable

Package: Simulink.SimulationData

Extract data from Simulink.SimulationData.Dataset or Simulink.SimulationData.Signal objects into timetables

Syntax

```
TT = extractTimetable(ds)
TT = extractTimetable(ds,Name=Value)
```

Description

`TT = extractTimetable(ds)` extracts data from multiple elements of `ds` into a timetable. The input argument `ds` is a Simulink.SimulationData.Dataset or Simulink.SimulationData.Signal object.

`TT = extractTimetable(ds,Name=Value)` extracts data into one or more timetables according to options that are specified by one or more name-value arguments. For example, the `SignalNames` argument specifies the names of the signals to extract from `ds`.

You can return the data as:

- A single timetable that includes all elements that contain time series data, synchronized to the union of the time stamps of all signals.
- A cell array of timetables that each contain data for signals that share the same sample time.
- A cell array of timetables that each contain time series data for a single signal.

Examples

Extract Signals into Timetable

Extract signals from a Simulink.SimulationData.Dataset object into a timetable.

First, create a Dataset object and add two signals to it. To calculate data for the signals, use the `sin` and `cos` functions. Each signal is in its own timeseries object. These signals both have a 0.1-second time step.

```
Time = 0.1*(0:99)';
ds = Simulink.SimulationData.Dataset;

element1 = Simulink.SimulationData.Signal;
element1.Name = "Sine";
element1.Values = timeseries(sin(Time),Time);
ds = addElement(ds,element1);

element2 = Simulink.SimulationData.Signal;
element2.Name = "Cosine";
element2.Values = timeseries(cos(Time),Time);
ds = addElement(ds,element2)
```

```
ds =
Simulink.SimulationData.Dataset '' with 2 elements
```

| | | Name | BlockPath |
|---|--------------|--------|-----------|
| 1 | [1x1 Signal] | Sine | '' |
| 2 | [1x1 Signal] | Cosine | '' |

- Use braces { } to access, modify, or add elements using index.

Next, extract data from `ds` and put the data into a timetable. The timetable `TT` has two variables, `Sine` and `Cosine`, that contain data from both elements of `ds`.

```
TT = extractTimetable(ds)
```

```
TT=100x2 timetable
   Time      Sine      Cosine
   -----
0 sec      0          1
0.1 sec    0.099833    0.995
0.2 sec    0.19867    0.98007
0.3 sec    0.29552    0.95534
0.4 sec    0.38942    0.92106
0.5 sec    0.47943    0.87758
0.6 sec    0.56464    0.82534
0.7 sec    0.64422    0.76484
0.8 sec    0.71736    0.69671
0.9 sec    0.78333    0.62161
1 sec      0.84147    0.5403
1.1 sec    0.89121    0.4536
1.2 sec    0.93204    0.36236
1.3 sec    0.96356    0.2675
1.4 sec    0.98545    0.16997
1.5 sec    0.99749    0.070737
   :
```

Add a third signal to `ds` with a time vector that has a 0.05-second time step.

```
Time2 = 0.05*(0:149)';
element3 = Simulink.SimulationData.Signal;
element3.Name = "Tangent";
element3.Values = timeseries(tan(Time2),Time2);
ds = addElement(ds,element3)
```

```
ds =
Simulink.SimulationData.Dataset '' with 3 elements
```

| | | Name | BlockPath |
|---|--------------|---------|-----------|
| 1 | [1x1 Signal] | Sine | '' |
| 2 | [1x1 Signal] | Cosine | '' |
| 3 | [1x1 Signal] | Tangent | '' |

- Use braces { } to access, modify, or add elements using index.

Extract the data from the three elements of `ds`. The elements have `timeseries` objects whose time vectors do not match. Thus, the vector of row times of `TT` is the union of the time vectors of the three `timeseries` objects. Then, the `extractTimetable` function synchronizes data from the three signals to its row times. the function fills in missing values for the row times where `Sine` and `Cosine` do not provide data.

```
TT2 = extractTimetable(ds)
```

```
TT2=175x3 timetable
      Time      Sine      Cosine      Tangent
      -----
0 sec          0          1          0
0.05 sec      NaN          NaN      0.050042
0.1 sec      0.099833      0.995      0.10033
0.15 sec      NaN          NaN      0.15114
0.2 sec      0.19867      0.98007      0.20271
0.25 sec      NaN          NaN      0.25534
0.3 sec      0.29552      0.95534      0.30934
0.35 sec      NaN          NaN      0.36503
0.4 sec      0.38942      0.92106      0.42279
0.45 sec      NaN          NaN      0.48306
0.5 sec      0.47943      0.87758      0.5463
0.55 sec      NaN          NaN      0.61311
0.6 sec      0.56464      0.82534      0.68414
0.65 sec      NaN          NaN      0.7602
0.7 sec      0.64422      0.76484      0.84229
0.75 sec      NaN          NaN      0.9316
      :
```

Return Timetables for Each Sample Time and Synchronize Them

Extract data from signals that have time vectors with different sample times. To avoid returning a timetable that contains NaNs, return the data in a cell array of timetables. Then, synchronize the output timetables by using linear interpolation to fill gaps in the data.

Create a `Dataset` object that has three elements. The first two elements have the same time vector and sample time. The third element has a time vector with a different sample time.

```
Time1 = 0.1*(0:99)';
ds = Simulink.SimulationData.Dataset;

element1 = Simulink.SimulationData.Signal;
element1.Name = "Sine";
element1.Values = timeseries(sin(Time1),Time1);
ds = addElement(ds,element1);

element2 = Simulink.SimulationData.Signal;
element2.Name = "Cosine";
element2.Values = timeseries(cos(Time1),Time1);
ds = addElement(ds,element2);

Time2 = 0.05*(0:149)';
```



```

element3 = Simulink.SimulationData.Signal;
element3.Name = "Tangent";
element3.Values = timeseries(tan(Time2),Time2);
ds = addElement(ds,element3)

ds =
Simulink.SimulationData.Dataset '' with 3 elements

```

| | | Name | BlockPath |
|---|--------------|---------|-----------|
| 1 | [1x1 Signal] | Sine | '' |
| 2 | [1x1 Signal] | Cosine | '' |
| 3 | [1x1 Signal] | Tangent | '' |

- Use braces { } to access, modify, or add elements using index.

Extract data from the signals into timetables. To avoid NaNs in the output, extract signals by sample time.

```
TT = extractTimetable(ds,OutputFormat="cell-by-sampletime")
```

```
TT=1x2 cell array
    {150x1 timetable}    {100x2 timetable}
```

Display the first timetable. The timetable contains the data from ds{3} and has a sample time of 0.05 seconds.

```
TT{1}
```

```
ans=150x1 timetable
    Time    Tangent
    -----
    0 sec    0
    0.05 sec 0.050042
    0.1 sec  0.10033
    0.15 sec 0.15114
    0.2 sec  0.20271
    0.25 sec 0.25534
    0.3 sec  0.30934
    0.35 sec 0.36503
    0.4 sec  0.42279
    0.45 sec 0.48306
    0.5 sec  0.5463
    0.55 sec 0.61311
    0.6 sec  0.68414
    0.65 sec 0.7602
    0.7 sec  0.84229
    0.75 sec 0.9316
    :
```

Display the second timetable. The variables from the second timetable contain the data from ds{1} and ds{2} because those two elements of ds have the same sample time, 0.1 seconds.

```
TT{2}
```

```
ans=100x2 timetable
    Time      Sine      Cosine
    _____  _____  _____
    0 sec      0          1
    0.1 sec    0.099833   0.995
    0.2 sec    0.19867   0.98007
    0.3 sec    0.29552   0.95534
    0.4 sec    0.38942   0.92106
    0.5 sec    0.47943   0.87758
    0.6 sec    0.56464   0.82534
    0.7 sec    0.64422   0.76484
    0.8 sec    0.71736   0.69671
    0.9 sec    0.78333   0.62161
    1 sec      0.84147   0.5403
    1.1 sec    0.89121   0.4536
    1.2 sec    0.93204   0.36236
    1.3 sec    0.96356   0.2675
    1.4 sec    0.98545   0.16997
    1.5 sec    0.99749   0.070737
    ⋮
```

Combine the two timetables in TT into one timetable by using the timetable synchronize method. To avoid filling gaps with NaNs, use linear interpolation as the fill method.

```
combinedTT = synchronize(TT{2},TT{1}, "union", "linear")
```

```
combinedTT=175x3 timetable
    Time      Sine      Cosine      Tangent
    _____  _____  _____  _____
    0 sec      0          1          0
    0.05 sec   0.049917   0.9975   0.050042
    0.1 sec    0.099833   0.995    0.10033
    0.15 sec   0.14925   0.98754   0.15114
    0.2 sec    0.19867   0.98007   0.20271
    0.25 sec   0.24709   0.9677    0.25534
    0.3 sec    0.29552   0.95534   0.30934
    0.35 sec   0.34247   0.9382    0.36503
    0.4 sec    0.38942   0.92106   0.42279
    0.45 sec   0.43442   0.89932   0.48306
    0.5 sec    0.47943   0.87758   0.5463
    0.55 sec   0.52203   0.85146   0.61311
    0.6 sec    0.56464   0.82534   0.68414
    0.65 sec   0.60443   0.79509   0.7602
    0.7 sec    0.64422   0.76484   0.84229
    0.75 sec   0.68079   0.73077   0.9316
    ⋮
```

Dataset with Timetable and timeseries Objects

A Dataset object can have some elements that contain timetables and other elements that contain timeseries objects. The extractTimetable function extracts data from both sets of elements and returns all data in one timetable.

Create a Dataset object with one element that has a timetable.

```
ds = Simulink.SimulationData.Dataset;
element1 = Simulink.SimulationData.Signal;
element1.Name = "TrigFuncs";
element1.Values = timetable(seconds(0:99)',sin(0:99)',cos(0:99)',...
    VariableNames=["Sine","Cosine"])
```

```
element1 =
  Simulink.SimulationData.Signal
  Package: Simulink.SimulationData

  Properties:
    Name: 'TrigFuncs'
    PropagatedName: ''
    BlockPath: [1x1 Simulink.SimulationData.BlockPath]
    PortType: 'inport'
    PortIndex: 1
    Values: [100x2 timetable]
```

Methods, Superclasses

```
ds = addElement(ds,element1);
```

Add another element that has a timeseries object.

```
element2 = Simulink.SimulationData.Signal;
element2.Name = "Tangent";
element2.Values = timeseries(tan(0:99),0:99)
```

```
element2 =
  Simulink.SimulationData.Signal
  Package: Simulink.SimulationData

  Properties:
    Name: 'Tangent'
    PropagatedName: ''
    BlockPath: [1x1 Simulink.SimulationData.BlockPath]
    PortType: 'inport'
    PortIndex: 1
    Values: [1x1 timeseries]
```

Methods, Superclasses

```
ds = addElement(ds,element2);
```

Extract all the data and return one timetable.

```
TT = extractTimetable(ds)
```

```
TT=100x3 timetable
    Time    TrigFuncs.Sine    TrigFuncs.Cosine    Tangent
    -----
    0 sec           0                1                0
    1 sec    0.84147            0.5403            1.5574
    2 sec    0.9093           -0.41615         -2.185
```

| | | | |
|--------|----------|-----------|----------|
| 3 sec | 0.14112 | -0.98999 | -0.14255 |
| 4 sec | -0.7568 | -0.65364 | 1.1578 |
| 5 sec | -0.95892 | 0.28366 | -3.3805 |
| 6 sec | -0.27942 | 0.96017 | -0.29101 |
| 7 sec | 0.65699 | 0.7539 | 0.87145 |
| 8 sec | 0.98936 | -0.1455 | -6.7997 |
| 9 sec | 0.41212 | -0.91113 | -0.45232 |
| 10 sec | -0.54402 | -0.83907 | 0.64836 |
| 11 sec | -0.99999 | 0.0044257 | -225.95 |
| 12 sec | -0.53657 | 0.84385 | -0.63586 |
| 13 sec | 0.42017 | 0.90745 | 0.46302 |
| 14 sec | 0.99061 | 0.13674 | 7.2446 |
| 15 sec | 0.65029 | -0.75969 | -0.85599 |
| : | | | |

Add another element that has a `timeseries` object with a different sample time. When you extract the timetable, it has many NaN values filled in.

```
element3 = Simulink.SimulationData.Signal;
element3.Name = "Mini-Tangent";
element3.Values = timeseries(tan(0.5*(0:99)),0.5*(0:99));
ds = addElement(ds,element3);
TT = extractTimetable(ds)
```

TT=150x4 timetable

| Time | TrigFuncs.Sine | TrigFuncs.Cosine | Tangent | Mini-Tangent |
|---------|----------------|------------------|----------|--------------|
| 0 sec | 0 | 1 | 0 | 0 |
| 0.5 sec | NaN | NaN | NaN | 0.5463 |
| 1 sec | 0.84147 | 0.5403 | 1.5574 | 1.5574 |
| 1.5 sec | NaN | NaN | NaN | 14.101 |
| 2 sec | 0.9093 | -0.41615 | -2.185 | -2.185 |
| 2.5 sec | NaN | NaN | NaN | -0.74702 |
| 3 sec | 0.14112 | -0.98999 | -0.14255 | -0.14255 |
| 3.5 sec | NaN | NaN | NaN | 0.37459 |
| 4 sec | -0.7568 | -0.65364 | 1.1578 | 1.1578 |
| 4.5 sec | NaN | NaN | NaN | 4.6373 |
| 5 sec | -0.95892 | 0.28366 | -3.3805 | -3.3805 |
| 5.5 sec | NaN | NaN | NaN | -0.99558 |
| 6 sec | -0.27942 | 0.96017 | -0.29101 | -0.29101 |
| 6.5 sec | NaN | NaN | NaN | 0.22028 |
| 7 sec | 0.65699 | 0.7539 | 0.87145 | 0.87145 |
| 7.5 sec | NaN | NaN | NaN | 2.706 |
| : | | | | |

To extract all data from elements with a one-second sample time, you must use different name-value arguments because one element has a timetable and the others have `timeseries` objects.

- To extract data from timetables with a one-second sample time, use the `TimeStep` argument. Specify the sample time as a duration value.
- To extract data from `timeseries` objects with a one-second sample time, use the `SampleTime` argument. Specify the sample time as a numeric value.

```
TT = extractTimetable(ds,TimeStep=seconds(1),SampleTime=1)
```

```

TT=100×3 timetable
  Time      TrigFuncs.Sine      TrigFuncs.Cosine      Tangent
  -----
  0 sec      0                          1                      0
  1 sec      0.84147                    0.5403                 1.5574
  2 sec      0.9093                     -0.41615               -2.185
  3 sec      0.14112                    -0.98999               -0.14255
  4 sec      -0.7568                    -0.65364               1.1578
  5 sec      -0.95892                   0.28366                -3.3805
  6 sec      -0.27942                   0.96017                -0.29101
  7 sec      0.65699                    0.7539                 0.87145
  8 sec      0.98936                    -0.1455                -6.7997
  9 sec      0.41212                    -0.91113               -0.45232
  10 sec     -0.54402                   -0.83907                0.64836
  11 sec     -0.99999                    0.0044257              -225.95
  12 sec     -0.53657                    0.84385                -0.63586
  13 sec     0.42017                    0.90745                 0.46302
  14 sec     0.99061                    0.13674                 7.2446
  15 sec     0.65029                    -0.75969                -0.85599
  :

```

If you use only the `SampleTime` argument, then you extract data only from elements that have a `timeseries` object. Similarly, if you specify only `TimeStep`, you extract data only from elements that have a timetable.

```
TT = extractTimetable(ds,SampleTime=1)
```

```

TT=100×1 timetable
  Time      Tangent
  -----
  0 sec      0
  1 sec      1.5574
  2 sec      -2.185
  3 sec      -0.14255
  4 sec      1.1578
  5 sec      -3.3805
  6 sec      -0.29101
  7 sec      0.87145
  8 sec      -6.7997
  9 sec      -0.45232
  10 sec     0.64836
  11 sec     -225.95
  12 sec     -0.63586
  13 sec     0.46302
  14 sec     7.2446
  15 sec     -0.85599
  :

```

Match Template to Data

Create a `Dataset` object that has elements with different time vectors.

```

Time1 = 0.1*(0:99)';
ds = Simulink.SimulationData.Dataset;

element1 = Simulink.SimulationData.Signal;
element1.Name = "Sine";
element1.Values = timeseries(sin(Time1),Time1);
ds = addElement(ds,element1);

Time2 = 0.05*(0:99)';
element2 = Simulink.SimulationData.Signal;
element2.Name = "Cosine";
element2.Values = timeseries(cos(Time2),Time2);
ds = addElement(ds,element2);

Time3 = (0:99)';
element3 = Simulink.SimulationData.Signal;
element3.Name = "Tangent";
element3.Values = timeseries(tan(Time3),Time3);
ds = addElement(ds,element3)

ds =
Simulink.SimulationData.Dataset '' with 3 elements

```

| | | Name | BlockPath |
|---|--------------|---------|-----------|
| 1 | [1x1 Signal] | Sine | '' |
| 2 | [1x1 Signal] | Cosine | '' |
| 3 | [1x1 Signal] | Tangent | '' |

- Use braces { } to access, modify, or add elements using index.

If you have data stored in another `Dataset` object, then you can use one of its elements as a template. You can extract data from elements of `ds` whose time properties match the time properties of the template.

Create a second `Dataset` object with one element.

```

ds2 = Simulink.SimulationData.Dataset;
templ = Simulink.SimulationData.Signal;
templ.Name = "Template";
templ.Values = timeseries(randi(100,1),(0:99)');
ds2 = addElement(ds2,templ)

ds2 =
Simulink.SimulationData.Dataset '' with 1 element

```

| | | Name | BlockPath |
|---|--------------|----------|-----------|
| 1 | [1x1 Signal] | Template | '' |

- Use braces { } to access, modify, or add elements using index.

Return data from the elements of `ds` that match the time properties of `ds2{1}`. The template matches the time properties of the third element of `ds`, named "Tangent".

```

TT = extractTimetable(ds,Template=ds2{1})

```

```

TT=100x1 timetable
    Time      Tangent
    _____
    0 sec      0
    1 sec      1.5574
    2 sec      -2.185
    3 sec      -0.14255
    4 sec      1.1578
    5 sec      -3.3805
    6 sec      -0.29101
    7 sec      0.87145
    8 sec      -6.7997
    9 sec      -0.45232
    10 sec     0.64836
    11 sec     -225.95
    12 sec     -0.63586
    13 sec     0.46302
    14 sec     7.2446
    15 sec     -0.85599
    :

```

Input Arguments

ds — Object that contains time series data

Simulink.SimulationData.Dataset object | Simulink.SimulationData.Signal object

Object that contains time series data, specified as a Simulink.SimulationData.Dataset or Simulink.SimulationData.Signal object.

Name-Value Arguments

Specify optional pairs of arguments as Name1=Value1, . . . , NameN=ValueN, where Name is the argument name and Value is the corresponding value. Name-value arguments must appear after other arguments, but the order of the pairs does not matter.

Example: TT = extractTimetable(ds,OutputFormat="cell-by-sampletime")

Arguments for All Inputs

OutputFormat — Output format and grouping

"timetable" (default) | "cell-by-signal" | "cell-by-sampletime" | "cell-by-timestep"

Output format and grouping of time series data, specified as one of the values described in the table.

| Value | Output Format |
|------------------|--|
| "timetable" | Timetable that contains the synchronized union of all signal data, padded with missing values. |
| "cell-by-signal" | Cell array that contains a timetable for each signal found in the input. |

| Value | Output Format |
|----------------------|---|
| "cell-by-sampletime" | Cell array that contains a timetable for each sample time found in the input. |
| "cell-by-timestep" | |

Example: `TT = extractTimetable(ds,OutputFormat="cell-by-signal")` returns a cell array where each element is a timetable that contains data from a corresponding element of `ds`.

SignalNames — Names of signals

string array | pattern object

Names of signals to extract the timetable, specified as a string array or a `pattern` object.

Example: `TT = extractTimetable(ds,SignalNames=["Sensor1","Sensor2"])` extracts data from signals named "Sensor1" or "Sensor2".

Example: `TT = extractTimetable(ds,SignalNames="Sensor" + wildcardPattern)` extracts data from signals whose names start with "Sensor".

Template — Template to match to time properties of input

timeseries object | timetable | `Simulink.SimulationData.Signal` object | name of signal in `ds`

Template to match to time properties of input signals, specified as a `timeseries` object, timetable, `Simulink.SimulationData.Signal` object, or the name of a signal in `ds`.

- If the template is or contains a `timeseries` object, then `extractTimetable` matches it only to elements of `ds` that contain `timeseries` objects.
- If the template is or contains a timetable, then `extractTimetable` matches it only to elements of `ds` that contain timetables.

Example: `TT = extractTimetable(ds,Template=ds{1})` extracts data from all elements of `ds` whose time properties match the time properties of the first element of `ds`.

Arguments for Inputs with Signals That Contain timeseries Objects

SampleTime — Sample time

one or more positive numeric values

Sample time, specified as one or more positive numeric values. When you specify the value of `SampleTime`, this function extracts data from all signals in `ds` that have `timeseries` objects whose time vectors have the specified sample time. The sample time is interpreted as a time interval in seconds.

If you provide multiple sample times in a numeric array, then the output is a timetable synchronized to the union of all signals that have `timeseries` objects with any of the specified sample times, unless you also specify the value of `OutputFormat`.

Example: `TT = extractTimetable(ds,SampleTime=0.5)` extracts data from any signals that have `timeseries` objects where the sample time is 0.5 seconds and returns the data in one timetable.

Example: `TT = extractTimetable(ds,SampleTime=[0.5,1.0],OutputFormat="cell-by-sampletime")` extracts data from signals that have `timeseries` objects where the sample time is either 0.5 or 1.0 seconds and returns a cell array that contains two timetables.

TimeVector – Time vector

datetime vector | duration vector

Time vector, specified as a `datetime` vector or `duration` vector.

The output timetable contains data from all signals in `ds` that have `timeseries` objects whose time vector matches the value of `TimeVector`.

Example: `TT = extractTimetable(ds,TimeVector=seconds(0:99))` extracts data from signals that have `timeseries` objects whose time vector is an array spanning 0–99 seconds with a sample time of one second.

Arguments for Inputs with Signals That Contain Timetables**SampleRate – Sample rate**

one or more positive numeric values

Sample rate, specified as one or more positive numeric values. When you specify the value of `SampleRate`, this function extracts data from all signals in `ds` that have timetables with the specified sample rate. The sample rate is interpreted as a rate in Hertz (Hz).

If you provide multiple sample rates in a numeric array, then the output is a timetable synchronized to the union of all signals that have timetables with any of the specified sample rates, unless you also specify the value of `OutputFormat`.

You can use this argument in combination with the `StartTime` name-value argument.

Example: `TT = extractTimetable(ds,SampleRate=100)` extracts data from any signals that have timetables where the sample rate is 100 Hz and returns the data in one timetable.

Example: `TT = extractTimetable(ds,SampleRate=[100,200],OutputFormat="cell-by-sampletime")` extracts data from signals that have timetables where the sample rate is either 100 or 200 Hz and returns a cell array that contains two timetables.

Example: `TT = extractTimetable(ds,SampleRate=100,StartTime=seconds(25))` extracts data from any signals that have timetables where the sample rate is 100 Hz and the signal starts at 25 seconds.

TimeStep – Time step

duration array

Time step, specified as a `duration` array. When you specify the value of `TimeStep`, this function extracts the timetable that contains data from all signals in `ds` that have timetables with the specified time step.

If you provide multiple time steps in an array, then the output is a timetable synchronized to the union of all signals that have timetables with any of the specified time steps, unless you also specify the value of `OutputFormat`.

You can use this argument in combination with the `StartTime` name-value argument.

Example: `TT = extractTimetable(ds,TimeStep=seconds(0.5))` extracts data from any signals that have timetables where the time step is 0.5 seconds and returns the data in one timetable.

Example: `TT = extractTimetable(ds,TimeStep=seconds([0.5,1.0]),OutputFormat="cell-by-sampletime")` extracts data from signals that have timetables where the time step is either 0.5 or 1.0 seconds and returns a cell array that contains two timetables.

Example: `TT = extractTimetable(ds,TimeStep=seconds(0.5),StartTime=seconds(10))` extracts data from any signals that have timetables where the time step is 0.5 seconds and the signal starts at 10 seconds.

RowTimes — Time vector

`datetime vector` | `duration vector`

Time vector, specified as a `datetime` vector or `duration` vector.

The output timetable contains data from all the signals in `ds` that have timetables whose row times are in a time vector that matches the vector specified by `RowTimes`.

Example: `TT = extractTimetable(ds,RowTimes=seconds(0:99))` extracts data from any signals that have timetables whose time vector is an array spanning 0–99 seconds with a time step of one second.

StartTime — Start time

`datetime scalar` | `duration scalar`

Start time, specified as a `datetime` scalar or `duration` scalar.

The output timetable contains data from all the signals in `ds` that have timetables whose row times start with a value matches the value specified by `StartTime`.

You can use `StartTime` in combination with either the `SampleRate` or `TimeStep` name-value arguments.

Example: `TT = extractTimetable(ds,StartTime=seconds(50))` extracts data from any signals that have timetables where the signal starts at 50 seconds.

Example: `TT = extractTimetable(ds,SampleRate=100,StartTime=seconds(25))` extracts data from any signals that have timetables where the sample rate is 100 Hz and the signal starts at 25 seconds.

Example: `TT = extractTimetable(ds,TimeStep=seconds(0.5),StartTime=seconds(10))` extracts data from any signals that have timetables where the time step is 0.5 seconds and the signal starts at 10 seconds.

See Also

`timetable` | `timeseries` | `Simulink.SimulationData.Dataset` | `Simulink.SimulationData.Signal`

Topics

“Create Timetables”
“Resample and Aggregate Data in Timetable”
“Combine Timetables and Synchronize Their Data”
“Select Times in Timetable”

Introduced in R2021b

get

Get element or collection of elements from dataset

Syntax

```
element = get(dataset,index)
element = get(dataset,name)
element = get(dataset,{name})
```

Description

`element = get(dataset,index)` returns the element corresponding to the `index`. The `getElement` method uses the same syntax and behavior as the `get` method.

`element = get(dataset,name)` returns the element whose name matches `name`. When `name` is in a cell array, return the index of the element whose name matches `name`.

`element = get(dataset,{name})` returns a single element if only one element name matches, a `SimulationData.Dataset` if multiple elements with this name exist.

If you use **Log Dataset data to file** to create the MAT-file, use `getAsDatastore` for fast access to the data.

Input Arguments

dataset — Dataset

`SimulationData.Dataset` object

The data set from which to get the element.

index — Index value of element to get

scalar numeric

Index value of element to get. The index reflects the index value of a data set element.

name — Name for data set element

character array | cell array

Name for a data set element, specified as:

- A character array reflecting the name of the data set element
- A cell array containing one character vector. To return a `SimulationData.Dataset` object that can contain one element, use this format. Consider this form when writing scripts.

Output Arguments

element — Element

element | `SimulationData.Dataset` object | empty object

The element that the `get` method finds.

- If `index` is the first argument after the data set, the method returns the element at the `index`.
- If `name` is the first argument after the data set:
 - If the method finds one element, it returns the element.
 - If the method finds more than one element, return a Dataset that contains the elements.
 - If the method does not find an element, it returns an empty object.

Examples

Access Dataset Elements

Access `Simulink.SimulationData.Dataset` elements in the top model of the `ex_bus_logging` model. The signal logging dataset is `topOut`.

```
open_system(docpath(fullfile(docroot, 'toolbox', 'simulink', ...
'examples', 'ex_bus_logging')));
open_system(docpath(fullfile(docroot, 'toolbox', 'simulink', ...
'examples', 'ex_mdhref_counter_bus')));
sim('ex_bus_logging')
topOut
```

`topOut =`

```
Simulink.SimulationData.Dataset
Package: Simulink.SimulationData
```

```
Characteristics:
    Name: 'topOut'
  Total Elements: 4
```

```
Elements:
  1: 'COUNTERBUS'
  2: 'OUTPUTBUS'
  3: 'INCREMENTBUS'
  4: 'inner_bus'
```

```
-Use get or getElement to access elements by index, name or
  block path.
-Use addElement or setElement to add or modify elements.
```

```
Methods, Superclasses
```

Access Dataset Elements with Index

Access the element at `index` if the first argument is a numeric value.

```
e1 = logout.get(1);
```

Access Dataset Elements with Characters

Access the element whose name matches `name`.

```
el = logout.get('name');
```

Access Dataset Elements with Cell Array

Return a dataset if the first argument is a cell array with a character vector as the first element.

```
ds = logout.get({'my_name'});
```

Alternatives

You can use curly braces to streamline indexing syntax to get an element in a dataset, instead of using `get` or `getElement`. The index must be a scalar that is not greater than the number of elements in the variable. For example, get the second element of the `logout` dataset.

```
logout{2}
```

Also, you can use the `find` method to get an element or collection of elements from a dataset.

See Also

`Simulink.SimulationData.BlockPath` | `Simulink.SimulationData.Signal` |
`Simulink.SimulationData.DataStoreMemory` | `addElement` | `concat` | `find` |
`getElementNames` | `numElements` | `setElement` | `Simulink.SimulationData.Dataset`

Topics

“Migrate Scripts That Use Legacy ModelDataLogs API”
“Export Signal Data Using Signal Logging”
“Log Data Stores”
“Convert Logged Data to Dataset Format”
“Migrate Scripts That Use Legacy ModelDataLogs API”

Introduced in R2011a

getElementNames

Return names of all elements in dataset

Syntax

```
element_list = getElementNames(dataset)
```

Description

`element_list = getElementNames(dataset)` returns the names of all of the elements in the `Simulink.SimulationData.Dataset` object.

Input Arguments

dataset — Data set

`SimulationData.Dataset` object

The data set from which to the element name.

Output Arguments

element_list — Data set

cell array

Data set, returned as a cell array of the character vectors containing names of all of the elements of the dataset.

Examples

Return Names of Elements

Return the names of the elements for the `topOut` data set (the signal logging data).

```
open_system(docpath(fullfile(docroot,'toolbox','simulink',...  
'examples','ex_bus_logging')));  
open_system(docpath(fullfile(docroot,'toolbox','simulink',...  
'examples','ex mdlref_counter_bus')));  
sim('ex_bus_logging')  
el_names = topOut.getElementNames
```

```
el_names =  
  
    'COUNTERBUS'  
    'OUTPUTBUS'
```

```
'INCREMENTBUS'  
'inner_bus'
```

See Also

Simulink.SimulationData.BlockPath | Simulink.SimulationData.Signal |
Simulink.SimulationData.DataStoreMemory | addElement | concat | find | get |
numElements | setElement | Simulink.SimulationData.Dataset

Topics

“Migrate Scripts That Use Legacy ModelDataLogs API”
“Export Signal Data Using Signal Logging”
“Log Data Stores”
“Convert Logged Data to Dataset Format”
“Migrate Scripts That Use Legacy ModelDataLogs API”

Introduced in R2011a

find

Get element or collection of elements from dataset

Syntax

```
[datasetOut,retIndex]=find(datasetIn,Name,Value,...)
```

```
[datasetOut,retIndex]=find(datasetIn,Name,Value,'-logicaloperator',...Name,Value,...)
```

```
[datasetOut,retIndex]=find(datasetIn,'-regexp',Name,Value,...)
```

Description

`[datasetOut,retIndex]=find(datasetIn,Name,Value,...)` returns a `Simulink.SimulationData.Dataset` object and indices of the elements whose property values match the specified property names and values. Specify optional comma-separated pairs of `Name,Value` properties. `Name` is the property name and `Value` is the corresponding value. `Name` must appear inside single quotes (' '). You can specify several name-value pair properties in any order as `Name1,Value1,...,NameN,ValueN`.

`[datasetOut,retIndex]=find(datasetIn,Name,Value,'-logicaloperator',...Name,Value,...)` applies the logical operator to the matching property value. You can combine multiple logical operators. Logical operator can be one of:

- -or
- -and

If you do not specify an operation, the method assumes -and.

`[datasetOut,retIndex]=find(datasetIn,'-regexp',Name,Value,...)` matches elements using regular expressions as if the value of the property is passed to the `regexp` function as:

```
regexp(element.Name,Value)
```

The method applies regular expression matching to the name-value pairs that appear after -regexp. If there is no -regexp, the method matches elements as if the value of the property is passed as:

```
isequal(element.Name,Value)
```

For more information on -regexp, see “-regexp With Multiple Block Paths” on page 5-876.

-regexp With Multiple Block Paths

-regexp works with properties of type char. To specify multiple block paths, you can use `Simulink.SimulationData.BlockPath` and `Simulink.BlockPath`. For example, when a signal is logged in a referenced model, you can use `Simulink.SimulationData.BlockPath` to specify multiple block paths.

The method returns elements that contain a **BlockPath** property where one or more of the individual block paths match the specified `Value` path when you use:

- - regexp with the **BlockPath** Name property.
- Value as a character vector or scalar object of type `Simulink.SimulationData.BlockPath` with one block path

Input Arguments

datasetIn — `SimulationData.Dataset`

`SimulationData.Dataset` object

`SimulationData.Dataset` object in which to search for matching elements.

Name — Name of property

character vector

Name of property to find in the element.

Value — Value of property

character vector | double | `Simulink.SimulationData.BlockPath`

Value of property to find in the element.

Output Arguments

datasetOut — `SimulationData.Dataset` data set

`SimulationData.Dataset`

`SimulationData.Dataset` object that contains the elements that match the specified criteria. If there is no matching `SimulationData.Dataset` object, the returned `SimulationData.Dataset` object contains no elements.

retIndex — Indices

vector

Indices of the elements `datasetIn` that match the specified criteria.

Examples

Find Block Path

Find a specific block path (specified by character vector) and port index.

```
dsOut = find(dsIn, 'BlockPath', 'vdp/x1', 'PortIndex', 1)
```

Find Elements

Find elements that have either name or propagated name as `InValve`.

```
dsOut = find(dsIn, 'Name', 'InValve', '-or', 'PropagatedName', 'InValve')
dsOut = find(dsIn, '-regex', 'Name', 'In*', '-or', ...
             '-regex', 'PropagatedName', 'In*')
```

Find and Change Element

Find and replace all elements containing `specified_name` with a `new_name`.

```
[dsOut,idxInDs] = find(ds, 'specified_name');
for idx=1: length(idxInDs)
    % process each element
    elm = get(dsOut, idx);
    elm.Name= 'New_Name'
    dsIn = setElement(dsIn, idxInDs(idx), elm);
end
```

Find Signals in subSys Using -regexp

Find all signals logged in a `subSys` using `-regexp`.

```
dsOut = find(dsIn, '-regexp', 'BlockPath', 'mdl/subSys/.*')
```

Find Signals in Referenced Model

Find all signals logged in the Model block.

```
dsOut = find(dsIn, '-regexp', 'BlockPath', 'refmdl/ModelBlk')
```

Alternative

You can use curly braces to streamline indexing syntax to get an element in a dataset, instead of using `find`. The index must be a scalar that is not greater than the number of elements in the variable. For example, get the second element of the `logout` dataset.

```
logout{2}
```

Also, you can use the `get` method to get an element or collection of elements from a dataset.

See Also

`Simulink.SimulationData.DatasetRef.getDatasetVariableNames` |
`Simulink.SimulationData.BlockPath` | `Simulink.SimulationData.Signal` |
`Simulink.SimulationData.DataStoreMemory` | `addElement` | `concat` | `get` |
`getElementNames` | `numElements` | `setElement` | `Simulink.SimulationData.Dataset` |
`regexp` | `findobj`

Topics

“Migrate Scripts That Use Legacy ModelDataLogs API”
 “Export Signal Data Using Signal Logging”
 “Log Data Stores”
 “Convert Logged Data to Dataset Format”

“Migrate Scripts That Use Legacy ModelDataLogs API”
“Load Big Data for Simulations”

Introduced in R2015b

numElements

Get number of elements in data set

Syntax

```
length = numElements(dataset)
```

Description

`length = numElements(dataset)` gets the number of elements in the top-level dataset. To get the number of elements of a nested data set, use `numElements` with the nested data set.

Input Arguments

dataset — Data set

`SimulationData.Dataset` object

The data set from which to get the number of elements.

Output Arguments

length — Number of elements

double

Number of elements, returned as a double.

Examples

Get Number of Elements

Get the number of elements in the signal logging data set for the `ex_bus_logging`.

```
length = topOut.numElements()
```

See Also

`Simulink.SimulationData.BlockPath` | `Simulink.SimulationData.Signal` | `Simulink.SimulationData.DataStoreMemory` | `addElement` | `concat` | `find` | `get` | `getElementNames` | `setElement` | `Simulink.SimulationData.Dataset`

Topics

“Migrate Scripts That Use Legacy ModelDataLogs API”

“Export Signal Data Using Signal Logging”

“Log Data Stores”

“Convert Logged Data to Dataset Format”

“Migrate Scripts That Use Legacy ModelDataLogs API”

Introduced in R2011a

plot

Plot data in the Simulation Data Inspector

Syntax

```
plot(ds)
plot(ds,viewer)
runObj = plot(ds)
```

Description

`plot(ds)` plots the data in the `Simulink.SimulationData.Dataset` or `Simulink.SimulationData.DatasetRef` in the **Simulation Data Inspector**. When there are eight signals or fewer in the `Dataset` or `DatasetRef` object, the Simulation Data Inspector plot layout changes to 1-by-n, where n is equal to the number of signals, and plots one signal on each subplot. When the `Dataset` or `DatasetRef` object contains more than eight signals, the Simulation Data Inspector plot layout changes to 1-by-1 and plots the first signal.

`plot(ds,viewer)` displays the plot in the Simulation Data Inspector or Signal Preview window, according to the value specified for `viewer`.

`runObj = plot(ds)` plots the data in the `Dataset` object and returns the corresponding `Simulink.sdi.Run` object.

Input Arguments

ds — Dataset or DatasetRef object with data to plot

`Simulink.SimulationData.Dataset` object | `Simulink.SimulationData.DatasetRef` object

`Dataset` or `DatasetRef` object that contains the data to plot.

viewer — Viewer to use to plot data

'datainspector' (default) | 'preview'

Viewer used to plot the data, specified as 'datainspector' or 'preview'. When you do not specify the viewer input, the plot function plots data in the Simulation Data Inspector.

- 'datainspector' — Plot data in the **Simulation Data Inspector**.
- 'viewer' — Plot data in the Signal Preview window. For more information, see “Preview Signal Data”.

Output Arguments

runObj — `Simulink.sdi.Run` object corresponding to the plotted data

`Simulink.sdi.Run` object

`Simulink.sdi.Run` object corresponding to the plotted data. When you view data in a Signal Preview window, the plot function returns empty (`[]`).

Examples

Plot a Data Set

Create a `timeseries` object `ts` and add elements to plot in the Simulation Data Inspector.

```
% Create a timeseries object
ts = timeseries([0;20],[0;10]);
% Create a SimulationData.Dataset
ds = Simulink.SimulationData.Dataset();
% Place timeseries object in dataset
ds = ds.addElement(ts,'ts');
% Plot the element
plot(ds);
```

Compatibility Considerations

'sdi' input is not recommended

Not recommended starting in R2019b

Starting in R2019b, specify the `viewer` argument for the `plot` function as `'datainspector'` to view plotted data in the Simulation Data Inspector.

See Also

`Simulink.SimulationData.Dataset | addElement`

Topics

“View and Inspect Signal Data”

“Migrate Scripts That Use Legacy ModelDataLogs API”

“Export Signal Data Using Signal Logging”

“Log Data Stores”

“Convert Logged Data to Dataset Format”

“Migrate Scripts That Use Legacy ModelDataLogs API”

“Load Big Data for Simulations”

Introduced in R2016b

addElement

Change element stored at specified index

Syntax

```
dataset = setElement(dataset,index,... element)
dataset = setElement(index,element, name)
```

Description

`dataset = setElement(dataset,index,... element)` changes the element stored at the specified index, for an existing index. If `index` is one greater than the number of elements in the data set, the function adds the element at the end of the data set.

`dataset = setElement(index,element, name)` changes the element stored at the specified index and gives it the name that you specify. You can use `name` to identify an element that does not have a name. If the signal already has a name, the element instead uses the name you specify by using the `name` argument.

Input Arguments

dataset — Data set

`SimulationData.Dataset` object

The data set for which to set the element.

index — Index

scalar

Index for the added element, specified as a scalar numeric value. The value must be between 1 and the number of elements plus 1.

element — Element to replace existing element

`Simulink.SimulationData.Signal` object | `Simulink.SimulationData.DataStoreMemory` object

Element to replace existing element or to add to the data set, specified as a `Simulink.SimulationData.Signal` object or `Simulink.SimulationData.DataStoreMemory` object.

name — Element name

character vector

Element name, returned as a character vector.

Output Arguments

dataset — Data set

character vector

Data set in which you change or add an element, specified as a character vector.

Examples

Set Element Name

Set element name.

```
ds = Simulink.SimulationData.Dataset
element1 = Simulink.SimulationData.Signal
element1.Name = 'A'
ds = ds.addElement(element1)
element2 = Simulink.SimulationData.Signal
element2.Name = 'B'
elementNew = Simulink.SimulationData.Signal
ds = ds.setElement(2,elementNew,'B1')
ds
```

ds =

```
Simulink.SimulationData.Dataset
Package: Simulink.SimulationData
```

```
Characteristics:
      Name: 'topOut'
  Total Elements: 2
```

```
Elements:
  1: 'A'
  2: 'B1'
```

Use `getElement` to access elements by index, name or block path.

Methods, Superclasses

Alternative

You can use curly braces to streamline indexing syntax to change an element in a dataset, instead of using `setElement`. The index must be a scalar that is not greater than the number of elements in the variable. For example, change the name of second element of the `logout` dataset.

```
logout{2}.Name = 'secondSignal'
```

See Also

`Simulink.SimulationData.BlockPath` | `Simulink.SimulationData.Signal` | `Simulink.SimulationData.DataStoreMemory` | `addElement` | `concat` | `find` | `get` | `getElementNames` | `numElements` | `Simulink.SimulationData.Dataset`

Topics

“Migrate Scripts That Use Legacy ModelDataLogs API”

“Export Signal Data Using Signal Logging”

“Log Data Stores”

“Migrate Scripts That Use Legacy ModelDataLogs API”

Introduced in R2011a

coder.BuildConfig class

Package: coder

Build context during code generation

Description

The code generator creates an object of this class to facilitate access to the build context. The build context encapsulates the settings used by the code generator including:

- Target language
- Code generation target
- Target hardware
- Build toolchain

Use `coder.BuildConfig` methods in the methods that you write for the `coder.ExternalDependency` class.

Construction

The code generator creates objects of this class.

Methods

| | |
|--|--|
| <code>getHardwareImplementation</code> | Get handle of copy of hardware implementation object |
| <code>getStdLibInfo</code> | Get standard library information |
| <code>getTargetLang</code> | Get target code generation language |
| <code>getToolchainInfo</code> | Returns handle of copy of toolchain information object |
| <code>isCodeGenTarget</code> | Determine if build configuration represents specified target |
| <code>isMatlabHostTarget</code> | Determine if hardware implementation object target is MATLAB host computer |

Copy Semantics

Value. To learn how value classes affect copy operations, see [Copying Objects](#).

Examples

Use `coder.BuildConfig` methods to access the build context in `coder.ExternalDependency` methods

This example shows how to use `coder.BuildConfig` methods to access the build context in `coder.ExternalDependency` methods. In this example, you use:

- `coder.BuildConfig.isMatlabHostTarget` to verify that the code generation target is the MATLAB host. If the host is not MATLAB report an error.
- `coder.BuildConfig.getStdLibInfo` to get the link-time and run-time library file extensions. Use this information to update the build information.

Write a class definition file for an external library that contains the function `adder`.

```

=====
% This class abstracts the API to an external Adder library.
% It implements static methods for updating the build information
% at compile time and build time.
=====

classdef AdderAPI < coder.ExternalDependency
    %#codegen

    methods (Static)

        function bName = getDescriptiveName(~)
            bName = 'AdderAPI';
        end

        function tf = isSupportedContext(buildContext)
            if buildContext.isMatlabHostTarget()
                tf = true;
            else
                error('adder library not available for this target');
            end
        end

        function updateBuildInfo(buildInfo, buildContext)
            % Get file extensions for the current platform
            [~, linkLibExt, execLibExt, ~] = buildContext.getStdLibInfo();

            % Add file paths
            hdrFilePath = fullfile(pwd, 'codegen', 'dll', 'adder');
            buildInfo.addIncludePaths(hdrFilePath);

            % Link files
            linkFiles = strcat('adder', linkLibExt);
            linkPath = hdrFilePath;
            linkPriority = '';
            linkPrecompiled = true;
            linkLinkOnly = true;
            group = '';
            buildInfo.addLinkObjects(linkFiles, linkPath, ...
                linkPriority, linkPrecompiled, linkLinkOnly, group);

            % Non-build files for packaging
            nbFiles = 'adder';
            nbFiles = strcat(nbFiles, execLibExt);
            buildInfo.addNonBuildFiles(nbFiles, '', '');
        end

        %API for library function 'adder'
        function c = adder(a, b)
            if coder.target('MATLAB')

```

```
        % running in MATLAB, use built-in addition
        c = a + b;
    else
        % Add the required include statements to the generated function code
        coder.cinclude('adder.h');
        coder.cinclude('adder_initialize.h');
        coder.cinclude('adder_terminate.h');
        c = 0;

        % Because MATLAB Coder generated adder, use the
        % housekeeping functions before and after calling
        % adder with coder.ceval.

        coder.ceval('adder_initialize');
        c = coder.ceval('adder', a, b);
        coder.ceval('adder_terminate');
    end
end
end
end
```

See Also

`coder.target` | `coder.ExternalDependency` | `coder.HardwareImplementation`

Topics

“Develop Interface for External C/C++ Code” (MATLAB Coder)

“Build Process Customization” (MATLAB Coder)

Introduced in R2013b

coder.ExternalDependency class

Package: coder

Interface to external code

Description

`coder.ExternalDependency` is an abstract class for developing an interface between external code and MATLAB code intended for code generation. You can define classes that derive from `coder.ExternalDependency` to encapsulate the interface to external libraries, object files, and C/C++ source code. This encapsulation allows you to separate the details of the interface from your MATLAB code.

To define a class derived from `coder.ExternalDependency`, create a subclass. For example:

```
classdef myClass < coder.ExternalDependency
```

You must define all of the methods listed in “Methods” on page 5-890. These methods are static and are not compiled. The code generator invokes these methods in MATLAB after code generation is complete to configure the build for the generated code. The `RTW.BuildInfo` and `coder.BuildConfig` objects that describe the build information and build context are automatically created during the build process. The `updateBuildInfo` method provides access to these objects. For more information on build information customization, see “Build Process Customization” (MATLAB Coder).

You also define methods that call the external code. These methods are compiled. For each external function that you want to call, write a method to define the programming interface to the function. In the method, use `coder.ceval` to call the external function.

Methods

| | |
|---------------------------------|---|
| <code>getDescriptiveName</code> | Return descriptive name for external dependency |
| <code>isSupportedContext</code> | Determine if build context supports external dependency |
| <code>updateBuildInfo</code> | Update build information |

Examples

Encapsulate the Interface to an External C Dynamic Library

This example shows how to encapsulate the interface to an external C dynamic linked library using `coder.ExternalDependency`.

Write a function `adder` that returns the sum of its inputs.

```
function c = adder(a,b)
%#codegen
c = a + b;
end
```

Generate a library that contains adder.

```
codegen('adder', '-args', {-2,5}, '-config:dll', '-report')
```

Write the class definition file AdderAPI.m to encapsulate the library interface.

```
%=====
% This class abstracts the API to an external Adder library.
% It implements static methods for updating the build information
% at compile time and build time.
%=====

classdef AdderAPI < coder.ExternalDependency
    %#codegen

    methods (Static)

        function bName = getDescriptiveName(~)
            bName = 'AdderAPI';
        end

        function tf = isSupportedContext(buildContext)
            if buildContext.isMatlabHostTarget()
                tf = true;
            else
                error('adder library not available for this target');
            end
        end

        function updateBuildInfo(buildInfo, buildContext)
            % Get file extensions for the current platform
            [~, linkLibExt, execLibExt, ~] = buildContext.getStdLibInfo();

            % Add file paths
            hdrFilePath = fullfile(pwd, 'codegen', 'dll', 'adder');
            buildInfo.addIncludePaths(hdrFilePath);

            % Link files
            linkFiles = strcat('adder', linkLibExt);
            linkPath = hdrFilePath;
            linkPriority = '';
            linkPrecompiled = true;
            linkLinkOnly = true;
            group = '';
            buildInfo.addLinkObjects(linkFiles, linkPath, ...
                linkPriority, linkPrecompiled, linkLinkOnly, group);

            % Non-build files for packaging
            nbFiles = 'adder';
            nbFiles = strcat(nbFiles, execLibExt);
            buildInfo.addNonBuildFiles(nbFiles, '', '');
        end

        %API for library function 'adder'
        function c = adder(a, b)
            if coder.target('MATLAB')
                % running in MATLAB, use built-in addition
                c = a + b;
            end
        end
    end
end
```

```

else
    % Add the required include statements to the generated function code
    coder.cinclude('adder.h');
    coder.cinclude('adder_initialize.h');
    coder.cinclude('adder_terminate.h');
    c = 0;

    % Because MATLAB Coder generated adder, use the
    % housekeeping functions before and after calling
    % adder with coder.ceval.

    coder.ceval('adder_initialize');
    c = coder.ceval('adder', a, b);
    coder.ceval('adder_terminate');
end
end
end
end
end

```

Write a function `adder_main` that calls the external library function `adder`.

```

function y = adder_main(x1, x2)
    %#codegen
    y = AdderAPI.adder(x1, x2);
end

```

Generate a MEX function for `adder_main`. The MEX Function exercises the `coder.ExternalDependency` methods.

```
codegen('adder_main', '-args', {7,9}, '-report')
```

Copy the library to the current folder using the file extension for your platform. For Windows, use:

```
copyfile(fullfile(pwd, 'codegen', 'dll', 'adder', 'adder.dll'));
```

For Linux, use:

```
copyfile(fullfile(pwd, 'codegen', 'dll', 'adder', 'adder.so'));
```

Run the MEX function and verify the result.

```
adder_main_mex(2,3)
```

See Also

`coder.ceval` | `coder.cinclude` | `coder.updateBuildInfo` | `coder.BuildConfig`

Topics

“Develop Interface for External C/C++ Code” (MATLAB Coder)

“Build Process Customization” (MATLAB Coder)

“Integrate External/Custom Code” (MATLAB Coder)

Introduced in R2013b

TimeScopeConfiguration

Control Scope block appearance and behavior

Description

Scope configuration properties control the appearance and behavior of a scope block. Create a scope configuration object with `get_param`, and then change property values using the object with dot notation.

Creation

`myScopeConfiguration = get_param(gcbh, 'ScopeConfiguration')` creates a scope configuration object for the selected scope block.

Properties

Name — Title on a scope window

block name (default) | character vector | string scalar

Title on a scope window, specified as a character vector or string scalar.

NumInputPorts — Number of input ports

'1' (default) | character vector

Number of input ports on a scope block, specified as a character vector or string scalar. The maximum number of input ports is 96.

ActiveDisplay — Display for setting display-specific properties

'1' (default) | character vector

Display for setting display-specific properties, specified as a character vector or string. The number of a display corresponds to its column-wise placement index. For multi-column layouts, the displays are numbered down and then across.

Dependency

Setting this property selects the display for setting the properties `ShowGrid`, `ShowLegend`, `Title`, `PlotAsMagnitudePhase`, `YLabel`, and `YLimits`.

AxesScaling — How to scale y-axes

'Manual' (default) | 'Auto' | 'Updates'

How to scale y-axes, specified as one of these values:

- 'Manual' — Manually scale y-axes with the **Scale Y-axis Limits** button.
- 'Auto' — Scale y-axes during and after simulation.
- 'Updates' — Scale y-axes after specified number of block updates (time intervals).

Dependency

If this property is set to 'Updates', also specify the property `AxesScalingNumUpdates`

AxesScalingNumUpdates — Number of updates before scaling y-axes

'10' (default) | character vector | string scalar

Number of updates before scaling y-axes, specified as a character vector or string scalar.

Dependency

Activate this property by setting `AxesScaling` to 'Updates'.

DataLogging — Save scope data

false (default) | true

Set this property to `true` to save scope data to a variable in the MATLAB workspace.

This property does not apply to floating scopes and scope viewers.

Dependency

If this property is set to `true`, you must also specify the properties `DataLoggingVariableName` and `DataLoggingSaveFormat`.

DataLoggingVariableName — Variable name for saving scope data

'ScopeData' (default) | character vector | string scalar

Variable name for saving scope data in the MATLAB workspace, specified as a character vector or string scalar. This property does not apply to floating scopes and scope viewers.

Dependency

Activate this property by setting `DataLogging` to `true`.

DataLoggingSaveFormat — Variable format for saving scope data

'Dataset' (default) | 'Structure With Time' | 'Structure' | 'Array'

Variable format for saving scope data to the MATLAB workspace, specified as one of these values:

- 'Dataset' — Save data as a dataset object. This format does not support variable-size data, MAT-file logging, or external mode archiving. See `Simulink.SimulationData.Dataset`.
- 'StructureWithTime' — Save data as a structure with associated time information. This format does not support single- or multiport frame-based data, or multirate data.
- 'Structure' — Save data as a structure. This format does not support multirate data.
- 'Array' — Save data as an array with associated time information. This format does not support multiport sample-based data, single- or multiport frame-based data, variable-size data, or multirate data.

This property does not apply to floating scopes and scope viewers.

Dependency

Activate this property by setting `DataLogging` to `true`.

DataLoggingLimitDataPoints — Limit buffered data

false (default) | true

Set to `true` to limit buffered data before plotting and saving data.

For simulations with **Stop time** set to `inf`, always set this parameter to `true`.

Dependency

If this property is set to `true`, also specify the number of data values to plot and save with the property `DataLoggingMaxPoints`.

DataLoggingMaxPoints — Maximum number of data values

'5000' (default) | character vector | string scalar

Maximum number of data values to plot and save, specified as a character vector or string scalar. The data values that are plotted and saved are from the end of a simulation. For example, setting this property to 100 saves the last 100 data points.

Dependency

Activate this property by setting `DataLoggingLimitDataPoints` to `true`. Specifying this property limits the data values a scope plots and the data values saved in the MATLAB variable specified in `DataLoggingVariableName`.

DataLoggingDecimateData — Reduce scope data

false (default) | true

Set this property to `true` to reduce scope data before plotting and saving.

Dependency

If this property is set to `true`, you must also specify the `DataLoggingDecimation` property.

DataLoggingDecimation — Decimation factor

'1' (default) | character vector | string scalar

Decimation factor applied to the signal data before plotting and saving, specified as a character vector or string scalar. The scope buffers every N^{th} data point, where N is the decimation factor you specify. A value of 1 buffers all data values.

Dependency

Activate this property by setting `DataLoggingDecimateData` to `true`.

FrameBasedProcessing — Frame-based processing of signals

false (default for Time Scope block) | true (default for Scope block)

Set this property to `true` to process signals as frame-based.

- `false` — Process signal values in a channel at each time interval (sample based).
- `true` — Process signal values in a channel as a group of values from multiple time intervals (frame based). Frame-based processing is available only with discrete input signals.

LayoutDimensions — Number of display rows and columns

[1 1] (default) | [numberOfRows numberOfColumns]

Number of display rows and columns, specified with as a two-element vector. The maximum layout dimension is 16-by-16.

- If the number of displays is equal to the number of ports, signals from each port appear on separate displays.
- If the number of displays is less than the number of ports, signals from additional ports appear on the last y-axis.

MaximizeAxes — Maximize size of signal plots`'Auto' (default) | 'On' | 'Off'`

Specify whether or not to maximize the size of signal plots:

- `'Auto'` — If `Title` and `YLabel` are not specified, maximize all plots.
- `'On'` — Maximize all plots. Values in `Title` and `YLabel` are hidden.
- `'Off'` — Do not maximize plots.

Each of the plots expands to fit the full display. Maximizing the size of signal plots removes the background area around the plots.

MinimizeControls — Hide menu and toolbar`false (default) | true`

Set this property to `true` to hide the menu and toolbar.

If you dock the scope, this property is inactive.

OpenAtSimulationStart — Open scope when starting simulation`true (default for Time Scope) | false (default for Scope)`

Set this property to `true` to open the scope when the simulation starts.

PlotAsMagnitudePhase — Magnitude and phase plots`false (default) | true`

Specify whether or not to display the magnitude and phase plots:

- `false` — Display signal plot.

If the signal is complex, plot the real and imaginary parts on the same y-axis (display).

- `true` — Display magnitude and phase plots.

If the signal is real, plot the absolute value of the signal for the magnitude. The phase is 0 degrees for positive values and 180 degrees for negative values.

Dependency

Set the `ActiveDisplay` property before setting this property.

Position — Size and location of the scope`[left bottom width height]`

Size and location of scope window, specified as a four-element vector consisting of the left, bottom, width, and height positions, in pixels.

By default, a scope window appears in the center of your screen with a width of 560 pixels and height of 420 pixels.

ShowGrid — Vertical and horizontal grid lines

true (default) | false

Set this property to true to display vertical and horizontal grid lines.

Dependency

Set the `ActiveDisplay` property before setting this property.

SampleTime — Time interval

'-1' (default) | character vector | string scalar

Time interval between Scope block updates during a simulation, specified as a character vector or string scalar. This property does not apply to floating scopes and scope viewers.

ShowLegend — Signal legend

false (default) | true

Set this property to true to display the legend.

Names listed in the legend are the signal names from the model. For signals with multiple channels, a channel index is appended after the signal name. See the Scope block reference for an example.

Dependency

Set the `ActiveDisplay` property before setting this property.

ShowTimeAxisLabel — Display or hide x-axis labels

true (default for Time Scope block) | false (default for Scope block)

Set this property to true to display the x-axis labels.

Dependency

Set the `ActiveDisplay` property before setting this property.

If this property is set to true, also set `TimeAxisLabels`. If `TimeAxisLabels` is set to 'None', this property is inactive.

TimeAxisLabels — How x-axis labels display

'All' (default for Time Scope block) | 'Bottom' (default for Scope block) | 'None'

How x-axis labels display, specified as one of these values:

- 'All' — Display x-axis labels on all displays.
- 'Bottom' — Display x-axis labels only on the bottom display.
- 'None' — Do not display labels and deactivate `ShowTimeAxisLabel` property.

Dependency

Set the `ActiveDisplay` property before specifying this property.

Set `ShowTimeAxisLabel` to true and set `Maximize axes` to 'Off'.

TimeDisplayOffset — x-axis range offset

'0' (default) | character vector | string scalar

x-axis range offset number, specified as a character vector or string scalar. For input signals with multiple channels, enter a scalar or vector of offsets.

- Scalar — Offset all channels of an input signal by the same value.
- Vector — Independently offset the channels.

TimeSpan — Length of x-axis range to display

'0' (default) | character vector | string scalar | 'Auto'

Length of x-axis range to display, specified as one of these values:

- Positive real number — Any value less than the total simulation time specified as a character vector or string scalar.
- 'Auto' — Difference between the simulation start and stop times.

The block calculates the beginning and end times of the x-axis range using the `TimeDisplayOffset` and `TimeSpan` properties. For example, if you set `TimeDisplay` to 10 and the `TimeSpan` to 20, the scope sets the x-axis range from 10 to 30.

TimeSpanOverrunAction — How to display data

'Wrap' (default) | 'Scroll'

How to display data beyond the visible x-axis range, specified as one of these values:

- 'Wrap' — Draw a full screen of data from left to right, clear the screen, and then restart drawing of data.
- 'Scroll' — Move data to the left as new data is drawn on the right. This mode is graphically intensive and can affect run-time performance.

You can see the effects of this option only when plotting is slow with large models or small step sizes.

TimeUnits — Units to display on the x-axis

'Metric' (default for Time Scope block) | 'None' (default for Scope block) | 'Seconds'

Units to display on the x-axis, specified as one of these values:

- 'Metric' — Display time units based on the length of the `TimeSpan` property.
- 'None' — Display Time on the x-axis.
- 'Seconds' — Display Time (seconds) on the x-axis.

Title — Title for display

'%<SignalLabel>' (default) | character vector | string scalar

Title for a display, specified as a character vector or string scalar. The default value `%<SignalLabel>` uses the input signal name for the title.

Dependency

Set the `ActiveDisplay` property before setting this property.

Visible — Visibility of scope window

true (default) | false

Set this property to true to make the scope window visible.

YLabel — Y-axis label`''` (default) | character vector | string scalar

y-axis label for active display, specified as a character vector or string scalar.

Dependency

Set the `ActiveDisplay` property before setting this property.

If `PlotAsMagnitudePhase` is `true`, the value of `YLabel` is hidden and plots are labeled `Magnitude` and `Phase`.

YLimits — Minimum and maximum values of y-axis`[-10 10]` (default) | [`ymin ymax`]

Minimum and maximum values of y-axis, specified as a two-element numeric vector.

Dependency

Set the `ActiveDisplay` property before setting this property.

When `PlotAsMagnitudePhase` is `true`, this property specifies the y-axis limits for the magnitude plot. The y-axis limits of the phase plot are always `[-180 180]`.

Examples

Create Scope Configuration Object

This example creates a scope configuration object using the `'vdp'` model which models the van der Pol equation.

```
open_system('vdp')
myScopeConfiguration = get_param('vdp/Scope','ScopeConfiguration');
myScopeConfiguration.NumInputPorts = '2';
```

See Also

[Scope](#) | [Floating Scope](#) | [Time Scope](#)

Topics

“Control Scope Blocks Programmatically”

Introduced in R2013a

Simulink.Simulation.Job class

Package: Simulink

Execute `batchsim` to create a `Simulink.Simulation.Job` object, `simJob`

Description

Execute `batchsim` command with a parallel pool to create a `Simulink.Simulation.Job` object. The `batchsim` command offloads multiple simulations to run in batch using the inputs specified with an array of `Simulink.SimulationInput` objects. You can use this object to monitor the status of a batch job, fetch outputs of a completed batch job, or cancel one or more jobs.

The `batchsim` command uses the Parallel Computing Toolbox™ license to run the simulations on compute cluster. If a parallel pool cannot be created `batchsim` runs the simulations in serial. In the absence of Parallel Computing Toolbox license, `batchsim` errors out.

Construction

`simJob = batchsim(in)` creates a `Simulink.Simulation.Job` object, `simJob`, while running multiple simulations in batches on a compute cluster using the inputs specified in the `Simulink.SimulationInput` object, `in`.

`createSimulationJob(batchJob)` creates a `Simulink.Simulation.Job` object from a `parallel.job` object, `batchJob`. Use the `createSimulationJob` command to retrieve the job object returned by the `batchsim` command.

Input Arguments

in — `Simulink.SimulationInput` object array

object (default) | array

A `Simulink.SimulationInput` object or an array of `Simulink.SimulationInput` objects used to run multiple simulations. Specify parameters and values of a model to run multiple simulations without making it dirty.

Example: `in = Simulink.SimulationInput('vdp'), in(1:10) = Simulink.SimulationInput('vdp')`

Properties

AdditionalPaths — Folders to add to MATLAB search path of workers

character vector | string | string array | array of character vectors

Specified folders to add to MATLAB search path of parallel workers.

This property is read-only.

AttachedFiles — Files and folders sent to the workers

character vector | string | string array | array of character vectors

Files and folders to send to the parallel workers.

This property is read-only.

AutoAddClientPath — Whether user-added entries on client path are added to each worker path

true (default) | false

Whether user-added entries on the client path are added to each parallel worker path at the start of the batch job, specified as true or false.

CreateDateTime — Date and time of simJob creation

datetime object

Date and time at which the batch job was created, specified as a datetime object.

This property is read-only.

EnvironmentVariables — Environment variables sent to the workers

character vector | string | string array | array of character vectors

Defines the names of environment variables that are copied from a client session to the parallel workers.

This property is read-only after job submission.

FinishDateTime — Date and time of simJob completion

datetime object

Date and time at when the batch job completes execution, specified as a datetime object.

This property is read-only.

ID — Numeric identifier of the simJob object

scalar integer

ID of the future object, specified as a scalar integer.

This property is read-only.

Name — simJob name

string | character vector

Name of the job object, specified as a string.

Parent — Cluster object containing simJob

parallel.cluster object

Cluster object that contains the Simulink.Simulation.Job object, simJob.

StartDateTime — Date and time when simJob starts running

datetime object

Date and time when the Simulink.Simulation.Job starts running, specified as a datetime object.

This property is read-only.

State — Current state of future object array

'pending' | 'queued' | 'running' | 'finished' | 'failed'

Current state of future object array, specified as 'pending', 'queued', 'running', 'finished', or 'failed'.

This property is read-only.

SubmitDateTime — Date and time of simJob submission

datetime object

Date and time when the Simulink.Simulation.Job is submitted, specified as a datetime object.

This property is read-only.

Tag — Label associated with simJob

string

Label associated with Simulink.Simulation.Job object.

Type — Job Type

independent | pool

Type of the Simulink.Simulation.Job object, specified as independent or pool.

UserData — Data associated with simJob

string

Stores any data associated with a job object. The data is stored in a client MATLAB session, and is not available on the workers.

UserName — Name of the user who creates the simJob object

string | character vector

Name of the user who creates the Simulink.Simulation.Job object.

Methods

| Method | Purpose |
|-----------------------|--|
| cancel | Cancel a pending, queued, or running Simulink.Simulation.Job object |
| diary | Display or save Command Window text of batch job |
| fetchOutputs | Retrieve an array of Simulink.SimulationOutput objects from all simulations in Simulink.Simulation.Job |
| listAutoAttachedFiles | List of files automatically attached to job, task, or parallel pool |
| wait | Wait for Simulink.Simulation.Job object to change state |

Examples

Run Parallel Simulations With `batchsim` to Create `Simulink.Simulation.Job`

This example shows how to run parallel simulations in batch using the `sldemo_househeat` model. `batchsim` offloads simulations to the compute cluster, enabling you to carry out other tasks while the batch job is processing, or close the client MATLAB and access the batch job later.

Observe the model behavior for different temperature set points.

1. Open the model.

```
open_system('sldemo_househeat');
```

2. Define a set of values for different temperatures.

```
setPointValues = 65:2:85;
spv_Length = length(setPointValues);
```

3. Using the `setPointValues`, initialize an array of `Simulink.SimulationInput` objects.

```
in(1:spv_Length) = Simulink.SimulationInput('sldemo_househeat');
for i = 1:1:spv_Length
    in(i) = in(i).setBlockParameter('sldemo_househeat/Set Point',...
        'Value',num2str(setPointValues(i)));
end
```

4. Specify the pool size of the number of workers to use. In addition to the number of workers used to run simulations in parallel, a head worker is required. In this case, assume that three workers are available to run a batch job for the parallel simulations. The job object returns useful metadata as shown. You can use the job ID to access the job object later from any machine. `NumWorkers` displays how many workers are running the simulations - the number of workers specified in the `'Pool'` argument plus an additional head worker.

```
simJob = batchsim(in,'Pool',3)

        ID: 1
        Type: pool
    NumWorkers: 4
        Username: #####
        State: running
    SubmitDateTime: ##-###-#### ##:##:##
    StartDateTime:
    Running Duration: 0 days 0h 0m 0s
```

See Also

Functions

`parsim` | `batchsim` | `cancel` | `diary` | `fetchOutputs` | `listAutoAttachedFiles` | `wait` | `parcluster` | `getSimulationJobs`

Classes

`Simulink.SimulationInput` | `Simulink.Simulation.Job` | `parallel.Cluster`

Topics

“Comparison Between Multiple Simulation Workflows”
 “Job Monitor” (Parallel Computing Toolbox)
 “Batch Processing” (Parallel Computing Toolbox)

Introduced in R2018b

cancel

Package: Simulink

Cancel a pending, queued, or running `Simulink.Simulation.Job` object

Syntax

```
cancel(simJob)
cancel(simJob, 'Message')
```

Description

`cancel(simJob)` stops the `Simulink.Simulation.Job` object, `simJob`, that is currently in 'pending', 'queued', or 'running' state.

`cancel(simJob, 'Message')` stops the `Simulink.Simulation.Job` object, `simJob`, that is in 'pending', 'queued', or 'running' state and displays a user-specified message.

The `State` property of `Simulink.Simulation.Job` object is set to finished, and other pending simulations are canceled. Canceling a job object disables you to fetch results from it. A canceled job object cannot be started again.

Note On canceling the job, the results of the completed simulations in the job are also lost.

Examples

Cancel a Batch Job

This example shows how to use the `cancel` method on a `simJob` object to stop simulations. The example runs several simulations of the `vdp` model, varying the value of the gain `Mu`.

1. Open the model and define a vector of `Mu` values.

```
open_system('vdp');
mu_Values = [0.5:0.25:1000];
muVal_Length = length(mu_Values);
```

2. Using `mu_Values`, initialize an array of `Simulink.SimulationInput` objects.

```
in(1:muVal_Length) = Simulink.SimulationInput('vdp');
for i = 1:1:muVal_Length
    in(i) = in(i).setBlockParameter('vdp/Mu', ...
        'Gain', num2str(mu_Values(i)));
end
```

3. Specify the pool size of the number of workers to use. In addition to the number of workers used to run simulations in parallel, a head worker is required. In this case, assume that three workers are available to run a batch job for the parallel simulations. The simulations are offloaded onto the default cluster profile.

```
simJob = batchsim(in, 'Pool',3);
```

4. Now, assume that you want to run simulations with different values of Mu and cancel the ongoing simulations.

```
cancel(simJob)
```

Input Arguments

simJob — **Simulink.Simulation.Job** object
object

A `Simulink.Simulation.Job` object. To create a `simJob`, run `batchsim`.

Example: `simJob = batchsim(in, 'Pool',6)`

See Also

Functions

`parsim` | `batchsim` | `batch` | `diary` | `fetchOutputs` | `listAutoAttachedFiles` | `wait` | `getSimulationJobs`

Classes

`Simulink.SimulationInput` | `Simulink.Simulation.Job`

Topics

“Comparison Between Multiple Simulation Workflows”

“Batch Processing” (Parallel Computing Toolbox)

Introduced in R2018b

diary

Package: Simulink

Display or save Command Window text of `Simulink.Simulation.Job` object

Syntax

```
diary(simJob)
diary(simJob, 'filename')
```

Description

`diary(simJob)` displays the Command Window output from the `Simulink.Simulation.Job` object, `simJob`, in the MATLAB Command Window. The Command Window output is captured only if the `batchsim` command includes the `'CaptureDiary'` argument with a value of `true`.

`diary(simJob, 'filename')` causes the Command Window output from the batch job to be appended to the specified file. Open the file, `filename`, with any text editor.

Examples

Display the Diary of `simJob`

This example uses `sldemo_househeat` model to show how to display the diary of the `Simulink.Simulation.Job` object, `simJob`. To create a `simJob`, you run parallel simulations using the `batchsim` command.

1. Open the model.

```
open_system('sldemo_househeat');
```

2. Define a set of values for different temperatures.

```
setPointValues = 65:2:85;
spv_Length = length(setPointValues);
```

3. Using `setPointValues`, initialize an array of `Simulink.SimulationInput` objects.

```
in(1:spv_Length) = Simulink.SimulationInput('sldemo_househeat');
for i = 1:1:spv_Length
    in(i) = in(i).setBlockParameter('sldemo_househeat/Set Point',...
        'Value', num2str(setPointValues(i)));
end
```

4. Specify the pool size of the number of workers to use. In addition to the number of workers used to run simulations in parallel, a head worker is required. In this case, assume that three workers are available to run a batch job for the parallel simulations. The job object returns useful metadata as shown. You can use the job ID to access the job object later from any machine. `NumWorkers` displays how many workers are running the simulations - the number of workers specified in the `'Pool'` argument plus an additional head worker.

```
simJob = batchsim(in, 'Pool', 3)

        ID: 1
        Type: pool
    NumWorkers: 4
        Username: #####
        State: running
    SubmitDateTime: ##-###-#### #:##:##
    StartDateTime:
    Running Duration: 0 days 0h 0m 0s
```

5. Use the `diary` method of the `Simulink.Simulation.Job` object to display the output of the batch job in the MATLAB command window.

Note that the diary is not displayed here because this is an example model.

```
diary(simJob)
```

Input Arguments

simJob — `Simulink.Simulation.Job` object
object

A `Simulink.Simulation.Job` object. To create a `simJob`, run `batchsim`.

Example: `simJob = batchsim(in, 'Pool', 4)`

'filename' — File to append with Command Window output text
string

Specify a file to append with Command Window output text from the `Simulink.Simulation.Job` object.

Example: `diary(simJob, 'abc.txt')`

See Also

Functions

`parsim` | `batchsim` | `cancel` | `fetchOutputs` | `listAutoAttachedFiles` | `wait` | `parcluster` | `getSimulationJobs`

Classes

`Simulink.SimulationInput` | `Simulink.Simulation.Job` | `parallel.Cluster`

Topics

“Comparison Between Multiple Simulation Workflows”
“Batch Processing” (Parallel Computing Toolbox)

Introduced in R2018b

fetchOutputs

Package: Simulink

Retrieve an array of `Simulink.SimulationOutput` objects from all simulations in `Simulink.Simulation.Job`

Syntax

```
out = fetchOutputs(simJob)
```

Description

`out = fetchOutputs(simJob)` returns an array of `Simulink.SimulationOutput` objects containing the results of the simulations in a batch job, `simJob`.

`fetchOutputs` reports an error if the job is not in the 'finished' state, or if one of its simulations encounters an error during execution. Use the `wait` method to wait for the job to complete before fetching outputs.

Examples

Fetch Outputs of the Batch Simulations

This example shows how to run parallel simulations in batch and fetch the resulting `Simulink.SimulationOutput` objects from the `Simulink.Simulation.Job` object. `batchsim` command offloads simulations to the compute cluster, enabling you to carry out other tasks while the batch job is processing, or close the client MATLAB and access the batch job later.

1. Open the model.

```
open_system('sldemo_househeat');
```

2. Define a set of values for different temperatures.

```
setPointValues = 65:2:85;
spv_Length = length(setPointValues);
```

3. Using `setPointValues`, initialize an array of `Simulink.SimulationInput` objects.

```
in(1:spv_Length) = Simulink.SimulationInput('sldemo_househeat');
for i = 1:1:spv_Length
    in(i) = in(i).setBlockParameter('sldemo_househeat/Set Point',...
        'Value',num2str(setPointValues(i)));
end
```

4. Specify the pool size of the number of workers to use. In addition to the number of workers used to run simulations in parallel, a head worker is required. In this case, assume that three workers are available to run a batch job for the parallel simulations. The job object returns useful metadata as shown. You can use the job ID to access the job object later from any machine. `NumWorkers` displays

how many workers are running the simulations - the number of workers specified in the 'Pool' argument plus an additional head worker.

```
simJob = batchsim(in, 'Pool', 3)

        ID: 1
        Type: pool
    NumWorkers: 4
        Username: #####
        State: running
    SubmitDateTime: ##-##-#### #:##:##
    StartDateTime:
    Running Duration: 0 days 0h 0m 0s
```

5. Access the results of the batch job using the `fetchOutputs` method. `fetchOutputs` returns an array of `Simulink.SimulationOutput` objects. You can fetch outputs only once `simJob` is in finished state.

```
out = fetchOutputs(simJob)
```

```
1x11 Simulink.SimulationOutput array
```

Input Arguments

simJob — `Simulink.Simulation.Job` object

object

A `Simulink.Simulation.Job` object. To create `simJob`, run `batchsim`.

Example: `simJob = batchsim(in, 'Pool', 4)`

Output Arguments

out — Simulation object containing logged simulation results

object

Array of `Simulink.SimulationOutput` objects that contain all of the logged simulation results. The size of the array is equal to the size of the array of `Simulink.SimulationInput` objects passed to `batchsim`.

All simulation outputs (logged time, states, and signals) are returned in a single `Simulink.SimulationOutput` object. You define the model time, states, and output that are logged using the **Data Import/Export** pane of the Model Configuration Parameters dialog box. You can log signals using blocks such as the To Workspace and Scope blocks. The **Signal & Scope Manager** tool can directly log signals.

See Also

Functions

`parsim` | `batchsim` | `cancel` | `diary` | `listAutoAttachedFiles` | `wait` | `getSimulationJobs`

Classes

`Simulink.SimulationInput` | `Simulink.Simulation.Job` | `Simulink.SimulationOutput`

Topics

“Comparison Between Multiple Simulation Workflows”
“Batch Processing” (Parallel Computing Toolbox)

Introduced in R2018b

listAutoAttachedFiles

Package: Simulink

List of files automatically attached to the `Simulink.Simulation.Job` object or parallel pool

Syntax

```
listAutoAttachedFiles(simJob)
```

Description

`listAutoAttachedFiles(simJob)` performs a dependency analysis on the `Simulink.Simulation.Job` job object, `simJob`. Then it displays a list of the code files that are already attached or are going to be automatically attached to the job object, `simJob`.

Examples

Run Parallel Simulations with `batchsim` and List Attached Files

This example shows how to run parallel simulations in batch and list any attached files. `batchsim` offloads simulations to the compute cluster, enabling you to carry out other tasks while the batch job is processing, or close the client MATLAB and access the batch job later.

1. Open the model.

```
open_system('sldemo_househeat');
```

2. Define a set of values for different temperatures.

```
setPointValues = 65:2:85;
spv_Length = length(setPointValues);
```

3. Using the `setPointValues`, initialize an array of `Simulink.SimulationInput` objects.

```
in(1:spv_Length) = Simulink.SimulationInput('sldemo_househeat');
for i = 1:1:spv_Length
    in(i) = in(i).setBlockParameter('sldemo_househeat/Set Point',...
    'Value',num2str(setPointValues(i)));
end
```

4. Specify the pool size of the number of workers to use. In addition to the number of workers used to run simulations in parallel, a head worker is required. In this case, assume that three workers are available to run a batch job for the parallel simulations. The job object returns useful metadata as shown. You can use the job ID to access the job object later from any machine. `NumWorkers` displays how many workers are running the simulations - the number of workers specified in the `'Pool'` argument plus an additional head worker.

```
simJob = batchsim(in,'Pool',3)
```

```
    ID: 1
  Type: pool
```

```
    NumWorkers: 4
      Username: #####
        State: running
  SubmitDateTime: ##-##-#### #:##:##
  StartDateTime:
Running Duration: 0 days 0h 0m 0s
```

If `AutoAttachFiles` property of `Simulink.Simulation.Job` is set to true in the cluster profile, then the job running on the cluster has the necessary code files automatically attached to it. Use the `listAutoAttachedFiles` method to view the attached files.

Note that the list of attached files is not displayed here because this is an example model.

```
listAutoAttachedFiles(simJob)
```

Input Arguments

simJob — `Simulink.Simulation.Job` object
object

A `Simulink.Simulation.Job` object. To create a `simJob`, run `batchsim`.

Example: `simJob = batchsim(in,'Pool',4)`

See Also

Functions

`parsim` | `batchsim` | `cancel` | `diary` | `fetchOutputs` | `wait` | `getSimulationJobs`

Classes

`Simulink.SimulationInput` | `Simulink.Simulation.Job`

Topics

“Comparison Between Multiple Simulation Workflows”

“Batch Processing” (Parallel Computing Toolbox)

Introduced in R2018b

wait

Package: Simulink

Wait for Simulink.Simulation.Job object to change state

Syntax

```
wait(simJob)
wait(simJob, 'stateOfJob')
wait(simJob, 'stateOfJob', timeout)
```

Description

`wait(simJob)` blocks execution in a client session until the job identified by the object `simJob` reaches the 'finished' state or fails. This occurs when all the simulations finish execution on the workers.

`wait(simJob, 'stateOfJob')` blocks execution in the client session until the specified job object changes state to the value of 'state'. The valid states to wait for are 'queued', 'running', and 'finished'. If the object is currently or has already been in the specified state, `wait` is not performed and execution returns immediately. For example, if you execute `wait(simJob, 'queued')` for a job already in the 'finished' state, the call returns immediately.

`wait(simJob, 'stateOfJob', timeout)` blocks execution until either the job reaches the specified 'state', or timeout seconds elapse, whichever happens first.

Examples

Wait for Simulations in simJob to Finish

This example shows uses the `sldemo_househeat` model to show how to wait for the batch simulations to finish.

1. Open the model.

```
open_system('sldemo_househeat');
```

2. Define a set of values for different temperatures.

```
setPointValues = 65:2:85;
spv_Length = length(setPointValues);
```

3. Using the `setPointValues`, initialize an array of Simulink.SimulationInput objects.

```
in(1:spv_Length) = Simulink.SimulationInput('sldemo_househeat');
for i = 1:1:spv_Length
    in(i) = in(i).setBlockParameter('sldemo_househeat/Set Point', ...
        'Value', num2str(setPointValues(i)));
end
```

4. Specify the pool size of the number of workers to use. In addition to the number of workers used to run simulations in parallel, a head worker is required. In this case, assume that three workers are available to run a batch job for the parallel simulations. The job object returns useful metadata as shown. You can use the job ID to access the job object later from any machine. NumWorkers displays how many workers are running the simulations - the number of workers specified in the 'Pool' argument plus an additional head worker.

```
simJob = batchsim(in, 'Pool', 3)

        ID: 1
        Type: pool
    NumWorkers: 4
        Username: #####
        State: running
    SubmitDateTime: ##-##-#### #:##:##
    StartDateTime:
    Running Duration: 0 days 0h 0m 0s
```

5. Now, wait for the job to finish before retrieving the outputs.

```
wait(simJob)
```

Input Arguments

simJob — **Simulink.Simulation.Job** object
object

A Simulink.Simulation.Job object. To create a simJob, run batchsim.

Example: `simJob = batchsim(in, 'Pool', '5')`

'stateOfJob' — **Value of the simulation job object State property to wait for**
'pending' | 'queued' | 'running' | 'finished' | 'failed' | 'unavailable'

Value of the State property of Simulink.Simulation.Job object to wait for.

Example: `wait(simJob, 'queued')`

timeout — **Maximum time to wait, in seconds**
object

Specify a timeout for wait to block execution in seconds.

Example: `wait(simJob, 5)`

See Also

Functions

parsim | batchsim | cancel | diary | fetchOutputs | listAutoAttachedFiles

Classes

Simulink.SimulationInput | Simulink.Simulation.Job

Topics

“Comparison Between Multiple Simulation Workflows”

Introduced in R2018b

simulink.schedule.OrderedSchedule class

Package: simulink.schedule

Creates an OrderedSchedule object containing priority order of the partitions of a model

Description

The `simulink.schedule.OrderedSchedule` object is a representation of the execution order of the partitions of the specified model. Access this object as a model parameter with `get_param`. You can use the `OrderedSchedule` object to modify the schedule of the partitions of the model through the command line.

You can use `set_param` to apply the schedule to the model.

Creation

`get_param mdl, 'Schedule'` creates an `OrderedSchedule` object for the specified model, `mdl`.

Properties

Order — Priority order of the partitions

table

Priority order of the partitions, specified as a table where:

RateSections — Sections of the order table

array

`RateSections` is an array of objects containing a portion of the order table with a single rate. Use `RateSections` to easily modify the order of the execution of partitions within valid groups.

Description — Description of the OrderedSchedule object

string

Purpose of an individual schedule object, specified as a string.

Examples

Create and Analyze Random Schedules for a Model Using the Schedule Editor API

This example uses the Schedule Editor API to perform operations on the schedule. Then it uses a function to generate random schedules and analyze them in Simulation Data Inspector

Open the Model and get the Schedule Object

Open a model of a Throttle Position Control system and use `get_param` to obtain the `simulink.schedule.OrderedSchedule` object. This object contains the current schedule.

```

model = 'ScheduleEditorAPIWithSubsystemPartitions';
open_system(model);
schedule = get_param(model, 'Schedule')

schedule =

    OrderedSchedule with properties:

        Order: [9x3 table]
        RateSections: [3x1 simulink.schedule.RateSection]
        Events: [0x1 simulink.schedule.Event]
        Description: ''
    
```

Schedule Subsystem Partitions with the Schedule Editor

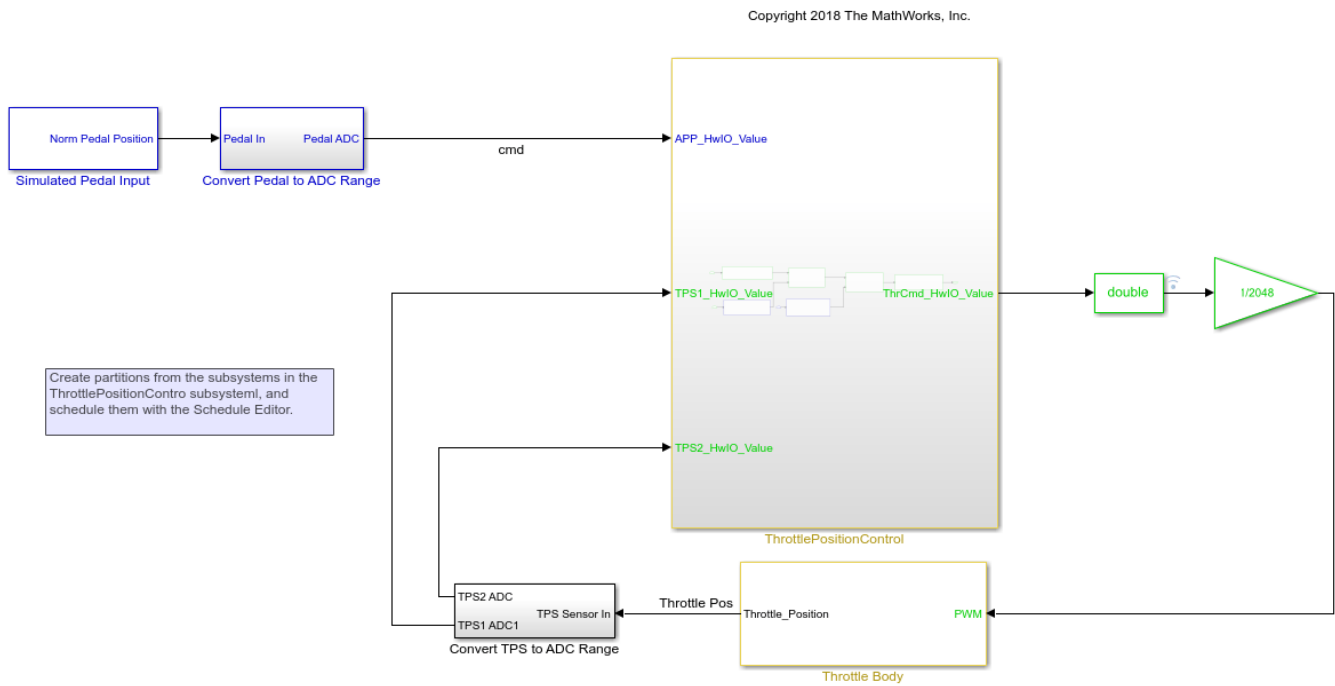

Examine the Schedule Object

The schedule object has an `Order` property that contains the execution order of the partitions in the model. The `Order` property displays a table that contains partition names, their index, type, and their trigger.

```
schedule.Order
```

```
ans =
```

9x3 table

| Index | Type | Trigger |
|-------|------|---------|
|-------|------|---------|

| | | | |
|--------------------|---|----------|---------|
| Cont | 1 | Periodic | "0" |
| TPSSecondaryRun5ms | 2 | Periodic | "0.005" |
| MonitorRun5ms | 3 | Periodic | "0.005" |
| ControllerRun5ms | 4 | Periodic | "0.005" |
| ActuatorRun5ms | 5 | Periodic | "0.005" |
| D2 | 6 | Periodic | "0.005" |
| D3 | 7 | Periodic | "0.01" |
| APPSnsrRun | 8 | Periodic | "0.01" |
| TPSPPrimaryRun10ms | 9 | Periodic | "0.01" |

Use the index variable in the `Order` table to change the execution order of the model

```
schedule.Order.Index('ActuatorRun5ms') = 2;
schedule.Order
```

```
ans =
```

```
9x3 table
```

| | Index | Type | Trigger |
|--------------------|-------|----------|---------|
| Cont | 1 | Periodic | "0" |
| ActuatorRun5ms | 2 | Periodic | "0.005" |
| TPSSecondaryRun5ms | 3 | Periodic | "0.005" |
| MonitorRun5ms | 4 | Periodic | "0.005" |
| ControllerRun5ms | 5 | Periodic | "0.005" |
| D2 | 6 | Periodic | "0.005" |
| D3 | 7 | Periodic | "0.01" |
| APPSnsrRun | 8 | Periodic | "0.01" |
| TPSPPrimaryRun10ms | 9 | Periodic | "0.01" |

Any moves within the `Order` property that are made to modify the schedule should result in valid schedule. To perform the schedule modifications and valid moves easier, each partition is grouped with partitions of the same rate in the `RateSections` property. Each element of the `RateSection` property contains an order table with partitions of the same rate.

```
schedule.RateSections(2)
schedule.RateSections(2).Order
```

```
ans =
```

```
RateSection with properties:
```

```
Rate: "0.005"
Order: [5x3 table]
```

```
ans =
```

```
5x3 table
```

| | Index | Type | Trigger |
|--|-------|------|---------|
|--|-------|------|---------|

| | | | |
|--------------------|---|----------|---------|
| ActuatorRun5ms | 2 | Periodic | "0.005" |
| TPSSecondaryRun5ms | 3 | Periodic | "0.005" |
| MonitorRun5ms | 4 | Periodic | "0.005" |
| ControllerRun5ms | 5 | Periodic | "0.005" |
| D2 | 6 | Periodic | "0.005" |

Use the index variable to move the partitions within RateSections.

```
schedule.RateSections(2).Order.Index('ActuatorRun5ms') = 5;
schedule.Order
```

```
ans =
```

```
9x3 table
```

| | Index | Type | Trigger |
|--------------------|-------|----------|---------|
| Cont | 1 | Periodic | "0" |
| TPSSecondaryRun5ms | 2 | Periodic | "0.005" |
| MonitorRun5ms | 3 | Periodic | "0.005" |
| ControllerRun5ms | 4 | Periodic | "0.005" |
| ActuatorRun5ms | 5 | Periodic | "0.005" |
| D2 | 6 | Periodic | "0.005" |
| D3 | 7 | Periodic | "0.01" |
| APPSnsrRun | 8 | Periodic | "0.01" |
| TPSPPrimaryRun10ms | 9 | Periodic | "0.01" |

Create a Function to Generate Random Schedules

In this section, we create three different functions: `randomSchedule`, `generateSimulationInputs` and `simulateRandomSchedules`

`randomSchedule` function is used to create random schedules by using random permutations of index modifications in the `schedule` object. Using the `Order` and the `RateSections` properties of the `schedule` object, partitions in the schedules are moved around in different, random combinations. With these randomly created schedules, models are simulated and compared to study the effect of different schedules on simulation. In the function `randomSchedule`, the input is the model name. Then use `get_param` to obtain the `simulink.schedule.OrderedSchedule` object of the model. The schedule object and its properties are used to modify and randomize the schedules. Create a variable `firstExecutionOrder` for the first rate section of the model. The `rateSections(1).ExecutionOrder = [firstExecutionOrder(1,:); reSchedule(firstExecutionOrder(2:end,:))]` line of code calls the function `reSchedule` which creates random permutations of the indexes.

```
type randomSchedule
```

```
function schedule = randomSchedule(model)
    % schedule = randomSchedule(model) Produces a
    % simulink.schedule.OrderedSchedule that has a randomized permutation
    % of the model's original execution order schedule
```

```

arguments
    model char = bdroot
end

schedule = get_param(model, 'Schedule');

rateSections = schedule.RateSections;
firstOrder = rateSections(1).Order;

% This assumes that the slowest discrete rate is at index 1. This may
% not be the case for all models (ex. JMAAB-B).
rateSections(1).Order = [firstOrder(1,:); reSchedule(firstOrder(2:end,:))];

for i=2:length(rateSections)
    rateSections(i).Order = reSchedule(rateSections(i).Order);
end

schedule.RateSections = rateSections;
end

function out = reSchedule(in)
    numPartitions = height(in);
    in.Index = in.Index(randperm(numPartitions));
    out = in;
end

```

To analyze the effects of different schedules on the model, simulate the model with the different schedules. In this function, create an array of `Simulink.SimulationInput` objects. Through this array of `Simulink.SimulationInput` objects, you can apply the schedules to the model with the `setModelParameters` method of the `Simulink.SimulationInput` object.

type [generateSimulationInputs](#)

```

function in = generateSimulationInputs(model, numSimulations)
    % in = generateSimulationInputs(model, numSimulations) Generates
    % numSimulations Simulink.SimulationInput objects each containing a
    % different, randomized execution order schedule
    arguments
        model char = bdroot
        numSimulations double = 10
    end

    in(numSimulations) = Simulink.SimulationInput();
    in = in.setModelName(model);
    for idx = 1:numSimulations
        in(idx) = in(idx).setModelParameter('Schedule', randomSchedule(model));
    end
end

```

In the last function, use the array of `Simulink.SimulationInput` objects to run multiple simulations. Once the simulations are complete, you can plot the output of all the simulations in Simulation Data Inspector.

type [simulateRandomSchedules](#)

```

function out = simulateRandomSchedules(model, numSimulations)

```

```
% out = simulateRandomSchedules(model, numSimulations) Simulates a
% model numSimulations number of times. Each simulation has a
% randomized execution order schedule.
arguments
    model char = bdroot
    numSimulations double = 10
end

in = generateSimulationInputs(model, numSimulations);
out = sim(in);
plot(out);
end
```

Execute the Functions

Now run the above functions for the `ScheduleEditorAPIWithSubsystemPartitions` model. First, use the `randomSchedule` function to create randomly generated schedules, then, use the `generateSimulationInputs` function to generate an array of `Simulink.SimulationInput` objects, and use the `simulateRandomSchedule` function to simulate the model with different schedules and plot their results for comparison. Let's run simulations with 15 randomly generated schedules.

```
simulateRandomSchedules(model, 15)
```

```
[01-Sep-2021 18:55:01] Running simulations...
[01-Sep-2021 18:55:14] Completed 1 of 15 simulation runs
[01-Sep-2021 18:55:23] Completed 2 of 15 simulation runs
[01-Sep-2021 18:55:31] Completed 3 of 15 simulation runs
[01-Sep-2021 18:55:37] Completed 4 of 15 simulation runs
[01-Sep-2021 18:55:44] Completed 5 of 15 simulation runs
[01-Sep-2021 18:55:52] Completed 6 of 15 simulation runs
[01-Sep-2021 18:55:59] Completed 7 of 15 simulation runs
[01-Sep-2021 18:56:06] Completed 8 of 15 simulation runs
[01-Sep-2021 18:56:13] Completed 9 of 15 simulation runs
[01-Sep-2021 18:56:21] Completed 10 of 15 simulation runs
[01-Sep-2021 18:56:28] Completed 11 of 15 simulation runs
[01-Sep-2021 18:56:35] Completed 12 of 15 simulation runs
[01-Sep-2021 18:56:41] Completed 13 of 15 simulation runs
[01-Sep-2021 18:56:48] Completed 14 of 15 simulation runs
[01-Sep-2021 18:56:54] Completed 15 of 15 simulation runs
```

```
ans =
```

```
1x15 Simulink.SimulationOutput array
```

See Also

Schedule Editor

Topics

“Schedule the Partitions”

“Create Partitions”

Introduced in R2020a

simulink.schedule.createSchedule

Package: simulink.schedule

Create a new schedule using provided schedule and ordering

Syntax

```
outputSchedule = createSchedule(inputSchedule, partitionOrder)
outputSchedule = createSchedule(inputSchedule, partitionOrder,
'IgnoreExtra',true)
```

Description

`outputSchedule = createSchedule(inputSchedule, partitionOrder)` creates a new `simulink.schedule.OrderedSchedule` object, `sch` with all the partitions present in the `simulink.schedule.OrderedSchedule` object, `inputSchedule`, according to order specified by the vector, `partitionOrder`.

`outputSchedule = createSchedule(inputSchedule, partitionOrder, 'IgnoreExtra',true)` creates a new `simulink.schedule.OrderedSchedule` object, `sch` with all the partitions present in the `simulink.schedule.OrderedSchedule`, `Schedule`, according to order specified by the parameter, `partitionOrder` while ignoring any partitions that are not already present in `sch`. `PartitionOrder` must contain all partitions of `inputSchedule`.

Input Arguments

inputSchedule — A `simulink.schedule.Orderedschedule` object
object

An existing `simulink.schedule.Orderedschedule` object copied to create new schedule.

partitionOrder — A vector of partition names
vector

Partition names in the desired order, specified as a vector of strings.

Name-Value Pair Arguments

Specify optional comma-separated pairs of `Name`, `Value` arguments. `Name` is the argument name and `Value` is the corresponding value. `Name` must appear inside quotes. You can specify several name and value pair arguments in any order as `Name1, Value1, ..., NameN, ValueN`.

Example: `'IgnoreExtra', true`

IgnoreExtra — Ignore additional partitions
`false` (default) | `true`

When specified as `true`, the `createSchedule` function ignores any additional partitions in `partitionOrder` that are not present in the object, `inputSchedule`.

Output Arguments

outputSchedule — New `simulink.schedule.Orderedschedule` object
object

A new or modified `simulink.schedule.Orderedschedule` object.

See Also

`simulink.schedule.OrderedSchedule` | **Schedule Editor**

Topics

“Create Partitions”

Introduced in R2020a

Simulink.dialog.TreeControl class

Package: Simulink.dialog

Control Tree control programmatically

Description

Use an instance of Simulink.dialog.TreeControl class to perform the following operations:

- Get selected items from the tree
- Set selected items in the tree

Properties

Name

Uniquely identifies the dialog control and is a required field.

Type: character vector or string

Prompt

Specifies the text displayed on the tree dialog control.

Type: character vector or string

Default: empty

TreeItems

Specifies the items shown in the tree.

Type: cell array

Default: empty

Callback

Specifies the MATLAB command (s) to be executed when the dialog control is invoked.

Type: character vector or string

Default: empty

Row

Specifies whether dialog control is placed on the current row or on a new row.

Type: character vector

Value: 'current' | 'new'

Default: 'current'

Enabled

Indicates whether tree control is active on the mask dialog box.

Type: boolean

Value: 'on' | 'off'

Default: 'on'

Visible

Indicates whether tree control is displayed on the mask dialog box.

Type: boolean

Value: 'on' | 'off'

Default: 'on'

Multiselect

Indicates whether tree control is enabled for multiple selection.

Type: boolean

Value: 'on' | 'off'

Default: 'on'

Tooltip

Indicates whether tree control has a tooltip configured.

Type: character vector or string

Default: empty

Methods

| | |
|-------------------------------|--|
| setSelectedItems(TreeControl) | Set values for a tree |
| getSelectedItems(TreeControl) | Get the values of selected items from a tree hierarchy |

See Also

setSelectedItems(TreeControl)

Class: Simulink.dialog.TreeControl

Package: Simulink.dialog

Set values for a tree

Syntax

```
treeControl.setSelectedItems({'Node1/ChildNode1', 'Node1/ChildNode2'})
```

Description

`treeControl.setSelectedItems({'Node1/ChildNode1', 'Node1/ChildNode2'})` set the values for the selected items in the tree.

Input Arguments

TreeControl — tree handle

table object

Handle to the tree, specified as an object. You can use the `getDialogControl` command to get the tree handle. For more information, see `getDialogControl`.

For example, `treeControl = maskObj.getDialogControl('TreeControl')`. Here, `maskObj` is the mask object and `TreeControl` is the name of the tree.

Data Types: cell array

value — value to be set

cell-array of string

Value to be set for selected items in the tree.

Examples

```
maskObj = Simulink.Mask.get( gcb );
treeControl = maskObj.getDialogControl('Control2')
```

```
% Set selected items
treeControl.setSelectedItems({'Node1/ChildNode1', 'Node1/ChildNode2'})
```

See Also

Simulink.Mask | “Create Block Masks”

Introduced in R2019b

getSelectedItems(TreeControl)

Class: Simulink.dialog.TreeControl

Package: Simulink.dialog

Get the values of selected items from a tree hierarchy

Syntax

```
selectedItems = treeControl.getSelectedItems()
```

Description

`selectedItems = treeControl.getSelectedItems()` fetches the information of the selected items in the tree.

Output Arguments

selectedItems — value of selected items

cell array

Value of the selected items, returned as a cell array.

Examples

```
% Get block mask handle
maskObj = Simulink.Mask.get(gcb);

% Get tree handle
treeControl = maskObj.getDialogControl('TreeControl');
treeControl.getSelectedItems();
```

```
ans =
```

```
4×1 cell array
```

```
 {'Node1/ChildNode1'}
 {'Node1/ChildNode2'}
 {'Node2/ChildNode1'}
 {'Node2/ChildNode2'}
```

See Also

[Simulink.Mask](#) | “Create Block Masks”

Introduced in R2019b

getSimulationJobs

Get all `Simulink.Simulation.Job` objects from cluster

Syntax

```
jobs = getSimulationJobs(myCluster)
```

Description

`jobs = getSimulationJobs(myCluster)` returns an array of `Simulink.Simulation.Job` objects that correspond to the jobs created by executing of `batchsim` on cluster, `myCluster`.

Examples

Get a Simulink.Simulation.Job Object from the Cluster

This example shows how to access a `batchsim` job that was submitted to a cluster. Assume that `myCluster` is a `parallel.Cluster` object on which the `Simulink.Simulation.Job` object is running.

```
jobs = getSimulationJobs(myCluster)
```

1×2 Job array:

| | ID | Type | State | FinishDateTime | Username |
|---|----|------|--------|----------------|----------|
| 1 | 3 | pool | queued | | ##### |
| 2 | 4 | pool | queued | | ##### |

The output displays all the `Simulink.Simulation.Job` objects on cluster, `myCluster`.

Input Arguments

myCluster — `parallel.Cluster` object

object

Cluster object representing parallel cluster compute resources.

Output Arguments

jobs — Array of `Simulink.Simulation.Job` objects

array

Array of `Simulink.Simulation.Job` objects submitted by executing `batchsim` command.

See Also

Functions

parsim | batchsim | cancel | diary | fetchOutputs | listAutoAttachedFiles | wait | parcluster

Classes

Simulink.SimulationInput | Simulink.Simulation.Job | parallel.Cluster

Topics

“Comparison Between Multiple Simulation Workflows”

“Batch Processing” (Parallel Computing Toolbox)

“Job Monitor” (Parallel Computing Toolbox)

Introduced in R2018b

Simulink.VariantControl class

Package: Simulink

Create a variant control variable object

Description

The `Simulink.VariantControl` class creates a variant control variable object to associate the value of a variant control variable with a variant activation time. Use the `Simulink.VariantControl` object to determine the active value of variant parameter during simulation.

Creation

`variantControlVariable = Simulink.VariantControl` creates a variant control variable object with no value and `'ActivationTime'` set to `'update diagram'`.

`variantControlVariable = Simulink.VariantControl(Name, Value)` creates a variant control variable object as specified by `Name, Value` pair arguments. Using this syntax, you create an object and associate its value with a variant activation time.

Input Arguments

Name-Value Pair Arguments

Specify optional comma-separated pairs of `Name, Value` arguments. `Name` is the argument name and `Value` is the corresponding value. `Name` must appear inside quotes. You can specify several name and value pair arguments in any order as `Name1, Value1, ..., NameN, ValueN`.

Example: `'Value', 1, 'ActivationTime', 'update diagram'`

Value — Value of variant control variable object

scalar variable | enumerated type | `Simulink.Parameter`

Value of variant control variable object, specified as scalar variables, enumerated types, or `Simulink.Parameter` object.

Note For a variant control variable object with `startup` activation time, specifying a value of enumerated type is not supported.

Example: `'Value', 1`

ActivationTime — Activation time of active value

`'update diagram'` (default) | `'update diagram analyze all choices'` | `'code compile'` | `'startup'`

Simulink can set active value of the variant parameters at different stages of the simulation and code generation workflow. Based on the stage you specify using this property, Simulink determines if the generated code must contain only the active values or both active and inactive values variant

parameters. The property also determines whether to analyze all the values of the variant parameters for incompatibilities in signal attributes. For “Activate Variant During Different Stages of Simulation and Code Generation Workflow”.

When you specify the variant activation time as:

- 'update diagram' -- Simulink does not analyze the values of variant parameters for incompatibilities in signal attributes. It generates code only for the active values of variant parameters.
- 'update diagram analyze all choices' -- Simulink analyzes both active and inactive values of variant parameters for incompatibilities in signal attributes, however it generates code only for the active values of variant parameters.
- 'code compile' -- Simulink analyzes both active and inactive values of variant parameters for incompatibilities in signal attributes and it also generates code for both active and inactive values of the variant parameters. The values are enclosed in C preprocessor conditional statements `#if` and `#endif` that are conditionally compiled when you compile the generated code.
- 'startup' -- Simulink analyzes both active and inactive values of variant parameters for incompatibilities in signal attributes and it also generates code for both active and inactive values of the variant parameters. The values are enclosed in regular `if` conditions inside the `model_initialize` function of the generated code that are conditionally evaluated when you run the executable that is built from the code.

Example: 'ActivationTime', 'code compile'

Methods

Specialized Operators and Functions

These methods specialize standard MATLAB operators and functions for objects in this class.

| | |
|-----|--------------------------------------|
| ne | Compare if the inputs are not equal. |
| eq | Compares if the inputs are equal. |
| not | Returns logical NOT of input. |

Examples

Scalar Values for Rapid Prototyping of Variant Parameters

Scalar MATLAB® variables allow you to rapidly prototype variant values when you are still building your model. They help you focus more on building your variant values than on developing the expressions that activate those choices.

You can define scalar control variables in locations listed in “Storage Locations for Variant Control Variables (Operands) in Variant Condition Expressions”.

In the MATLAB Editor, specify variant choices in their simplest form as scalar variables in a `Simulink.VariantVariable` object.

```
vpObj = Simulink.VariantVariable('Choices',{ 'VCtrl==1', 1000, 'VCtrl==2', 2000})
```



```
vpObj =
VariantVariable with 2 choices:
```

| Condition | Value |
|------------|-------|
| VCtrl == 1 | 1000 |
| VCtrl == 2 | 2000 |

```
Specification: ''
```

Use `getChoice`, `setChoice`, `addChoice`, `removeChoice` to access, modify, add or remove choices

Activate one of the variant values by defining a control variable, `VCtrl`, and setting its value to 1 in a `Simulink.VariantControl` object. This condition activates the value 1000 and assigns this value to `vpObj`.

```
VCtrl = Simulink.VariantControl('Value', 1, 'ActivationTime', 'update diagram')
```

```
VCtrl =
VariantControl with properties:
    Value: 1
    ActivationTime: 'update diagram'
```

If you change the value of `VCtrl` to 2, Simulink® sets the value of `vpObj` to 2000.

```
VCtrl.Value = 2;
```

Enumerated Types to Improve Code Readability of Variant Parameters

Use enumerated types to give meaningful names to integers used as variant control values.

You can define variant control variables of enumerated types in storage locations as listed in “Storage Locations for Variant Control Variables (Operands) in Variant Condition Expressions”.

In the MATLAB® Editor, define the classes that map enumerated values to meaningful names.

Here, `EngType` is an integer-based enumeration class that is derived from the built-in data type, `int32`. The class has two enumeration values, `Small` and `Big`. These enumerated values have underlying integer values 1 and 2.

```
type EngType.m
classdef EngType < Simulink.IntEnumType
    enumeration
        Small (1)
        Big (2)
    end
end
```

Specify the names as variant choices in a `Simulink.VariantVariable` object.

```
vpObj = Simulink.VariantVariable('Choices', {'VCtrl == EngType.Small',3.5,'VCtrl == EngType.Big'}
```

```
vpObj =
VariantVariable with 2 choices:

          Condition          Value
-----
VCtrl == EngType.Big      8.5000
VCtrl == EngType.Small   3.5000
```

Specification: ''

Use `getChoice`, `setChoice`, `addChoice`, `removeChoice` to access, modify, add or remove choices

Activate one of the variant values by defining the control variable `VCtrl` and setting its value to `EngType.Small` in a `Simulink.VariantControl` object. This condition activates the value 3.5 and assigns this value to `vpObj`.

Note: For a variant control variable object with 'startup' activation time, specifying a value of enumerated type is not supported.

```
VCtrl = Simulink.VariantControl('Value',EngType.Small,'ActivationTime','code compile')
```

```
VCtrl =
VariantControl with properties:

          Value: Small
ActivationTime: 'code compile'
```

Using enumerated types simplifies the generated code because it contains the names of the values rather than integers.

Simulink.Parameter Objects for Code Generation of Variant Parameters

If you intend to generate code for a model containing variant parameter values, specify variant control variables as MATLAB® variables or `Simulink.Parameter` objects. `Simulink.Parameter` objects allow you to specify other attributes (such as data type) that are required for generating code.

Note:

- You can define a variant control variable of type `Simulink.Parameter` only in the base workspace or in a data dictionary. Defining `Simulink.Parameter` type of variant control variables in the mask or model workspace is not supported. For more information on storage locations for variant control variables, see “Storage Locations for Variant Control Variables (Operands) in Variant Condition Expressions”.
- `Simulink.Parameter` objects within structures and that have data types other than `Simulink.Bus` objects are not supported.

In the MATLAB Editor, define a `Simulink.Parameter` object.

```
VSSMODE = Simulink.Parameter;
VSSMODE.Value = 1;
VSSMODE.DataType = 'int32';
```

```
VSSMODE.CoderInfo.StorageClass = 'Custom';
VSSMODE.CoderInfo.CustomStorageClass = 'ImportedDefine';
VSSMODE.CoderInfo.CustomAttributes.HeaderFile = 'rtwdemo_importedmacros.h';
```

Variant control variables defined as `Simulink.Parameter` objects can have one of these storage classes:

- Define or ImportedDefine with header file specified
- CompilerFlag
- SystemConstant (AUTOSAR)
- Your own storage class that defines data as a macro

You can also convert a scalar variant control variable into a `Simulink.Parameter` object. For more information, see [Convert Variant Control Variables into Simulink.Parameter Objects](#).

Specify the object as a variant control using a `Simulink.VariantVariable` object.

```
vpObj = Simulink.VariantVariable('Choices', {'VCtrl == 1',1000,'VCtrl == 2',2000});
```

Activate one of the variant values by defining a control variable `VCtrl` and setting its value to `VSSMODE` in a `Simulink.VariantControl` object. This condition activates the value 1000 and assigns this value to `vpObj`.

```
VCtrl = Simulink.VariantControl('Value',VSSMODE,'ActivationTime','code compile')
```

```
VCtrl =
  VariantControl with properties:
      Value: [1x1 Simulink.Parameter]
  ActivationTime: 'code compile'
```

See Also

`Simulink.VariantVariable`

Topics

“Change Active Values and Activation Time of Variant Parameters”

“Compile Code Conditionally for all Values of Variant Parameters”

“Use Variant Parameters to Reuse Block Parameters with Different Values”

“Create a Simple Variant Parameter Model”

Introduced in R2021a

Simulink.VariantVariable class

Package: Simulink

Create a variant parameter object

Description

The `Simulink.VariantVariable` class creates a variant parameter object. You can specify multiple values for each object. You can also specify properties such as dimension, data type, and so on. Each value of the object is associated with a variant condition expression. Set the parameter values and properties in the object, then reference the object from the block.

Before you create a new `Simulink.VariantVariable` object, create a `Simulink.VariantControl` object representing the variant control variable to be used in the `Simulink.VariantVariable` object.

Note You can create the variant parameter object only in a base or in a data dictionary.

Creation

`P = Simulink.VariantVariable` creates an empty variant parameter object.

`P = Simulink.VariantVariable(Name, Value)` creates a variant parameter object as specified by one or more `Name, Value` pair arguments. Using this syntax, you can specify multiple values for the object and associate each value with a variant condition expression. You can also specify other properties of the object such as data types, storage class, dimensions, and so on.

Input Arguments

Name-Value Pair Arguments

Specify optional comma-separated pairs of `Name, Value` arguments. `Name` is the argument name and `Value` is the corresponding value. `Name` must appear inside quotes. You can specify several name and value pair arguments in any order as `Name1, Value1, ..., NameN, ValueN`.

Example: `'Specification', 'Pspec', 'Choices', {'V==1', 4.5, 'V==2', 9.5}`

Specification — Properties of variant parameter object

`Simulink.Parameter` object name

Properties of variant parameter object such as data type, dimensions, storage class, and so on, specified as the `Simulink.Parameter` object. The default storage class of a `Simulink.Parameter` object is `Auto`. If you specify the storage class as `Auto`, the value of the object is inline to the literal value in the generated code. If you specify the storage class of the object anything other than `Auto`, the object is represented as tunable parameters using symbolic names in the generated code. For more information, see “Choose Storage Class for Controlling Data Representation in Generated Code” (Simulink Coder).

Note If the variant parameter object is associated to a variant control object having a `startup` activation time then specifying the storage class of the variant parameter object to any of these is not supported:

- Storage classes such as `Define` that generates macros in the code.
 - Storage classes such as `Const` that generates constant qualified variables in the code.
-

Example: 'Specification', 'Pspec'

Choices — Variant conditions and values

cell array

Variant conditions and values, specified as a struct. During simulation, when a variant condition evaluates to `true`, its associated value becomes active. When a variant condition evaluates to `false`, its associated value becomes inactive. No two values of the same variant parameter must be associated with the same variant condition.

You can specify the variant condition as boolean MATLAB expressions that contain one or more operands and operators. See “Variant Controls in Variant Parameters”.

Example: 'Choices', {'V==1', 4.5, 'V==2', 9.5}

Methods

Public Methods

`addChoice` Add choices to variant parameter object
`getChoice` Return choices of variant parameter object
`setChoice` Modify existing choices of variant parameter object
`removeChoice` Remove choices from variant parameter object

Specialized Operators and Functions

These methods specialize standard MATLAB operators and functions for objects in this class.

| | |
|-----------------------|---|
| <code>bitcmp</code> | Performs bit-wise complement on input. |
| <code>eq</code> | Compares if the inputs are equal. |
| <code>gt</code> | Compares if the first input is greater than the second input. |
| <code>mrdivide</code> | Divides the first input by the second input. |
| <code>or</code> | Performs a logical OR on inputs. |
| <code>uminus</code> | Negates the input. |
| <code>bitor</code> | Performs bit-wise OR on inputs. |
| <code>ge</code> | Compares if the first input is greater than or equal to the second input. |
| <code>le</code> | Compares if the first input is less than or equal to the second input. |
| <code>mtimes</code> | Multiplies the inputs. |

| | |
|----------|--|
| plus | Adds the inputs. |
| uplus | Returns the value of the input. |
| and | Performs logical AND on inputs. |
| bitshift | Shift bits by specified number of places. |
| lt | Compares if the first input is less than the second input. |
| ne | Compares if the inputs are not equal. |
| bitand | Performs bit-wise AND on inputs. |
| bitxor | Performs bit-wise XOR on inputs. |
| minus | Subtracts the second input from the first input. |
| not | Returns logical NOT of input. |

Examples

Scalar Values for Rapid Prototyping of Variant Parameters

Scalar MATLAB® variables allow you to rapidly prototype variant values when you are still building your model. They help you focus more on building your variant values than on developing the expressions that activate those choices.

You can define scalar control variables in locations listed in “Storage Locations for Variant Control Variables (Operands) in Variant Condition Expressions”.

In the MATLAB Editor, specify variant choices in their simplest form as scalar variables in a `Simulink.VariantVariable` object.

```
vpObj = Simulink.VariantVariable('Choices',{ 'VCtrl==1', 1000, 'VCtrl==2', 2000})
```

```
vpObj =  
VariantVariable with 2 choices:
```

| Condition | Value |
|------------|-------|
| VCtrl == 1 | 1000 |
| VCtrl == 2 | 2000 |

```
Specification: ''
```

```
Use getChoice, setChoice, addChoice, removeChoice to access, modify, add or  
remove choices
```

Activate one of the variant values by defining a control variable, `VCtrl`, and setting its value to 1 in a `Simulink.VariantControl` object. This condition activates the value 1000 and assigns this value to `vpObj`.

```
VCtrl = Simulink.VariantControl('Value', 1, 'ActivationTime', 'update diagram')
```

```
VCtrl =  
VariantControl with properties:
```

```
Value: 1
ActivationTime: 'update diagram'
```

If you change the value of `VCtrl` to 2, Simulink® sets the value of `vpObj` to 2000.

```
VCtrl.Value = 2;
```

Simulink.Parameter Objects for Code Generation of Variant Parameters

If you intend to generate code for a model containing variant parameter values, specify variant control variables as MATLAB® variables or `Simulink.Parameter` objects. `Simulink.Parameter` objects allow you to specify other attributes (such as data type) that are required for generating code.

Note:

- You can define a variant control variable of type `Simulink.Parameter` only in the base workspace or in a data dictionary. Defining `Simulink.Parameter` type of variant control variables in the mask or model workspace is not supported. For more information on storage locations for variant control variables, see “Storage Locations for Variant Control Variables (Operands) in Variant Condition Expressions”.
- `Simulink.Parameter` objects within structures and that have data types other than `Simulink.Bus` objects are not supported.

In the MATLAB Editor, define a `Simulink.Parameter` object.

```
VSSMODE = Simulink.Parameter;
VSSMODE.Value = 1;
VSSMODE.DataType = 'int32';
VSSMODE.CoderInfo.StorageClass = 'Custom';
VSSMODE.CoderInfo.CustomStorageClass = 'ImportedDefine';
VSSMODE.CoderInfo.CustomAttributes.HeaderFile = 'rtwdemo_importedmacros.h';
```

Variant control variables defined as `Simulink.Parameter` objects can have one of these storage classes:

- Define or ImportedDefine with header file specified
- CompilerFlag
- SystemConstant (AUTOSAR)
- Your own storage class that defines data as a macro

You can also convert a scalar variant control variable into a `Simulink.Parameter` object. For more information, see [Convert Variant Control Variables into Simulink.Parameter Objects](#).

Specify the object as a variant control using a `Simulink.VariantVariable` object.

```
vpObj = Simulink.VariantVariable('Choices', {'VCtrl == 1',1000,'VCtrl == 2',2000});
```

Activate one of the variant values by defining a control variable `VCtrl` and setting its value to `VSSMODE` in a `Simulink.VariantControl` object. This condition activates the value 1000 and assigns this value to `vpObj`.

```
VCtrl = Simulink.VariantControl('Value',VSSMODE,'ActivationTime','code compile')
```

```
VCtrl =
  VariantControl with properties:

      Value: [1x1 Simulink.Parameter]
  ActivationTime: 'code compile'
```

Simulink.Variant Objects for Variant Condition Reuse of Variant Parameters

After identifying the variant values that your model requires, you can construct complex variant conditions to control the activation of your variant parameter values by defining variant conditions as `Simulink.Variant` objects. `Simulink.Variant` objects enable you to reuse common variant conditions across models and help you encapsulate complex variant condition expressions.

Note:

- You can define a variant control variable of type `Simulink.Variant` only in the base workspace or in a data dictionary. Defining `Simulink.Variant` type of variant control variables in the mask or model workspace is not supported. For more information on storage locations for variant control variables, see “Storage Locations for Variant Control Variables (Operands) in Variant Condition Expressions”.
- `Simulink.Variant` within structures are not supported.

In the MATLAB® Editor, encapsulate variant control expressions as `Simulink.Variant` objects.

```
LinearController=Simulink.Variant('VCtrl==1');
NonLinearController=Simulink.Variant('VCtrl==2');
```

Specify the `Simulink.Variant` objects as the variant controls in a `Simulink.VariantVariable` object.

```
vpObj = Simulink.VariantVariable('Choices',{ 'LinearController',1000,'NonLinearController',2000})
```

```
vpObj =
  VariantVariable with 2 choices:
```

| Condition | Value |
|---------------------|-------|
| LinearController | 1000 |
| NonLinearController | 2000 |

```
Specification: ''
```

Use `getChoice`, `setChoice`, `addChoice`, `removeChoice` to access, modify, add or remove choices

Activate one of the variant values by defining a control variable, `VCtrl`, and setting its value to `LinearController` in a `Simulink.VariantControl` object. This condition activates the value 1000 and assigns this value to `vpObj`.

```
VCtrl = Simulink.VariantControl('Value',1,'ActivationTime','update diagram')
```



```
VCtrl =  
  VariantControl with properties:  
  
      Value: 1  
  ActivationTime: 'update diagram'
```

Using this approach, you can develop complex variant condition expressions that are reusable.

See Also

`Simulink.VariantControl`

Topics

“Change Active Values and Activation Time of Variant Parameters”

“Compile Code Conditionally for all Values of Variant Parameters”

“Use Variant Parameters to Reuse Block Parameters with Different Values”

“Create a Simple Variant Parameter Model”

Introduced in R2021a

Model and Block Parameters

- “Programmatic Model Editor Appearance Parameters” on page 6-2
- “Internal Programmatic Model Settings” on page 6-9
- “Common Block Properties” on page 6-12
- “Block-Specific Parameters” on page 6-26
- “Mask Parameters” on page 6-131

Programmatic Model Editor Appearance Parameters

Use the following parameters to control how your model appears in the Simulink editor. To query and/or modify the value of a parameter, use `get_param` or `set_param`.

Model Appearance Parameters

| Parameter | Description | Values |
|--|---|--|
| BlockNameDataTip | Specifies whether to display the block name as a data tip. In the Simulink Editor, in the Debug tab, select Information Overlays > Name in Tooltip . | 'on' {'off'} |
| BlockParametersDataTip | Specifies whether to display a block parameter in a data tip. In the Simulink Editor, in the Debug tab, select Information Overlays > Parameters in Tooltip . | 'on' {'off'} |
| BlockDescription-StringDataTip | Specifies whether to display the user description for a block as a data tip. In the Simulink Editor, in the Debug tab, select Information Overlays > Description in Tooltip . | 'on' {'off'} |
| BrowserLookUnderMasks | Show masked subsystems in the Model Browser. On the Modeling tab, select Environment > Model Browser . In the Model Browser pane, click  and select Systems with Mask Parameters . | 'on' {'off'} |
| BrowserShowLibraryLinks | Show library links in the Model Browser. On the Modeling tab, select Environment > Model Browser . In the Model Browser pane, click  and select Library Links . | 'on' {'off'} |
| CompiledModelBlockNormalModeVisibility | For a top model that is being simulated or that is in a compiled state, return information about which Model blocks have normal mode visibility enabled. | Return values indicate which Model blocks have normal mode visibility enabled. |

| Parameter | Description | Values |
|--|--|-----------------------|
| DefaultAnnotationFontName DefaultBlockFontName DefaultLineFontName | Name of font to use for new annotation text, block text, or signal line labels and on existing annotations, block names, or signal lines whose FontName property is set to 'auto'. To set, on the Format tab, click the Font Properties button arrow, then click Fonts for Model . | character vector |
| DefaultAnnotationFontSize DefaultBlockFontSize DefaultLineFontSize | Size of font to use for new annotation text, block text, or signal line labels and on existing annotations, blocks, or signal lines whose FontSize property is set to -1. To set, on the Format tab, click the Font Properties button arrow, then click Fonts for Model . | positive integer |
| DefaultAnnotationFontAngle DefaultBlockFontAngle DefaultLineFontAngle | Angle of font for new annotation text, block text, or signal line labels and on existing annotations, blocks, or signal lines whose FontAngle property is set to 'auto'. To set, on the Format tab, click the Font Properties button arrow, then click Fonts for Model . | {'normal'} 'italic' |
| DefaultAnnotationFontWeight DefaultBlockFontWeight DefaultLineFontWeight | Weight of font for new annotation text, block text, or signal line labels and on existing annotations, blocks, or signal lines whose FontWeight property is set to 'auto'. To set, on the Format tab, click the Font Properties button arrow, then click Fonts for Model . | {'normal'} 'bold' |
| HideAutomaticNames | Hides block names given automatically by the Simulink Editor. See "Hide or Display Block Names". | {'on'} 'off' |

| Parameter | Description | Values |
|---|---|---|
| LineUpdate | <p>Specifies when to update line routing to avoid overlapping lines and obstacles in the model.</p> <p>When set to the default 'deferred', scripts postpone line routing until they pause or complete. To perform deferred line routing within a script, you can use function <code>Simulink.BlockDiagram.routeLine</code>.</p> | {'deferred'} 'none' 'immediate' |
| ModelBrowserVisibility | <p>Show the Model Browser.</p> <p>In the Simulink Editor, in the Modeling tab, select Environment > Model Browser.</p> | 'on' {'off'} |
| ModelBrowserWidth | <p>Width of the Model Browser pane in the model window. To display the Model Browser pane, see the <code>ModelBrowserVisibility</code> parameter.</p> | integer — {200} |
| ModelBlockNormalModeVisibility | <p>Use with <code>set_param</code> to set normal mode visibility on for the specified Model blocks.</p> <p>You can set this parameter with the Model Block Normal Mode Visibility dialog box. For details, see “Specify the Instance Having Normal Mode Visibility”.</p> | <p>With <code>set_param</code>, use an array of <code>Simulink.BlockPath</code> objects or cell array of cell arrays of character vectors of paths to blocks or models.</p> <p>With <code>set_param</code>, an empty array specifies to use the Simulink default selection for the instance to have normal mode visibility enabled.</p> |
| ModelBlockNormalModeVisibilityBlockPath | <p>Return information about which Model blocks have normal mode visibility enabled. Use with a model that you are editing.</p> | <p>Return values indicate which Model blocks have normal mode visibility enabled. See “Simulate Multiple Referenced Model Instances in Normal Mode”.</p> |
| PortDataTypeDisplayFormat | <p>When you display port data types in a model, choose whether to display data type aliases, base data types, or both.</p> <p>In the Simulink Editor, in the Debug tab, set by Information Overlays > Base Data Types and Information Overlays > Alias Data Types.</p> | {'AliasTypeOnly'} 'BaseTypeOnly' 'BaseAndAliasTypes' |

| Parameter | Description | Values |
|---------------------------------|---|---|
| ReqHilite | Highlights all the blocks in the Simulink diagram that have requirements associated with them. In the Simulink Editor, in the Apps tab, under Verification, Validation, and Test , click Requirements Viewer . The Requirements Viewer tab appears. Click Highlight Links . | 'on' {'off'} |
| SampleTimeAnnotations | In the Simulink Editor, in the Debug tab, select Information Overlays > Text . | 'on' {'off'} |
| SampleTimeColors | In the Simulink Editor, in the Debug tab, select Information Overlays > Colors . | 'on' {'off'} |
| ScreenColor | Background color of the model window. In the Simulink Editor, on the Format tab, set Background . | 'black' {'white'} 'red' 'green' 'blue' 'cyan' 'magenta' 'yellow' 'gray' 'lightBlue' 'orange' 'darkGreen' [r,g,b,a] where r, g, b, and a are the red, green, blue, and alpha values of the color normalized to the range 0.0 to 1.0. The alpha value is ignored. |
| ShowLinearization-Annotations | Toggles linearization icons in the model. | {'on'} 'off' |
| ShowLineDimensions | Show signal dimensions on this model's block diagram. In the Simulink Editor, on the Debug tab, select Information Overlays > Signal Dimensions . | 'on' {'off'} |
| ShowLoopsOnError | Highlight invalid loops graphically. | {'on'} 'off' |
| ShowModelReferenceBlockIO | Toggles display of I/O mismatch on block. In the Simulink Editor, in the Debug tab, select Information Overlays > Ref. Model I/O Mismatch . | 'on' {'off'} |
| ShowModelReference-BlockVersion | Toggles display of version on block. In the Simulink Editor, in the Debug tab, select Information Overlays > Ref. Model Version . | 'on' {'off'} |

| Parameter | Description | Values |
|--------------------|--|----------------|
| ShowPageBoundaries | <p>Toggles display of page boundaries on the Simulink Editor canvas.</p> <p>In the Simulink Editor, in the Simulation tab, select Print > Show Page Boundaries.</p> | 'on' {'off'} |
| ShowPortDataTypes | <p>Show data types of ports on this model's block diagram.</p> <p>In the Simulink Editor, in the Debug tab, select Information Overlays > Base Data Types.</p> | 'on' {'off'} |
| ShowPortUnits | <p>Show units of ports, subsystem, and model block icons on the model block diagram.</p> <p>In the Simulink Editor, in the Debug tab, select Information Overlays > Port Units.</p> | 'on' {'off'} |
| ShowStorageClass | <p>Show storage classes of signals on this model's block diagram.</p> <p>In the Simulink Editor, in the Debug tab, select Information Overlays > Storage Class.</p> | 'on' {'off'} |
| ShowTestPointIcons | <p>Show test point icons on this model's block diagram.</p> <p>In the Simulink Editor, in the Debug tab, select Information Overlays > Log & Testpoint.</p> | {'on'} 'off' |
| ShowViewerIcons | <p>Show viewer icons on this model's block diagram.</p> <p>In the Simulink Editor, in the Debug tab, select Information Overlays > Viewers.</p> | {'on'} 'off' |
| SortedOrder | <p>Show the sorted order of this model's blocks on the block diagram.</p> <p>In the Simulink Editor, in the Debug tab, select Information Overlays > Execution Order.</p> | 'on' {'off'} |

| Parameter | Description | Values |
|------------|--|--|
| ZoomFactor | <p>Zoom factor of the Simulink Editor window expressed as a percentage of normal (100%) or by the keywords FitSystem or FitSelection.</p> <p>In the Simulink Editor, on the Modeling tab, select one of the options under Environment > Zoom.</p> | {'100'} 'FitSystem' 'FitSelection' |
| WideLines | <p>Draws lines that carry vector or matrix signals wider than lines that carry scalar signals.</p> <p>In the Simulink Editor, on the Debug tab, select Information Overlays > Nonscalar Signals.</p> | 'on' {'off'} |

See Also

set_param | get_param

Internal Programmatic Model Settings

The following model parameters are reserved for MathWorks internal use only.

Internal Model Parameters

| |
|--------------------------------|
| CurrentBlock |
| CurrentOutputPort |
| DiscreteInheritContinuousMsg |
| DisplayBdSearchResults |
| DisplayBlockIO |
| DisplayCallgraphDominators |
| DisplayCompileStats |
| DisplayCondStIdTree |
| DisplayErrorDirections |
| DisplayInvisibleSources |
| DisplaySortedLists |
| DisplayVectorAndFunctionCounts |
| DisplayVectPropagationResults |
| FixPtInfo |
| ForceArrayBoundsChecking |
| ForceConsistencyChecking |
| ForceModelCoverage |
| ForwardingTableString |
| HiliteAncestors |
| IgnoreBidirectionalLines |
| Jacobian |
| LibraryType |
| LinearizationMsg |
| Lines |
| Location |
| MinMaxOverflowArchiveData |
| ModelDataFile |
| ModelReferenceTargetType |
| Open |
| ParamWorkspaceSource |
| RequirementInfo |
| SaveDefaultBlockParams |
| ScrollbarOffset |
| ShowLineDimensionsOnError |
| Shown |
| ShowPortDataTypesOnError |

| |
|------------------|
| UseAnalysisPorts |
| ZeroCross |

Common Block Properties

| In this section... |
|---|
| "About Common Block Properties" on page 6-12 |
| "Examples of Setting Block Properties" on page 6-25 |

About Common Block Properties

This table lists the properties common to all Simulink blocks, including block callback properties (see "Callbacks for Customized Model Behavior"). Examples of commands that change these properties follow this table (see "Examples of Setting Block Properties" on page 6-25).

Common Block Properties

| Property | Description | Values |
|------------------------|---|---|
| AncestorBlock | Name of the library block that the block is linked to (for blocks with a disabled link). | character vector |
| AttributesFormatString | Block annotation text (corresponds to block properties). | character vector |
| BackgroundColor | Block background color. | color value <code>'[r,g,b]'</code> <code>'[r,g,b,a]'</code> r, g, and b, are the red, green, blue values of the color in the range 0.0 to 1.0. If specified, the alpha value (a) is ignored. Possible color values are 'black', 'white', 'red', 'green', 'blue', 'cyan', 'magenta', 'yellow', 'gray', 'lightBlue', 'orange', 'darkGreen'. |
| BlockDescription | Block description shown at the top of the block parameters dialog box or property inspector. | character array |
| BlockType | Block type (read-only). | character array |
| BlockKeywords | Associates one or more keywords with a custom library block. | character vector string scalar string array |
| ClipboardFcn | Function called when block is copied to the clipboard (Ctrl+C) or when the menu item Copy is selected. | function character vector |
| CloseFcn | Function called when <code>close_system</code> is run on block. | function character vector |
| Commented | Exclude block from simulation. | {'off'} 'on' 'through' |
| CompiledBusType | Returns whether the signal connected to a port is not a bus, is a virtual, or is a nonvirtual bus (read-only). Specify a port or line handle when using <code>get_param</code> . For example: <code>ports = get_param(gcb,'PortHandles');</code> <code>feval(gcs,[],[],[],'compile');</code> <code>bt = get_param(ports.Outport,'CompiledBusType')</code> See "Display Bus Information". | 'NOT_BUS' 'VIRTUAL_BUS' 'NON_VIRTUAL_BUS' |

| Property | Description | Values |
|----------------------------|--|-----------------|
| CompiledIsActive | <p>Specifies whether the block status is active or not at compile time.</p> <p>CompiledIsActive returns off if any one of these conditions is true at compile time:</p> <ul style="list-style-type: none"> • Block is inactive path of Inline Variant. • Block is inactive choice of Variant Subsystem. • Block is commented out is within a Subsystem block that is commented out. • Block is inactive due to condition propagated from Variant Subsystem block. <p>CompiledIsActive returns off for inactive choices and returns on for active choices of Variant Subsystem.</p> | 'off' 'on' |
| CompiledPortComplexSignals | <p>Complexity of port signals after updating diagram. You must compile the model before querying this property. For example:</p> <pre>vdp([],[],[],'compile'); d = get_param(gcf,'CompiledPortComplexSignals'); vdp([],[],[],'term');</pre> | structure array |
| CompiledPortDataTypes | <p>Data types of port signals after updating diagram. You must compile the model before querying this property. See CompiledPortComplexSignals .</p> | structure array |
| CompiledPortDesignMin | <p>Design minimum of port signals after updating diagram. You must compile the model before querying this property. For example:</p> <pre>feval(gcs, [],[],[],'compile'); ports = get_param(gcf,'PortHandles'); min = get_param(ports.Outport, 'CompiledPortDesignMin') feval(model, [],[],[],'term');</pre> | structure array |

| Property | Description | Values |
|----------------------------|---|--|
| CompiledPortDesignMax | Design maximum of port signals at compile time. You must compile the model before querying this property. For example: <pre>feval(gcs, [], [], [], 'compile'); ports = get_param(gcb, 'PortHandles'); max = get_param(ports.Outport, 'CompiledPortDesignMax'); feval(model, [], [], [], 'term');</pre> | structure array |
| CompiledPortDimensions | Dimensions of port signals after updating diagram. You must compile the model before querying this property. For details, see “Get Compiled Port Dimensions”. | numeric array |
| CompiledPortDimensionsMode | Indication whether the port signal has a variable size (after updating diagram). You must compile the model before querying this property. See “Determine Whether Signal Line Has Variable Size”. | double number. 0 indicates the signal does not have a variable size. 1 indicates the signal has a variable size. |
| CompiledPortFrameData | Frame mode of port signals after updating diagram. You must compile the model before querying this property. | structure array |
| CompiledPortWidths | Structure of port widths after updating diagram. You must compile the model before querying this property. | structure array |
| CompiledSampleTime | Block sample time after updating diagram. You must compile the model before querying this property. | vector [sample time, offset time] or cell {[sample time 1, offset time 1]; [sample time 2, offset time 2]; ... [sample time n, offset time n]} |
| ContinueFcn | Function called at the restart of a simulation (after a pause). | function character vector |
| CopyFcn | Function called when block is copied. See “Block Callback Parameters” for details. | function character vector |
| DataTypeOverrideCompiled | For internal use. | |
| DeleteFcn | Function called when block is deleted. See “Block Callback Parameters” for details. | MATLAB expression |

| Property | Description | Values |
|-------------------------|---|---|
| DestroyFcn | Function called when block is destroyed. See “Block Callback Parameters” for details. | MATLAB expression |
| Description | Description of block. Set by the Description field in the General pane of the Block Properties dialog box. | text and tokens |
| Diagnostics | For internal use. | |
| DialogParameters | List of names/attributes of block-specific parameters for an unmasked block, or mask parameters for a masked block. | structure |
| DropShadow | Display drop shadow. | {'off'} 'on' |
| ExtModeLoggingSupported | Enable a block to support uploading of signal data in external mode (for example, with a scope block). | {'off'} 'on' |
| ExtModeLoggingTrig | Enable a block to act as the trigger block for external mode signal uploading. | {'off'} 'on' |
| ExtModeUploadOption | Enable a block to upload signal data in external mode when the Select all check box on the External Signal & Triggering dialog box is not selected. A value of <code>log</code> indicates the block uploads signals. A value of <code>none</code> indicates the block does not upload signals. The value <code>monitor</code> is currently not in use. If the Select all check box on the External Signal & Triggering dialog box is selected, it overrides this parameter setting. | {'none'} 'log' 'monitor' |
| FontAngle | Font angle. | 'normal' 'italic' 'oblique' {'auto'} |
| FontName | Font name. | character array |
| FontSize | Font size. A value of -1 specifies that this block inherits the font size specified by the <code>DefaultBlockFontSize</code> model parameter. | real {'-1'} |
| FontWeight | Font weight. | 'light' 'normal' 'demi' 'bold' {'auto'} |

| Property | Description | Values |
|-------------------|--|--|
| ForegroundColor | Foreground color of block icon. | color value '[r,g,b]' '[r,g,b,a]' r, g, and b, are the red, green, blue values of the color in the range 0.0 to 1.0. The value changes if it is too similar to the canvas color (ScreenColor parameter). Use get_param to return the actual value. If specified, the alpha value (a) is ignored. Possible color values are 'black', 'white', 'red', 'green', 'blue', 'cyan', 'magenta', 'yellow', 'gray', 'lightBlue', 'orange', 'darkGreen'. |
| Handle | Block handle. | real |
| HideAutomaticName | Specify whether the block name given automatically by the Simulink Editor displays in the model. To hide automatic names, use the default setting of 'on'. (The HideAutomaticNames parameter for the model must also be set to 'on'.) Set to 'off' to display the name, and also set the block ShowName parameter to 'on'. Blocks whose ShowName parameter is 'off' are hidden regardless of this setting. For more information on how the parameters interact, see "Hide or Display Block Names". | {'on'} 'off' |
| HiliteAncestors | For internal use. | |
| InitFcn | Initialization function for a block. Created on the Callbacks pane of the Model Properties dialog box. For more information, see "Create Model Callbacks". On non-masked blocks, updating the diagram or running the simulation call this function. | MATLAB expression |
| InputSignalNames | Names of input signals. | cell array |

| Property | Description | Values |
|---------------------------------|--|--|
| IntrinsicDialogParameters | List of names/attributes of block-specific parameters (regardless of whether the block is masked or unmasked). Use instead of <code>DialogParameters</code> if you want block-specific parameters for masked or unmasked blocks. | structure |
| IOSignalStrings | Block paths to objects that are connected to the Signal & Scope Manager. Simulink software saves these paths when the model is saved. | list |
| IOType | Signal & Scope Manager type. For internal use. | |
| IsStateOwnerBlock | Indicates whether the block is a supported state owner block that can be used with the State Reader and State Writer blocks (read-only). See State Reader and State Writer. | 'off' 'on' |
| LibraryVersion | For a linked block, the initial value of this property is the <code>ModelVersion</code> of the library at the time the link was created. The value updates with increments in the model version of the library. | character vector — {'1.1'} |
| LineHandles | Handles of lines connected to block. | structure |
| LinkData | Array of details about changes to the blocks inside the link that differ between a parameterized link and its library, listing the block names and parameter values. Use [] to reset to deparameterized, e.g., <code>set_param(gcb, 'linkData', [])</code> . | cell array |
| LinkStatus | Link status of block. Updates out-of-date linked blocks when queried using <code>get_param</code> . See “Control Linked Block Programmatically”. | 'none' 'resolved' 'unresolved' 'implicit' 'inactive' 'restore' 'propagate' 'propagateHierarchy' 'restoreHierarchy' |
| LoadFcn | Function called when block is loaded. | MATLAB expression |
| MinMaxOverflow-Logging_Compiled | For internal use. | |

| Property | Description | Values |
|---------------------|---|------------------------------------|
| ModelCloseFcn | Function called when model is closed. The ModelCloseFcn is called prior to the block's DeleteFcn and DestroyFcn callbacks, if either are set. | MATLAB expression |
| ModelParamTableInfo | For internal use. | |
| MoveFcn | Function called when block is moved. | MATLAB expression |
| Name | Block or signal name. To specify a signal name, use the corresponding port or line handle. <code>ports = get_param(gcf, 'PortHandles');</code> <code>set_param(ports.Outputport(1), 'Name', 'NewName');</code> Alternatively, to name an output signal of a block, you can use SignalNameFromLabel. | character vector |
| NameChangeFcn | Function called when block name is changed. | MATLAB expression |
| NamePlacement | Position of block name. | {'normal'} 'alternate' |
| ObjectParameters | Names/attributes of block's parameters. | structure |
| OpenFcn | Function called when this Block Parameters dialog box opens. | MATLAB expression |
| Orientation | Where block faces. | {'right'} 'left' 'up' 'down' |
| OutputSignalNames | Names of output signals. | cell array |
| Parent | Name of the system that owns the block. | character vector {'untitled'} |
| ParentCloseFcn | Function called when parent subsystem is closed. The ParentCloseFcn of blocks at the root model level is not called when the model is closed. | MATLAB expression |
| PauseFcn | Function called at the pause of a simulation. | function character vector |

| Property | Description | Values |
|------------------|--|-----------------|
| PortConnectivity | <p>The value of this property is an array of structures, each of which describes one of the block's input or output ports. Each port structure has the following fields:</p> <ul style="list-style-type: none"> • Type Specifies the port's type and/or number. The value of this field can be: <ul style="list-style-type: none"> • n, where n is the number of the port for data ports • 'enable' if the port is an enable port • 'trigger' if the port is a trigger port • 'state' for state ports • 'ifaction' for action ports • 'LConn#' for a left connection port where # is the port's number • 'RConn#' for a right connection port where # is the port's number • Position The value of this field is a two-element vector, $[x\ y]$, that specifies the port's position. • SrcBlock Handle of the block connected to this port. This field is null for output ports and -1 for unconnected input ports. SrcBlock property is a valid source handle for Variant Subsystem blocks. • SrcPort Number of the port connected to this port, starting at zero. This field is null for both output ports and unconnected input ports. • DstBlock Handle of the block to which this port is connected. This field is | structure array |

| Property | Description | Values |
|----------|---|--------|
| | <p>null for input ports and contains a 1-by-0 empty matrix for unconnected output ports.</p> <ul style="list-style-type: none"><li data-bbox="570 394 727 426">• DstPort <p>Number of the port to which this port is connected, starting at zero. This field is null for input ports and contains a 1-by-0 empty matrix for unconnected output ports. For Simscape blocks, the field contains port handles.</p> | |

| Property | Description | Values |
|------------------|--|------------------------|
| PortHandles | <p>The value of this property is a structure that specifies the handles of the block's ports. The structure has the following fields:</p> <ul style="list-style-type: none"> • Inport Handles of the block's input ports. • Outputport Handles of the block's output ports. • Enable Handle of the block's enable port. • Trigger Handle of the block's trigger port. • State Handle of the block's state port. • LConn Handles of the block's left connection ports (for blocks that support Physical Modeling tools). • RConn Handles of the block's right connection ports (for blocks that support Physical Modeling tools). • Ifaction Handle of the block's action port. • Reset Handle of the block's reset port. | structure array |
| PortRotationType | Type of port rotation used by this block (read-only). | 'default' 'physical' |

| Property | Description | Values |
|----------------|---|---|
| Ports | <p>A vector that specifies the number of each kind of port this block has. The order of the vector's elements corresponds to the following port types:</p> <ul style="list-style-type: none"> • Inport • Outport • Enable • Trigger • State • LConn • RConn • Ifaction • Reset | vector |
| Position | <p>Position of block in model window.</p> <p>To help with block alignment, the position you set can differ from the actual block position by a few pixels. Use <code>get_param</code> to return the actual position.</p> | <p>vector of coordinates, in pixels: [left top right bottom]</p> <p>The origin is the upper-left corner of the Simulink Editor canvas before any canvas resizing. Supported coordinates are between -1073740824 and 1073740823, inclusive. Positive values are to the right of and down from the origin. Negative values are to the left of and up from the origin.</p> |
| PostSaveFcn | Function called after the block is saved. | MATLAB expression |
| PreCopyFcn | Function called before the block is copied. See "Block Callback Parameters" for details. | MATLAB expression |
| PreDeleteFcn | Function called before the block is deleted. See "Block Callback Parameters" for details. | MATLAB expression |
| PreSaveFcn | Function called before the block is saved. See "Block Callback Parameters" for details. | MATLAB expression |
| Priority | Specifies the block's order of execution relative to other blocks in the same model. Set by the Priority field on the General pane of the Block Properties dialog box. | character vector { ' ' } |
| ReferenceBlock | Name of the library block to which this block links. | character vector { ' ' } |

| Property | Description | Values |
|-------------------------------|--|---|
| RequirementInfo | For internal use. | |
| RTWData | User specified data, used by Simulink Coder software. Intended only for use with user written S-functions. See the section “S-Function RTWdata” (Simulink Coder) for details. | |
| SampleTime | Value of the sample time parameter. See “Specify Sample Time” for more details. | character vector |
| Selected | Status of whether or not block is selected. | {'on'} 'off' |
| ShowName | Display or hide block name. To display a block name given by the Simulink Editor (automatic names), set the block 'HideAutomaticName' parameter to 'off' and ShowName to 'on'. To hide an automatic block name given by the Editor, set ShowName to 'on', HideAutomaticName to 'on', and HideAutomaticNames on the model to 'on'. For more information on how the parameters interact, see “Hide or Display Block Names”. | {'on'} 'off' |
| SignalHierarchy | If the signal is a bus, returns the name and hierarchy of the signals in the bus (read-only). Specify a port or line handle when using <code>get_param</code> . For example: <code>ports = get_param(gcf, 'PortHandles');</code> <code>feval(gcs, [], [], [], 'compile');</code> <code>sh = get_param(ports.Outport, 'SignalHierarchy');</code> See “Display Bus Information”. | values reflect the structure of the signal that you specify |
| StartFcn | Function called at the start of a simulation. | MATLAB expression |
| StatePerturbation-ForJacobian | State perturbation size to use during linearization. See “Change Perturbation Level of Blocks Perturbed During Linearization” (Simulink Control Design) for details. | character vector |

| Property | Description | Values |
|----------------------------|---|---|
| StaticLinkStatus | Link status of block. Does not update out-of-date linked blocks when queried using <code>get_param</code> . See also <code>LinkStatus</code> . | 'none' 'resolved' 'unresolved' 'implicit' 'inactive' 'restore' 'propagate' 'propagateHierarchy' 'restoreHierarchy' |
| StopFcn | Function called at the termination of a simulation. | MATLAB expression |
| Tag | Text that appears in the block label that Simulink software generates. Set by the Tag field on the General pane of the Block Properties dialog box. | character vector {' '} |
| Type | Simulink object type (read-only). | 'block' |
| UndoDeleteFcn | Function called when block deletion is undone. | MATLAB expression |
| UserData | User-specified data that can have any MATLAB data type. | {'[]'} |
| UserDataPersistent | Status of whether or not <code>UserData</code> will be saved in the model file. | 'on' {'off'} |
| VariantConfigurationObject | Specifies the variant configuration object that is associated with the model. See “Export, Save, Refresh, and Load a Variant Configuration Data Object”. | {' '} The value is an empty character vector if no configuration object is associated; otherwise, it is the name of a <code>Simulink.VariantConfigurationData</code> object. |

Examples of Setting Block Properties

These examples illustrate how to change common block properties.

This command changes the orientation of the Gain block in the `myModel` system so it faces the opposite direction (right to left).

```
set_param('myModel/Gain','Orientation','left')
```

This command associates an `OpenFcn` callback with the Gain block in the `myModel` system.

```
set_param('myModel/Gain','OpenFcn','my_open_cb')
```

This command sets the `Position` property of the Gain block in the `myModel` system. The block is 75 pixels wide by 25 pixels high.

```
set_param('myModel/Gain','Position',[50 250 125 275])
```

Block-Specific Parameters

To write scripts that create and modify models, you can use the `get_param` and `set_param` functions to query and modify the properties and parameters of a block or diagram. Use the tables to determine the programmatic name of a parameter or property in a block dialog box.

- Continuous Library Block Parameters on page 6-28
- Discontinuities Library Block Parameters on page 6-31
- Discrete Library Block Parameters on page 6-34
- Logic and Bit Operations Library Block Parameters on page 6-46
- Lookup Tables Library Block Parameters on page 6-49
- Math Operations Library Block Parameters on page 6-57
- Model Verification Library Block Parameters on page 6-74
- Model-Wide Utilities Library Block Parameters on page 6-77
- Ports & Subsystems Library Block Parameters on page 6-79
- Signal Attributes Library Block Parameters on page 6-103
- Signal Routing Library Block Parameters on page 6-108
- Sinks Library Block Parameters on page 6-115
- String Library Block Parameters
- Sources Library Block Parameters on page 6-119
- User-Defined Functions Library Block Parameters on page 6-127
- Additional Discrete Library Block Parameters on page 6-128
- Additional Math: Increment - Decrement Library Block Parameters on page 6-130

Programmatic Parameters of Blocks and Models

Programmatic parameters that describe a model are model parameters. Parameters that describe a block are block parameters. Parameters that are common to all Simulink blocks are common block parameters (see “Common Block Properties” on page 6-12). Many blocks also have unique block-specific parameters. A masked block can have mask parameters (see “Mask Parameters” on page 6-131).

The model and block properties also include callbacks, which are commands that execute when a certain model or block event occurs. These events include opening a model, simulating a model, copying a block, opening a block, etc. See “Model, Block, and Port Callbacks”.

Tip For block parameters that accept array values, the number of elements in the array cannot exceed what `int_T` can represent. This limitation applies to both simulation and Simulink Coder code generation.

The maximum number of characters that a parameter edit field can contain is 49,000.

Block-Specific Parameters and Programmatic Equivalents

The tables list block-specific parameters for Simulink blocks. The type of the block appears in parentheses after the block name. Some Simulink blocks work as masked subsystems. The tables indicate masked blocks by adding the designation "masked subsystem" after the block type.

The type listed for nonmasked blocks is the value of the `BlockType` parameter (see "Common Block Properties" on page 6-12). The type listed for masked blocks is the value of the `MaskType` parameter (see "Mask Parameters" on page 6-131).

The **Dialog Box Prompt** column indicates the text of the prompt for the parameter in the block dialog box. The **Values** column shows the type of value required (scalar, vector, variable), the possible values (separated with a vertical line), and the default value (enclosed in braces).

Continuous Library Block Parameters

| Block (Type)/Parameter | Dialog Box Prompt | Values |
|---|---|---|
| Derivative (Derivative) | | |
| CoefficientInTFApproximation | Coefficient c in the transfer function approximation $s/(c*s+1)$ used for linearization | {'inf'} |
| Integrator (Integrator) | | |
| ExternalReset | External reset | {'none'} 'rising' 'falling' 'either' 'level' 'level hold' |
| InitialConditionSource | Initial condition source | {'internal'} 'external' |
| InitialCondition | Initial condition | scalar or vector — {'0'} |
| LimitOutput | Limit output | {'off'} 'on' |
| UpperSaturationLimit | Upper saturation limit | scalar or vector — {'inf'} |
| LowerSaturationLimit | Lower saturation limit | scalar or vector — {'-inf'} |
| ShowSaturationPort | Show saturation port | {'off'} 'on' |
| ShowStatePort | Show state port | {'off'} 'on' |
| AbsoluteTolerance | Absolute tolerance | character vector, scalar, or vector — {'auto'} {'-1'} any real scalar or vector |
| IgnoreLimit | Ignore limit and reset when linearizing | {'off'} 'on' |
| ZeroCross | Enable zero-crossing detection | 'off' {'on'} |
| ContinuousStateAttributes | State Name | {' '} user-defined |
| WrapState | Wrap state | {'off'} 'on' |
| WrappedStateUpperValue | Upper value of wrapped state | scalar or vector — {'pi'} |
| WrappedStateLowerValue | Lower value of wrapped state | scalar or vector — {'-pi'} |
| Second-Order Integrator (SecondOrderIntegrator) | | |
| ICSourceX | Initial condition source x | {'internal'} 'external' |
| ICX | Initial condition x | scalar or vector — {'0'} |
| LimitX | Limit x | {'off'} 'on' |
| UpperLimitX | Upper limit x | scalar or vector — {'inf'} |
| LowerLimitX | Lower limit x | scalar or vector — {'-inf'} |
| WrapStateX | Enable wrapping of x | {'off'} 'on' |
| WrappedUpperValueX | Upper value for wrapping x | scalar or vector — {'pi'} |
| WrappedLowerValueX | Lower value for wrapping x | scalar or vector — {'-pi'} |
| AbsoluteToleranceX | Absolute tolerance x | character vector, scalar, or vector — {'auto'} {'-1'} any real scalar or vector |
| StateNameX | State name x | { } user-defined |

| Block (Type)/Parameter | Dialog Box Prompt | Values |
|---|---|---|
| ICSourceDXDT | Initial condition source dx/dt | {'internal'} 'external' |
| ICDXDT | Initial condition dx/dt | scalar or vector — {'0'} |
| LimitDXDT | Limit dx/dt | {'off'} 'on' |
| UpperLimitDXDT | Upper limit dx/dt | scalar or vector — {'inf'} |
| LowerLimitDXDT | Lower limit dx/dt | scalar or vector — {'-inf'} |
| AbsoluteToleranceDXDT | Absolute tolerance dx/dt | character vector, scalar, or vector — {'auto'} {'-1'} any real scalar or vector |
| StateNameDXDT | State name dx/dt | { } user-defined |
| ExternalReset | External reset | {'none'} 'rising' 'falling' 'either' |
| ZeroCross | Enable zero-crossing detection | {'on'} 'off' |
| ReinitDXDTwhenXreachesSaturation | Reinitialize dx/dt when x reaches saturation | {'off'} 'on' |
| IgnoreStateLimitsAndResetForLinearization | Ignore state limits and the reset for linearization | {'off'} 'on' |
| ShowOutput | Show output | {'both'} 'x' 'dxdt' |
| State-Space (StateSpace) | | |
| A | A | matrix — {'1'} |
| B | B | matrix — {'1'} |
| C | C | matrix — {'1'} |
| D | D | matrix — {'1'} |
| InitialCondition | Initial conditions | vector — {'0'} |
| AbsoluteTolerance | Absolute tolerance | character vector, scalar, or vector — {'auto'} {'-1'} any real scalar or vector |
| ContinuousStateAttributes | State Name | {' '} user-defined |
| Transfer Fcn (TransferFcn) | | |
| Numerator | Numerator coefficients | vector or matrix — {'[1]'} |
| Denominator | Denominator coefficients | vector — {'[1 1]'} |
| AbsoluteTolerance | Absolute tolerance | character vector, scalar, or vector — {'auto'} {'-1'} any real scalar or vector |
| ContinuousStateAttributes | State Name | {' '} user-defined |
| Transport Delay (TransportDelay) | | |
| DelayTime | Time delay | scalar or vector — {'1'} |
| InitialOutput | Initial output | scalar or vector — {'0'} |
| BufferSize | Initial buffer size | scalar — {'1024'} |
| FixedBuffer | Use fixed buffer size | {'off'} 'on' |

| Block (Type)/Parameter | Dialog Box Prompt | Values |
|--|--|---|
| TransDelayFeedthrough | Direct feedthrough of input during linearization | {'off'} 'on' |
| PadeOrder | Pade order (for linearization) | {'0'} |
| Variable Time Delay (VariableTimeDelay) | | |
| VariableDelayType | Select delay type | 'Variable transport delay' {'Variable time delay'} |
| MaximumDelay | Maximum delay | scalar or vector — {'10'} |
| InitialOutput | Initial output | scalar or vector — {'0'} |
| MaximumPoints | Initial buffer size | scalar — {'1024'} |
| FixedBuffer | Use fixed buffer size | {'off'} 'on' |
| ZeroDelay | Handle zero delay | {'off'} 'on' |
| TransDelayFeedthrough | Direct feedthrough of input during linearization | {'off'} 'on' |
| PadeOrder | Pade order (for linearization) | {'0'} |
| ContinuousStateAttributes | State Name | {' '} user-defined |
| Variable Transport Delay (VariableTransportDelay) | | |
| VariableDelayType | Select delay type | {'Variable transport delay'} 'Variable time delay' |
| MaximumDelay | Maximum delay | scalar or vector — {'10'} |
| InitialOutput | Initial output | scalar or vector — {'0'} |
| MaximumPoints | Initial buffer size | scalar — {'1024'} |
| FixedBuffer | Use fixed buffer size | {'off'} 'on' |
| TransDelayFeedthrough | Direct feedthrough of input during linearization | {'off'} 'on' |
| PadeOrder | Pade order (for linearization) | {'0'} |
| AbsoluteTolerance | Absolute tolerance | character vector, scalar, or vector — {'auto'} {'-1'} any positive real scalar or vector |
| ContinuousStateAttributes | State Name | {' '} user-defined |
| Zero-Pole (ZeroPole) | | |
| Zeros | Zeros | vector — {'[1]'} vector — {'[0 -1]'} vector — {'[1]'} character vector, scalar, or vector — {'auto'} {'-1'} any positive real scalar or vector |
| Poles | Poles | |
| Gain | Gain | |
| AbsoluteTolerance | Absolute tolerance | |
| ContinuousStateAttributes | State Name | {' '} user-defined |

Discontinuities Library Block Parameters

| Block (Type)/Parameter | Dialog Box Prompt | Values |
|---|--|-----------------------------------|
| Backlash (Backlash) | | |
| BacklashWidth | Deadband width | scalar or vector — {'1'} |
| InitialOutput | Initial output | scalar or vector — {'0'} |
| ZeroCross | Enable zero-crossing detection | 'off' {'on'} |
| SampleTime | Sample time (-1 for inherited) | {'-1'} |
| Coulomb & Viscous Friction (Coulombic and Viscous Friction) (masked subsystem) | | |
| offset | Coulomb friction value (Offset) | {'[1 3 2 0]'} |
| gain | Coefficient of viscous friction (Gain) | {'1'} |
| Dead Zone (DeadZone) | | |
| LowerValue | Start of dead zone | scalar or vector — {'-0.5'} |
| UpperValue | End of dead zone | scalar or vector — {'0.5'} |
| SaturateOnIntegerOverflow | Saturate on integer overflow | 'off' {'on'} |
| LinearizeAsGain | Treat as gain when linearizing | 'off' {'on'} |
| ZeroCross | Enable zero-crossing detection | 'off' {'on'} |
| SampleTime | Sample time (-1 for inherited) | {'-1'} |
| Dead Zone Dynamic (Dead Zone Dynamic) (masked subsystem) | | |
| Hit Crossing (HitCross) | | |
| HitCrossingOffset | Hit crossing offset | scalar or vector — {'0'} |
| HitCrossingDirection | Hit crossing direction | 'rising' 'falling' {'either'} |
| ShowOutputPort | Show output port | 'off' {'on'} |
| ZeroCross | Enable zero-crossing detection | 'off' {'on'} |
| SampleTime | Sample time (-1 for inherited) | {'-1'} |
| Quantizer (Quantizer) | | |
| QuantizationInterval | Quantization interval | scalar or vector — {'0.5'} |
| LinearizeAsGain | Treat as gain when linearizing | 'off' {'on'} |
| SampleTime | Sample time (-1 for inherited) | {'-1'} |
| Rate Limiter (RateLimiter) | | |
| RisingSlewLimit | Rising slew rate | {'1'} |
| FallingSlewLimit | Falling slew rate | {'-1'} |
| SampleTimeMode | Sample time mode | 'continuous' {'inherited'} |
| InitialCondition | Initial condition | {'0'} |
| LinearizeAsGain | Treat as gain when linearizing | 'off' {'on'} |
| Rate Limiter Dynamic (Rate Limiter Dynamic) (masked subsystem) | | |
| Relay (Relay) | | |

| Block (Type)/Parameter | Dialog Box Prompt | Values |
|------------------------|--|--|
| OnSwitchValue | Switch on point | {'eps'} |
| OffSwitchValue | Switch off point | {'eps'} |
| OnOutputValue | Output when on | {'1'} |
| OffOutputValue | Output when off | {'0'} |
| ZeroCross | Enable zero-crossing detection | 'off' {'on'} |
| SampleTime | Sample time (-1 for inherited) | {'-1'} |
| OutMin | Output minimum | {'[]'} |
| OutMax | Output maximum | {'[]'} |
| OutDataTypeStr | Output data type | 'Inherit: Inherit via back propagation' {'Inherit: All ports same datatype'} 'double' 'single' 'int8' 'uint8' 'int16' 'uint16' 'int32' 'uint32' 'fixdt(1,16)' 'fixdt(1,16,0)' 'fixdt(1,16,2^0,0)' 'Enum: <class name>' |
| LockScale | Lock output data type setting against changes by the fixed-point tools | {'off'} 'on' |
| Saturation (Saturate) | | |
| UpperLimit | Upper limit | scalar or vector — {'0.5'} |
| LowerLimit | Lower limit | scalar or vector — {'-0.5'} |
| LinearizeAsGain | Treat as gain when linearizing | 'off' {'on'} |
| ZeroCross | Enable zero-crossing detection | 'off' {'on'} |
| SampleTime | Sample time (-1 for inherited) | {'-1'} |
| OutMin | Output minimum | {'[]'} |
| OutMax | Output maximum | {'[]'} |
| OutDataTypeStr | Output data type | 'Inherit: Inherit via back propagation' {'Inherit: Same as input'} 'double' 'single' 'int8' 'uint8' 'int16' 'uint16' 'int32' 'uint32' 'int64' 'uint64' 'fixdt(1,16,0)' 'fixdt(1,16,2^0,0)' |
| LockScale | Lock output data type setting against changes by the fixed-point tools | {'off'} 'on' |

| Block (Type)/Parameter | Dialog Box Prompt | Values |
|--|--|--|
| RndMeth | Integer rounding mode | 'Ceiling' 'Convergent' {'Floor'} 'Nearest' 'Round' 'Simplest' 'Zero' |
| Saturation Dynamic (Saturation Dynamic) (masked subsystem) | | |
| OutMin | Output minimum | {'[]'} |
| OutMax | Output maximum | {'[]'} |
| OutDataTypeStr | Output data type | {'Inherit: Same as second input'} 'double' 'single' 'int8' 'uint8' 'int16' 'uint16' 'int32' 'uint32' 'fixdt(1,16,0)' 'fixdt(1,16,2^0,0)' |
| OutputDataTypeScalingMode | Deprecated in R2007b | |
| OutDataType | Deprecated in R2007b | |
| OutScaling | Deprecated in R2007b | |
| LockScale | Lock output data type setting against changes by the fixed-point tools | {'off'} 'on' |
| RndMeth | Integer rounding mode | 'Ceiling' 'Convergent' {'Floor'} 'Nearest' 'Round' 'Simplest' 'Zero' |
| DoSatur | Saturate on integer overflow | {'off'} 'on' |
| Wrap To Zero (Wrap To Zero) (masked subsystem) | | |
| Threshold | Threshold | {'255'} |

Discrete Library Block Parameters

| Block (Type)/Parameter | Dialog Box Prompt | Values |
|--|--|---|
| Delay (Delay) | | |
| DelayLengthSource | Delay length > Source | {'Dialog'} 'Input port' |
| DelayLength | Delay length > Value | {'2'} |
| DelayLengthUpperLimit | Delay length > Upper limit | {'100'} |
| InitialConditionSource | Initial condition > Source | {'Dialog'} 'Input port' |
| InitialCondition | Initial condition > Value | {'0.0'} |
| ExternalReset | External reset | {'None'} 'Rising' 'Falling' 'Either' 'Level' 'Level hold' |
| InputProcessing | Input processing | 'Columns as channels (frame based)' {'Elements as channels (sample based)'} 'Inherited' |
| UseCircularBuffer | Use circular buffer for state | {'off'} 'on' |
| PreventDirectFeedthrough | Prevent direct feedthrough | {'off'} 'on' |
| RemoveDelayLengthCheckInGeneratedCode | Remove delay length check in generated code | {'off'} 'on' |
| DiagnosticForDelayLength | Diagnostic for delay length | {'None'} 'Warning' 'Error' |
| SampleTime | Sample time (-1 for inherited) | {'-1'} |
| StateName | State name | {''} |
| StateMustResolveToSignalObject | State name must resolve to Simulink signal object | {'off'} 'on' |
| StateSignalObject | Signal object class Code generation storage class | Simulink.Signal object Object of a class that is derived from Simulink.Signal |
| StateStorageClass | Code generation storage class | {'Auto'} 'Model default' 'ExportedGlobal' 'ImportedExtern' 'ImportedExternPointer' 'Custom' |
| CodeGenStateStorageTypeQualifier | Code generation storage type qualifier | {''} |
| Difference (Difference) (masked subsystem) | | |
| ICPrevInput | Initial condition for previous input | {'0.0'} |
| OutMin | Output minimum | {'[]'} |
| OutMax | Output maximum | {'[]'} |

| Block (Type)/Parameter | Dialog Box Prompt | Values |
|--|--|--|
| OutDataTypeStr | Output data type | {'Inherit: Inherit via internal rule'} 'Inherit: Inherit via back propagation' 'double' 'single' 'int8' 'uint8' 'int16' 'uint16' 'int32' 'uint32' 'int64' 'uint64' 'fixdt(1,16,0)' 'fixdt(1,16,2^0,0)' |
| OutputDataTypeScalingMode | Deprecated in R2007b | |
| OutDataType | Deprecated in R2007b | |
| OutScaling | Deprecated in R2007b | |
| LockScale | Lock output data type setting against changes by the fixed-point tools | {'off'} 'on' |
| RndMeth | Integer rounding mode | 'Ceiling' 'Convergent' {'Floor'} 'Nearest' 'Round' 'Simplest' 'Zero' |
| DoSatur | Saturate to max or min when overflows occur | {'off'} 'on' |
| Discrete Derivative (Discrete Derivative) (masked subsystem) | | |
| gainval | Gain value | {'1.0'} |
| ICPrevScaledInput | Initial condition for previous weighted input $K*u/Ts$ | {'0.0'} |
| OutMin | Output minimum | {'[]'} |
| OutMax | Output maximum | {'[]'} |
| OutDataTypeStr | Output data type | {'Inherit: Inherit via internal rule'} 'Inherit: Inherit via back propagation' 'double' 'single' 'int8' 'uint8' 'int16' 'uint16' 'int32' 'uint32' 'int64' 'uint64' 'fixdt(1,16,0)' 'fixdt(1,16,2^0,0)' |
| OutputDataTypeScalingMode | Deprecated in R2007b | |
| OutDataType | Deprecated in R2007b | |
| OutScaling | Deprecated in R2007b | |

| Block (Type)/Parameter | Dialog Box Prompt | Values |
|---|--|---|
| LockScale | Lock output data type setting against changes by the fixed-point tools | {'off'} 'on' |
| RndMeth | Integer rounding mode | 'Ceiling' 'Convergent' {'Floor'} 'Nearest' 'Round' 'Simplest' 'Zero' |
| DoSatur | Saturate to max or min when overflows occur | {'off'} 'on' |
| Discrete FIR Filter (Discrete FIR Filter) | | |
| CoefSource | Coefficient source | {'Dialog parameters'} 'Input port' |
| FilterStructure | Filter structure | {'Direct form'} 'Direct form symmetric' 'Direct form antisymmetric' 'Direct form transposed' 'Lattice MA' Note You must have a DSP System Toolbox license to use a filter structure other than Direct form. |
| Coefficients | Coefficients | vector — {'[0.5 0.5]'} Note You must have a DSP System Toolbox license to use a filter structure other than Direct form. |
| InputProcessing | Input processing | 'Columns as channels (frame based)' {'Elements as channels (sample based)'} Note You must have a DSP System Toolbox license to use a filter structure other than Direct form. |
| InitialStates | Initial states | scalar or vector — {'0'} |
| SampleTime | Sample time (-1 for inherited) | {'-1'} |
| CoefMin | Coefficients minimum | {'[]'} |
| CoefMax | Coefficients maximum | {'[]'} |
| OutMin | Output minimum | {'[]'} |
| OutMax | Output maximum | {'[]'} |
| TapSumDataTypeStr | Tap sum data type | {'Inherit: Same as input'} 'int8' 'uint8' 'int16' 'uint16' 'int32' 'uint32' 'fixdt(1,16,0)' |
| CoefDataTypeStr | Coefficients data type | {'Inherit: Same word length as input'} 'int8' 'uint8' 'int16' 'uint16' 'int32' 'uint32' 'fixdt(1,16)' 'fixdt(1,16,0)' |

| Block (Type)/Parameter | Dialog Box Prompt | Values |
|----------------------------------|---|--|
| ProductDataTypeStr | Product output data type | {'Inherit: Inherit via internal rule'} 'Inherit: Same as input' 'int8' 'uint8' 'int16' 'uint16' 'int32' 'uint32' 'fixdt(1,16,0)' |
| AccumDataTypeStr | Accumulator data type | {'Inherit: Inherit via internal rule'} 'Inherit: Same as input' 'Inherit: Same as product output' 'int8' 'uint8' 'int16' 'uint16' 'int32' 'uint32' 'fixdt(1,16,0)' |
| StateDataTypeStr | State data type | 'Inherit: Same as input' {'Inherit: Same as accumulator'} 'int8' 'uint8' 'int16' 'uint16' 'int32' 'uint32' 'fixdt(1,16,0)' |
| OutDataTypeStr | Output data type | 'Inherit: Same as input' {'Inherit: Same as accumulator'} 'int8' 'uint8' 'int16' 'uint16' 'int32' 'uint32' 'int64' 'uint64' 'fixdt(1,16)' 'fixdt(1,16,0)' |
| LockScale | Lock data type settings against changes by the fixed-point tools | {'off'} 'on' |
| RndMeth | Integer rounding mode | 'Ceiling' 'Convergent' {'Floor'} 'Nearest' 'Round' 'Simplest' 'Zero' |
| SaturateOnIntegerOverflow | Saturate on integer overflow | {'off'} 'on' |
| Discrete Filter (DiscreteFilter) | | |
| Numerator | Numerator coefficients | vector — {'[1]'}' |
| Denominator | Denominator coefficients | vector — {'[1 0.5]'}' |
| IC | Initial states | {'0'} |
| SampleTime | Sample time (-1 for inherited) | {'1'} |
| a0EqualsOne | Optimize by skipping divide by leading denominator coefficient (a0) | {'off'} 'on' |
| NumCoefMin | Numerator coefficient minimum | {'[]'} |
| NumCoefMax | Numerator coefficient maximum | {'[]'} |
| DenCoefMin | Denominator coefficient minimum | {'[]'} |

| Block (Type)/Parameter | Dialog Box Prompt | Values |
|------------------------|--|--|
| DenCoefMax | Denominator coefficient maximum | {'[]'} |
| OutMin | Output minimum | {'[]'} |
| OutMax | Output maximum | {'[]'} |
| StateDataTypeStr | State data type | {'Inherit: Same as input' 'int8' 'int16' 'int32' 'fixdt(1,16,0)'} |
| NumCoefDataTypeStr | Numerator coefficient data type | {'Inherit: Inherit via internal rule' 'int8' 'int16' 'int32' 'fixdt(1,16)' 'fixdt(1,16,0)'} |
| DenCoefDataTypeStr | Denominator coefficient data type | {'Inherit: Inherit via internal rule' 'int8' 'int16' 'int32' 'fixdt(1,16)' 'fixdt(1,16,0)'} |
| NumProductDataTypeStr | Numerator product output data type | {'Inherit: Inherit via internal rule' 'Inherit: Same as input' 'int8' 'int16' 'int32' 'fixdt(1,16,0)'} |
| DenProductDataTypeStr | Denominator product output data type | {'Inherit: Inherit via internal rule' 'Inherit: Same as input' 'int8' 'int16' 'int32' 'fixdt(1,16,0)'} |
| NumAccumDataTypeStr | Numerator accumulator data type | {'Inherit: Inherit via internal rule' 'Inherit: Same as input' 'Inherit: Same as product output' 'int8' 'int16' 'int32' 'fixdt(1,16,0)'} |
| DenAccumDataTypeStr | Denominator accumulator data type | {'Inherit: Inherit via internal rule' 'Inherit: Same as input' 'Inherit: Same as product output' 'int8' 'int16' 'int32' 'fixdt(1,16,0)'} |
| OutDataTypeStr | Output data type | {'Inherit: Inherit via internal rule' 'Inherit: Same as input' 'int8' 'int16' 'int32' 'fixdt(1,16,0)'} |
| LockScale | Lock data type settings against changes by the fixed-point tools | {'off'} 'on' |

| Block (Type)/Parameter | Dialog Box Prompt | Values |
|---|--|---|
| RndMeth | Integer rounding mode | 'Ceiling' 'Convergent' {'Floor'} 'Nearest' 'Round' 'Simplest' 'Zero' |
| SaturateOnIntegerOverflow | Saturate on integer overflow | {'off'} 'on' |
| StateName | State name | {''} |
| StateMustResolveToSignal Object | State name must resolve to Simulink signal object | {'off'} 'on' |
| StateSignalObject | Signal object class | Simulink.Signal object |
| | Code generation storage class | Object of a class that is derived from Simulink.Signal |
| StateStorageClass | Code generation storage class | {'Auto'} 'Model default' 'ExportedGlobal' 'ImportedExtern' 'ImportedExternPointer' 'Custom' |
| RTWStateStorageTypeQualif ier | Code generation storage type qualifier | {''} |
| Discrete State-Space (DiscreteStateSpace) | | |
| A | A | matrix — {'1'} |
| B | B | matrix — {'1'} |
| C | C | matrix — {'1'} |
| D | D | matrix — {'1'} |
| InitialCondition | Initial conditions | vector — {'0'} |
| SampleTime | Sample time (-1 for inherited) | {'1'} |
| StateName | State name | {''} |
| StateMustResolveToSignal Object | State name must resolve to Simulink signal object | {'off'} 'on' |
| StateSignalObject | Signal object class | Simulink.Signal object |
| | Code generation storage class | Object of a class that is derived from Simulink.Signal |
| StateStorageClass | Code generation storage class | {'Auto'} 'Model default' 'ExportedGlobal' 'ImportedExtern' 'ImportedExternPointer' 'Custom' |
| RTWStateStorageTypeQuali fier | Code generation storage type qualifier | {''} |
| Discrete Transfer Fcn (DiscreteTransferFcn) | | |
| Numerator | Numerator coefficients | vector — {'[1]'} {''} |

| Block (Type)/Parameter | Dialog Box Prompt | Values |
|--|--|--|
| OutDataTypeStr | Output data type | {'Inherit: Inherit via internal rule'} 'Inherit: Same as input' 'int8' 'int16' 'int32' 'fixdt(1,16,0)' |
| LockScale | Lock data type settings against changes by the fixed-point tools | {'off'} 'on' |
| RndMeth | Integer rounding mode | 'Ceiling' 'Convergent' {'Floor'} 'Nearest' 'Round' 'Simplest' 'Zero' |
| SaturateOnIntegerOverflow | Saturate on integer overflow | {'off'} 'on' |
| StateName | State name | {''} |
| StateMustResolveToSignalObject | State name must resolve to Simulink signal object | {'off'} 'on' |
| StateSignalObject | Signal object class Code generation storage class | Simulink.Signal object Object of a class that is derived from Simulink.Signal |
| StateStorageClass | Code generation storage class | {'Auto'} 'Model default' 'ExportedGlobal' 'ImportedExtern' 'ImportedExternPointer' 'Custom' |
| RTWStateStorageTypeQualifier | Code generation storage type qualifier | {''} |
| Discrete Zero-Pole (DiscreteZeroPole) | | |
| Zeros | Zeros | vector — {'[1]'}' |
| Poles | Poles | vector — {'[0 0.5]'}' |
| Gain | Gain | {'1'} |
| SampleTime | Sample time (-1 for inherited) | {'1'} |
| StateName | State name | {''} |
| StateMustResolveToSignalObject | State name must resolve to Simulink signal object | {'off'} 'on' |
| StateSignalObject | Signal object class Code generation storage class | Simulink.Signal object Object of a class that is derived from Simulink.Signal |
| StateStorageClass | Code generation storage class | {'Auto'} 'Model default' 'ExportedGlobal' 'ImportedExtern' 'ImportedExternPointer' 'Custom' |

| Block (Type)/Parameter | Dialog Box Prompt | Values |
|---|--|--|
| RTWStateStorageType Qualifier | Code generation storage type qualifier | {''} |
| Discrete-Time Integrator (DiscreteIntegrator) | | |
| IntegratorMethod | Integrator method | {'Integration: Forward Euler'} 'Integration: Backward Euler' 'Integration: Trapezoidal' 'Accumulation: Forward Euler' 'Accumulation: Backward Euler' 'Accumulation: Trapezoidal' |
| gainval | Gain value | {'1.0'} |
| ExternalReset | External reset | {'none'} 'rising' 'falling' 'either' 'level' 'sampled level' |
| InitialConditionSource | Initial condition source | {'internal'} 'external' |
| InitialCondition | Initial condition | scalar or vector — {'0'} |
| InitialConditionSetting | Initial condition setting | {'State (most efficient)'} 'Output' 'Compatibility' |
| SampleTime | Sample time (-1 for inherited) | {'1'} |
| LimitOutput | Limit output | {'off'} 'on' |
| UpperSaturationLimit | Upper saturation limit | scalar or vector — {'-inf'} |
| LowerSaturationLimit | Lower saturation limit | scalar or vector — {'-inf'} |
| ShowSaturationPort | Show saturation port | {'off'} 'on' |
| ShowStatePort | Show state port | {'off'} 'on' |
| IgnoreLimit | Ignore limit and reset when linearizing | {'off'} 'on' |
| OutMin | Output minimum | {'[]'} |
| OutMax | Output maximum | {'[]'} |
| OutDataTypeStr | Output data type | {'Inherit: Inherit via internal rule'} 'Inherit: Inherit via back propagation' 'double' 'single' 'int8' 'uint8' 'int16' 'uint16' 'int32' 'uint32' 'int64' 'uint64' 'fixdt(1,16,0)' 'fixdt(1,16,2^0,0)' |
| LockScale | Lock output data type setting against changes by the fixed-point tools | {'off'} 'on' |

| Block (Type)/Parameter | Dialog Box Prompt | Values |
|--|--|---|
| RndMeth | Integer rounding mode | 'Ceiling' 'Convergent' {'Floor'} 'Nearest' 'Round' 'Simplest' 'Zero' |
| SaturateOnInteger Overflow | Saturate on integer overflow | {'off'} 'on' |
| StateName | State name | {''} |
| StateMustResolveTo SignalObject | State name must resolve to Simulink signal object | {'off'} 'on' |
| StateSignalObject | Signal object class Code generation storage class | Simulink.Signal object Object of a class that is derived from Simulink.Signal |
| StateStorageClass | Code generation storage class | {'Auto'} 'Model default' 'ExportedGlobal' 'ImportedExtern' 'ImportedExternPointer' 'Custom' |
| RTWStateStorageType Qualifier | Code generation storage type qualifier | {''} |
| First-Order Hold (First-Order Hold) (masked subsystem) | | |
| Ts | Sample time | {'1'} |
| Memory (Memory) | | |
| InitialCondition | Initial condition | scalar or vector — {'0'} |
| InheritSampleTime | Inherit sample time | {'off'} 'on' |
| LinearizeMemory | Direct feedthrough of input during linearization | {'off'} 'on' |
| LinearizeAsDelay | Treat as a unit delay when linearizing with discrete sample time | {'off'} 'on' |
| StateName | State name | {''} |
| StateMustResolveTo SignalObject | State name must resolve to Simulink signal object | {'off'} 'on' |
| StateSignalObject | Signal object class Code generation storage class | Simulink.Signal object Object of a class that is derived from Simulink.Signal |
| StateStorageClass | Code generation storage class | {'Auto'} 'Model default' 'ExportedGlobal' 'ImportedExtern' 'ImportedExternPointer' 'Custom' |
| RTWStateStorageType Qualifier | Code generation storage type qualifier | {''} |

| Block (Type)/Parameter | Dialog Box Prompt | Values |
|---|---|---|
| Tapped Delay (S-Function) (Tapped Delay Line) (masked subsystem) | | |
| vinit | Initial condition | {'0.0'} |
| samptime | Sample time | {'-1'} |
| NumDelays | Number of delays | {'4'} |
| DelayOrder | Order output vector starting with | {'Oldest'} 'Newest' |
| includeCurrent | Include current input in output vector | {'off'} 'on' |
| Transfer Fcn First Order (First Order Transfer Fcn) (masked subsystem) | | |
| PoleZ | Pole (in Z plane) | {'0.95'} |
| ICPrevOutput | Initial condition for previous output | {'0.0'} |
| RndMeth | Integer rounding mode | 'Ceiling' 'Convergent' {'Floor'} 'Nearest' 'Round' 'Simplest' 'Zero' |
| DoSatur | Saturate to max or min when overflows occur | {'off'} 'on' |
| Transfer Fcn Lead or Lag (Lead or Lag Compensator) (masked subsystem) | | |
| PoleZ | Pole of compensator (in Z plane) | {'0.95'} |
| ZeroZ | Zero of compensator (in Z plane) | {'0.75'} |
| ICPrevOutput | Initial condition for previous output | {'0.0'} |
| ICPrevInput | Initial condition for previous input | {'0.0'} |
| RndMeth | Integer rounding mode | 'Ceiling' 'Convergent' {'Floor'} 'Nearest' 'Round' 'Simplest' 'Zero' |
| DoSatur | Saturate to max or min when overflows occur | {'off'} 'on' |
| Transfer Fcn Real Zero (Transfer Fcn Real Zero) (masked subsystem) | | |
| ZeroZ | Zero (in Z plane) | {'0.75'} |
| ICPrevInput | Initial condition for previous input | {'0.0'} |
| RndMeth | Integer rounding mode | 'Ceiling' 'Convergent' {'Floor'} 'Nearest' 'Round' 'Simplest' 'Zero' |
| DoSatur | Saturate to max or min when overflows occur | {'off'} 'on' |
| Unit Delay (UnitDelay) | | |
| InitialCondition | Initial condition | scalar or vector — {'0'} |

| Block (Type)/Parameter | Dialog Box Prompt | Values |
|----------------------------------|--|---|
| InputProcessing | Input processing | 'Columns as channels (frame based)' {'Elements as channels (sample based)'} 'Inherited' |
| SampleTime | Sample time (-1 for inherited) | {'-1'} |
| StateName | State name | {''} |
| StateMustResolveToSignalObject | State name must resolve to Simulink signal object | {'off'} 'on' |
| StateSignalObject | Signal object class Code generation storage class | Simulink.Signal object Object of a class that is derived from Simulink.Signal |
| StateStorageClass | Code generation storage class | {'Auto'} 'Model default' 'ExportedGlobal' 'ImportedExtern' 'ImportedExternPointer' 'Custom' |
| CodeGenStateStorageTypeQualifier | Code generation storage type qualifier | {''} |
| Zero-Order Hold (ZeroOrderHold) | | |
| SampleTime | Sample time (-1 for inherited) | {'1'} |

Logic and Bit Operations Library Block Parameters

| Block (Type)/Parameter | Dialog Box Prompt | Values |
|--|---------------------------------------|---|
| Bit Clear (Bit Clear) (masked subsystem) | | |
| iBit | Index of bit (0 is least significant) | {'0'} |
| Bit Set (Bit Set) (masked subsystem) | | |
| iBit | Index of bit (0 is least significant) | {'0'} |
| Bitwise Operator (S-Function) (Bitwise Operator) (masked subsystem) | | |
| logicop | Operator | {'AND' 'OR' 'NAND' 'NOR' 'XOR' 'NOT'} |
| UseBitMask | Use bit mask ... | 'off' {'on'} |
| NumInputPorts | Number of input ports | {'1'} |
| BitMask | Bit Mask | {'bin2dec('11011001')'} |
| BitMaskRealWorld | Treat mask as | 'Real World Value' {'Stored Integer'} |
| Combinatorial Logic (CombinatorialLogic) | | |
| TruthTable | Truth table | {'[0 0;0 1;0 1;1 0;0 1;1 0;1 0;1 1]'} |
| SampleTime | Sample time (-1 for inherited) | {'-1'} |
| Compare To Constant (Compare To Constant) (masked subsystem) | | |
| relop | Operator | '==' '~=' '<' {'<='} '>=' '>' |
| const | Constant value | {'3.0'} |
| OutDataTypeStr | Output data type | {'boolean'} 'uint8' |
| ZeroCross | Enable zero-crossing detection | 'off' {'on'} |
| Compare To Zero (Compare To Zero) (masked subsystem) | | |
| relop | Operator | '==' '~=' '<' {'<='} '>=' '>' |
| OutDataTypeStr | Output data type | {'boolean'} 'uint8' |
| ZeroCross | Enable zero-crossing detection | 'off' {'on'} |
| Detect Change (Detect Change) (masked subsystem) | | |
| vinit | Initial condition | {'0'} |
| OutDataTypeStr | Output data type | {'boolean'} 'uint8' |
| Detect Decrease (Detect Decrease) (masked subsystem) | | |
| vinit | Initial condition | {'0.0'} |
| OutDataTypeStr | Output data type | {'boolean'} 'uint8' |
| Detect Fall Negative (Detect Fall Negative) (masked subsystem) | | |
| vinit | Initial condition | {'0'} |
| OutDataTypeStr | Output data type | {'boolean'} 'uint8' |
| Detect Fall Nonpositive (Detect Fall Nonpositive) (masked subsystem) | | |

| Block (Type)/Parameter | Dialog Box Prompt | Values |
|--|--|--|
| vinit | Initial condition | {'0'} |
| OutDataTypeStr | Output data type | {'boolean'} 'uint8' |
| Detect Increase (Detect Increase) (masked subsystem) | | |
| vinit | Initial condition | {'0.0'} |
| OutDataTypeStr | Output data type | {'boolean'} 'uint8' |
| Detect Rise Nonnegative (Detect Rise Nonnegative) (masked subsystem) | | |
| vinit | Initial condition | {'0'} |
| OutDataTypeStr | Output data type | {'boolean'} 'uint8' |
| Detect Rise Positive (Detect Rise Positive) (masked subsystem) | | |
| vinit | Initial condition | {'0'} |
| OutDataTypeStr | Output data type | {'boolean'} 'uint8' |
| Extract Bits (Extract Bits) (masked subsystem) | | |
| bitsToExtract | Bits to extract | {'Upper half'} 'Lower half' 'Range starting with most significant bit' 'Range ending with least significant bit' 'Range of bits' |
| numBits | Number of bits | {'8'} |
| bitIdxRange | Bit indices ([start end], 0-based relative to LSB) | {'[0 7]'} |
| outScalingMode | Output scaling mode | {'Preserve fixed-point scaling'} 'Treat bit field as an integer' |
| Interval Test (Interval Test) (masked subsystem) | | |
| IntervalClosedRight | Interval closed on right | 'off' {'on'} |
| uplimit | Upper limit | {'0.5'} |
| IntervalClosedLeft | Interval closed on left | 'off' {'on'} |
| lowlimit | Lower limit | {'-0.5'} |
| OutDataTypeStr | Output data type | {'boolean'} 'uint8' |
| Interval Test Dynamic (Interval Test Dynamic) (masked subsystem) | | |
| IntervalClosedRight | Interval closed on right | 'off' {'on'} |
| IntervalClosedLeft | Interval closed on left | 'off' {'on'} |
| OutDataTypeStr | Output data type | {'boolean'} 'uint8' |
| Logical Operator (Logic) | | |
| Operator | Operator | {'AND'} 'OR' 'NAND' 'NOR' 'XOR' 'NXOR' 'NOT' |
| Inputs | Number of input ports | {'2'} |

| Block (Type)/Parameter | Dialog Box Prompt | Values |
|---|--|---|
| IconShape | Icon shape | {'rectangular'} 'distinctive' |
| SampleTime | Sample time (-1 for inherited) | {'-1'} |
| AllPortsSameDT | Require all inputs and output to have the same data type | {'off'} 'on' |
| OutDataTypeStr | Output data type | 'Inherit: Logical (see Configuration Parameters: Optimization)' {'boolean'} 'fixdt(1,16)' |
| Relational Operator (RelationalOperator) | | |
| Operator | Relational operator | '==' '~=' '<' {'<='} '>=' '>' 'isInf' 'isNaN' 'isFinite' |
| ZeroCross | Enable zero-crossing detection | 'off' {'on'} |
| SampleTime | Sample time (-1 for inherited) | {'-1'} |
| InputSameDT | Require all inputs to have the same data type | {'off'} 'on' |
| OutDataTypeStr | Output data type | 'Inherit: Logical (see Configuration Parameters: Optimization)' {'boolean'} 'fixdt(1,16)' |
| Shift Arithmetic (ArithShift) | | |
| BitShiftNumberSource | Bits to shift > Source | {'Dialog'} 'Input port' |
| BitShiftDirection | Bits to shift > Direction | 'Left' 'Right' {'Bidirectional'} |
| BitShiftNumber | Bits to shift > Number | {'8'} |
| BinPtShiftNumber | Binary points to shift > Number | {'0'} |
| DiagnosticFor00RShift | Diagnostic for out-of-range shift value | {'None'} 'Warning' 'Error' |
| Check00RBitShift | Check for out-of-range 'Bits to shift' in generated code | {'off'} 'on' |
| nBitShiftRight | Deprecated in R2011a | |
| nBinPtShiftRight | Deprecated in R2011a | |

Lookup Table Library Block Parameters

| Block (Type)/Parameter | Dialog Box Prompt | Values |
|---|--|---|
| Cosine (Cosine) (masked subsystem) | | |
| Formula | Output formula | 'sin(2*pi*u)' {'cos(2*pi*u)'} 'exp(j*2*pi*u)' 'sin(2*pi*u) and cos(2*pi*u)' |
| NumDataPoints | Number of data points for lookup table | {'(2^5)+1'} |
| OutputWordLength | Output word length | {'16'} |
| InternalRulePriority | Internal rule priority for lookup table | {'Speed'} 'Precision' |
| Direct Lookup Table (n-D) (LookupNDDirect) | | |
| NumberOfTableDimensions | Number of table dimensions | '1' {'2'} '3' '4' |
| InputsSelectThisObjectFromTable | Inputs select this object from table | {'Element'} 'Vector' '2-D Matrix' |
| TableIsInput | Make table an input | {'off'} 'on' |
| Table | Table data | {'[4 5 6;16 19 20;10 18 23]}' |
| DiagnosticForOutOfRangeInput | Diagnostic for out-of-range input | 'None' {'Warning'} 'Error' |
| SampleTime | Sample time (-1 for inherited) | {'-1'} |
| TableMin | Table minimum | {'[]}' |
| TableMax | Table maximum | {'[]}' |
| TableDataTypeStr | Table data type | {'Inherit: Inherit from 'Table data''} 'double' 'single' 'int8' 'uint8' 'int16' 'uint16' 'int32' 'uint32' 'boolean' 'fixdt(1,16)' 'fixdt(1,16,0)' 'fixdt(1,16,2^0,0)' |
| LockScale | Lock data type settings against changes by the fixed-point tools | {'off'} 'on' |
| maskTabDims | Deprecated in R2009b | |
| explicitNumDims | Deprecated in R2009b | |
| outDims | Deprecated in R2009b | |
| tabIsInput | Deprecated in R2009b | |
| mxTable | Deprecated in R2009b | |
| clipFlag | Deprecated in R2009b | |
| samptime | Deprecated in R2009b | |
| Interpolation Using Prelookup (Interpolation_n-D) | | |
| NumberOfTableDimensions | Number of table dimensions | '1' {'2'} '3' '4' |

| Block (Type)/Parameter | Dialog Box Prompt | Values |
|------------------------------------|--|---|
| Table | Table data > Value | {'sqrt([1:11]' * [1:11])'} |
| TableSource | Table data > Source | {'Dialog'} 'Input port' |
| TableSpecification | Specification | {'Explicit values'} 'Lookup table object' To set this parameter from 'Explicit values' to 'Lookup table object', use the same call to set_param to set the parameter LookupTableObject. For example: <pre>set_param('myModel/myInterpBlock',... 'TableSpecification',... 'Lookup table object',... 'LookupTableObject','myLUTObject')</pre> |
| LookupTableObject | Name of lookup table object | {''} |
| InterpMethod | Interpolation method | 'Flat' {'Linear point-slope'} 'Nearest' 'Linear Lagrange' |
| ExtrapMethod | Extrapolation method | 'Clip' {'Linear'} |
| ValidIndexMayReachLast | Valid index input may reach last index | {'off'} 'on' |
| DiagnosticForOutOfRangeInput | Diagnostic for out-of-range input | {'None'} 'Warning' 'Error' |
| RemoveProtectionIndex | Remove protection against out-of-range index in generated code | {'off'} 'on' |
| NumSelectionDims | Number of sub-table selection dimensions | {'0'} |
| SampleTime | Sample time (-1 for inherited) | {'-1'} |
| TableDataTypeStr | Table data > Data Type | 'Inherit: Inherit from 'Table data'' {'Inherit: Same as output'} 'double' 'single' 'int8' 'uint8' 'int16' 'uint16' 'int32' 'uint32' 'fixdt(1,16)' 'fixdt(1,16,0)' 'fixdt(1,16,2^0,0)' |
| TableMin | Table data > Minimum | {'[]'} |
| TableMax | Table data > Maximum | {'[]'} |
| IntermediateResultsDataTy peStr | Intermediate results > Data Type | {'Inherit: Inherit via internal rule'} 'Inherit: Same as output' 'double' 'single' 'int8' 'uint8' 'int16' 'uint16' 'int32' 'uint32' 'fixdt(1,16,0)' 'fixdt(1,16,2^0,0)' |

| Block (Type)/Parameter | Dialog Box Prompt | Values |
|---|--|---|
| OutDataTypeStr | Output > Data Type | 'Inherit: Inherit via back propagation' {'Inherit: Inherit from table data'} 'double' 'single' 'int8' 'uint8' 'int16' 'uint16' 'int32' 'uint32' 'fixdt(1,16,0)' 'fixdt(1,16,2^0,0)' |
| OutMin | Output > Minimum | {'[]'} |
| OutMax | Output > Maximum | {'[]'} |
| InternalRulePriority | Internal rule priority | {'Speed'} 'Precision' |
| LockScale | Lock data type settings against changes by the fixed-point tools | {'off'} 'on' |
| RndMeth | Integer rounding mode | 'Ceiling' 'Convergent' {'Floor'} 'Nearest' 'Round' 'Simplest' 'Zero' |
| SaturateOnIntegerOverflow | Saturate on integer overflow | {'off'} 'on' |
| CheckIndexInCode | Deprecated in R2011a | |
| n-D Lookup Table, 1-D Lookup Table, 2-D Lookup Table (Lookup_n-D) | | |
| NumberOfTableDimensions | Number of table dimensions | '1' '2' '3' '4'. Default is '1' for 1-D Lookup Table, '2' for 2-D Lookup Table, '3' for n-D Lookup Table. |
| DataSpecification | (n-D Lookup Table) Data specification | {'Table and breakpoints'} 'Lookup table object' To set this parameter from 'Table and breakpoints' to 'Lookup table object', use the same call to set_param to set the parameter LookupTableObject. For example: set_param('myModel/myLookupBlock',... 'DataSpecification','Lookup table... object',... 'LookupTableObject','myLUTObject') |
| LookupTableObject | Name of lookup table object. | {''} |
| Table | Table data | {'reshape(repmat([4 5 6;16 19 20;10 18 23],1,2),[3,3,2])'} |
| BreakpointsSpecification | Breakpoints specification | {'Explicit values'} 'Even spacing' |
| BreakpointsFor-Dimension1FirstPoint | First point | {'1'} |
| BreakpointsFor-Dimension2FirstPoint | First point | {'1'} |

| Block (Type)/Parameter | Dialog Box Prompt | Values |
|--|--|--|
| BreakpointsFor-Dimension3FirstPoint | First point | {'1'} |
| ... | ... | ... |
| BreakpointsFor-Dimension30FirstPoint | First point | {'1'} |
| BreakpointsFor-Dimension1Spacing | Spacing | {'1'} |
| BreakpointsFor-Dimension2Spacing | Spacing | {'1'} |
| BreakpointsFor-Dimension3Spacing | Spacing | {'1'} |
| ... | ... | ... |
| BreakpointsFor-Dimension30Spacing | Spacing | {'1'} |
| BreakpointsForDimension1 | Breakpoints 1 | {'[10,22,31]}'} |
| BreakpointsForDimension2 | Breakpoints 2 | {'[10,22,31]}'} |
| BreakpointsForDimension3 | Breakpoints 3 | {'[5, 7]}'} |
| ... | ... | ... |
| BreakpointsForDimension30 | Breakpoints 30 | {'[1:3]}'} |
| SampleTime | Sample time (-1 for inherited) | {'-1'} |
| InterpMethod | Interpolation method | 'Flat' 'Nearest' {'Linear point-slope'} 'Linear Lagrange' 'Cubic spline' |
| ExtrapMethod | Extrapolation method | 'Clip' {'Linear'} 'Cubic spline' |
| UseLastTableValue | Use last table value for inputs at or above last breakpoint | {'off'} 'on' |
| DiagnosticForOutOfRangeInput | Diagnostic for out-of-range input | {'None'} 'Warning' 'Error' |
| RemoveProtectionInput | Remove protection against out-of-range input in generated code | {'off'} 'on' |
| IndexSearchMethod | Index search method | 'Evenly spaced points' 'Linear search' {'Binary search'} |
| BeginIndexSearchUsingPreviousIndexResult | Begin index search using previous index result | {'off'} 'on' |
| UseOneInputPortForAllInputData | Use one input port for all input data | {'off'} 'on' |
| SupportTunableTableSize | Support tunable table size in code generation | {'off'} 'on' |

| Block (Type)/Parameter | Dialog Box Prompt | Values |
|--------------------------------------|------------------------------------|---|
| MaximumIndicesForEachDimension | Maximum indices for each dimension | {'[]'} |
| TableDataTypeStr | Table data > Data Type | 'Inherit: Inherit from 'Table data'' {'Inherit: Same as output'} 'double' 'single' 'int8' 'uint8' 'int16' 'uint16' 'int32' 'uint32' 'fixdt(1,16)' 'fixdt(1,16,0)' 'fixdt(1,16,2^0,0)' |
| TableMin | Table data > Minimum | {'[]'} |
| TableMax | Table data > Maximum | {'[]'} |
| BreakpointsForDimension1DataTypeStr | Breakpoints 1 > Data Type | {'Inherit: Same as corresponding input'} 'Inherit: Inherit from 'Breakpoint data'' 'double' 'single' 'int8' 'uint8' 'int16' 'uint16' 'int32' 'uint32' 'fixdt(1,16)' 'fixdt(1,16,0)' 'fixdt(1,16,2^0,0)' |
| BreakpointsForDimension1Min | Breakpoints 1 > Minimum | {'[]'} |
| BreakpointsForDimension1Max | Breakpoints 1 > Maximum | {'[]'} |
| BreakpointsForDimension2DataTypeStr | Breakpoints 2 > Data Type | {'Inherit: Same as corresponding input'} 'Inherit: Inherit from 'Breakpoint data'' 'double' 'single' 'int8' 'uint8' 'int16' 'uint16' 'int32' 'uint32' 'fixdt(1,16)' 'fixdt(1,16,0)' 'fixdt(1,16,2^0,0)' |
| BreakpointsForDimension2Min | Breakpoints 2 > Minimum | {'[]'} |
| BreakpointsForDimension2Max | Breakpoints 2 > Maximum | {'[]'} |
| ... | ... | ... |
| BreakpointsForDimension30DataTypeStr | Breakpoints 30 > Data Type | {'Inherit: Same as corresponding input'} 'Inherit: Inherit from 'Breakpoint data'' 'double' 'single' 'int8' 'uint8' 'int16' 'uint16' 'int32' 'uint32' 'fixdt(1,16)' 'fixdt(1,16,0)' 'fixdt(1,16,2^0,0)' |

| Block (Type)/Parameter | Dialog Box Prompt | Values |
|--|--|---|
| BreakpointsForDimension30 Min | Breakpoints 30 > Minimum | {'[]'} |
| BreakpointsForDimension30 Max | Breakpoints 30 > Maximum | {'[]'} |
| FractionDataTypeStr | Fraction > Data Type | {'Inherit: Inherit via internal rule'} 'double' 'single' 'fixdt(1,16,0)' |
| IntermediateResults DataTypeStr | Intermediate results > Data Type | 'Inherit: Inherit via internal rule' {'Inherit: Same as output'} 'double' 'single' 'int8' 'uint8' 'int16' 'uint16' 'int32' 'uint32' 'fixdt(1,16,0)' 'fixdt(1,16,2^0,0)' |
| OutDataTypeStr | Output > Data Type | 'Inherit: Inherit via back propagation' 'Inherit: Inherit from table data' {'Inherit: Same as first input'} 'double' 'single' 'int8' 'uint8' 'int16' 'uint16' 'int32' 'uint32' 'int64' 'uint64' 'fixdt(1,16,0)' 'fixdt(1,16,2^0,0)' |
| OutMin | Output > Minimum | {'[]'} |
| OutMax | Output > Maximum | {'[]'} |
| InternalRulePriority | Internal rule priority | {'Speed'} 'Precision' |
| InputSameDT | Require all inputs to have the same data type | 'off' {'on'} |
| LockScale | Lock data type settings against changes by the fixed-point tools | {'off'} 'on' |
| RndMeth | Integer rounding mode | 'Ceiling' 'Convergent' 'Floor' 'Nearest' 'Round' {'Simplest'} 'Zero' |
| SaturateOnInteger Overflow | Saturate on integer overflow | {'off'} 'on' |
| ProcessOutOfRangeInput | Deprecated in R2009b | |
| Lookup Table Dynamic (Lookup Table Dynamic) (masked subsystem) | | |
| LookUpMeth | Lookup Method | 'Interpolation-Extrapolation' {'Interpolation-Use End Values'} 'Use Input Nearest' 'Use Input Below' 'Use Input Above' |

| Block (Type)/Parameter | Dialog Box Prompt | Values |
|---|--|--|
| OutDataTypeStr | Output data type | {'fixdt('double')} 'Inherit: Inherit via back propagation' 'double' 'single' 'int8' 'uint8' 'int16' 'uint16' 'int32' 'uint32' 'int64' 'uint64' 'boolean' 'fixdt(1,16,0)' 'fixdt(1,16,2^0,0)' |
| OutputDataTypeScaling Mode | Deprecated in R2007b | |
| OutDataType | Deprecated in R2007b | |
| OutScaling | Deprecated in R2007b | |
| LockScale | Lock output data type setting against changes by the fixed-point tools | {'off'} 'on' |
| RndMeth | Integer rounding mode | 'Ceiling' 'Convergent' {'Floor'} 'Nearest' 'Round' 'Simplest' 'Zero' |
| DoSatur | Saturate to max or min when overflows occur | {'off'} 'on' |
| Prelookup (PreLookup) | | |
| BreakpointsSpecification | Specification | {'Explicit values'} 'Even spacing' 'Breakpoint object' To set this parameter from 'Explicit values' or 'Even spacing' to 'Breakpoint object', use the same call to set_param to set the parameter BreakpointObject. For example: set_param('myModel/myPrelookupBlock', ... 'BreakpointsSpecification', ... 'Breakpoint object', ... 'BreakpointObject', 'myBPObject') |
| BreakpointObject | Name of breakpoint object | {''} |
| BreakpointsFirstPoint | First point | {'10'} |
| BreakpointsSpacing | Spacing | {'10'} |
| BreakpointsNumPoints | Number of points | {'11'} |
| BreakpointsData | Value | {'[10:10:110]'} |
| BreakpointsDataSource | Source | {'Dialog'} 'Input port' |
| IndexSearchMethod | Index search method | 'Evenly spaced points' 'Linear search' {'Binary search'} |
| BeginIndexSearchUsing PreviousIndexResult | Begin index search using previous index result | {'off'} 'on' |

| Block (Type)/Parameter | Dialog Box Prompt | Values |
|--------------------------------|--|---|
| OutputOnlyTheIndex | Output only the index | {'off'} 'on' |
| ExtrapMethod | Extrapolation method | 'Clip' {'Linear'} |
| UseLastBreakpoint | Use last breakpoint for input at or above upper limit | {'off'} 'on' |
| DiagnosticForOutOfRange Input | Diagnostic for out-of-range input | {'None'} 'Warning' 'Error' |
| RemoveProtectionInput | Remove protection against out-of-range input in generated code | {'off'} 'on' |
| SampleTime | Sample time (-1 for inherited) | {'-1'} |
| BreakpointDataTypeStr | Breakpoint > Data Type | {'Inherit: Same as input'} 'Inherit: Inherit from Breakpoint data' 'double' 'single' 'int8' 'uint8' 'int16' 'uint16' 'int32' 'uint32' 'fixdt(1,16)' 'fixdt(1,16,0)' 'fixdt(1,16,2^0,0)' |
| BreakpointMin | Breakpoint > Minimum | {'[]'} |
| BreakpointMax | Breakpoint > Maximum | {'[]'} |
| IndexDataTypeStr | Index > Data Type | 'int8' 'uint8' 'int16' 'uint16' 'int32' {'uint32'} 'fixdt(1,16)' |
| FractionDataTypeStr | Fraction > Data Type | {'Inherit: Inherit via internal rule'} 'double' 'single' 'fixdt(1,16,0)' |
| LockScale | Lock output data type setting against changes by the fixed-point tools | {'off'} 'on' |
| RndMeth | Integer rounding mode | 'Ceiling' 'Convergent' {'Floor'} 'Nearest' 'Round' 'Simplest' 'Zero' |
| ProcessOutOfRangeInput | Deprecated in R2011a | |
| Sine (Sine) (masked subsystem) | | |
| Formula | Output formula | {'sin(2*pi*u)'} 'cos(2*pi*u)' 'exp(j*2*pi*u)' 'sin(2*pi*u) and cos(2*pi*u)' |
| NumDataPoints | Number of data points for lookup table | {'(2^5)+1'} |
| OutputWordLength | Output word length | {'16'} |
| InternalRulePriority | Internal rule priority for lookup table | {'Speed'} 'Precision' |

Math Operations Library Block Parameters

| Block (Type)/Parameter | Dialog Box Prompt | Values |
|----------------------------|--|---|
| Abs (Abs) | | |
| ZeroCross | Enable zero-crossing detection | 'off' {'on'} |
| SampleTime | Sample time (-1 for inherited) | {'-1'} |
| OutMin | Output minimum | {'[]'} |
| OutMax | Output maximum | {'[]'} |
| OutDataTypeStr | Output data type | 'Inherit: Inherit via internal rule' 'Inherit: Inherit via back propagation' {'Inherit: Same as input'} 'double' 'single' 'int8' 'uint8' 'int16' 'uint16' 'int32' 'uint32' 'int64' 'uint64' 'fixdt(1,16,0)' 'fixdt(1,16,2^0,0)' |
| LockScale | Lock output data type setting against changes by the fixed-point tools | {'off'} 'on' |
| RndMeth | Integer rounding mode | 'Ceiling' 'Convergent' {'Floor'} 'Nearest' 'Round' 'Simplest' 'Zero' |
| SaturateOnInteger Overflow | Saturate on integer overflow | {'off'} 'on' |
| Add (Sum) | | |
| IconShape | Icon shape | {'rectangular'} 'round' |
| Inputs | List of signs | {'++'} |
| CollapseMode | Sum over | {'All dimensions'} 'Specified dimension' |
| CollapseDim | Dimension | {'1'} |
| SampleTime | Sample time (-1 for inherited) | {'-1'} |
| InputSameDT | Require all inputs to have the same data type | {'off'} 'on' |
| AccumDataTypeStr | Accumulator data type | {'Inherit: Inherit via internal rule'} 'Inherit: Same as first input' 'double' 'single' 'int8' 'uint8' 'int16' 'uint16' 'int32' 'uint32' 'fixdt(1,16,0)' 'fixdt(1,16,2^0,0)' |

| Block (Type)/Parameter | Dialog Box Prompt | Values |
|---|--|--|
| OutMin | Output minimum | {'[]'} |
| OutMax | Output maximum | {'[]'} |
| OutDataTypeStr | Output data type | {'Inherit: Inherit via internal rule'} 'Inherit: Inherit via back propagation' 'Inherit: Same as first input' 'Inherit: Same as accumulator' 'double' 'single' 'int8' 'uint8' 'int16' 'uint16' 'int32' 'uint32' 'int64' 'uint64' 'fixdt(1,16,0)' 'fixdt(1,16,2^0,0)' |
| LockScale | Lock data type settings against changes by the fixed-point tools | {'off'} 'on' |
| RndMeth | Integer rounding mode | 'Ceiling' 'Convergent' {'Floor'} 'Nearest' 'Round' 'Simplest' 'Zero' |
| SaturateOnInteger Overflow | Saturate on integer overflow | {'off'} 'on' |
| Algebraic Constraint (Algebraic Constraint) | | |
| Constraint | Constraint on input signal | {'f(z) = 0'} 'f(z) = z' |
| Solver | Algebraic Loop Solver | {'auto'} 'Trust Region' 'Line Search' |
| Tolerance | Solver Tolerance | {'auto'} |
| InitialGuess | Initial guess | {'0'} |
| Assignment (Assignment) | | |
| NumberOfDimensions | Number of output dimensions | {'1'} |
| IndexMode | Index mode | 'Zero-based' {'One-based'} |
| OutputInitialize | Initialize output (Y) | {'Initialize using input port <Y0>'} 'Specify size for each dimension in table' |
| IndexOptionArray | Index Option | 'Assign all' {'Index vector (dialog)'} 'Index vector (port)' 'Starting index (dialog)' 'Starting index (port)' |
| IndexParamArray | Index | cell array |
| OutputSizeArray | Output Size | cell array |

| Block (Type)/Parameter | Dialog Box Prompt | Values |
|--|---|---|
| DiagnosticForDimensions | Action if any output element is not assigned | 'Error' 'Warning' {'None'} |
| SampleTime | Sample time (-1 for inherited) | {'-1'} |
| IndexOptions | See the IndexOptionArray parameter for more information. | |
| Indices | See the IndexParamArray parameter for more information. | |
| OutputSizes | See the OutputSizeArray parameter for more information. | |
| Bias (Bias) | | |
| Bias | Bias | {'0.0'} |
| SaturateOnInteger Overflow | Saturate on integer overflow | {'off'} 'on' |
| Complex to Magnitude-Angle (ComplexToMagnitudeAngle) | | |
| Output | Output | 'Magnitude' 'Angle' {'Magnitude and angle'} |
| SampleTime | Sample time (-1 for inherited) | {'-1'} |
| Complex to Real-Imag (ComplexToRealImag) | | |
| Output | Output | 'Real' 'Imag' {'Real and imag'} |
| SampleTime | Sample time (-1 for inherited) | {'-1'} |
| Divide (Product) | | |
| Inputs | Number of inputs | {'*/'} |
| Multiplication | Multiplication | {'Element-wise(*)'} 'Matrix(*)' |
| SampleTime | Sample time (-1 for inherited) | {'-1'} |
| InputSameDT | Require all inputs to have same data type | {'off'} 'on' |
| OutMin | Output minimum | {'[]'} |
| OutMax | Output maximum | {'[]'} |
| OutDataTypeStr | Output data type | {'Inherit: Inherit via internal rule'} 'Inherit: Inherit via back propagation' 'Inherit: Same as first input' 'double' 'single' 'int8' 'uint8' 'int16' 'uint16' 'int32' 'uint32' 'int64' 'uint64' 'fixdt(1,16,0)' 'fixdt(1,16,2^0,0)' |

| Block (Type)/Parameter | Dialog Box Prompt | Values |
|----------------------------|--|---|
| LockScale | Lock output data type setting against changes by the fixed-point tools | {'off'} 'on' |
| RndMeth | Integer rounding mode | 'Ceiling' 'Convergent' {'Floor'} 'Nearest' 'Round' 'Simplest' 'Zero' |
| SaturateOnInteger Overflow | Saturate on integer overflow | {'off'} 'on' |
| Dot Product (DotProduct) | | |
| SampleTime | Sample time (-1 for inherited) | {'-1'} |
| InputSameDT | Require all inputs to have same data type | 'off' {'on'} |
| OutMin | Output minimum | {'[]'} |
| OutMax | Output maximum | {'[]'} |
| OutDataTypeStr | Output data type | {'Inherit: Inherit via internal rule'} 'Inherit: Inherit via back propagation' 'Inherit: Same as first input' 'double' 'single' 'int8' 'uint8' 'int16' 'uint16' 'int32' 'uint32' 'int64' 'uint64' 'fixdt(1,16,0)' 'fixdt(1,16,2^0,0)' |
| OutputDataTypeScaling Mode | Deprecated in R2007b | |
| OutDataType | Deprecated in R2007b | |
| OutScaling | Deprecated in R2007b | |
| LockScale | Lock output data type setting against changes by the fixed-point tools | {'off'} 'on' |
| RndMeth | Integer rounding mode | 'Ceiling' 'Convergent' {'Floor'} 'Nearest' 'Round' 'Simplest' 'Zero' |
| SaturateOnInteger Overflow | Saturate on integer overflow | {'off'} 'on' |
| Find (Find) | | |
| IndexOutputFormat | Index output format | {'Linear indices'} 'Subscripts' |
| NumberOfInputDimensions | Number of input dimensions | integer — {'1'} |

| Block (Type)/Parameter | Dialog Box Prompt | Values |
|----------------------------------|--|---|
| IndexMode | Index mode | {'Zero-based'} 'One-based' |
| ShowOutputForNonzero InputValues | Show output port for nonzero input values | {'off'} 'on' |
| SampleTime | Sample time (-1 for inherited) | {'-1'} |
| OutDataTypeStr | Output data type | {'Inherit: Inherit via internal rule'} 'int8' 'uint8' 'int16' 'uint16' 'int32' 'uint32' 'int64' 'uint64' 'fixdt(1,16)' |
| Gain (Gain) | | |
| Gain | Gain | {'1'} |
| Multiplication | Multiplication | {'Element-wise(K.*u)'} 'Matrix(K*u)' 'Matrix(u*K)' 'Matrix(K*u) (u vector)' |
| SampleTime | Sample time (-1 for inherited) | {'-1'} |
| OutMin | Output minimum | {'[]'} |
| OutMax | Output maximum | {'[]'} |
| OutDataTypeStr | Output data type | {'Inherit: Inherit via internal rule'} 'Inherit: Inherit via back propagation' 'Inherit: Same as input' 'double' 'single' 'int8' 'uint8' 'int16' 'uint16' 'int32' 'uint32' 'int64' 'uint64' 'fixdt(1,16,0)' 'fixdt(1,16,2^0,0)' |
| LockScale | Lock output data type setting against changes by the fixed-point tools | {'off'} 'on' |
| RndMeth | Integer rounding mode | 'Ceiling' 'Convergent' {'Floor'} 'Nearest' 'Round' 'Simplest' 'Zero' |
| SaturateOnInteger Overflow | Saturate on integer overflow | {'off'} 'on' |
| ParamMin | Parameter minimum | {'[]'} |
| ParamMax | Parameter maximum | {'[]'} |

| Block (Type)/Parameter | Dialog Box Prompt | Values |
|---|---|---|
| ParamDataTypeStr | Parameter data type | {'Inherit: Inherit via internal rule'} 'Inherit: Same as input' 'Inherit: Inherit from 'Gain'' 'double' 'single' 'int8' 'uint8' 'int16' 'uint16' 'int32' 'uint32' 'fixdt(1,16)' 'fixdt(1,16,0)' 'fixdt(1,16,2^0,0)' |
| Magnitude-Angle to Complex (MagnitudeAngleToComplex) | | |
| Input | Input | 'Magnitude' 'Angle' {'Magnitude and angle'} |
| ConstantPart | Magnitude or Angle | {'0'} |
| ApproximationMethod | Approximation method | {'None'} 'CORDIC' |
| NumberOfIterations | Number of iterations | {'11'} |
| ScaleReciprocalGainFactor | Scale output by reciprocal of gain factor | 'off' {'on'} |
| SampleTime | Sample time (-1 for inherited) | {'-1'} |
| Math Function (Math) | | |
| Operator | Function | {'exp'} 'log' '10^u' 'log10' 'magnitude^2' 'square' 'pow' 'conj' 'reciprocal' 'hypot' 'rem' 'mod' 'transpose' 'hermitian' |
| OutputSignalType | Output signal type | {'auto'} 'real' 'complex' |
| SampleTime | Sample time (-1 for inherited) | {'-1'} |
| OutMin | Output minimum | {'[]'} |
| OutMax | Output maximum | {'[]'} |
| OutDataTypeStr | Output data type | 'Inherit: Inherit via internal rule' 'Inherit: Inherit via back propagation' {'Inherit: Same as first input'} 'double' 'single' 'int8' 'uint8' 'int16' 'uint16' 'int32' 'uint32' 'int64' 'uint64' 'fixdt(1,16,0)' 'fixdt(1,16,2^0,0)' |

| Block (Type)/Parameter | Dialog Box Prompt | Values |
|--|--|--|
| LockScale | Lock output data type setting against changes by the fixed-point tools | {'off'} 'on' |
| RndMeth | Integer rounding mode | 'Ceiling' 'Convergent' {'Floor'} 'Nearest' 'Round' 'Simplest' 'Zero' |
| SaturateOnInteger Overflow | Saturate on integer overflow | 'off' {'on'} |
| Matrix Concatenate (Concatenate) | | |
| NumInputs | Number of inputs | {'2'} |
| Mode | Mode | 'Vector' {'Multidimensional array'} |
| ConcatenateDimension | Concatenate dimension | {'2'} |
| MinMax (MinMax) | | |
| Function | Function | {'min'} 'max' |
| Inputs | Number of input ports | {'1'} |
| ZeroCross | Enable zero-crossing detection | 'off' {'on'} |
| SampleTime | Sample time (-1 for inherited) | {'-1'} |
| InputSameDT | Require all inputs to have the same data type | {'off'} 'on' |
| OutMin | Output minimum | {'[]'} |
| OutMax | Output maximum | {'[]'} |
| OutDataTypeStr | Output data type | {'Inherit: Inherit via internal rule'} 'Inherit: Inherit via back propagation' 'double' 'single' 'int8' 'uint8' 'int16' 'uint16' 'int32' 'uint32' 'int64' 'uint64' 'fixdt(1,16,0)' 'fixdt(1,16,2^0,0)' |
| LockScale | Lock output data type setting against changes by the fixed-point tools | {'off'} 'on' |
| RndMeth | Integer rounding mode | 'Ceiling' 'Convergent' {'Floor'} 'Nearest' 'Round' 'Simplest' 'Zero' |
| SaturateOnInteger Overflow | Saturate on integer overflow | {'off'} 'on' |
| MinMax Running Resetable (MinMax Running Resetable) (masked subsystem) | | |

| Block (Type)/Parameter | Dialog Box Prompt | Values |
|--|--|---|
| Function | Function | {'min'} 'max' |
| vinit | Initial condition | {'0.0'} |
| Permute Dimensions (PermuteDimensions) | | |
| Order | Order | {'[2,1]}'} |
| Polynomial (Polyval) | | |
| coefs | Polynomial Coefficients | {'[+2.081618890e-019, -1.441693666e-014, +4.719686976e-010, -8.536869453e-006, +1.621573104e-001, -8.087801117e+001]'} |
| Product (Product) | | |
| Inputs | Number of inputs | {'2'} |
| Multiplication | Multiplication | {'Element-wise(*)'} 'Matrix(*)' |
| CollapseMode | Multiply over | {'All dimensions'} 'Specified dimension' |
| CollapseDim | Dimension | {'1'} |
| SampleTime | Sample time (-1 for inherited) | {'-1'} |
| InputSameDT | Require all inputs to have same data type | {'off'} 'on' |
| OutMin | Output minimum | {'[]'} |
| OutMax | Output maximum | {'[]'} |
| OutDataTypeStr | Output data type | {'Inherit: Inherit via internal rule'} 'Inherit: Inherit via back propagation' 'Inherit: Same as first input' 'double' 'single' 'int8' 'uint8' 'int16' 'uint16' 'int32' 'uint32' 'int64' 'uint64' 'fixdt(1,16,0)' 'fixdt(1,16,2^0,0)' |
| LockScale | Lock output data type setting against changes by the fixed-point tools | {'off'} 'on' |
| RndMeth | Integer rounding mode | 'Ceiling' 'Convergent' 'Floor' 'Nearest' 'Round' 'Simplest' {'Zero'} |
| SaturateOnInteger Overflow | Saturate on integer overflow | {'off'} 'on' |

| Block (Type)/Parameter | Dialog Box Prompt | Values |
|--|--|---|
| Product of Elements (Product) | | |
| Inputs | Number of inputs | { '*' } |
| Multiplication | Multiplication | { 'Element-wise(*)' } 'Matrix(*)' |
| CollapseMode | Multiply over | { 'All dimensions' } 'Specified dimension' |
| CollapseDim | Dimension | { '1' } |
| SampleTime | Sample time (-1 for inherited) | { '-1' } |
| InputSameDT | Require all inputs to have same data type | { 'off' } 'on' |
| OutMin | Output minimum | { '[]' } |
| OutMax | Output maximum | { '[]' } |
| OutDataTypeStr | Output data type | { 'Inherit: Inherit via internal rule' } 'Inherit: Inherit via back propagation' 'Inherit: Same as first input' 'double' 'single' 'int8' 'uint8' 'int16' 'uint16' 'int32' 'uint32' 'int64' 'uint64' 'fixdt(1,16,0)' 'fixdt(1,16,2^0,0)' |
| LockScale | Lock output data type setting against changes by the fixed-point tools | { 'off' } 'on' |
| RndMeth | Integer rounding mode | 'Ceiling' 'Convergent' { 'Floor' } 'Nearest' 'Round' 'Simplest' 'Zero' |
| SaturateOnInteger Overflow | Saturate on integer overflow | { 'off' } 'on' |
| Real-Imag to Complex (RealImagToComplex) | | |
| Input | Input | 'Real' 'Imag' { 'Real and imag' } |
| ConstantPart | Real part or Imag part | { '0' } |
| SampleTime | Sample time (-1 for inherited) | { '-1' } |
| Reciprocal Sqrt (Sqrt) | | |
| Operator | Function | 'sqrt' 'signedSqrt' { 'rSqrt' } |
| OutputSignalType | Output signal type | { 'auto' } 'real' 'complex' |

| Block (Type)/Parameter | Dialog Box Prompt | Values |
|---------------------------------|--|---|
| SampleTime | Sample time (-1 for inherited) | {'-1'} |
| OutMin | Output minimum | {'[]'} |
| OutMax | Output maximum | {'[]'} |
| OutDataTypeStr | Output data type | 'Inherit: Inherit via internal rule' 'Inherit: Inherit via back propagation' {'Inherit: Same as first input'} 'double' 'single' 'int8' 'uint8' 'int16' 'uint16' 'int32' 'uint32' 'int64' 'uint64' 'fixdt(1,16,0)' 'fixdt(1,16,2^0,0)' |
| LockScale | Lock output data type setting against changes by the fixed-point tools | {'off'} 'on' |
| RndMeth | Integer rounding mode | 'Ceiling' 'Convergent' {'Floor'} 'Nearest' 'Round' 'Simplest' 'Zero' |
| SaturateOnInteger Overflow | Saturate on integer overflow | 'off' {'on'} |
| IntermediateResults DataTypeStr | Intermediate results data type | {'Inherit: Inherit via internal rule'} 'Inherit: Inherit from input' 'Inherit: Inherit from output' 'double' 'single' 'int8' 'uint8' 'int16' 'uint16' 'int32' 'uint32' 'fixdt(1,16,0)' 'fixdt(1,16,2^0,0)' |
| AlgorithmType | Method | 'Exact' {'Newton-Raphson'} |
| Iterations | Number of iterations | {'3'} |
| Reshape (Reshape) | | |
| OutputDimensionality | Output dimensionality | {'1-D array'} 'Column vector (2-D)' 'Row vector (2-D)' 'Customize' 'Derive from reference input port' |
| OutputDimensions | Output dimensions | {'[1,1]}'} |
| Rounding Function (Rounding) | | |

| Block (Type)/Parameter | Dialog Box Prompt | Values |
|---------------------------------|--|---|
| Operator | Function | {'floor'} 'ceil' 'round' 'fix' |
| SampleTime | Sample time (-1 for inherited) | {'-1'} |
| Sign (Signum) | | |
| ZeroCross | Enable zero-crossing detection | 'off' {'on'} |
| SampleTime | Sample time (-1 for inherited) | {'-1'} |
| Signed Sqrt (Sqrt) | | |
| Operator | Function | 'sqrt' {'signedSqrt'} 'rSqrt' |
| OutputSignalType | Output signal type | {'auto'} 'real' 'complex' |
| SampleTime | Sample time (-1 for inherited) | {'-1'} |
| OutMin | Output minimum | {'[]'} |
| OutMax | Output maximum | {'[]'} |
| OutDataTypeStr | Output data type | 'Inherit: Inherit via internal rule' 'Inherit: Inherit via back propagation' {'Inherit: Same as first input'} 'double' 'single' 'int8' 'uint8' 'int16' 'uint16' 'int32' 'uint32' 'int64' 'uint64' 'fixdt(1,16,0)' 'fixdt(1,16,2^0,0)' |
| LockScale | Lock output data type setting against changes by the fixed-point tools | {'off'} 'on' |
| RndMeth | Integer rounding mode | 'Ceiling' 'Convergent' {'Floor'} 'Nearest' 'Round' 'Simplest' 'Zero' |
| SaturateOnInteger Overflow | Saturate on integer overflow | 'off' {'on'} |
| IntermediateResults DataTypeStr | Intermediate results data type | {'Inherit: Inherit via internal rule'} 'Inherit: Inherit from input' 'Inherit: Inherit from output' 'double' 'single' 'int8' 'uint8' 'int16' 'uint16' 'int32' 'uint32' 'fixdt(1,16,0)' 'fixdt(1,16,2^0,0)' |

| Block (Type)/Parameter | Dialog Box Prompt | Values |
|--|------------------------------------|---|
| AlgorithmType | Method | {'Exact'} 'Newton-Raphson' |
| Iterations | Number of iterations | {'3'} |
| Sine Wave Function (Sin) | | |
| SineType | Sine type | {'Time based'} 'Sample based' |
| TimeSource | Time | 'Use simulation time' {'Use external signal'} |
| Amplitude | Amplitude | {'1'} |
| Bias | Bias | {'0'} |
| Frequency | Frequency | {'1'} |
| Phase | Phase | {'0'} |
| Samples | Samples per period | {'10'} |
| Offset | Number of offset samples | {'0'} |
| SampleTime | Sample time | {'0'} |
| VectorParams1D | Interpret vector parameters as 1-D | 'off' {'on'} |
| Slider Gain (Slider Gain) (masked subsystem) | | |
| low | Low | {'0'} |
| gain | Gain | {'1'} |
| high | High | {'2'} |
| Sqrt (Sqrt) | | |
| Operator | Function | {'sqrt'} 'signedSqrt' 'rSqrt' |
| OutputSignalType | Output signal type | {'auto'} 'real' 'complex' |
| SampleTime | Sample time (-1 for inherited) | {'-1'} |
| OutMin | Output minimum | {'[]'} |
| OutMax | Output maximum | {'[]'} |
| OutDataTypeStr | Output data type | 'Inherit: Inherit via internal rule' 'Inherit: Inherit via back propagation' {'Inherit: Same as first input'} 'double' 'single' 'int8' 'uint8' 'int16' 'uint16' 'int32' 'uint32' 'int64' 'uint64' 'fixdt(1,16,0)' 'fixdt(1,16,2^0,0)' |

| Block (Type)/Parameter | Dialog Box Prompt | Values |
|--------------------------------------|--|--|
| LockScale | Lock output data type setting against changes by the fixed-point tools | {'off'} 'on' |
| RndMeth | Integer rounding mode | 'Ceiling' 'Convergent' {'Floor'} 'Nearest' 'Round' 'Simplest' 'Zero' |
| SaturateOnInteger Overflow | Saturate on integer overflow | 'off' {'on'} |
| IntermediateResults DataTypeStr | Intermediate results data type | {'Inherit: Inherit via internal rule'} 'Inherit: Inherit from input' 'Inherit: Inherit from output' 'double' 'single' 'int8' 'uint8' 'int16' 'uint16' 'int32' 'uint32' 'fixdt(1,16,0)' 'fixdt(1,16,2^0,0)' |
| AlgorithmType | Method | {'Exact'} 'Newton-Raphson' |
| Iterations | Number of iterations | {'3'} |
| Squeeze (Squeeze) (masked subsystem) | | |
| None | None | None |
| Subtract (Sum) | | |
| IconShape | Icon shape | {'rectangular'} 'round' |
| Inputs | List of signs | {'+- '} |
| CollapseMode | Sum over | {'All dimensions'} 'Specified dimension' |
| CollapseDim | Dimension | {'1'} |
| SampleTime | Sample time (-1 for inherited) | {'-1'} |
| InputSameDT | Require all inputs to have the same data type | {'off'} 'on' |
| AccumDataTypeStr | Accumulator data type | {'Inherit: Inherit via internal rule'} 'Inherit: Same as first input' 'double' 'single' 'int8' 'uint8' 'int16' 'uint16' 'int32' 'uint32' 'int64' 'uint64' 'fixdt(1,16,0)' 'fixdt(1,16,2^0,0)' |
| OutMin | Output minimum | {'[]'} |
| OutMax | Output maximum | {'[]'} |

| Block (Type)/Parameter | Dialog Box Prompt | Values |
|----------------------------|--|--|
| OutDataTypeStr | Output data type | {'Inherit: Inherit via internal rule'} {'Inherit: Inherit via back propagation'} {'Inherit: Same as first input'} {'Inherit: Same as accumulator'} {'double'} {'single'} {'int8'} {'uint8'} {'int16'} {'uint16'} {'int32'} {'uint32'} {'int64'} {'uint64'} {'fixdt(1,16,0)'} {'fixdt(1,16,2^0,0)'} |
| LockScale | Lock data type settings against changes by the fixed-point tools | {'off'} {'on'} |
| RndMeth | Integer rounding mode | 'Ceiling' 'Convergent' {'Floor'} 'Nearest' 'Round' 'Simplest' 'Zero' |
| SaturateOnInteger Overflow | Saturate on integer overflow | {'off'} {'on'} |
| Sum (Sum) | | |
| IconShape | Icon shape | 'rectangular' {'round'} |
| Inputs | List of signs | {' ++'} |
| CollapseMode | Sum over | {'All dimensions'} 'Specified dimension' |
| CollapseDim | Dimension | {'1'} |
| SampleTime | Sample time (-1 for inherited) | {'-1'} |
| InputSameDT | Require all inputs to have the same data type | {'off'} {'on'} |
| AccumDataTypeStr | Accumulator data type | {'Inherit: Inherit via internal rule'} {'Inherit: Same as first input'} {'double'} {'single'} {'int8'} {'uint8'} {'int16'} {'uint16'} {'int32'} {'uint32'} {'fixdt(1,16,0)'} {'fixdt(1,16,2^0,0)'} |
| OutMin | Output minimum | {'[]'} |
| OutMax | Output maximum | {'[]'} |

| Block (Type)/Parameter | Dialog Box Prompt | Values |
|----------------------------|--|--|
| OutDataTypeStr | Output data type | {'Inherit: Inherit via internal rule'} {'Inherit: Inherit via back propagation'} {'Inherit: Same as first input'} {'Inherit: Same as accumulator'} {'double'} {'single'} {'int8'} {'uint8'} {'int16'} {'uint16'} {'int32'} {'uint32'} {'int64'} {'uint64'} {'fixdt(1,16,0)'} {'fixdt(1,16,2^0,0)'} |
| LockScale | Lock data type settings against changes by the fixed-point tools | {'off'} {'on'} |
| RndMeth | Integer rounding mode | {'Ceiling'} {'Convergent'} {'Floor'} {'Nearest'} {'Round'} {'Simplest'} {'Zero'} |
| SaturateOnInteger Overflow | Saturate on integer overflow | {'off'} {'on'} |
| Sum of Elements (Sum) | | |
| IconShape | Icon shape | {'rectangular'} {'round'} |
| Inputs | List of signs | {'+'} |
| CollapseMode | Sum over | {'All dimensions'} {'Specified dimension'} |
| CollapseDim | Dimension | {'1'} |
| SampleTime | Sample time (-1 for inherited) | {'-1'} |
| InputSameDT | Require all inputs to have the same data type | {'off'} {'on'} |
| AccumDataTypeStr | Accumulator data type | {'Inherit: Inherit via internal rule'} {'Inherit: Same as first input'} {'double'} {'single'} {'int8'} {'uint8'} {'int16'} {'uint16'} {'int32'} {'uint32'} {'fixdt(1,16,0)'} {'fixdt(1,16,2^0,0)'} |
| OutMin | Output minimum | {'[]'} |
| OutMax | Output maximum | {'[]'} |

| Block (Type)/Parameter | Dialog Box Prompt | Values |
|---|--|--|
| OutDataTypeStr | Output data type | {'Inherit: Inherit via internal rule'} {'Inherit: Inherit via back propagation'} {'Inherit: Same as first input'} {'Inherit: Same as accumulator'} {'double'} {'single'} {'int8'} {'uint8'} {'int16'} {'uint16'} {'int32'} {'uint32'} {'int64'} {'uint64'} {'fixdt(1,16,0)'} {'fixdt(1,16,2^0,0)'} |
| LockScale | Lock data type settings against changes by the fixed-point tools | {'off'} {'on'} |
| RndMeth | Integer rounding mode | {'Ceiling'} {'Convergent'} {'Floor'} {'Nearest'} {'Round'} {'Simplest'} {'Zero'} |
| SaturateOnInteger Overflow | Saturate on integer overflow | {'off'} {'on'} |
| Trigonometric Function (Trigonometry) | | |
| Operator | Function | {'sin'} {'cos'} {'tan'} {'asin'} {'acos'} {'atan'} {'atan2'} {'sinh'} {'cosh'} {'tanh'} {'asinh'} {'acosh'} {'atanh'} {'sincos'} {'cos + jsin'} |
| ApproximationMethod | Approximation method | {'None'} {'CORDIC'} |
| NumberOfIterations | Number of iterations | {'11'} |
| OutputSignalType | Output signal type | {'auto'} {'real'} {'complex'} |
| SampleTime | Sample time (-1 for inherited) | {'-1'} |
| Unary Minus (UnaryMinus) | | |
| SampleTime | Sample time (-1 for inherited) | {'-1'} |
| SaturateOnInteger Overflow | Saturate on integer overflow | {'off'} {'on'} |
| Vector Concatenate (Concatenate) | | |
| NumInputs | Number of inputs | {'2'} |
| Mode | Mode | {'Vector'} {'Multidimensional array'} |
| Weighted Sample Time Math (SampleTimeMath) | | |
| TsampMathOp | Operation | {'+'} {'-'} {'*'} {'/'} {'Ts Only'} {'1/Ts Only'} |

| Block (Type)/Parameter | Dialog Box Prompt | Values |
|-------------------------------|------------------------------|---|
| weightValue | Weight value | {'1.0'} |
| TsampMathImp | Implement using | {'Online Calculations'} 'Offline Scaling Adjustment' |
| OutDataTypeStr | Output data type | {'Inherit via internal rule'} 'Inherit via back propagation' |
| RndMeth | Integer rounding mode | 'Ceiling' 'Convergent' {'Floor'} 'Nearest' 'Round' 'Simplest' 'Zero' |
| SaturateOnInteger Overflow | Saturate on integer overflow | {'off'} 'on' |
| OutputDataTypeScaling Mode | Deprecated in R2009b | |
| DoSatur | Deprecated in R2009b | |

Model Verification Library Block Parameters

| Block (Type)/Parameter | Dialog Box Prompt | Values |
|--|---|----------------------|
| Assertion (Assertion) | | |
| Enabled | Enable assertion | 'off' {'on'} |
| AssertionFailFcn | Simulation callback when assertion fails | {''} |
| StopWhenAssertionFail | Stop simulation when assertion fails | 'off' {'on'} |
| SampleTime | Sample time (-1 for inherited) | {'-1'} |
| Check Dynamic Gap (Checks_DGap) (masked subsystem) | | |
| enabled | Enable assertion | 'off' {'on'} |
| callback | Simulation callback when assertion fails (optional) | {''} |
| stopWhenAssertionFail | Stop simulation when assertion fails | 'off' {'on'} |
| export | Output assertion signal | {'off'} 'on' |
| icon | Select icon type | {'graphic'} 'text' |
| Check Dynamic Range (Checks_DRange) (masked subsystem) | | |
| enabled | Enable assertion | 'off' {'on'} |
| callback | Simulation callback when assertion fails (optional) | {''} |
| stopWhenAssertionFail | Stop simulation when assertion fails | 'off' {'on'} |
| export | Output assertion signal | {'off'} 'on' |
| icon | Select icon type | {'graphic'} 'text' |
| Check Static Gap (Checks_SGap) (masked subsystem) | | |
| max | Upper bound | {'100'} |
| max_included | Inclusive upper bound | 'off' {'on'} |
| min | Lower bound | {'0'} |
| min_included | Inclusive lower bound | 'off' {'on'} |
| enabled | Enable assertion | 'off' {'on'} |
| callback | Simulation callback when assertion fails (optional) | {''} |
| stopWhenAssertionFail | Stop simulation when assertion fails | 'off' {'on'} |
| export | Output assertion signal | {'off'} 'on' |
| icon | Select icon type | {'graphic'} 'text' |
| Check Static Range (Checks_SRange) (masked subsystem) | | |
| max | Upper bound | {'100'} |
| max_included | Inclusive upper bound | 'off' {'on'} |
| min | Lower bound | {'0'} |
| min_included | Inclusive lower bound | 'off' {'on'} |

| Block (Type)/Parameter | Dialog Box Prompt | Values |
|---|---|----------------------|
| enabled | Enable assertion | 'off' {'on'} |
| callback | Simulation callback when assertion fails (optional) | {''} |
| stopWhenAssertionFail | Stop simulation when assertion fails | 'off' {'on'} |
| export | Output assertion signal | {'off'} 'on' |
| icon | Select icon type | {'graphic'} 'text' |
| Check Discrete Gradient (Checks_Gradient) (masked subsystem) | | |
| gradient | Maximum gradient | {'1'} |
| enabled | Enable assertion | 'off' {'on'} |
| callback | Simulation callback when assertion fails (optional) | {''} |
| stopWhenAssertionFail | Stop simulation when assertion fails | 'off' {'on'} |
| export | Output assertion signal | {'off'} 'on' |
| icon | Select icon type | {'graphic'} 'text' |
| Check Dynamic Lower Bound (Checks_DMin) (masked subsystem) | | |
| Enabled | Enable assertion | 'off' {'on'} |
| callback | Simulation callback when assertion fails (optional) | {''} |
| stopWhenAssertionFail | Stop simulation when assertion fails | 'off' {'on'} |
| export | Output assertion signal | {'off'} 'on' |
| icon | Select icon type | {'graphic'} 'text' |
| Check Dynamic Upper Bound (Checks_DMax) (masked subsystem) | | |
| enabled | Enable assertion | 'off' {'on'} |
| callback | Simulation callback when assertion fails (optional) | {''} |
| stopWhenAssertionFail | Stop simulation when assertion fails | 'off' {'on'} |
| export | Output assertion signal | {'off'} 'on' |
| icon | Select icon type | {'graphic'} 'text' |
| Check Input Resolution (Checks_Resolution) (masked subsystem) | | |
| resolution | Resolution | {'1'} |
| enabled | Enable assertion | 'off' {'on'} |
| callback | Simulation callback when assertion fails (optional) | {''} |
| stopWhenAssertionFail | Stop simulation when assertion fails | 'off' {'on'} |
| export | Output assertion signal | {'off'} 'on' |
| Check Static Lower Bound (Checks_SMin) (masked subsystem) | | |
| min | Lower bound | {'0'} |
| min_included | Inclusive boundary | 'off' {'on'} |

| Block (Type)/Parameter | Dialog Box Prompt | Values |
|---|---|----------------------|
| enabled | Enable assertion | 'off' {'on'} |
| callback | Simulation callback when assertion fails (optional) | {''} |
| stopWhenAssertionFail | Stop simulation when assertion fails | 'off' {'on'} |
| export | Output assertion signal | {'off'} 'on' |
| icon | Select icon type | {'graphic'} 'text' |
| Check Static Upper Bound (Checks_SMax) (masked subsystem) | | |
| max | Upper bound | {'0'} |
| max_included | Inclusive boundary | 'off' {'on'} |
| enabled | Enable assertion | 'off' {'on'} |
| callback | Simulation callback when assertion fails (optional) | {''} |
| stopWhenAssertionFail | Stop simulation when assertion fails | 'off' {'on'} |
| export | Output assertion signal | {'off'} 'on' |
| icon | Select icon type | {'graphic'} 'text' |

Model-Wide Utilities Library Block Parameters

| Block (Type)/Parameter | Dialog Box Prompt | Values |
|--|---------------------------|---------------------------|
| Block Support Table (Block Support Table) (masked subsystem) | | |
| DocBlock (DocBlock) (masked subsystem) | | |
| ECoderFlag | Embedded Coder Flag | {''} |
| DocumentType | Document Type | {'Text'} 'RTF' 'HTML' |
| Model Info (CMBlock) (masked subsystem) | | |
| InitialSaveTempField | InitialSaveTempField | {''} |
| InitialBlockCM | InitialBlockCM | {'None'} |
| BlockCM | BlockCM | {'None'} |
| Frame | Show block frame | 'off' {'on'} |
| SaveTempField | SaveTempField | {''} |
| DisplayStringWithTags | DisplayStringWithTags | {'Model Info'} |
| MaskDisplayString | MaskDisplayString | {'Model Info'} |
| HorizontalTextAlignment | Horizontal text alignment | {'Center'} |
| LeftAlignmentValue | LeftAlignmentValue | {'0.5'} |
| SourceBlockDiagram | SourceBlockDiagram | {'untitled'} |
| TagMaxNumber | TagMaxNumber | {'20'} |
| CMTag1 | CMTag1 | {''} |
| CMTag2 | CMTag2 | {''} |
| CMTag3 | CMTag3 | {''} |
| CMTag4 | CMTag4 | {''} |
| CMTag5 | CMTag5 | {''} |
| CMTag6 | CMTag6 | {''} |
| CMTag7 | CMTag7 | {''} |
| CMTag8 | CMTag8 | {''} |
| CMTag9 | CMTag9 | {''} |
| CMTag10 | CMTag10 | {''} |
| CMTag11 | CMTag11 | {''} |
| CMTag12 | CMTag12 | {''} |
| CMTag13 | CMTag13 | {''} |
| CMTag14 | CMTag14 | {''} |
| CMTag15 | CMTag15 | {''} |
| CMTag16 | CMTag16 | {''} |
| CMTag17 | CMTag17 | {''} |
| CMTag18 | CMTag18 | {''} |
| CMTag19 | CMTag19 | {''} |

| Block (Type)/Parameter | Dialog Box Prompt | Values |
|--|-----------------------------------|--|
| CMTag20 | CMTag20 | {''} |
| Timed-Based Linearization (Timed Linearization) (masked subsystem) | | |
| LinearizationTime | Linearization time | {'1'} |
| SampleTime | Sample time (of linearized model) | {'0'} |
| Trigger-Based Linearization (Triggered Linearization) (masked subsystem) | | |
| TriggerType | Trigger type | {'rising'} {'falling'} 'either' 'function-call' |
| SampleTime | Sample time (of linearized model) | {'0'} |

Ports & Subsystems Library Block Parameters

| Block (Type)/Parameter | Dialog Box Prompt | Values |
|--|--|---|
| Action Port (ActionPort) | | |
| InitializeStates | States when execution is resumed | {'held'} 'reset' |
| PropagateVarSize | Propagate sizes of variable-size signals | {'Only when execution is resumed'} 'During execution' |
| Atomic Subsystem (SubSystem) | | |
| ShowPortLabels | Show port labels Note The values 'off' and 'on' are for backward compatibility only and should not be used in new models or when updating existing models. | 'none' {'FromPortIcon'} 'FromPortBlockName' 'SignalName' 'off' 'on' |
| BlockChoice | Block choice | {''} |
| TemplateBlock | Template block | {''} |
| MemberBlocks | Member blocks | {''} |
| Permissions | Read/Write permissions | {'ReadWrite'} 'ReadOnly' 'NoReadOrWrite' |
| ErrorFcn | Name of error callback function | {''} |
| PermitHierarchicalResolution | Permit hierarchical resolution | {'All'} 'ExplicitOnly' 'None' |
| TreatAsAtomicUnit | Treat as atomic unit | 'off' {'on'} |
| TreatAsGroupedWhenPropagatingVariantConditions | Treat as grouped when propagating variant conditions | 'off' {'on'} |
| MinAlgLoopOccurrences | Minimize algebraic loop occurrences | {'off'} 'on' |
| CheckFcnCallInpInsideContextMsg | Warn if function-call inputs are context-specific | {'off'} 'on' |
| SystemSampleTime | Sample time (-1 for inherited) | {'-1'} |
| RTWSystemCode | Function packaging | {'Auto'} 'Inline' 'Nonreusable function' 'Reusable function' |
| RTWFcnNameOpts | Function name options | {'Auto'} 'Use subsystem name' 'User specified' |
| RTWFcnName | Function name | {''} |
| RTWFileNameOpts | File name options | {'Auto'} 'Use subsystem name' 'Use function name' 'User specified' |
| RTWFileName | File name (no extension) | {''} |

| Block (Type)/Parameter | Dialog Box Prompt | Values |
|--------------------------|---|---|
| FunctionInterfaceSpec | Function interface This parameter requires a license for Embedded Coder software and an ERT-based system target file. | {'void_void'} 'Allow arguments (Optimized)' 'Allow arguments (Match graphical interface)' |
| FunctionWithSeparateData | "Function with separate data" on page 1-0 This parameter requires a license for Embedded Coder software and an ERT-based system target file. | {'off'} 'on' |
| RTWMemSecFuncInitTerm | "Memory section for initialize/terminate functions" on page 1-0 This parameter requires a license for Embedded Coder software and an ERT-based system target file. | {'Inherit from model'} 'Default' list of memory sections from model's package |
| RTWMemSecFuncExecute | "Memory section for execution functions" on page 1-0 This parameter requires a license for Embedded Coder software and an ERT-based system target file. | {'Inherit from model'} 'Default' list of memory sections from model's package |
| RTWMemSecDataConstants | "Memory section for constants" on page 1-0 This parameter requires a license for Embedded Coder software and an ERT-based system target file. | {'Inherit from model'} 'Default' list of memory sections from model's package |
| RTWMemSecDataInternal | "Memory section for internal data" on page 1-0 This parameter requires a license for Embedded Coder software and an ERT-based system target file. | {'Inherit from model'} 'Default' list of memory sections from model's package |
| RTWMemSecDataParameters | "Memory section for parameters" on page 1-0 This parameter requires a license for Embedded Coder software and an ERT-based system target file. | {'Inherit from model'} 'Default' list of memory sections from model's package |
| DataTypeOverride | No dialog box prompt Specifies data type used to override fixed-point data types. Set by Data type override on the Fixed-Point Tool. | {'UseLocalSettings'} 'ScaledDouble' 'Double' 'Single' 'Off' |

| Block (Type)/Parameter | Dialog Box Prompt | Values |
|----------------------------------|--|---|
| MinMaxOverflowLogging | No dialog box prompt Setting for fixed-point instrumentation. Set by Fixed-point instrumentation mode on the Fixed-Point Tool. | {'UseLocalSettings'} 'MinMaxAndOverflow' 'OverflowOnly' 'ForceOff' |
| SimViewingDevice | No dialog box prompt If set to 'on', designates the block as a Signal Viewing Subsystem — an atomic subsystem that encapsulates processing and viewing of signals received from the target system in External mode. For more information, see “Signal Viewing Subsystems” (Simulink Coder). | {'off'} 'on' |
| IsSubsystemVirtual | | boolean — {'off'} 'on' Read-only |
| Code Reuse Subsystem (SubSystem) | | |
| ShowPortLabels | Show port labels Note The values 'off' and 'on' are for backward compatibility only and should not be used in new models or when updating existing models. | 'none' {'FromPortIcon'} 'FromPortBlockName' 'SignalName' 'off' 'on' |
| BlockChoice | Block choice | {''} |
| TemplateBlock | Template block | {''} |
| MemberBlocks | Member blocks | {''} |
| Permissions | Read/Write permissions | {'ReadWrite'} 'ReadOnly' 'NoReadOrWrite' |
| ErrorFcn | Name of error callback function | {''} |
| PermitHierarchicalResolution | Permit hierarchical resolution | {'All'} 'ExplicitOnly' 'None' |
| TreatAsAtomicUnit | Treat as atomic unit | 'off' {'on'} |
| MinAlgLoopOccurrences | Minimize algebraic loop occurrences | {'off'} 'on' |
| CheckFcnCallInpInsideContextMsg | Warn if function-call inputs are context-specific | {'off'} 'on' |
| SystemSampleTime | Sample time (-1 for inherited) | {'-1'} |

| Block (Type)/Parameter | Dialog Box Prompt | Values |
|-------------------------|--|---|
| RTWSystemCode | Function packaging | 'Auto' 'Inline' 'Nonreusable function' {'Reusable function'} |
| RTWFcnNameOpts | Function name options | 'Auto' {'Use subsystem name'} 'User specified' |
| RTWFcnName | Function name | {''} |
| RTWFileNameOpts | File name options | 'Auto' {'Use subsystem name'} 'Use function name' 'User specified' |
| RTWFileName | File name (no extension) | {''} |
| RTWMemSecFuncInitTerm | <p>“Memory section for initialize/terminate functions” on page 1-0</p> <p>This parameter requires a license for Embedded Coder software and an ERT-based system target file.</p> | {'Inherit from model'} 'Default' list of memory sections from model's package |
| RTWMemSecFuncExecute | <p>“Memory section for execution functions” on page 1-0</p> <p>This parameter requires a license for Embedded Coder software and an ERT-based system target file.</p> | {'Inherit from model'} 'Default' list of memory sections from model's package |
| RTWMemSecDataConstants | <p>“Memory section for constants” on page 1-0</p> <p>This parameter requires a license for Embedded Coder software and an ERT-based system target file.</p> | {'Inherit from model'} 'Default' list of memory sections from model's package |
| RTWMemSecDataInternal | <p>“Memory section for internal data” on page 1-0</p> <p>This parameter requires a license for Embedded Coder software and an ERT-based system target file.</p> | {'Inherit from model'} 'Default' list of memory sections from model's package |
| RTWMemSecDataParameters | <p>“Memory section for parameters” on page 1-0</p> <p>This parameter requires a license for Embedded Coder software and an ERT-based system target file.</p> | {'Inherit from model'} 'Default' list of memory sections from model's package |
| DataTypeOverride | <p>No dialog box prompt</p> <p>Specifies data type used to override fixed-point data types. Set by Data type override on the Fixed-Point Tool.</p> | {'UseLocalSettings'} 'ScaledDouble' 'Double' 'Single' 'Off' |

| Block (Type)/Parameter | Dialog Box Prompt | Values |
|------------------------------------|--|---|
| MinMaxOverflowLogging | No dialog box prompt Setting for fixed-point instrumentation. Set by Fixed-point instrumentation mode on the Fixed-Point Tool. | {'UseLocalSettings'} 'MinMaxAndOverflow' 'OverflowOnly' 'ForceOff' |
| IsSubsystemVirtual | | boolean — {'off'} 'on' Read-only |
| Configurable Subsystem (SubSystem) | | |
| ShowPortLabels | Show port labels Note The values 'off' and 'on' are for backward compatibility only and should not be used in new models or when updating existing models. | 'none' {'FromPortIcon'} 'FromPortBlockName' 'SignalName' 'off' 'on' |
| BlockChoice | Block choice | {''} |
| TemplateBlock | Template block | {'self'} |
| MemberBlocks | Member blocks | {''} |
| Permissions | Read/Write permissions | {'ReadWrite'} 'ReadOnly' 'NoReadOrWrite' |
| ErrorFcn | Name of error callback function | {''} |
| PermitHierarchicalResolution | Permit hierarchical resolution | {'All'} 'ExplicitOnly' 'None' |
| TreatAsAtomicUnit | Treat as atomic unit | {'off'} 'on' |
| MinAlgLoopOccurrences | Minimize algebraic loop occurrences | {'off'} 'on' |
| CheckFcnCallInpInsideContextMsg | Warn if function-call inputs are context-specific | {'off'} 'on' |
| SystemSampleTime | Sample time (-1 for inherited) | {'-1'} |
| RTWSystemCode | Function packaging | {'Auto'} 'Inline' 'Nonreusable function' 'Reusable function' |
| RTWFcnNameOpts | Function name options | {'Auto'} 'Use subsystem name' 'User specified' |
| RTWFcnName | Function name | {''} |
| RTWFileNameOpts | File name options | {'Auto'} 'Use subsystem name' 'Use function name' 'User specified' |
| RTWFileName | File name (no extension) | {''} |

| Block (Type)/Parameter | Dialog Box Prompt | Values |
|---|--|--|
| DataTypeOverride | No dialog box prompt Specifies data type used to override fixed-point data types. Set by Data type override on the Fixed-Point Tool. | {'UseLocalSettings'} 'ScaledDouble' 'Double' 'Single' 'Off' |
| MinMaxOverflowLogging | No dialog box prompt Setting for fixed-point instrumentation. Set by Fixed-point instrumentation mode on the Fixed-Point Tool. | {'UseLocalSettings'} 'MinMaxAndOverflow' 'OverflowOnly' 'ForceOff' |
| SimViewingDevice | No dialog box prompt If set to 'on', designates the block as a Signal Viewing Subsystem — an atomic subsystem that encapsulates processing and viewing of signals received from the target system in External mode. For more information, see “Signal Viewing Subsystems” (Simulink Coder). | {'off'} 'on' |
| DataTypeOverride | No dialog box prompt Specifies data type used to override fixed-point data types. Set by Data type override on the Fixed-Point Tool. | {'UseLocalSettings'} 'ScaledDouble' 'Double' 'Single' 'Off' |
| MinMaxOverflowLogging | No dialog box prompt Setting for fixed-point instrumentation. Set by Fixed-point instrumentation mode on the Fixed-Point Tool. | {'UseLocalSettings'} 'MinMaxAndOverflow' 'OverflowOnly' 'ForceOff' |
| IsSubsystemVirtual | No dialog box prompt | boolean — {'on'} 'off' Read-only |
| Enable (EnablePort) | | |
| StatesWhenEnabling | States when enabling | {'held'} 'reset' |
| PropagateVarSize | Propagate sizes of variable-size signals | {'Only when enabling'} 'During execution' |
| ShowOutputPort | Show output port | {'off'} 'on' |
| ZeroCross | Enable zero-crossing detection | 'off' {'on'} |
| Enabled and Triggered Subsystem (SubSystem) | | |

| Block (Type)/Parameter | Dialog Box Prompt | Values |
|---------------------------------|--|---|
| ShowPortLabels | Show port labels Note The values 'off' and 'on' are for backward compatibility only and should not be used in new models or when updating existing models. | 'none' {'FromPortIcon'} 'FromPortBlockName' 'SignalName' 'off' 'on' |
| BlockChoice | Block choice | {''} |
| TemplateBlock | Template block | {''} |
| MemberBlocks | Member blocks | {''} |
| Permissions | Read/Write permissions | {'ReadWrite'} 'ReadOnly' 'NoReadOrWrite' |
| ErrorFcn | Name of error callback function | {''} |
| PermitHierarchicalResolution | Permit hierarchical resolution | {'All'} 'ExplicitOnly' 'None' |
| TreatAsAtomicUnit | Treat as atomic unit | 'off' {'on'} |
| MinAlgLoopOccurrences | Minimize algebraic loop occurrences | {'off'} 'on' |
| CheckFcnCallInpInsideContextMsg | Warn if function-call inputs are context-specific | {'off'} 'on' |
| SystemSampleTime | Sample time (-1 for inherited) | {'-1'} |
| RTWSystemCode | Function packaging | {'Auto'} 'Inline' 'Nonreusable function' 'Reusable function' |
| RTWFcnNameOpts | Function name options | {'Auto'} 'Use subsystem name' 'User specified' |
| RTWFcnName | Function name | {''} |
| RTWFileNameOpts | File name options | {'Auto'} 'Use subsystem name' 'Use function name' 'User specified' |
| RTWFileName | File name (no extension) | {''} |
| DataTypeOverride | No dialog box prompt Specifies data type used to override fixed-point data types. Set by Data type override on the Fixed-Point Tool. | {'UseLocalSettings'} 'ScaledDouble' 'Double' 'Single' 'Off' |
| MinMaxOverflowLogging | No dialog box prompt Setting for fixed-point instrumentation. Set by Fixed-point instrumentation mode on the Fixed-Point Tool. | {'UseLocalSettings'} 'MinMaxAndOverflow' 'OverflowOnly' 'ForceOff' |

| Block (Type)/Parameter | Dialog Box Prompt | Values |
|---------------------------------|--|---|
| IsSubsystemVirtual | | boolean — {'off'} 'on' Read-only |
| Enabled Subsystem (SubSystem) | | |
| ShowPortLabels | Show port labels Note The values 'off' and 'on' are for backward compatibility only and should not be used in new models or when updating existing models. | 'none' {'FromPortIcon'} 'FromPortBlockName' 'SignalName' 'off' 'on' |
| BlockChoice | Block choice | {''} |
| TemplateBlock | Template block | {''} |
| MemberBlocks | Member blocks | {''} |
| Permissions | Read/Write permissions | {'ReadWrite'} 'ReadOnly' 'NoReadOrWrite' |
| ErrorFcn | Name of error callback function | {''} |
| PermitHierarchicalResolution | Permit hierarchical resolution | {'All'} 'ExplicitOnly' 'None' |
| TreatAsAtomicUnit | Treat as atomic unit | 'off' {'on'} |
| MinAlgLoopOccurrences | Minimize algebraic loop occurrences | {'off'} 'on' |
| CheckFcnCallInpInsideContextMsg | Warn if function-call inputs are context-specific | {'off'} 'on' |
| SystemSampleTime | Sample time (-1 for inherited) | {'-1'} |
| RTWSystemCode | Function packaging | {'Auto'} 'Inline' 'Nonreusable function' 'Reusable function' |
| RTWFcnNameOpts | Function name options | {'Auto'} 'Use subsystem name' 'User specified' |
| RTWFcnName | Function name | {''} |
| RTWFileNameOpts | File name options | {'Auto'} 'Use subsystem name' 'Use function name' 'User specified' |
| RTWFileName | File name (no extension) | {''} |
| DataTypeOverride | No dialog box prompt Specifies data type used to override fixed-point data types. Set by Data type override on the Fixed-Point Tool. | {'UseLocalSettings'} 'ScaledDouble' 'Double' 'Single' 'Off' |

| Block (Type)/Parameter | Dialog Box Prompt | Values |
|------------------------------------|--|---|
| MinMaxOverflowLogging | No dialog box prompt Setting for fixed-point instrumentation. Set by Fixed-point instrumentation mode on the Fixed-Point Tool. | {'UseLocalSettings'} 'MinMaxAndOverflow' 'OverflowOnly' 'ForceOff' |
| IsSubsystemVirtual | | boolean — {'off'} 'on' Read-only |
| For Each(ForEach) | | |
| InputPartition | Partition | cell array of character vectors |
| InputPartitionDimension | Partition dimension for input signal | cell array of character vectors |
| InputPartitionWidth | Width of partition for input signal | cell array of character vectors |
| OutputConcatenationDimension | Concatenation dimension of output signal | cell array of character vectors |
| For Iterator (ForIterator) | | |
| ResetStates | States when starting | {'held'} 'reset' |
| IterationSource | Iteration limit source | {'internal'} 'external' |
| IterationLimit | Iteration limit | {'5'} |
| ExternalIncrement | Set next i (iteration variable) externally | {'off'} 'on' |
| ShowIterationPort | Show iteration variable | 'off' {'on'} |
| IndexMode | Index mode | 'Zero-based' {'One-based'} |
| IterationVariableDataType | Iteration variable data type | {'int32'} 'int16' 'int8' 'double' |
| For Iterator Subsystem (SubSystem) | | |
| ShowPortLabels | Show port labels Note The values 'off' and 'on' are for backward compatibility only and should not be used in new models or when updating existing models. | 'none' {'FromPortIcon'} 'FromPortBlockName' 'SignalName' 'off' 'on' |
| BlockChoice | Block choice | {''} |
| TemplateBlock | Template block | {''} |
| MemberBlocks | Member blocks | {''} |
| Permissions | Read/Write permissions | {'ReadWrite'} 'ReadOnly' 'NoReadOrWrite' |
| ErrorFcn | Name of error callback function | {''} |

| Block (Type)/Parameter | Dialog Box Prompt | Values |
|--|--|--|
| PermitHierarchicalResolution | Permit hierarchical resolution | {'All'} 'ExplicitOnly' 'None' |
| TreatAsAtomicUnit | Treat as atomic unit | 'off' {'on'} |
| MinAlgLoopOccurrences | Minimize algebraic loop occurrences | {'off'} 'on' |
| CheckFcnCallInpInsideContextMsg | Warn if function-call inputs are context-specific | {'off'} 'on' |
| SystemSampleTime | Sample time (-1 for inherited) | {'-1'} |
| RTWSystemCode | Function packaging | {'Auto'} 'Inline' 'Nonreusable function' 'Reusable function' |
| RTWFcnNameOpts | Function name options | {'Auto'} 'Use subsystem name' 'User specified' |
| RTWFcnName | Function name | {''} |
| RTWFileNameOpts | File name options | {'Auto'} 'Use subsystem name' 'Use function name' 'User specified' |
| RTWFileName | File name (no extension) | {''} |
| DataTypeOverride | No dialog box prompt Specifies data type used to override fixed-point data types. Set by Data type override on the Fixed-Point Tool. | {'UseLocalSettings'} 'ScaledDouble' 'Double' 'Single' 'Off' |
| MinMaxOverflowLogging | No dialog box prompt Setting for fixed-point instrumentation . Set by Fixed-point instrumentation mode on the Fixed-Point Tool. | {'UseLocalSettings'} 'MinMaxAndOverflow' 'OverflowOnly' 'ForceOff' |
| IsSubsystemVirtual | | boolean — {'off'} 'on' Read-only |
| Function-Call Generator (Function-Call Generator) (masked subsystem) | | |
| sample_time | Sample time | {'1'} |
| numberOfIterations | Number of iterations | {'1'} |
| Function-Call Subsystem (SubSystem) | | |

| Block (Type)/Parameter | Dialog Box Prompt | Values |
|---------------------------------|--|---|
| ShowPortLabels | Show port labels Note The values 'off' and 'on' are for backward compatibility only and should not be used in new models or when updating existing models. | 'none' {'FromPortIcon'} 'FromPortBlockName' 'SignalName' 'off' 'on' |
| BlockChoice | Block choice | {''} |
| TemplateBlock | Template block | {''} |
| MemberBlocks | Member blocks | {''} |
| Permissions | Read/Write permissions | {'ReadWrite'} 'ReadOnly' 'NoReadOrWrite' |
| ErrorFcn | Name of error callback function | {''} |
| PermitHierarchicalResolution | Permit hierarchical resolution | {'All'} 'ExplicitOnly' 'None' |
| TreatAsAtomicUnit | Treat as atomic unit | 'off' {'on'} |
| MinAlgLoopOccurrences | Minimize algebraic loop occurrences | {'off'} 'on' |
| CheckFcnCallInpInsideContextMsg | Warn if function-call inputs are context-specific | {'off'} 'on' |
| SystemSampleTime | Sample time (-1 for inherited) | {'-1'} |
| RTWSystemCode | Function packaging | {'Auto'} 'Inline' 'Nonreusable function' 'Reusable function' |
| RTWFcnNameOpts | Function name options | {'Auto'} 'Use subsystem name' 'User specified' |
| RTWFcnName | Function name | {''} |
| RTWFileNameOpts | File name options | {'Auto'} 'Use subsystem name' 'Use function name' 'User specified' |
| RTWFileName | File name (no extension) | {''} |
| DataTypOverride | No dialog box prompt Specifies data type used to override fixed-point data types. Set by Data type override on the Fixed-Point Tool. | {'UseLocalSettings'} 'ScaledDouble' 'Double' 'Single' 'Off' |
| MinMaxOverflowLogging | No dialog box prompt Setting for fixed-point instrumentation. Set by Fixed-point instrumentation mode on the Fixed-Point Tool. | {'UseLocalSettings'} 'MinMaxAndOverflow' 'OverflowOnly' 'ForceOff' |

| Block (Type)/Parameter | Dialog Box Prompt | Values |
|---------------------------------|--|---|
| IsSubsystemVirtual | | boolean — {'off'} 'on' Read-only |
| If (If) | | |
| NumInputs | Number of inputs | {'1'} |
| IfExpression | If expression (e.g., u1 ~= 0) | {'u1 > 0'} |
| ElseIfExpressions | Elseif expressions (comma-separated list, e.g., u2 ~= 0, u3(2) < u2) | {' '} |
| ShowElse | Show else condition | 'off' {'on'} |
| ZeroCross | Enable zero-crossing detection | 'off' {'on'} |
| SampleTime | Sample time (-1 for inherited) | {'-1'} |
| If Action Subsystem (SubSystem) | | |
| ShowPortLabels | Show port labels Note The values 'off' and 'on' are for backward compatibility only and should not be used in new models or when updating existing models. | 'none' {'FromPortIcon'} 'FromPortBlockName' 'SignalName' 'off' 'on' |
| BlockChoice | Block choice | {' '} |
| TemplateBlock | Template block | {' '} |
| MemberBlocks | Member blocks | {' '} |
| Permissions | Read/Write permissions | {'ReadWrite'} 'ReadOnly' 'NoReadOrWrite' |
| ErrorFcn | Name of error callback function | {' '} |
| PermitHierarchicalResolution | Permit hierarchical resolution | {'All'} 'ExplicitOnly' 'None' |
| TreatAsAtomicUnit | Treat as atomic unit | 'off' {'on'} |
| MinAlgLoopOccurrences | Minimize algebraic loop occurrences | {'off'} 'on' |
| CheckFcnCallInpInsideContextMsg | Warn if function-call inputs are context-specific | {'off'} 'on' |
| SystemSampleTime | Sample time (-1 for inherited) | {'-1'} |
| RTWSystemCode | Function packaging | {'Auto'} 'Inline' 'Nonreusable function' 'Reusable function' |
| RTWFcnNameOpts | Function name options | {'Auto'} 'Use subsystem name' 'User specified' |
| RTWFcnName | Function name | {' '} |

| Block (Type)/Parameter | Dialog Box Prompt | Values |
|------------------------------|--|--|
| RTWFileNameOpts | File name options | {'Auto'} 'Use subsystem name' 'Use function name' 'User specified' |
| RTWFileName | File name (no extension) | {''} |
| DataTypeOverride | No dialog box prompt Specifies data type used to override fixed-point data types. Set by Data type override on the Fixed-Point Tool. | {'UseLocalSettings'} 'ScaledDouble' 'Double' 'Single' 'Off' |
| MinMaxOverflowLogging | No dialog box prompt Setting for fixed-point instrumentation. Set by Fixed-point instrumentation mode on the Fixed-Point Tool. | {'UseLocalSettings'} 'MinMaxAndOverflow' 'OverflowOnly' 'Off' |
| IsSubsystemVirtual | | boolean — {'off'} 'on' Read-only |
| In1 (Inport) | | |
| Port | Port number | {'1'} |
| IconDisplay | Icon display | 'Signal name' {'Port number'} 'Port number and signal name' |
| LatchByDelayingOutsideSignal | Latch input by delaying outside signal | {'off'} 'on' |
| LatchInputForFeedbackSignals | Latch input for feedback signals of function-call subsystem outputs | {'off'} 'on' |
| Interpolate | Interpolate data | 'off' {'on'} |
| UseBusObject | Specify properties via bus object | {'off'} 'on' |
| BusObject | Bus object for specifying bus properties | {'BusObject'} |
| BusOutputAsStruct | Output as nonvirtual bus | {'off'} 'on' |
| PortDimensions | Port dimensions (-1 for inherited) | {'-1'} |
| SampleTime | Sample time (-1 for inherited) | {'-1'} |
| OutMin | Minimum | {'[]'} |
| OutMax | Maximum | {'[]'} |

| Block (Type)/Parameter | Dialog Box Prompt | Values |
|-------------------------------|--|--|
| OutDataTypeStr | Data type | {'Inherit: auto'} 'double' 'single' 'int8' 'uint8' 'int16' 'uint16' 'int32' 'uint32' 'int64' 'uint64' 'boolean' 'fixdt(1,16,0)' 'fixdt(1,16,2^0,0)' 'Enum: <class name>' |
| LockScale | Lock output data type setting against changes by the fixed-point tools | {'off'} 'on' |
| Unit | Specify physical unit of the input signal to the block. | {'inherit'} '<Enter unit>' |
| UnitNoProp | Specify physical unit of the input signal to the block without propagation. For a list of acceptable units, see Allowed Units. | '<Enter unit>' |
| SignalType | Signal type | {'auto'} 'real' 'complex' |
| Model (ModelReference) | | |
| ModelNameDialog | The name of the referenced model exactly as you typed it in, with any surrounding whitespace removed. When you set <code>ModelNameDialog</code> programmatically or interactively, Simulink automatically sets the values of <code>ModelName</code> and <code>ModelFile</code> based on the value of <code>ModelNameDialog</code> . | {'<Enter Model Name>'} |
| ModelName | The value of <code>ModelNameDialog</code> stripped of any filename extension that you provided. For backward compatibility, setting <code>ModelName</code> programmatically actually sets <code>ModelNameDialog</code> , which then sets <code>ModelName</code> as described. You cannot use <code>get_param</code> to obtain the <code>ModelName</code> of a protected model, because the name without a suffix would be ambiguous. Use <code>get_param</code> on <code>ModelFile</code> instead. You can test <code>ProtectedModel</code> to determine programmatically whether a referenced model is protected. | character vector — Set automatically when <code>ModelNameDialog</code> is set. |

| Block (Type)/Parameter | Dialog Box Prompt | Values |
|-------------------------|---|---|
| ModelFile | The value of ModelNameDialog with a filename extension. The suffix of the first match Simulink finds becomes the suffix of ModelFile. Setting ModelFile programmatically actually sets ModelNameDialog, which then sets ModelFile as described. | character vector — Set automatically when ModelNameDialog is set. |
| ProtectedModel | Read-only boolean indicating whether the model referenced by the block is protected (on) or unprotected (off). | boolean — 'off' 'on' — Set automatically when ModelNameDialog is set. |
| InstanceParameters | Structure array of instance-specific parameters on the Model block. | structure with fields: Name, Value, Path, and Argument. |
| ParameterArgumentNames | Names of instance-specific parameters that the referenced model defines. Corresponds to the Name column in the table on the Instance parameters tab. | { '' } |
| ParameterArgumentValues | Values for model arguments. Corresponds to the Value column in the table on the Instance parameters tab. | structure with no fields |
| SimulationMode | Specifies whether to simulate the model by generating and executing code or by interpreting the model in Simulink software. | { 'Normal' } 'Accelerator' 'Software-in-the-loop (SIL)' 'Processor-in-the-loop (PIL)' |
| DefaultDataLogging | | { 'off' } 'on' |
| Out1 (Output) | | |
| Port | Port number | { '1' } |
| IconDisplay | Icon display | 'Signal name' { 'Port number' } 'Port number and signal name' |
| UseBusObject | Specify properties via bus object | { 'off' } 'on' |
| BusObject | Bus object for validating input bus | { 'BusObject' } |
| BusOutputAsStruct | Output as nonvirtual bus in parent model | { 'off' } 'on' |
| PortDimensions | Port dimensions (-1 for inherited) | { '-1' } |
| VarSizeSig | Variable-size signal | { 'Inherit' } 'No' 'Yes' |
| SampleTime | Sample time (-1 for inherited) | { '-1' } |
| OutMin | Minimum | { '[]' } |
| OutMax | Maximum | { '[]' } |

| Block (Type)/Parameter | Dialog Box Prompt | Values |
|---------------------------|---|--|
| OutDataTypeStr | Data type | {'Inherit: auto'} 'double' 'single' 'int8' 'uint8' 'int16' 'uint16' 'int32' 'uint32' 'int64' 'uint64' 'boolean' 'fixdt(1,16,0)' 'fixdt(1,16,2^0,0)' 'Enum: <class name>' 'Bus: <object name>' |
| LockScale | Lock output data type setting against changes by the fixed-point tools | {'off'} 'on' |
| Unit | Specify physical unit of the input signal to the block. For a list of acceptable units, see Allowed Units. | {'inherit'} '<Enter unit>' |
| UnitNoProp | Specify physical unit of the input signal to the block without propagation. For a list of acceptable units, see Allowed Units. | '<Enter unit>' |
| SignalObject | This parameter does not appear in the block dialog box. Use the Model Data Editor instead. See “Design Data Interface by Configuring Inport and Outport Blocks” (Simulink Coder). | Simulink.Signal object Object of a class that is derived from Simulink.Signal |
| StorageClass | This parameter does not appear in the block dialog box. Use the Model Data Editor instead. See “Design Data Interface by Configuring Inport and Outport Blocks” (Simulink Coder). | {'Auto'} 'Model default' 'ExportedGlobal' 'ImportedExtern' 'ImportedExternPointer' 'Custom' |
| SignalName | Signal name | character vector |
| SignalType | Signal type | {'auto'} 'real' 'complex' |
| OutputWhenDisabled | Output when disabled | {'held'} 'reset' |
| InitialOutput | Initial output | {'[]'} |
| MustResolveToSignalObject | This parameter does not appear in the block dialog box. Use the Model Data Editor instead. See “For Signals”. | {'off'} 'on' |
| Subsystem (SubSystem) | | |

| Block (Type)/Parameter | Dialog Box Prompt | Values |
|--|--|---|
| ShowPortLabels | Show port labels Note The values 'off' and 'on' are for backward compatibility only and should not be used in new models or when updating existing models. | 'none' {'FromPortIcon'} 'FromPortBlockName' 'SignalName' 'off' 'on' |
| BlockChoice | Block choice | {''} |
| TemplateBlock | Template block | {''} |
| MemberBlocks | Member blocks | {''} |
| Permissions | Read/Write permissions | {'ReadWrite'} 'ReadOnly' 'NoReadOrWrite' |
| ErrorFcn | Name of error callback function | {''} |
| PermitHierarchicalResolution | Permit hierarchical resolution | {'All'} 'ExplicitOnly' 'None' |
| TreatAsAtomicUnit | Treat as atomic unit | {'off'} 'on' |
| TreatAsGroupedWhenPropagatingVariantConditions | Treat as grouped when propagating variant conditions | 'off' {'on'} |
| VariantControl | Variant control | {'Variant'} '(default)' |
| MinAlgLoopOccurrences | Minimize algebraic loop occurrences | {'off'} 'on' |
| CheckFcnCallInpInsideContextMsg | Warn if function-call inputs are context-specific | {'off'} 'on' |
| SystemSampleTime | Sample time (-1 for inherited) | {'-1'} |
| RTWSystemCode | Code generation function packaging | {'Auto'} 'Inline' 'Nonreusable function' 'Reusable function' |
| RTWFcnNameOpts | Code generation function name options | {'Auto'} 'Use subsystem name' 'User specified' |
| RTWFcnName | Code generation function name | {''} |
| RTWFileNameOpts | Code generation file name options | {'Auto'} 'Use subsystem name' 'Use function name' 'User specified' |
| RTWFileName | Code generation file name (no extension) | {''} |
| DataTypeOverride | Specifies data type used to override fixed-point data types. Set by Data type override on the Fixed-Point Tool. | {'UseLocalSettings'} 'ScaledDouble' 'Double' 'Single' 'Off' |

| Block (Type)/Parameter | Dialog Box Prompt | Values |
|--|--|---|
| MinMaxOverflowLogging | No dialog box prompt Setting for fixed-point instrumentation. Set by Fixed-point instrumentation mode on the Fixed-Point Tool. | {'UseLocalSettings'} 'MinMaxAndOverflow' 'OverflowOnly' 'ForceOff' |
| IsSubsystemVirtual | | boolean — {'on'} 'off' Read-only |
| Virtual | For internal use | |
| Switch Case (SwitchCase) | | |
| CaseConditions | Case conditions (e.g., {1,[2,3]}) | {' {1}'} |
| ShowDefaultCase | Show default case | 'off' {'on'} |
| ZeroCross | Enable zero-crossing detection | 'off' {'on'} |
| SampleTime | Sample time (-1 for inherited) | {' -1'} |
| CaseShowDefault | Deprecated in R2009b | |
| Switch Case Action Subsystem (SubSystem) | | |
| ShowPortLabels | Show port labels Note The values 'off' and 'on' are for backward compatibility only and should not be used in new models or when updating existing models. | 'none' {'FromPortIcon'} 'FromPortBlockName' 'SignalName' 'off' 'on' |
| BlockChoice | Block choice | {' '} |
| TemplateBlock | Template block | {' '} |
| MemberBlocks | Member blocks | {' '} |
| Permissions | Read/Write permissions | {'ReadWrite'} 'ReadOnly' 'NoReadOrWrite' |
| ErrorFcn | Name of error callback function | {' '} |
| PermitHierarchicalResolution | Permit hierarchical resolution | {'All'} 'ExplicitOnly' 'None' |
| TreatAsAtomicUnit | Treat as atomic unit | 'off' {'on'} |
| MinAlgLoopOccurrences | Minimize algebraic loop occurrences | {'off'} 'on' |
| CheckFcnCallInpInsideContextMsg | Warn if function-call inputs are context-specific | {'off'} 'on' |
| SystemSampleTime | Sample time (-1 for inherited) | {' -1'} |
| RTWSystemCode | Code generation function packaging | {'Auto'} 'Inline' 'Nonreusable function' 'Reusable function' |

| Block (Type)/Parameter | Dialog Box Prompt | Values |
|-------------------------|--|--|
| RTWFcnNameOpts | Code generation function name options | {'Auto'} 'Use subsystem name' 'User specified' |
| RTWFcnName | Code generation function name | {''} |
| RTWFileNameOpts | Code generation file name options | {'Auto'} 'Use subsystem name' 'Use function name' 'User specified' |
| RTWFileName | Code generation file name (no extension) | {''} |
| DataTypeOverride | No dialog box prompt Specifies data type used to override fixed-point data types. Set by Data type override on the Fixed-Point Tool. | {'UseLocalSettings'} 'ScaledDouble' 'Double' 'Single' 'Off' |
| MinMaxOverflowLogging | No dialog box prompt Setting for fixed-point instrumentation. Set by Fixed-point instrumentation mode on the Fixed-Point Tool. | {'UseLocalSettings'} 'MinMaxAndOverflow' 'OverflowOnly' 'ForceOff' |
| IsSubsystemVirtual | | boolean — {'off'} 'on' Read-only |
| Trigger (TriggerPort) | | |
| TriggerType | Trigger type | {'rising'} 'falling' 'either' 'function-call' |
| IsSimulinkFunction | Configure the Function-call subsystem to be a Simulink Function | {'off'} 'on' |
| StatesWhenEnabling | States when enabling | {'held'} 'reset' 'inherit' |
| PropagateVarSize | Propagate sizes of variable-size signals | {'During execution'} 'Only when enabling' |
| ShowOutputPort | Show output port | {'off'} 'on' |
| OutputDataType | Output data type | {'auto'} 'double' 'int8' |
| SampleTimeType | Sample time type | {'triggered'} 'periodic' |
| SampleTime | Sample time | {'1'} |
| ZeroCross | Enable zero-crossing detection | 'off' {'on'} |
| PortDimensions | Port dimensions (-1 for inherited) | {'-1'} |
| TriggerSignalSampleTime | Trigger signal sample time | {'-1'} |
| OutMin | Minimum | {'[]'} |
| OutMax | Maximum | {'[]'} |

| Block (Type)/Parameter | Dialog Box Prompt | Values |
|---------------------------------|--|--|
| OutDataTypeStr | Data type | {'Inherit: auto'} 'double' 'single' 'int8' 'uint8' 'int16' 'uint16' 'int32' 'uint32' 'int64' 'uint64' 'boolean' 'fixdt(1,16,0)' 'fixdt(1,16,2^0,0)' 'Enum: <class name>' |
| Interpolate | Interpolate data | 'off' {'on'} |
| Triggered Subsystem (SubSystem) | | |
| ShowPortLabels | Show port labels Note The values 'off' and 'on' are for backward compatibility only and should not be used in new models or when updating existing models. | 'none' {'FromPortIcon'} 'FromPortBlockName' 'SignalName' 'off' 'on' |
| BlockChoice | Block choice | {''} |
| TemplateBlock | Template block | {''} |
| MemberBlocks | Member blocks | {''} |
| Permissions | Read/Write permissions | {'ReadWrite'} 'ReadOnly' 'NoReadOrWrite' |
| ErrorFcn | Name of error callback function | {''} |
| PermitHierarchicalResolution | Permit hierarchical resolution | {'All'} 'ExplicitOnly' 'None' |
| TreatAsAtomicUnit | Treat as atomic unit | 'off' {'on'} |
| MinAlgLoopOccurrences | Minimize algebraic loop occurrences | {'off'} 'on' |
| CheckFcnCallInpInsideContextMsg | Warn if function-call inputs are context-specific | {'off'} 'on' |
| SystemSampleTime | Sample time (-1 for inherited) | {'-1'} |
| RTWSystemCode | Code generation function packaging | {'Auto'} 'Inline' 'Nonreusable function' 'Reusable function' |
| RTWFcnNameOpts | Code generation function name options | {'Auto'} 'Use subsystem name' 'User specified' |
| RTWFcnName | Code generation function name | {''} |
| RTWFileNameOpts | Code generation file name options | {'Auto'} 'Use subsystem name' 'Use function name' 'User specified' |

| Block (Type)/Parameter | Dialog Box Prompt | Values |
|--------------------------------------|--|---|
| RTWFileName | Code generation file name (no extension) | {''} |
| DataTypeOverride | No dialog box prompt Specifies data type used to override fixed-point data types. Set by Data type override on the Fixed-Point Tool. | {'UseLocalSettings'} 'ScaledDouble' 'Double' 'Single' 'Off' |
| MinMaxOverflowLogging | No dialog box prompt Setting for fixed-point instrumentation. Set by Fixed-point instrumentation mode on the Fixed-Point Tool. | {'UseLocalSettings'} 'MinMaxAndOverflow' 'OverflowOnly' 'ForceOff' |
| IsSubsystemVirtual | | boolean — {'off'} 'on' Read-only |
| Unit Conversion | | |
| OutDataTypeStr | Output data type | {'Inherit via internal rule'} 'Inherit via back propagation' |
| Unit System Configuration | | |
| AllowAllUnitSystems | Allow or restrict unit systems. | boolean — {'on'} 'off' |
| UnitSystems | Displays allowed unit system. | cell array of character vectors — {'SI', 'English', 'SI (extended)', 'CGS'} |
| While Iterator (WhileIterator) | | |
| MaxIters | Maximum number of iterations (-1 for unlimited) | {'5'} |
| WhileBlockType | While loop type | {'while'} 'do-while' |
| ResetStates | States when starting | {'held'} 'reset' |
| ShowIterationPort | Show iteration number port | {'off'} 'on' |
| OutputDataType | Output data type | {'int32'} 'int16' 'int8' 'double' |
| While Iterator Subsystem (SubSystem) | | |
| ShowPortLabels | Show port labels Note The values 'off' and 'on' are for backward compatibility only and should not be used in new models or when updating existing models. | 'none' {'FromPortIcon'} 'FromPortBlockName' 'SignalName' 'off' 'on' |
| BlockChoice | Block choice | {''} |

| Block (Type)/Parameter | Dialog Box Prompt | Values |
|---------------------------------|--|--|
| TemplateBlock | Template block | {''} |
| MemberBlocks | Member blocks | {''} |
| Permissions | Read/Write permissions | {'ReadWrite'} 'ReadOnly' 'NoReadOrWrite' |
| ErrorFcn | Name of error callback function | {''} |
| PermitHierarchicalResolution | Permit hierarchical resolution | {'All'} 'ExplicitOnly' 'None' |
| TreatAsAtomicUnit | Treat as atomic unit | 'off' {'on'} |
| MinAlgLoopOccurrences | Minimize algebraic loop occurrences | {'off'} 'on' |
| CheckFcnCallInpInsideContextMsg | Warn if function-call inputs are context-specific | {'off'} 'on' |
| SystemSampleTime | Sample time (-1 for inherited) | {'-1'} |
| RTWSystemCode | Code generation function packaging | {'Auto'} 'Inline' 'Nonreusable function' 'Reusable function' |
| RTWFcnNameOpts | Code generation function name options | {'Auto'} 'Use subsystem name' 'User specified' |
| RTWFcnName | Code generation function name | {''} |
| RTWFileNameOpts | Code generation file name options | {'Auto'} 'Use subsystem name' 'Use function name' 'User specified' |
| RTWFileName | Code generation file name (no extension) | {''} |
| DataTypeOverride | No dialog box prompt Specifies data type used to override fixed-point data types. Set by Data type override on the Fixed-Point Tool. | {'UseLocalSettings'} 'ScaledDouble' 'Double' 'Single' 'Off' |
| MinMaxOverflowLogging | No dialog box prompt Setting for fixed-point instrumentation. Set by Fixed-point instrumentation mode on the Fixed-Point Tool. | {'UseLocalSettings'} 'MinMaxAndOverflow' 'OverflowOnly' 'ForceOff' |
| IsSubsystemVirtual | | boolean — {'off'} 'on' Read-only |
| Variant Subsystem (Subsystem) | | |
| Variant | No dialog box prompt Check if the subsystem is a Variant Subsystem block. | boolean — {'off'} 'on' Read-only |

| Block (Type)/Parameter | Dialog Box Prompt | Values |
|--|---|--|
| VariantChoices | No dialog box prompt List of variant choices in a Variant Subsystem block. | { ' ' } The value is an empty structure array if the block is not a Variant Subsystem block. Otherwise, the value is a structure array with fields: Name and BlockName. Read-only |
| VariantControl | Variant control for the choice block of a Variant Subsystem block. | { ' ' } The value is an empty character vector if the block is not a variant choice. Otherwise, the value is the variant control for the choice block. |
| VariantControlMode | Specifies the mode used to determine the active variant choice. | {'expression'} 'label' 'sim codegen switching' |
| LabelModeActiveChoice | Specifies the variant control label of the active choice for the Variant Subsystem block when VariantControlMode is specified as label. | { ' ' } The value is an empty character vector if the VariantControlMode for the Variant Subsystem block is not label. Otherwise, the value is the variant control label for the active choice. |
| TreatAsGroupedWhenPropagatingVariantConditions | No dialog box prompt Specifies if the subsystem is treated as a group when propagating variant conditions. | boolean — {'on'} 'off' |
| GeneratePreprocessorConditionals | No dialog box prompt Specifies if all the choices are to be analyzed and if preprocessor conditionals should be generated. | boolean — {'off'} 'on' |
| PropagateVariantConditions | Specifies if variant conditions on the ports inside the Variant Subsystem block should be propagated outside the block. Note Use the “Variant activation time” on page 1-0 parameter instead. | boolean — {'off'} 'on' |
| AllowZeroVariantControls | Specifies if the Variant Subsystem block is allowed to have no active choices. | boolean — {'off'} 'on' |

| Block (Type)/Parameter | Dialog Box Prompt | Values |
|-------------------------------|--|---|
| Variant Activation Time | Specifies when the active choice of a Variant Subsystem block is set. The Variant activation time parameter is available only when you set the Variant control mode parameter to expression or sim codegen switching. | {'update diagram'} 'update diagram analyze all choices' 'code compile' |

Signal Attributes Library Block Parameters

| Block (Type)/Parameter | Dialog Box Prompt | Values |
|--|--|--|
| Bus to Vector (BusToVector) | | |
| Data Type Conversion (DataTypeConversion) | | |
| OutMin | Output minimum | {'[]'} |
| OutMax | Output maximum | {'[]'} |
| OutDataTypeStr | Output data type | {'Inherit: Inherit via back propagation'} 'double' 'single' 'int8' 'uint8' 'int16' 'uint16' 'int32' 'uint32' 'int64' 'uint64' 'boolean' 'fixdt(1,16,0)' 'fixdt(1,16,2^0,0)' 'Enum: <class name>' |
| LockScale | Lock output data type setting against changes by the fixed-point tools | {'off'} 'on' |
| ConvertRealWorld | Input and output to have equal | {'Real World Value (RWV)' 'Stored Integer (SI)'} 'Stored Integer (SI)' |
| RndMeth | Integer rounding mode | 'Ceiling' 'Convergent' {'Floor'} 'Nearest' 'Round' 'Simplest' 'Zero' |
| SaturateOnInteger Overflow | Saturate on integer overflow | {'off'} 'on' |
| SampleTime | Sample time (-1 for inherited) | {'-1'} |
| Data Type Conversion Inherited (Conversion Inherited) (masked subsystem) | | |
| ConvertRealWorld | Input and Output to have equal | {'Real World Value'} 'Stored Integer' |
| RndMeth | Integer rounding mode | 'Ceiling' 'Convergent' {'Floor'} 'Nearest' 'Round' 'Simplest' 'Zero' |
| DoSatur | Saturate to max or min when overflows occur | {'off'} 'on' |
| Data Type Duplicate (DataTypeDuplicate) | | |
| NumInputPorts | Number of input ports | {'2'} |
| Data Type Propagation (Data Type Propagation) (masked subsystem) | | |
| PropDataTypeMode | 1. Propagated data type | 'Specify via dialog' {'Inherit via propagation rule'} |
| PropDataType | 1.1. Propagated data type (e.g., fixdt(1,16), fixdt('single')) | {'fixdt(1,16)'} 'fixdt('single')' |

| Block (Type)/Parameter | Dialog Box Prompt | Values |
|-------------------------------|--|---|
| IfRefDouble | 1.1. If any reference input is double, output is | {'double'} 'single' |
| IfRefSingle | 1.2. If any reference input is single, output is | 'double' {'single'} |
| IsSigned | 1.3. Is-Signed | 'IsSigned1' 'IsSigned2' {'IsSigned1 or IsSigned2'} 'TRUE' 'FALSE' |
| NumBitsBase | 1.4.1. Number-of-Bits: Base | 'NumBits1' 'NumBits2' {'max([NumBits1 NumBits2])'} 'min([NumBits1 NumBits2])' 'NumBits1+NumBits2' |
| NumBitsMult | 1.4.2. Number-of-Bits: Multiplicative adjustment | {'1'} |
| NumBitsAdd | 1.4.3. Number-of-Bits: Additive adjustment | {'0'} |
| NumBitsAllowFinal | 1.4.4. Number-of-Bits: Allowable final values | {'1:128'} |
| PropScalingMode | 2. Propagated scaling | 'Specify via dialog' {'Inherit via propagation rule'} 'Obtain via best precision' |
| PropScaling | 2.1. Propagated scaling: Slope or [Slope Bias] ex. 2 ⁻⁹ | {'2 ⁻¹⁰ '} |
| ValuesUsedBestPrec | 2.1. Values used to determine best precision scaling | {'[5 -7]'} |
| SlopeBase | 2.1.1. Slope: Base | 'Slope1' 'Slope2' 'max([Slope1 Slope2])' {'min([Slope1 Slope2])'} 'Slope1*Slope2' 'Slope1/Slope2' 'PosRange1' 'PosRange2' 'max([PosRange1 PosRange2])' 'min([PosRange1 PosRange2])' 'PosRange1*PosRange2' 'PosRange1/PosRange2' |
| SlopeMult | 2.1.2. Slope: Multiplicative adjustment | {'1'} |
| SlopeAdd | 2.1.3. Slope: Additive adjustment | {'0'} |

| Block (Type)/Parameter | Dialog Box Prompt | Values |
|--|--|---|
| BiasBase | 2.2.1. Bias: Base | {'Bias1'} 'Bias2' 'max([Bias1 Bias2])' 'min([Bias1 Bias2])' 'Bias1*Bias2' 'Bias1/Bias2' 'Bias1+Bias2' 'Bias1-Bias2' |
| BiasMult | 2.2.2. Bias: Multiplicative adjustment | {'1'} |
| BiasAdd | 2.2.3. Bias: Additive adjustment | {'0'} |
| Data Type Scaling Strip (Scaling Strip) (masked subsystem) | | |
| IC (InitialCondition) | | |
| Value | Initial value | {'1'} |
| SampleTime | Sample time (-1 for inherited) | {'-1'} |
| Probe (Probe) | | |
| ProbeWidth | Probe width | 'off' {'on'} |
| ProbeSampleTime | Probe sample time | 'off' {'on'} |
| ProbeComplexSignal | Detect complex signal | 'off' {'on'} |
| ProbeSignalDimensions | Probe signal dimensions | 'off' {'on'} |
| ProbeFramedSignal | Detect framed signal | 'off' {'on'} |
| ProbeWidthDataType | Data type for width | {'double'} 'single' 'int8' 'uint8' 'int16' 'uint16' 'int32' 'uint32' 'Same as input' |
| ProbeSampleTimeDataType | Data type for sample time | {'double'} 'single' 'int8' 'uint8' 'int16' 'uint16' 'int32' 'uint32' 'Same as input' |
| ProbeComplexityDataType | Data type for signal complexity | {'double'} 'single' 'int8' 'uint8' 'int16' 'uint16' 'int32' 'uint32' 'boolean' 'Same as input' |
| ProbeDimensionsDataType | Data type for signal dimensions | {'double'} 'single' 'int8' 'uint8' 'int16' 'uint16' 'int32' 'uint32' 'Same as input' |
| ProbeFrameDataType | Data type for signal frames | {'double'} 'single' 'int8' 'uint8' 'int16' 'uint16' 'int32' 'uint32' 'boolean' 'Same as input' |
| Rate Transition (RateTransition) | | |

| Block (Type)/Parameter | Dialog Box Prompt | Values |
|--|--|---|
| Integrity | Ensure data integrity during data transfer | 'off' {'on'} |
| Deterministic | Ensure deterministic data transfer (maximum delay) | 'off' {'on'} |
| InitialCondition | Initial conditions | {'0'} |
| OutPortSampleTimeOpt | Output port sample time options | {'Specify'} 'Inherit' 'Multiple of input port sample time' |
| OutPortSampleTimeMultiple | Sample time multiple (>0) | {'1'} |
| OutPortSampleTime | Output port sample time | {'-1'} |
| Signal Conversion (SignalConversion) | | |
| ConversionOutput | Output | {'Signal copy'} 'Virtual bus' 'Nonvirtual bus' |
| OutDataTypeStr | Data type | {'Inherit: auto'} 'Bus: <object name>' |
| OverrideOpt | Exclude this block from 'Block reduction' optimization | {'off'} 'on' |
| Signal Specification (SignalSpecification) | | |
| Dimensions | Dimensions (-1 for inherited) | {'-1'} |
| VarSizeSig | Variable-size signal | {'Inherit'} 'No' 'Yes' |
| SampleTime | Sample time (-1 for inherited) | {'-1'} |
| OutMin | Minimum | {'[]'} |
| OutMax | Maximum | {'[]'} |
| OutDataTypeStr | Data type | {'Inherit: auto'} 'double' 'single' 'int8' 'uint8' 'int16' 'uint16' 'int32' 'uint32' 'int64' 'uint64' 'boolean' 'fixdt(1,16,0)' 'fixdt(1,16,2^0,0)' 'Enum: <class name>' 'Bus: <object name>' |
| BusOutputAsStruct | Require nonvirtual bus | {'off'} 'on' |
| Unit | Specify physical unit of the input signal to the block. For a list of acceptable units, see Allowed Units. | {'inherit'} '<Enter unit>' |
| UnitNoProp | Specify physical unit of the input signal to the block without propagation. For a list of acceptable units, see Allowed Units. | '<Enter unit>' |

| Block (Type)/Parameter | Dialog Box Prompt | Values |
|---------------------------------------|--|---|
| LockScale | Lock output data type setting against changes by the fixed-point tools | {'off'} 'on' |
| SignalType | Signal type | {'auto'} 'real' 'complex' |
| Weighted Sample Time (SampleTimeMath) | | |
| TsampMathOp | Operation | '+' '-' '*' '/' {'Ts Only'} '1/Ts Only' |
| weightValue | Weight value | {'1.0'} |
| TsampMathImp | Implement using | {'Online Calculations'} 'Offline Scaling Adjustment' |
| OutDataTypeStr | Output data type | {'Inherit via internal rule'} 'Inherit via back propagation' |
| RndMeth | Integer rounding mode | 'Ceiling' 'Convergent' {'Floor'} 'Nearest' 'Round' 'Simplest' 'Zero' |
| SaturateOnInteger Overflow | Saturate on integer overflow | {'off'} 'on' |
| OutputDataTypeScaling Mode | Deprecated in R2009b | |
| DoSatur | Deprecated in R2009b | |
| Width (Width) | | |
| OutputDataTypeScaling Mode | Output data type mode | {'Choose intrinsic data type'} 'Inherit via back propagation' 'All ports same datatype' |
| DataType | Output data type | {'double'} 'single' 'int8' 'uint8' 'int16' 'uint16' 'int32' 'uint32' |

Signal Routing Library Block Parameters

| Block (Type)/Parameter | Dialog Box Prompt | Values |
|-------------------------------------|--|---|
| Bus Assignment (BusAssignment) | | |
| AssignedSignals | Elements that are being assigned | { '' } |
| InputSignals | Elements in the bus | matrix — { '{' } } |
| Bus Creator (BusCreator) | | |
| InheritFromInputs | Use names from inputs instead of from bus object | { 'on' } 'off' If set to 'on', overrides bus signal names from inputs. Otherwise, inherits bus signal names from a bus object. |
| Inputs | Number of inputs | { '2' } |
| DisplayOption | | 'none' 'signals' { 'bar' } |
| NonVirtualBus | Output as nonvirtual bus | { 'off' } 'on' |
| OutDataTypeStr | Data type | { 'Inherit: auto' } 'double' 'single' 'int8' 'uint8' 'int16' 'uint16' 'int32' 'uint32' 'int64' 'uint64' 'boolean' 'fixdt(1,16,0)' 'fixdt(1,16,2^0,0)' 'Enum: <class name>' 'Bus: <object name>' |
| Bus Selector (BusSelector) | | |
| OutputSignals | Selected elements | character vector — in the form 'signal1,signal2' |
| OutputAsBus | Output as bus | { 'off' } 'on' |
| InputSignals | Signals in bus | matrix — { '{' } } |
| Data Store Memory (DataStoreMemory) | | |
| DataStoreName | Data store name | { 'A' } |
| ReadBeforeWriteMsg | Detect read before write | 'none' { 'warning' } 'error' |
| WriteAfterWriteMsg | Detect write after write | 'none' { 'warning' } 'error' |
| WriteAfterReadMsg | Detect write after read | 'none' { 'warning' } 'error' |
| InitialValue | Initial value | { '0' } |
| StateMustResolveToSignalObject | Data store name must resolve to Simulink signal object | { 'off' } 'on' |
| DataLogging | Log Signal Data | 'off' { 'on' } |
| DataLoggingNameMode | Logging Name | { 'SignalName' } 'Custom' |
| DataLoggingName | Logging Name | { '' } |
| DataLoggingLimitDataPoints | Limit data points to last | 'off' { 'on' } |
| DataLoggingMaxPoints | Limit data points to last | non-zero integer {5000} |

| Block (Type)/Parameter | Dialog Box Prompt | Values |
|-----------------------------------|---|---|
| DataLoggingDecimateData | Decimation | 'off' {'on'} |
| DataLoggingLimitDataPoints | Decimation | non-zero integer {2} |
| StateStorageClass | Storage class | {'Auto'} 'Model default' 'ExportedGlobal' 'ImportedExtern' 'ImportedExternPointer' 'Custom' |
| StateSignalObject | Signal object class Storage class | Simulink.Signal object Object of a class that is derived from Simulink.Signal |
| RTWStateStorageTypeQualifier | Code generation type qualifier | {''} |
| VectorParams1D | Interpret vector parameters as 1-D | 'off' {'on'} |
| ShowAdditionalParam | Show additional parameters | {'off'} 'on' |
| OutMin | Minimum | {'[]'} |
| OutMax | Maximum | {'[]'} |
| OutDataTypeStr | Data type | {'Inherit: auto'} 'double' 'single' 'int8' 'uint8' 'int16' 'uint16' 'int32' 'uint32' 'boolean' 'fixdt(1,16,0)' 'fixdt(1,16,2^0,0)' 'Enum: <class name>' |
| LockScale | Lock output data type setting against changes by the fixed-point tools | {'off'} 'on' |
| SignalType | Signal type | {'auto'} 'real' 'complex' |
| Data Store Read (DataStoreRead) | | |
| DataStoreElements | Corresponds to the parameters on the Element Selection tab of the block dialog box. See "Specification using the command line". | |
| DataStoreName | Data store name | {'A'} |
| SampleTime | Sample time | {'0'} |
| Data Store Write (DataStoreWrite) | | |
| DataStoreElements | Corresponds to the parameters on the Element Assignment tab of the block dialog box. See "Specification using the command line". | |

| Block (Type)/Parameter | Dialog Box Prompt | Values |
|--|--|---|
| DataStoreName | Data store name | {'A'} |
| SampleTime | Sample time (-1 for inherited) | {'-1'} |
| Demux (Demux) | | |
| Outputs | Number of outputs | {'2'} |
| DisplayOption | Display option | 'none' {'bar'} |
| Environment Controller (Environment Controller) (masked subsystem) | | |
| From (From) | | |
| GotoTag | Goto tag | {'A'} |
| IconDisplay | Icon display | 'Signal name' {'Tag'} 'Tag and signal name' |
| Goto (Goto) | | |
| GotoTag | Goto tag | {'A'} |
| IconDisplay | Icon display | 'Signal name' {'Tag'} 'Tag and signal name' |
| TagVisibility | Tag visibility | {'local'} 'scoped' 'global' |
| Goto Tag Visibility (GotoTagVisibility) | | |
| GotoTag | Goto tag | {'A'} |
| Index Vector (MultiPortSwitch) | | |
| DataPortOrder | Data port order | {'Zero-based contiguous'} 'One-based contiguous' 'Specify indices' |
| Inputs | Number of data ports | {'1'} |
| zeroidx | Deprecated in R2010a | |
| SampleTime | Sample time (-1 for inherited) | {'-1'} |
| InputSameDT | Require all data port inputs to have the same data type | {'off'} 'on' |
| OutMin | Output minimum | {'[]'} |
| OutMax | Output maximum | {'[]'} |
| OutDataTypeStr | Output data type | {'Inherit: Inherit via internal rule'} 'Inherit: Inherit via back propagation' 'double' 'single' 'int8' 'uint8' 'int16' 'uint16' 'int32' 'uint32' 'fixdt(1,16,0)' 'fixdt(1,16,2^0,0)' |
| LockScale | Lock output data type setting against changes by the fixed-point tools | {'off'} 'on' |

| Block (Type)/Parameter | Dialog Box Prompt | Values |
|--|---|--|
| RndMeth | Integer rounding mode | 'Ceiling' 'Convergent' {'Floor'} 'Nearest' 'Round' 'Simplest' 'Zero' |
| SaturateOnIntegerOverflow | Saturate on integer overflow | {'off'} 'on' |
| AllowDiffInputSizes | Allow different data input sizes (Results in variable-size output signal) | {'off'} 'on' |
| Manual Switch (Manual Switch) (masked subsystem) | | |
| varsize | Allow different input sizes (Results in variable-size output signal) | {'off'} 'on' |
| SampleTime | Sample time (-1 for inherited) | {'-1'} |
| Merge (Merge) | | |
| Inputs | Number of inputs | {'2'} |
| InitialOutput | Initial output | {'[]'} |
| AllowUnequalInputPortWidths | Allow unequal port widths | {'off'} 'on' |
| InputPortOffsets | Input port offsets | {'[]'} |
| Multiport Switch (MultiPortSwitch) | | |
| DataPortOrder | Data port order | 'Zero-based contiguous' {'One-based contiguous'} 'Specify indices' |
| Inputs | Number of data ports | {'3'} |
| zeroidx | Deprecated in R2010a | |
| DataPortIndices | Data port indices | {'1,2,3'} |
| DataPortForDefault | Data port for default case | {'Last data port'} 'Additional data port' |
| DiagnosticForDefault | Diagnostic for default case | 'None' 'Warning' {'Error'} |
| SampleTime | Sample time (-1 for inherited) | {'-1'} |
| InputSameDT | Require all data port inputs to have the same data type | {'off'} 'on' |
| OutMin | Output minimum | {'[]'} |
| OutMax | Output maximum | {'[]'} |
| OutDataTypeStr | Output data type | {'Inherit: Inherit via internal rule'} 'Inherit: Inherit via back propagation' 'double' 'single' 'int8' 'uint8' 'int16' 'uint16' 'int32' 'uint32' 'int64' 'uint64' 'fixdt(1,16,0)' 'fixdt(1,16,2^0,0)' |

| Block (Type)/Parameter | Dialog Box Prompt | Values |
|----------------------------|---|--|
| LockScale | Lock output data type setting against changes by the fixed-point tools | {'off'} 'on' |
| RndMeth | Integer rounding mode | 'Ceiling' 'Convergent' {'Floor'} 'Nearest' 'Round' 'Simplest' 'Zero' |
| SaturateOnInteger Overflow | Saturate on integer overflow | {'off'} 'on' |
| AllowDiffInputSizes | Allow different data input sizes (Results in variable-size output signal) | {'off'} 'on' |
| Mux (Mux) | | |
| Inputs | Number of inputs | {'2'} |
| DisplayOption | Display option | 'none' 'signals' {'bar'} |
| UseBusObject | For internal use | |
| BusObject | For internal use | |
| NonVirtualBus | For internal use | |
| Selector (Selector) | | |
| NumberOfDimensions | Number of input dimensions | {'1'} |
| IndexMode | Index mode | 'Zero-based' {'One-based'} |
| IndexOptionArray | Index Option | 'Select all' {'Index vector (dialog)'} 'Index vector (port)' 'Starting index (dialog)' 'Starting index (port)' |
| IndexParamArray | Index | cell array |
| OutputSizeArray | Output Size | cell array |
| InputPortWidth | Input port size | {'1'} |
| SampleTime | Sample time (-1 for inherited) | {'-1'} |
| IndexOptions | See the IndexOptionArray parameter for more information. | |
| Indices | See the IndexParamArray parameter for more information. | |
| OutputSizes | See the IndexParamArray parameter for more information. | |
| Switch (Switch) | | |
| Criteria | Criteria for passing first input | {'u2 >= Threshold'} 'u2 > Threshold' 'u2 ~= 0' |
| Threshold | Threshold | {'0'} |
| ZeroCross | Enable zero-crossing detection | 'off' {'on'} |
| SampleTime | Sample time (-1 for inherited) | {'-1'} |

| Block (Type)/Parameter | Dialog Box Prompt | Values |
|--------------------------------|--|---|
| InputSameDT | Require all data port inputs to have the same data type | {'off'} 'on' |
| OutMin | Output minimum | {'[]'} |
| OutMax | Output maximum | {'[]'} |
| OutDataTypeStr | Output data type | {'Inherit: Inherit via internal rule'} 'Inherit: Inherit via back propagation' 'double' 'single' 'int8' 'uint8' 'int16' 'uint16' 'int32' 'uint32' 'int64' 'uint64' 'fixdt(1,16,0)' 'fixdt(1,16,2^0,0)' 'Enum: <class name>' |
| LockScale | Lock output data type setting against changes by the fixed-point tools | {'off'} 'on' |
| RndMeth | Integer rounding mode | 'Ceiling' 'Convergent' {'Floor'} 'Nearest' 'Round' 'Simplest' 'Zero' |
| SaturateOnInteger Overflow | Saturate on integer overflow | {'off'} 'on' |
| AllowDiffInputSizes | Allow different input sizes (Results in variable-size output signal) | {'off'} 'on' |
| Variant Source (VariantSource) | | |
| VariantControls | Variant control | {'Variant'} '(default)' |
| LabelModeActiveChoice | Label mode active choice | {''} |
| AllowZeroVariantControls | Allow zero active variant controls | {'off'} 'on' |
| ShowConditionOnBlock | Show variant condition on block | {'off'} 'on' |
| VariantActivationTime | Variant activation time | 'update diagram' 'update diagram analyze all choices' 'code compile' |
| CompiledActiveVariantControl | | string – {''} The value is a empty string if no variant is active; or the name of the active variant. Compile the model before querying this property. |
| CompiledActiveVariantPort | | string – {'-1'} The value is -1 if no variant is active; or the index of the active variant. Compile the model before querying this property. |
| Variant Sink (VariantSink) | | |

| Block (Type)/Parameter | Dialog Box Prompt | Values |
|----------------------------------|------------------------------------|---|
| VariantControls | Variant control | {'Variant'} '(default)' |
| LabelModeActiveChoice | Label mode active choice | {''} |
| AllowZeroVariantControls | Allow zero active variant controls | {'off'} 'on' |
| ShowConditionOnBlock | Show variant condition on block | {'off'} 'on' |
| VariantActivationTime | Variant activation time | 'update diagram' 'update diagram analyze all choices' 'code compile' |
| CompiledActiveVariantControl | | string – {''} The value is a empty string if no variant is active; or the name of the active variant. Compile the model before querying this property. |
| CompiledActiveVariantPort | | string – {'-1'} The value is -1 if no variant is active; or the index of the active variant. Compile the model before querying this property. |
| Vector Concatenate (Concatenate) | | |
| NumInputs | Number of inputs | {'2'} |
| Mode | Mode | {'Vector'} 'Multidimensional array' |

Sinks Library Block Parameters

| Block (Type)/Parameter | Dialog Box Prompt | Values |
|------------------------|--------------------------------|---|
| Display (Display) | | |
| Numeric display format | Format | {'short'} 'long' 'short_e' 'long_e' 'bank' 'hex (Stored Integer)' 'binary (Stored Integer)' 'decimal (Stored Integer)' 'octal (Stored Integer)' |
| Decimation | Decimation | {'1'} |
| Floating | Floating display | {'off'} 'on' |
| SampleTime | Sample time (-1 for inherited) | {'-1'} |
| Floating Scope (Scope) | | |
| Floating | | 'off' {'on'} |
| Location | | vector — {'[376 294 700 533]'} |
| Open | | {'off'} 'on' |
| NumInputPorts | | Do not change this parameter with the command-line. To add inputs, use the signal selector button  . |
| TickLabels | | 'on' 'off' {'OneTimeTick'} |
| ZoomMode | | {'on'} 'xonly' 'yonly' |
| AxesTitles | | character vector |
| Grid | | 'off' {'on'} 'xonly' 'yonly' |
| TimeRange | | {'auto'} |
| YMin | | {'-5'} |
| YMax | | {'5'} |
| SaveToWorkspace | | {'off'} 'on' |
| SaveName | | {'ScopeData'} |
| DataFormat | | {'StructureWithTime'} 'Structure' 'Array' |
| LimitDataPoints | | 'off' {'on'} |
| MaxDataPoints | | {'5000'} |
| Decimation | | {'1'} |
| SampleInput | | {'off'} 'on' |
| SampleTime | | {'0'} |
| Out1 (Output) | | |

| Block (Type)/Parameter | Dialog Box Prompt | Values |
|-------------------------------|---|---|
| Port | Port number | {'1'} |
| IconDisplay | Icon display | 'Signal name' {'Port number'} 'Port number and signal name' |
| BusOutputAsStruct | Output as nonvirtual bus in parent model | {'off'} 'on' |
| PortDimensions | Port dimensions (-1 for inherited) | {'-1'} |
| VarSizeSig | Variable-size signal | {'Inherit'} 'No' 'Yes' |
| SampleTime | Sample time (-1 for inherited) | {'-1'} |
| OutMin | Minimum | {'[]'} |
| OutMax | Maximum | {'[]'} |
| OutDataTypeStr | Data type | {'Inherit: auto'} 'double' 'single' 'int8' 'uint8' 'int16' 'uint16' 'int32' 'uint32' 'int64' 'uint64' 'boolean' 'fixdt(1,16,0)' 'fixdt(1,16,2^0,0)' 'Enum: <class name>' 'Bus: <object name>' |
| LockScale | Lock output data type setting against changes by the fixed-point tools | {'off'} 'on' |
| SignalObject | This parameter does not appear in the block dialog box. Use the Model Data Editor instead. See “Design Data Interface by Configuring Inport and Outport Blocks” (Simulink Coder). | Simulink.Signal object Object of a class that is derived from Simulink.Signal |
| StorageClass | This parameter does not appear in the block dialog box. Use the Model Data Editor instead. See “Design Data Interface by Configuring Inport and Outport Blocks” (Simulink Coder). | {'Auto'} 'Model default' 'ExportedGlobal' 'ImportedExtern' 'ImportedExternPointer' 'Custom' |
| SignalName | Signal name | character vector |
| SignalType | Signal type | {'auto'} 'real' 'complex' |
| OutputWhenDisabled | Output when disabled | {'held'} 'reset' |
| InitialOutput | Initial output | {'[]'} |

| Block (Type)/Parameter | Dialog Box Prompt | Values |
|----------------------------|-------------------------------------|--|
| SampleTime | Sample time (-1 for inherited) | {'-1'} |
| To Workspace (ToWorkspace) | | |
| VariableName | Variable name | {'simout'} |
| MaxDataPoints | Limit data points to last | {'inf'} |
| Decimation | Decimation | {'1'} |
| SampleTime | Sample time (-1 for inherited) | {'-1'} |
| SaveFormat | Save format | {'Timeseries'} 'Structure With Time' 'Structure' 'Array' |
| FixptAsFi | Log fixed-point data as a fi object | {'off'} 'on' |

Sources Library Block Parameters

| Block (Type)/Parameter | Dialog Box Prompt | Values |
|--|--|---|
| Band-Limited White Noise (Band-Limited White Noise) (masked subsystem) | | |
| Cov | Noise power | {' [0.1] '} |
| Ts | Sample time | {' 0.1 '} |
| seed | Seed | {' [23341] '} |
| VectorParams1D | Interpret vector parameters as 1-D | 'off' {'on'} |
| Chirp Signal (chirp) (masked subsystem) | | |
| f1 | Initial frequency | {' 0.1 '} |
| T | Target time | {' 100 '} |
| f2 | Frequency at target time | {' 1 '} |
| VectorParams1D | Interpret vectors parameters as 1-D | 'off' {'on'} |
| Clock (Clock) | | |
| DisplayTime | Display time | {'off'} 'on' |
| Decimation | Decimation | {' 10 '} |
| Constant (Constant) | | |
| Value | Constant value | {' 1 '} |
| VectorParams1D | Interpret vector parameters as 1-D | 'off' {'on'} |
| SampleTime | Sampling time | {'Sample based'} 'Frame based' |
| OutMin | Output minimum | {' [] '} |
| OutMax | Output maximum | {' [] '} |
| OutDataTypeStr | Output data type | {'Inherit: Inherit from 'Constant value'} 'Inherit: Inherit via back propagation' 'double' 'single' 'int8' 'uint8' 'int16' 'uint16' 'int32' 'uint32' 'int64' 'uint64' 'boolean' 'fixdt(1,16)' 'fixdt(1,16,0)' 'fixdt(1,16,2^0,0)' 'Enum: <class name>'} |
| LockScale | Lock output data type setting against changes by the fixed-point tools | {'off'} 'on' |
| SampleTime | Sample time | {'inf'} |
| FramePeriod | Frame period | {'inf'} |
| Counter Free-Running (Counter Free-Running) (masked subsystem) | | |
| NumBits | Number of Bits | {' 16 '} |

| Block (Type)/Parameter | Dialog Box Prompt | Values |
|--|--|--|
| tsamp | Sample time | {'-1'} |
| Counter Limited (Counter Limited) (masked subsystem) | | |
| uplimit | Upper limit | {'7'} |
| tsamp | Sample time | {'-1'} |
| Digital Clock (DigitalClock) | | |
| SampleTime | Sample time | {'1'} |
| Enumerated Constant (EnumeratedConstant) | | |
| OutDataTypeStr | Output data type | {'Enum: SLDemoSign'} |
| Value | Value | {'SLDemoSign.Positive'} 'SLDemoSign.Zero' 'SLDemoSign.Negative' |
| SampleTime | Sample time | {'inf'} |
| From File (FromFile) | | |
| FileName | File name | {'untitled.mat'} |
| ExtrapolationBeforeFirstDataPoint | Data extrapolation before first data point | {'Linear extrapolation'} 'Hold first value' 'Ground value' |
| InterpolationWithinTimeRange | Data interpolation within time range | {'Linear interpolation'} 'Zero order hold' |
| ExtrapolationAfterLastDataPoint | Data extrapolation after last data point | {'Linear extrapolation'} 'Hold last value' 'Ground value' |
| SampleTime | Sample time | {'0'} |
| From Workspace (FromWorkspace) | | |
| VariableName | Data | {'simin'} |
| OutDataTypeStr | Output Data type | {'Inherit: auto'} 'double' 'single' 'int8' 'uint8' 'int16' 'uint16' 'int32' 'uint32' 'int64' 'uint64' 'boolean' 'fixdt(1,16,0)' 'fixdt(1,16,2^0,0)' 'Enum: <class name>' 'Bus: <object name>' |
| SampleTime | Sample time | {'0'} |
| Interpolate | Interpolate data | 'off' {'on'} |
| ZeroCross | Enable zero-crossing detection | 'off' {'on'} |
| OutputAfterFinalValue | Form output after final data value by | {'Extrapolation'} 'Setting to zero' 'Holding final value' 'Cyclic repetition' |

| Block (Type)/Parameter | Dialog Box Prompt | Values |
|--|--|---|
| Ground | | |
| In1 (Inport) | | |
| Port | Port number | {'1'} |
| IconDisplay | Icon display | 'Signal name' {'Port number'} 'Port number and signal name' |
| BusOutputAsStruct | Output as nonvirtual bus | {'off'} 'on' |
| PortDimensions | Port dimensions (-1 for inherited) | {'-1'} |
| VarSizeSig | Variable-size signal | {'Inherit'} 'No' 'Yes' |
| SampleTime | Sample time (-1 for inherited) | {'-1'} |
| OutMin | Minimum | {'[]'} |
| OutMax | Maximum | {'[]'} |
| OutDataTypeStr | Data type | {'Inherit: auto'} 'double' 'single' 'int8' 'uint8' 'int16' 'uint16' 'int32' 'uint32' 'int64' 'uint64' 'boolean' 'fixdt(1,16,0)' 'fixdt(1,16,2^0,0)' 'Enum: <class name>' 'Bus: <object name>' |
| LockScale | Lock output data type setting against changes by the fixed-point tools | {'off'} 'on' |
| Unit | Specify physical unit of the input signal to the block. For a list of acceptable units, see Allowed Units. | {'inherit'} '<Enter unit>' |
| UnitNoProp | Specify physical unit of the input signal to the block without propagation. For a list of acceptable units, see Allowed Units. | '<Enter unit>' |
| SignalType | Signal type | {'auto'} 'real' 'complex' |
| LatchByDelaying OutsideSignal | Latch input by delaying outside signal | {'off'} 'on' |
| LatchInputFor FeedbackSignals | Latch input for feedback signals of function-call subsystem outputs | {'off'} 'on' |
| OutputFunctionCall | Output a function-call trigger signal | {'off'} 'on' |
| Interpolate | Interpolate data | 'off' {'on'} |
| Pulse Generator (DiscretePulseGenerator) | | |

| Block (Type)/Parameter | Dialog Box Prompt | Values |
|--|------------------------------------|--|
| PulseType | Pulse type | {'Time based'} 'Sample based' |
| TimeSource | Time (t) | {'Use simulation time'} 'Use external signal' |
| Amplitude | Amplitude | {'1'} |
| Period | Period | {'10'} |
| PulseWidth | Pulse width | {'5'} |
| PhaseDelay | Phase delay | {'0'} |
| SampleTime | Sample time | {'1'} |
| VectorParams1D | Interpret vector parameters as 1-D | 'off' {'on'} |
| Ramp (Ramp) (masked subsystem) | | |
| slope | Slope | {'1'} |
| start | Start time | {'0'} |
| InitialOutput | Initial output | {'0'} |
| VectorParams1D | Interpret vector parameters as 1-D | 'off' {'on'} |
| Random Number (RandomNumber) | | |
| Mean | Mean | {'0'} |
| Variance | Variance | {'1'} |
| Seed | Seed | {'0'} |
| SampleTime | Sample time | {'0.1'} |
| VectorParams1D | Interpret vector parameters as 1-D | 'off' {'on'} |
| Repeating Sequence (Repeating table) (masked subsystem) | | |
| rep_seq_t | Time values | {'[0 2]'} |
| rep_seq_y | Output values | {'[0 2]'} |
| Repeating Sequence Interpolated (Repeating Sequence Interpolated) (masked subsystem) | | |
| OutValues | Vector of output values | {'[3 1 4 2 1].''} |
| TimeValues | Vector of time values | {'[0 0.1 0.5 0.6 1].''} |
| LookUpMeth | Lookup Method | {'Interpolation-Use End Values'} 'Use Input Nearest' 'Use Input Below' 'Use Input Above' |
| tsamp | Sample time | {'0.01'} |
| OutMin | Output minimum | {'[]'} |
| OutMax | Output maximum | {'[]'} |

| Block (Type)/Parameter | Dialog Box Prompt | Values |
|--|--|--|
| OutDataTypeStr | Output data type | 'Inherit: Inherit via back propagation' {'double'} 'single' 'int8' 'uint8' 'int16' 'uint16' 'int32' 'uint32' 'int64' 'uint64' 'fixdt(1,16,0)' 'fixdt(1,16,2^0,0)' |
| OutputDataTypeScaling Mode | Deprecated in R2007b | |
| OutDataType | Deprecated in R2007b | |
| OutScaling | Deprecated in R2007b | |
| LockScale | Lock output data type setting against changes by the fixed-point tools | {'off'} 'on' |
| Repeating Sequence Stair (Repeating Sequence Stair) (masked subsystem) | | |
| OutValues | Vector of output values | {'[3 1 4 2 1].''} |
| tsamp | Sample time | {'-1'} |
| OutMin | Output minimum | {'[]'} |
| OutMax | Output maximum | {'[]'} |
| OutDataTypeStr | Output data type | 'Inherit: Inherit via back propagation' {'double'} 'single' 'int8' 'uint8' 'int16' 'uint16' 'int32' 'uint32' 'int64' 'uint64' 'boolean' 'fixdt(1,16)' 'fixdt(1,16,0)' 'fixdt(1,16,2^0,0)' 'Enum: <class name>' |
| OutputDataTypeScaling Mode | Deprecated in R2007b | |
| OutDataType | Deprecated in R2007b | |
| ConRadixGroup | Deprecated in R2007b | |
| OutScaling | Deprecated in R2007b | |
| LockScale | Lock output data type setting against changes by the fixed-point tools | {'off'} 'on' |
| Signal Builder (Sigbuilder block) (masked subsystem) | | |
| Signal Editor (SignalEditor) | | |
| Filename | File name | {'untitled.mat'} |
| ActiveScenario | Active scenario | {'Scenario'} |

| Block (Type)/Parameter | Dialog Box Prompt | Values |
|---|---------------------------------------|---|
| ActiveSignal | Signals | {'Signal 1'} |
| IsBus | Output a bus signal | 'on' {'off'} |
| OutputBusObjectStr | Select bus object | {'Bus: BusObject'} |
| SampleTime | Sample time | {'0'} |
| Interpolate | Interpolate data | {'off'} 'on' |
| ZeroCross | Enable zero-crossing detection | {'off'} 'on' |
| OutputAfterFinalValue | Form output after final data value by | {'Setting to zero'} 'Extrapolation' 'Holding final value' |
| Unit | Unit | {'inherit'} |
| PreserveSignalName | — | boolean — {'off'} 'on' |
| NumberOfScenarios | — | Read-only. Use get_param to get this value. |
| NumberOfSignals | — | Read-only. Use get_param to get this value. |
| Signal Generator (SignalGenerator) | | |
| WaveForm | Wave form | {'sine'} 'square' 'sawtooth' 'random' |
| TimeSource | Time (t) | {'Use simulation time'} 'Use external signal' |
| Amplitude | Amplitude | {'1'} |
| Frequency | Frequency | {'1'} |
| Units | Units | 'rad/sec' {'Hertz'} |
| VectorParams1D | Interpret vector parameters as 1-D | 'off' {'on'} |
| Sine Wave (Sin) | | |
| SineType | Sine type | {'Time based'} 'Sample based' |
| TimeSource | Time | {'Use simulation time'} 'Use external signal' |
| Amplitude | Amplitude | {'1'} |
| Bias | Bias | {'0'} |
| Frequency | Frequency | {'1'} |
| Phase | Phase | {'0'} |
| Samples | Samples per period | {'10'} |
| Offset | Number of offset samples | {'0'} |
| SampleTime | Sample time | {'0'} |
| VectorParams1D | Interpret vector parameters as 1-D | 'off' {'on'} |
| Step (Step) | | |
| Time | Step time | {'1'} |

| Block (Type)/Parameter | Dialog Box Prompt | Values |
|---|--|--|
| Before | Initial value | {'0'} |
| After | Final value | {'1'} |
| SampleTime | Sample time | {'0'} |
| VectorParams1D | Interpret vector parameters as 1-D | 'off' {'on'} |
| ZeroCross | Enable zero-crossing detection | 'off' {'on'} |
| Uniform Random Number (UniformRandomNumber) | | |
| Minimum | Minimum | {'-1'} |
| Maximum | Maximum | {'1'} |
| Seed | Seed | {'0'} |
| SampleTime | Sample time | {'0.1'} |
| VectorParams1D | Interpret vector parameters as 1-D | 'off' {'on'} |
| Waveform Generator (WaveformGenerator) | | |
| OutMin | Output minimum | {'[]'} |
| OutMax | Output maximum | {'[]'} |
| OutDataTypeStr | Output data type | 'Inherit: Inherit via back propagation' {'Inherit: Inherit from table data'} 'double' 'single' 'int8' 'uint8' 'int16' 'uint16' 'int32' 'uint32' 'int64' 'uint64' 'boolean' 'fixdt(1,16)' 'fixdt(1,16,0)' 'fixdt(1,16,2^0,0)' |
| LockScale | Lock output data type setting against changes by the fixed-point tools | {'off'} 'on' |
| RndMeth | Integer rounding mode | 'Ceiling' 'Convergent' 'Floor' {'Nearest'} 'Round' 'Simplest' 'Zero' |
| SaturateOnIntegerOverflow | Saturate on integer overflow | {'off'} 'on' |
| SelectedSignal | Output signal | {'1'} |
| SampleTime | Sample time | {'0'} |

String Library Block Parameters

| Block (Type)/Parameter | Dialog Box Prompt | Values |
|---|-------------------------------------|--|
| Compose String (Compose String) | | |
| Format | Format | scalar {"%d %f"} "%d" "%i" "%o" "%x" "%X" "%f" "%e" "%E" "%g" "%G" "%s" optional operators and text |
| OutDataTypeStr | Output data type | {"stringtype(255)} "stringtype(N)" "string" |
| Scan String (Scan String) | | |
| Format | Format | scalar {"%d %f"} "%d" "%i" "%o" "%x" "%X" "%f" "%e" "%E" "%g" "%G" "%s" optional operators and text |
| String Compare (String Compare) | | |
| CaseSensitive | Case sensitivity for string compare | 'off' {'on'} |
| CompareOption | Amount of characters to compare | {"Entire string"} "First N characters" |
| NumberOfCharacters | Number of characters to compare | {'1'} scalar |
| String Concatenate (String Concatenate) | | |
| Inputs | Number of inputs | {"2"} |
| OutDataTypeStr | Output data type | {"stringtype(128)} "stringtype(N)" "string" |
| String Constant (String Constant) | | |
| String | String | {"Hello!"} scalar |
| OutDataTypeStr | Output data type | {"stringtype(128)} "stringtype(N)" "string" |
| String to ASCII (String to ASCII) | | |
| OutputVectorSize | Output vector size | {"31"} scalar |
| String to Double (String to Double) | | |
| Format | Format | scalar {"%d %f"} "%d" "%i" "%o" "%x" "%X" "%f" "%e" "%E" "%g" "%G" "%s" optional operators and text |
| String to Enum (String to Enum) | | |

| Block (Type)/Parameter | Dialog Box Prompt | Values |
|-------------------------------------|-----------------------------------|---|
| OutDataTypeStr | Output data type | {"Enum: S1DemoSign"} <data type expression> |
| String to Single (String to Single) | | |
| Format | Format | scalar {"%f"} "%d" "%i" "%o" "%x" "%X" "%f" "%e" "%E" "%g" "%G" "%s" optional operators and text |
| Substring (Substring) | | |
| InheritMaximumLength | Inherit maximum length from input | 'off' {'on'} |
| OutDataTypeStr | Output data type | {"stringtype(31)} "stringtype(N)" "string" |
| StringFromIdxToEnd | Output string from 'idx' to end | {'off'} 'on' |

User-Defined Functions Library Block Parameters

| Block (Type)/Parameter | Dialog Box Prompt | Values |
|--|--------------------------------|-------------------------------|
| MATLAB Function (Stateflow) (masked subsystem) | | |
| MATLAB System (MATLABSystem) | | |
| System | System object class name | {''} |
| Level-2 MATLAB S-Function (M-S-Function) | | |
| FunctionName | S-function name | {'mlfile'} |
| Parameters | Arguments | {''} |
| Interpreted MATLAB Function (MATLABFcn) | | |
| MATLABFcn | MATLAB function | {'sin'} |
| OutputDimensions | Output dimensions | {'-1'} |
| OutputSignalType | Output signal type | {'auto'} 'real' 'complex' |
| Output1D | Collapse 2-D results to 1-D | 'off' {'on'} |
| SampleTime | Sample time (-1 for inherited) | {'-1'} |
| S-Function (S-Function) | | |
| FunctionName | S-function name | {'system'} |
| Parameters | S-function parameters | {''} |
| SFunctionModules | S-function modules | {''} |
| S-Function Builder (S-Function Builder) (masked subsystem) | | |
| FunctionName | S-function name | {'system'} |
| Parameters | S-function parameters | {''} |
| SFunctionModules | S-function modules | {''} |

Additional Discrete Library Block Parameters

| Block (Type)/Parameter | Dialog Box Prompt | Values |
|--|--|--|
| Fixed-Point State-Space (Fixed-Point State-Space) (masked subsystem) | | |
| A | State Matrix A | {'[2.6020 -2.2793 0.6708; 1 0 0; 0 1 0]'} } |
| B | Input Matrix B | {'[1; 0; 0]'} } |
| C | Output Matrix C | {'[0.0184 0.0024 0.0055]'} } |
| D | Direct Feedthrough Matrix D | {'[0.0033]'} } |
| InitialCondition | Initial condition for state | {'0.0'} |
| InternalDataType | Data type for internal calculations | {'fixdt('double')'} |
| StateEqScaling | Scaling for State Equation AX+BU | {'2^0'} |
| OutputEqScaling | Scaling for Output Equation CX+DU | {'2^0'} |
| LockScale | Lock output data type setting against changes by the fixed-point tools | {'off'} 'on' |
| RndMeth | Integer rounding mode | 'Ceiling' 'Convergent' {'Floor'} 'Nearest' 'Round' 'Simplest' 'Zero' |
| DoSatur | Saturate to max or min when overflows occur | {'off'} 'on' |
| Transfer Fcn Direct Form II (Transfer Fcn Direct Form II) (masked subsystem) | | |
| NumCoefVec | Numerator coefficients | {'[0.2 0.3 0.2]'} } |
| DenCoefVec | Denominator coefficients excluding lead (which must be 1.0) | {'[-0.9 0.6]'} } |
| vinit | Initial condition | {'0.0'} |
| RndMeth | Integer rounding mode | 'Ceiling' 'Convergent' {'Floor'} 'Nearest' 'Round' 'Simplest' 'Zero' |
| DoSatur | Saturate to max or min when overflows occur | {'off'} 'on' |
| Transfer Fcn Direct Form II Time Varying (Transfer Fcn Direct Form II Time Varying) (masked subsystem) | | |
| vinit | Initial condition | {'0.0'} |
| RndMeth | Integer rounding mode | 'Ceiling' 'Convergent' {'Floor'} 'Nearest' 'Round' 'Simplest' 'Zero' |
| DoSatur | Saturate to max or min when overflows occur | {'off'} 'on' |
| Unit Delay Enabled (Unit Delay Enabled) (masked subsystem) | | |

| Block (Type)/Parameter | Dialog Box Prompt | Values |
|--|-------------------|---------|
| vinit | Initial condition | {'0.0'} |
| tsamp | Sample time | {'-1'} |
| Unit Delay Enabled External IC (Unit Delay Enabled External Initial Condition) (masked subsystem) | | |
| tsamp | Sample time | {'-1'} |
| Unit Delay Enabled Resettable (Unit Delay Enabled Resettable) (masked subsystem) | | |
| vinit | Initial condition | {'0.0'} |
| tsamp | Sample time | {'-1'} |
| Unit Delay Enabled Resettable External IC (Unit Delay Enabled Resettable External Initial Condition) (masked subsystem) | | |
| tsamp | Sample time | {'-1'} |
| Unit Delay External IC (Unit Delay External Initial Condition) (masked subsystem) | | |
| tsamp | Sample time | {'-1'} |
| Unit Delay Resettable (Unit Delay Resettable) (masked subsystem) | | |
| vinit | Initial condition | {'0.0'} |
| tsamp | Sample time | {'-1'} |
| Unit Delay Resettable External IC (Unit Delay Resettable External Initial Condition) (masked subsystem) | | |
| tsamp | Sample time | {'-1'} |
| Unit Delay With Preview Enabled (Unit Delay With Preview Enabled) (masked subsystem) | | |
| vinit | Initial condition | {'0.0'} |
| tsamp | Sample time | {'-1'} |
| Unit Delay With Preview Enabled Resettable (Unit Delay With Preview Enabled Resettable) (masked subsystem) | | |
| vinit | Initial condition | {'0.0'} |
| tsamp | Sample time | {'-1'} |
| Unit Delay With Preview Enabled Resettable External RV (Unit Delay With Preview Enabled Resettable External RV) (masked subsystem) | | |
| vinit | Initial condition | {'0.0'} |
| tsamp | Sample time | {'-1'} |
| Unit Delay With Preview Resettable (Unit Delay With Preview Resettable) (masked subsystem) | | |
| vinit | Initial condition | {'0.0'} |
| tsamp | Sample time | {'-1'} |
| Unit Delay With Preview Resettable External RV (Unit Delay With Preview Resettable External RV) (masked subsystem) | | |
| vinit | Initial condition | {'0.0'} |
| tsamp | Sample time | {'-1'} |

Additional Math: Increment - Decrement Library Block Parameters

| Block (Type)/Parameter | Dialog Box Prompt | Values |
|--|--------------------------|---------------|
| Decrement Real World (Real World Value Decrement) (masked subsystem) | | |
| Decrement Stored Integer (Stored Integer Value Decrement) (masked subsystem) | | |
| Decrement Time To Zero (Decrement Time To Zero) (masked subsystem) | | |
| Decrement To Zero (Decrement To Zero) (masked subsystem) | | |
| Increment Real World (Real World Value Increment) (masked subsystem) | | |
| Increment Stored Integer (Stored Integer Value Increment) (masked subsystem) | | |

Mask Parameters

About Mask Parameters

This section lists parameters that describe masked blocks. You can use these descriptive parameters with `get_param` and `set_param` to obtain and specify the properties of a block mask.

The descriptive mask parameters listed in this section apply to all masks, and provide access to all mask properties. Be careful not to confuse these descriptive mask parameters with the mask-specific parameters defined for an individual mask in the Mask Editor **Parameters** pane.

See “Masking Fundamentals” and “Mask Editor Overview” for information about block masks and the Mask Editor.

Mask Parameters

| Parameter | Description/Prompt | Values |
|--------------------|--|--|
| Mask | Turns mask on or off. | { 'on' } 'off' |
| MaskCallbackString | Mask parameter callbacks that are executed when the respective parameter is changed on the dialog. Set by the Dialog callback field on the Parameters pane of the Mask Editor dialog box. For more information, see “Mask Callback Code”. | pipe-delimited character vector { ' ' } |
| MaskCallbacks | Cell array version of MaskCallbackString. | cell array { ' [] ' } |
| MaskDescription | Block description. Set by the Mask description field on the Documentation pane of the Mask Editor dialog box. | character vector { ' ' } |
| MaskDisplay | Drawing commands for the block icon. Set by the Icon Drawing commands field on the Icon & Ports pane of the Mask Editor dialog box. | character vector { ' ' } |
| MaskEditorHandle | For internal use only. | |
| MaskEnableString | Option that determines whether a parameter is greyed out in the dialog. Set by the Enable parameter check box on the Parameters pane of the Mask Editor dialog box. | pipe-delimited character vector { ' ' } |
| MaskEnables | Cell array version of MaskEnableString. | cell array of character vectors, each either 'on' or 'off' { ' [] ' } |
| MaskHelp | Block help. Set by the Mask help field on the Documentation pane of the Mask Editor dialog box. | character vector { ' ' } |
| MaskIconFrame | Set the visibility of the icon frame (Visible is on, Invisible is off). Set by the Block Frame option on the Icon & Ports pane of the Mask Editor dialog box. | { 'on' } 'off' |
| MaskIconOpaque | Set the transparency of the icon. Set by the Icon Transparency option on the Icon & Ports pane of the Mask Editor dialog box. | { 'opaque' } 'transparent' 'opaque-with-ports' |

| Parameter | Description/Prompt | Values |
|--------------------------|---|---|
| MaskIconRotate | Set the rotation of the icon (Rotates is on, Fixed is off). Set by the Icon Rotation option on the Icon & Ports pane of the Mask Editor dialog box. | 'on' {'off'} |
| MaskIconUnits | Set the units for the drawing commands. Set by the Icon Units option on the Icon & Ports pane of the Mask Editor dialog box. | 'pixel' {'autoscale'} 'normalized' |
| MaskInitialization | Initialization commands. Set by the Initialization commands field on the Initialization pane of the Mask Editor dialog box. | MATLAB command {' '} |
| MaskNames | Cell array of mask dialog parameter names. Set inside the Variable column in the Parameters pane of the Mask Editor dialog box. | matrix {'[[']']} |
| MaskPortRotate | Specify the port rotation policy for the masked block. Set in the Port Rotation area on the Icon & Ports pane of the Mask Editor dialog box. For more information, see “Format a Model”. | {'default'} 'physical' |
| MaskPrompts | List of dialog parameter prompts (see below). Set inside the Dialog parameters area on the Parameters pane of the Mask Editor dialog box. | cell array of character vectors {'[[']']} |
| MaskPromptString | List of dialog parameter prompts (see below). Set inside the Dialog parameters area on the Parameters pane of the Mask Editor dialog box. | character vector {' '} |
| MaskPropertyName | Pipe-delimited version of MaskNames. | character vector {' '} |
| MaskRunInitForIconRedraw | Specifies whether Simulink must run mask initialization before executing the mask icon commands. | {'auto'} 'on' 'off' |
| MaskSelfModifiable | Indicates that the block can modify itself. Set by the Allow library block to modify its contents check box on the Initialization pane of the Mask Editor dialog box. | 'on' {'off'} |

| Parameter | Description/Prompt | Values |
|------------------------|---|---|
| MaskStyles | Determines whether the dialog parameter is a check box, edit field, or pop-up list. Set by the Type column in the Parameters pane of the Mask Editor dialog box. | cell array {' [] '} edit, checkbox, popup, combobox, radiobutton, slider, dial, spinbox, unit, textarea, customtable, unidt, min, max. |
| MaskStyleString | Comma-separated version of MaskStyles. | character vector { ' ' } |
| MaskTabNameString | For internal use only. | |
| MaskTabNames | For internal use only. | |
| MaskToolTipsDisplay | Determines which mask dialog parameters to display in the tooltip for this masked block. Specify as a cell array of 'on' or 'off' values, each of which indicates whether to display the parameter named at the corresponding position in the cell array returned by MaskNames. | cell array of 'on' and 'off' {''} |
| MaskToolTipString | Comma-delimited version of MaskToolTipsDisplay. | character vector { ' ' } |
| MaskTunableValues | Allows the changing of mask dialog values during simulation. Set by the Tunable column in the Parameters pane of the Mask Editor dialog box. | cell array of character vectors { ' [] ' } |
| MaskTunableValueString | Comma-delimited character vector version of MaskTunableValues. | delimited character vector { ' ' } |
| MaskType | Mask type. Set by the Mask type field on the Documentation pane of the Mask Editor dialog box. | character vector { 'Stateflow' } |
| MaskValues | Dialog parameter values. | cell array { ' [] ' } |
| MaskValueString | Delimited character vector version of MaskValues. | delimited character vector { ' ' } |
| MaskVarAliases | Specify aliases for a block's mask parameters. The aliases must appear in the same order as the parameters appear in the block's MaskValues parameter. | cell array { ' [] ' } |
| MaskVarAliasString | For internal use only. | |
| MaskVariables | List of the dialog parameters' variables (see below). Set inside the Dialog parameters area on the Parameters pane of the Mask Editor dialog box. | character vector { ' ' } |

| Parameter | Description/Prompt | Values |
|----------------------|---|------------------------|
| MaskVisibilities | Specifies visibility of parameters. Set with the Show parameter check box in the Options for selected parameter area on the Parameters pane of the Mask Editor dialog box. | matrix {' []'} |
| MaskVisibilityString | Delimited character vector version of MaskVisibilities. | character vector {' '} |
| MaskWSVariables | List of the variables defined in the mask workspace (read only). | matrix {' []'} |

See Control Masks Programmatically, for more information on setting the mask parameters from the MATLAB command line.

Tools and Apps

Bus Editor

Create, modify, and manage Simulink.Bus objects

Description

To interactively create a `Simulink.Bus` object, and the `Simulink.BusElement` objects that it contains, use the Simulink Bus Editor.

The Bus objects that you create using the Bus Editor are stored in the MATLAB base workspace. To simulate a block that uses a Bus object, the Bus object must be in the base workspace or in a data dictionary.

To save Bus object definitions using the Bus Editor, export the Bus objects from the base workspace into a MATLAB code file or MAT-file. If you save a Bus object in a MATLAB code file, you can edit it programmatically. For details, see “Create Bus Objects Programmatically”.

You can use the Bus Editor to change and delete existing Bus objects and bus elements. The Bus Editor displays all Bus objects in the base workspace. Changes that create, reorder, or delete entities take effect immediately in the base workspace.

Note The Bus Editor does not provide an undo capability. Changes to properties take effect when you apply them.

For more information on Bus objects, see “Specify Bus Properties with Simulink.Bus Object Data Types”.

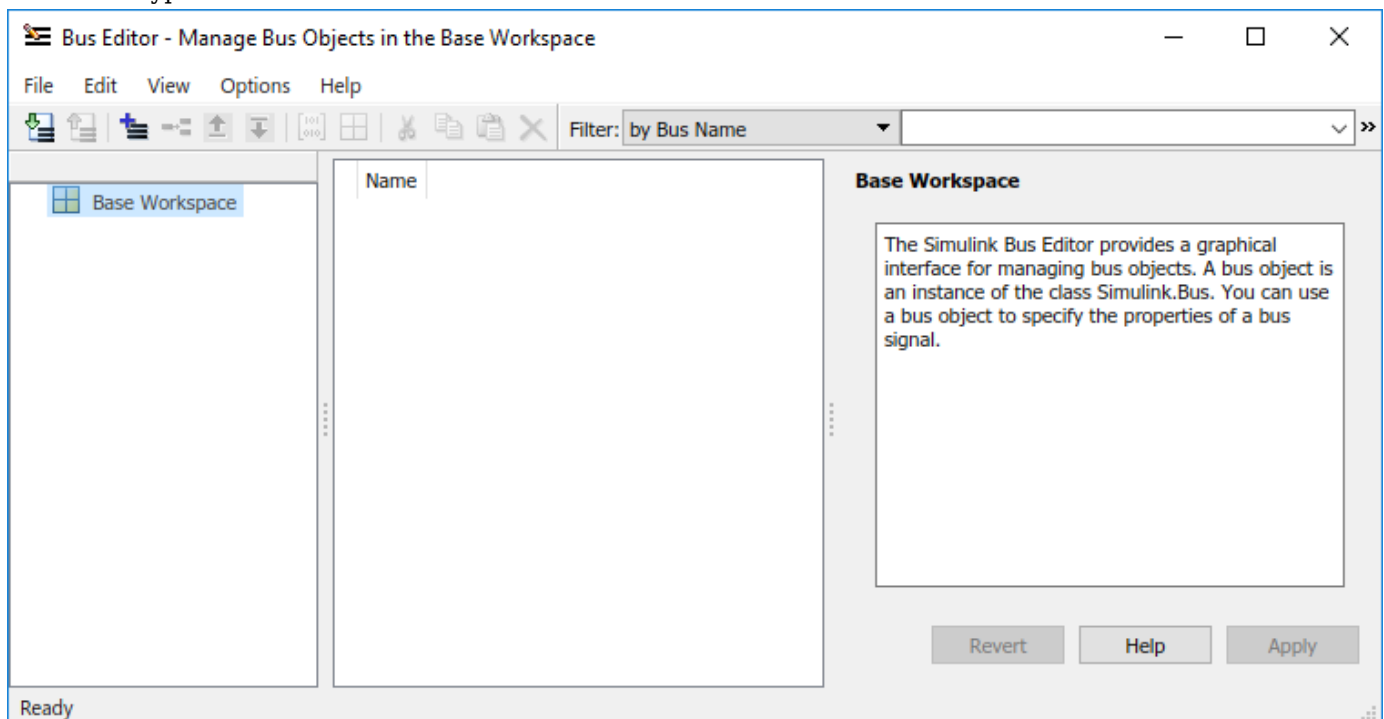

Open the Bus Editor

- In the Simulink Toolstrip, on the **Modeling** tab, in the **Design** gallery, click **Bus Editor**.
- At the MATLAB command prompt, enter `buseditor`.
- In the Model Explorer, in a Bus object dialog box, click the **Launch Bus Editor** button.

Examples

Create Bus Objects Using the Bus Editor

This example shows how to create a Bus object that corresponds to the `control` bus in `model`. This bus contains two signals as elements.

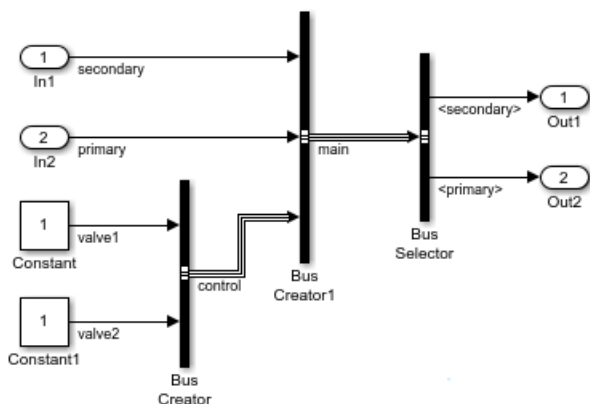

- 1 In the Bus Editor, click the **Add Bus** button .

A Bus object with a default name appears in the left pane and its default properties appear in the **Simulink.Bus** dialog pane.

- 2 Specify the name for the Bus object using the **Name** property. For easy identification, use a name that reflects the bus associated with the bus object. The bus that combines the valve inputs is named `control`, therefore, name the Bus object `CONTROL`.

Tip Click **Apply** after editing properties or choose to automatically apply changes when you click a different object.

- 3 Click the **Add/Insert BusElement** button .

A bus element with a default name and default properties is created in the `CONTROL` Bus object. The bus element appears in the left pane nested under the `CONTROL` Bus object.

- 4 In the **Simulink.BusElement** dialog pane, set **Name** to `VALVE1`, which reflects the name of the corresponding signal in the bus.
- 5 To determine the signal properties for BusElement object `VALVE1`, open the Block Parameters dialog box for the Constant block.

The properties on the **Signal Attributes** tab match the default BusElement object properties, so no change is required.

- 6 Similarly, create a `BusElement` object named `VALVE2` that corresponds to the `valve2` element.
- 7 To determine the signal properties for `BusElement` object `VALVE2`, open the Block Parameters dialog box for the `Constant1` block.

The **Output data type** specified by the `Constant1` block is `int8`, which does not match the default `BusElement` object properties. Set the **Data Type** property of `BusElement` object `VALVE2` to `int8`.

Nest Bus Objects Using the Bus Editor

Any signal in a bus can be another bus, which can in turn contain subordinate buses, to any depth. Describing nested buses using `Bus` objects requires nesting the `Bus` object definitions.

Model has two buses, with one bus nested inside the other bus.

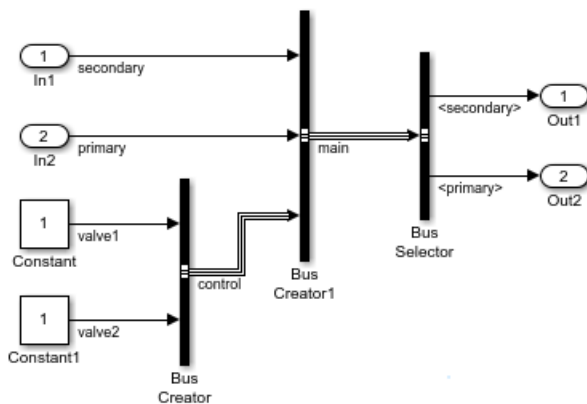

This example shows how to nest a `Bus` object that corresponds to the `control` bus in a `Bus` object that corresponds to the `main` bus.

- 1 Create a `Bus` object named `CONTROL` that fully specifies the `control` bus.
- 2 Create a `Bus` object named `MAIN` that fully specifies the `main` bus, temporarily using default values for the `BusElement` object that specifies the nested `control` bus.

To identify that this `BusElement` object corresponds to a nested bus, you can name it `VALVES_BUS`.

- 3 In the **Simulink.BusElement** dialog pane for `VALVES_BUS`, set the **Data type** parameter to `Bus: <object name>`, where `<object name>` is the name of the `Bus` object for the `control` bus.

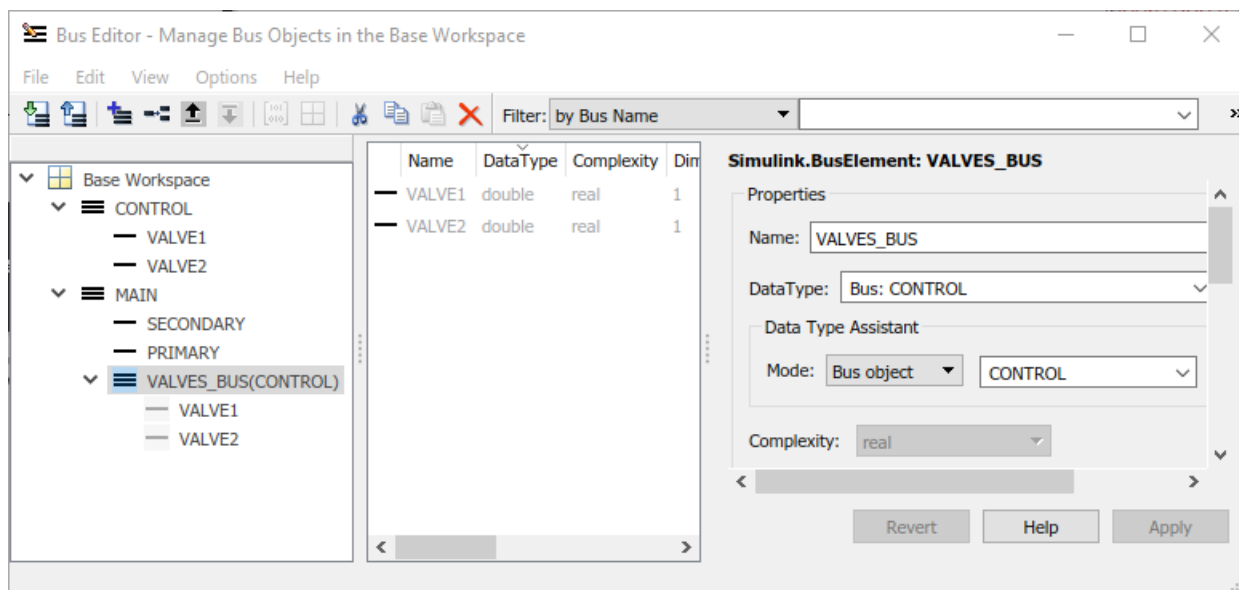

Tip A Bus object cannot directly or indirectly reference itself. If you define a circular structure, the Bus Editor warns you and sets the data type of the element that would have completed the circle to double.

Edit Bus Objects Using the Bus Editor

To edit a Bus object or BusElement object:

- 1 In the left pane, select the object to edit.
- 2 In the **Simulink.Bus** or **Simulink.BusElement** dialog pane, edit the object properties.
- 3 Click **Apply**.

When you have a Bus object selected, you can edit its BusElement objects in the middle pane.

To make the same edit to a property in multiple BusElement objects, use the middle pane. Hold the **Ctrl** key while you select multiple bus element objects and enter the new value in the property for one of the selected bus element objects. The change applies to all the selected BusElement objects.

You can use the Bus Editor to copy and paste Bus objects or BusElement objects. Right-click an object and use the context menu to copy and paste the Bus object. Copying a Bus object also copies its BusElement objects. The copied objects have the same property values as the original objects.

To change the order of bus elements in a Bus object, in the left pane, select a bus element and click **Move Element Up**  or **Move Element Down** .

To delete a Bus object, in the left pane, select the Bus object and click **Delete**  or press the **Delete** key. Deleting a Bus object deletes its BusElement objects.

If you delete a Bus object, in the Simulink Editor, update any blocks that use that Bus object. To find where a bus object is used in a model, see “Finding Blocks That Use a Specific Variable”.

Save Bus Objects Using the Bus Editor

When you create Bus objects in the base workspace, before you close MATLAB, save the Bus objects for future use.

You can save Bus objects to one of these locations:

- Data dictionary
- MATLAB code file
- MAT-file
- Database or other external files

The Bus Editor can save Bus objects in a MAT-file or MATLAB code file. To save Bus objects in other locations, see “Save Simulink.Bus Objects”.

Tip To display a reminder to save Bus objects before closing the Bus Editor, select **Options > Always Warn Before Closing**.

- 1 Select which Bus objects you want to export.
 - To export all visible Bus objects in the Bus Editor, select **File > Export to File**. Bus objects hidden by a filter do not export.
 - To export only selected Bus objects, right-click a Bus object, then select **Export to File**.
 - To include nested Bus objects used by the selected Bus object, select **Export with Dependent Bus Objects to File**.
- 2 In the Export dialog box, specify the name for the export file.
- 3 Set **Save as type** to MATLAB files (*.m) or MAT-files (*.mat).
- 4 Click **Save**.
- 5 For a MATLAB code file, in the additional dialog box that appears, select the export format.
 - **Cell** — Stores Bus objects in a compressed format.
 - **Object** — Store Bus objects in the Simulink.Bus object format, which is easier to read and edit.

Filter Displayed Bus Objects in the Bus Editor

By default, the Bus Editor displays all Bus objects that exist in the base workspace, in alphabetical order. When you want to reduce the number of Bus objects displayed, you can apply a filter.

The Bus Editor can display only those Bus objects that have:

- Names that match a given search term or regular expression

- A specified relationship to a specified Bus object

You can work with any Bus object that is visible in a filtered display exactly as in an unfiltered display. If you change the name or dependency of an object so that it no longer passes the current filter, the object disappears from the display. Conversely, if some activity outside the Bus Editor changes a filtered object so that it passes the current filter, the object immediately becomes visible.

Tip Bus objects created or imported from outside the Bus Editor are not visible until you reopen the Bus Editor.

Operations performed in the left pane for the base workspace affect only visible objects. An object that a filter hides is unaffected by the operation. To act on all existing Bus objects, clear the filter.

In this example, the Bus Editor displays the Bus objects that are in the base workspace.

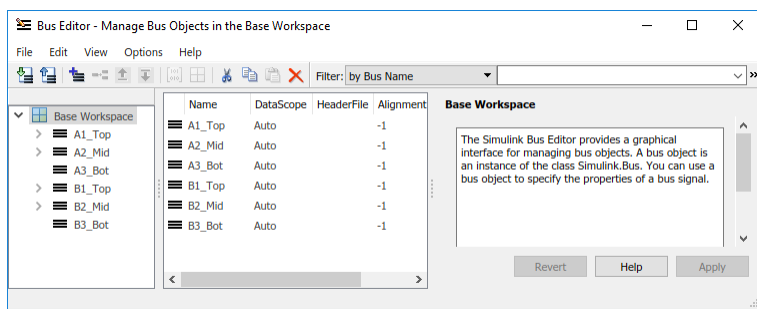

These Bus objects form two hierarchies. A1_Top is the parent of A2_Mid, which is the parent of A3_Bot. Similarly, B1_Top is the parent of B2_Mid, which is the parent of B3_Bot.

To filter by name, select by Bus Name from the list and type the filter term. See "Regular Expressions" for complete information about MATLAB regular expression syntax.

As you type, the Bus Editor updates dynamically to show only the Bus objects whose names match the filter expression. The comparison is case-sensitive. For example, typing A displays only the Bus objects whose names contain an uppercase A.

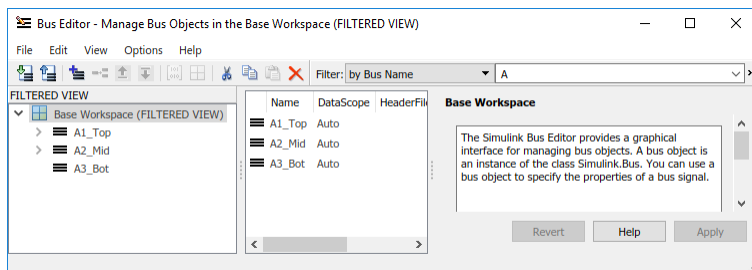

To filter by relationship, select by Bus Object Dependency from the list. In the second list that appears, select the type of relationship to display.

- Bus Object and Parents — Show a specified bus object and all superior Bus objects in the hierarchy (default).
- Bus Object and Dependents — Show a specified Bus object and all subordinate Bus objects in the hierarchy.

- **Bus Object and Related Objects** — Show a specified Bus object and all superior and subordinate Bus objects.

Type a Bus object by name or select an existing Bus object name from the list.

For example, if you select **Bus Object and Dependents** and type **B2**, the Bus Editor displays only the Bus object hierarchies that contain the **B2** Bus object.

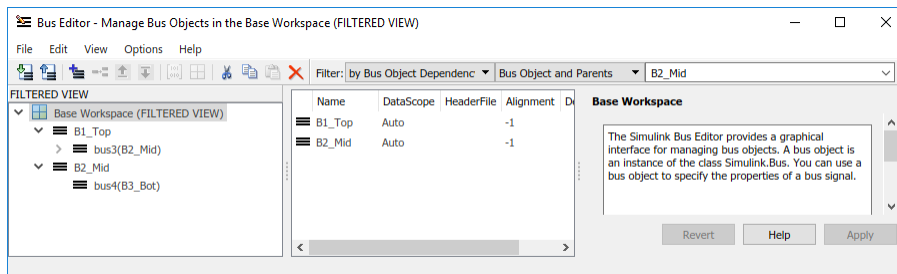

Load Bus Objects Into the Base Workspace

You can use the Bus Editor to import the definitions from a MAT-file or MATLAB code file to the base workspace. The import loads the complete contents of the file, not just the Bus objects.

- 1 Choose **File > Import into Base Workspace**.
- 2 Use the Open File dialog box to navigate to and import the desired file.

See Also

Blocks

Bus Creator | Out Bus Element

Classes

Simulink.Bus | Simulink.BusElement

Topics

“Specify Bus Properties with Simulink.Bus Object Data Types”

“Create Bus Objects Programmatically”

Introduced before R2006a

MATLAB Function Block Editor

Create, edit, and debug MATLAB code in MATLAB Function blocks

Description

The **MATLAB Function Block Editor** allows you to view, edit, and create the MATLAB functions for a MATLAB Function block. When you update the MATLAB code, Simulink updates the MATLAB Function block with input and output ports that match the input and output arguments in the MATLAB function. The **MATLAB Function Block Editor** opens in the **Simulink Editor**.

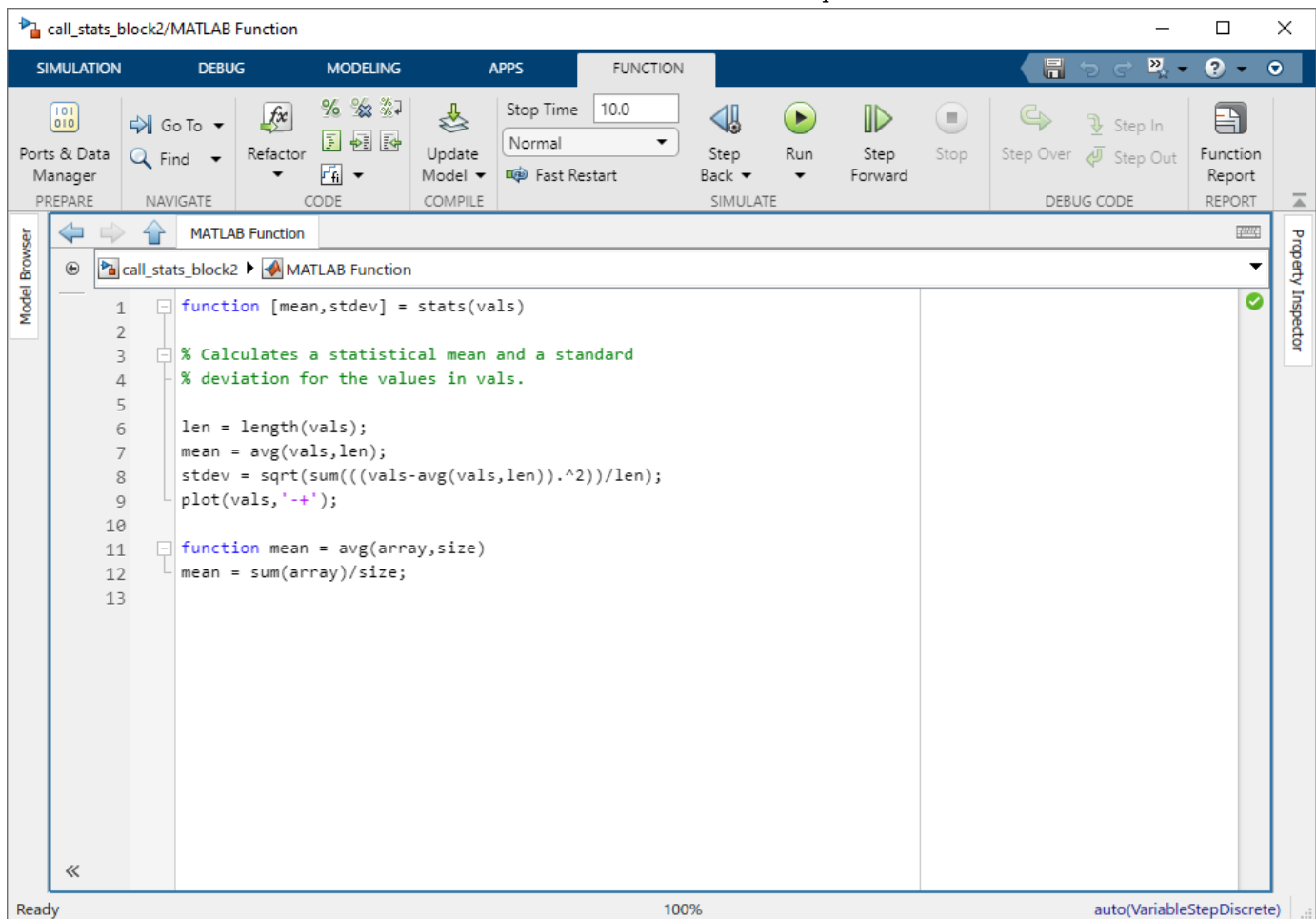

Open the MATLAB Function Block Editor

- Double-click a MATLAB Function block.
- Select a MATLAB Function block and, in the **Function** tab, click **Open in Simulink**.

Examples

Open and Use the MATLAB Function Block Editor

Add a MATLAB Function to your model to open the **MATLAB Function Block Editor**.

- 1 In the **Simulation** tab, click **Library Browser**. Select **Simulink > User-Defined Functions**. Drag a MATLAB Function block to the Simulink canvas.
- 2 Double-click the block to open the **MATLAB Function Block Editor**. Replace the function body code with the following:

```
y = 2*u;
```

- 3 Return to the model by clicking the Up to Parent button . Add a Sine Wave block as the input signal and add a Scope block to capture the input and output of the MATLAB Function block.

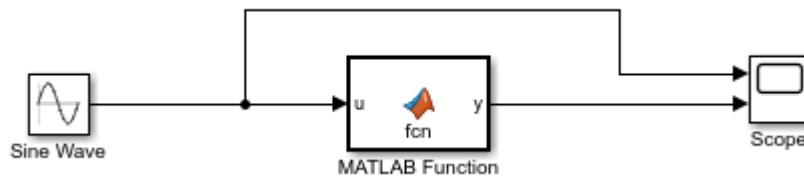

- 4 Run the simulation and open the Scope block to see the effects of the code.

Redefine the Function Header

Rename the default function and adjust function arguments to automatically update the block inports, outports, and block icon.

- 1 Create a new MATLAB Function block and open the **MATLAB Function Block Editor**.
- 2 In the function header, change the text to:

```
function [x y] = test_function(u1, u2)
```
- 3 Return to the model window. The name on the block icon is now `test_function`, and the block has two input ports for **u1** and **u2**, and two output ports **x** and **y**.

Add Data with the Ports and Data Manager

Add function arguments and content to the MATLAB Function block by using the Ports and Data Manager.

- 1 Create a new MATLAB Function block and open the **MATLAB Function Block Editor**.
- 2 Click the Ports and Data Manager button .
- 3 In the Ports and Data Manager window, click **Add > Data**.
- 4 To adjust the data properties, click the new data.

Add Breakpoints to Debug a Function

You can add breakpoints to debug MATLAB Function blocks.

- 1 Create a new MATLAB Function block and open the **MATLAB Function Block Editor**.
- 2 Enter the following code:

```
function [mult,add,subtract] = number_operations(u1,u2)

add = u1 + u2;
subtract = u1 - u2;
mult = u1 * u2;
```

- 3 Click line numbers 3 and 4 to add two breakpoints. The line numbers highlight in red.
- 4 Run the simulation. The simulation stops at the first breakpoint. Click the **Continue** button to simulate until the next breakpoint. If the last breakpoint has been reached, click **Continue** to advance to the next time step.

Investigate Code by Running a Report

Run a report on your MATLAB function code to find information on variables and help detect warnings and errors.

- 1 Create a new MATLAB Function block and open the **MATLAB Function Block Editor**.
- 2 Enter the following code:

```
function [mult,add,subtract] = number_operations(u1,u2)

add = u1 + u2;
subtract = u1 - u2;
mult = u1 * u2;
```

- 3 Click the Function Report button .
- 4 The report lists variables in the **Variables** tab at the bottom. Click any of the variable names to highlight instances where the variable appears in the code.
- 5 In the function code, point to or click any variable or expression to see a dialog box with more information.
 - “Debug MATLAB Function Blocks”
 - “Create Custom Functionality Using MATLAB Function Blocks”
 - “Call MATLAB Function Files in MATLAB Function Blocks”

Parameters

Prepare

Ports and Data Manager — Launches the Ports and Data Manager button

Launches the Ports and Data Manager. Use the Ports and Data Manager to add, delete, or modify data in MATLAB Function blocks. When you open the Ports and Data Manager, the settings correspond to

the MATLAB Function block you are editing with the **MATLAB Function Block Editor**. For more information, see “Define MATLAB Function Block Data”.

Navigate

Go To — Goes to specified code

button

Goes to specified code, including functions and line numbers.

Find — finds and replaces code in function

button

Finds and replaces specified text written in the **MATLAB Function Block Editor**. You can also use the **Ctrl+F** keyboard shortcut. This parameter has the same functionality as the MATLAB Editor. For more information, see “Find and Replace Text in Files and Go to Location”.

Code

Refactor — Converts selected code to a function

button

Converts selected code to a function. Use this feature on code that is not already contained in a function. You can create a separate file for the function code or you can convert code into a local function.

- 1 To convert code and save it in a separate m-file, select the code and click **Refactor > Convert to Function**. The code saves as a m-file and the **MATLAB Function Block Editor** calls the code by the name you specify. To run the model without error, the m-file must be on the path.
- 2 To convert code into a local function, select the code and click **Refactor > Convert to Local Function**. The **MATLAB Function Block Editor** creates a local function at the bottom of the code and replaces the selected code with a function call to the local function.

Comment — Comments out code

button

Comments out code. Select the lines you want to comment and click the Comment button . The button adds one % to the selected lines each time you press it. You can also select the code and use the **Ctrl+R** command.

Uncomment — Removes comments from code

button

Removes comments from code. Select the lines you want to uncomment and click the Uncomment button . The button removes one % from the selected lines each time you press it. You can also select the code and use the **Ctrl+T** command.

Wrap Comments — Wraps comments

button

Wraps comments. Select the lines you want to comment and click the Wrap comments button .

The **MATLAB Function Block Editor** does not wrap comments with:

- 1 Code section titles (comments that begin with %%).
- 2 Long contiguous text, such as URLs.
- 3 Bulleted list items (text that begins with * or #) onto the preceding line.

Smart Indent — Formats code with smart indenting

button

Formats code with smart indenting. Smart indenting automatically formats code to improve code readability, such as when you use functions or logical statements. To manually deploy smart

indenting, select the lines of code and click the Smart Indent button . By default, the **MATLAB Function Block Editor** automatically uses smart indenting. For more information, see “Edit and Format Code”.

Increase Indent — Increases the code indent

button

Increases the code indent by one tab indent. To increase the indent, select the lines of code and click the Increase Indent button .

Decrease Indent — Decreases the code indent

button

Decreases the code indent by one tab indent if the code is indented. To decrease the indent, select the lines code and click the Decrease Indent button .

Specify fixed-point data — Builds fi object constructors

button

Builds fi object constructors with a user interface. To open the interface, click the Specify fixed-point data button . Click the arrow next to the icon to select additional fi constructors. For more information, see “Building fimath Object Constructors in a GUI” (Fixed-Point Designer). This features requires a Fixed-Point Designer license.

Compile

Update Model — Updates the model and checks for errors

button

Updates the model and checks for errors. Expand the menu under **Update Model** to select from two options.

- **Update Model:** Compiles the model and checks for static errors.
- **Refresh blocks:** Updates the model blocks to reflect changes made.

For more information, see “Update Diagram and Run Simulation” and “Simulation Phases in Dynamic Systems”.

Simulate

Stop Time — Specifies the simulation stop time

10 (default) | scalar

Specifies the simulation stop time.

Simulation Mode — Changes the simulation mode

menu item

Changes the simulation mode. You can select from **Normal**, **Accelerator** or **Rapid Accelerator**. For more information, see “Choosing a Simulation Mode”.

Fast Restart — Enables fast restart

'off' (default) | 'on'

Enables fast restart for model simulation. Fast restart can improve performance by preventing compiling. For more information, see “Get Started with Fast Restart”.

Step Back — Steps back in simulation

button

Steps back in simulation. You must configure this option first with the Simulation Stepping Options. If you have not configured these options, the button opens the Simulation Stepping Options window. For more information, see “Simulation Stepping Options”.

Run — Runs the simulation

button

Runs the simulation. You can run a single simulation, or run multiple simulations by creating design studies with **Multiple Simulations** and selecting **Run All** from the drop down. Adjust the time pacing by selecting **Simulation Pacing** from the drop down.

Step Forward — Steps through the simulation at each time step

button

Steps through the simulation at each time step. For more information, see “Step Through a Simulation”.

Stop — Stops the simulation

button

Stops the simulation.

Debug Code

Step over — Steps over the breakpoint during debugging

button

Steps over the breakpoint during debugging in the MATLAB Function block. When you press the button, the debugger steps past function calls and does not enter called functions for line-by-line execution. You can use this button only after simulation stops at a breakpoint.

Step In — Goes to next line of code during debugging

button

Goes to next line of code during debugging in the MATLAB Function block. If the line calls a local function, step into the first line of the local function. You can use this button only after simulation stops at a breakpoint.

Step out — Exits line-by-line function execution during debugging

button

Exits line-by-line function execution during debugging of the current function or local function. If in a local function, the debugger continues to the line following the call to this local function. You can use this button only after simulation stops at a breakpoint.

Report**Function Report — Opens a report**

button

Opens a report that contains information about the MATLAB Function. You can use this report to find information about variables and expressions in the code. For more information, see “MATLAB Function Reports”.

See Also

Simulink Editor | **Model Explorer** | `function`

Topics

“Debug MATLAB Function Blocks”

“Create Custom Functionality Using MATLAB Function Blocks”

“Call MATLAB Function Files in MATLAB Function Blocks”

Introduced in R2011a

Finder

Find and optionally replace values in Simulink models, libraries, and subsystems

Description

Use the **Finder** to search Simulink models, libraries, and subsystems for elements that contain the search string that you enter.

The search can match the string anywhere in the element, such as in the name or in the parameter values. You can customize the search to look only in certain types of elements or for elements with specific parameter settings.

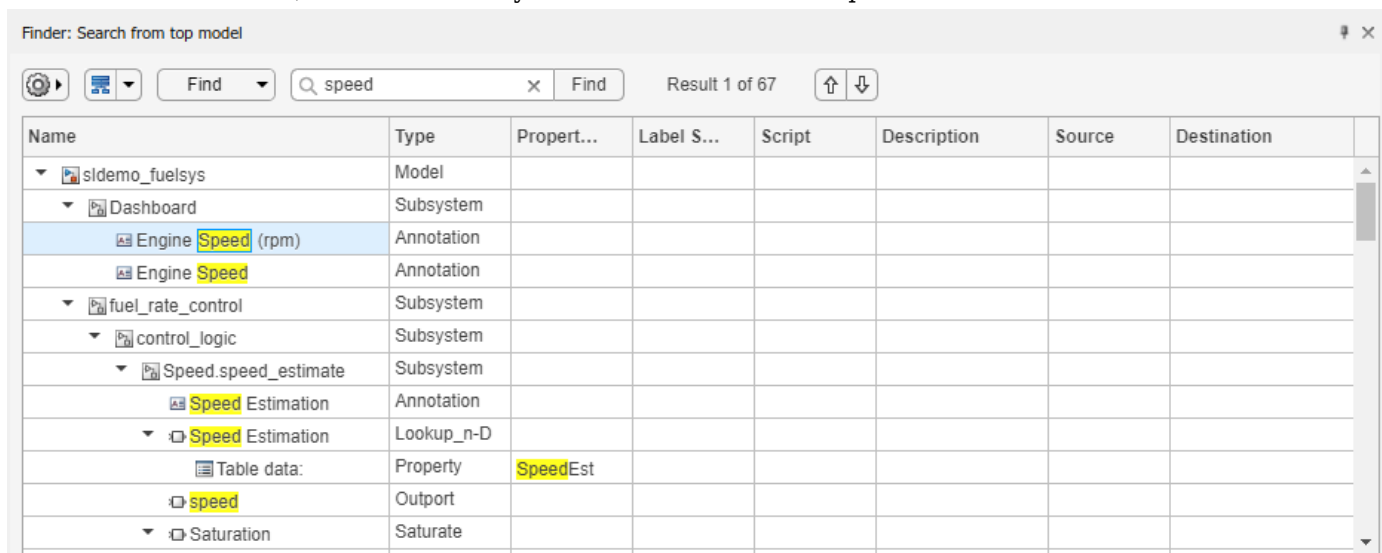

From the search results, you can select and navigate to elements. You can also replace found instances of the search string with another string.

By default, the **Finder** searches all model elements in the current system, its referenced models, its linked blocks, and its masked systems for case-insensitive partial or full matches.



Open the Finder

- In the Simulink Toolstrip, on the **Modeling** tab, click **Find**.
- In the Simulink quick access toolbar, click the **Find** button .

If the **Find** button  is not in the quick access toolbar, click the **Common Controls** button  and select the **Find** check box.

- With the Simulink Editor selected, press **Ctrl+F**.

Examples

Search One Level of Model

In this example, you search the top level of the `sldemo_fuelsys` model for any model element that contains the number 2.

- 1 Open the model `sldemo_fuelsys`.
`sldemo_fuelsys`
- 2 Open the **Finder**. On the **Modeling** tab, click **Find**.
- 3 Click the **Change the search scope**  button arrow and select **Search this level only**.
- 4 In the search box, enter 2.

Model elements that contain the search string appear in a table. The first element in the table is selected.
- 5 To move to the next element, click the down arrow .
- 6 Use the up and down arrows to move through the rest of the found elements. Alternatively, scroll through the table and click an element to select it.

Perform Advanced Search

When a search returns too many results, use the advanced search settings to narrow your search.

The advanced search settings allow you to:

- Include only the elements you are interested in, such as blocks, annotations, or signals.
- Omit block parameter values from the search.
- Search for case-sensitive matches.
- Search for exact matches.
- Search using regular expressions.
- Omit masked systems, linked blocks, and referenced models from the search.
- Search based on property values such as `BlockDescription` or `BlockType`.

In this example, you search the `sldemo_fuelsys` model for all elements that contain the string `speed`. You then use the **Advanced settings** pane to refine your results.

- 1 Open the model `sldemo_fuelsys`.
`sldemo_fuelsys`
- 2 Open the **Finder**. On the **Modeling** tab, click **Find**.
- 3 Enter the search string. For example, enter `speed`.

Model elements that contain the search string appear in a table. The first element in the table is selected.

Alternatively, you can enter the search string after you specify the search settings

- 4 Click the **Advanced settings** button .

The **Advanced Settings** pane opens.

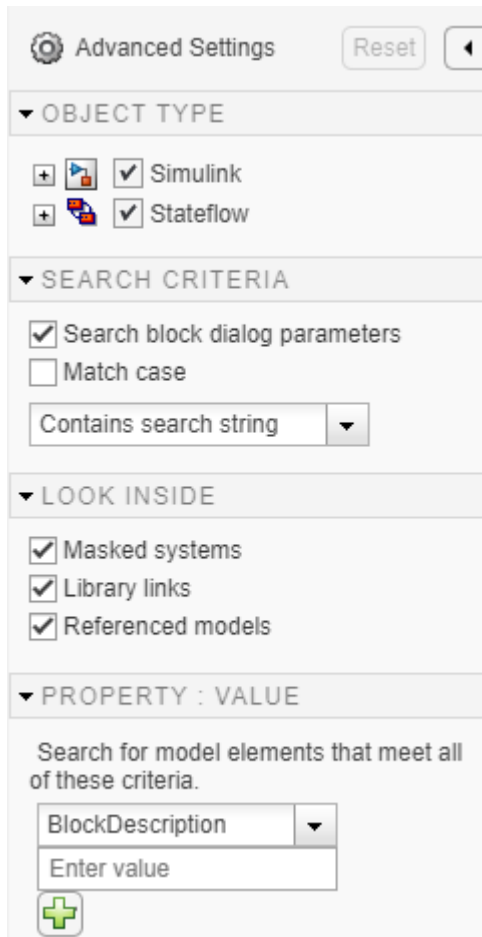

- 5 Specify the advanced settings you want. For example, in the **Property:Value** section, change `BlockDescription` to `BlockType`. In the corresponding text box, type `Constant` and click the **Add property and value** button .

Note In the **Property:Value** section, if you want to search based on a property that is not in the list, select `Other`, then enter the full programmatic name of the property. To find the programmatic name, in the Property Inspector, pause on the property. You cannot use regular expressions or partial matches for the property name.

- 6 Click **Find** to find results that match the updated search criteria.

To restore the default advanced settings, click **Reset**.

Find and Replace Text

You can find and replace text using the **Finder**.

For search results to support replacement:

- You must have write access for the field.
- The field value must be the same as when you performed the search.
- The text formatting must be plain.

In this example, you search the `sldemo_fuelsys` model for the string `rad` and replace `rad` with `deg`.

- 1 Open the model `sldemo_fuelsys`.

`sldemo_fuelsys`

- 2 Open the **Finder**. On the **Modeling** tab, click **Find**.
- 3 In the search box, enter the search string. For example, enter `rad`.

Model elements that contain the search string appear in a table.

- 4 To the left of the search box, click the **Find** button arrow, and select **Replace**.

Replace options appear in the Finder.

- 5 In the text box next to the **Replace** button, enter the replacement string. For example, enter `deg`.
- 6 Select the instance you want to replace, then click **Replace**.

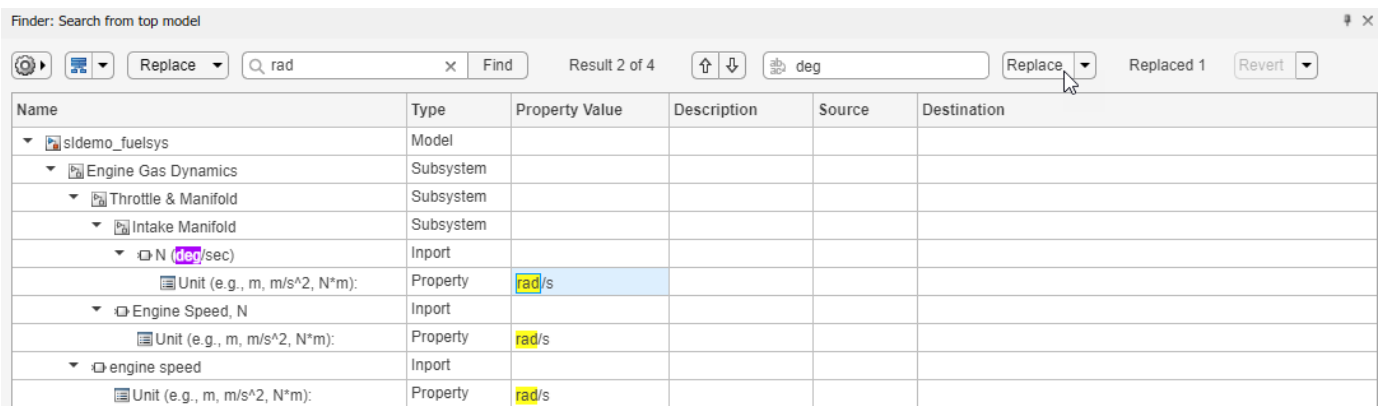

Alternatively, replace all instances of the found string by clicking **Replace > Replace All**.

Note If you stop the replacement operation before it completes, the completed replacements do not revert.

- 7 To view a replacement in the model, double-click the row that corresponds to the replaced element.

If you want to revert replacements, you must revert them before you perform another search or close the **Finder**. To revert replacements, select the instance to revert, then click **Revert**. Alternatively, click the **Revert** button arrow and select **Revert All**. The **Finder** applies the inverse replacements to restore the original values.

- “Build and Edit a Model Interactively”

Tips

- To select the starting point for your search, use the Model Browser.
- To go to and select the element in the model, double-click an item in the list.
- To search for any model elements that match the search criteria, enter an asterisk (*) in the search box.
- To search for a string that contains a colon, escape the colon using a backslash (for example, `Earth\ : a planet`), or use single or double quotes around the expression (for example, `'Earth: a planet'` or `"Earth: a planet"`).
- You can interact with search results while the search runs. However, you can sort the results only after the search is complete.
- To stop a search and view partial search results, in the Finder, click the **Stop** button.
- For table display options, pause on the **Name** heading and click the arrow that appears. The menu provides options to expand, collapse, and sort results. To sort the table based on another column, pause on the corresponding table heading and click the arrow that appears.

See Also

Tools

Model Explorer

Functions

`hilite_system` | `find_system` | `Simulink.FindOptions` | `Simulink.findTemplates` | `Simulink.allBlockDiagrams` | `Simulink.findBlocks` | `Simulink.findBlocksOfType` | `replace_block`

Topics

“Build and Edit a Model Interactively”

Introduced in R2016b

Instrumentation Properties

View and edit signal logging and visualization properties

Description

Use the Instrumentation Properties dialog box to configure logging and visualization settings for logged signals, including a data access callback function to process logged data during simulation and logging sample time.

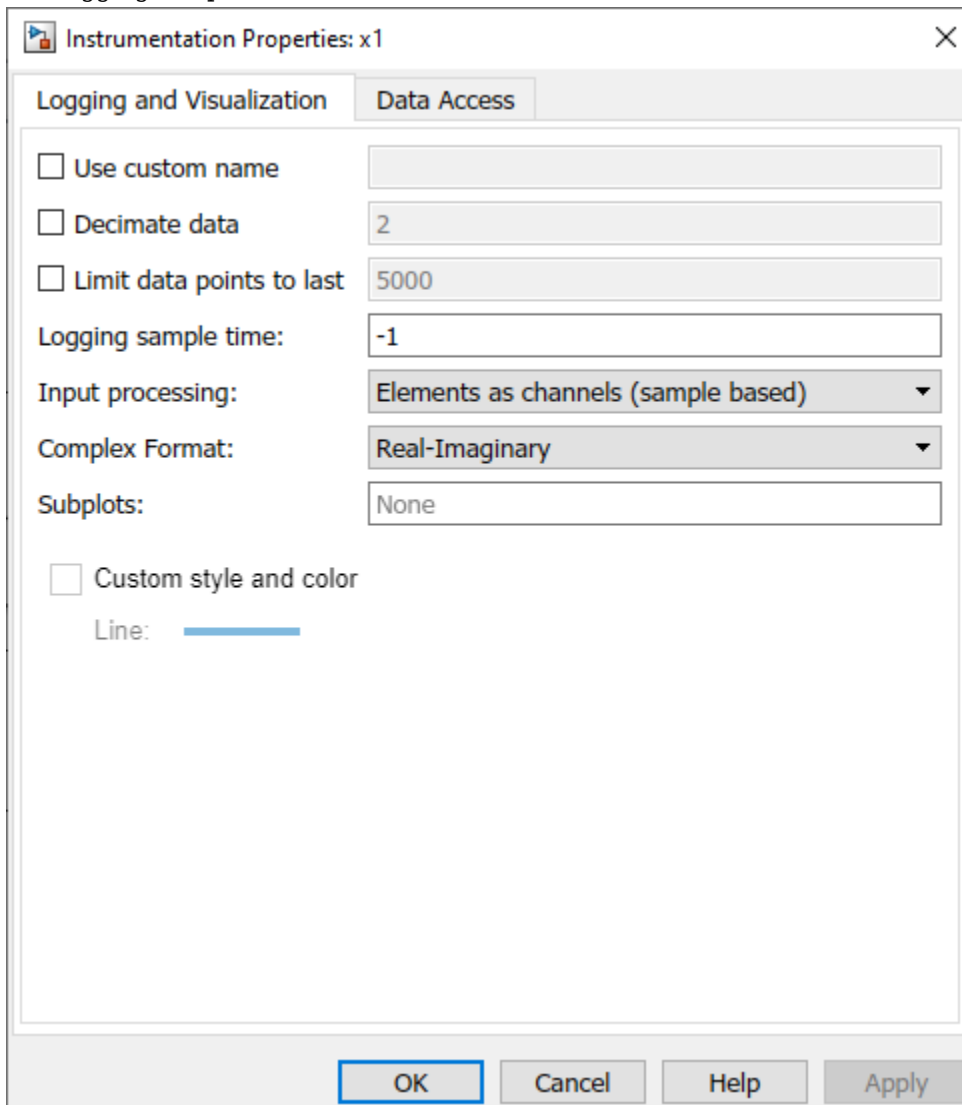

Open the Instrumentation Properties

- Right-click the logging badge on a signal that is marked for logging and select **Properties**.

Parameters

Logging and Visualization

Use custom name — Signal logging name

string | character vector

Select this option to specify a name for logged signal data that is different from the name of the signal in the model. By default, logged signal data uses the name of the signal specified in the model.

The **Use custom name** property is the same as the **Logging name** property that you configure through the dialog box.

Programmatic Use

To specify the signal logging name programmatically, use the `set_param` function to configure the `DataLoggingNameMode` and `DataLoggingName` parameters for the port handle that corresponds to the block output port that produces the signal. For an example, see “Signal-Specific Logging Name Specified Programmatically”.

Decimate data — Option to log every *n*th data value

'off' (default) | 'on'

When you want to reduce the effective sample rate for logged data, select **Decimate data** and specify the desired decimation factor in the text box. For example, if you specify a decimation factor of 2, every other signal value is logged.

Consider data requirements for each signal before reducing the number of data points logged in simulation. Decimation can cause aliasing if the effective sample rate is too low.

For more information, see “Specify Signal Values to Log” and “Limit the Size of Logged Data”.

Limit data points to last — Option to log only last *n* data points

'off' (default) | 'on'

When you only want to save or analyze the data from the end of a simulation, you can configure logging to capture only the last *n* signal values. Select **Limit data points to last** and specify the number of data points you want to log.

When you only log the last simulation values, dashboard blocks and the Simulation Data Inspector do not display data during simulation. Consider data requirements for each signal before you reduce the number of data points logged in simulation.

For more information, see “Specify Signal Values to Log” and “Limit the Size of Logged Data”.

Programmatic Use

To configure this option programmatically, use the `set_param` function to specify the `DataLoggingLimitDataPoints` and `DataLoggingMaxPoints` parameters for the port handle that corresponds to the block output port that produces the signal.

Logging sample time — Sample time for logged signal data

-1 (default) | scalar

Specify the sample time to use for logging the data for the selected signal. By default, the logging sample time is inherited (-1) from the block that produces the signal. For continuous logging sample

time, specify the value as 0. To use a discrete sample time for logging data, specify the sampling interval as a scalar.

Specifying a logging sample time may add a new sample time to the model. When you specify a logging sample time, the model calculates a value for the exact time hits. When you use a fixed-step solver, the logging sample time you specify must be a multiple of the base rate for the model.

Logging sample time is not supported for signals inside conditional subsystems or conditional referenced models.

Input processing — Option to log data as samples or as frames

Elements as channels (sample based) (default) | Columns as channels (frame based)

Specify how multidimensional data is logged and interpreted by the Simulation Data Inspector. By default, signals are logged as sample-based, with each element in a multidimensional sample treated as a channel.

When logging a frame-based signal, set **Input processing** to Columns as channels (frame based). A frame-based signal buffers a batch of samples to create a frame of data. When you log the data as frame-based, each column in a sample is treated as a channel, and the row dimension is treated as evenly-spaced samples within the channel.

Programmatic Use

To programmatically configure or access the **Input processing** property for a logged signal, use the `Simulink.sdi.setSignalInputProcessingMode` function and the `Simulink.sdi.getSignalInputProcessingMode` function.

Complex format — Option to specify how complex signal is displayed in Simulation Data Inspector

Real-Imaginary (default) | Magnitude-Phase | Magnitude | Phase

Complex signal data is logged as a single signal. Use the **Complex format** property to specify how to display a complex signal in the Simulation Data Inspector. By specifying the complex format in the Instrumentation Properties, you save the preference in the model so logged data is displayed consistently for each simulation. You can also modify the complex format for a signal in the Simulation Data Inspector, after data is logged from simulation or imported.

For all complex formats, you plot the complex signal as one signal. Some formats display components of the plotted signal as separate traces.

- **Real - Imaginary** — Plot real and imaginary components as separate traces.

The signal line color specifies the color of the real component. The imaginary component uses a different shade of the specified line color.

- **Magnitude-Phase** — Plot magnitude and phase components as separate traces.

The signal line color specifies the color of the magnitude component. The phase component uses a different shade of the specified line color.

- **Magnitude** — Plot only the magnitude component.
- **Phase** — Plot only the phase component.

Subplots — Option to plot signals in Simulation Data Inspector from model

scalar between 1 and 64

When you specify a value for the **Subplots** property, the signal is plotted on the corresponding subplot or subplots in the Simulation Data Inspector. You can use this property to save a plotting configuration in the model. However, the property does not affect the subplot layout in the Simulation Data Inspector or clear signals that are already plotted.

Custom style and color — Option to configure signal line style and color in model

'off' (default) | 'on'

When enabled, you can configure the line style and color used to display the signal in the Simulation Data Inspector and on Dashboard Scope blocks and save the preference in the model so the signal is displayed consistently across MATLAB sessions.

Specifying the line style and color in the model does not prevent you from changing the line style and color in the Simulation Data Inspector. The Dashboard Scope block and the Simulation Data Inspector always display a signal using the line style and color specified in the logged signal properties, as displayed in the **Properties** pane in the Simulation Data Inspector.

Line — Line style, color, and width for Simulation Data Inspector and Dashboard Scope blocks

line style, width, and color

Line style, width, and color used to display the signal on Dashboard Scope blocks and in the Simulation Data Inspector.

Specifying the line style and color in the model does not prevent you from changing the line style and color in the Simulation Data Inspector. The Dashboard Scope block and the Simulation Data Inspector always display a signal using the line style and color specified in the logged signal properties, as displayed in the **Properties** pane in the Simulation Data Inspector.

Dependencies

To enable the **Line** parameter, select **Custom style and color**.

Data Access

Enable run-time data access — Option to stream signal data to MATLAB function during simulation

'on' (default) | 'off'

When enabled, you can specify a data access callback function that processes or visualizes the logged signal data during simulation. The function receives data in packets asynchronously throughout the simulation, and the function executes each time it receives new data. For more information, see “Access Data in a MATLAB Function During Simulation”.

Function name — MATLAB function that receives signal data during simulation

name of MATLAB function

Name of the data access callback function that processes or visualizes signal data during simulation. The data access callback function always receives signal data as the first argument and may also receive simulation time and a function parameter as additional arguments. When the function receives all three arguments, simulation time is the second argument. For more information, see “Access Data in a MATLAB Function During Simulation”.

For more information about writing MATLAB functions, see “Create Functions in Files”.

Include simulation time — Option to send simulation time to MATLAB function

'on' (default) | 'off'

Option to send simulation time along with signal data to the data access callback function during simulation. The data access callback function always receives signal data as the first argument and may also receive simulation time and a function parameter as additional arguments. When a function receives all three arguments, simulation time is the second argument. For more information, see “Access Data in a MATLAB Function During Simulation”.

Function parameter — Option to use parameter to identify data source

numeric | text

When you specify a value for the **Function parameter**, the data access callback receives the specified value as a second or third argument depending on whether time is included with data sent to the callback function. When you use the same data access callback function to process data for more than one signal, specify a function parameter to identify which signal data the function receives in a given call. For more information, see “Access Data in a MATLAB Function During Simulation”.

See Also**Functions**set_param | Simulink.sdi.setSignalInputProcessingMode |
Simulink.sdi.getSignalInputProcessingMode**Tools****Signal Properties | Simulation Data Inspector****Topics**

“Access Data in a MATLAB Function During Simulation”

“Specify Signal Values to Log”

“Limit the Size of Logged Data”

Introduced in R2018a

Library Browser

Find and add blocks to your model

Description

The **Library Browser** displays a tree view of the Simulink libraries on your system. Use the **Library Browser** to locate blocks and annotations to add to your model.

To navigate the libraries, select libraries from the tree or double-click sublibraries in the right pane. When you select libraries in the tree, the contents of the library appear in the right pane. Sublibraries, blocks, and text and image annotations can appear in the right pane. Pause on any item to see a description. Right-click any item to see options. For example, right-click a block to see options to view block parameters, open help for the block, and add an instance of the block to a model.

When you find the item you are looking for, you can drag it into your model or right-click it and select the option to add it to your model.

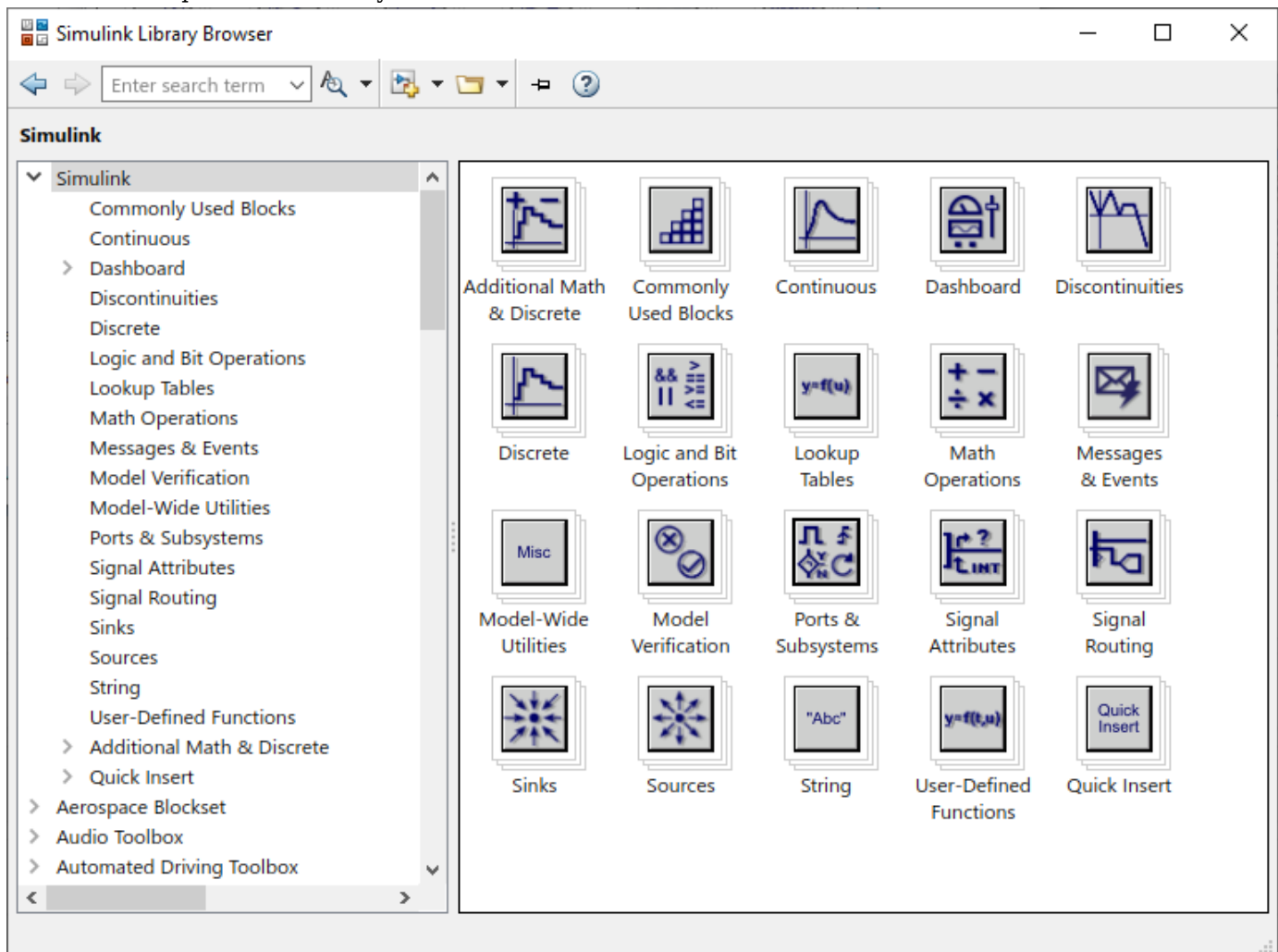

Open the Library Browser

- In the Simulink Toolstrip, on the **Simulation** tab, click **Library Browser**.

You must have a Simulink model, library, or subsystem open to see the Simulink Toolstrip.

- In the MATLAB Command Window, enter `slLibraryBrowser`.

Examples

Search for Blocks in the Library Browser

You can search for blocks and annotations using the search controls.

- 1 In the search box, type the search term or select it from the list of recent search terms.

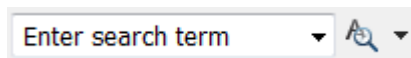

For annotations, you can search for any of the text in the annotation or any part of its description.

- 2 To use regular expressions, case-sensitive search, or whole-word search, click the **Search for subsystems, blocks, and annotations** button arrow, then select the search options you want to use.

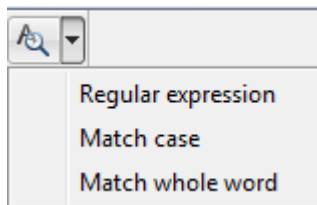

- 3 Press **Enter** to start the search.

The blocks pane displays the blocks found, grouped by library.

To see where the search string matches, pause on a block.

To navigate to a block library, right-click the block, then select **Select in library view**.

Add Blocks to Models from the Library Browser

You can add instances of a library block from the Library Browser to an open model.

Drag the block from the Library Browser to the Simulink Editor canvas.

Alternatively, right-click the block in the Library Browser and select **Add block to model** or **Add block to a new model**. If no model is open, this option creates a model and adds the block to it.

Blocks that you have recently added to your model from the Library Browser appear in the **Recently Used** library at the bottom of the left pane.

Sort Blocks in the Library Browser

By default, library contents appear in alphabetical order. Subsystems appear first, then blocks, and then annotations. If you prefer to view the contents of the libraries in the order set by the developer of the library, right-click the right pane and select **Sort in library model order**. This setting stays in effect from session to session.

To return to the alphabetical order, right-click and select **Sort in alphabetical order**. Depending on the library, some items might not appear in alphabetical order. For example, in the **Simulink** library, the **Quick Insert** library appears as the last item regardless of the sorting option you choose.

Create Custom Libraries

You can create your own libraries and, optionally, have them appear in the **Library Browser**.

For more information, see “Create Custom Library”.

Refresh the Library Browser

Refresh your Library Browser if you:

- Modify existing libraries or resave them in .slx file format.
- Move or delete your library files.
- Add a library.
- Change your Library Browser customizations. See “Customize Library Browser Appearance”.

To refresh the libraries displayed in the Library Browser, right-click in the libraries pane and select **Refresh Library Browser**. The Library Browser updates to display any libraries or blocks added to or deleted from the MATLAB path since the Library Browser was last opened or refreshed.

Tips

You can use keyboard shortcuts to interact with the **Library Browser**.

| Task | Action |
|--|---------------------|
| Open Library Browser from a model | Ctrl+Shift+L |
| Move selection down | Down arrow |
| Move selection up | Up arrow |
| Expand a library | Right arrow |
| Collapse a library | Left arrow |
| Refresh libraries | F5 |

| Task | Action |
|---|-----------------------|
| Navigate to parent library | Esc |
| Navigate from search result to library containing block | Ctrl+R |
| Insert the selected block in a new model | Ctrl+I |
| Increase zoom | Ctrl+Plus (+) |
| Decrease zoom | Ctrl+Minus (-) |
| Reset zoom to default | Alt+1 |
| Find a block | Ctrl+F |
| Close Library Browser | Ctrl+W |

See Also

Functions

`sLibraryBrowser` | `LibraryBrowser.LibraryBrowser2`

Objects

`LibraryBrowser.LBStandalone`

Topics

“Build and Edit a Model Interactively”

“Keyboard Shortcuts and Mouse Actions for Simulink Modeling”

Introduced before R2006a

Model Data Editor

Inspect and edit data items (signals, parameters, and states) in a table that you can sort, group, and filter

Description

The **Model Data Editor** enables you to inspect and edit data items such as signals, block parameters (for example, the **Gain** parameter of a Gain block), and data stores in a list that you can sort, group, and filter. You can then configure properties and parameters, such as data types and dimensions, without having to locate the items in the block diagram.

Use the Model Data Editor to configure multiple signals, states, and algorithmic parameters. The Model Data Editor can set only certain parameters and properties such as data types, initial values, and physical units. To work with one model element at a time, open the **Property Inspector**. To perform batch operations, open the Model Data Editor.

For information about setting block properties and parameters, see “Signal Properties”.

When creating and debugging a model, you can configure multiple data items at once by selecting the corresponding signals and blocks in the block diagram. Work with the selected items in the Model Data Editor instead of opening individual dialog boxes. Use this technique to more quickly view and compare properties of multiple signals that are close to each other in the diagram, for example, in a subsystem.

Use the Model Data Editor to configure:

- Instrumentation for signals and data stores, which allows you to view and collect the simulation values. For example, you can log signals to compare data in the Simulation Data Inspector.
- Design attributes such as data type, minimum and maximum value, and physical units. You can use these attributes to:
 - Specify the values of numeric block parameters.
 - Control the interaction (interface) between components through Inport and Outport blocks and data stores (see “Configure Data Interfaces”).
 - Specify the dimensions of nonscalar signals in a model.

Note The Model Data Editor does not show information about data items in referenced models (which you reference with Model blocks). To work with data items in a referenced model, open the Model Data Editor in that model.

Columns in the Data Table

Use this table to find more information about the purpose of the columns in the Model Data Editor.

| Column Name | Purpose and More Information |
|-----------------------------------|---|
| Source | Shows the name of the block that defines the data item. For signals, also shows the number of the block port that generates the signal. For workspace variables, shows the name of the workspace or data dictionary that contains the variable. |
| Signal Name or Name | Sets the name of the signal, state, or data store. For information about naming signals, see “Signal Names and Labels”. For parameters, displays the programmatic name of each parameter. For workspace variables, sets the name of the variable. |
| Data Type | “Control Data Types of Signals” and “Control Block Parameter Data Types” |
| Min and Max | “Specify Signal Ranges” and “Specify Minimum and Maximum Values for Block Parameters” |
| Dimensions | “Determine Signal Dimensions” |
| Complexity | Sets the numeric complexity of the data item. |
| Sample Time | “What Is Sample Time?” |
| Unit | “Unit Specification in Simulink Models” |
| Test Point | “Configure Signals as Test Points” |
| Log Data | “Iterate Model Design Using the Simulation Data Inspector” |
| Resolve | Corresponds to the Signal name must resolve to Simulink signal object check box in the Signal Properties dialog box and similar check boxes in block dialog boxes for states and data stores. See “Use Signal Objects”. |
| Shared | Corresponds to the Share across model instances parameter of the Data Store Memory block. See Data Store Memory. |
| Initial Value | Sets the initial value of the state or data store. See “Initialize Signal Values”. |
| Value | “Set Block Parameter Values” |
| Argument | Configures a variable in a model workspace as a model argument. See “Parameterize Instances of a Reusable Referenced Model”. |
| Path | Shows the location of the block in the model and provides a link to the block in the Simulink Editor. Visible when you click the Change Scope button. |

Two Entries Per Cell in the Data Table

When a cell contains two entries (for instance, in the **Data Type** column), the entry on the right side of the cell indicates compiled information. The compiled information shows you the value that the data item uses for simulation.

For example, the default data type setting for most signals in a model is `Inherit: Inherit via internal rule`. With this setting, after you update the block diagram, Simulink chooses a specific data type, such as `single`, for the signal to use for simulation. In the Model Data Editor, the cell in the **Data Type** column shows `Inherit: Inherit via internal rule` on the left side and `single` on the right side.

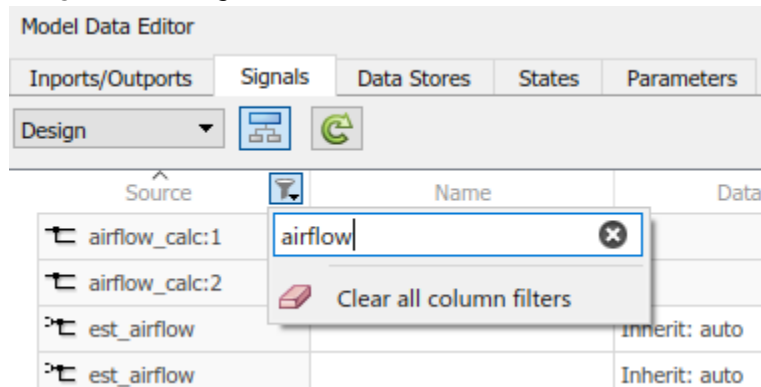

Open the Model Data Editor

- In the Simulink Toolstrip, on the **Modeling** tab, click **Model Data Editor**.
- While in the Simulink Editor, press **Ctrl+Shift+E**.

Examples

Configure Distant Data Items

In this example, use the Model Data Editor to log signals in different subsystems and referenced models so you can inspect their data using the **Simulation Data Inspector**.

The example model `sldemo_fuelsys_dd` represents the fueling system of a vehicle engine. The referenced model `sldemo_fuelsys_dd_controller` controls the rate of fuel flow to the engine.

First, explore the example models.

- 1 Open `sldemo_fuelsys_dd` and the referenced model `sldemo_fuelsys_dd_controller`.
- 2 Navigate to the `airflow_calc` subsystem.

The Pumping Constant block contains a lookup table that describes the performance of a fuel pump. You can stream the output of this block to the Simulation Data Inspector.

- 3 Navigate to the root of the model and into the `fuel_calc` subsystem.
- 4 Navigate into the `feedforward_fuel_rate` subsystem.

The Outport block named `ff_fuel_rate` passes feedforward information to the fuel rate control algorithm.

- 5 Navigate back to the `fuel_calc` subsystem and into the `switchable_compensation` subsystem.

The Inport block named `ff_fuel_rate` carries the feedforward information. You can stream the output of this Inport block.

Then, log signals for data inspection.

- 1 Navigate to the root of the `sldemo_fuelsys_dd_controller` model.
- 2 In the Model Data Editor, inspect the **Signals** tab.
- 3 Set the **Change view** drop-down to **Instrumentation**.

- 4 Activate the **Change scope** button  to display the contents of the subsystems.

The Model Data Editor identifies all the signals in the model. The **Path** column appears.

- 5 In the **Filter Contents** box, type `ff_fuel_rate`.

The Model Data Editor updates the list of signals to include only those named `ff_fuel_rate`. You can click the link in the **Path** column to view where the signal resides within the model.

- 6 Select the **Log Data** check box for the signal whose path is `sldemo_fuelsys_dd_controller/fuel_calc/switchable_compensation`.

This instructs Simulink to send the data for the logged signals to the Simulation Data Inspector.

- 7 Filter the signals again using the text `Pumping Constant`.

The table contains one row that corresponds to the output of the `Pumping Constant` block.

- 8 Select the **Log Data** check box for the `Pumping Constant` signal.
- 9 Simulate the system model, `sldemo_fuelsys_dd`. During the simulation, double-click a `Manual Switch` block, such as `Engine Speed Selector`, to disturb the fuel control system.

- 10 When the simulation finishes, the **Simulation Data Inspector** button  is highlighted. This indicates that there is data to inspect and compare. Click the **Simulation Data Inspector** button.

- 11 In the left pane, expand the **Run** node that corresponds to the simulation run and select the check boxes for the signals whose data you want to inspect and compare.

The Simulation Data Inspector presents the values for the selected signals on the same graph.

Find and Organize Data by Filtering, Sorting, and Grouping

In the example model `sldemo_fuelsys_dd_controller`, variables and parameter objects set the values of block parameters. The variables and objects reside in a data dictionary. Use the Model Data Editor to display these dictionary entries together in a group.



- 1 Open the `sldemo_fuelsys_dd_controller` model.
- 2 In the example model, open the Model Data Editor and select the **Parameters** tab.

- 3 Activate the **Change scope** button to display the contents of the subsystems.
- 4 Click the **Show/refresh additional information** button to display rows that correspond to the dictionary entries.
- 5 Right-click the **Source** column header and select **Group by This Column**.

The Model Data Editor groups the list by block or workspace (including a group for the dictionary entries).

- 6 Find the group labeled **Source: Dictionary**. Now, you can use the Model Data Editor to inspect and modify the attributes of the variables and objects in the dictionary.

The Model Data Editor allows you to filter a list of data items by using one or a combination of these methods:

- To filter the data table through a text search, use the **Filter contents** box.
- To filter based on the blocks or signals that you select in the model, next to the **Filter contents** box, click the **Filter using selection** button. Then, as you click blocks and signals in the model, the Model Data Editor shows you only the rows that are relevant to that block or signal. If you lasso multiple blocks or signals, the Model Data Editor shows only the rows that are relevant to those model elements.
- To filter based on column-specific criteria, point to a column header and click the filter icon . As you type in the text box, the editor applies a substring filter to the column contents. After the filter is applied, the column displays a smaller filter icon  next to the column header. To edit a filter, remove a filter, or remove all column filters, click this icon.

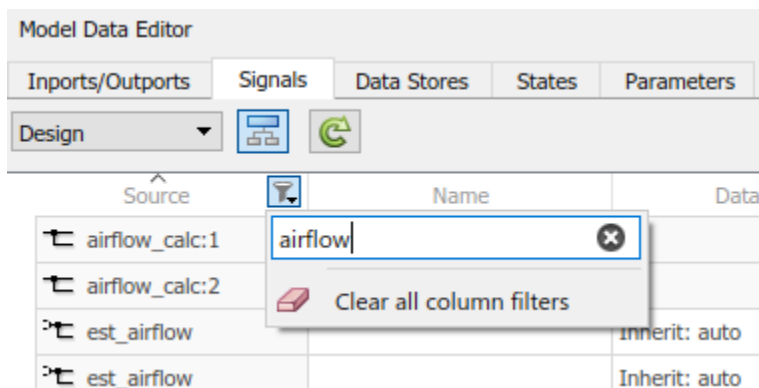

Select Multiple Data Items from Block Diagram

In the example model `sldemo_househeat`, use the Model Data Editor to log the signals in the Heater subsystem for inspection using the **Simulation Data Inspector**.

- 1 Open the `sldemo_househeat` model.
- 2 In the `sldemo_househeat` model, open the Heater subsystem.
- 3 Open the Model Data Editor and select the **Signals** tab.

The Model Data Editor identifies all the signals in the subsystem.

- 4 In the Model Data Editor, set the **Change view** drop-down list to **Instrumentation**.

- 5 Using the Simulink Editor, select all the signals in the subsystem. Optionally, do not select the output of the Constant block because the signal value does not change during the simulation.
In response, the Model Data Editor highlights the rows that correspond to the signals you selected.
- 6 In the Model Data Editor, for any of the signals, click the check box in the **Log Data** column.
The Model Data Editor selects the check box for all of the selected signals.
- 7 Simulate the model.
- 8 Open the Simulation Data Inspector and, in the leftmost pane, expand the **Run** node that corresponds to the simulation run. Select the check boxes for the signals whose values you want to inspect and compare.

Interact with a Model That Uses Workspace Variables

When you use workspace variables (such as numeric MATLAB variables and `Simulink.AliasType` objects) to share settings between data items, you can interact with those variables through the Model Data Editor. You do not need to work outside the Editor to configure the data items. In the Editor, click the **Show/refresh additional information** button, which finds variables that the model uses by updating the block diagram.

This example shows how to work with objects that a model uses to set block parameter values. You modify the value of a variable that the model `sldemo_fuelsys` uses.

- 1 Open the `sldemo_fuelsys` model.
`sldemo_fuelsys`
- 2 Open the Model Data Editor **Parameters** tab.
- 3 In the Model Data Editor, click the **Show/refresh additional information** button.
The data table now contains rows that correspond to variables and objects that the model uses.
- 4 In the model, navigate into the `fuel_rate_control` subsystem and then the `airflow_calc` subsystem.
- 5 In the Model Data Editor, next to the **Filter contents** box, select the **Filter using selection** button.

With this button selected, when you select a block or signal in the block diagram, the data table shows only the data items and workspace variables that are relevant to that block or signal.

- 6 In the model, click the lookup table block labeled `Pumping Constant`.

The Model Data Editor shows that the block uses three workspace variables. The block acquires some breakpoint values from the variable `SpeedVect`.

Now, you can use the columns in the Model Data Editor to configure the properties of `SpeedVect`.

You can further interact with a variable to:

- Configure other properties that the columns do not represent:
 - 1 In the model, open the Property Inspector. On the **Modeling** tab, under **Design**, click **Property Inspector**.

- 2 In the Model Data Editor, select the row that corresponds to the target variable or object. If the Property Inspector does not respond, select a different row and then select the target row again.
 - 3 Use the Property Inspector to configure the target properties.
- Move the variable between workspaces and data dictionaries and configure the variable alongside other variables. Use the Model Explorer. To open the Model Explorer, in the Model Data Editor data table, double-click the icon in the leftmost column. For more information about using the Model Explorer, see “Edit and Manage Workspace Variables by Using Model Explorer”.
 - Rename a variable everywhere it is used by blocks in Simulink models. In the Model Data Editor, right-click the variable and select **Rename All**. You can rename only variables that the function `Simulink.findVars` supports.
 - Find blocks that use a specific variable. In the Model Data Editor, right-click the variable and select **Find Where Used**.

Inspect Individual Data Item

To focus on an individual data item, use one of these techniques:

- In the Model Data Editor, next to the **Filter contents** box, select the **Filter using selection** button. Then, in the model, click the block or signal that corresponds to the data item.

Use this technique to configure the item by using the columns in the data table.

- In the model, open the Property Inspector. On the **Modeling** tab, under **Design**, click **Property Inspector**. Then, in the data table, click the target row. The Property Inspector shows the properties of the data item. If the Property Inspector does not respond when you click the target row, click a different row and then click the target row again.

Use this technique to inspect all of the properties that the Model Data Editor can access at once (in other words, the union of the columns available in the **Design** and **Instrumentation** views).

- In the model, open the Property Inspector. Then, in the data table, for the target row, double-click the cell in the leftmost column (the icon). In the model, select the highlighted block or signal.

Use this technique to inspect all properties, including those that the Model Data Editor cannot access.

Navigate from Model Data Editor to Block Diagram

To navigate from a data item in the Model Data Editor to the block in the diagram that owns the data item, double-click the icon in the left-most column. The Simulink Editor then focuses on the relevant block. Use this technique to navigate to blocks when you select **Change scope** to view the contents of subsystems below the current system.

- “Use the Model Data Editor for Batch Editing”

Limitations

- You cannot access these attributes by using the Model Data Editor:

- Any settings related to code generation. Instead, use the Code Mappings editor or code mappings API.
- For mask parameters:
 - Any settings for tunable mask parameters other than the parameter value.
 - Any settings for nontunable mask parameters.

Note that some built-in blocks are masked and can have tunable or nontunable mask parameters.

- Any settings for parameters of Simscape blocks.
- Any settings for data items in referenced models. Instead, open the Model Data Editor in the referenced models.
- Any settings for variables that are not defined in the base workspace, a model workspace, or a data dictionary. For example, you cannot access the attributes of variables created by mask initialization code.
- On the **Parameters** tab, the data type, minimum value, and maximum value of a Constant block. Use the **Signals** tab instead.

For some settings that you cannot access with the Model Data Editor, you can use the **Property Inspector** instead. Open the Property Inspector and select the target data item in the model, not in the Model Data Editor. For mask parameters, use the mask dialog box or the Mask Editor as described in “Masking Fundamentals”.

- The Model Data Editor does not show Stateflow data. However, the Model Data Editor shows the data for Simulink functions that you define inside Stateflow charts.

To manage Stateflow data, events, and messages in a chart, see “Manage Symbols in the Stateflow Editor” (Stateflow).

- On the **Parameters** tab, these variables are not available:
 - Variables used by non-tunable block parameters. For example, the minimum and maximum parameters on a Gain block or the `Sample time` on a Constant block.
 - Variant control variables
 - Variables used for symbolic dimensions

See Also

Property Inspector | **Model Explorer**

Topics

“Use the Model Data Editor for Batch Editing”

“Configure Data Interfaces”

“Design Data Interface by Configuring Inport and Outport Blocks” (Simulink Coder)

“Decide How to Visualize Simulation Data”

“Configure Generated Code According to Interface Control Document Specifications” (Embedded Coder)

Introduced in R2016b

Model Explorer

View, modify, and add elements of Simulink models, Stateflow charts, and workspace variables

Description

Use the Model Explorer to view, modify, and add elements of Simulink models, Stateflow charts, and workspace variables.

The Model Explorer lets you focus on specific elements (for example, blocks, signals, and properties) without navigating through the model or chart.

Use the Model Explorer to search for:

- Variables in workspaces and data dictionaries
- Variable usage in a model
- Instances of a type of block
- Block parameters and parameter values

You can combine search criteria and iteratively refine the results. Search in the Model Explorer for model elements, starting with the node you select in the model hierarchy. You can search the entire model, in a particular system, or in a system and all the systems below it in the hierarchy. Using your search results, you can apply changes to multiple elements at once.

To manipulate model data (block parameters, signals, and states) in a searchable, sortable table, consider using the **Model Data Editor**. You can specify data attributes such as parameter values, signal names, and initial values for states.

To create, modify, and view the entries in a data dictionary, use the Model Explorer. See “Edit and Manage Workspace Variables by Using Model Explorer” and “View and Revert Changes to Dictionary Data”.

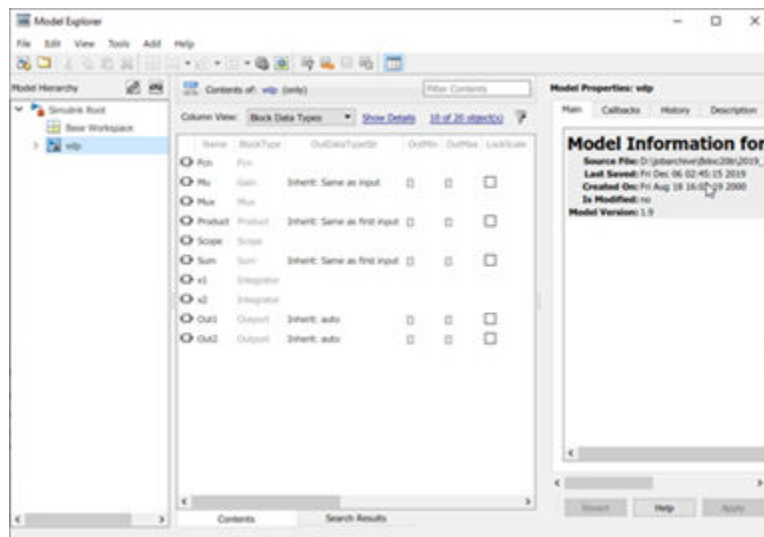

Open the Model Explorer

- In the Simulink Toolstrip, on the **Modeling** tab, click **Model Explorer**.
- In an open model in the Simulink Editor, right-click a block and select **Explore**.
- In an open Stateflow chart, right-click the drawing area and select **Explore**.

Examples



Add Objects to a Model, Chart, or Workspace

You can use the Model Explorer to add many kinds of objects to a model, chart, or workspace. The types of objects that you can add depend on the node that you select in the **Model Hierarchy** pane.

Use toolbar buttons or the **Add** menu to add objects. The **Add** menu lists the types of objects you can add.

Cut, Copy, and Paste Objects Between Workspaces

You can cut, copy, and paste objects from one workspace into another workspace.

- 1 In the **Contents** pane, perform one of these actions:
 - Right-click the workspace object you want to cut or copy. Select **Cut** or **Copy**.
 - Click the workspace object you want to cut or copy. In the **Edit** menu, select **Cut** or **Copy**.
 - Click the workspace object you want to cut or copy. In the toolbar, click the **Cut** button  or **Copy** button .
- 2 To paste the workspace object that you cut or copied, in the **Model Hierarchy** pane:
 - Right-click the workspace into which you want to paste the object, and select **Paste**.
 - Click the workspace into which you want to paste the object. In the **Edit** menu, select **Paste**.
 - Click the workspace into which you want to paste the object. In the toolbar, click the **Paste** button .

When you copy and paste (or drag and drop), you can manage the resolution of name conflicts. In the dialog box, choose an action for each item whose name conflicts with an existing item.

- **Skip** — Default action when the conflicting items have the same value.
- **Replace** — Default action when the conflicting items have different values.
- **Keep both** — Preserve both copies. The name given to the copied item follows the naming rules that are used in the MATLAB workspace.

If the source and destination are the same, the software resolves the name conflict by following the naming rules that are used in the MATLAB workspace.

You can also cut, copy, and paste by selecting an object and performing drag and drop operations.

Edit Object Properties

You can edit object properties in the Model Explorer.

In the **Contents** pane, first select the row that contains the value, and then click the value. Change the value of the selected property by typing or selecting a new value.

To assign the same property value to multiple objects in the **Contents** pane, select the objects and then change one of the values of the selected objects. The Model Explorer assigns the new property value to all of the selected objects.

Alternatively, you can edit values for model elements in the **Dialog** pane. To display the **Dialog** pane, click **View > Show Dialog Pane**.

To edit workspace variables, such as arrays or structures, you can use the Variable Editor.

To open a properties dialog box for an object, in the **Model Hierarchy** pane, right-click the object and select **Properties**. Alternatively, click an object and from the **Edit** menu, select **Properties**.

Search and Refine Search Results

To find objects that might not be currently displayed, search.

In this example, you search for elements that have an **Integer rounding mode** parameter. You then refine the results to include only n-D Lookup table blocks. You can use the search results to find out more about how these values are set or make batch changes to the elements found by the search.

- 1 Open the model `sldemo_fuelsys`.
- 2 On the **Modeling** tab, click **Model Explorer**.
- 3 To specify the scope of the search, use the **Model Hierarchy** pane in combination with the **View > Show Current System and Below** setting. For example, to search the current system and loaded systems below it, select the `sldemo_fuelsys` node and enable **View > Show Current System and Below**.
- 4 Display the search bar by enabling **View > Toolbars > Search Bar**.
- 5 In the search bar, set:

- **Search** to by Property Name
- **Property** to Rounding

Rounding is the programmatic name for the **Integer rounding mode** parameter. Block reference pages list the programmatic name for a parameter in the parameter description.

- 6 Click **Search**. In the **Search Results** box, results appear. You can go to an item by clicking the link to the path.
- 7 Refine the search. In the search bar, click the **Search Options** button  and select **Refine Search**.

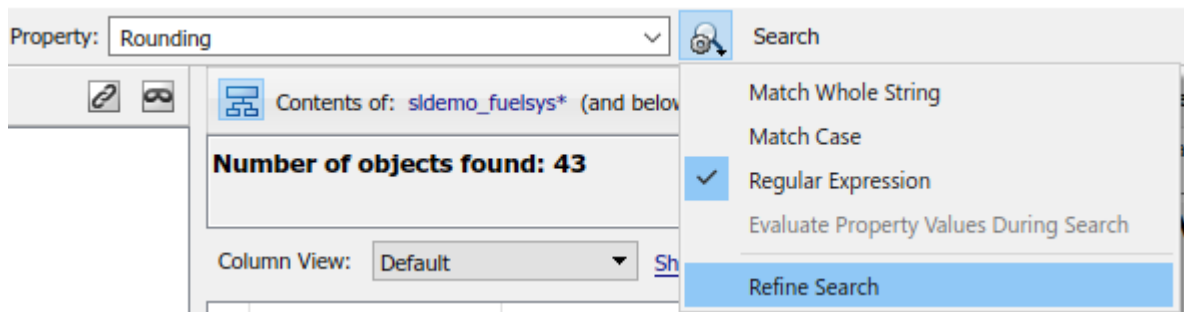

The search button label changes to **Refine**. Additional search criteria act on the previous set of results.

- 8 Set **Search** to by **Block Type** and set **Type** to **Lookup_n-D**. Click **Refine**.
- 9 To work further with the values, click **Show Details**.

Suppose the property you are interested in learning more about or acting on is **Rounding**. First, add a column for it. Select **Rounding** from the list (you can enter it in the **Find Properties** box to locate it quickly), and click the **Display property as column in view** button .

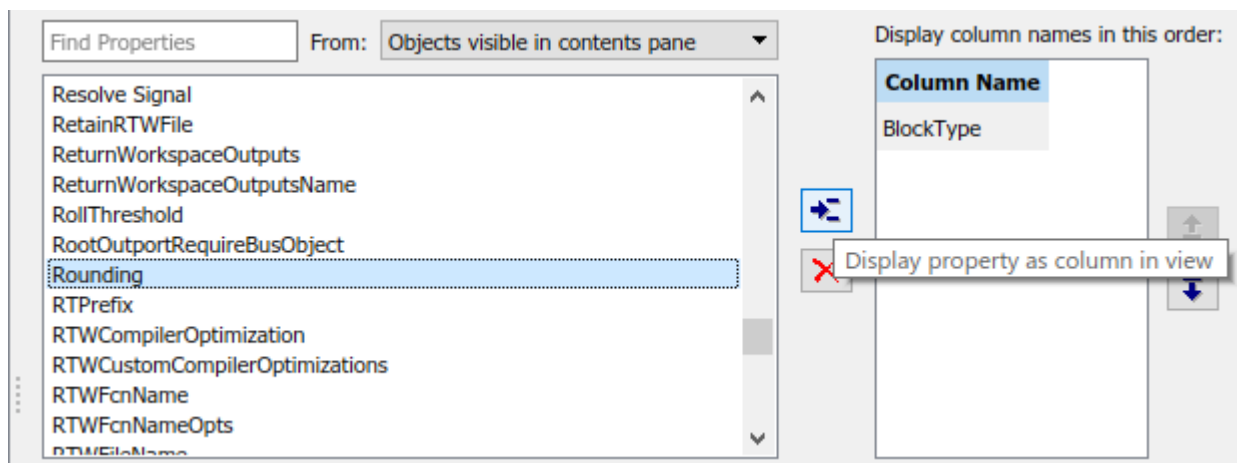

A column for **Rounding** appears in the search results. For any column, you can view, sort, and change values for multiple items. For example, to change the **Rounding** values on all of the n-D Lookup Table blocks in this search, select all the items in the list. In the **Rounding** column, click any cell and select a new value from the list (for example, **Floor**).

Tip To view a summary of the search options that you used, expand the **Number of objects found** box by clicking the **Show Search Details** button .

You can use the Model Explorer to create, modify, and view the entries in a data dictionary. See “Edit and Manage Workspace Variables by Using Model Explorer” and “View and Revert Changes to Dictionary Data”.

Display Partial or Whole Model Hierarchy Contents

By default, the Model Explorer displays objects for the system that you select in the **Model Hierarchy** pane. It does not display data for child systems. You can override that setting, so that the Model Explorer displays objects for the whole hierarchy of the currently selected system.

To toggle between displaying only the current system and displaying the whole system hierarchy of the current system, use one of these techniques:

- Select **View > Show Current System and Below**.
- Click the **Show contents of current system and below** button  at the top of the **Contents** pane.

When you select the **Show Current System and Below** option:

- The **Model Hierarchy** pane highlights the current system and its child systems.
- After the path in the **Contents** pane, the text (and below) appears.

Loading very large models for the current system and below can be slow. To stop the loading process at any time, either click the **Show contents of current system only** button or click another node in the tree hierarchy.

If you show the current system and below, you might want to change the view to better reflect the displayed system contents.



The setting for the **Show Current System and Below** option is persistent across Simulink sessions.

Note To open a graphical object (for example, a model, subsystem, or chart) in a Simulink Editor window from the Model Explorer, right-click the object in the **Model Hierarchy** pane, then select **Open**.

Display Linked Library Subsystems and Masked Subsystems

By default, the Model Explorer does not display the contents of linked library subsystems or masked subsystems in the **Model Hierarchy** pane.

To display the contents of linked library subsystems or masked subsystems, use one of these approaches:

- At the top of the **Model Hierarchy** pane, click the **Show/Hide Library Links** button  or the **Show/Hide Masked Subsystems** button .
- From the **View** menu, select **Show Library Links** or **Show Masked Subsystems**.

Linked subsystems and masked subsystems are visible in the **Contents** pane, regardless of how you configure the **Model Hierarchy** pane.

Note Search does not find elements in linked library or masked subsystems that are not displayed in the **Model Hierarchy** pane.

For subsystems that are both linked and masked, how you set the linked subsystems and masked subsystems options affects which subsystems appear in the **Model Hierarchy** pane, as described in the following table.

| Settings | Subsystems Displayed in the Model Hierarchy Pane |
|--|---|
| Show Library Links Hide Masked Subsystems | Only library-linked, unmasked subsystems |
| Hide Library Links Show Masked Subsystems | Only masked subsystems that are not library-linked subsystems |
| Show Library Links Show Masked Subsystems | All library-linked or masked subsystems |

Expand and Edit Referenced Models

To browse a model that includes Model blocks, you can expand the **Model Hierarchy** pane nodes of the Model blocks.

To browse a model referenced by a Model block:

- 1 Right-click the referenced model node in the **Model Hierarchy** pane.
- 2 Select **Open Model**.

The referenced model opens as a top model and appears as a separate node in the **Model Hierarchy** pane. While you can expand the Model block node and display the corresponding contents, you must use the node that corresponds to the referenced model to edit them.

For example, the `sldemo_mdref_depgraph` model includes Model blocks that reference other models. If you open the `sldemo_mdref_depgraph` model and expand that model node in the **Model Hierarchy** pane, you see that the model contains several Model blocks, including `heat2cost`.

If you right-click the `heat2cost` Model block node and select **Open Model**, the **Contents** pane displays the objects in the `heat2cost` Model block. You can expand the `heat2cost` node.

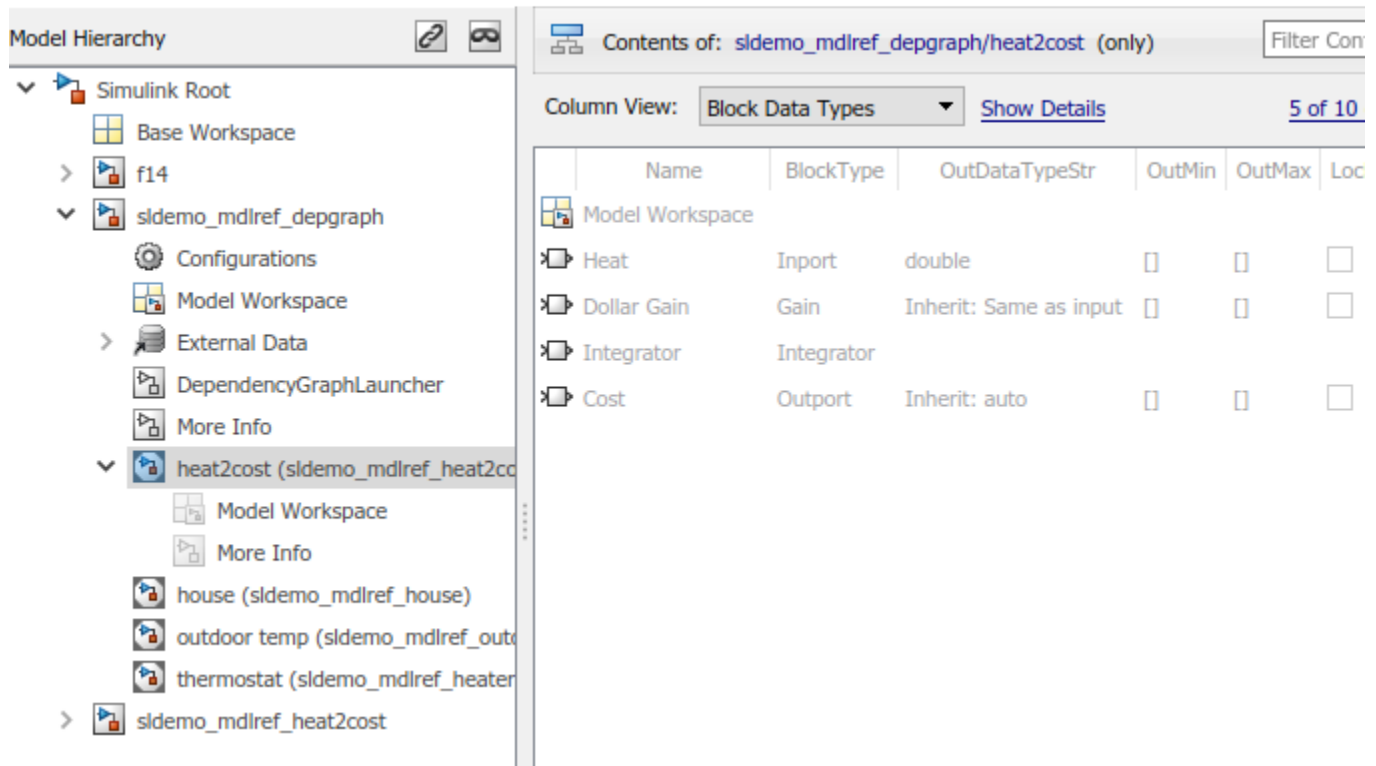

You can browse the contents of the referenced model, but you cannot edit the objects in the Model block.

To edit the referenced model, expand the referenced model node in the **Model Hierarchy** pane, and then access the properties of objects in the referenced model. For example, expand the `sldemo_mdref_heat2cost` node.

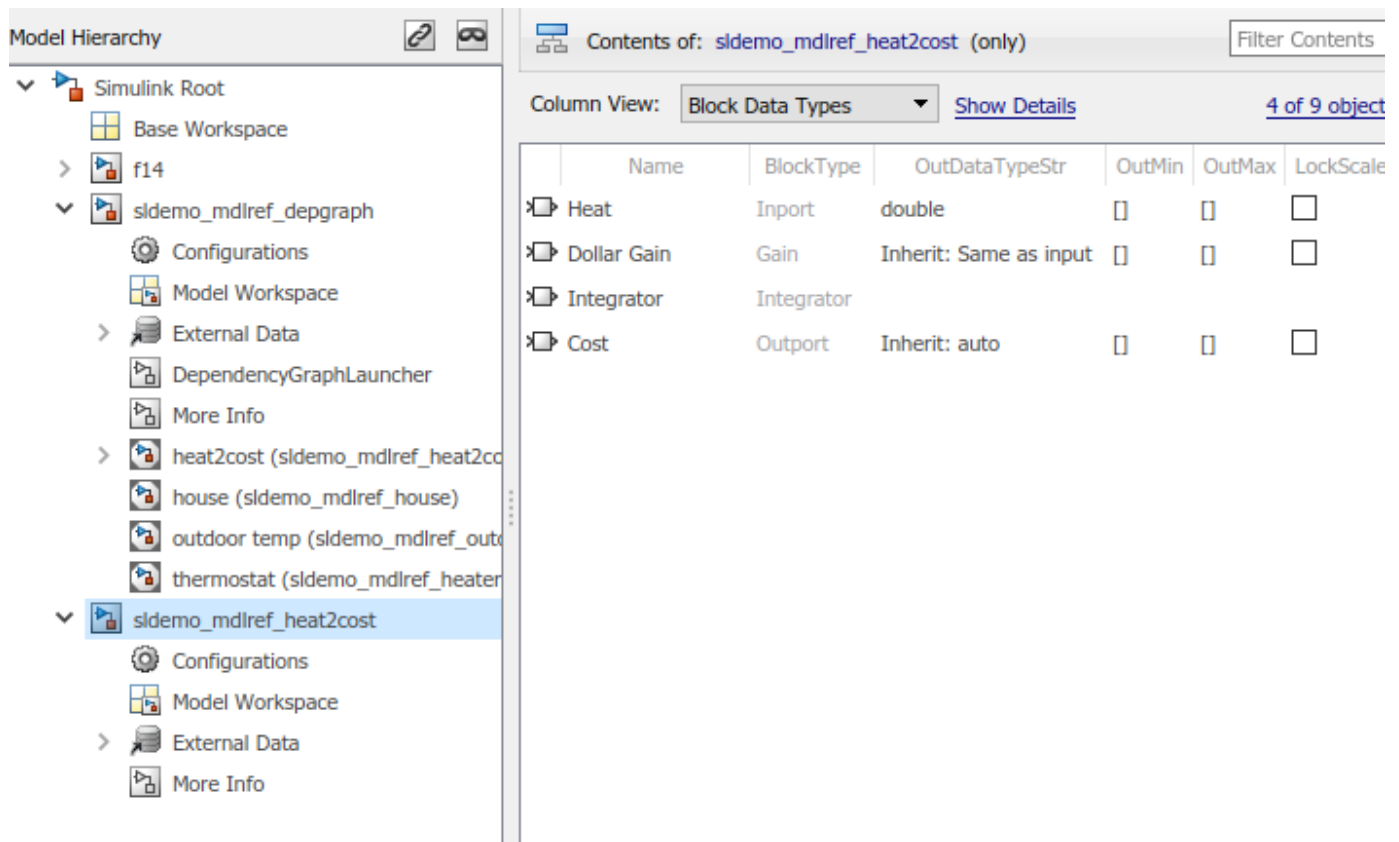

For information about referenced models, see “Model Reference Basics”.

Change Font Size

You can change the font size in the Model Explorer panes.

To increase the font size, press **Ctrl+Plus (+)**. Alternatively, from the Model Explorer **View** menu, select **Increase Font Size**.

To decrease the font size, press **Ctrl+Minus (-)**. Alternatively, from the Model Explorer **View** menu, select **Decrease Font Size**.

The changes remain in effect for the Model Explorer and in Simulink dialog boxes across Simulink sessions.

Create Views

If a default view that ships with the Model Explorer does not meet your needs, you can modify or create a view.

To open the View Manager dialog box, select **View > Column View > Manage Views**.

To copy and rename an existing view:

- 1 In the View Manager dialog box, select the view that you want to use as the starting point for your new view.
- 2 Click the **Copy** button.

A new row appears at the bottom of the View Manager table. The new row contains the name of the view you copied, followed by a number in parentheses. For example, if you copy the Stateflow view, the initial name of the copied view is Stateflow (1).

To create a new view, in the View Manager dialog box, click the **New** button. A new view row appears at the bottom of the View Manager table.

After you create a view, you can name and describe the view:

- 1 Double-click the name of the view in the **View** column and enter a name for the view.
- 2 Double-click the text in the **Description** column and enter a description for the view.
- 3 Click **OK**.

Customize Views and Filter Contents

You can control the information the **Contents** pane displays and directly manipulate column headings.

To control which property columns to display, use the **View > Column View** option.

To control which types of objects to display, use the **View > Row Filter** option.

To focus on specific objects in the **Contents** pane, based on a search string, filter contents.

As you customize the table represented by the current view, you change the current view definition. The Model Explorer saves the following changes to the table as part of the column view definition:

- Grouping by property
- Sorting in a column
- Changing the order of property columns
- Adding a property column
- Hiding and removing property columns

When you change from one view to another view, the Model Explorer saves any customizations that you have made to the previous view.

For example, suppose you set **Column View** to Block Data Types view and you hide the LockScale property column. If you then switch to use the Data Objects view, and later use the Block Data Types view again, the Block Data Types view no longer includes the LockScale column that you hid.

At the end of a Simulink session, the Model Explorer saves the view customizations that you made during that session. When you reopen the Model Explorer, Simulink uses the customized view, and maintains any changes that you made to the view in the previous session.

If you modify a default view that ships with the Model Explorer, you can reset it to factory settings. With the default view as the current view, in the **Contents** pane, click **Show Details**, then click **Options > Reset This View to Factory Settings**.

To reset the factory settings for *all* default views in one step, in the View Manager dialog box, click the **Options > Reset All Views to Factory Settings**.

Note When you reset all views, the Model Explorer removes all the custom views you have created. Before you reset views to factory settings, export any views that you will want to use in the future. For more information, see “Manage Views” on page 7-47.

Manage Views

In the View Manager, you can delete, reposition, export, and import views for use by the Model Explorer.

To open the View Manager, select **View > Column View > Manage Views**.

To delete a view from the **Column View** list of views:

- 1 In the View Manager dialog box, select one or more views that you want to remove from the list.
- 2 Click the **Delete** button or press the **Delete** key.
- 3 Click **OK**.

Deleting a view using the View Manager dialog box permanently deletes that view from the Model Explorer interface. If you think you or someone else might want to use a view again, consider exporting the view before you delete it.

To change the position of a view in the **Column View** list:

- 1 In the View Manager dialog box, select one or more views that you wish to move up or down in the table of views.
- 2 Click the up or down arrow buttons to the right of the table. Repeat this step until the view appears where you want it to be in the table.
- 3 Click **OK**.

To export views that you or others can then import:

- 1 In the View Manager dialog box, select one or more views that you want to export.
- 2 Click the **Export** button. The Export Views dialog box opens with check marks next to the views that you selected.
- 3 Click **OK**. An Export to File Name dialog box opens.

Navigate to the folder where you want to export the view. By default, the Model Explorer exports views to the current folder in MATLAB.

- 4 Specify the file name for the exported view. The file is saved as a **.mat** file.
- 5 Click **OK**.

To import view files for use by the Model Explorer:

- 1 In the View Manager dialog box, click **Import**. The Select .mat File to Import dialog box opens.
- 2 Navigate to the folder that contains the view you want to import.
- 3 Select the MAT-file containing the view that you want to import and click **Open**. A confirmation dialog box opens. Click **OK** to import the view.

The imported views are added at the bottom of the View Manager table. The Model Explorer automatically renames the view if a name conflict occurs.

- “Build and Edit a Model Interactively”

Parameters

Search Bar

Search — Specify the type of objects or properties to include in the search

by Name | by Property Name | by Property Value | by Block Type | ...

Open the search bar by selecting **View > Toolbars > Search Bar**.

Use the **Search** setting to specify the type of objects or properties to include in the search.

| Search Type Option | Description |
|--------------------------|--|
| by Name | Searches a model or chart for all objects that have the specified string in the name of the object. |
| by Property Name | Searches for objects that have a specified property. Specify the target property name from a list of properties that objects in the search domain can have. |
| by Property Value | Searches for objects with a property value that matches the value you specify. Specify the name of the property, the value to be matched, and the type of match (for example, equals, less than, or greater than). |
| by Block Type | Searches for blocks of a specified block type. Select the target block type from the list of types contained in the currently selected model. |
| by Stateflow Type | Searches for Stateflow objects of a specified type. |
| for Variable Usage | Searches for blocks that use variables defined in a workspace. Select the base workspace or a model workspace (model name) and, optionally, the name of a variable. |
| for Referenced Variables | Searches for variables that a model or block uses. Specify the name of the model or block in the by System field. The model or block must be in the Model Hierarchy pane. |
| for Unused Variables | Searches for variables that are defined in a workspace but not used by any model or block. Select the name of the workspace from the drop-down list for the in Workspace field. |
| for Library Links | Searches for library links in the current model. |
| by Class | Searches for Simulink objects of a specified class. |

| Search Type Option | Description |
|-------------------------|--|
| for Fixed Point Capable | Searches a model for all blocks that support fixed-point computations. |
| for Model References | Searches a model for references to other models. |
| by Dialog Prompt | Searches a model for all objects whose dialogs contain the prompt you specify. |
| by String | Searches a model for all objects in which the string you specify occurs. |

Search Options – Specify search strings

name | property | type | variables | ...

Use search option settings to specify the scope of the search.

| Search Option | Description |
|---|--|
| Match Whole String | Do not allow partial string matches (for example, do not allow sub to match substring). |
| Match Case | Considers case when matching strings (for example, Gain does not match gain). |
| Regular Expression | Considers a string to be matched as a regular expression. |
| Evaluate Property Values During Search | This option applies only for searches by property value. If enabled, Model Explorer evaluates the value of each property as a MATLAB expression and compares the result to the search value. If this option is disabled, the Model Explorer compares the unevaluated property value to the search value. |
| Refine Search | Enables you to search the initial search results. The second search operation searches for objects that meet both the original and the new search criteria. |

By default, search strings are case-insensitive and are treated as regular expressions. The search allows partial string matches. You cannot use wildcard characters in search strings. For example, if you enter *1 as a name search string, you get no search results unless there is an item whose name starts with the characters *1. If there is an out1 item, the search results do not include that item.

Model Hierarchy Pane

Simulink Root – Display display nodes representing the MATLAB workspace, Simulink models, and Stateflow charts

node structure

Expand **Simulink Root** to display nodes representing the MATLAB workspace, Simulink models, and Stateflow charts that are in the current session.

Base Workspace – MATLAB workspace

node structure

Base Workspace represents the MATLAB workspace. The MATLAB workspace is the base workspace for Simulink models and Stateflow charts. Variables defined in this workspace are visible to all open models and charts.

Expanding a model or chart node in the **Model Hierarchy** pane displays nodes representing the following elements, as applicable, for the models and charts you have open.

| Node | Description |
|----------------------|--|
| Configurations | Select the Configurations node to show the model's configuration sets and configuration references in the Contents pane. For information about adding, deleting, saving, and moving configuration sets, see “Manage Configuration Sets for a Model”. |
| Model Workspace | For information about how to use the Model Explorer to work with model workspace variables, see these topics: <ul style="list-style-type: none"> • “Edit and Manage Workspace Variables by Using Model Explorer” • “Model Workspaces” |
| External data | Expand the External Data node to display external data sources for the model, including the base workspace (if access is enabled), and data dictionaries. |
| Top-level subsystems | Expand a node representing a subsystem to display underlying subsystems. |
| Model blocks | Expand model blocks to show contents of referenced models. |
| Stateflow charts | <ul style="list-style-type: none"> • Expand a node representing a Stateflow chart to display the top-level states of the chart. • Expand a node representing a state to display its substates. |

Contents Pane

Contents Pane — Describe contents of node

table

The **Contents** pane displays one of two tables containing information about models and charts, depending on the tab that you select:

- The **Contents** tab displays an object property table for the node that you select in the **Model Hierarchy** pane.
- The **Search Results** tab displays the search results table.

You can also click **Show Details** to add and modify the columns that appear in the tables.

The **Contents** pane displays a table of model and chart object data.

In the **Contents** tab and in the **Search Results** tab:

- Table columns correspond to object properties (for example, Name and BlockType).

The table displays the first two columns (the object icon and the Name property) persistently, so that these columns remain visible regardless of how far you scroll to the right.

- Table rows correspond to objects (for example, blocks, and states).

The objects and properties displayed in the **Contents** pane depend on:

- The column view that you select in the **Column View** menu
- The node that you select in the **Model Hierarchy** pane
- The kind of object (for example, subsystem or chart) that you select in the **Model Hierarchy** pane
- The **View > Row Filter** options that you select

The link next to **Contents of** at the top of the **Contents** pane links to the currently selected node in the **Model Hierarchy** pane. The model data displayed in the **Contents** pane reflects the setting of the **Current System and Below** option.

Column View — Named set of properties

properties

The Model Explorer uses views to specify sets of property columns to display in the **Contents** pane.

Each kind of node in the **Model Hierarchy** pane displays specific properties in the **Contents** pane. For example, a Simulink model or subsystem node displays properties such as:

- `BlockType` (block type)
- `OutDataTypeStr` (output data type)
- `OutMin` (minimum value for the block output)

Generally, a column view does not contain the total set of properties for all the objects in a node. Specifying a subset of properties to display can streamline the task of exploring and editing model and chart object properties and increase the density of the data displayed in the **Contents** pane.

You can use a view to capture the following characteristics of the model information to show in the Model Explorer:

- Properties that you want to display in the **Contents** pane
- The layout of the **Contents** pane (for example, grouping by property, the order of property columns, and sorting)

You can use views in the following ways:

- Use the standard views that ship with the Model Explorer
- Customize the standard views
- Create your own views

The first time you open the Model Explorer, Simulink automatically applies one of the standard views to the node you select in the **Model Hierarchy** pane. The Model Explorer applies a view based on the kind of node you select.

The Model Explorer assigns one of four categories of nodes in the **Model Hierarchy** pane. The Model Explorer initially associates a default view with each node category. The four node categories are:

| Node Category | Kinds of Hierarchy Nodes Included | Initial Associated View |
|----------------|---|-------------------------|
| Simulink | Models, subsystems, and root level models | Block Data Types |
| Workspace | Base and model workspace objects | Data Objects |
| Stateflow | Stateflow charts and states | Stateflow |
| Configurations | Configurations section node | Configurations |
| Other | Objects that do not fit into one of the first three categories; for example, configuration sets | Default |

The **Column View** field at the top of the **Contents** pane displays the view that the Model Explorer is currently using.

In the **Contents** pane, from the **Column View** list, you can select a different view. If you select a different view, then the Model Explorer associates that view with the category of the current node. For example, suppose the selected node in the **Model Hierarchy** pane is a Simulink model, and the current view is **Data Objects**. If you change the view to **Signals**, then when you select another Simulink model node, the Model Explorer uses the **Signals** view.

By default, the Model Explorer automatically applies a view based on the category of node that you select and the last view used for that node. You can manually select a view from the **Column View** list that better meets your current task.

You can shift from the default mode of having the Model Explorer automatically apply views to a mode in which you must manually select a view to change views.

To enable the manual view selection mode:

- 1 Select **View > Column View > Manage Views**.

The View Manager dialog box opens.

- 2 In the View Manager dialog box, click the **Options** button and clear **Change View Automatically**.

In the manual view selection mode, if you switch to a different kind of node in the **Model Hierarchy** pane that has a different view associated with it, the **Contents** pane displays a yellow informational bar suggesting a view to use.

You can manage views (for example, create a new view or export a view) using the View Manager dialog box. To open the View Manager dialog box, select the **Manage Views** option from either:

- The **View > Column View** menu
- The options listed when you click the **Options** button in the column view details section

The View Manager dialog box displays a list of defined views and provides tools for you to manage views.

You can manage views in several ways, including creating, deleting, reordering, exporting, importing, and resetting views.

Tip Interface — Display or hide tips

tip field

The tip interface appears immediately above the table in the **Contents** pane. It does not appear if, in the View Manager dialog box, you clear **Options > Change View Automatically**. The tip interface displays a link for changing the current view to a suggested view. To choose the suggested view displayed in the tip bar, click the link. To hide the currently displayed tip, from the menu button on the right side of the tip bar, select **Hide This Tip**.

Initially, the suggested view is the default view associated with a node. If you associate a different view with a node category, then the tip suggests the most recently selected view when you select similar nodes.

To change from manual specification of views to automatic specification, from the tip interface, select the down arrow and **Change View Automatically**.

To enable the tip interface, in the **View** menu, select **Column View > Manage Views**. In the View Manager, enable **Options > Change View Automatically**.

Dialog Pane

Dialog Pane — Display properties of objects

dialog pane

Use the **Dialog** pane to view and change properties of objects that you select in the **Model Hierarchy** pane or in the **Contents** pane.

By default, the **Dialog** pane appears to the right of the **Contents** pane. To show or hide the **Dialog** pane, use one of these approaches:

- From the **View** menu, select **Show Dialog Pane**.
- From the main toolbar, click the **Dialog View** button .

To edit property values using the **Dialog** pane:

- 1 In the **Contents** pane, select an object (such as a block or signal). The **Dialog** pane displays the properties of the object you selected.
- 2 Change a property (for example, the port number of an Outport block).
- 3 Click **Apply** to accept the change, or click **Revert** to return to the original value.

By default, clicking outside the **Dialog** pane when a field has unapplied changes causes the Apply Changes dialog box to appear. Click **Apply** to accept the changes or **Ignore** to revert to the original settings.

To prevent the Apply Changes dialog box from displaying:

- 1 In the dialog box, click the **In the future Apply or Ignore (whichever I select) without asking** check box.
- 2 If you want Simulink to apply changes without warning you, press **Apply**. If you want Simulink to ignore changes without warning you, press **Ignore**.

To restore the **Apply Changes** dialog box, from the **Tools** menu, select **Prompt if dialog has unapplied changes**.

When you select a numeric MATLAB variable or a `Simulink.Parameter` object in a model workspace, the **Argument** check box appears in the **Dialog** pane. This check box configures the variable or object as a model argument. See “Parameterize Instances of a Reusable Referenced Model”.

Programmatic Use

`daexplr` opens the Model Explorer.

See Also

Simulink Editor

Topics

“Build and Edit a Model Interactively”

Model Reference Conversion Advisor

Convert subsystems to referenced models

Description

The Model Reference Conversion Advisor converts subsystems, including conditional and referenced subsystems, to referenced models.

Converting subsystems to referenced models is beneficial for modeling large, complex systems and for team-based development. Many large models use a combination of subsystems and referenced models. To decide whether to convert a subsystem to a referenced model, see “Choose Among Types of Model Components”.

When the conversion encounters an issue, the advisor helps you review and fix the issue. Preparing the contents of a Subsystem block can eliminate or reduce the number of issues that the advisor identifies. Addressing these issues in the model editing environment can be more efficient than switching repeatedly between the advisor and the Simulink Editor.

The Model Reference Conversion Advisor does not support conversion for some types of subsystems. For example:

- Subsystem blocks with Simscape Multibody™ components that cross the subsystem boundary
- Asynchronous subsystems — To convert asynchronous subsystems to referenced models that accept asynchronous function calls, see “Asynchronous Support Limitations” (Simulink Coder).

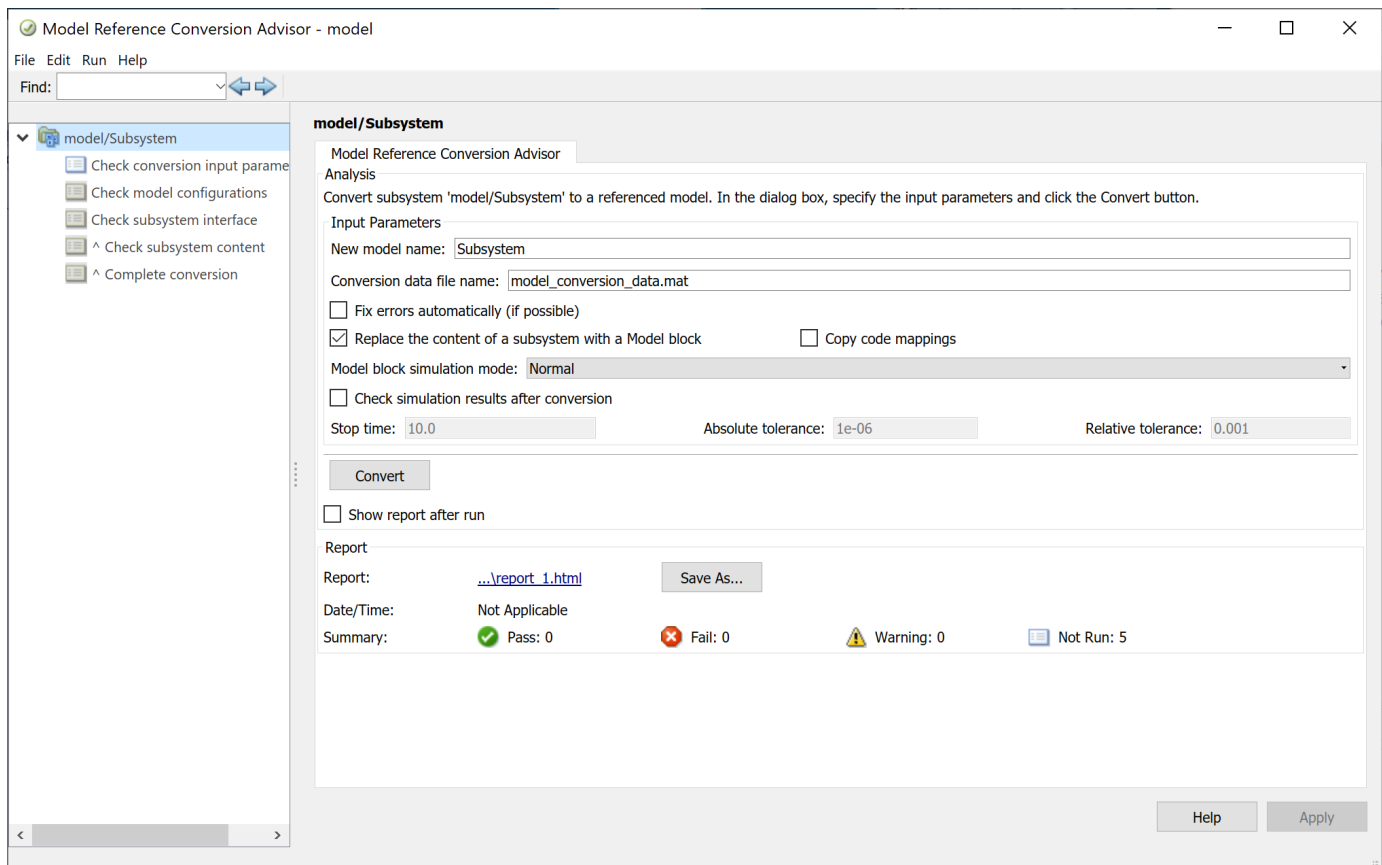

Open the Model Reference Conversion Advisor

- In the Simulink Editor, select a Subsystem block. In the Simulink Toolstrip, on the **Subsystem Block** tab, select **Convert > Model Block**.
- In the MATLAB command window, use the `Simulink.SubSystem.convertToModelReference` function with the 'UseConversionAdvisor' argument set to true.

Examples

Set Subsystem Conversion Options

Specify input parameters that determine the output of the conversion and control whether the advisor automatically attempts to fix conversion errors.

When you open the advisor, in the left pane, the top node is selected. This node identifies the Subsystem block that the advisor will convert to a referenced model and provides conversion input parameters. You can use the default parameter values or change the values to customize the conversion.

| Input Parameter | Description |
|--|---|
| New model name | <p>The advisor provides a model name based on the Subsystem block name that is unique in the MATLAB path.</p> <p>The model name cannot exceed 59 characters. For more information, see “Model Names”.</p> <hr/> <p>Tip If the advisor generates an error indicating that the target referenced model already exists, then use the New model name parameter to specify a new file name.</p> |
| Conversion data file name | <p>The advisor creates a file for storing data created during the conversion. By default, the advisor uses the model name at the beginning of the file name and appends the file name with <code>_conversion_data.mat</code>. For example, for a subsystem in a model named <code>myModel</code>, the conversion file name is <code>myModel_conversion_data.mat</code>.</p> <p>You can save the conversion data in a MAT-file (default) or a MATLAB file. If you use a <code>.m</code> file extension, the advisor serializes all variables to a MATLAB file.</p> <hr/> <p>Note If the top model uses a data dictionary, you cannot select this option.</p> |
| Fix errors automatically (if possible) | <p>By default, if an advisor check finds an error that the advisor can fix, the advisor provides a Fix button. Click it to have the advisor fix the issue.</p> <p>If you enable this parameter, the advisor fixes all the conversion errors it can without displaying the Fix button.</p> |
| Replace the content of a subsystem with a Model block | <p>By default, the advisor updates the original model by inserting a Model block. The advisor action depends on whether you use the automatic fix options.</p> <ul style="list-style-type: none"> • If you use the automatic fixes, then the advisor replaces the Subsystem block with a Model block unless the automatic fixes change the input or output ports. If the ports change, the advisor includes the contents of the subsystem in a Model block and inserts it into the Subsystem block. • If you do not use the automatic fixes, then the advisor replaces the Subsystem block with a Model block. <p>Clear this parameter to have the advisor open a new Simulink Editor window that contains only a Model block that references the newly created referenced model. The advisor does not update the original model in the other Simulink Editor window.</p> |

| Input Parameter | Description |
|--|--|
| Copy code mappings | <p>Copy the code mapping information from the parent model to the new, converted referenced model. By default, this parameter is cleared.</p> <p>Code mapping information includes configurations of model data elements for code generation. This parameter does not affect simulation.</p> <p>For more information, see “Convert Subsystem to Referenced Model and Generate Code” (Simulink Coder).</p> |
| Model block simulation mode | <p>Simulation mode for the new Model block that references the referenced model.</p> <ul style="list-style-type: none"> • Normal (default) • Accelerator |
| Check simulation results after conversion | <p>Compare top-model simulation results before and after conversion.</p> <p>To use this option, before performing the conversion:</p> <ul style="list-style-type: none"> • Enable signal logging for the subsystem output signals of interest. • Select Replace the content of a subsystem with a Model block. • Set the Model block simulation mode option in the advisor to the same simulation mode as the original model. • Specify the Stop time, Absolute tolerance, and Relative tolerance. <p>To see the results after the conversion is complete, click View comparison results. The advisor displays the results of the comparison in the Simulation Data Inspector. For more information, see “Compare Simulation Results Before and After Conversion”.</p> |
| Stop time | <p>By default, the advisor uses the stop time of the top model, unless the stop time of the top model is <code>inf</code>. If the stop time of the top model is <code>inf</code>, the advisor uses a default stop time of 10.</p> <p>To use this option, select Check simulation results after conversion.</p> |
| Absolute tolerance | <p>The absolute signal tolerance for the simulation run comparison. The default is $1e-06$.</p> <p>To use this option, select Check simulation results after conversion.</p> |
| Relative tolerance | <p>The relative signal tolerance for the simulation run comparison. The default is $1e-03$.</p> <p>To use this option, select Check simulation results after conversion.</p> |
| Show report after run | <p>After the conversion completes, open a report that summarizes the conversion setup and results.</p> |

Automatically Convert Subsystem to Referenced Model

The Model Reference Conversion Advisor can step through each check automatically.

- 1 After you configure the subsystem conversion options, click **Convert**.

The Model Reference Conversion Advisor steps through each check automatically.

- 2 Address any issues that the advisor reports. The advisor provides a **Fix** button for any issues it can fix automatically.
- 3 After you address the reported issues, click **Continue**.

After the Model Reference Conversion Advisor successfully runs all checks, it completes the conversion.

Check Conversion Input Parameters

Verify that all conversion input parameters are valid.

For information on conversion input parameters, see “Set Subsystem Conversion Options” on page 7-56.

- 1 In the left pane, select the **Check conversion input parameters** node.
- 2 Click the **Run This Task** button.
- 3 Address any issues that the advisor reports. The advisor provides a **Fix** button for any issues it can fix automatically.
- 4 After you address the reported issues, click **Continue**.

Check Model Configurations

Verify that the model configurations meet model referencing requirements. This check identifies model configuration parameter settings that are not valid for model references.

- 1 In the left pane, select the **Check model configurations** node.
- 2 Click the **Run This Task** button.
- 3 Address any issues that the advisor reports. The advisor provides a **Fix** button for any issues it can fix automatically.
- 4 After you address the reported issues, click **Continue**.

Check Subsystem Interface

Verify whether the subsystem interface meets model reference requirements.

- 1 In the left pane, select the **Check subsystem interface** node.
- 2 Click the **Run This Task** button.

The advisor verifies that the type of subsystem is one that the advisor can convert. Then, it verifies that the interfaces to specific types of subsystems, such as masked subsystems, meet conversion requirements.

- 3 Address any issues that the advisor reports. The advisor provides a **Fix** button for any issues it can fix automatically.

- 4 After you address the reported issues, click **Continue**.

Check Subsystem Content

Verify whether the subsystem content meets model reference requirements.

- 1 In the left pane, select the **Check subsystem content** node.
- 2 Click the **Run This Task** button.

The advisor checks whether the model compiles successfully. Upon successful compilation, the advisor checks whether the blocks in the subsystem meet the requirements for conversion.

- 3 Address any issues that the advisor reports. The advisor provides a **Fix** button for any issues it can fix automatically.
- 4 After you address the reported issues, click **Continue**.

Complete Conversion

After all checks run successfully, complete the conversion.

- 1 In the left pane, select the **Complete conversion** node.
- 2 Click the **Run This Task** button.

The Model Reference Conversion Advisor:

- Creates a referenced model from the subsystem.
- Creates the `Simulink.Bus` objects, `Simulink.Signal` objects, and tunable parameters that the referenced model requires.
- By default, replaces the Subsystem block with a Model block that references the new model.
- Inserts the Model block in a Subsystem block if the automatic fixes added ports to the Model block interface.
- Creates an HTML conversion summary report in the `s\prj` folder. This report summarizes the results of the conversion process, including the results of the fixes that the advisor performed. This report also describes the elements that the advisor copies.
- Optionally checks the consistency of simulation results before and after conversion.
- Copies the following elements from the original model to the new referenced model.
 - **Configuration set** — If the parent model uses:
 - A configuration set that is not a referenced configuration set, the advisor copies the entire configuration set to the referenced model
 - A referenced configuration set, then both the parent and referenced models use the same referenced configuration set
 - **Variables** — The advisor copies only the model workspace variables that the subsystem used in the original model to the model workspace of the referenced model. If the model that contained the subsystem uses a data dictionary, then the referenced model uses the same data dictionary.

- **Requirements links** — The advisor copies requirements links created with Simulink Requirements™ software to the Model block from the original Subsystem block.

If you are not satisfied with the conversion results, you can restore the model to its initial state. After you successfully run the **Complete conversion** check, use the **Click here to restore the original model** link.

If you selected **Check simulation results after conversion**, you can view the results by using the **Click here to view the comparison results** link.

Compare Simulation Results Before and After Conversion

If you selected **Check simulation results after conversion**, the Model Reference Conversion Advisor provides a comparison of top-model simulation results before and after conversion.

After you successfully run the **Complete conversion** check, click **Click here to view the comparison results**. The results display in the **Simulation Data Inspector**. A green check mark indicates that simulation results are within tolerance between the baseline model and the model with the new referenced model.

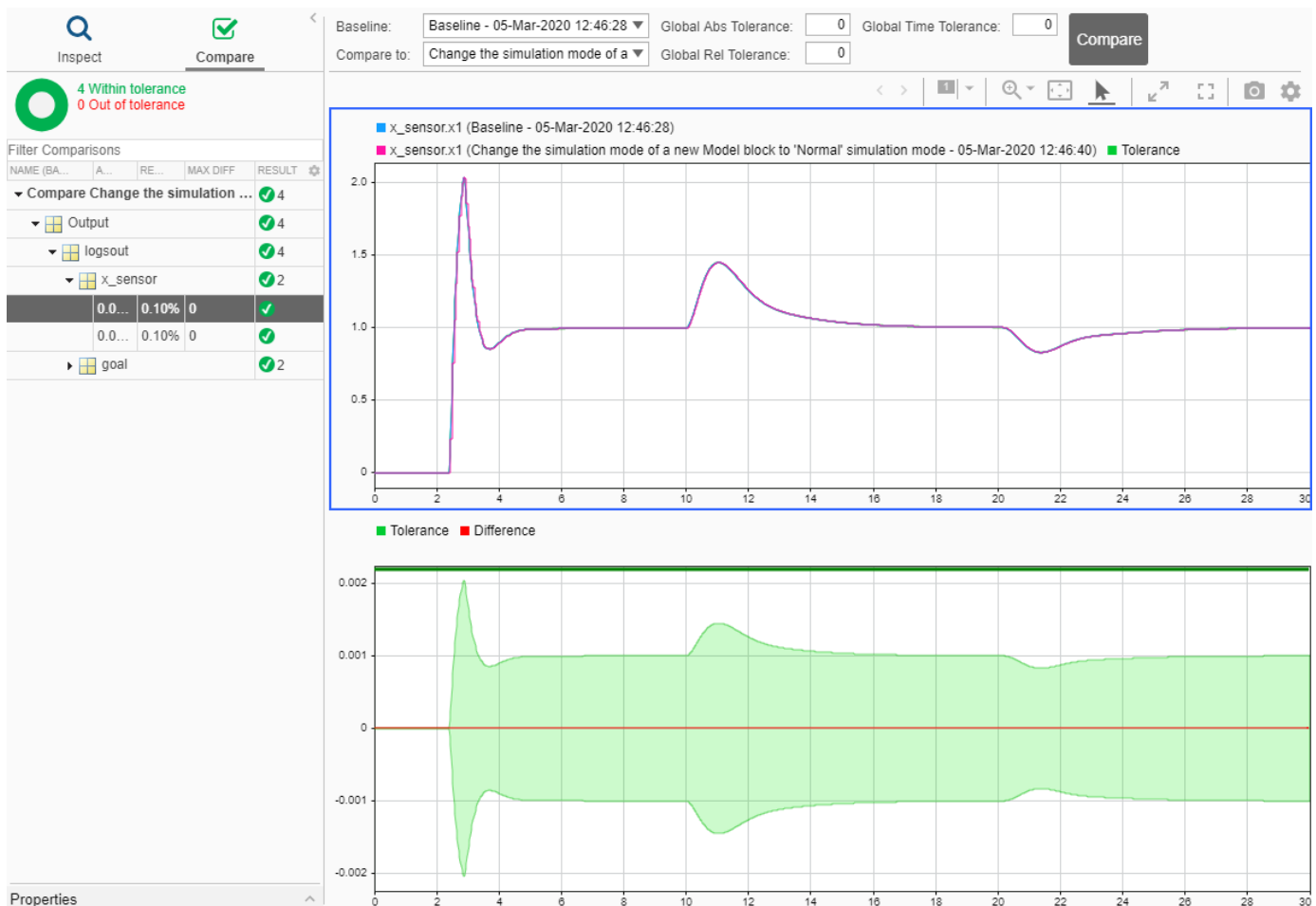

For more information, see “Compare Simulation Data”.

See Also

Functions

`Simulink.SubSystem.convertToModelReference`

Blocks

Subsystem | Model

Topics

“Convert Subsystems to Referenced Models”

“Choose Among Types of Model Components”

“Model Reference Requirements and Limitations”

“Convert Subsystem to Referenced Model and Generate Code” (Simulink Coder)

Introduced in R2014a

Multiple Simulations

Run multiple simulations from the Simulink Editor

Description

Multiple Simulations panel allows you to setup multiple simulations for a block parameter that you want to vary, for example, for a parameter sweep, or Monte-Carlo simulations. You can pick the block parameter of interest from the model canvas and specify values that you want to use for the simulations. You can also specify variables for the simulations. With the **Multiple Simulations** panel, you can provide configurations such as **Use Parallel** to run your simulations in parallel. To run the simulations that you have set up, first, select the design study, then click the **Run All** button in the **Simulation** section on the Simulink toolstrip. Once the simulations are complete, you can view and manage the results in **Simulation Manager**.

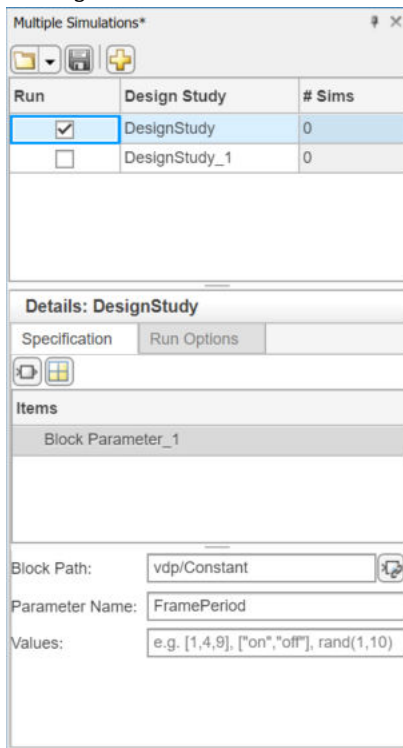

Open the Multiple Simulations

- To open the **Multiple Simulations** panel, navigate to the **Prepare** section on the Simulink

toolstrip. In the **Inputs & Parameter Tuning** section, click **Multiple Simulations**

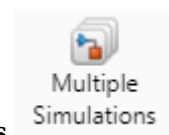

Examples

- “Multiple Simulations Panel: Simulate for Different Values of Stiffness for a Vehicle Dynamics System”

Programmatic Use

`parsim(in)` is the command line equivalent syntax for the command line.

More About

Design Study

In the panel, you can click the right most button to create a new design study. A new design study object is added to the panel. The name of this design study is automatically populated. To change the name, double click on the name and enter your preferred name. A design study is an object that allows you to set up simulations. Once you configure and set up the values for the simulations, you can select this design study and click **Run All** on the Simulink toolstrip to run the simulations.

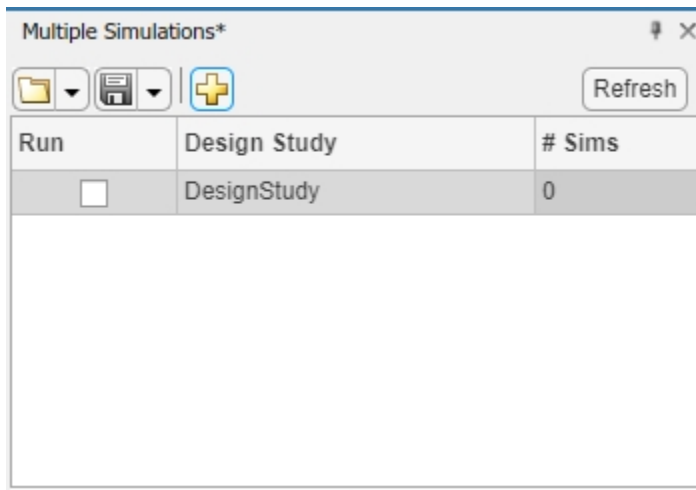

See Also

“Running Multiple Simulations” | “Comparison Between Multiple Simulation Workflows” | “Configure and Run Simulations with Multiple Simulations Panel”

Topics

“Multiple Simulations Panel: Simulate for Different Values of Stiffness for a Vehicle Dynamics System”

Introduced in R2021b

Property Inspector

Edit parameters and properties for any Simulink model element

Description

The Simulink **Property Inspector** enables you to use a single interface to edit parameters and properties for any model element.

You can leave the Property Inspector open as you build your model, and it updates with your selection. You can use the Property Inspector to edit:

- Block parameters and properties
- Stateflow elements
- Annotations, areas, and images
- Signals
- Model properties

When you open the Property Inspector, it opens as a pane in the current Simulink Editor window. You can drag the Property Inspector from the default location and dock it in another location in the editor. You can collapse the Property Inspector pane by clicking the pushpin.

The Property Inspector lets you quickly set parameters and properties as you work. Values take effect when you set them. For more information on setting block parameters and properties, see “Add Blocks and Set Parameters”.

Note You can alternatively open a dialog box for a selected model element by right-clicking and selecting an item such as **Properties**, or for blocks, **Block Parameters**. Double-clicking a block generally opens a block dialog box. (Use one of the menu commands on Subsystem and Model blocks.)

The Property Inspector and dialog boxes operate on a single selected element. The main difference is that the Property Inspector updates with each selection, and the dialog box shows settings for only the element you opened it from. For this reason, the dialog box is useful if:

- You are moving through the model hierarchy and want to see or set element parameters or properties as you navigate the model.
 - You want to compare the parameters or properties of similar elements.
 - The settings are advanced and appear only in the dialog box.
-

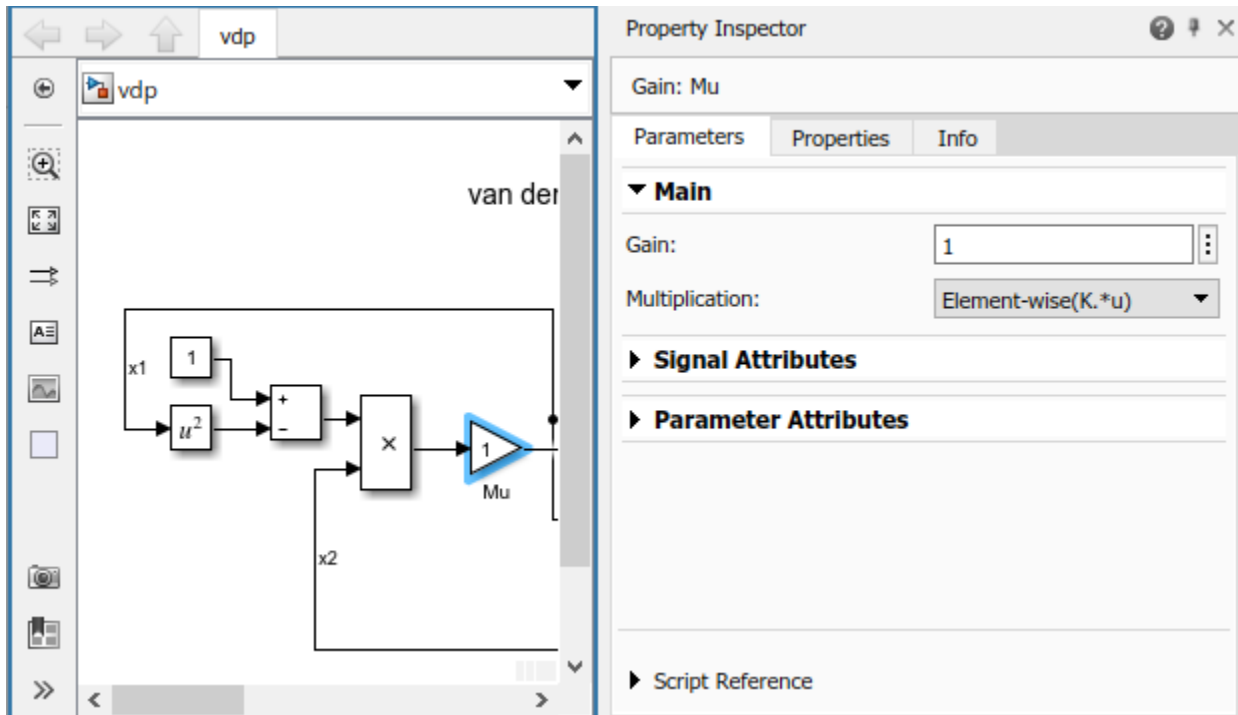

Open the Property Inspector

- In the Simulink Toolstrip, on the **Modeling** tab, in the **Design** gallery, select **Property Inspector**.
- While in the Simulink Editor, press **Ctrl+Shift+I**.

Examples

Set Block Parameter Value

You can set parameters on most blocks. Parameters allow you to specify how a block operates in the model.

- 1 Open the vdp model.
vdp
- 2 Open the Property Inspector. On the **Modeling** tab, in the **Design** gallery, click **Property Inspector**.
- 3 In the model, select the Gain block named Mu.
- 4 In the Property Inspector, set the **Gain** parameter to 2, then press **Enter**.

See Also

Model Explorer | **Model Data Editor**

Topics

“Build and Edit a Model Interactively”

“Add Blocks and Set Parameters”
“Manage Model Versions and Specify Model Properties”
“Create, Edit, and Manage Workspace Variables”
“Data Objects”

Introduced in R2016b

Referenced Files Pane

View, save, and close referenced subsystems and models

Description

The **Referenced Files** pane allows you to view, save, and close referenced subsystems and models in the corresponding model hierarchy.

The **Referenced Files** pane shows a flat list of model and subsystem files that are loaded and referenced by the model hierarchy. Opening the top model in the model hierarchy does not load the referenced models in the model hierarchy. Load referenced models by opening them in the Simulink Editor or by using a function such as `load_system`. Referenced subsystems load when you load the models that reference them.

When you save a model using the **Referenced Files** pane, you also save the models it references. When you close a model using the **Referenced Files** pane, you also close the models it references that are not open in another model hierarchy. Before you can close a modified model, you must choose whether to save the corresponding changes, which include changes to the model workspace.

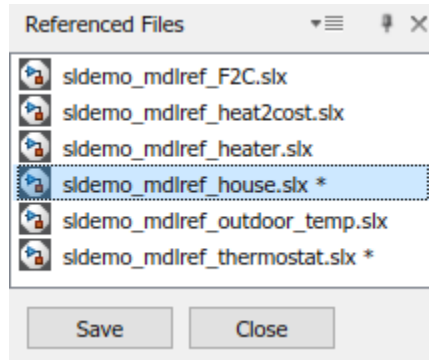

Open the Referenced Files Pane

- On the **Modeling** tab, in the **Design** gallery, click **Referenced Files**.
- If a referenced file in the model hierarchy has been modified, on the **Simulation** tab, click the **Save All** button arrow, then click **Save Referenced Files > Manage Referenced Files**.
- Navigate into a referenced model in the model hierarchy. The **Referenced Files** pane opens as a tab on the left side of the Simulink Editor unless you have previously hidden the pane.

Examples

Individually Save and Close Referenced Models

Save and discard changes to individual referenced models in a model hierarchy.

Open the top model in a model hierarchy that contains multiple referenced models.

sldemo_mdref_depgraph

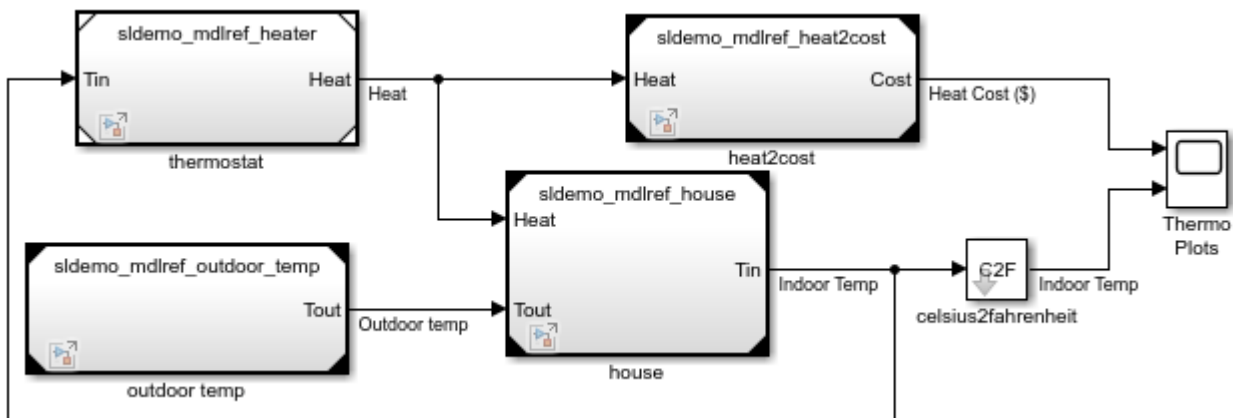

On the Simulink Toolstrip **Modeling** tab, in the **Design** gallery, click **Referenced Files**.

The **Referenced Files** pane opens. It does not show any referenced subsystems or models. The `sldemo_mdref_depgraph` model does not reference any subsystems, but it references multiple models. The referenced models must be loaded to appear in the **Referenced Files** pane.

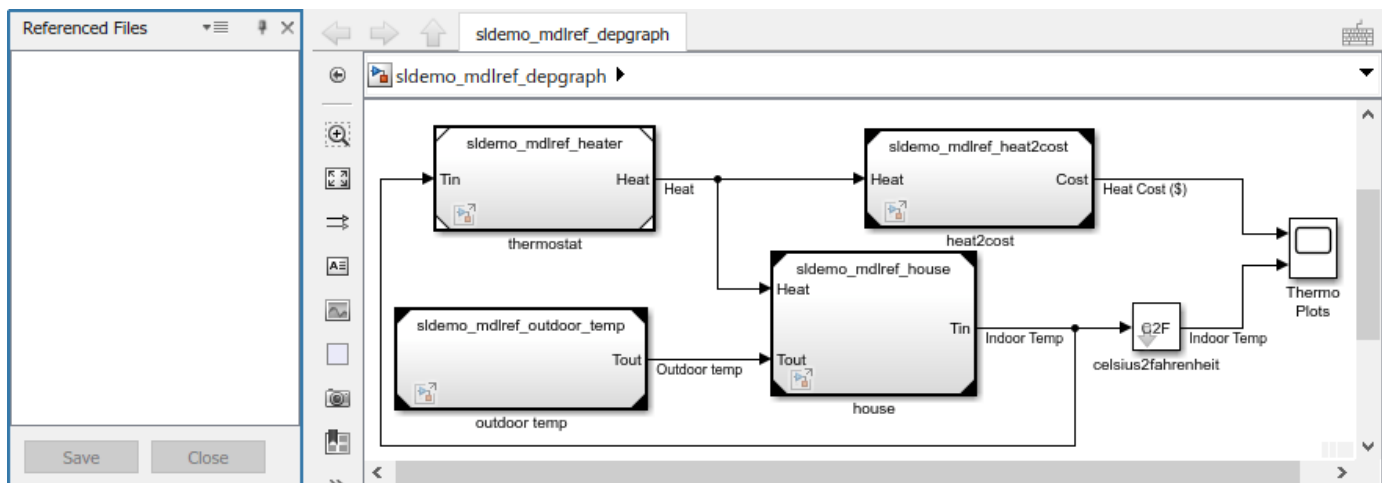

Double-click the block named `thermostat`.

The `sldemo_mdref_heater` model loads and opens. When **Show Only Modified Files** in the **Filter contents** list (☰) is cleared, this model appears in the **Referenced Files** pane. Otherwise, you must modify the file before it appears.

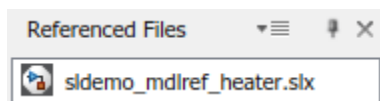

Modify `sldemo_mdref_heater` by moving a block.

Next to the model name, the dirty flag (*) indicates that the model has unsaved changes.



Double-click the block named `Fahrenheit` to `Celsius`.

The `sldemo_mdref_F2C` model loads and opens.

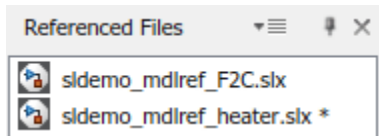

Modify `sldemo_mdref_F2C` by moving a block.

Next to the model name, the dirty flag (*) indicates that the model has unsaved changes.

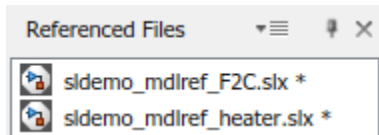

Suppose you want to keep your changes to `sldemo_mdref_F2C`, and you want to discard your changes to `sldemo_mdref_heater`.

If you select `sldemo_mdref_heater` and click **Close**, you receive a message asking whether to save the changes to `sldemo_mdref_heater` and `sldemo_mdref_F2C` before closing both models. Unless a referenced model is open in another model hierarchy, closing its parent model closes the referenced model.

To keep your changes to `sldemo_mdref_F2C`, select it in the **Referenced Files** pane and click **Save**. Then, select `sldemo_mdref_heater` and click **Close**.

See Also

Topics

“Navigate Model Hierarchies”

“Inspect Model Hierarchies”

“Component-Based Modeling Guidelines”

Introduced in R2020b

Sequence Viewer

Visualize messages, events, states, transitions, and functions

Description

The Sequence Viewer visualizes message flow, function calls, and state transitions.

Use the Sequence Viewer to see the interchange of messages, events, function calls in Simulink models, Simulink behavior models in System Composer™ and between Stateflow charts in Simulink models.

In the Sequence Viewer window, you can view event data related to Stateflow chart execution and the exchange of messages between Stateflow charts. The Sequence Viewer window shows messages as they are created, sent, forwarded, received, and destroyed at different times during model execution. The Sequence Viewer window also displays state activity, transitions, and function calls to Stateflow graphical functions, Simulink functions, and MATLAB functions. For more information, see “Use the Sequence Viewer to Visualize Messages, Events, and Entities”.

Note The Sequence Viewer does not display function calls generated by MATLAB Function blocks and S-functions.

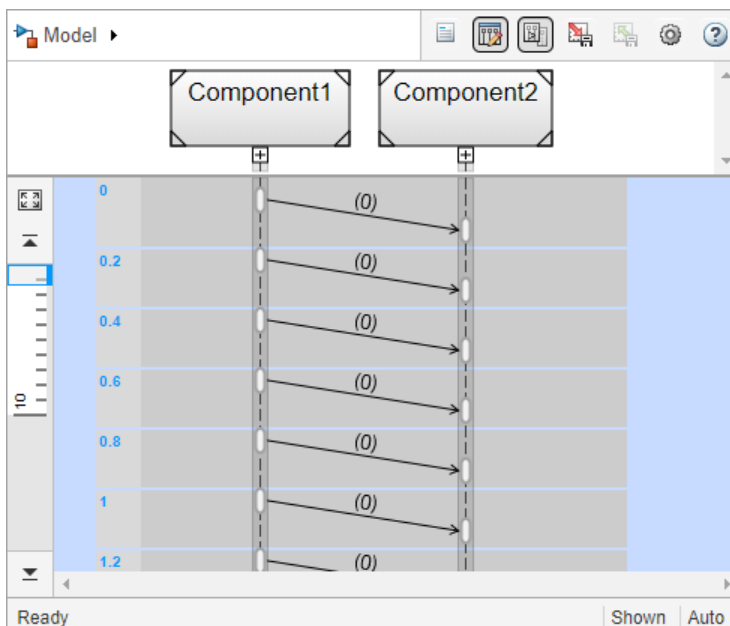

Open the Sequence Viewer

- Simulink Toolstrip: On the **Simulation** tab, in the **Review Results** section, click **Sequence Viewer**.

Examples

Using the Sequence Viewer Tool

- 1 To activate logging events, in the Simulink Toolstrip, under the **Simulation** tab, in the **Prepare** section, click **Log Events**.
 - 2 Simulate your model.
 - 3 To open the tool, in the Simulink Toolstrip, under the **Simulation** tab, in the **Review Results** section, click **Sequence Viewer**.
- “Use the Sequence Viewer to Visualize Messages, Events, and Entities”
 - “Simulink Messages Overview”

Parameters

Time Precision for Variable Step — Digits for time increment precision

3 (default) | scalar

Number of digits for time increment precision. When using a variable step solver, change this parameter to adjust the time precision for the sequence viewer. By default the block supports 3 digits of precision. Minimum and maximum precision are 1 and 16, respectively.

Suppose the block displays two events that occur at times 0.1215 and 0.1219. Displaying these two events precisely requires 4 digits of precision. If the precision is 3, then the block displays two events at time 0.121.

Programmatic Use

Block Parameter: SequenceViewerTimePrecision

Type: character vector

Values: '3' | scalar

Default: '3'

History — Maximum number of previous events to display

1000 (default) | scalar

Total number of events before the last event to display. Minimum and maximum number of events are 0 and 25000, respectively.

For example, if **History** is 5 and there are 10 events in your simulation, then the block displays 6 events, including the last event and the five events prior the last event. Earlier events are not displayed. The time ruler is greyed to indicate the time between the beginning of the simulation and the time of the first displayed event.

Each send, receive, drop, or function call event is counted as one event, even if they occur at the same simulation time.

Programmatic Use

Block Parameter: SequenceViewerHistory

Type: character vector

Values: '1000' | scalar

Default: '1000'

See Also

Topics

[“Use the Sequence Viewer to Visualize Messages, Events, and Entities”](#)

[“Simulink Messages Overview”](#)

Introduced in R2020b

Signal Properties

View and edit signal properties

Description

Use the Signal Properties dialog box to view and edit properties for signals in your model. Using the Signal Properties dialog box, you can mark a signal for logging, specify a signal name, and configure logging options, including which data points to log and the logging sample time.

When your model is configured for concurrent execution, the Signal Properties dialog box also includes a **Data Transfer** tab. For more information, see “Configure Data Transfer Settings Between Concurrent Tasks” and “Configure Your Model for Concurrent Execution”.

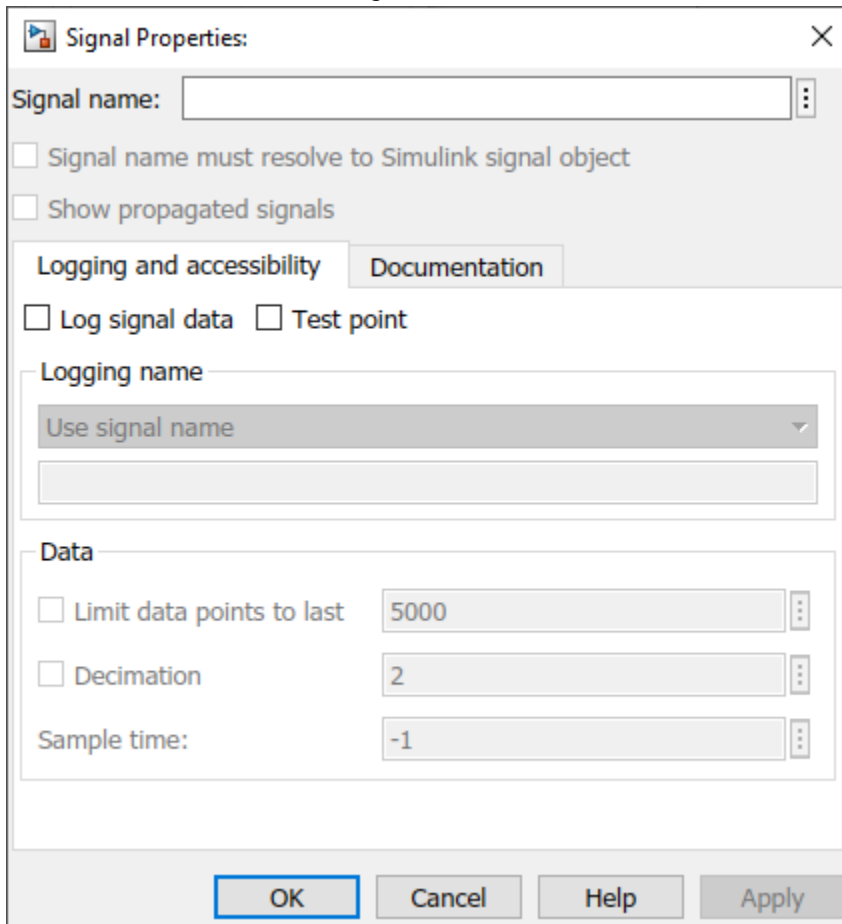

Open the Signal Properties

- Right-click a signal line in the model and select **Properties**.
- When you select a signal line in your model, the Signal Properties are available in the Property Inspector.

Parameters

Signal Name Properties

Signal name — Signal name

string | character vector

Specify a name for the signal as a character vector or string.

When you select **Signal name must resolve to Simulink signal object**, the name must match the name of a `Simulink.Signal` object in the base workspace, the model workspace, or a data dictionary. The signal name can implicitly resolve to a `Simulink.Signal` object when you do not select **Signal name must resolve to Simulink signal object**. For more information, see “Explicit and Implicit Symbol Resolution”.

Programmatic Use

To specify a signal name programmatically, use the `set_param` function to set the `Name` property for the line handle that corresponds to the signal. For an example, see “Name a Signal Programmatically”.

Signal name must resolve to Simulink signal object — Explicit signal name resolution

'off' (default) | 'on'

When enabled, the signal name specified in the Signal Properties dialog box must match the name of a `Simulink.Signal` object in the base workspace, the model workspace, or a data dictionary. When disabled, the signal name can implicitly resolve to a `Simulink.Signal` object. For more information, see “Explicit and Implicit Symbol Resolution”.

By default, signals that require resolution to a `Simulink.Signal` object are marked with the signal resolution icon to the left of the signal label. For more information, see “Signal to Object Resolution Indicator”.

Programmatic Use

To configure this option for a signal programmatically, use the `set_param` function to set the `MustResolveToSignalObject` property for the line handle that corresponds to the signal. For an example, see “Use Signal Objects”.

Show propagated signals — Option to display propagated signal name

'off' (default) | 'on'

When a downstream signal originates from a block that supports signal label propagation, you can enable this option on the downstream signal line to display the propagated signal name as a label on the signal line.

For example, the output signal from the Subsystem block is configured for signal label propagation. The propagated signal label `<const>` comes from the name of the upstream Constant block output signal `const`.

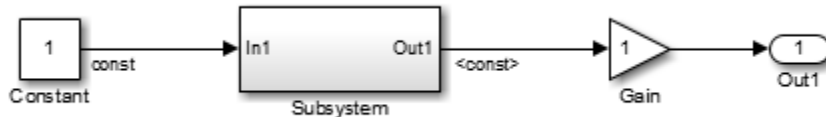

For more information see, “Signal Label Propagation”.

Tips

To display propagated signal labels for all signals, in the Simulink Editor, on the **Debug** tab, select **Information Overlays**, then select **Propagated Signal Labels**.

Programmatic Use

To configure a signal to display its propagated name programmatically, use the `set` function to specify the value of the `SignalPropagation` property for the line handle that corresponds to the signal. For an example, see “Display Propagated Signal Labels”.

Logging and Accessibility

Log signal data — Signal logging

'off' (default) | 'on'

Select this option to mark a signal for logging. When the **Signal logging** option in the model configuration parameters is enabled, data for signals marked for logging is sent to the workspace and the Simulation Data Inspector during simulation. For more information, see “Export Signal Data Using Signal Logging”.

Programmatic Use

You can control whether to log a signal programmatically using the `Simulink.sdi.markSignalForStreaming` function or by using the `set_param` function to configure the `DataLogging` property of the port handle that corresponds to the block output port that produces the signal.

Test point — Test point designation

'off' (default) | 'on'

When enabled, the signal is designated as a test point. For more information, see “Configure Signals as Test Points”.

Programmatic Use

To designate a signal as a test point programmatically, use the `set_param` function to specify the value of the `TestPoint` property for the port handle that corresponds to the block output port that produces the signal.

Logging Name — Name for logged signal data

'SignalName' (default) | 'Custom'

Specify a name for the logged signal data. By default, logged signal data uses the name of the signal specified in the model.

To specify a logging name for a signal that is different from the name of the signal in the model, select `Custom` and specify the logging name in the text box.

Programmatic Use

To specify the logging name programmatically, use the `set_param` function to configure the `DataLoggingNameMode` and `DataLoggingName` parameters for the port handle that corresponds to the block output port that produces the signal. For an example, see “Signal-Specific Logging Name Specified Programmatically”.

Limit data points to last — Option to log only last n data points

'off' (default) | 'on'

When you only want to save or analyze the data from the end of a simulation, you can configure logging to capture only the last n signal values. Select **Limit data points to last** and specify the number of data points you want to log.

When you only log the last simulation values, dashboard blocks and the Simulation Data Inspector do not display data during simulation. Consider data requirements for each signal before you reduce the number of data points logged in simulation.

For more information, see “Specify Signal Values to Log” and “Limit the Size of Logged Data”.

Programmatic Use

To configure this option programmatically, use the `set_param` function to specify the `DataLoggingLimitDataPoints` and `DataLoggingMaxPoints` parameters for the port handle that corresponds to the block output port that produces the signal.

Decimation — Option to log every n th data point

'off' (default) | 'on'

When you want to reduce the effective sample rate for logged data, select **Decimation** and specify the desired decimation factor in the text box. For example, if you specify a decimation factor of 2, every other signal value is logged.

Consider data requirements for each signal before reducing the number of data points logged in simulation. Decimation can cause aliasing if the effective sample rate is too low.

For more information, see “Specify Signal Values to Log” and “Limit the Size of Logged Data”.

Sample time — Logging sample time

-1 (default) | scalar

Specify the sample time to use for logging the data for the selected signal. By default, the logging sample time is inherited (-1) from the block that produces the signal. For continuous logging sample time, specify the value as 0. To use a discrete sample time for logging data, specify the sampling interval as a scalar.

Specifying a logging sample time may add a new sample time to the model. When you specify a logging sample time, the model calculates a value for the exact time hits. When you use a fixed-step solver, the logging sample time you specify must be a multiple of the base rate for the model.

Logging sample time is not supported for signals inside conditional subsystems or conditional referenced models.

Documentation

Description — Signal description

string | character vector

You can provide a description of the signal that shows in the **Info** tab of the Property Inspector when the signal is selected.

The description specified in the Signal Properties dialog box does not appear in generated code. To provide a signal description that becomes a comment in generated code, use a `Simulink.Signal` object.

Document Link — Link to documentation about signal

MATLAB expression

Specify a MATLAB expression that opens documentation for the signal. For example, you can call the `web` function to open an HTML file. When you specify a value for the **Document link** property, you can click the **Document link** field label to open the document.

Programmatic Use

To programmatically specify a document link, use the `set_param` property to specify the `DocumentLink` property of the port handle that corresponds to the block output port that produces the signal.

See Also

Functions

`set_param` | `Simulink.sdi.markSignalForStreaming` | `web`

Objects

`Simulink.Signal`

Simulink Configuration Parameters

Signal logging

Tools

Instrumentation Properties | **Simulation Data Inspector**

Topics

- “Signal Basics”
- “Display Signal Attributes”
- “Signal Label Propagation”
- “Export Signal Data Using Signal Logging”
- “Configure Signals as Test Points”
- “Specify Signal Values to Log”
- “Limit the Size of Logged Data”

Introduced before R2006a

Simulation Data Inspector

Inspect and compare data and simulation results to validate and iterate model designs

Description

The Simulation Data Inspector visualizes and compares multiple kinds of data.

Using the Simulation Data Inspector, you can inspect and compare time series data at multiple stages of your workflow. This example workflow shows how the Simulation Data Inspector supports all stages of the design cycle:

1 “View Data in the Simulation Data Inspector”.

Run a simulation in a model configured to log data to the Simulation Data Inspector, or import data from the workspace or a MAT-file. You can view and verify model input data or inspect logged simulation data while iteratively modifying your model diagram, parameter values, or model configuration.

2 “Inspect Simulation Data”.

Plot signals on multiple subplots, zoom in and out on specified plot axes, and use data cursors to understand and evaluate the data. “Create Plots Using the Simulation Data Inspector” to tell your story.

3 “Compare Simulation Data”

Compare individual signals or simulation runs and analyze your comparison results with relative, absolute, and time tolerances. The compare tools in the Simulation Data Inspector facilitate iterative design and allow you to highlight signals that do not meet your tolerance requirements. For more information about the comparison operation, see “How the Simulation Data Inspector Compares Data”.

4 “Save and Share Simulation Data Inspector Data and Views”.

Share your findings with others by saving Simulation Data Inspector data and views.

You can also harness the capabilities of the Simulation Data Inspector from the command line. For more information, see “Inspect and Compare Data Programmatically”.

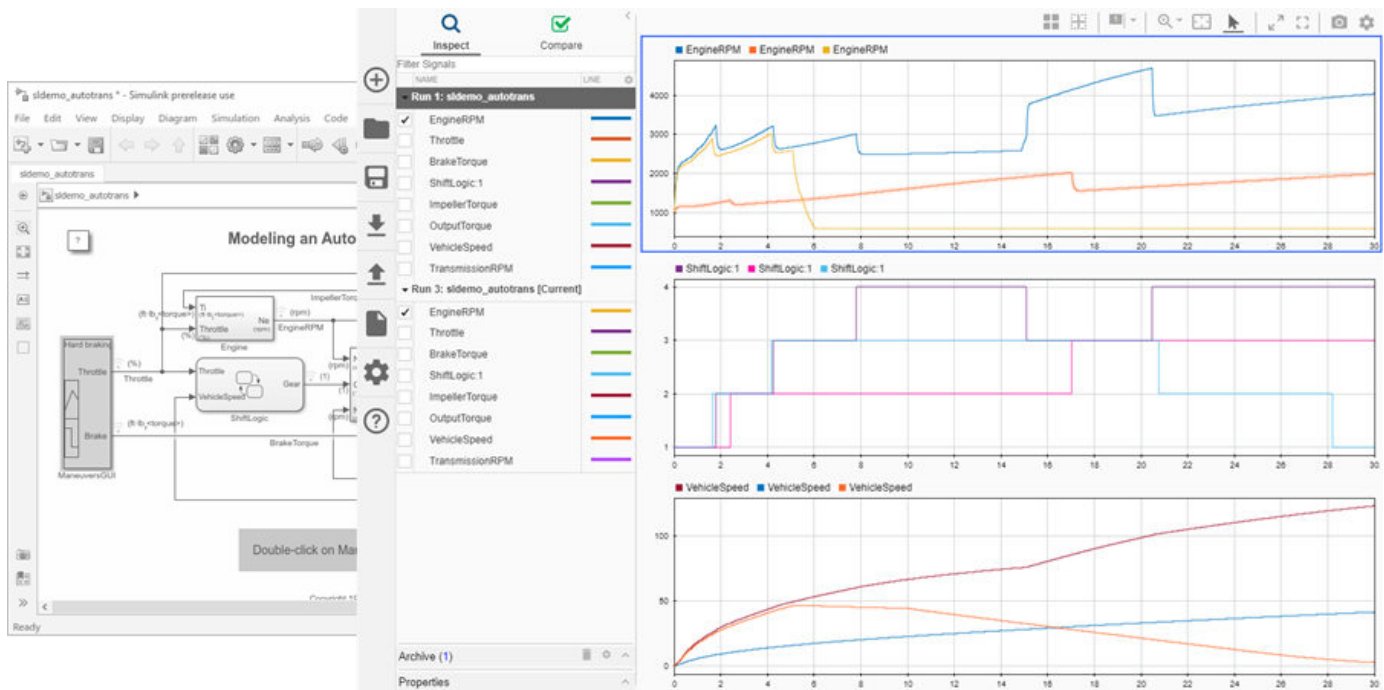

Open the Simulation Data Inspector

- Simulink Toolstrip: On the **Simulation** tab, under **Review Results**, click **Data Inspector**.
- Click the streaming badge on a signal to open the Simulation Data Inspector and plot the signal.
- MATLAB command prompt: Enter `Simulink.sdi.view`.

Examples

Apply a Tolerance to a Signal in Multiple Runs

You can use the Simulation Data Inspector programmatic interface to modify a parameter for the same signal in multiple runs. This example adds an absolute tolerance of 0.1 to a signal in all four runs of data.

First, clear the workspace and load the Simulation Data Inspector session with the data. The session includes logged data from four simulations of a Simulink® model of a longitudinal controller for an aircraft.

```
Simulink.sdi.clear
Simulink.sdi.load('AircraftExample.mldatx');
```

Use the `Simulink.sdi.getRunCount` function to get the number of runs in the Simulation Data Inspector. You can use this number as the index for a for loop that operates on each run.

```
count = Simulink.sdi.getRunCount;
```

Then, use a for loop to assign the absolute tolerance of 0.1 to the first signal in each run.

```
for a = 1:count
    runID = Simulink.sdi.getRunIDByIndex(a);
    aircraftRun = Simulink.sdi.getRun(runID);
    sig = getSignalByIndex(aircraftRun,1);
    sig.AbsTol = 0.1;
end
```

- “View Data in the Simulation Data Inspector”
- “Inspect Simulation Data”
- “Compare Simulation Data”
- “Iterate Model Design Using the Simulation Data Inspector”

Programmatic Use

`Simulink.sdi.view` opens the Simulation Data Inspector from the MATLAB command line.

See Also

Functions

`Simulink.sdi.clear` | `Simulink.sdi.clearPreferences` | `Simulink.sdi.snapshot`

Topics

“View Data in the Simulation Data Inspector”

“Inspect Simulation Data”

“Compare Simulation Data”

“Iterate Model Design Using the Simulation Data Inspector”

Introduced in R2010b

Simulink Editor

Create models and set model properties

Description

The Simulink Editor allows you to create and configure system models.

The Simulink Editor is a tool for building models. In addition to providing standard methods for working with diagrams in a vector graphics editor, the editor provides shortcuts that help you to add and connect blocks. The Simulink Editor also gives you access to the tools you need for technical operations such as importing data, simulating your model, and analyzing model performance.

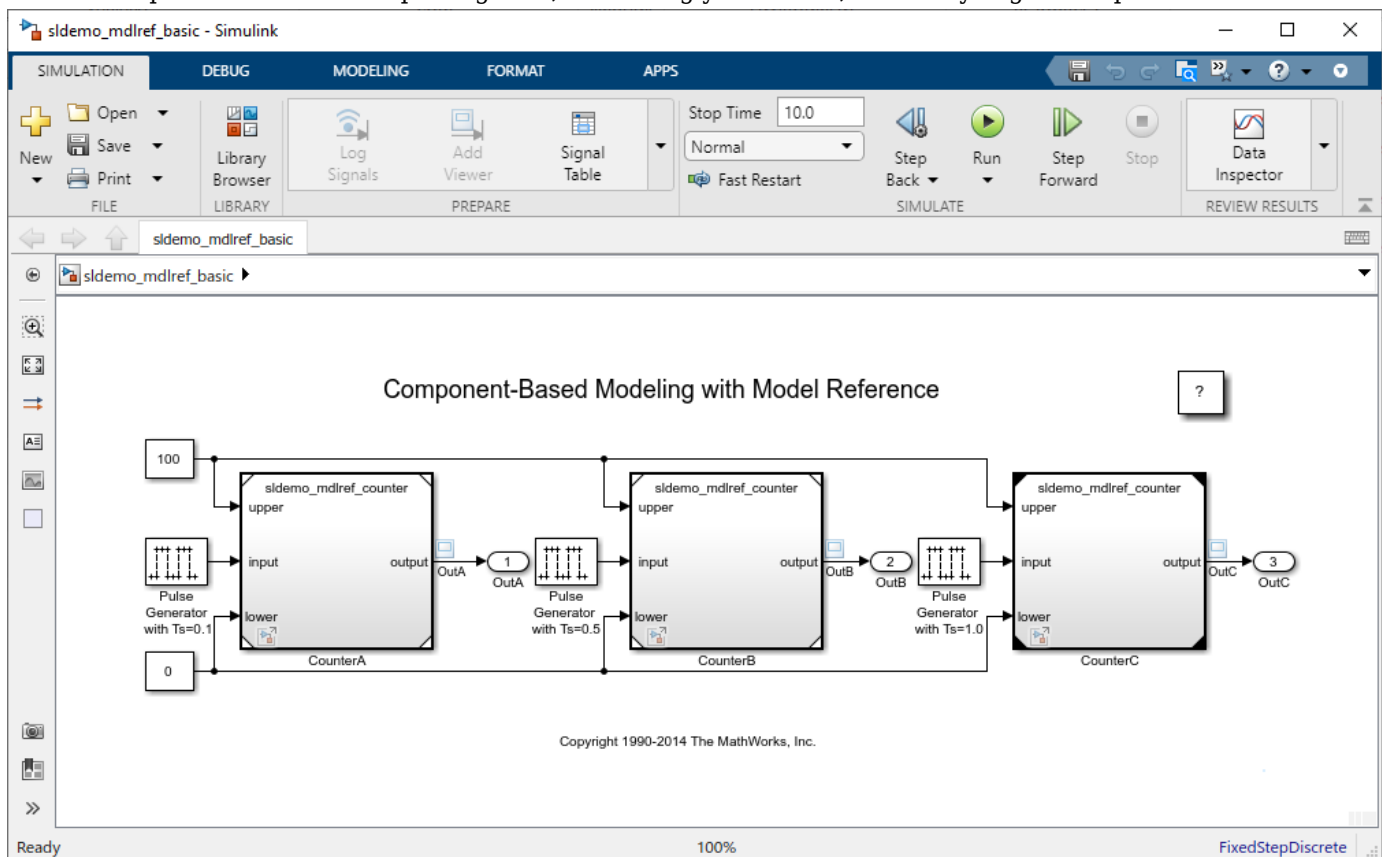

Open the Simulink Editor

- Create a model. On the MATLAB **Home** tab, click **Simulink** and choose a model template.

Alternatively, if you already have the Library Browser open, click the **New Model** button .

- Open an existing model. To open recent models, on the MATLAB **Home** tab, click **Simulink**.

Alternatively, if you know the name of the model you want to open, enter the name in the MATLAB Command Window, such as `vdp`.

Tip The first model that you open in a MATLAB session takes longer to open than subsequent models. By default, MATLAB does not start Simulink until you open the first model to reduce MATLAB startup time and avoid unnecessary system memory use.

To speed up opening the first model, you can configure MATLAB startup to also start Simulink. For more information on how to start Simulink without opening models or the Library Browser, see the `start_simulink` reference page.

Examples

Interactively Build Models

When you build a model in the Simulink Editor, you use common techniques for working with graphics objects.

Actions you can perform in the Simulink Editor include:

- Selecting using click, shift-click, and dragging
- Resizing objects using handles and moving objects by dragging
- Cutting, copying, and pasting
- Undoing and redoing up to 101 operations

Note After you undo or redo block parameter changes, a visual cue appears that shows the current values of the affected parameters. Some parameter changes are not affected by the undo or redo commands. After you undo or redo changes to block parameters, use the cue to see the parameters affected.

A small subset of parameters cannot be undone. Changing these parameters clears the undo history when you make the change in the Property Inspector or in the block dialog box.

You can also zoom and scroll the editing area. On the **Modeling** tab, select **Environment > Zoom**, and select the zoom or view you want to use. If you are using a supported touch display platform, you can pinch to zoom and swipe to scroll. The supported touch display devices include Microsoft Windows platforms with a Windows 7 certified or Windows 8 certified touch display and Macintosh platforms with an Apple Magic Trackpad.

The editor supports additional shortcuts for scrolling that are unique to Simulink. Shortcuts and other interactive model building techniques are summarized in “Keyboard Shortcuts and Mouse Actions for Simulink Modeling”. For a tutorial, see “Build and Edit a Model Interactively”.

Detect Model Design Errors

The Simulink Editor can provide you with visual cues for some model design issues. Highlighted blocks alert you to issues. To see a description of the issue, pause on a highlighted block and click the error or warning symbol.

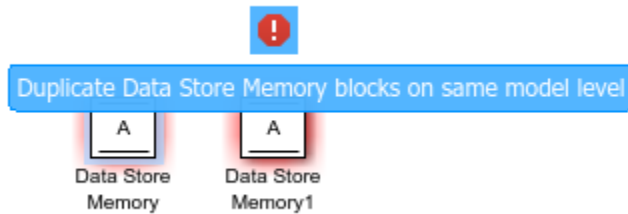

Similar to the Diagnostic Viewer, if an error or warning has a predefined fix, the notification dialog box lists actions and may include a **Fix** button to apply these changes.

Simulink can detect block errors and warnings, such as:

- Goto and From block mismatches.
- Duplicate data store blocks. The value of the Duplicate data store names parameter determines whether to display a warning or an error symbol.

The **Errors and Warnings** option is enabled by default. To turn off this option, in the **Debug** tab, select **Diagnostics > Edit-Time Errors & Warnings**.

Explore Model Hierarchy

Use the Model Browser to navigate a model hierarchy using a tree structure. The browser helps you to understand the organization of your model and explore systems within systems.

To display the Model Browser, in the Simulink Editor, in the **Modeling** tab, select **Environment > Model Browser**. You can toggle the Model Browser display by clicking the **Hide/Show Model Browser** control .

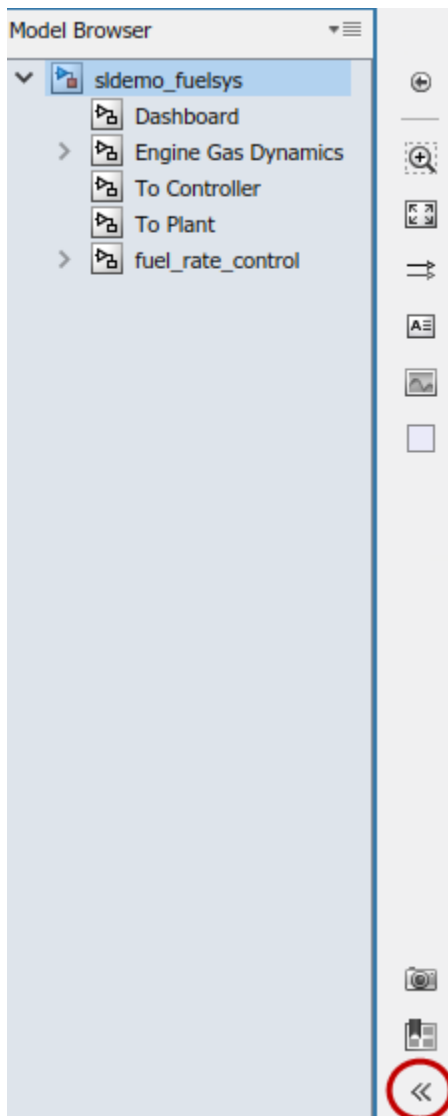

In the Model Browser, you can specify whether to display blocks that are linked to a library or to masked subsystems. Click  and select **Library Links** or **Systems with Mask Parameters**. For information on these types of blocks, see “Linked Blocks” and “Masking Fundamentals”.

Set Properties and Parameters

As you build a model, you can set parameters and properties on model elements. For example, you can set parameters and properties for blocks that affect how the block functions. You can also set properties on Stateflow charts, signal lines, visual elements such as annotations, and on the model.

Based on your workflow and goals, set parameters and properties using:

- The **Property Inspector**, which stays open in the editor as you work and updates based on the current selection

- A dialog box that is associated with an element, such as a specific block
- The **Model Data Editor**, which stays open and displays information about signals, states, and algorithmic block parameters (for instances, gains and filter coefficients) in a table

For blocks whose parameter value appears on the block icon, you can select the block, pause on the value, and edit the value directly. For more information, see “Set Block Parameters”.

- “Build and Edit a Model Interactively”

Parameters

Toolstrip — Access and discover Simulink capabilities

Simulation | **Debug** | **Modeling** | **Format** | **Apps**

To support common user workflow tasks, tabs called **Simulation**, **Debug**, **Modeling**, **Format**, and **Apps** provide functionality corresponding to each task.

The **Apps** tab provides a gallery of applications from the Simulink family of products. Apps may open a new contextual tab, a separate window, or they may be a shortcut to the configuration parameters.

After you open a gallery, you can mark buttons as favorites. Buttons that are favorites appear at the top of the gallery for quicker access. You can drag these buttons to reorder them.

When you select a model component, a contextual tab displays tools to assist you. For example, when you select a Subsystem block, the **Subsystem Block** tab appears. If you select a Stateflow chart, the **State Chart** tab appears. When the block or chart is no longer selected, the contextual tabs disappear.

The preferences folder saves the product-specific tabs that you have open for a model. Open tabs that require a license checkout do not persist after you close the model.

To add custom tabs to the Simulink Toolstrip, see “Create Custom Simulink Toolstrip Tabs”.

The quick access toolbar contains frequently used options such as save, undo, and redo. To customize the quick access toolbar, see “Access Frequently Used Features and Commands in Simulink”.

Commands also appear on context menus. Context menus appear when you right-click a model element or a blank area of the editor. For example, if you right-click a block, the menus display the commands relevant for working on blocks, such as clipboard and alignment operations. Some commands appear only on a context menu.

Palette — Access additional shortcuts along the left side of the editor

icons

The palette along the left side of the editor provides shortcuts to commands you can use to modify the model appearance and navigate the model. For example, the palette includes a shortcut for adding annotations and other visuals, like boxed-in areas for labeling the model. It also provides a zoom button for zooming on a particular part of the model.

Hide/Show Explorer Bar — Hide or display a bar that shows where you are in the model hierarchy

off (default) | on

The **Hide/Show Explorer Bar** button in the upper left corner of the editor window displays a bar that shows where you are in the model hierarchy.

Hide/Show Model Browser — Hide or display a hierarchical view of the model

off (default) | on

The **Hide/Show Model Browser** button displays the **Model Browser** pane. You can use this pane to view and navigate a hierarchical view of the model.

Show Perspectives Views — Enable code, requirements, and interface perspectives

off (default) | on

The icon in the lower-right corner opens additional views of the model. One such view is the interface view, which helps you to trace model interfaces. Click the control to see these views.

Model Data Access — Retrieve model data

off (default) | on

A badge in the lower-left corner indicates that a model has external data sources, such as a data dictionary, or that there is data in the model workspace. Click the badge, then use the menu to navigate to these data sources.

- To open the Model Explorer with the **Model Workspace** node selected, click the **Model Workspace** link.
- To open the Model Explorer with the **External Data** node for the model selected, click the **External Data** link.
- To add or change a linked data dictionary, click the gear icon to open the **External Data** tab of the Model Properties dialog box.

Programmatic Use

simulink opens the Simulink Start Page. Select a model or template to open the Simulink Editor.

See Also

Functions

simulink | start_simulink

Tools

Library Browser | **Model Explorer** | **Finder**

Topics

“Build and Edit a Model Interactively”

Introduced before R2006a

Simulink Onramp

Self-paced, interactive tutorial included with Simulink license

Description

Simulink Onramp is a self-paced, interactive tutorial that helps you get started with Simulink. It is included with a Simulink license.

After completing Simulink Onramp, you will be able to create, modify, and troubleshoot Simulink models that simulate dynamic systems and perform basic signal analysis.

To teach concepts incrementally, Simulink Onramp uses tasks. You receive automated assessments and feedback after submitting tasks. Your progress is saved when you exit the training, so you can complete the training in multiple sessions.

Using Simulink Onramp, you can explore:

- Simulink blocks and signals
- Signal value visualizations during simulation
- Math and logic operators for algorithms
- How to access help from documentation
- MATLAB variables and functions in Simulink
- Dynamic systems in Simulink
- Discrete-time systems
- Continuous-time systems
- Simulation duration

Simulink Onramp helps you practice what you learn with these projects:

- Automotive Performance Modes
- Modeling a Thermostat
- Peregrine Falcon Dive

The screenshot displays the Simulink Onramp training environment. On the left, the 'Training - Tasks' window shows 'Task 1' with instructions: 'Connect the signal line labeled velocity to the Signal Assessment block. The line will change from dashed, red to solid, black when connected.' Below the instructions are buttons for 'Hint', 'See Solution', 'Reset', 'Submit', and 'Next task'. The main window shows a Simulink model for a falling object with air drag. The model includes a 'Gravitational force' block (9.81*1), a summing junction, a '1/mass' gain block, an 'Integrator' block (1/s), and a 'Signal Assessment' block. The equation $\Sigma F = ma$ and $-mg + \alpha v^2 = ma$ is shown. The output is 'velocity'. On the right, the 'Training - Assessment' window shows 'Task 1 Signal' with a plot of 'Value' vs 'Time'. The plot shows a blue curve ('My signal') starting at 0 and decaying towards a value of approximately -15. A legend indicates 'Signal requirement' (orange line) and 'My signal' (blue line). Below the plot, a 'Requirements' section shows a green checkmark and the text 'Does the connected signal meet the requirement?'.

Open the Simulink Onramp

- On the Simulink Start Page, click the **Simulink Onramp** button  **Simulink Onramp**.
- On the Simulink Toolstrip quick access toolbar, click **Help > Learn Simulink**.
- In the MATLAB Command Window, enter `learning.simulink.launchOnramp('simulink')`.

See Also

Topics

“Simulink Block Diagrams”

“Create a Simple Model”

“Explore Model Hierarchy”

“Model-Based Design with Simulink”

“Build and Edit a Model Interactively”

“Simulink Models” on page 11-6

Introduced in R2019a

Simulink Profiler

Identify sources of simulation slowdowns

Description

Use the **Simulink Profiler** to examine model and block execution and identify issues that can contribute to poor simulation performance.

The screenshot displays the Simulink Profiler interface. The main window shows a control model titled "Anti-Windup PID Control Example". The model consists of a reference input $r(t)$ entering a summing junction, followed by a PID controller block, a saturation block labeled "Plant Actuator" with input $u(t)$ and output $SAT(u)$, a first-order process block with transfer function $\frac{1}{10s + 1}$, a dead time block, and a scope block labeled "yout".

The Profiler Report pane at the bottom shows the following data:

| Path | Time Plot (Dark Band = Self Time) | Total Time (s) | Self Time (s) | Number of Calls |
|-------------------|-----------------------------------|----------------|---------------|-----------------|
| sldemo_antiwindup | [Bar chart] | 4.247 | 1.198 | 18013 |
| Scope | [Bar chart] | 2.398 | 2.398 | 6004 |
| Scope1 | [Bar chart] | 0.642 | 0.642 | 6004 |
| PID Controller | [Bar chart] | 0.004 | 0.000 | 0 |
| Filter | [Bar chart] | 0.001 | 0.000 | 0 |
| Integrator | [Bar chart] | 0.001 | 0.000 | 0 |
| D Gain | [Bar chart] | 0.000 | 0.000 | 0 |
| I Gain | [Bar chart] | 0.000 | 0.000 | 0 |
| N Gain | [Bar chart] | 0.000 | 0.000 | 0 |

A tooltip for the Integrator block shows: Self Time (dark band): 0.000, Total Time: 0.001.

The Property Inspector pane on the right shows the Simulink Profiler details:

Detail: sldemo_antiwindup
Total Time Breakdown for sldemo_antiwindup:
 4.247 s (Total Time) = 1.198 s (Self Time) + 3.049 s (Total Time of children)
 Note: Model hierarchy view does not include compile time
Self Time Breakdown for sldemo_antiwindup:

| Exec Node | Time (s) | Calls |
|----------------------|----------|-------|
| simulationPhase | 0.767 | 1 |
| initializationPhase | 0.338 | 1 |
| terminationPhase | 0.034 | 1 |
| sldemo_antiwindup... | 0.019 | 1 |
| sldemo_antiwindup... | 0.014 | 1 |
| solverPhase | 0.007 | 2000 |
| sldemo_antiwindup... | 0.006 | 2001 |
| simulate(sldemo_a... | 0.004 | 1 |
| sldemo_antiwindup... | 0.003 | 4000 |
| ode3.Integrate | 0.002 | 2000 |
| sldemo_antiwindup... | 0.002 | 1 |
| sldemo_antiwindup... | 0.001 | 5999 |
| sldemo_antiwindup... | 0.001 | 2001 |
| sldemo_antiwindup... | 0.001 | 1 |
| sldemo_antiwindup... | 0.000 | 1 |
| reset | 0.000 | 1 |
| sldemo_antiwindup... | 0.000 | 1 |
| sldemo_antiwindup... | 0.000 | 1 |

Open the Simulink Profiler

- 1 Open a model.
- 2 On the **Debug** tab, select **Performance Advisor > Simulink Profiler**.
- 3 On the **Profile** tab, click **Profile**.

When simulation is complete, the **Profiler Report** pane opens and displays the simulation profile for the model. You can share the results of the Profiling Run by exporting the report to HTML, as well as by saving the profiling data to a MAT file.

The screenshot displays the Simulink Profiler interface for a model named 'sldemo_antiwindup'. The main workspace shows a block diagram titled 'Anti-Windup PID Control Example'. The diagram includes a reference input $r(t)$, a summing junction, a PID controller block, a saturation block 'SAT(u)', a 'Plant Actuator' block, a 'First Order Process' block with transfer function $\frac{1}{10s + 1}$, a 'Dead Time' block, and an output $y(t)$ labeled 'yout'. The status bar at the bottom indicates 'Ready' and '148%' zoom.

The Profiler Report (sldemo_antiwindup @ 21-Dec-2020 12:39:31) is shown below the model. It includes a search bar and a table with the following columns: Path, Time Plot (Dark Band = Self Time), Total Time (s), Self Time (s), and Number of Calls.

| Path | Time Plot (Dark Band = Self Time) | Total Time (s) | Self Time (s) | Number of Calls |
|-------------------|-----------------------------------|----------------|---------------|-----------------|
| sldemo_antiwindup | [Bar] | 4.247 | 1.198 | 18013 |
| Scope | [Bar] | 2.398 | 2.398 | 6004 |
| Scope1 | [Bar] | 0.642 | 0.642 | 6004 |
| PID Controller | [Bar] | 0.004 | 0.000 | 0 |
| Filter | [Bar] | 0.001 | 0.000 | 0 |
| Integrator | [Bar] | 0.001 | 0.000 | 0 |
| D Gain | [Bar] | 0.000 | 0.000 | 0 |
| I Gain | [Bar] | 0.000 | 0.000 | 0 |
| N Gain | [Bar] | 0.000 | 0.000 | 0 |

A tooltip for the 'I Gain' block shows: Self Time (dark band): 0.000, Total Time: 0.001.

The Property Inspector on the right shows the Simulink Profiler details for 'sldemo_antiwindup':

Simulink Profiler
 Detail: sldemo_antiwindup
Total Time Breakdown for sldemo_antiwindup:
 4.247 s (Total Time) = 1.198 s (Self Time) + 3.049 s (Total Time of children)
 Note: Model hierarchy view does not include compile time
Self Time Breakdown for sldemo_antiwindup:

| Exec Node | Time (s) | Calls |
|----------------------|----------|-------|
| simulationPhase | 0.767 | 1 |
| initializationPhase | 0.338 | 1 |
| terminationPhase | 0.034 | 1 |
| sldemo_antiwindup... | 0.019 | 1 |
| sldemo_antiwindup... | 0.014 | 1 |
| solverPhase | 0.007 | 2000 |
| sldemo_antiwindup... | 0.006 | 2001 |
| simulate(sldemo_a... | 0.004 | 1 |
| sldemo_antiwindup... | 0.003 | 4000 |
| ode3.Integrate | 0.002 | 2000 |
| sldemo_antiwindup... | 0.002 | 1 |
| sldemo_antiwindup... | 0.001 | 5999 |
| sldemo_antiwindup... | 0.001 | 2001 |
| sldemo_antiwindup... | 0.001 | 1 |
| sldemo_antiwindup... | 0.000 | 1 |
| reset | 0.000 | 1 |
| sldemo_antiwindup... | 0.000 | 1 |
| sldemo_antiwindup... | 0.000 | 1 |

Examples

Identify Performance Slowdowns Using the Simulink Profiler

This example shows how to use the Simulink Profiler to track down the source of a simulation slowdown in your model.

This example uses a modified version of the sldemo_fuel_sys_dd model, (the Modeling a Fault-Tolerant Fuel Control System example) model with a slowdown artificially inserted.

Fault-Tolerant Fuel Control System

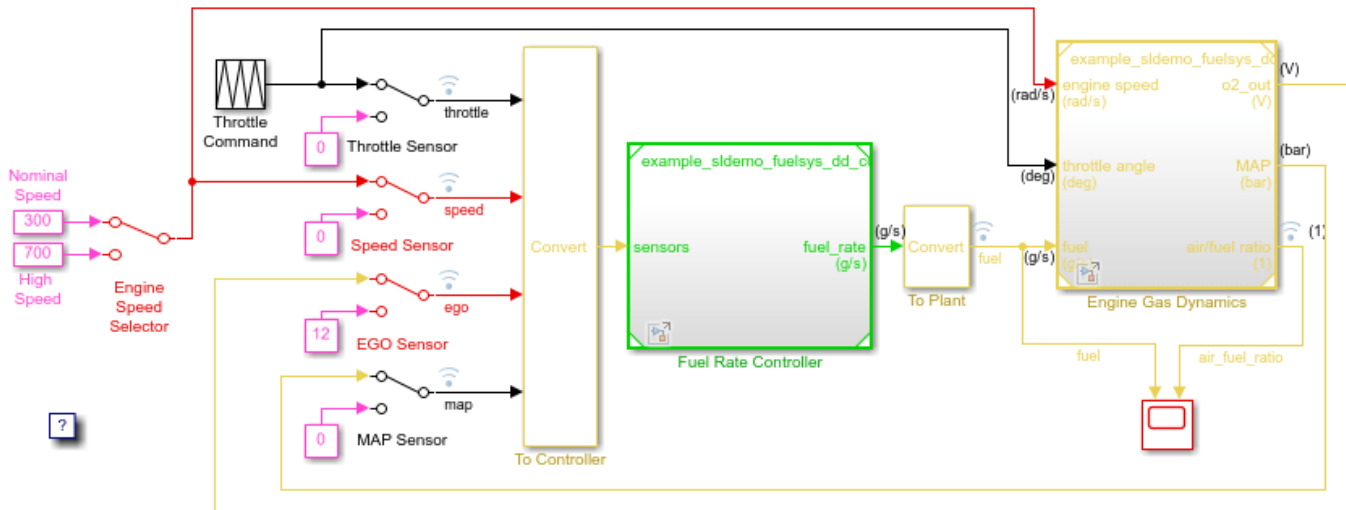

The sensor switches simulate any combination of sensor failures.
The Engine Speed Selector switch simulates different engine speeds (rad/s).

Copyright 1990-2017 The MathWorks, Inc.

Open the profiler for your model from the **Debug** tab by selecting **Performance Advisor > Simulink Profiler**.

The screenshot displays the Simulink Profiler interface for a model named "profiling_example_fuelcontrol_model". The main workspace shows a block diagram titled "Fault-Tolerant Fuel Control System". The diagram includes a "Fuel Rate Controller" block (example_slidemo_fuelsys_dd_c) and an "Engine Gas Dynamics" block (example_slidemo_fuelsys_d). The controller receives inputs from a "Throttle Command" block and various sensors (Throttle Sensor, Speed Sensor, EGO Sensor, MAP Sensor) through a "Convert" block. The engine dynamics block receives "fuel" and "air_fuel_ratio" inputs and outputs "throttle angle", "engine speed", "c2_out", and "MAP".

Below the diagram, a text box states: "The sensor switches simulate any combination of sensor failures. The Engine Speed Selector switch simulates different engine speeds (rad/s)." Copyright 1990-2017 The MathWorks, Inc.

The Profiler Report pane at the bottom shows "Run: No data" and a table with the following columns: Path, Time Plot (Dark Band = Self Time), Total Time (s), Self Time (s), and Number of Calls. The table is currently empty, with a message "Click profile to generate data".

The status bar at the bottom indicates "Ready", "81%", and "FixedStepAuto".

Click **Profile** to profile the model. When simulation completes, the Profiler Report pane opens.

Observe that the Engine Gas Dynamics block takes a large portion of the total profiling time (177.759s out of 231.443s) of the top model. This is a useful place to start looking for the problematic block in the model.

Fault-Tolerant Fuel Control System

The diagram shows a control system with inputs: Throttle Command (deg), Speed Sensor (rad/s), EGO Sensor (V), and MAP Sensor (bar). These feed into a 'Fuel Rate Controller' block. The controller outputs 'fuel_rate (g/s)', which is converted to 'fuel (g/s)' and sent to the 'Engine' block. The engine outputs 'throttle and speed (deg)' and 'engine speed (rad/s)'. There are also 'To Controller' and 'To Plant' conversion blocks.

Profiler Report (profiling_example_fuelcontrol_model @ 21-Dec-2020 13:13:27)

| Path | Time Plot (Dark Band = Self Time) | Total Time (s) | Self Time (s) | Number of Calls |
|-------------------------------------|-----------------------------------|----------------|---------------|-----------------|
| profiling_example_fuelcontrol_model | [Bar] | 198.379 | 16.524 | 9000015 |
| Engine Gas Dynamics | [Bar] | 160.690 | 7.286 | 8000014 |
| Throttle Command | [Bar] | 12.096 | 0.000 | 0 |
| To Controller | [Bar] | 2.553 | 0.000 | 0 |
| Scope | [Bar] | 2.194 | 2.194 | 1000004 |
| EGO Sensor | [Bar] | 1.058 | 1.058 | 2000009 |
| MAP Sensor | [Bar] | 0.930 | 0.930 | 4000009 |

Property Inspector: Simulink Profiler

Detail: Engine Gas Dynamics

Total Time Breakdown for Engine Gas Dynamics:
 160.690 s (Total Time) = 7.286 s (Self Time) + 153.404 s (Total Time of children)

Note: Model hierarchy view does not include compile time

Self Time Breakdown for Engine Gas Dynamics:

| Exec Node | Time (s) | Calls |
|-----------------|----------|---------|
| ModelReferen... | 2.825 | 2000000 |
| ModelReferen... | 1.801 | 1000001 |
| ModelReferen... | 1.368 | 1000001 |
| ModelReferen... | 1.065 | 2999999 |
| ToAsyncQueu... | 0.223 | 1000001 |
| ModelReferen... | 0.002 | 1 |
| ModelReferen... | 0.001 | 1 |
| ModelReferen... | 0.001 | 1 |
| ModelReferen... | 0.001 | 1 |
| ToAsyncQueu... | 0.000 | 1 |
| ModelReferen... | 0.000 | 1 |
| ModelReferen... | 0.000 | 1 |
| ModelReferen... | 0.000 | 1 |
| ToAsyncQueu... | 0.000 | 1 |
| ModelReferen... | 0.000 | 1 |
| ToAsyncQueu... | 0.000 | 1 |
| ModelReferen... | 0.000 | 1 |
| ToAsyncQueu... | 0.000 | 1 |

Recursively expand the block hierarchy view. By default, the profiler sorts the blocks at the same level of the model in descending order of **Total Time(s)**.

Fault-Tolerant Fuel Control System

The sensor switches simulate any combination of sensor failures. The Engine Speed Selector switch simulates different engine speeds (rad/s).

Copyright 1990-2017 The MathWorks, Inc.

Profiler Report (profiling_example_fuelcontrol_model @ 21-Dec-2020 13:13:27)

| Path | Time Plot (Dark Band = Self Time) | Total Time (s) | Self Time (s) | Number of Calls |
|-------------------------------------|-----------------------------------|----------------|---------------|-----------------|
| profiling_example_fuelcontrol_model | | 198.379 | 16.524 | 9000015 |
| Engine Gas Dynamics | | 160.690 | 7.286 | 8000014 |
| Mixing & Combustion | | 127.246 | 0.000 | 0 |
| EGO Sensor | | 124.698 | 0.371 | 1000006 |
| For Iterator Subsystem | | 122.215 | 55.689 | 1000004 |
| In1 | | 66.526 | 66.526 | 500000501 |
| For Iterator | | 0.000 | 0.000 | 1 |

Simulink Profiler

Detail: Engine Gas Dynamics

Total Time Breakdown for Engine Gas Dynamics:
160.690 s (Total Time) = 7.286 s (Self Time) + 153.404 s (Total Time of children)

Note: Model hierarchy view does not include compile time

Self Time Breakdown for Engine Gas Dynamics:

| Exec Node | Time (s) | Calls |
|-----------------|----------|---------|
| ModelReferen... | 2.825 | 2000000 |
| ModelReferen... | 1.801 | 1000001 |
| ModelReferen... | 1.368 | 1000001 |
| ModelReferen... | 1.065 | 2999999 |
| ToAsyncQueu... | 0.223 | 1000001 |
| ModelReferen... | 0.002 | 1 |
| ModelReferen... | 0.001 | 1 |
| ModelReferen... | 0.001 | 1 |
| ModelReferen... | 0.001 | 1 |
| ToAsyncQueu... | 0.000 | 1 |
| ModelReferen... | 0.000 | 1 |
| ModelReferen... | 0.000 | 1 |
| ModelReferen... | 0.000 | 1 |
| ToAsyncQueu... | 0.000 | 1 |
| ModelReferen... | 0.000 | 1 |
| ToAsyncQueu... | 0.000 | 1 |
| ModelReferen... | 0.000 | 1 |
| ToAsyncQueu... | 0.000 | 1 |

Observe that the For Iterator subsystem accounts for approximately 98% of the execution time of the EGO Sensor subsystem. It is highly probable that this is the source of the slow performance of the model.

The screenshot displays the Simulink Profiler interface. The main workspace shows a block diagram with a 'For Iterator' block and a 'double (V)' block. The Profiler Report (profiling_example_fuelcontrol_model @ 21-Dec-2020 13:13:27) is visible at the bottom, showing a table of performance metrics for various blocks.

| Path | Time Plot (Dark Band = Self Time) | Total Time (s) | Self Time (s) | Number of Calls |
|------------------------|-----------------------------------|----------------|---------------|-----------------|
| EGO Sensor | [Time Plot] | 124.698 | 0.371 | 1000006 |
| For Iterator Subsystem | [Time Plot] | 122.215 | 55.689 | 1000004 |
| In1 | [Time Plot] | 66.526 | 66.526 | 50000501 |
| For Iterator | [Time Plot] | 0.000 | 0.000 | 1 |
| EGO Sensor | [Time Plot] | 2.111 | 2.111 | 2000013 |
| System Lag | [Time Plot] | 1.747 | 0.000 | 0 |
| Product | [Time Plot] | 0.544 | 0.544 | 3000005 |

The Property Inspector on the right shows the Simulink Profiler details for 'In1':

Total Time Breakdown for In1:
66.526 s (Total Time) = 66.526 s (Self Time) + 0.000 s (Total Time of children)

Self Time Breakdown for In1:

| Exec Node | Time (s) | Calls |
|------------------|----------|-----------|
| Inport.Output... | 66.526 | 500000... |
| Inport.Cleanu... | 0.000 | 1 |

Delete the block, reconnect the broken signal, and profile the model again. You should see significantly faster simulation times.

To compare the results between the two runs, click **Add Report Panel** and select the previous run from the **Run** list.

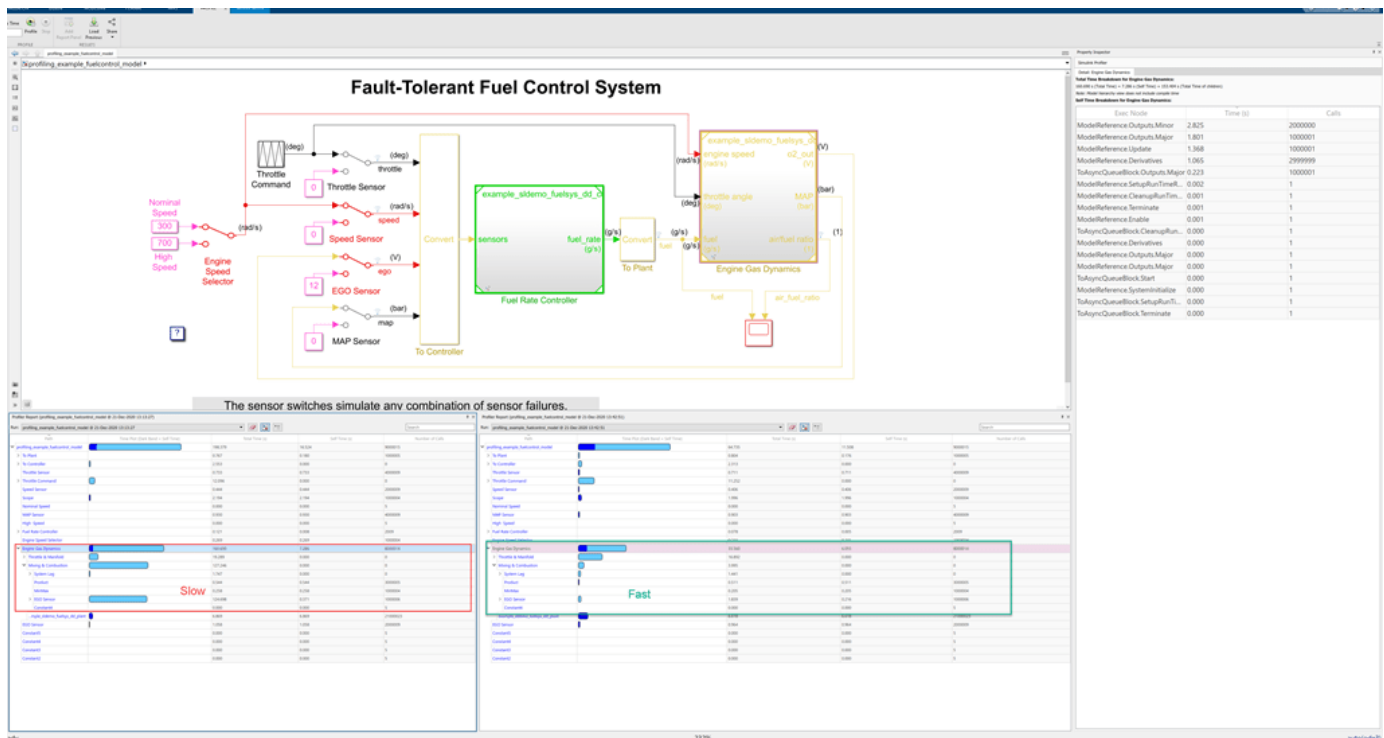

You can share the results of a selected run as an HTML report or as a MAT file. To share the profiler report, from the **Share** menu, select **Generate Report** for an HTML report or **Export** to save the results in a MAT file. The profiling results are exported to the current working folder in MATLAB™.

To view the generated report, you can open it in a supported web browser or use the built-in browser by passing the file path to the web command. If you have MATLAB Report Generator™ installed, you can also use rptview to view the report.

The screenshot shows the Simulink Profiler interface. On the left, a table lists the execution stack with columns for Path, Total Time (s), Self Time (s), and Number of Calls. The main window displays a report titled 'Simulink Profiler Report for profiling_example_fuelcontrol_model' with a summary and an execution stack table.

| Path | Total Time (s) | Self Time (s) | Number of Calls |
|--|----------------|---------------|-----------------|
| ---simulate(profiling_example_fuelcontrol_model) | 46.200003 | 0.004166 | 1 |
| ---compilePhase | 28.807228 | 28.807228 | 1 |
| ---simulationPhase | 16.334963 | 2.178103 | 1 |
| -----profiling_example_fuelcontrol_model.Outputs.Major | 11.032283 | 0.115601 | 74108 |
| -----ModelReference.Outputs.Major | 9.973248 | 0.140053 | 74108 |
| -----example_sldemo_fuelsys_dd_plant.Outputs.Major | 9.833195 | 0.040779 | 74108 |
| -----RootSubSystem.Outputs.Major | 9.775145 | 0.080781 | 74108 |
| -----AtomicSubSystem.Outputs.Major | 9.164628 | 0.024024 | 74108 |
| -----ForIteratorSubSystem.Outputs.Major | 9.008826 | 3.965829 | 74108 |
| -----Inport.Outputs.Major | 5.042998 | 5.042998 | 37054000 |
| -----AtomicMATLABFunctionSubSystem.Outputs.Major | 0.131777 | 0.023741 | 74108 |
| -----StateflowChild.Outputs.Major | 0.108036 | 0.108036 | 74108 |
| -----Switch.Outputs.Major | 0.097714 | 0.097714 | 74108 |
| -----AtomicMATLABFunctionSubSystem.Outputs.Major | 0.086943 | 0.016695 | 74108 |
| -----StateflowChild.Outputs.Major | 0.070248 | 0.070248 | 74108 |

See Also

“Understanding Total Time and Self Time in Profiler Reports”

See Also

Simulink.profiler.Data

Topics

“Understanding Total Time and Self Time in Profiler Reports”

“How Profiler Captures Performance Data”

Introduced in R2007b

Solver Profiler

Identify solver performance bottlenecks

Description

Use the **Solver Profiler** to examine solver and model behavior to identify issues that can contribute to poor simulation performance.

Use the **Solver Profiler** to analyze a model for patterns that affect its simulation. The **Solver Profiler** presents graphical and statistical information about the simulation, solver settings, events, and errors. You can use this data to identify locations in the model that caused simulation bottlenecks.

In addition, there are multiple factors that can limit the simulation speed. The Solver Profiler logs and reports all the major events that occur when simulating a model:

- Zero-crossing events
- Solver exception events
- Solver reset events
- Jacobian computation events

These events are common and necessary for an accurate simulation. However, they do incur computational cost and frequent occurrences can slow down or even stall the simulation.

Available actions

- **Trace**
- **Filter**
- **Explore**

Information Panes

- **Statistics**
- **Step Size**
- **Suggestions**

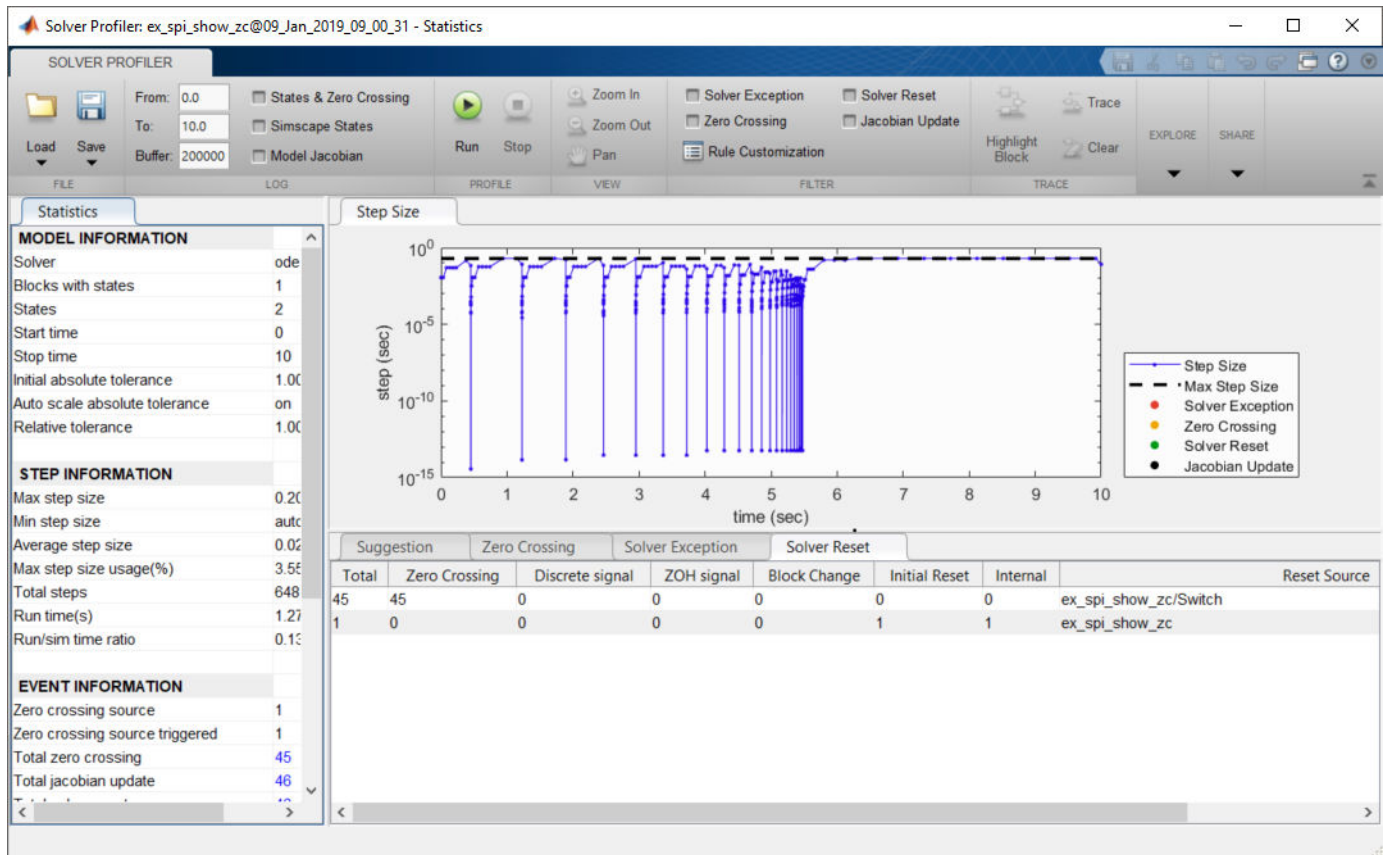

Open the Solver Profiler

Open the Solver Profiler by clicking the hyperlink in the lower-right corner of the Simulink Editor.

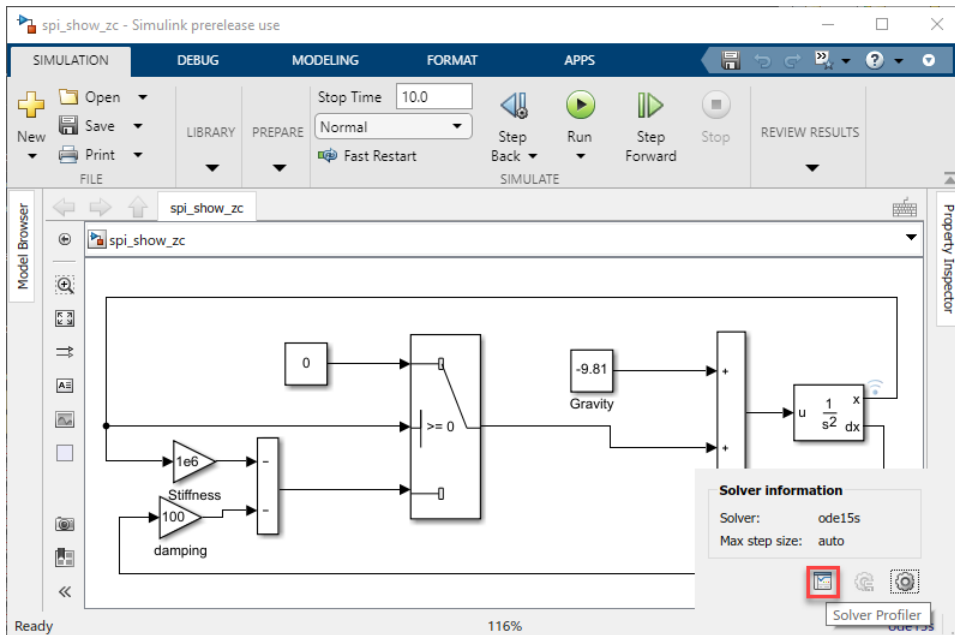

Examples

Locate source blocks for solver events

This example shows how to find the source of a particular solver event using a model that simulates a ball bouncing off the ground. As the ball comes to rest, the density of zero-crossings increase, leading to a solver slowdown.

To begin, open the `ex_spi_show_zc` model and launch the Solver Profiler.

Click **Run** to profile the model.

Notice that the model has 45 zero-crossing events, Select the **Zero Crossing** tab in the Results pane.

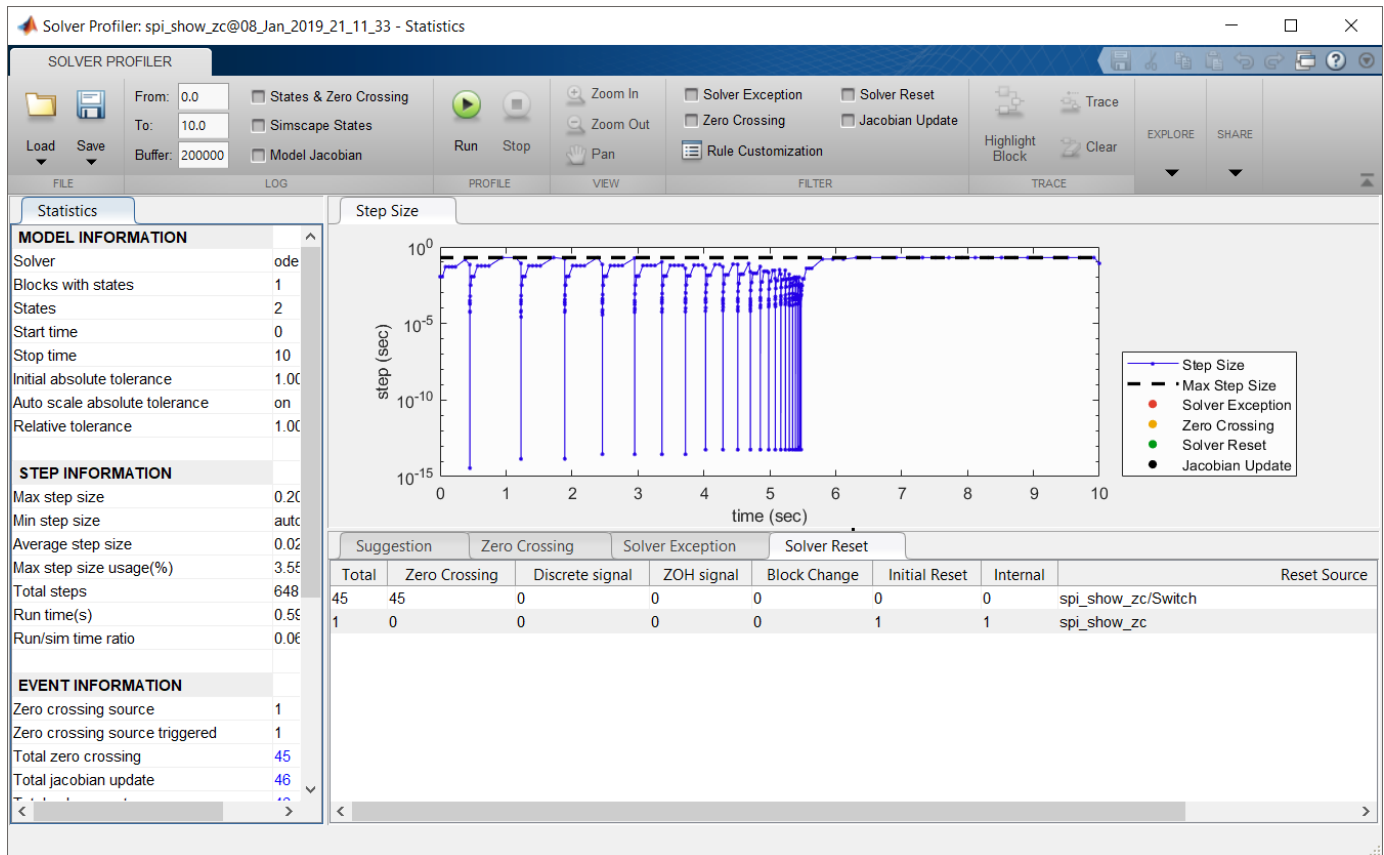

Select the `ex_spi_show_zc/Switch` field in the Results pane. All zero crossing events caused by the Switch block are highlighted in the **Step Size** plot.

In the **Trace** section of the toolbar, select **Highlight Block**.

You should see the Switch block causing the zero crossing events.

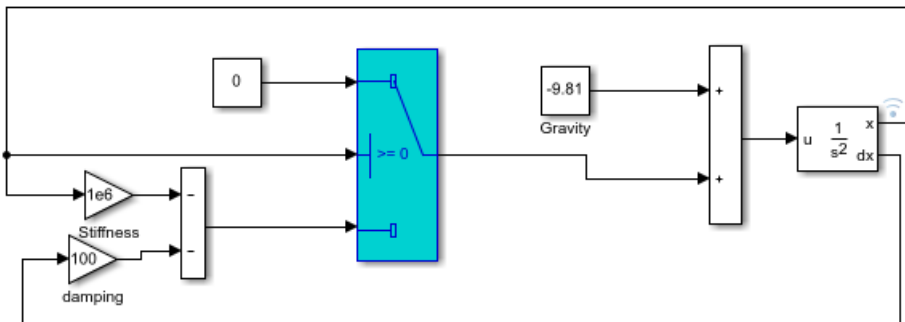

- “Examine Model Dynamics Using Solver Profiler”
- “Solver Resets”
- “Zero-Crossing Events”
- “Solver Exception Events”

- “Jacobian Logging and Analysis”

Parameters

Configure

Continuous States — Save model states to file

off (default) | on

By default, the profiler does not save the states of the model. Enabling this parameter configures the profiler to save the states to the profiler data MAT file.

Simscape States — Save Simscape states to file

off (default) | on

Enable this parameter to save Simscape states to the profiler data MAT file.

Zero Crossing — Save zero crossing data to file

off (default) | on

Enable this parameter to save zero crossing information to the profiler data MAT file

Model Jacobian — Save model Jacobian

off (default) | on

Option to log the solver Jacobian matrices to memory. This option is useful for simulations that use implicit solvers. For a comparison of solvers, see “Compare Solvers”.

For a more detailed explanation of the solver Jacobian, see “Choose a Jacobian Method for an Implicit Solver”.

Simscape Stiffness — Log stiffness analysis of Simscape states

off (default) | on

Enable this parameter to log the stiffness analysis of Simscape states to the profiler data MAT file. For more information on Simscape representation of stiffness and other physical system concepts, see “How Simscape Models Represent Physical Systems” (Simscape)

From — Profiler start time

model start time (default) | scalar

Time, in seconds, of the simulation that the profiler starts analyzing the model. This is not the same as the start time of the simulation.

To — Profiler stop time

model stop time (default) | scalar

Time, in seconds, of the simulation to which the profiler should profile the model. By default, the analysis continues until the end of the simulation. Changing this parameter does not change the stop time of the model which you specify in the Model Configuration Parameters.

A value less than the configured stop time of the model stops the profiling and simulation at `StopTime`.

Buffer – Memory impact of logging

50000 (default) | positive scalar

Maximum number of events that are logged. If the number of logged events reaches this value and memory is available, increase `BufferSize`. If memory is limited, consider lowering the value.

Filter**Solver Exception – Show solver exception events**

off (default) | on

Enable this parameter to highlight solver exception events in the Step Size plot of the Solver Profiler.

Solver Reset – Show solver reset events

off (default) | on

Enable this parameter to highlight solver reset events in the Step Size plot of the Solver Profiler.

Zero Crossing – Show zero crossing events

off (default) | on

Enable this parameter to highlight zero crossing events in the Step Size plot of the Solver Profiler.

Jacobian Update – Show Jacobian update events

off (default) | on

Enable this parameter to highlight Jacobian update events in the Step Size plot of the Solver Profiler.

Rule Customization – Change thresholds for profiler rules

off (default) | on

Click **Rule Customization** in the Solver Profiler to access the rule set. You can change the thresholds for most of these rules and also select which rules you want to apply selectively during a simulation run.

To modify a rule, enable its customization and then enter a desired threshold value.

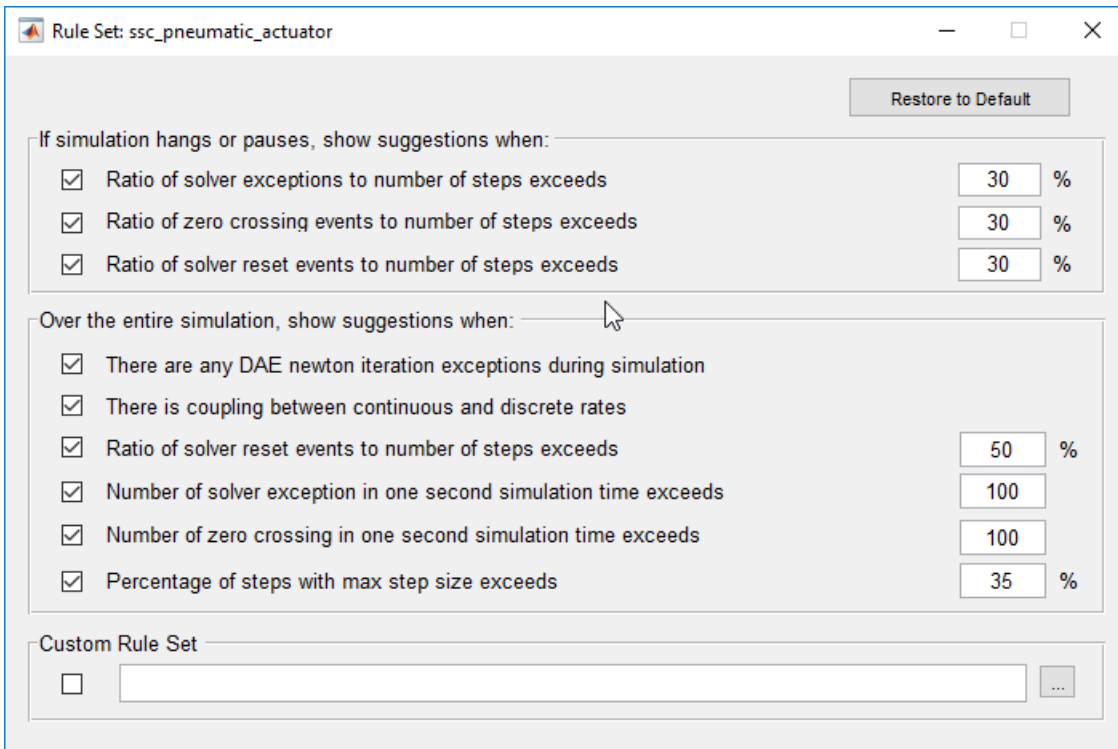

Custom Rule Set

You can override the settings on the **Rule Set** dialog box by specifying a custom rule set.

Create a rule set as a MATLAB script and specify the path to the script in the **Custom Rule Set** section of the **Rule Set** dialog box.

A simple rule set example looks as follows:

```
function diagnosticsString = customRule(profilerData)
    if isempty(profilerData.zcEvents)
        diagnosticsString{1} = 'No zero crossing event detected.';
    else
        diagnosticsString{1} = 'Zero-crossing events detected.';
    end
end
```

The input to the function is an array of structures called `profilerData`. This array of structures organizes all the information that the Solver Profiler collects during a profiling run. It contains the following substructures.

| Substructure | Fields |
|--|--|
| <code>stateInfo</code> : Stores information on block states | <ul style="list-style-type: none"> <code>name</code>: Block name <code>value</code>: State values <code>blockIdx</code>: Block ID |
| <code>blockInfo</code> : Cross-reference of blocks and state IDs | <ul style="list-style-type: none"> <code>name</code>: Block name <code>stateIdx</code>: State ID |

| Substructure | Fields |
|---|---|
| zcSrcInfo: Stores information on blocks causing zero crossing events | <ul style="list-style-type: none"> • name: Block name • blockIdx: Block ID |
| zcEvents: Cross-reference of the time stamps of zero crossing events and the corresponding state IDs | <ul style="list-style-type: none"> • t: Event timestamp • srcIdx: Block ID |
| exceptionEvents: Cross-reference of exception event timestamps, the ID of the corresponding state that caused the event, and the cause. | <ul style="list-style-type: none"> • t: Event timestamp • stateIdx: State ID • cause: Cause of exception |
| resetTime: Stores timestamps of solver resets. | None |
| tout: Stores simulation times. | None |

Data Types: double

More About

Statistics Pane

The statistics pane displays information on model parameters, including:

- **Average step size** — A measure of how fast the solver advances. It is calculated as the total simulation time divided by the number of steps the solver used. It is bounded by the model configuration parameters **Max step size** and **Min step size**.
- **Max step size usage** — The percentage of maximum step sizes used by the solver among all step sizes.
- **Zero crossing** — A solver-specific event that affects model dynamics. During simulation, the solver detects zero crossing. Zero crossing detection incurs computation cost. For more information, see “Zero-Crossing Detection”.
- **Solver reset** — An event that causes the solver to reset its parameters. Solver reset detection incurs computation cost. The solver reset statistics are broken down into **Zero Crossing**, **Discrete Signal**, **ZOH Signal**, **Block Change**, **Initial Reset**, and **Internal** solver reset events. For more information, see “Solver Resets”
- **Solver exception** — An event that renders the solver unable to solve model states to meet accuracy specifications. To solve model states accurately, the solver has to run a few adjusted trials, which incur computation cost.
- **Error control exception** — An event where a solution obtained by the solver has an error that is greater than the tolerance specification.
- **Newton iteration exception** — An event specific to implicit solvers. Newton iterations do not converge after a few trials.
- **Infinite state exception** — An event where one or more states solved by the solver are infinite.
- **DAE newton iteration exception** — An event specific to implicit solvers for Simscape models. The Newton iteration does not converge even though the solver violates the minimum step size constraint.

Suggestions and Exceptions Pane

The suggestions and exceptions pane displays information on exceptions, including:

- **Zero crossing** — A solver-specific event that affects model dynamics. During simulation, the solver detects zero crossing. Zero crossing detection incurs computation cost. For more information, see “Zero-Crossing Detection”.
- **Solver reset** — An event that causes the solver to reset its parameters. Solver reset detection incurs computation cost. The solver reset statistics are broken down into **Zero Crossing**, **Discrete Signal**, **ZOH Signal**, **Block Change**, **Initial Reset**, and **Internal** solver reset events. For more information, see “Solver Resets”
- **Solver exception** — An event that renders the solver unable to solve model states to meet accuracy specifications. To solve model states accurately, the solver has to run a few adjusted trials, which incur computation cost.
- **Error control exception** — An event where a solution obtained by the solver has an error that is greater than the tolerance specification.
- **Newton iteration exception** — An event specific to implicit solvers. Newton iterations do not converge after a few trials.
- **Infinite state exception** — An event where one or more states solved by the solver are infinite.
- **DAE newton iteration exception** — An event specific to implicit solvers for Simscape models. The Newton iteration does not converge even though the solver violates the minimum step size constraint.

Solver Reset Pane

The **Solver Reset** pane shows a tabulated list of solver resets that have occurred when simulating the model. Each row of the table corresponds to a block in the model. The following causes of solver resets are recorded:

- **Zero Crossing**
- **Discrete Signal**
- **ZOH Signal**
- **Block Change**
- **Initial Reset**
- **Internal**

See Also

`solverprofiler.profileModel` | Zero Crossing Explorer | States Explorer

Topics

“Examine Model Dynamics Using Solver Profiler”

“Solver Resets”

“Zero-Crossing Events”

“Solver Exception Events”

“Jacobian Logging and Analysis”

Introduced in R2016a

States Explorer

Visualize states in model

Description

Use the **States Explorer** to view individual state dynamics of your model

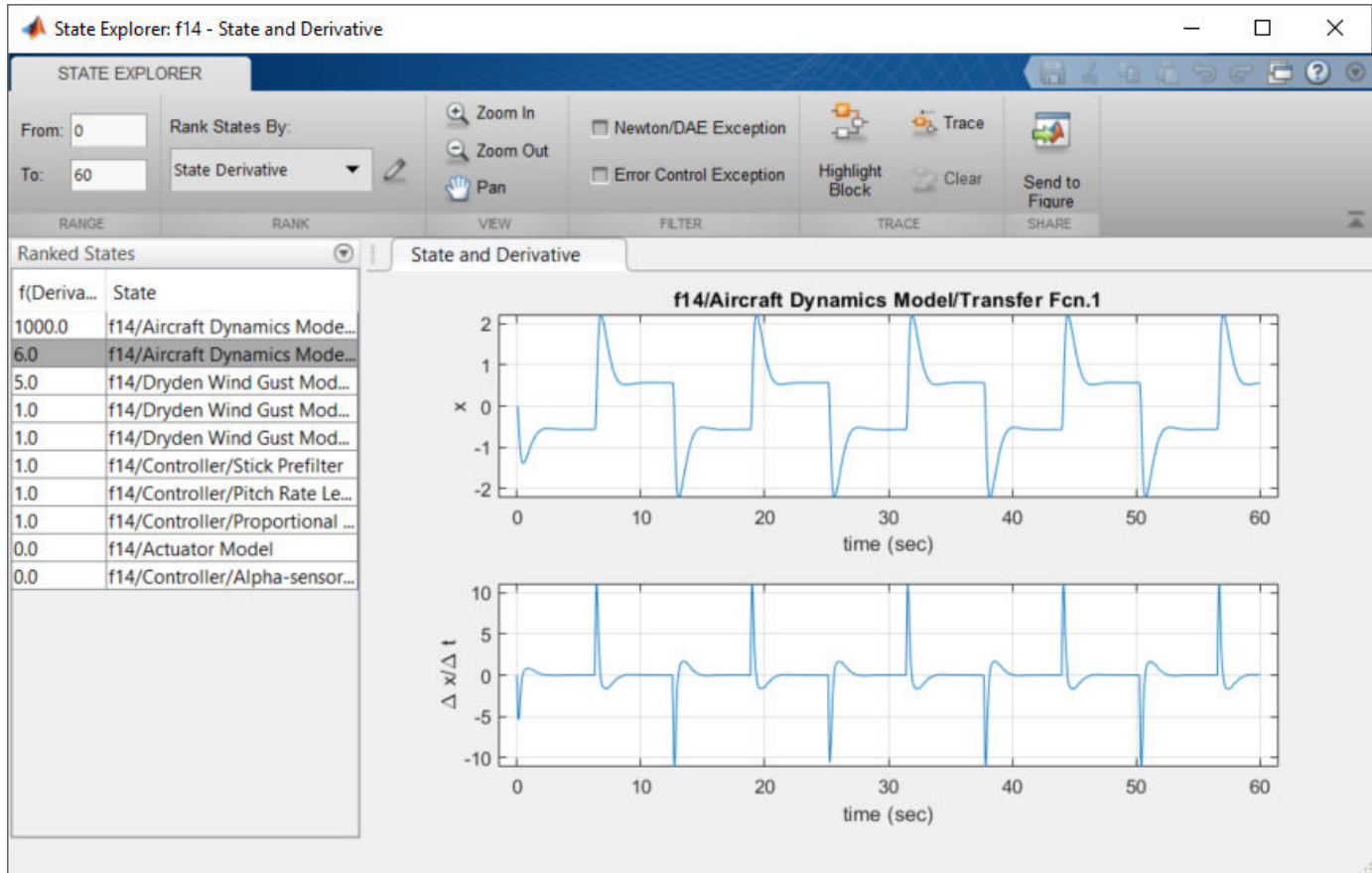

Open the States Explorer

- Profile the model using the **Solver Profiler**. Ensure that the **States & Zero Crossing** parameter is enabled.
- Select **States** in the **Explore** section of the **Solver Profiler** toolstrip.

See Also

[solverprofiler.profileModel](#) | [Solver Profiler](#) | [Zero Crossing Explorer](#)

Introduced in R2016a

Zero Crossing Explorer

Visualize and interactively explore zero-crossing events

Description

Use the **Zero Crossing Explorer** to visualize and analyze zero crossing events that occur for each state in your model.

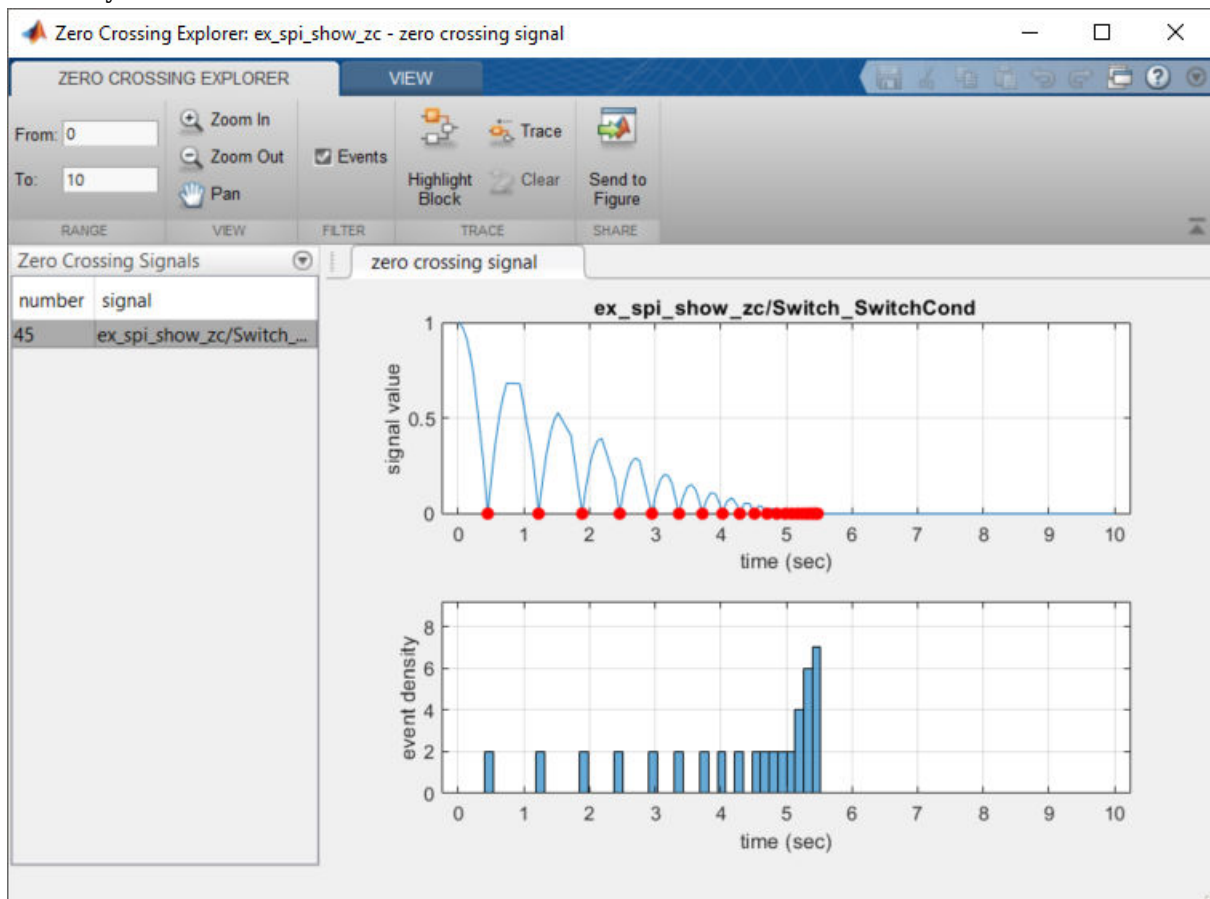

Open the Zero Crossing Explorer

- Profile the model using the **Solver Profiler**. Ensure that the **States & Zero Crossing** parameter is enabled.
- Select **Zero Crossing** in the **Explore** section of the **Solver Profiler** toolstrip.

Examples

Interactively Explore Zero Crossings

Use the **Zero Crossing Explorer** to examine clusters of zero crossing events

Open the `ex_spi_show_zc` model and launch the **Solver Profiler**.

Enable the **States & Zero Crossing** parameter in the **Log** section of the toolstrip and run the **Solver Profiler**.

When profiling has completed, launch the **Zero Crossing Explorer**

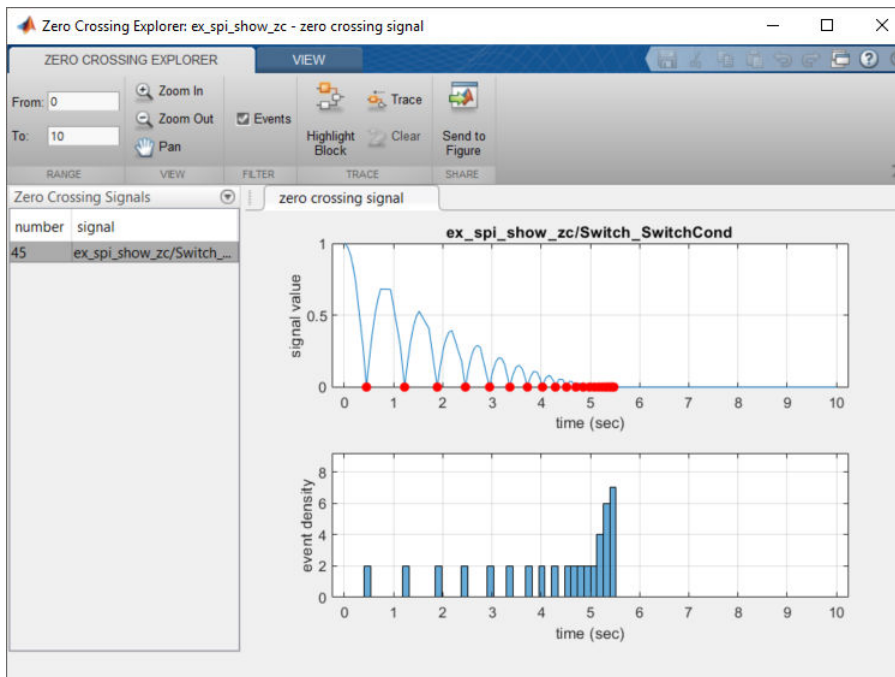

There is an increase in the density of zero crossing events halfway through the simulation. Zoom in on the **event density** plot between the 5 and 6 second mark

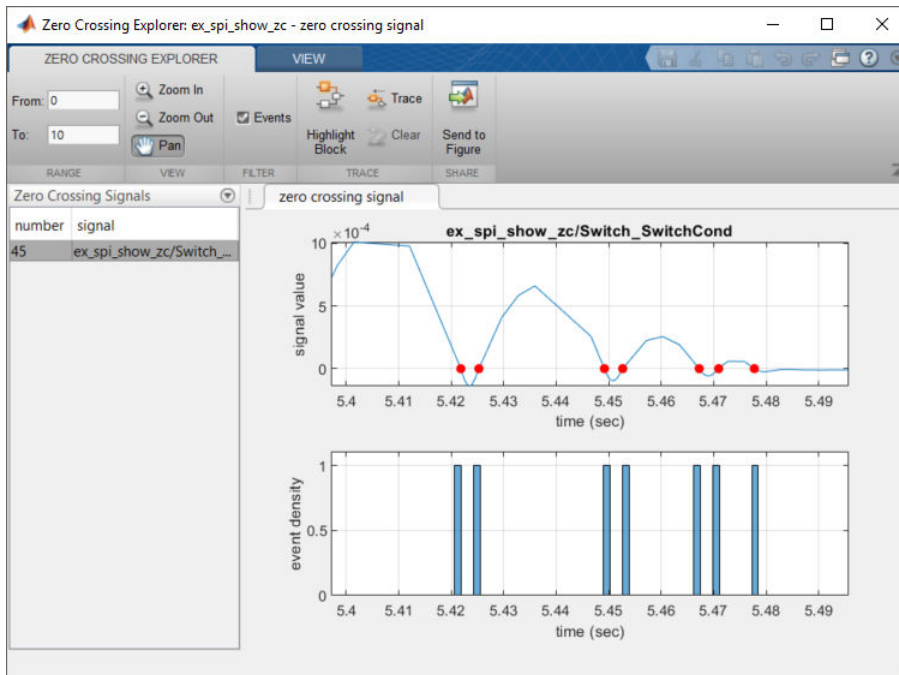

A closer examination reveals that each bounce corresponds to two zero crossings — from positive to negative and vice-versa. This is an artefact of numerically solving state dynamics that approach 0 value. Around 5.48 seconds, the ball being simulated in the model comes to 'rest', hence the isolated single zero crossing event.

- “Zero-Crossing Events”

See Also

[Solver Profiler](#) | [States Explorer](#) | `solverprofiler.profileModel`

Topics

“Zero-Crossing Events”
 “Zero-Crossing Detection”

Introduced in R2019a

Objects

Simulink.Annotation

Create and specify properties of text, image, and area annotations

Description

Annotations are visual elements that you can use to add descriptive notes and callouts to your model. You can programmatically access and modify them as `Simulink.Annotation` objects.

To interactively create and modify annotations, see “Describe Models Using Notes and Annotations”.

Creation

Syntax

```
a = Simulink.Annotation(sys,name)
a = Simulink.Annotation(path,Name,Value)
```

Description

`a = Simulink.Annotation(sys,name)` creates an annotation with the specified name and default properties in the specified system or subsystem.

`a = Simulink.Annotation(path,Name,Value)` creates an annotation with properties on page 8-3 specified using name-value pairs. For example, `Simulink.Annotation('model/annotation','BackgroundColor','yellow')` creates an annotation with a yellow background. You can specify multiple name-value pairs. Enclose each property name in quotes.

Input Arguments

sys — System or subsystem to contain annotation

character vector | string scalar

System or subsystem to contain annotation, specified as a character vector or string scalar.

Data Types: `char` | `string`

name — Name of new annotation

character vector

Name of new annotation, specified as a character vector.

Data Types: `char`

path — Path to new annotation

character vector | string scalar

Path to new annotation, specified as a character vector or string scalar composed of the system name and the annotation name.

Example: `Simulink.Annotation('model/annotation')`

Data Types: char | string

Properties

Interaction

Selected — Option to select annotation

'off' (default) | on/off logical value

Option to select or deselect the annotation, specified as 'on' or 'off', or numeric or logical 1 (true) or 0 (false). A value of 'on' is equivalent to true, and 'off' is equivalent to false. Thus, you can use the value of this property as a logical value. The value is stored as an on/off logical value of type OnOffSwitchState.

- 'on' — Select annotation.
- 'off' — Remove selection from annotation.

Data Types: logical | char | string

Text

Name — Text of annotation

character vector | string scalar

Text of annotation, specified as a character vector or string scalar.

Same as Text.

Data Types: char | string

Text — Text of annotation

character vector | string scalar

Text of annotation, specified as a character vector or string scalar.

Same as Name.

Data Types: char | string

Interpreter — Option to format text style

'off' (default) | 'rich' | 'tex'

Option to format text style, specified as 'off' for plain text, 'rich' for rich text, or 'tex' for text that contains LaTeX commands. When you format a plain text annotation using the formatting toolbar, the annotation becomes a rich text annotation.

TeXMode — Option to render TeX markup

'off' (default) | on/off logical value

Option to render TeX markup, specified as 'on' or 'off', or numeric or logical 1 (true) or 0 (false). A value of 'on' is equivalent to true, and 'off' is equivalent to false. Thus, you can use the value of this property as a logical value. The value is stored as an on/off logical value of type OnOffSwitchState.

- 'on' — Render TeX markup.

- 'off' — Do not render TeX markup.

MarkupType — Option to make markup annotation

'model' (default) | 'markup'

Option to make markup annotation, specified as 'model' or 'markup'.

Note Set the 'ShowMarkup' model parameter to 'on' to show markup annotations or 'off' to hide markup annotations.

Font

FontName — Font name

'auto' (default) | character vector | string scalar

This property affects only plain text annotations.

Font name, specified as a character vector or string scalar. The default value, 'auto', uses the default font specified for annotations in the Font Styles dialog box. To open the Font Styles dialog box, on the **Format** tab, click the **Font Properties** button arrow, then click **Fonts for Model**.

Data Types: char | string

FontSize — Font size, in points

-1 (default) | numeric scalar

This property affects only plain text annotations.

Font size, in points, specified as a numeric scalar. The default value, -1, uses the default font size for annotations specified in the Font Styles dialog box. To open the Font Styles dialog box, on the **Format** tab, click the **Font Properties** button arrow, then click **Fonts for Model**.

Data Types: single | double | int8 | int16 | int32 | int64 | uint8 | uint16 | uint32 | uint64

FontWeight — Character thickness

'auto' (default) | 'normal' | 'bold' | 'light' | 'demi'

This property affects only plain text annotations.

Character thickness, specified as one of the values listed in the table.

| Value | Description |
|----------|--|
| 'auto' | The default weight for annotations specified in the Font Styles dialog box. To open the Font Styles dialog box, on the Format tab, click the Font Properties button arrow, then click Fonts for Model . |
| 'normal' | Normal font weight. |
| 'bold' | Bold font weight. |
| 'light' | Not recommended. |
| 'demi' | Not recommended. |

FontAngle – Angle of annotation font

'auto' (default) | 'normal' | 'italic' | 'oblique'

This property affects only plain text annotations.

Angle of annotation font, specified as one of the values listed in the table.

| Value | Description |
|-----------|--|
| 'auto' | The default font angle specified for annotations in the Font Styles dialog box. To open the Font Styles dialog box, on the Format tab, click the Font Properties button arrow, then click Fonts for Model . |
| 'normal' | Normal font. |
| 'italic' | Italic font. |
| 'oblique' | Oblique font (usually the same as italic font). |

Colors and Effects**BackgroundColor – Background color of annotation**

'white' (default) | RGB value array | 'automatic' (transparent) | 'black' | 'red' | 'green' | 'blue' | ...

Background color of annotation, specified as one of the values listed in this table.

| Value | Description |
|--|---------------------------|
| 'automatic' | Transparent |
| 'black' | Black |
| 'white' | White |
| 'red' | Red |
| 'green' | Green |
| 'blue' | Blue |
| 'cyan' | Cyan |
| 'magenta' | Magenta |
| 'yellow' | Yellow |
| 'gray' | Gray |
| 'lightBlue' | Light blue |
| 'orange' | Orange |
| 'darkGreen' | Dark green |
| RGB value array, specified as '[r, g, b]' where r, g, and b are the red, green, and blue values of the color normalized to the range 0.0 to 1.0. | Fully opaque custom color |

Data Types: char | string

ForegroundColor – Foreground color of annotation

'black' (default) | RGB value array | 'white' | 'red' | 'green' | 'blue' | ...

Foreground color of annotation, specified as one of the values listed in this table.

| Value | Description |
|--|---------------------------|
| 'black' | Black |
| 'white' | White |
| 'red' | Red |
| 'green' | Green |
| 'blue' | Blue |
| 'cyan' | Cyan |
| 'magenta' | Magenta |
| 'yellow' | Yellow |
| 'gray' | Gray |
| 'lightBlue' | Light blue |
| 'orange' | Orange |
| 'darkGreen' | Dark green |
| RGB value array, specified as '[r,g,b]' where r, g, and b are the red, green, and blue values of the color normalized to the range 0.0 to 1.0. | Fully opaque custom color |

Data Types: char | string

DropShadow — Option to display drop shadow

'off' (default) | on/off logical value

Option to display drop shadow, specified as 'on' or 'off', or numeric or logical 1 (true) or 0 (false). A value of 'on' is equivalent to true, and 'off' is equivalent to false. Thus, you can use the value of this property as a logical value. The value is stored as an on/off logical value of type `OnOffSwitchState`.

- 'on' — Display drop shadow.
- 'off' — Do not display drop shadow.

Size and Position

FixedHeight — Option to control annotation height

'off' (default) | on/off logical value

Option to control annotation height, specified as 'on' or 'off', or numeric or logical 1 (true) or 0 (false). A value of 'on' is equivalent to true, and 'off' is equivalent to false. Thus, you can use the value of this property as a logical value. The value is stored as an on/off logical value of type `OnOffSwitchState`.

- 'on' — The annotation does not resize to accommodate text changes. The visible text may be truncated.
- 'off' — The annotation automatically resizes to accommodate text changes.

Interactively resizing the annotation sets this parameter to 'on'.

VerticalAlignment — Vertical anchor point of annotation

'top' (default) | 'middle' | 'bottom' | 'cap' | 'baseline'

Vertical anchor point of annotation, specified as one of the values listed in this table.

| Value | Description |
|------------|--|
| 'top' | The top of the annotation remains fixed as the annotation grows or shrinks. |
| 'middle' | The middle of the annotation remains fixed as the annotation grows or shrinks. |
| 'bottom' | The bottom of the annotation remains fixed as the annotation grows or shrinks. |
| 'cap' | Not recommended. |
| 'baseline' | Not recommended. |

Dependencies

To enable `VerticalAlignment`, set `FixedHeight` to 'off'.

FixedWidth — Option to control annotation width

'off' (default) | on/off logical value

Option to control annotation width, specified as 'on' or 'off', or numeric or logical 1 (true) or 0 (false). A value of 'on' is equivalent to true, and 'off' is equivalent to false. Thus, you can use the value of this property as a logical value. The value is stored as an on/off logical value of type `OnOffSwitchState`.

- 'on' — The annotation does not resize to accommodate text changes. When text cannot fit inside the annotation bounds, it wraps onto the next line.
- 'off' — The annotation automatically resizes to accommodate text changes.

Interactively resizing the annotation sets this parameter to 'on'.

HorizontalAlignment — Horizontal alignment of text within annotation

'left' (default) | 'center' | 'right'

Horizontal alignment of text within annotation, specified as one of the values listed in the table.

| Value | Result |
|----------|--|
| 'left' | Text in the annotation is left justified. |
| 'center' | Text in the annotation is centered. |
| 'right' | Text in the annotation is right justified. |

InternalMargins — Space between bounding box and borders

[0 0 0 0] (default) | 1x4 array

Space between bounding box of text and borders of annotation, specified as a 1x4 array. The array provides the space between the text and each side of the annotation. The elements of the array specify the space at the left, top, right, and bottom sides in order ([left top right bottom]).

Supported coordinates are between -1073740824 and 1073740823, inclusive.

Data Types: double

Position — Location of annotation

[0 0 28 14] (default) | 1x4 array

Location of annotation, specified as a 1x4 array. The array provides the locations of the annotation sides, in pixels. The elements of the array specify the locations of the left, top, right, and bottom sides in order ([left top right bottom]).

The origin is the upper-left corner of the Simulink Editor canvas before any canvas resizing. Positive values are to the right of and down from the origin. Negative values are to the left of and up from the origin. Supported coordinates are between -1073740824 and 1073740823, inclusive.

Dependencies

- To programmatically move the location of the right side without moving the left side the same amount, `FixedWidth` must be set to 'on'.
- To programmatically move the location of the bottom side without moving the top side the same amount, `FixedHeight` must be set to 'on'.

Data Types: double

Metadata**Description — Description of annotation**

character vector | string scalar

Description of annotation, specified as a character vector or string scalar.

Data Types: char | string

Tag — Text tag for annotation

character vector | string scalar

Text tag for annotation, specified as a character vector or string scalar.

Data Types: char | string

UserData — Data to associate with annotation

user data

Data to associate with annotation.

Data Types: single | double | int8 | int16 | int32 | int64 | uint8 | uint16 | uint32 | uint64 | logical | char | string | struct | table | cell | function_handle | categorical | datetime | duration | calendarDuration | fi

Callback Functions**ClickFcn — MATLAB code that executes when you click annotation**

character vector | string scalar

MATLAB code that executes when you click annotation, specified as a character vector or string scalar.

For more information, see “Make Annotations Interactive”.

Dependencies

When `UseDisplayTextAsClickCallback` is set to 'on', the `ClickFcn` value matches the `Name` and `Text` value.

Data Types: char | string

UseDisplayTextAsClickCallback — Option to use text as click function

'off' (default) | on/off logical value

Option to use text as click function, specified as 'on' or 'off', or numeric or logical 1 (true) or 0 (false). A value of 'on' is equivalent to true, and 'off' is equivalent to false. Thus, you can use the value of this property as a logical value. The value is stored as an on/off logical value of type `OnOffSwitchState`.

- 'on' — Clicking the annotation runs the annotation text specified by `Text`, which is interpreted as a valid MATLAB expression.
- 'off' — Clicking the annotation runs the function specified by `ClickFcn`, if available. If a click function is not specified, clicking the annotation does not run a function.

For more information, see “Make Annotations Interactive”.

LoadFcn — MATLAB code to execute when model containing annotation loads

character vector | string scalar

MATLAB code to execute when model containing annotation is loaded, specified as a character vector or string scalar. For more information, see “Make Annotations Interactive”.

Data Types: char | string

DeleteFcn — MATLAB code to execute before programmatically deleting annotation

character vector | string scalar

MATLAB code to execute before programmatically deleting annotation, specified as a character vector or string scalar.

For more information, see “Make Annotations Interactive”.

Data Types: char | string

Information (Read-Only)**Type — Annotation type**

'annotation' (default)

This property is read-only.

Annotation type, returned as 'annotation'.

AnnotationType — Type of annotation

'note_annotation' | 'area_annotation' | 'image_annotation'

This property is read-only.

Type of annotation, specified as 'note_annotation' for a text-based note, 'area_annotation' for an area, or 'image_annotation' for an image.

To programmatically create an area, see “Create Area Programmatically”.

To programmatically create an image-only annotation, see `setImage`.

IsImage — Check whether annotation is image-only annotation

'off' (default) | 'on'

This property is read-only.

Check whether annotation is an image-only annotation, returned as 'on' or 'off'.

PlainText — Text in annotation

vector

This property is read-only.

Text in annotation, without formatting, returned as a vector.

Handle — Annotation handle

double

This property is read-only.

Annotation handle, returned as a double.

Parent — System that contains annotation

character vector

This property is read-only.

System that contains annotation, returned as a character vector.

Path — Path to annotation

character vector

This property is read-only.

Path to annotation, returned as a character vector.

Object Functions

| | |
|-----------------------|--|
| <code>view</code> | Find annotation |
| <code>setImage</code> | Specify image to display as annotation |
| <code>delete</code> | Delete annotation |

Examples**Create Annotation Programmatically**

Programmatically create, modify, and view an annotation.

Open a new model.

```
open_system(new_system)
```

Create an annotation with default properties using the `Simulink.Annotation` function.

```
a = Simulink.Annotation(gcs, 'This is an annotation.');
```

After creating the annotation, use dot notation to set property values. For example, apply an 18-point font and light blue background to the annotation.

```
a.FontSize = 18;
a.BackgroundColor = 'lightBlue';
```

To view and briefly highlight the new annotation, use the `view` function.

```
view(a)
```

Create Annotation with Custom Properties

Programmatically create an annotation with custom properties.

Open a model.

```
new_system('CreateAnnotationModel')
open_system('CreateAnnotationModel')
```

Create an annotation with custom properties specified as comma-separated pairs consisting of the property and value by using the `Simulink.Annotation` function. For example, apply an 18-point font and light blue background to the annotation.

```
a = Simulink.Annotation('CreateAnnotationModel/This is an annotation.',...
'FontSize',18, 'BackgroundColor', 'lightblue');
```

Tips

- To programmatically modify an existing annotation, use the `find_system` function to get the annotation handle, then use the `get_param` function to get the object. For example:

```
h = find_system(gcs, 'FindAll', 'on', 'Type', 'annotation');
a1 = get_param(h(1), 'Object');
```
- If an annotation invoked a currently executing callback function, use the `getCallbackAnnotation` to determine which annotation invoked it. The function returns the corresponding `Annotation` object. This function is also useful if you write a callback function in a separate MATLAB file that contains multiple callback calls.

Alternative Functionality

You also can create annotations using the `add_block` function. For example:

- `add_block('built-in/Note', 'model/This is a note.', 'BackgroundColor', 'yellow')` creates a note annotation with a yellow background.
- `add_block('built-in/Area', 'model/This is an Area.', 'Position', [120, 100, 230, 200])` creates an area annotation at the specified position.

To interactively create an annotation and edit its properties, see “Describe Models Using Notes and Annotations”.

See Also

`add_block` | `getCallbackAnnotation` | `find_system`

Topics

“Describe Models Using Notes and Annotations”

“Create and Edit Annotations Programmatically”

Introduced before R2006a

Simulink.BlockPath

Fully specified Simulink block path

Description

A `Simulink.BlockPath` object represents a fully specified block path that uniquely identifies a block within a model hierarchy, even when the model hierarchy references the same model multiple times.

Creation

Use either the `Simulink.BlockPath` or `gcbp` function to create a `Simulink.BlockPath` object. To get a `Simulink.BlockPath` object for the most recently clicked or loaded block, use the `gcbp` function.

Syntax

```
bp = Simulink.BlockPath
bp = Simulink.BlockPath(blockpath)
bp = Simulink.BlockPath(paths)
bp = Simulink.BlockPath(paths, subpath)
```

Description

`bp = Simulink.BlockPath` creates an empty `BlockPath` object.

`bp = Simulink.BlockPath(blockpath)` creates a copy of the specified `BlockPath` object.

`bp = Simulink.BlockPath(paths)` creates a `BlockPath` object from the specified character vector or cell array of character vectors. Each character vector represents a path at a level of the model hierarchy. Simulink builds the full block path based on the character vectors.

`bp = Simulink.BlockPath(paths, subpath)` additionally specifies an individual component of the block, such as a signal, that you specify with the `subpath` argument.

Input Arguments

blockpath — Existing `BlockPath` object

`BlockPath` object

Existing `BlockPath` object that you want to copy, specified as a `BlockPath` object.

paths — Paths used to build block path

character vector | cell array of character vectors

Paths used to build the block path, specified as a character vector or cell array of character vectors.

Specify each character vector in order, from the top model to the specific block for which you are creating a `BlockPath` object.

Each character vector must be a path to a block within the Simulink model. The block must be:

- A block in a single model
- A Model block (except for the last character vector, which may be a block other than a Model block)
- A block in the model referenced by the Model block that the previous character vector specifies

subpath — Individual component of block

character vector

Individual component of a block, such as a signal, specified as a character vector.

Properties

SubPath — Component of block

' ' (default) | character vector

Component of the block, specified as a character vector that provides the block path. For example, if the block path refers to a Stateflow chart, you can use `SubPath` to indicate the chart signals.

Example: `'gear_state.first'`

Data Types: `char`

Object Functions

| | |
|----------------------------|---|
| <code>convertToCell</code> | Convert block path to cell array of character vectors |
| <code>getBlock</code> | Get single block path in model reference hierarchy |
| <code>getLength</code> | Get number of hierarchy levels in block path |
| <code>open</code> | Open specified model, library, subsystem, or block |
| <code>validate</code> | Determine whether block path represents valid block hierarchy |

Examples

Create Simulink.BlockPath Object Using Cell Array

Create a block path object called `bp2`, using a cell array of character vectors representing elements of the block path.

```
sldemo_mdref_depgraph
bp2 = Simulink.BlockPath({'sldemo_mdref_depgraph/thermostat', ...
'sldemo_mdref_heater/Fahrenheit to Celsius', ...
'sldemo_mdref_F2C/Gain1'})
```

```
bp2 =
```

```
Simulink.BlockPath
Package: Simulink
```

```
Block Path:
sldemo_mdref_depgraph/thermostat
sldemo_mdref_heater/Fahrenheit to Celsius
sldemo_mdref_F2C/Gain1
```

The resulting block path reflects the model reference hierarchy for the block path.

See Also

Classes

`Simulink.SimulationData.BlockPath` | `Simulink.SimulationData.Dataset`

Functions

`gcbp`

Introduced in R2010b

Simulink.Bus

Specify properties of buses

Description

A `Simulink.Bus` object is a data type that, when used with `Simulink.BusElement` objects, specifies and validates the properties of a bus. When you simulate or update a model, Simulink checks whether buses connected to blocks match the `Simulink.Bus` object data types that the blocks specify.

A `Bus` object specifies only the architectural properties of a bus. For example, a bus object can specify element names, hierarchy, order, and data types. A `Bus` object cannot specify the values of the signals in a bus.

A `Bus` object is analogous to a structure definition in C: it defines the members of the bus but does not create the bus. A `Bus` object is also similar to a cable connector. The connector defines all the pins and their configuration and controls what types of wires can be connected to it. Similarly, a `Bus` object defines the configuration and properties of the signals that the associated bus must have.

`Bus` objects contain `Simulink.BusElement` objects. Each `BusElement` object specifies the properties of a signal in a bus, such as its name, data type, and dimension. The order of the `BusElement` objects in the `Bus` object defines the order of the signals in the bus.

A `Bus` object can specify properties that were not defined by constituent signals, but were left to be inherited.

To create and modify `Bus` objects in the base workspace or a data dictionary, you can use the **Bus Editor**, **Model Explorer**, or MATLAB commands. You cannot store `Bus` objects in model workspaces.

To use `Bus` objects in a model, see “Specify Bus Properties with `Simulink.Bus` Object Data Types”.

Creation

You can create a `Bus` object in multiple ways.

- To programmatically create a `Bus` object, use the `Simulink.Bus` function (described here).
- To interactively create a `Bus` object, use the **Bus Editor** or **Model Explorer**.
- To create `Bus` objects from blocks in a model, MATLAB data, and external C code, see “Create Bus Objects Programmatically”.

Syntax

```
name = Simulink.Bus
```

Description

`name = Simulink.Bus` returns a `Bus` object with default property values. The name of the `Bus` object is the name of the MATLAB variable to which you assign the `Bus` object.

Properties

Description — Bus description

' ' (default) | character vector

Bus description, specified as a character vector. Use the description to document information about the Bus object, such as the kind of signal it applies to or where the Bus object is used. This information does not affect Simulink processing.

Data Types: char | string

Elements — Elements of bus

empty array (default) | array of Simulink.BusElement objects

Elements of bus, specified as an array of Simulink.BusElement objects. Each BusElement object defines the name, data type, dimensions, and other properties of a signal within the bus. For more information, see Simulink.BusElement.

DataScope — Data type definition mode in generated code

'Auto' (default) | 'Exported' | 'Imported'

Data type definition mode in generated code, specified as 'Auto', 'Exported', or 'Imported'. This property specifies whether during code generation the data type definition is imported from, or exported to, the header file specified with the HeaderFile property.

| Value | Action |
|------------------|--|
| 'Auto' (default) | Import the data type definition from the specified header file. If you do not specify the header file, export the data type definition to the default header file. |
| 'Exported' | Export the data type definition to the specified header file or default header file. |
| 'Imported' | Import the data type definition from the specified header file or default header file. |

Data Types: char | string

HeaderFile — C header file used with data type definition

' ' (default) | character vector

C header file used with data type definition, specified as a character vector. Based on the value of the DataScope property, import the data type definition from or export the data type definition to the header file. The Simulink Coder software uses this property for code generation. Simulink software ignores this property.

By default, the generated #include directive uses the preprocessor delimiter " instead of < and >. To generate the directive #include <myTypes.h>, specify HeaderFile as <myTypes.h>.

Data Types: char | string

Alignment — Data alignment boundary

-1 (default) | integer

Data alignment boundary, specified as an integer, in number of bytes. The Simulink Coder software uses this property for code generation. Simulink software ignores this property.

The starting memory address for the data allocated for the bus is a multiple of the `Alignment` setting. If the object occurs in a context that requires alignment, you must specify an `Alignment` value with a positive integer that is a power of 2, not exceeding 128.

Data Types: `single` | `double` | `int8` | `int16` | `int32` | `int64` | `uint8` | `uint16` | `uint32` | `uint64`

PreserveElementDimensions — Specification to preserve dimensions of multidimensional bus elements

`'false'` (default) | `'true'`

Specification for the code generator to preserve dimensions of multidimensional bus elements in the generated code. For more information, see “Preserve Dimensions of Bus Elements in Generated Code” (Embedded Coder).

Data Types: `logical`

Examples

Create Bus Objects from Arrays

Create a hierarchy of `Bus` objects using arrays. Array indexing lets you create and access multiple elements in an array. Dot notation lets you access property values.

Create two `BusElement` objects, named `Chirp` and `Sine`, in the base workspace.

```
elems(1) = Simulink.BusElement;
elems(1).Name = 'Chirp';

elems(2) = Simulink.BusElement;
elems(2).Name = 'Sine';
```

Create a `Bus` object, named `NestedBus`, that uses the elements defined in the `elems` array.

```
NestedBus = Simulink.Bus;
NestedBus.Elements = elems;
```

Create two more `BusElement` objects, named `NestedBus` and `Step`. To have `NestedBus` represent a `Bus` object, specify a `Bus` object data type.

```
clear elems

elems(1) = Simulink.BusElement;
elems(1).Name = 'NestedBus';
elems(1).DataType = 'Bus: NestedBus';

elems(2) = Simulink.BusElement;
elems(2).Name = 'Step';
```

Create the bus at the top of the bus hierarchy that uses the elements defined in the `elems` array.

```
TopBus = Simulink.Bus;
TopBus.Elements = elems;
```

You can view the created objects in the **Bus Editor**.

```
buseditor
```

See Also

Functions

`Simulink.Bus.cellToObject` | `Simulink.Bus.createObject` |
`Simulink.Bus.createMATLABStruct` | `Simulink.Bus.objectToCell` | `Simulink.Bus.save`

Tools

Bus Editor

Objects

`Simulink.BusElement`

Topics

“Specify Bus Properties with `Simulink.Bus` Object Data Types”

“Create Bus Objects Programmatically”

“Organize Data into Structures in Generated Code” (Simulink Coder)

“Data Alignment for Code Replacement” (Embedded Coder)

Introduced before R2006a

Simulink.BusElement

Specify properties of elements of buses

Description

A `Simulink.BusElement` object is an element of a `Simulink.Bus` object that validates the properties of an element in a bus. When you simulate or update a model, Simulink checks whether the properties specified by the `BusElement` object match the properties specified by the corresponding bus elements.

`BusElement` objects exist only within the `Bus` object. You can specify a `Bus` object, but not a `BusElement` object, as a data type.

To create and modify `Bus` and `BusElement` objects in the base workspace or a data dictionary, you can use the **Bus Editor**, **Model Explorer**, or MATLAB commands. You cannot store `Bus` objects in model workspaces.

Creation

You can create a `BusElement` object in multiple ways.

- To programmatically create a `BusElement` object, use the `Simulink.BusElement` function (described here).
- To interactively create a `BusElement` object, use the **Bus Editor** or **Model Explorer**.
- To create `BusElement` objects from blocks in a model, MATLAB data, and external C code, see “Create Bus Objects Programmatically”.

Syntax

```
be = Simulink.BusElement
```

Description

`be = Simulink.BusElement` returns a `BusElement` object with default property values.

Properties

Name — Name of element

'a' (default) | character vector

Name of element, specified as a character vector.

Note To validate the properties of a signal against a `BusElement` object, the signal name must be a valid identifier that starts with an alphabetic character or underscore (`_`), followed by alphanumeric characters or underscores.

Data Types: char | string

Complexity — Numeric type of element

'real' (default) | 'complex'

Numeric type of the element, specified as 'real' or 'complex'.

Data Types: char | string

Dimensions — Dimensions of element

1 (default) | scalar | vector

Dimensions of element, specified as a scalar or vector.

To use symbolic dimensions in generated code, see “Implement Dimension Variants for Array Sizes in Generated Code” (Embedded Coder).

Data Types: double

Data Type — Data type of element

'double' (default) | character vector | string scalar

Data type of element, specified as a character vector or string scalar.

Click the **Show data type assistant** button  to display the **Data Type Assistant**, which helps you set the data type attributes. For more information, see “Specify Data Types Using Data Type Assistant”.

You can specify any of these options:

- Built-in Simulink data type — For example, specify 'single' or 'uint8'. See “Data Types Supported by Simulink”.
- Fixed-point data type — Use the `fixdt` function. For example, specify 'fixdt(1,16,0)'.
- Enumerated data type — Use the name of the type preceded by `Enum:`. For example, specify 'Enum: myEnumType'.
- Bus data type — Use the name of the `Simulink.Bus` object preceded by `Bus:`. For example, specify 'Bus: myBusObject'.
- Value type — Use the name of the `Simulink.ValueType` object preceded by `ValueType:`. For example, specify 'ValueType: windVelocity'.
- Custom data type — Use a MATLAB expression that specifies the type. For example, you can specify a `Simulink.NumericType` object whose `DataTypeMode` property is set to a value other than 'Fixed-point: unspecified scaling'.

Specifying a `Simulink.Bus` object allows you to create Bus objects that specify hierarchical buses (that is, buses that contain other buses).

When you specify a `Simulink.ValueType` or `Simulink.Bus` object, the object defines more than the data type. The object also defines properties such as **Min**, **Max**, and **Unit**. The property values specified by the `ValueType` object override the corresponding property values specified by a block. For example, suppose a block sets **Unit** to ft/s. When the **Data type** of the block specifies a `ValueType` object that has m/s as its unit, the block uses m/s instead of ft/s.

Data Types: char | string

Min — Minimum value of element

[] (default) | scalar

Minimum value of the element, specified as a scalar. This value must be a finite real double scalar or, if the element is a bus, the value must be empty, [].

Data Types: double

Max — Maximum value of element

[] (default) | scalar

Maximum value of the element, specified as a scalar. This value must be a finite real double scalar or, if the element is a bus, the value must be empty, [].

Data Types: double

DimensionsMode — Specify how to handle size of element

'Fixed' (default) | 'Variable'

Specify how to handle size of element, specified as 'Fixed' or 'Variable'.

Data Types: char | string

Unit — Physical unit for expressing element

' ' (default) | character vector

Physical unit for expressing element, specified as a character vector.

For more information, see “Unit Specification in Simulink Models”.

Example: 'inches'

Data Types: char | string

Description — Bus element description

' ' (default) | character vector

Bus element description, specified as a character vector. Use the description to document information about the BusElement object, such as the kind of signal it applies to. This information does not affect Simulink processing.

Data Types: char | string

Examples

Create Bus Objects from Arrays

Create a hierarchy of Bus objects using arrays. Array indexing lets you create and access multiple elements in an array. Dot notation lets you access property values.

Create two BusElement objects, named Chirp and Sine, in the base workspace.

```
elems(1) = Simulink.BusElement;  
elems(1).Name = 'Chirp';
```

```
elems(2) = Simulink.BusElement;  
elems(2).Name = 'Sine';
```

Create a Bus object, named `NestedBus`, that uses the elements defined in the `elems` array.

```
NestedBus = Simulink.Bus;
NestedBus.Elements = elems;
```

Create two more `BusElement` objects, named `NestedBus` and `Step`. To have `NestedBus` represent a Bus object, specify a Bus object data type.

```
clear elems

elems(1) = Simulink.BusElement;
elems(1).Name = 'NestedBus';
elems(1).DataType = 'Bus: NestedBus';

elems(2) = Simulink.BusElement;
elems(2).Name = 'Step';
```

Create the bus at the top of the bus hierarchy that uses the elements defined in the `elems` array.

```
TopBus = Simulink.Bus;
TopBus.Elements = elems;
```

You can view the created objects in the **Bus Editor**.

```
buseditor
```

Compatibility Considerations

Simulink.BusElement objects no longer support the **SampleTime** property

Errors starting in R2020b

The `SampleTime` property of `Simulink.BusElement` objects is no longer supported.

`BusElement` objects that specify a sample time cause an error during compile. To remove the sample time specification from a `BusElement` object, set its `SampleTime` to `-1`.

`Simulink.Bus.cellToObject` continues to accept cell arrays that specify sample time for bus elements. `Simulink.Bus.objectToCell`, `Simulink.Bus.save`, and `Simulink.Bus.createObject` continue to return cell arrays or arrays that include the sample time when it is noninherited. When the sample time is inherited (`-1`), they omit it. Similarly, the **Bus Editor** and **Model Explorer** omit the sample time when it is inherited.

To specify the sample time for an element of a bus, use the `SampleTime` block parameter of corresponding blocks. For example, you can use `In Bus Element`, `Out Bus Element`, and `Signal Specification` blocks to specify sample time.

Simulink.BusElement objects will no longer support the **SamplingMode** property

Not recommended starting in R2016b

In R2016b, the `SamplingMode` property of `Simulink.BusElement` objects was removed. Scripts that use the `SamplingMode` property of `Simulink.BusElement` objects continue to work. `Simulink.Bus.cellToObject` continues to require the `SamplingMode` field and `Simulink.Bus.objectToCell` continues to include the sampling mode in the output cell arrays.

In a future release, support for the `SamplingMode` property will be removed.

To specify whether a signal is sample-based or frame-based, define the sampling mode of input signals at the block level instead of at the signal level.

See Also

`Simulink.Bus` | `Simulink.ValueType`

Topics

“Specify Bus Properties with `Simulink.Bus` Object Data Types”

“Create Bus Objects Programmatically”

“Signal Names and Labels”

“Specify Application-Specific Signal Properties”

“Specify Sample Time”

“Variable-Size Signal Basics”

Introduced before R2006a

Simulink.ConfigSet

Model configuration set

Description

Use the `Simulink.ConfigSet` object to access a model configuration set. Get information about your configuration set and manage configuration parameters.

Creation

Use the `getActiveConfigSet` function to get the active configuration set for a model. Use the `getConfigSet` function to get a model configuration set by name.

Properties

Description — Description of the configuration set

character vector

Description of the configuration set, specified as a character vector. Use the description to provide additional information about a configuration set, such as its purpose.

Name — Name of the configuration set

character vector

Name of the configuration set, specified by a character vector. This name represents the configuration set in the Model Explorer.

Object Functions

| | |
|-----------------------------|---------------------------------------|
| <code>copy</code> | Copy configuration set or reference |
| <code>getFullName</code> | |
| <code>getModel</code> | |
| <code>get_param</code> | Get parameter names and values |
| <code>isActive</code> | |
| <code>isValidParam</code> | |
| <code>saveAs</code> | |
| <code>setPropEnabled</code> | |
| <code>set_param</code> | Set system and block parameter values |

Examples

Get the Active Configuration Set for a Model

Open the model `vdp` and get the active configuration set.

```
vdp  
configSetObj = getActiveConfigSet('vdp');
```

See Also

[getConfigSet](#) | [getActiveConfigSet](#) | [getConfigSets](#)

Topics

“Manage Configuration Sets for a Model”

“Share a Configuration with Multiple Models”

Introduced in R2006a

Simulink.ConfigSetRef

Link model to freestanding configuration set

Description

Use the ConfigSetRef object to allow a model to reference configuration sets that are not saved in a model.

Creation

Create a ConfigSetRef object by using the getConfigSet function to call a model configuration reference by name.

Properties

Description — Description of configuration reference

character vector

Description of the configuration reference, specified as a character vector. Use this property to provide additional information about a configuration reference, such as its purpose. This field can remain blank.

Name — Name of configuration reference

character vector

Name of the configuration reference, specified as a character vector. This name represents the configuration reference in the Model Explorer.

SourceName — Variable that contains referenced configuration set

character vector

Name of the variable in the workspace or the data dictionary that contains the referenced configuration set, specified as a character vector.

Object Functions

| | |
|-----------------|-------------------------------------|
| copy | Copy configuration set or reference |
| getFullName | |
| getModel | |
| get_param | Get parameter names and values |
| getRefConfigSet | |
| isActive | |
| refresh | |

Examples

Create and Reference a Freestanding Configuration Set

Use a `ConfigSetRef` object to allow a model to use a freestanding configuration set, which is not associated with a model.

Open the model `vdp`. Create a freestanding configuration set by copying the configuration set of the model.

```
model = 'vdp';  
open_system(model)  
  
freeConfigSet = copy(getActiveConfigSet(model));
```

Create a configuration reference. To point the reference to your freestanding configuration, set the `SourceName` property to `freeConfigSet`, the base workspace variable that represents your configuration. Name the reference `vdpConfigRef`.

```
configRef = Simulink.ConfigSetRef;  
set_param(configRef, 'SourceName', 'freeConfigSet');  
set_param(configRef, 'Name', 'vdpConfigRef');
```

Attach the configuration reference to the `vdp` model and activate it.

```
attachConfigSet('vdp', configRef);  
setActiveConfigSet('vdp', 'vdpConfigRef');
```

See Also

[getConfigSet](#) | [getActiveConfigSet](#) | [getConfigSets](#)

Topics

“Share a Configuration with Multiple Models”

“Automate Model Configuration by Using a Script”

Introduced in R2007a

Symbol

C Function block data symbol

Description

Define C Function block symbols and their properties.

Creation

Access a `Symbol` object through one of the following methods.

- `addSymbol` function
- `getSymbol` function
- Access the `Symbols` property of a `SymbolSpec` object.

Properties

Name — Symbol name in source code

character vector

Symbol name in source code, specified as a character vector.

Data Types: character

PortNumber — Port number

scalar integer

Port number, specified as a scalar integer. For input and output symbols, `PortNumber` indicates the port index on the block. For parameter symbols, `PortNumber` indicates the order that the symbol appears in the block parameter mask.

Data Types: single | double | int8 | int16 | int32 | int64 | uint8 | uint16 | uint32 | uint64

Size — Size dimensions of the symbol

'1' (default) | character vector

Size of the symbol data specified as a character vector containing a scalar integer. The C Function block supports only scalars and vectors. Matrices and higher-dimension arrays are not supported. You can use a size expression to define the size of an output. Use -1 to inherit size.

Data Types: character

Type — Data type of symbol

'double' (default) | character vector

Data type of the symbol, specified as a character vector that evaluates to a numeric data type, or as a `Simulink.AliasType` object.

Example: `mySymbol.DataType = 'int32'`

Data Types: char

Scope — Scope of the symbol

'Input' (default) | 'Output' | 'Persistent' | 'Parameter' | 'Constant'

Scope of the symbol, specified as one of the following values.

- **Input** — Input symbol to the C Function block.
- **Output** — Output symbol to the C Function block.
- **Parameter** — Define a symbol as parameter. The parameter name is defined by the `Label` property of the symbol.
- **Persistent** — Define a symbol as persistent data.
- You can define a void pointer using the `Persistent` scope in the C Function block. A *void pointer* is a pointer that can store any type of data that you create or allocate.
- **Constant** — Define a symbol as constant using value-size or numeric expressions.

Data Types: character

Label — Symbol label

character vector

Symbol label, specified as a character vector. For symbols with their scope set to `Input` or `Output`, this label appears as the port name on the block. For symbols with their scope set to `Parameter`, this label is the label that appears on the block parameter mask. If the scope is `Constant`, the label is the constant expression. You cannot define a label for `Persistent` symbols.

Data Types: character

See Also**Functions**

`addSymbol` | `getSymbol` | `deleteSymbol`

Objects

`SymbolSpec`

Blocks

C Function

Topics

“Call and Integrate External C Algorithms into Simulink Using C Function Blocks”

Introduced in R2020a

SymbolSpec

Query and configure C Function block data symbols

Description

Use the SymbolSpec object to query and configure C Function block symbol definitions and their properties.

Creation

Syntax

```
myCFunctionObj = get_param(CFcnBlk, 'SymbolSpec')
```

Description

`myCFunctionObj = get_param(CFcnBlk, 'SymbolSpec')` creates a C Function block symbol configuration object for the specified C Function block.

Input Arguments

CFcnBlk — C Function block

character vector

C Function block path specified as a character vector, or a handle to the C Function block.

Properties

Symbols — Symbols defined in the C Function block

Symbol object | array of Symbol objects

The symbols defined in the C Function block, specified as a Symbol object, or an array of Symbol objects.

Symbol objects define the properties of each symbol in the C Function block.

Object Functions

| | |
|---------------------------|---|
| <code>addSymbol</code> | Add a symbol object definition to a C Function block |
| <code>getSymbol</code> | Get a symbol object definition of a C Function block |
| <code>deleteSymbol</code> | Delete a symbol object definition from a C Function block |

See Also

Objects

Symbol

Blocks

C Function

Topics

“Call and Integrate External C Algorithms into Simulink Using C Function Blocks”

Introduced in R2020a

Simulink.ConnectionBus

Specify properties of physical connection buses

Description

A `Simulink.ConnectionBus` object is a data type that, when used with `Simulink.ConnectionElement` objects, lets you design rigid interface specifications for Simscape conserving connections. When you apply such rigid specification to a Simscape Bus or Connection Port block, the block ports become typed by the interface and do not accept connections to a different domain type.

A `ConnectionBus` object specifies the architectural properties of an interface, such as element names, hierarchy, and domain types. A `ConnectionBus` object is similar to a cable connector. The connector defines all the pins and their configuration and controls what types of wires can be connected to it. Similarly, a `ConnectionBus` object defines the configuration and domain types of the ports of the associated Simscape Bus or Connection Port blocks.

`ConnectionBus` objects contain `Simulink.ConnectionElement` objects. Each `ConnectionElement` object specifies the properties of a port in a connection bus, such as its name and domain type. To create nested connection buses, specify a `ConnectionElement` on the parent bus and set its type as the child `ConnectionBus` object.

To create and modify `ConnectionBus` objects in the base workspace or a data dictionary, you can use the **Bus Editor**, the **Model Explorer**, or MATLAB commands. You cannot store `ConnectionBus` objects in model workspaces.

To simulate a model containing blocks that use a `ConnectionBus` object, that `ConnectionBus` object must be in the base workspace or in a data dictionary. You save and load `ConnectionBus` objects similar to `Simulink.Bus` objects. For more information, see “Determine How to Manage `Simulink.Bus` Objects”.

To apply an existing connection bus specification to a Simscape Bus or Connection Port block, use the **Connection type** parameter and select the bus name from the drop-down list.

Creation

Syntax

```
name = Simulink.ConnectionBus
```

Description

`name = Simulink.ConnectionBus` returns a `ConnectionBus` object with default property values. The name of the `ConnectionBus` object is the name of the MATLAB variable to which you assign the `ConnectionBus` object.

Properties

Description — Connection bus description

' ' (default) | character vector

Connection bus description, specified as a character vector. Use the description to document information about the `ConnectionBus` object, such as the application it is used for or domain types of its ports. This information does not affect Simulink processing.

Data Types: `char` | `string`

Elements — Elements of connection bus

empty array (default) | array of `Simulink.ConnectionElement` objects

Elements of connection bus, specified as an array of `Simulink.ConnectionElement` objects. Each `ConnectionElement` object defines the properties of a conserving connection within the bus, such as its name and domain type. For more information, see `Simulink.ConnectionElement`.

Examples

Create Connection Bus and Connection Element Objects Using MATLAB Commands

Define a rigid interface with one mechanical translational and one electrical port by creating a `ConnectionBus` object containing a two-element array of `ConnectionElement` objects. Array indexing lets you create and access multiple elements in an array. Dot notation lets you access property values.

Create a `ConnectionBus` object called `MechElec`:

```
MechElec = Simulink.ConnectionBus
```

```
MechElec =
```

```
ConnectionBus with properties:
```

```
Description: ''
Elements: [0x0 Simulink.ConnectionElement]
```

By default, the connection bus has no description and an empty array of connection elements.

Use the dot notation to fill in the description:

```
MechElec.Description = 'Rigid interface with one mechanical and one electrical port'
```

```
MechElec =
```

```
ConnectionBus with properties:
```

```
Description: 'Rigid interface with one mechanical and one electrical port'
Elements: [0x0 Simulink.ConnectionElement]
```

Create a `ConnectionElement` object to define the mechanical translational port:

```
mech = Simulink.ConnectionElement
```

```

mech =

  ConnectionElement with properties:

      Name: 'a'
      Type: 'Connection: <domain name>'
      Description: ''

```

This command creates a `ConnectionElement` object with default properties.

Change the `ConnectionElement` name to `mech`:

```
mech.Name = 'mech'
```

```

mech =

  ConnectionElement with properties:

      Name: 'mech'
      Type: 'Connection: <domain name>'
      Description: ''

```

Specify the domain type for the connection:

```
mech.Type = 'Connection: foundation.mechanical.translational.translational'
```

```

mech =

  ConnectionElement with properties:

      Name: 'mech'
      Type: 'Connection: foundation.mechanical.translational.translational'
      Description: ''

```

For a list of Foundation domain types, see “Domain-Specific Line Styles” (Simscape).

Optionally, fill in the port description:

```
mech.Description = 'Mechanical translational port'
```

```

mech =

  ConnectionElement with properties:

      Name: 'mech'
      Type: 'Connection: foundation.mechanical.translational.translational'
      Description: 'Mechanical translational port'

```

Similarly, create another `ConnectionElement` object to define the electrical port:

```

elec = Simulink.ConnectionElement;
elec.Name = 'elec';
elec.Type = 'Connection: foundation.electrical.electrical';
elec.Description = 'Electrical port'

```

```

elec =

  ConnectionElement with properties:

      Name: 'elec'

```

```
Type: 'Connection: foundation.electrical.electrical'  
Description: 'Electrical port'
```

Add the two elements to the `ConnectionBus` object:

```
MechElec.Elements = [mech elec]
```

```
MechElec =
```

```
ConnectionBus with properties:
```

```
Description: 'Rigid interface containing one mechanical and one electrical port'  
Elements: [2x1 Simulink.ConnectionElement]
```

You can view the created objects in the **Bus Editor**:

```
buseditor
```

Alternatives

To interactively create a `ConnectionBus` object, use the **Bus Editor** or the **Model Explorer**.

See Also

Tools

Bus Editor

Objects

`Simulink.ConnectionElement` | `Simulink.Bus` | `Simulink.BusElement`

Topics

“Design Rigid Interface Specifications for Conserving Connections” (Simscape)

Introduced in R2021b

Simulink.ConnectionElement

Specify properties of elements of physical connection buses

Description

A `Simulink.ConnectionElement` object is an element of a `Simulink.ConnectionBus` object. It validates the properties of a physical connection port.

`ConnectionElement` objects exist only within the `ConnectionBus` object. You can specify a `ConnectionBus` object, but not a `ConnectionElement` object, as a data type.

When you simulate or update a model, Simulink checks whether the ports connected to Simscape Bus or Connection Port blocks with rigid interface specifications match the properties of the corresponding `ConnectionElement` objects.

To create and modify `ConnectionBus` and `ConnectionElement` objects in the base workspace or a data dictionary, you can use the **Bus Editor**, the **Model Explorer**, or MATLAB commands. You cannot store `ConnectionBus` and `ConnectionElement` objects in model workspaces.

Creation

Syntax

```
ce = Simulink.ConnectionElement
```

Description

`ce = Simulink.ConnectionElement` returns a `ConnectionElement` object with default property values.

Properties

Name — Name of element

'a' (default) | character vector

Name of element, specified as a character vector. The element name must be a valid MATLAB identifier that starts with an alphabetic character or underscore (`_`), followed by alphanumeric characters or underscores.

Data Types: `char` | `string`

Type — Connection type of element

'Connection: <domain name>' (default) | registered Simscape domain | Simscape Multibody conserving connection type | `ConnectionBus` object present in the base workspace or a data dictionary

Connection type of element, specified as a Simscape Foundation domain name, a custom domain name registered in your MATLAB session, or a Simscape Multibody conserving connection type.

For a list of Foundation domains, see “Domain-Specific Line Styles” (Simscape).

Selecting a `ConnectionBus` object present in the base workspace or a data dictionary lets you create nested connection buses.

If you create `ConnectionElement` objects interactively, by using the **Bus Editor** or the **Model Explorer**, the drop-down list automatically contains all the valid domain and connection types.

Data Types: `char` | `string`

Description — Connection element description

`''` (default) | character vector

Connection element description, specified as a character vector. Use the description to document information about the `ConnectionElement` object, such as the domain type. This information does not affect Simulink processing.

Data Types: `char` | `string`

Examples

Create Connection Bus and Connection Element Objects Using MATLAB Commands

Define a rigid interface with one mechanical translational and one electrical port by creating a `ConnectionBus` object containing a two-element array of `ConnectionElement` objects. Array indexing lets you create and access multiple elements in an array. Dot notation lets you access property values.

Create a `ConnectionBus` object called `MechElec`:

```
MechElec = Simulink.ConnectionBus
```

```
MechElec =
```

```
ConnectionBus with properties:
```

```
  Description: ''  
  Elements: [0x0 Simulink.ConnectionElement]
```

By default, the connection bus has no description and an empty array of connection elements.

Use the dot notation to fill in the description:

```
MechElec.Description = 'Rigid interface with one mechanical and one electrical port'
```

```
MechElec =
```

```
ConnectionBus with properties:
```

```
  Description: 'Rigid interface with one mechanical and one electrical port'  
  Elements: [0x0 Simulink.ConnectionElement]
```

Create a `ConnectionElement` object to define the mechanical translational port:

```
mech = Simulink.ConnectionElement
```



```

mech =

ConnectionElement with properties:

    Name: 'a'
    Type: 'Connection: <domain name>'
    Description: ''

```

This command creates a `ConnectionElement` object with default properties.

Change the `ConnectionElement` name to `mech`:

```
mech.Name = 'mech'
```

```

mech =

ConnectionElement with properties:

    Name: 'mech'
    Type: 'Connection: <domain name>'
    Description: ''

```

Specify the domain type for the connection:

```
mech.Type = 'Connection: foundation.mechanical.translational.translational'
```

```

mech =

ConnectionElement with properties:

    Name: 'mech'
    Type: 'Connection: foundation.mechanical.translational.translational'
    Description: ''

```

For a list of Foundation domain types, see “Domain-Specific Line Styles” (Simscape).

Optionally, fill in the port description:

```
mech.Description = 'Mechanical translational port'
```

```

mech =

ConnectionElement with properties:

    Name: 'mech'
    Type: 'Connection: foundation.mechanical.translational.translational'
    Description: 'Mechanical translational port'

```

Similarly, create another `ConnectionElement` object to define the electrical port:

```

elec = Simulink.ConnectionElement;
elec.Name = 'elec';
elec.Type = 'Connection: foundation.electrical.electrical';
elec.Description = 'Electrical port'

```

```

elec =

ConnectionElement with properties:

    Name: 'elec'

```

```
Type: 'Connection: foundation.electrical.electrical'  
Description: 'Electrical port'
```

Add the two elements to the `ConnectionBus` object:

```
MechElec.Elements = [mech elec]
```

```
MechElec =
```

```
ConnectionBus with properties:
```

```
Description: 'Rigid interface containing one mechanical and one electrical port'  
Elements: [2x1 Simulink.ConnectionElement]
```

You can view the created objects in the **Bus Editor**:

```
buseditor
```

Alternatives

To interactively create a `ConnectionElement` object, use the **Bus Editor** or the **Model Explorer**.

See Also

Tools

Bus Editor

Objects

`Simulink.ConnectionBus` | `Simulink.Bus` | `Simulink.BusElement`

Topics

“Design Rigid Interface Specifications for Conserving Connections” (Simscape)

Introduced in R2021b

FunctionPortSpecification

Query and configure C Caller block properties

Description

Query and configure the C Caller block function definition and return argument. Configure the C Caller block input arguments programmatically.

Creation

`myCCallerObj = get_param(gcb, 'FunctionPortSpecification')` creates a C Caller block configuration object for the selected C Caller block.

Properties

CPrototype — C function mapping to the C Caller block

character vector

Displays the mapping of the C function input to the C Caller block in the model. You cannot edit this property using the command line. To edit the C function mapping, edit the source code of the C Caller block.

Example: `real_T add(real_T u1, real_T u2);`

Data Types: char

InputArguments — List of function input arguments

FunctionArgument object

Returns the list of function input arguments in a “FunctionArgument Object” on page 8-41.

ReturnArgument — List of function output arguments

FunctionArgument scalar

Returns a scalar or an empty “FunctionArgument Object” on page 8-41.

Data Types: char

GlobalArguments — List of global arguments

FunctionArgument scalar

Returns a scalar or an empty “FunctionArgument Object” on page 8-41.

Data Types: char

FunctionArgument Object

The `FunctionArgument` is a class that carries port specification information of a C Caller block programmatically. The `FunctionArgument` object has these properties:

- 1 **Name** — Name of the variable in the source code, specified as a character vector. This property is read-only.
- 2 **PortNumber** — Port number of the InputArgument that has been edited, specified as uint32. This property is read-only.
- 3 **Size** — Size of the Simulink port dimensions specified as a character vector. You can edit this property if it is allowed in the function definition.
- 4 **Type** — Simulink data type for the specified port specified as a character vector. You can edit this property if it is allowed in the function definition.
- 5 **Label** — Port label on the Simulink block specified as a character vector. You can change the port label programmatically, for example:

```
myCCallerObj.my_CCaller.InputArguments(1).Label = 'inputport1'
```

```
my_CCallerObj =
```

```
FunctionPortSpecification with properties:
```

```
    CPrototype: 'real_T add(real_T u1, real_T u2);'
  InputArguments: [1x2 Simulink.CustomCode.FunctionArgument]
  ReturnArgument: [1x1 Simulink.CustomCode.FunctionArgument]
  GlobalArguments: [1x0 Simulink.CustomCode.FunctionArgument]
```

- 6 **Scope** — Mapping of the Simulink scope to the input argument specified as a character vector. If the variable is defined as a constant qualifier, the argument can be an input or a parameter. If no constant qualifier exists, you can change an output argument to an input, inputoutput, or to a parameter. If your scope fits any of the scenarios above, you can change it programmatically:

```
my_CCallerObj.InputArguments(1).Scope = 'parameter'
```

```
my_CCallerObj =
```

```
FunctionPortSpecification with properties:
```

```
    CPrototype: 'extern real_T add(real_T u1, real_T u2);'
  InputArguments: [1x2 Simulink.CustomCode.FunctionArgument]
  ReturnArgument: [1x1 Simulink.CustomCode.FunctionArgument]
  GlobalArguments: [1x0 Simulink.CustomCode.FunctionArgument]
```

Object Functions

`getGlobalArg` Get an object definition of a global variable in a C Caller block

Examples

Create a C Caller Configuration Object

This example creates a C Caller configuration object using the 'slexCCallerExample' demo model.

```
my_CCallerObj = get_param('slexCCallerExample/C Caller','FunctionPortSpecification')
```

```
my_CCallerObj =
```

```
FunctionPortSpecification with properties:
```

```
    CPrototype: 'real_T add(real_T u1, real_T u2);'
```

```

InputArguments: [1x2 Simulink.CustomCode.FunctionArgument]
ReturnArgument: [1x1 Simulink.CustomCode.FunctionArgument]
GlobalArguments: [1x0 Simulink.CustomCode.FunctionArgument]

```

Create a `FunctionArgument` object for the 1st input port:

```

inargone = my_CCallerObj.InputArguments(1)
inargone =

```

FunctionArgument with properties:

```

    Name: 'u1'
PortNumber: 1
    Size: '1'
    Type: 'double'
    Label: 'u1'
    Scope: 'Parameter'

```

Change the label for the first input port:

```

inargone.Label = 'inputport1'
inargone =

```

FunctionArgument with properties:

```

    Name: 'u1'
PortNumber: 1
    Size: '1'
    Type: 'double'
    Label: 'inputport1'
    Scope: 'Parameter'

```

See Also

C Caller | `MATLABFunctionConfiguration`

Topics

“Call C Functions Using C Caller Block” on page 13-528

“Integrate C Code Using C Caller Blocks”

Introduced in R2019b

Simulink.data.dictionary.Entry

Configure data dictionary entry

Description

An object of the `Simulink.data.dictionary.Entry` class represents one entry of a data dictionary. The object allows you to perform operations such as assign the entry a value or change the name of the entry.

Before you can create a new `Simulink.data.dictionary.Entry` object, you must create a `Simulink.data.dictionary.Section` object representing the data dictionary section that contains the target entry. However, once created, the `Simulink.data.dictionary.Entry` object exists independently of the `Simulink.data.dictionary.Section` object. Use the function `getSection` to create a `Simulink.data.dictionary.Section` object.

Creation

Syntax

Description

The functions `addEntry`, `getEntry`, and `find` create `Simulink.data.dictionary.Entry` objects.

Properties

DataSource — File name of containing data dictionary

character vector

File name of containing data dictionary, specified as a character vector. Changes you make to this property affect the represented data dictionary entry.

Example: `'myDictionary.sldd'`

Data Types: `char`

LastModified — Date and time of last modification

character vector

Date and time of last modification to entry, returned in Coordinated Universal Time (UTC) as a character vector. This property is read only.

LastModifiedBy — Name of last user to modify entry

character vector

Name of last user to modify entry, returned as a character vector. This property is read only.

Name — Name of entry

character vector

Name of entry, specified as a character vector. Changes you make to this property affect the represented data dictionary entry.

Data Types: char

Status — State of entry

'New' | 'Modified' | 'Unchanged' | 'Deleted'

State of entry, returned as 'New', 'Modified', 'Unchanged', or 'Deleted'. The state is valid since the last data dictionary save. If the state is 'Deleted', the represented entry was deleted from its data dictionary. This property is read only.

Object Functions

| | |
|----------------|---|
| deleteEntry | Delete data dictionary entry |
| discardChanges | Discard changes to data dictionary entry |
| find | Search in array of data dictionary entries |
| getValue | Return value of data dictionary entry |
| setValue | Set value of data dictionary entry |
| showChanges | Display changes made to data dictionary entry |

Examples

Add Entry to Data Dictionary and Modify its Value

Represent the Design Data section of the data dictionary `myDictionary_ex_API.sldd` with a `Simulink.data.dictionary.Section` object named `dDataSectObj`.

```
myDictionaryObj = Simulink.data.dictionary.open('myDictionary_ex_API.sldd');
dDataSectObj = getSection(myDictionaryObj, 'Design Data');
```

Add an entry `myEntry` with value 27 to the Design Data section of `myDictionary_ex_API.sldd`. Assign the returned `Simulink.data.dictionary.Entry` object to variable `e`.

```
e = addEntry(dDataSectObj, 'myEntry', 27)
```

```
e =
```

Entry with properties:

```

        Name: 'myEntry'
        Value: 27
        DataSource: 'myDictionary_ex_API.sldd'
        LastModified: '2014-Aug-26 18:42:08.439709'
        LastModifiedBy: 'jsmith'
        Status: 'New'
```

Change the value of `myEntry` from 27 to the character vector 'My New Value'.

```
setValue(e, 'My New Value')
```

```
e
```

```
e =
```

Entry with properties:

```

        Name: 'myEntry'
        Value: 'My New Value'
        DataSource: 'myDictionary_ex_API.sldd'
        LastModified: '2014-Aug-26 18:45:58.336598'
        LastModifiedBy: 'jsmith'
        Status: 'New'

```

Return Value of Data Dictionary Entry

Represent the data dictionary entry `fuelFlow` with a `Simulink.data.dictionary.Entry` object named `fuelFlowObj`. `fuelFlow` is defined in the data dictionary `myDictionary_ex_API.sldd`.

```

myDictionaryObj = Simulink.data.dictionary.open('myDictionary_ex_API.sldd');
dDataSectObj = getSection(myDictionaryObj, 'Design Data');
fuelFlowObj = getEntry(dDataSectObj, 'fuelFlow');

```

Return the value of the entry `fuelFlow` and assign the value to the variable `fuelFlowValue`.

```
fuelFlowValue = getValue(fuelFlowObj)
```

```
fuelFlowValue =
```

```
237
```

Move Entry Within Data Dictionary Hierarchy

Represent the Design Data section of the data dictionary `myDictionary_ex_API.sldd` with a `Simulink.data.dictionary.Section` object named `dDataSectObj`. `myDictionary_ex_API.sldd` references the data dictionary `myRefDictionary_ex_API.sldd`.

```

myDictionaryObj = Simulink.data.dictionary.open('myDictionary_ex_API.sldd');
dDataSectObj = getSection(myDictionaryObj, 'Design Data');

```

Create a `Simulink.data.dictionary.Entry` object representing the entry `fuelFlow`, which resides in `myDictionary_ex_API.sldd`. Assign the object to variable `e`.

```
e = getEntry(dDataSectObj, 'fuelFlow')
```

```
e =
```

```
Entry with properties:
```

```

        Name: 'fuelFlow'
        Value: 237
        DataSource: 'myDictionary_ex_API.sldd'
        LastModified: '2014-Sep-05 13:12:06.099278'
        LastModifiedBy: 'jsmith'
        Status: 'Unchanged'

```

Migrate the entry `fuelFlow` to the reference data dictionary `myRefDictionary_ex_API.sldd` by modifying the `DataSource` property of `e`.

```
e.DataSource = 'myRefDictionary_ex_API.sldd'
```

```
e =
```

```
Entry with properties:
```



```
Name: 'fuelFlow'  
Value: 237  
DataSource: 'myRefDictionary_ex_API.sldd'  
LastModified: '2014-Sep-05 13:12:06.099278'  
LastModifiedBy: 'jsmith'  
Status: 'Modified'
```

Because `myDictionary_ex_API.sldd` references `myRefDictionary_ex_API.sldd`, both dictionaries belong to the same dictionary hierarchy, allowing you to migrate the entry `fuelFlow` between them.

See Also

`Simulink.data.dictionary.Section` | `getEntry` | `Simulink.data.Dictionary`

Topics

“Store Data in Dictionary Programmatically”
“What Is a Data Dictionary?”

Introduced in R2015a

Simulink.data.dictionary.EnumTypeDefinition

Store enumerated type definition in data dictionary

Description

A `Simulink.data.dictionary.EnumTypeDefinition` object defines an enumerated data type in a data dictionary. You store the object in a data dictionary entry so models linked to the dictionary can use the enumerated type definition.

In the MATLAB base workspace, `Simulink.data.dictionary.EnumTypeDefinition` objects retain information about an enumerated type but do not define the type for use by other variables or by models.

Creation

Syntax

```
Simulink.data.dictionary.EnumTypeDefinition
```

Description

When you use the function `importEnumTypes` to import the definitions of enumerated types to a data dictionary, Simulink creates a `Simulink.data.dictionary.EnumTypeDefinition` object in the dictionary for each imported definition. The dictionary stores each object in an individual entry.

The `Simulink.data.dictionary.EnumTypeDefinition` function creates a `Simulink.data.dictionary.EnumTypeDefinition` object with default property values and a single enumeration member that has underlying integer value 0.

Properties

AddClassNameToEnumNames — Flag to control enumeration identifiers in generated code

`false` (default) | `true`

Flag to prefix enumerations with the class name in generated code, specified as `true` or `false`.

If you specify `true`, when you generate code the identifier of each enumeration member begins with the name of the enumeration class. For example, an enumeration class `LEDcolor` with enumeration members `GREEN` and `RED` defines the enumeration members in generated code as `LEDcolor_GREEN` and `LEDcolor_RED`.

Data Types: `logical`

DataScope — Flag to control data type definition in generated code

`'Auto'` (default) | `'Imported'` | `'Exported'`

Flag to control data type definition in generated code, specified as `'Auto'`, `'Imported'`, or `'Exported'`. The table describes the behavior of generated code for each value.

| Value | Action |
|----------------|--|
| Auto (default) | <p>If you do not specify the property <code>Headerfile</code>, export the data type definition to <code>model_types.h</code>, where <code>model</code> is the model name.</p> <p>If you specify <code>Headerfile</code>, import the data type definition from the specified header file.</p> |
| Exported | <p>Export the data type definition to a separate header file.</p> <p>If you do not specify the property <code>Headerfile</code>, the header file name defaults to <code>type.h</code>, where <code>type</code> is the data type name.</p> |
| Imported | <p>Import the data type definition from a separate header file.</p> <p>If you do not specify the property <code>Headerfile</code>, the header file name defaults to <code>type.h</code>, where <code>type</code> is the data type name.</p> |

DefaultValue — Default enumeration member

' ' (default) | character vector

Default enumeration member, specified as a character vector. Specify `DefaultValue` as the name of an enumeration member you have already defined.

When you create a `Simulink.data.dictionary.EnumTypeDefinition` object, `DefaultValue` is an empty character vector, ' ', and Simulink uses the first enumeration member as the default member.

Example: 'enumMember1'

Description — Description of enumerated data type in generated code

' ' (default) | character vector

Description of the enumerated data type, specified as a character vector. Use this property to explain the purpose of the type in generated code.

Example: 'Two possible colors of LED indicator: GREEN and RED.'

Data Types: char

HeaderFile — Name of header file defining enumerated data type in generated code

' ' (default) | character vector

Name of the header file that defines the enumerated data type in generated code, specified as a character vector. Use a `.h` extension to specify the file name.

If you do not specify `HeaderFile`, generated code uses a default header file name that depends on the value of the `DataScope` property.

Example: 'myTypeIncludeFile.h'

Data Types: char

StorageType — Data type of underlying integer values

' ' (default) | character vector

Data type of the integer values underlying the enumeration members, specified as a character vector. Generated code stores the underlying integer values using the data type you specify.

You can specify one of these supported integer types:

- 'int8'
- 'int16'
- 'int32'
- 'uint8'
- 'uint16'

To store the underlying integer values in generated code using the native integer type of the target hardware, specify `StorageType` as an empty character vector, `' '`, which is the default value.

Example: `'int16'`

' '

Object Functions

`appendEnumeral` Add enumeration member to enumerated data type definition in data dictionary
`removeEnumeral` Remove enumeration member from enumerated data type definition in data dictionary

Examples**Programmatically Create Enumerated Type Definition in Data Dictionary**

Create an object that can store the definition of an enumerated type. By default, the new type defines a single enumeration member `enum1` with underlying integer value 0.

```
myColors = Simulink.data.dictionary.EnumTypeDefinition
```

```
myColors =
```

```
    Simulink.data.dictionary.EnumTypeDefinition
        enum1
```

Add some enumeration members to the definition of the type.

```
appendEnumeral(myColors, 'Orange', 1, '')
```

```
appendEnumeral(myColors, 'Black', 2, '')
```

```
appendEnumeral(myColors, 'Cyan', 3, '')
```

```
myColors
```

```
myColors =
```

```
    Simulink.data.dictionary.EnumTypeDefinition
        enum1
        Orange
        Black
        Cyan
```

Remove the default enumeration member `enum1`. Since `enum1` is the first enumeration member in the list, identify it with index 1.

```
removeEnumeral(myColors,1)
myColors
myColors =
    Simulink.data.dictionary.EnumTypeDefinition
    Orange
    Black
    Cyan
```

Customize the enumerated type by configuring the properties of the object representing it.

```
myColors.Description = 'These are my favorite colors.';
myColors.DefaultValue = 'Cyan';
myColors.HeaderFile = 'colorsType.h';
```

Open the data dictionary `myDictionary_ex_API.sldd` and represent it with a `Simulink.data.Dictionary` object named `myDictionaryObj`.

```
myDictionaryObj = Simulink.data.dictionary.open('myDictionary_ex_API.sldd');
```

Import the object that defines the enumerated type `myColors` to the dictionary.

```
importFromBaseWorkspace(myDictionaryObj, 'varList', {'myColors'});
```

Alternatives

You can use Model Explorer to add and modify enumerated data types stored in a data dictionary.

See Also

`Simulink.data.Dictionary` | enumeration

Topics

“Store Data in Dictionary Programmatically”

“Use Enumerated Data in Simulink Models”

Introduced in R2015a

Simulink.data.dictionary.Section

Configure data dictionary section

Description

An object of the `Simulink.data.dictionary.Section` class represents one section of a data dictionary, such as Design Data or Configurations. The object allows you to perform operations on the section such as add or delete entries and import data from files.

Before you can create a `Simulink.data.dictionary.Section` object, you must create a `Simulink.data.Dictionary` object representing the target data dictionary. Once created, the `Simulink.data.dictionary.Section` object exists independently of the `Simulink.data.Dictionary` object.

You cannot use the data dictionary programmatic interface (see “Store Data in Dictionary Programmatically”) to access the **Embedded Coder** section of a data dictionary. Instead, see Embedded Coder Dictionary (Embedded Coder).

Creation

Syntax

Description

The function `getSection` creates a `Simulink.data.dictionary.Section` object.

Properties

Name — Name of data dictionary section

character vector

Name of data dictionary section, returned as a character vector. This property is read only.

Object Functions

| | |
|-----------------------------|--|
| <code>addEntry</code> | Add new entry to data dictionary section |
| <code>assignin</code> | Assign value to data dictionary entry |
| <code>deleteEntry</code> | Delete data dictionary entry |
| <code>evalin</code> | Evaluate MATLAB expression in data dictionary section |
| <code>exist</code> | Check existence of data dictionary entry |
| <code>exportToFile</code> | Export data dictionary entries from section to MAT-file or MATLAB file |
| <code>find</code> | Search in data dictionary section |
| <code>getEntry</code> | Create <code>Simulink.data.dictionary.Entry</code> object to represent data dictionary entry |
| <code>importFromFile</code> | Import variables from MAT-file or MATLAB file to data dictionary section |

Examples

Create New Data Dictionary Section Object

Open the data dictionary `myDictionary_ex_API.sldd` and represent it with a `Simulink.data.Dictionary` object named `myDictionaryObj`.

```
myDictionaryObj = Simulink.data.dictionary.open('myDictionary_ex_API.sldd');
```

Represent the Design Data section of the data dictionary `myDictionary_ex_API.sldd` with a `Simulink.data.dictionary.Section` object named `dDataSectObj`.

```
dDataSectObj = getSection(myDictionaryObj, 'Design Data')
```

```
dDataSectObj =
```

```
    Section with properties:
```

```
        Name: 'Design Data'
```

See Also

[getSection](#) | [Simulink.data.Dictionary](#)

Topics

“Store Data in Dictionary Programmatically”

“What Is a Data Dictionary?”

Introduced in R2015a

Simulink.data.Dictionary

Configure data dictionary

Description

A `Simulink.data.Dictionary` object represents a data dictionary. The object allows you to perform operations on the data dictionary such as save or discard changes, import data from the base workspace, and add other data dictionaries as references.

Creation

The functions `Simulink.data.dictionary.create` and `Simulink.data.dictionary.open` create a `Simulink.data.Dictionary` object.

Properties

DataSources — Referenced data dictionaries

cell array of character vectors

This property is read-only.

Referenced data dictionaries by file name, returned as a cell array of character vectors. This property only lists directly referenced dictionaries whose parent is the `Simulink.data.Dictionary` object.

EnableAccessToBaseWorkspace — Specify whether models can use design data in the base workspace

`false` (default) | `true`

Whether linked models can use design data in the base workspace, specified as `true` or `false`.

To determine whether a dictionary provides access to the base workspace (including through referenced dictionaries), query the `HasAccessToBaseWorkspace` property.

For more information about this property, including restrictions that limit your ability to interact with base workspace data through the dictionary, see “Continue to Use Shared Data in the Base Workspace”.

Data Types: `logical`

HasAccessToBaseWorkspace — Query whether models can use design data in the base workspace

`0` (default) | `1`

This property is read-only.

Query whether models can use design data in the base workspace, returned as `1` (true) or `0` (false). If the dictionary or a referenced dictionary has the `EnableAccessToBaseWorkspace` property set to `true`, this property returns `1`.

Use this property to determine whether models that link to the dictionary can use design data in the base workspace. You do not need to query each referenced dictionary to determine whether it has the `EnableAccessToBaseWorkspace` property set to `true`.

Data Types: `logical`

HasUnsavedChanges — Indicator of unsaved changes

0 | 1

This property is read-only.

Indicator of unsaved changes to the data dictionary, returned as 0 or 1. The value is 1 if changes have been made since last data dictionary save and 0 if not.

NumberOfEntries — Total number of entries in data dictionary

integer

This property is read-only.

Total number of entries in data dictionary, including those in referenced dictionaries, returned as an integer.

Object Functions

| | |
|--------------------------------------|--|
| <code>addDataSource</code> | Add reference data dictionary to parent data dictionary |
| <code>close</code> | Close connection between data dictionary and <code>Simulink.data.Dictionary</code> object |
| <code>discardChanges</code> | Discard changes to data dictionary |
| <code>exportToVersion</code> | Export a <code>Simulink.data.Dictionary</code> object to a previous version |
| <code>filepath</code> | Full path and file name of data dictionary |
| <code>getSection</code> | Return <code>Simulink.data.dictionary.Section</code> object to represent data dictionary section |
| <code>hide</code> | Remove data dictionary from Model Explorer |
| <code>importEnumTypes</code> | Import enumerated type definitions to data dictionary |
| <code>importFromBaseWorkspace</code> | Import base workspace variables to data dictionary |
| <code>listEntry</code> | List data dictionary entries |
| <code>removeDataSource</code> | Remove reference data dictionary from parent data dictionary |
| <code>saveChanges</code> | Save changes to data dictionary |
| <code>show</code> | Show data dictionary in Model Explorer |

Examples

Create New Data Dictionary and Data Dictionary Object

Create a data dictionary file `myNewDictionary.sldd` and a `Simulink.data.Dictionary` object representing the new data dictionary. Assign the object to variable `ddl`.

```
ddl = Simulink.data.dictionary.create('myNewDictionary.sldd')
```

```
ddl =
```

```
data dictionary with properties:
```

```
    DataSources: {0x1 cell}
```

```
HasUnsavedChanges: 0  
  NumberOfEntries: 0
```

Open Existing Data Dictionary

Create a `Simulink.data.Dictionary` object representing the existing data dictionary `myDictionary_ex_API.sldd`. Assign the object to variable `dd2`.

```
dd2 = Simulink.data.dictionary.open('myDictionary_ex_API.sldd')
```

```
dd2 =
```

```
Dictionary with properties:
```

```
  DataSources: {'myRefDictionary_ex_API.sldd'}  
HasUnsavedChanges: 0  
  NumberOfEntries: 4
```

See Also

`Simulink.data.dictionary.open` | `Simulink.data.dictionary.create` |
`Simulink.data.dictionary.Section` | `Simulink.data.dictionary.Entry`

Topics

“Store Data in Dictionary Programmatically”

“What Is a Data Dictionary?”

Introduced in R2015a

Simulink.FindOptions

Specify options for finding blocks in models and subsystems

Description

Simulink.FindOptions objects allow you to constrain a search with the Simulink.findBlocks and Simulink.findBlocksOfType functions.

Creation

Syntax

```
f = Simulink.FindOptions
f = Simulink.FindOptions(Name,Value)
```

Description

f = Simulink.FindOptions creates a FindOptions object that uses the default search options.

f = Simulink.FindOptions(Name,Value) sets properties on page 8-57 using name-value pairs. For example, Simulink.FindOptions('SearchDepth',1) creates a FindOptions object with a search depth of 1. You can specify multiple name-value pairs. Enclose each property name in single quotes.

Properties

CaseSensitive — Option to match case when searching

true (default) | false

Option to match case when searching, specified as true for case-sensitive search or false for case-insensitive search.

Data Types: logical

FollowLinks — Option for search to follow library links

false (default) | true

Option for search to follow library links, specified as true or false. If true, search follows links into library blocks.

Data Types: logical

IncludeCommented — Option for search to include commented blocks

true (default) | false

Option for search to include commented blocks, specified as true or false.

Data Types: logical

LookUnderMasks — Options to search masked blocks`'all'` (default) | `'none'` | `'functional'` | `'graphical'`

Options to search masked blocks, specified as:

- `'all'` — Search in all masked blocks.
- `'none'` — Prevent searching in masked systems.
- `'functional'` — Include masked subsystems that do not have dialogs.
- `'graphical'` — Include masked subsystems that do not have workspaces or dialogs.

Data Types: `char` | `string`**Variants — Options to search variant subsystems**`'AllVariants'` (default) | `'ActiveVariants'` | `'ActivePlusCodeVariants'`

Note The `Variants` argument will be removed. Use `MatchFilter` instead. For more information, see [Compatibility Considerations on page 8-60](#).

Options to search variant subsystems, specified as:

- `'AllVariants'` — Search all variant choices.
- `'ActiveVariants'` — Search only active variant choices.
- `'ActivePlusCodeVariants'` — Search all variant choices in the Variant Subsystem that are active in simulation and is part of the generated code.

This search constraint applies only to Variant Subsystem blocks that have the **Variant control mode** set to `expression` or `label`. Use the `Simulink.FindOptions` object with the `MatchFilter` option to operate on all types of variant blocks.

Data Types: `char` | `string`**MatchFilter — Function handle to match elements**

function handle

Function handle to match elements in a search, such as blocks, system, lines, ports, and annotations. Use `MatchFilter` to determine whether elements should be included or skipped in a search.

The named function must be defined within a MATLAB program file. The function takes the handle of the element as input and returns two outputs.

```
function [match, prune] = func(element)
```

- The input `element` is the handle of the block being processed.
- The first output, `match`, is a logical value. If `false`, search skips the element.
- The second output, `prune`, is an optional logical value that only applies when `element` is a subsystem. The default value is `false`. If this value is set to `true`, the entire subsystem is omitted from the search.

Example: Use `MatchFilter` to find all Gain blocks in the model `vdp` with a gain value between 1 and 10.

```

function match = gainOneToTen(blk)
match = false;
if strcmp(get_param(blk, 'Type'), 'block') ...
    && strcmp(get_param(blk, 'BlockType'), 'Gain')
    gainValue = str2double(get_param(blk, 'Gain'));
    match = gainValue >= 1 && gainValue <= 10;
end
end

load_system('vdp');
findOptObj = Simulink.FindOptions('MatchFilter', @gainOneToTen);
blks=getfullname((Simulink.findBlocks('vdp', findOptObj)));

```

Variants: Simulink provides `Simulink.match.activeVariants` and `Simulink.match.codeCompileVariants` match filter functions for variant blocks, which you can use to find active variants or code compile variant blocks. To do so, compile the model and apply the appropriate `MatchFilter` options:

- `Simulink.match.activeVariants` - Matches blocks that are active in simulation after model compilation
- `Simulink.match.codeCompileVariants` - Matches blocks that are part of generated code after model compilation

Example: Use the `Simulink.match.activeVariants` option to find active variants in a model:

```

addpath(fullfile(matlabroot, 'examples', 'simulink_variants', 'main'));
model='sldemo_variant_subsystems';
load_system(model);
assignin('base', 'VSS_MODE', 2);
set_param(model, 'SimulationCommand', 'update');
findOptObj = Simulink.FindOptions('MatchFilter', @Simulink.match.activeVariants);
blks=getfullname((Simulink.findBlocks(model, findOptObj)))

```

Example: Use the `Simulink.match.codeCompileVariants` option to find variant choices that are part of the generated C code:

```

addpath(fullfile(matlabroot, 'examples', 'simulink_variants', 'main'));
load_system('sldemo_variant_subsystems');
assignin('base', 'VSS_MODE', 2);
sldemo_variant_subsystems([], [], [], 'compileForCodegen');
findOptObj = Simulink.FindOptions('MatchFilter', @Simulink.match.codeCompileVariants);
blks=getfullname((Simulink.findBlocks('sldemo_variant_subsystems', findOptObj)));
sldemo_variant_subsystems([], [], [], 'term');

```

RegExp — Option to treat search text as regular expression

false (default) | true

Option to treat search text as a regular expression, specified as true or false. To learn more about MATLAB regular expressions, see “Regular Expressions”.

Data Types: logical

SearchDepth — Levels in model to search

-1 (default) | positive integer

Levels in model to search, specified as a positive integer. The default (-1) is to search all levels. Specify:

- 1 — Search in the top-level system.
- 2 — Search the top-level system and its children, 3 to search an additional level, and so on.

Data Types: int32

Examples

Specify Search Options

Create a `Simulink.FindOptions` object that specifies a search depth of 1.

```
f = Simulink.FindOptions('SearchDepth',1);
```

Using the `FindOptions` object, search for all blocks in the subsystem named `Unlocked`, but not in any of its children.

```
openExample('sldemo_clutch');
bh = Simulink.findBlocks('sldemo_clutch/Unlocked',f);
```

The `Simulink.findBlocks` function returns the block handles.

To get the block path, use the `getfullname` function.

```
bp = getfullname(bh)
```

```
bp =
```

```
20x1 cell array
```

```
{'sldemo_clutch/Unlocked/Tfmaxk' }
{'sldemo_clutch/Unlocked/Tin' }
{'sldemo_clutch/Unlocked/Enable' }
{'sldemo_clutch/Unlocked/E_Sum' }
{'sldemo_clutch/Unlocked/Engine←Damping' }
{'sldemo_clutch/Unlocked/Engine←Inertia' }
{'sldemo_clutch/Unlocked/Engine←Integrator' }
{'sldemo_clutch/Unlocked/Goto' }
{'sldemo_clutch/Unlocked/Goto1' }
{'sldemo_clutch/Unlocked/Max←Dynamic←Friction←Torque' }
{'sldemo_clutch/Unlocked/V_Sum' }
{'sldemo_clutch/Unlocked/Vehicle←Damping' }
{'sldemo_clutch/Unlocked/Vehicle←Inertia' }
{'sldemo_clutch/Unlocked/Vehicle←Integrator' }
{'sldemo_clutch/Unlocked/W_Slip' }
{'sldemo_clutch/Unlocked/slip direction' }
{'sldemo_clutch/Unlocked/w0' }
{'sldemo_clutch/Unlocked/w0 ' }
{'sldemo_clutch/Unlocked/we' }
{'sldemo_clutch/Unlocked/wv' }
```

Compatibility Considerations

Variants argument will be removed

Warns starting in R2021a

The `Variants` option will be removed from `Simulink.FindOptions` in a future release. Scripts that use the `Variants` option continue to work with a warning.

To find variant blocks in a model that are active during simulation or code generation, you can compile the model and use the `Simulink.FindOptions` object with the `MatchFilter` option.

`Simulink.FindOptions` does not support the use of `MatchFilter` along with the `Variants` option.

This command produces an error:

```
f = Simulink.FindOptions('MatchFilter',...  
@Simulink.match.activeVariants, 'Variants', 'ActiveVariants');  
blocks=Simulink.findBlocks('sldemo_variant_subsystems',f)
```

See Also

`Simulink.findBlocksOfType` | `Simulink.findBlocks` | `Simulink.allBlockDiagrams`

Introduced in R2018a

Simulink.HMI.InstrumentedSignals

Save and restore signal logging specification

Description

A `Simulink.HMI.InstrumentedSignals` object acts as a specification for logged signals in a model, including signals in subsystems, library instances, and Stateflow charts. You can get a `Simulink.HMI.InstrumentedSignals` object for the logging configuration in your model using the `get_param` function with the `InstrumentedSignals` model parameter. You can save several logging configurations as `Simulink.HMI.InstrumentedSignals` objects and easily swap the logging configuration for your model using `set_param`.

Note An `InstrumentedSignals` object for a model does not include signals logged inside referenced models. To get a list of logged signals in a referenced model, create an `InstrumentedSignals` object for the referenced model.

Creation

The `get_param` function returns a `Simulink.HMI.InstrumentedSignals` object for the `InstrumentedSignals` model parameter.

Properties

Model — Model name

character vector

Name of the model that corresponds to the list of logged signals.

Example: 'sldemo_fuelsys'

Count — Number of logged signals

integer

Number of logged signals in the model.

Example: 10

Data Types: `uint32`

Examples

Save and Restore a Set of Logged Signals

This example shows how to use the `Simulink.HMI.InstrumentedSignals` object to save a set of logged signals to restore after running a simulation with a different signal logging configuration.

Save the Initial Signal Logging Configuration

This example uses the `sldemo_fuelsys` model, which is configured to log 10 signals. Open the model and use the `get_param` function to get a `Simulink.HMI.InstrumentedSignals` object representing the signal logging configuration.

```
load_system sldemo_fuelsys

initSigs = get_param('sldemo_fuelsys','InstrumentedSignals');
```

You can save the initial signal logging configuration in a MAT-file for later use.

```
save initial_instSigs.mat initSigs
```

Remove All Logging Badges

To return to a baseline of no logged signals, you can use the `set_param` function to remove all logging badges from signals in your model. Then, you can easily select a different configuration of signals to log in the Simulink™ Editor or using the `Simulink.sdi.markSignalForStreaming` function.

```
set_param('sldemo_fuelsys','InstrumentedSignals',[])
```

Restore Saved Logging Configuration

After working with a different set of logged signals, you can restore a saved configuration using the `Simulink.HMI.InstrumentedSignals` object. For example, if you saved the logging configuration to a MAT-file, you can load the MAT-file contents into the workspace and use the `set_param` function to restore the previously saved logging configuration.

```
load initial_instSigs.mat

set_param('sldemo_fuelsys','InstrumentedSignals',initSigs)
```

See Also

[Simulink.HMI.SignalSpecification](#) | [Simulink.sdi.markSignalForStreaming](#)

Topics

“View Data in the Simulation Data Inspector”

“Export Signal Data Using Signal Logging”

“Configure a Signal for Logging”

Introduced in R2015b

Simulink.HMI.ParamSourceInfo

Information about Dashboard block variable and parameter connections

Description

Use a `Simulink.HMI.ParamSourceInfo` object to connect a Dashboard block to a variable or parameter programmatically using the `set_param` function. The `get_param` function returns a `Simulink.HMI.ParamSourceInfo` object when you use the function to query the connection information for a Dashboard block connected to a variable or parameter.

The `Simulink.HMI.ParamSourceInfo` object contains four properties. Some of the properties apply to connecting Dashboard blocks to parameters, and some apply for connecting Dashboard blocks to variables. Not all fields have a value for a connection because a given Dashboard block connects to either a parameter or a variable.

Creation

Syntax

```
paramSourceInfo = Simulink.HMI.ParamSourceInfo
```

Description

`paramSourceInfo = Simulink.HMI.ParamSourceInfo` creates the empty `Simulink.HMI.ParamSourceInfo` object, `paramSourceInfo`.

Properties

BlockPath — Path to the block associated with the parameter or variable

`Simulink.BlockPath`

`Simulink.BlockPath` object for the block associated with the parameter or variable. You can create a `Simulink.BlockPath` object for a block by passing a character array describing the path to `Simulink.BlockPath`. You can get a character array describing the block path for a selected block using the `gcb` function.

Example: `Simulink.BlockPath('vdp/Mu')`

ParamName — Name of the connected tunable block parameter

character array

Name of the connected tunable block parameter, specified as a character array. A `Simulink.HMI.ParamSourceInfo` object connected to a variable does not have a value for the `ParamName` property.

Example: `Gain`

VarName — Name of the connected variable

character array

Name of the connected variable, specified as a character array. A `Simulink.HMI.ParamSourceInfo` object connected to a tunable parameter does not have a value for the `VarName` property.

Example: `Mu`

Element — Element of nonscalar variable or parameter value to connect

character array

Element of nonscalar variable or parameter value to connect, specified as a character array.

When the value of the variable or parameter you want to tune using a dashboard block is nonscalar, use the `Element` property to specify the scalar element of the nonscalar value that you want to tune. To connect to a scalar element in a vector or matrix, specify the element index. To connect to an element of a bus or structure, specify the element in the context of the bus or structure hierarchy by using dots to indicate different levels in the hierarchy, and omit the top level. The value of the `VarName` property or the `ParamName` property specifies the top level.

Example: `3` connects the block to the third element of the variable specified by the `VarName` property or the parameter specified by the `ParamName` property.

Example: `(3,2)` connects the block to the element in the third row and second column of the variable specified by the `VarName` property or the parameter specified by the `ParamName` property.

Example: `a.b` connects the block to element `b` of the nested structure or bus `a` within the value of the variable specified by the `VarName` property or the parameter specified by the `ParamName` property.

WksType — Source workspace for the connected variable

'base' | 'model' | data dictionary file path

Source workspace for the connected variable, specified as a character array. The source workspace can be the base workspace, model workspace, or a data dictionary. When the source workspace is a data dictionary, the `WksType` property value is the file path for the data dictionary, specified as a character array. A `Simulink.HMI.ParamSourceInfo` object connected to a tunable parameter does not have a value for the `WksType` property.

Example: `'modelData.sldd'`

Examples

Programmatically Add and Connect a Dashboard Block

This example shows how to programmatically add Dashboard blocks to a model and connect them to elements in the model. The example adds a Dashboard Scope block and a Slider block to the `vdp` model and connects and configures the blocks.

Add Blocks

Use the `add_block` function to add a Dashboard Scope block and a Slider block to the `vdp` model. This example also specifies the position of the blocks.

```
open_system('vdp')

scopePos = [550 140 800 305];
sliderPos = [550 30 800 120];
```

```
add_block('simulink_hmi_blocks/Dashboard Scope','vdp/Dashboard Scope',...
         'Position',scopePos)
add_block('simulink_hmi_blocks/Slider','vdp/Slider','Position',sliderPos)
```

Connect the Dashboard Scope Block

Use a cell array of `Simulink.HMI.SignalSpecification` objects to connect the Dashboard block to the x1 and x2 signals. The `Simulink.HMI.SignalSpecification` object specifies a connected signal using the block path and port index for the source of the signal. The default value for the `OutputPortIndex` is 1, so this example does not specify the output port for the x1 and x2 signals.

```
x1_sigSpec = Simulink.HMI.SignalSpecification;
x1_sigSpec.BlockPath = Simulink.BlockPath('vdp/x1');

x2_sigSpec = Simulink.HMI.SignalSpecification;
x2_sigSpec.BlockPath = Simulink.BlockPath('vdp/x2');

connection_dashboardScope = {x1_sigSpec x2_sigSpec};
```

Use the `set_param` function to configure the connected signals for the Dashboard Scope block.

```
set_param('vdp/Dashboard Scope',"Binding",connection_dashboardScope)
```

Connect and Configure the Slider Block

Use a `Simulink.HMI.ParamSourceInfo` object and the `set_param` function to connect the Slider block to the Gain parameter of the Mu block. To connect a parameter, the `Simulink.HMI.ParamSourceInfo` needs to specify the block path for the block that corresponds to the parameter and the name of the parameter.

```
slider_param = Simulink.HMI.ParamSourceInfo;
slider_param.BlockPath = Simulink.BlockPath('vdp/Mu');
slider_param.ParamName = 'Gain';

set_param('vdp/Slider',"Binding",slider_param)
```

Configure the scale for the slider for a range of 1 to 10 with a tick mark spacing of 1.

```
slider_limits = [1 1 10];

set_param('vdp/Slider',"Limits",slider_limits)
```

See Also

Edit | Knob | Slider | Push Button | Rotary Switch | Radio Button | Combo Box | Check Box | Rocker Switch | Slider Switch | Toggle Switch | `Simulink.HMI.SignalSpecification`

Introduced in R2019a

Simulink.HMI.SignalSpecification

Programmatically connect a Dashboard block to a signal

Description

Use a `Simulink.HMI.SignalSpecification` object to programmatically connect a Dashboard block to a signal.

The `SignalSpecification` object contains the block path, port index, and frame processing mode for a signal. To connect a Dashboard block to a signal, specify the corresponding `SignalSpecification` object as the value for the `Binding` parameter for the block using the `set_param` function.

Creation

Syntax

```
sigSpec = Simulink.HMI.SignalSpecification
```

Description

`sigSpec = Simulink.HMI.SignalSpecification` creates an empty `Simulink.HMI.SignalSpecification` object. Specify the block path and port index that correspond to the origin of the signal you want to connect.

Properties

BlockPath — Path of the block with the signal as an output

`Simulink.BlockPath` (default) | character vector

Block path for the block that has the signal you want to connect as an output, specified as a character vector or a `Simulink.BlockPath` object.

```
Example: sigSpec.BlockPath = 'vdp/Mu';
```

```
Example: sigSpec.BlockPath = myBlockPath;
```

OutputPortIndex — Block output port corresponding to the signal

1 (default) | scalar

Output port index corresponding to the signal, specified as a scalar, real integer.

```
Example: sigSpec.OutputPortIndex = 2;
```

FrameProcessingMode — Processing mode for the signal data

"sample" (default) | "frame"

Processing mode for the signal data, specified as `sample` or `frame`.

- `sample` — Each element in a sample of the signal is processed as a channel.
- `frame` — Each column in a sample of the signal is processed as a channel.

Example: `sigSpec.FrameProcessingMode = "frame";`

Note Only the Dashboard Scope block supports frame-based data.

Examples

Programmatically Add and Connect a Dashboard Block

This example shows how to programmatically add Dashboard blocks to a model and connect them to elements in the model. The example adds a Dashboard Scope block and a Slider block to the `vdp` model and connects and configures the blocks.

Add Blocks

Use the `add_block` function to add a Dashboard Scope block and a Slider block to the `vdp` model. This example also specifies the position of the blocks.

```
open_system('vdp')

scopePos = [550 140 800 305];
sliderPos = [550 30 800 120];

add_block('simulink_hmi_blocks/Dashboard Scope','vdp/Dashboard Scope',...
    'Position',scopePos)
add_block('simulink_hmi_blocks/Slider','vdp/Slider','Position',sliderPos)
```

Connect the Dashboard Scope Block

Use a cell array of `Simulink.HMI.SignalSpecification` objects to connect the Dashboard block to the `x1` and `x2` signals. The `Simulink.HMI.SignalSpecification` object specifies a connected signal using the block path and port index for the source of the signal. The default value for the `OutputPortIndex` is 1, so this example does not specify the output port for the `x1` and `x2` signals.

```
x1_sigSpec = Simulink.HMI.SignalSpecification;
x1_sigSpec.BlockPath = Simulink.BlockPath('vdp/x1');

x2_sigSpec = Simulink.HMI.SignalSpecification;
x2_sigSpec.BlockPath = Simulink.BlockPath('vdp/x2');

connection_dashboardScope = {x1_sigSpec x2_sigSpec};
```

Use the `set_param` function to configure the connected signals for the Dashboard Scope block.

```
set_param('vdp/Dashboard Scope',"Binding",connection_dashboardScope)
```

Connect and Configure the Slider Block

Use a `Simulink.HMI.ParamSourceInfo` object and the `set_param` function to connect the Slider block to the `Gain` parameter of the `Mu` block. To connect a parameter, the `Simulink.HMI.ParamSourceInfo` needs to specify the block path for the block that corresponds to the parameter and the name of the parameter.

```
slider_param = Simulink.HMI.ParamSourceInfo;  
slider_param.BlockPath = Simulink.BlockPath('vdp/Mu');  
slider_param.ParamName = 'Gain';
```

```
set_param('vdp/Slider','Binding',slider_param)
```

Configure the scale for the slider for a range of 1 to 10 with a tick mark spacing of 1.

```
slider_limits = [1 1 10];
```

```
set_param('vdp/Slider','Limits',slider_limits)
```

See Also

[get_param](#) | [set_param](#) | [Simulink.BlockPath](#)

Topics

“View Data in the Simulation Data Inspector”

“Tune and Visualize Your Model with Dashboard Blocks”

Introduced in R2015b

LibraryBrowser.LBStandalone

Display, hide, size, and position Simulink Library Browser

Description

`LibraryBrowser.LBStandalone` objects allow you to programmatically display, hide, size, and position the Simulink Library Browser.

Creation

Get the handle of the Library Browser object using either the `LibraryBrowser.LibraryBrowser2` or `slLibraryBrowser` function.

Properties

IsOnTop — Always put Library Browser window on top

`false` or `0` (default) | `true` or `1`

Always put the Library Browser window on top of other Simulink Editor windows, specified as a numeric or logical `1` (`true`) or `0` (`false`).

Object Functions

| | |
|--------------------------|--|
| <code>refresh</code> | Refresh Simulink Library Browser |
| <code>show</code> | Display Simulink Library Browser |
| <code>hide</code> | Hide Simulink Library Browser |
| <code>getPosition</code> | Get position of Simulink Library Browser |
| <code>setPosition</code> | Set position of Simulink Library Browser |

Examples

Keep Library Browser in Front of Other Windows

Create an object that lets you programmatically access the Library Browser.

```
lb = LibraryBrowser.LibraryBrowser2;
```

Set the `IsOnTop` property of the Library Browser to `1` (`true`) using dot notation to access the property.

```
lb.IsOnTop = 1;
```

Compatibility Considerations

LibraryBrowser.LBStandalone object replaces LibraryBrowser.LibraryBrowser2 object
Behavior changed in R2016b

In previous releases, these two commands returned a `LibraryBrowser.LibraryBrowser2` object:

```
lb = slLibraryBrowser  
lb = LibraryBrowser.LibraryBrowser2
```

Starting in R2016b, each command returns a `LibraryBrowser.LBStandalone` object. The functions to access Library Browser operations such as `show` and `refresh` support `LibraryBrowser.LBStandalone` objects.

See Also

Library Browser

Topics

“Create Custom Library”

“Add Libraries to the Library Browser”

“Customize Library Browser Appearance”

“Register Customizations with Simulink”

Introduced in R2014b

MATLABFunctionConfiguration

MATLAB Function block property configuration

Description

The MATLABFunctionConfiguration object controls the MATLAB Function block properties such as the description, sample time, and function script.

Tip You can also configure a MATLAB Function block programmatically by using a Stateflow.EMChart object. This object provides access to the inputs, outputs, and properties of a MATLAB Function block. For more information, see “Configure MATLAB Function Blocks Programmatically”.

Creation

Each MATLAB Function block has its own MATLABFunctionConfiguration object. To access this object, use the `get_param` function. For example, if the model `myModel` contains a MATLAB Function block called MATLAB Function, enter:

```
config = get_param('myModel/MATLAB Function', ...
    'MATLABFunctionConfiguration');
```

Properties

Path — Path of block relative to model

character vector

Path of the MATLAB Function block relative to the model, specified as a character vector.

Data Types: char

FunctionScript — Code for MATLAB Function block

character vector

Code for the MATLAB Function block, specified as a character vector.

Data Types: char

UpdateMethod — Update method for MATLAB Function block

Inherited (default) | Discrete | Continuous

Update method for the MATLAB Function block, specified as one of these values:

- **Inherited** — The input signal at the trigger port determines when the block is updated during a simulation. A signal from a connected Simulink block triggers the port. If `UpdateMethod` is changed to 'Inherited', `Sample Time` is automatically set to -1.

- **Discrete** — The Simulink model generates an implicit event at regular time intervals to awaken the block at the rate you specify in the `SampleTime` property. Other blocks in the model can have different sample times.
- **Continuous** — The MATLAB Function block updates at major time steps only, although it computes outputs and local continuous variables during minor and major time steps. If the `UpdateMethod` is changed to 'Continuous', `Sample Time` is automatically set to 0.

When you set `UpdateMethod` to `Inherited` or `Continuous` and attempt to change `SampleTime`, Simulink displays a warning and ignores the input sample time.

UI Use

In the Property Inspector, Ports and Data Manager, or Model Explorer, set **Update method** to `Inherited`, `Discrete`, or `Continuous`.

Data Types: enumerated

SampleTime — Sample time

'-1' (default) | '0' | character vector

Sample time of the MATLAB Function block, specified as a character vector. Sample time is only valid when `UpdateMethod` is set to `Discrete`. If `UpdateMethod` is set to `Continuous` or `Inherited`, any changes made to the sample time are ignored.

UI Use

In the Property Inspector, Ports and Data Manager, or Model Explorer, enter a value for the **Sample Time** parameter.

Data Types: char

Description — Description

character vector

Description of the MATLAB Function block, specified as a character vector.

UI Use

In the Property Inspector, Ports and Data Manager, or Model Explorer, enter a description in the **Description** box.

Data Types: char

DocumentLink — Documentation link

character vector

Documentation link for the MATLAB Function block, specified as a character vector.

UI Use

In the Property Inspector, Ports and Data Manager, or Model Explorer, enter a link in the **Document link** box.

Data Types: char

SupportVariableSizing — Whether MATLAB Function block supports variable-size data

true or 1 (default) | false or 0

Whether the MATLAB Function block supports variable-size data, specified as a numeric or logical 1 (`true`) or 0 (`false`).

UI Use

In the Property Inspector, Ports and Data Manager, or Model Explorer, select **Support variable-size arrays** to enable this setting.

Data Types: `logical`

AllowDirectFeedthrough — Whether MATLAB Function block supports direct feedthrough semantics

`true` or 1 (default) | `false` or 0

Whether the MATLAB Function block supports direct feedthrough semantics, specified as a numeric or logical 1 (`true`) or 0 (`false`). The block has direct feedthrough if the output of the block directly depends on the input of the block. The block does not have direct feedthrough if the outputs of the block depend on the internal states and properties rather than the input of the block.

UI Use

In the Property Inspector, Ports and Data Manager, or Model Explorer, select **Allow direct feedthrough** to enable this setting.

Data Types: `logical`

VectorOutputs1D — Whether MATLAB Function block outputs column vectors as one-dimensional data

`false` or 0 (default) | `true` or 1

Whether the MATLAB Function block outputs column vectors as one-dimensional data, specified as a numeric or logical 0 (`false`) or 1 (`true`). When enabled, the block converts vectors of size N -by-1 to one-dimensional signals with a signal size equal to N .

UI Use

In the Property Inspector, Ports and Data Manager, or Model Explorer, select or clear **Interpret output column vectors as one-dimensional data**.

Data Types: `logical`

SaturateonIntegerOverflow — Whether data saturates on integer overflow

`true` or 1 (default) | `false` or 0

Whether the data in the MATLAB Function block saturates on integer overflow, specified as a numeric or logical 1 (`true`) or 0 (`false`). If this setting is set to `true`, the overflows saturate to either the minimum or maximum value that the data type can represent. If the setting is `false`, the overflow wraps to the appropriate value that the data type can represent. If your model has a possible overflow and you want to apply saturation protection in your generated code, it is recommended to enable this setting. If you have performance restrictions or are not concerned with integer overflow, you can disable this setting.

UI Use

In the Property Inspector, Ports and Data Manager, or Model Explorer, select **Saturate on integer overflow** to enable this setting.

Data Types: `logical`

TreatAsFi — Inherited signals to treat as fi objects

'FixedPoint' (default) | 'FixedPointAndInteger'

Inherited Simulink signals to treat as Fixed-Point Designer `fi` objects, specified as one of these values:

- 'FixedPoint' — The MATLAB Function block treats all fixed-point inputs as `fi` objects.
- 'FixedPointAndInteger' — The MATLAB Function block treats all fixed-point and integer inputs as `fi` objects.

To learn more about `fi` objects, see “`fi` Object Properties” (Fixed-Point Designer).

UI Use

In the Property Inspector, Ports and Data Manager, or Model Explorer, set **Treat these inherit Simulink signal types as fi objects** to Fixed-point or Fixed-point and & Integer.

Data Types: enumerated

FimathMode — Default fimath properties

'SameAsMATLAB' (default) | 'UserSpecified'

Default `fimath` properties for the MATLAB Function block, specified as one of these values:

- 'SameAsMATLAB' — Use the same `fimath` properties as the current default `fimath` object.
- 'UserSpecified' — Use the `Fimath` property to specify the default `fimath` object.

To learn more about fixed-point math, see `fimath`.

UI Use

In the Property Inspector, Ports and Data Manager, or Model Explorer, set **MATLAB Function fimath** to Same as MATLAB or Specify Other.

Data Types: enumerated

Fimath — Default fimath object

character vector

Default `fimath` object, specified as a character vector. When the `FimathMode` property for the MATLAB Function block is 'UserSpecified', you can use this property to:

- Enter an expression that constructs a `fimath` object.
- Enter the variable name for a `fimath` object in the MATLAB or model workspace.

To learn more about `fimath` object properties, see “`fimath` Object Properties” (Fixed-Point Designer).

UI Use

In the Property Inspector, Ports and Data Manager, or Model Explorer, set **MATLAB Function fimath** to Specify Other and enter a `fimath` expression.

Data Types: char

Object Functions

`openReport` Open MATLAB function report

closeReport Close MATLAB function report
getReport Generate MATLAB function report

Examples

Configure MATLAB Function Block Properties

Access the MATLABFunctionConfiguration object for the MATLAB Function block in the model call_stats_block1 described in “Create Custom Functionality Using MATLAB Function Blocks”.

```
config = get_param('call_stats_block1/MATLAB Function', ...  
                  'MATLABFunctionConfiguration');
```

Set the value of the Description property.

```
config.Description = 'Calculate the mean and standard deviation for a vector of values.';
```

Create Custom Report for MATLAB Function Block

Access the MATLABFunctionConfiguration object for the MATLAB Function block in the model call_stats_block1 described in “Create Custom Functionality Using MATLAB Function Blocks”.

```
config = get_param('call_stats_block1/MATLAB Function', ...  
                  'MATLABFunctionConfiguration');
```

Create the MATLABFunctionReport object for the MATLAB Function block.

```
report = getReport(config);
```

Access the coder.Function objects in the report.

```
functions = report.Functions;
```

Create a custom report that lists the functions and variables in the MATLAB Function block.

```
for i = 1:numel(functions)  
    fprintf('Function %s uses these variables:\n', functions(i).Name)  
    variables = functions(i).Variables;  
    for j = 1:numel(variables)  
        fprintf('%d. %s -- %s\n', j, variables(j).Name, variables(j).Scope)  
    end  
    fprintf('\n')  
end
```

```
Function stats uses these variables:
```

```
1. mean -- Output  
2. stdev -- Output  
3. vals -- Input  
4. len -- Local
```

```
Function avg uses these variables:
```

```
1. mean -- Output
```

- 2. array -- Input
- 3. size -- Input

See Also

[get_param](#) | [MATLAB Function](#) | [Stateflow.EMChart](#) | [MATLABFunctionReport](#)

Topics

“Radar Tracking Using MATLAB Function Block” on page 13-227

“Create Custom Functionality Using MATLAB Function Blocks”

“Specify MATLAB Function Block Properties”

Introduced in R2019b

MATLABFunctionReport

MATLAB function report

Description

Use MATLABFunctionReport objects to access information about the functions and variables used by MATLAB Function blocks.

Creation

To create a MATLABFunctionReport object for a MATLAB Function block, call the `getReport` function on the MATLABFunctionConfiguration object for the block. For example, if the model `myModel` contains a MATLAB Function block called `MATLAB Function`, enter:

```
config = get_param('myModel/MATLAB Function', ...  
    'MATLABFunctionConfiguration');  
report = getReport(config);
```

Properties

Functions — Functions in block

array of `coder.Function` objects

This property is read-only.

Functions in the MATLAB Function block, specified as an array of `coder.Function` objects. The array contains one `coder.Function` object for each function in the block. Use these objects to access information such as the name, scope, and type of the variables used by each function. For more information, see `coder.Function` Properties.

Data Types: `coder.Function`

Examples

Create Custom Report for MATLAB Function Block

Access the MATLABFunctionConfiguration object for the MATLAB Function block in the model `call_stats_block1` described in “Create Custom Functionality Using MATLAB Function Blocks”.

```
config = get_param('call_stats_block1/MATLAB Function', ...  
    'MATLABFunctionConfiguration');
```

Create the MATLABFunctionReport object for the MATLAB Function block.

```
report = getReport(config);
```

Access the `coder.Function` objects in the report.

```
functions = report.Functions;
```

Create a custom report that lists the functions and variables in the MATLAB Function block.

```
for i = 1:numel(functions)
    fprintf('Function %s uses these variables:\n', functions(i).Name)
    variables = functions(i).Variables;
    for j = 1:numel(variables)
        fprintf('%d. %s -- %s\n', j, variables(j).Name, variables(j).Scope)
    end
    fprintf('\n')
end
```

Function stats uses these variables:

1. mean -- Output
2. stdev -- Output
3. vals -- Input
4. len -- Local

Function avg uses these variables:

1. mean -- Output
2. array -- Input
3. size -- Input

Tips

The first time that you create a `MATLABFunctionReport` object or open the MATLAB function report, Simulink automatically updates your model. If you make subsequent changes to the MATLAB code in the block, you must update your model before you generate a new `MATLABFunctionReport` object. Otherwise, the object does not reflect your changes. From the **Modeling** tab, select **Update Model**, or press **Ctrl+D**. For more information, see “Update Diagram and Run Simulation”.

See Also

[getReport](#) | [MATLAB Function](#) | [MATLABFunctionConfiguration](#) | [coder.Function Properties](#)

Topics

“MATLAB Function Reports”

“Create Custom Functionality Using MATLAB Function Blocks”

Introduced in R2021a

Simulink.MDLInfo

Extract SLX, SLXP, or MDL file information without loading file

Description

`Simulink.MDLInfo` objects extract information from an SLX, SLXP or MDL file without loading it into memory.

To extract the description and metadata from a file without creating an `MDLInfo` object, use the `Simulink.MDLInfo.getDescription` and `Simulink.MDLInfo.getMetadata` functions, respectively.

Creation

Syntax

```
info = Simulink.MDLInfo(file)
```

Description

`info = Simulink.MDLInfo(file)` creates an `MDLInfo` object called `info` and populates the properties with the information from the specified model file.

Input Arguments

file — Name of SLX, SLXP, or MDL file

character vector | string scalar

Name of the SLX, SLXP, or MDL file, specified as a character vector or string scalar.

The file name can include a partial path, complete path, relative path, or no path. When you do not provide a path, the file extension is optional.

To avoid unexpected results caused by shadowed files that share a name, specify a fully qualified file name.

Example: `Simulink.MDLInfo('vdp')`

Example: `Simulink.MDLInfo('mymodel.slx')`

Example: `Simulink.MDLInfo('mydir/mymodel.slx')`

Example: `Simulink.MDLInfo('C:/mydir/mymodel.slx')`

Data Types: `char` | `string`

Properties

File Name and Contents

BlockDiagramName — Name of block diagram

character vector

This property is read-only.

Name of the block diagram, returned as a character vector.

The name of the block diagram matches the file name, but without an extension.

Data Types: `char`

BlockDiagramType — Type of file

character vector

This property is read-only.

Type of file, returned as a character vector.

Data Types: `char`

FileName — Fully qualified file name

character vector

This property is read-only.

Fully qualified file name, returned as a character vector.

Data Types: `char`

Interface — Description of inputs, outputs, and references

structure

This property is read-only.

Description of inputs, outputs, and references, returned as a structure.

The structure includes the names and attributes of the top-level ports, model references, and subsystem references.

Data Types: `struct`

IsLibrary — True or false result

1 | 0

This property is read-only.

True or false result, returned as a 1 or 0 of data type `logical`.

- 1 (`true`) — File is a library.
- 0 (`false`) — File is not a library.

Data Types: `logical`

User-Specified Information

Description — User-specified description

character vector

This property is read-only.

User-specified description for the file, returned as a character vector.

Tips

- To extract the description without loading the model or creating an `MDLInfo` object, use the `Simulink.MDLInfo.getDescription` function.
- To view the description without loading the model or creating an `MDLInfo` object, in the MATLAB Command Window, enter:

```
help 'mymodelName'
```

- To view the description for an open model, open the **Description** tab in the Model Properties dialog box.

Data Types: `char`

Metadata — Names and values of arbitrary data

structure

This property is read-only.

Names and values of arbitrary data associated with the file, returned as a structure.

The structure fields can be character vectors, numeric matrices of type `double`, or more structures.

Tips

To extract the metadata structure without loading the model or creating an `MDLInfo` object, use the `Simulink.MDLInfo.getMetadata` function.

Data Types: `struct`

Save Information

ReleaseUpdateLevel — Release update used to save file

positive integer

This property is read-only.

Release update used to save the file, returned as a positive integer.

- 0 — The file was saved in a general release, for example, 'R2020a', or was saved in a release before R2020a.
- Positive integer — The file was saved in an update release, for example, 2, if the model was saved in 'R2020a Update 2'.

Data Types: `int32`

LastModifiedBy — Name of user who last saved file

character vector

This property is read-only.

Name of the user who last saved the file, returned as a character vector.

Data Types: char

LastSavedArchitecture — Platform used to save file

character vector

This property is read-only.

Platform used to save the file, returned as a character vector.

Example: 'glnxa64'

Data Types: char

ModelVersion — Version number

character vector

This property is read-only.

Version number of the file, returned as a character vector.

Data Types: char

ReleaseName — MATLAB release used to save file

character vector

This property is read-only.

MATLAB release used to save the file, returned as a character vector.

Example: 'R2020a'

Data Types: char

SavedCharacterEncoding — Character encoding

character vector

This property is read-only.

Character encoding when the file was saved, returned as a character vector.

Example: 'UTF-8'

Data Types: char

SimulinkVersion — Simulink version number used to save file

character vector

This property is read-only.

Simulink version number used to save the file, returned as a character vector.

Example: '10.1'

Data Types: char

Examples

Get Model Information

Create a `Simulink.MDLInfo` object that corresponds to the `vdp.slx` file.

```
info = Simulink.MDLInfo('vdp.slx');
```

Get information about the file, such as the type of file, by using dot notation to access the property values.

```
type = info.BlockDiagramType
```

```
type =
```

```
    'Model'
```

`vdp` is a model file.

Find Referenced Models Without Loading Top Model

Get information about the `sldemo_mdhref_depgraph` model.

```
info = Simulink.MDLInfo('sldemo_mdhref_depgraph');
```

Get the interface information.

```
info.Interface
```

```
ans =
```

```
    struct with fields:
```

```

        Inports: [0x1 struct]
        Outports: [0x1 struct]
        Trigports: [0x1 struct]
        Enableports: [0x1 struct]
        ModelVersion: '1.84'
        SubsystemReferences: {0x1 cell}
        ModelReferences: {4x1 cell}
        ParameterArgumentNames: ''
        TestPointedSignals: [0x1 struct]
        ProvidedFunctions: [0x1 struct]
        IsExportFunctionModel: 0
        IsArchitectureModel: 0
        IsAUTOSARArchitectureModel: 0
        ResetEvents: [0x1 struct]
        HasInitializeEvent: 0
        HasTerminateEvent: 0
        PreCompExecutionDomainType: 'Unset'
        ParameterArguments: [0x1 struct]
        ExternalFileReference: [4x1 struct]
```

Get the referenced models.

```
info.Interface.ModelReferences
```

```
ans =
    4x1 cell array

    {'sldemo_mdref_depgraph/heat2cost|sldemo_mdref_heat2cost'      }
    {'sldemo_mdref_depgraph/house|sldemo_mdref_house'              }
    {'sldemo_mdref_depgraph/outdoor temp|sldemo_mdref_outdoor_temp'}
    {'sldemo_mdref_depgraph/thermostat|sldemo_mdref_heater'        }
```

Add and Check File Metadata

Create a structure that contains metadata information.

```
m.TestStatus = 'untested';
m.ExpectedCompletionDate = '01/01/2011';
```

Create a model, update the 'Metadata' parameter, and save the metadata in the model.

```
new_system('MDLInfoMetadataModel')
set_param('MDLInfoMetadataModel','Metadata',m)
save_system('MDLInfoMetadataModel')
```

Check the model for metadata by using an MDLInfo object.

```
info = Simulink.MDLInfo('MDLInfoMetadataModel');
info.Metadata
```

```
ans =
    struct with fields:
        TestStatus: 'untested'
        ExpectedCompletionDate: '01/01/2011'
```

See Also

[Simulink.MDLInfo.getDescription](#) | [Simulink.MDLInfo.getMetadata](#)

Topics

“Manage Model Versions and Specify Model Properties”

Introduced in R2009b

Simulink.Parameter

Store, share, and configure parameter values

Description

Create a `Simulink.Parameter` object to set the value of one or more block parameters in a model, such as the **Gain** parameter of a Gain block. You create the object in a workspace or in a data dictionary. Set the parameter value in the object, then reference the object from the block.

Use a `Simulink.Parameter` object to:

- Share a value among multiple block parameters.
- Represent an engineering constant or a tunable calibration parameter.
- Separate a parameter value from its data type and other properties.
- Configure parameter data for code generation.

The `Value` property of the object stores the parameter value. To use the object in a model, set the value of a block parameter to an expression that includes the name of the object. Omit the `Value` property from the expression. For more information, see “Use Parameter Objects”.

For more information about block parameters, see “Set Block Parameter Values” and “How Generated Code Stores Internal Signal, State, and Parameter Data” (Simulink Coder).

Creation

Create a `Simulink.Parameter` object:

- Directly from a block dialog box or the Property Inspector. See “Create, Edit, and Manage Workspace Variables”.
- By using the Model Data Editor. Inspect the **Parameters** tab. Right-click the row that contains a variable and from the context menu, select **Convert to parameter object**.
- By using the Model Explorer. See “Create Data Objects from Built-In Data Class Package Simulink”.
- By using the `Simulink.Parameter` function described below.

Syntax

```
paramObj = Simulink.Parameter  
paramObj = Simulink.Parameter(paramValue)
```

Description

`paramObj = Simulink.Parameter` returns a `Simulink.Parameter` object with default property values.

`paramObj = Simulink.Parameter(paramValue)` returns a `Simulink.Parameter` object and initializes the `Value` property to `paramValue`.

Properties

For information about the properties in the property dialog box of a `Simulink.Parameter` object, see “`Simulink.Parameter` Property Dialog Box”.

CoderInfo — Specifications for generating code for parameter object

`Simulink.CoderInfo` object

Specifications for generating code for the parameter object, returned as a `Simulink.CoderInfo` object.

This property is read only. Instead, modify the properties of the `Simulink.CoderInfo` object that this property contains.

For example, the `StorageClass` property of the `Simulink.CoderInfo` object determines how Simulink code generation toolboxes allocate memory for the parameter object in the generated code. For more information, see “C Code Generation Configuration for Model Interface Elements” (Simulink Coder) and “Choose Storage Class for Controlling Data Representation in Generated Code” (Embedded Coder).

Complexity — Numeric complexity of parameter value

'real' (default) | 'complex'

Numeric complexity of the parameter value, specified as either 'real' or 'complex'. For `Simulink.Parameter` objects in the model workspace, use this property to configure the complexity of a model argument. See “Parameterize Instances of a Reusable Referenced Model”.

For numeric values, Simulink derives the complexity from the parameter value that you specify in the `Value` property. In this case, changing the complexity results in error.

When the value is a structure or a mathematical expression, Simulink ignores the specified complexity.

Data Types: char

DataType — Data type of parameter value

'auto' (default) | character vector

Data type of the parameter value in the `Value` property, specified as 'auto' or a character vector. When you simulate the model or generate code, Simulink casts the value to the specified data type.

If you specify 'auto', the default setting, the parameter object uses the same data type as the block parameters that use the object. See “Reduce Maintenance Effort with Data Type Inheritance”.

When you set the `Value` property to something other than a double number, the object typically sets the `DataType` property based on the value of the `Value` property. For example, when you set the `Value` property to `int8(5)`, the object sets the value of the `DataType` property to 'int8'.

To explicitly specify a built-in data type (see “Data Types Supported by Simulink”), specify one of these options:

- 'double'
- 'single'
- 'half'
- 'int8'
- 'uint8'
- 'int16'
- 'uint16'
- 'int32'
- 'uint32'
- 'int64'
- 'uint64'
- 'boolean'

To specify a fixed-point data type, use the `fixdt` function. For example, specify `'fixdt(1,16,5)'`.

If you use a `Simulink.AliasType` or `Simulink.NumericType` object to create and share custom data types in your model, specify the name of the object.

To specify an enumerated data type, use the name of the type preceded by `Enum:`. For example, specify `'Enum: myEnumType'`.

When you store a structure or array of structures in the `Value` property of the object, the object sets the `DataType` property to `'struct'`. To specify a `Simulink.Bus` object as the data type, use the name of the bus object preceded by `Bus:`. For example, specify `'Bus: myBusObject'`.

Example: `'auto'`

Example: `'int8'`

Example: `'fixdt(1,16,5)'`

Example: `'myAliasTypeObject'`

Example: `'Enum: myEnumType'`

Example: `'Bus: myBusObject'`

Data Types: `char`

Description — Custom description of parameter object

`''` (default) | character vector

Custom description of the parameter object, specified as a character vector. Use this property to document the significance that the parameter object has in your algorithm.

If you have an Embedded Coder license, you can configure this description to appear in the generated code as a comment. See “Simulink data object descriptions” (Embedded Coder).

Example: `'This parameter represents the maximum rotation speed of the engine.'`

Data Types: `char`

Dimensions — Dimensions of parameter value

`[0 0]` (default) | row vector | character vector

Dimensions of the value stored in the `Value` property, returned as a row vector or specified as a character vector. When the `Value` property is empty (set to `''`), you can configure the `Dimensions`. Otherwise, the property is derived from `Value`.

When you set the `Value` property of the object, the object sets the value of the `Dimensions` property to a `double` row vector. The vector is the same vector that the `size` function returns.

If you are configuring the object as a model argument, and you intend to provide a value for the object elsewhere in the parent model reference hierarchy, you can leave the `Value` property empty (set to `''`) and set the `Dimensions` and `Data Type` properties explicitly. See “Parameterize Instances of a Reusable Referenced Model”.

To use symbolic dimensions, specify a character vector. See “Implement Dimension Variants for Array Sizes in Generated Code” (Embedded Coder).

Example: `[1 3]`

Example: `'[1 myDimParam]'`

Data Types: `double` | `char`

Max — Maximum value of parameter

`[]` (default) | real `double` scalar

Maximum value that the `Value` property of the object can store, specified as a real `double` scalar.

The default value is empty, which means the parameter value does not have a maximum.

If you store a complex number in the `Value` property, the `Max` property applies separately to the real and imaginary parts.

If you store a structure in the `Value` property, the object ignores the `Max` property. Instead, use a `Simulink.Bus` object as the data type of the parameter object and specify a maximum value for each field by using the elements of the bus object. See “Control Field Data Types and Characteristics by Creating Parameter Object”.

If `Value` is greater than the maximum value or if the maximum value is outside the range of the object data type, Simulink generates a warning. When updating the diagram or starting a simulation, Simulink generates an error.

For more information about how Simulink uses this property, see “Specify Minimum and Maximum Values for Block Parameters”.

Example: `5.32`

Data Types: `double`

Min — Minimum value of parameter

`[]` (default) | real `double` scalar

Minimum value that the `Value` property of the object can store, specified as a real `double` scalar.

The default value is empty, which means the parameter value does not have a minimum.

If you store a complex number in the `Value` property, the `Min` property applies separately to the real and imaginary parts.

If you store a structure in the `Value` property, the object ignores the `Min` property. Instead, use a `Simulink.Bus` object as the data type of the parameter object and specify a minimum value for each field by using the elements of the bus object. See “Control Field Data Types and Characteristics by Creating Parameter Object”.

If `Value` is less than the minimum value or if the minimum value is outside the range of the object data type, Simulink generates a warning. When updating the diagram or starting a simulation, Simulink generates an error.

For more information about how Simulink uses this property, see “Specify Minimum and Maximum Values for Block Parameters”

Example: `-0.92`

Data Types: `double`

Unit — Physical unit of parameter value

`' '` (default) | character vector

Physical unit of parameter value, specified as a character vector that describes a valid unit. For more information, see “Unit Specification in Simulink Models”.

Example: `'degC'`

Data Types: `char`

Value — Value to use in block parameters

`[]` (default) | numeric | boolean | enum | structure | scalar | array | <mathematical expression>

Value to use in block parameters, specified as any of these valid values:

- Numeric value
- Boolean value
- Instance of enumerated type
- Structure
- Scalar or array
- Mathematical expression (see “Set Variable Value by Using a Mathematical Expression”)

If you use a `Simulink.Parameter` object to set the block parameter value in a reusable referenced model, you can compile and simulate the model as a referenced model with the value for the object left empty (`Value` set to `'[]'`) as long as you provide an explicit value somewhere in the parent model reference hierarchy. In this case, you cannot simulate the model directly. When the value is empty, you must provide the `Data Type` and `Dimensions` for the object. Although you have specified an empty value, Simulink still synthesizes a `Value` by using one of these:

- `Max`.
- `Min`, if you have not specified `Max`.
- `1`, if you have not specified either `Min` or `Max`.

See “Parameterize Instances of a Reusable Referenced Model”.

You can also use MATLAB syntax to specify the value.

| Example Expression | Description |
|------------------------------|--|
| 15.23 | Specifies a scalar value |
| [3 4; 9 8] | Specifies a matrix |
| 3+2i | Specifies a complex value |
| struct('A',20,'B',5) | Specifies a structure with two fields, A and B, with double-precision values 20 and 5. Organize block parameters into structures (see “Organize Related Block Parameter Definitions in Structures”) or initialize the signal elements in a bus (see “Specify Initial Conditions for Bus Elements”). |
| slexpr('myVar + myOtherVar') | Specifies the expression myVar + myOtherVar where myVar and myOtherVar are other MATLAB variables or parameter objects. Simulink preserves this mathematical relationship between the object and the variables. |

To use a `Simulink.Parameter` object to store a value of a particular numeric data type, specify the ideal value with the `Value` property and control the type with the `DataType` property.

If you set the `Value` property by using a typed expression such as `single(32.5)`, the `DataType` property changes to reflect the new type. A best practice is to use an expression that is not typed to avoid accumulating numerical error through repeated quantizations or data type saturation, especially for fixed-point data types.

Example: 3.15

Example: 1.2 + 3.2i

Example: true

Example: myEnumType.myEnumValue

Example: struct('field1',15,'field2',7.32)

Example: slexpr('myVar + myOtherVar')

Data Types: double | single | int8 | int16 | int32 | int64 | uint8 | uint16 | uint32 | uint64 | logical | struct | fi | enum

Complex Number Support: Yes

Examples

Use Parameter Object to Set Value of Gain Parameter

- 1 At the command prompt, create a `Simulink.Parameter` object.

```
myParam = Simulink.Parameter;
```

- 2 Assign a numeric value to the `Value` property.

```
myParam.Value = 15.23;
```

- 3 Specify the minimum and maximum values the parameter can take with the `Min` and `Max` properties.

```
myParam.Min = 10.11;
myParam.Max = 25.27;
```

- 4 Open a new Simulink model. Add a Gain block and set its **Gain** parameter to `myParam`. During simulation, the **Gain** parameter uses the value 15.23.

Change Value Stored by Parameter Object

- 1 At the command prompt, create a `Simulink.Parameter` object that stores the value 2.52.

```
myParam = Simulink.Parameter(2.52);
```

- 2 Change the value by accessing the `Value` property of the object. This technique preserves the values of the other properties of the object.

```
myParam.Value = 1.13;
```

Create Parameter Object with Specific Numeric Data Type

To reduce model maintenance, you can leave the `DataType` property at its default value, `auto`. The parameter object acquires a data type from the block parameter that uses the object.

To reduce the risk of the data type changing when you make changes to signal data types and other data types in your model, you can explicitly specify a data type for the parameter object. For example, when you generate code that exports parameter data to your custom code, explicitly specify a data type for the object.

- 1 At the MATLAB command prompt, create a `Simulink.Parameter` object that stores the value 18.25.

```
myParam = Simulink.Parameter(18.25);
```

The expression `18.25` returns the number 18.25 with the double-precision, floating-point data type `double`. The `Value` property stores the number 18.25 with double precision.

- 2 Use the `DataType` property to specify the single-precision data type `single`.

```
myParam.DataType = 'single';
```

When you simulate or generate code, the object casts the value of the `Value` property, 18.25, to the data type specified by the `DataType` property, `single`.

Set Parameter Value to a Mathematical Expression

This example shows how to set the value of a parameter object, `myParam`, to the sum of two other variables, `myVar` and `myOtherVar`. With this technique, when you change the values of the independent variables, Simulink immediately calculates the new value of the parameter object.

- 1 Create the two independent variables.

```
myVar = 5.2;  
myOtherVar = 9.8;
```

- 2 Create the parameter object.

```
myParam = Simulink.Parameter;
```

- 3 Set the value of the parameter object to the expression `myVar + myOtherVar`.

```
myParam.Value = slexpr('myVar + myOtherVar')
```

When you simulate or generate code, the expression evaluates to 15.

See Also

[Simulink.Signal](#) | [Simulink.CoderInfo](#) | [AUTOSAR.Parameter](#) | [Simulink.LookupTable](#) | [Simulink.Breakpoint](#) | [Simulink.AliasType](#)

Topics

["Data Objects"](#)

["Set Block Parameter Values"](#)

["How Generated Code Stores Internal Signal, State, and Parameter Data" \(Simulink Coder\)](#)

["Determine Where to Store Variables and Objects for Simulink Models"](#)

["Data Types Supported by Simulink"](#)

["Define Data Classes"](#)

Introduced before R2006a

Simulink.sdi.DiffRunResult

Access run comparison results

Description

The `Simulink.sdi.DiffRunResult` object provides access to run comparison metadata and comparison results. Use the `getSignalByIndex` function to access the metadata and comparison results for each signal in the run comparison.

Creation

A `Simulink.sdi.DiffRunResult` object is created when you perform a comparison using the Simulation Data Inspector.

When you compare data using the UI, use the `Simulink.sdi.getCurrentComparison` function to access the results in a `Simulink.sdi.DiffRunResult` object.

Programmatic comparisons using the `Simulink.sdi.compareRuns` function or the `compare` function return a `DiffRunResult` object.

Properties

MatlabVersion — Software version used to create object

character vector

This property is read-only.

Version of MATLAB used to create the `DiffRunResult` object, returned as a character vector.

RunID1 — Baseline run ID

integer

This property is read-only.

Run identifier for the comparison baseline run, returned as an integer.

RunID2 — ID for run to compare

integer

This property is read-only.

Run identifier of the run to compare, returned as an integer.

Count — Number of signals compared

integer

This property is read-only.

Number of signals that aligned between the two runs in the comparison, returned as an integer. For more information on how signals are aligned for comparisons, see “Signal Alignment”.

DateCreated — Object creation date

`datetime`

This property is read-only.

Date and time the `Simulink.sdi.DiffRunResult` object was created, returned as a `datetime` object.

Data Types: `datetime`

GlobalTolerance — Global tolerance values used for comparison

`structure`

This property is read-only.

Global tolerance values used for the run comparison, returned as a structure with fields:

- `AbsTol` — Global absolute tolerance used for the run comparison.
- `RelTol` — Global relative tolerance used for the run comparison.
- `TimeTol` — Global time tolerance used for the run comparison.

For more information about how tolerances are used and calculated for comparisons, see “Tolerance Specification”.

Summary — Comparison results summary

`structure`

This property is read-only.

Comparison results summary, returned as a structure with a field for each `Status` a signal comparison result could have. The value of each field indicates the number of signals in the run comparison with the corresponding `Status`.

- `WithinTolerance` — Signal comparison completed, and all data points compared fell within the specified tolerance.
- `OutOfTolerance` — Signal comparison completed, and some data points compared fell outside of the specified tolerance.
- `Unaligned` — Signal from the baseline run did not align with a signal in the run to compare.
- `Empty` — Aligned signal in the baseline run or run to compare contains no data.
- `EmptySynced` — Synchronized signal in the baseline run or run to compare contains no data. An empty synchronized signal can mean that the signals do not overlap or, if you specified the intersection synchronization method, that they included none of the same time points.
- `Canceled` — Signal result not computed because the user canceled the comparison.
- `Pending` — Comparison is in progress and the signal result computation has not started.
- `Processing` — Signal result computation in progress.
- `UnitsMismatch` — The signal units in the baseline run and run to compare do not match.
- `DataTypeMismatch` — The signal data types in the baseline run and run to compare do not match. Only results of comparisons configured to check signal data types can have this status.

- **TimeMismatch** — The signal time vectors in the baseline run and run to compare do not match. Only results of comparisons configured to check signal time vectors can have this status.
- **StartStopMismatch** — The signal start and stop times in the baseline run and run to compare do not match. Only results of comparisons configured to check signal start and stop times can have this status.
- **Unsupported** — The Simulation Data Inspector comparison algorithm does not support this type of signal. For example, signals with data types that lose precision when converted to `double` are not supported.

For more information about alignment, tolerances, and synchronization, see “How the Simulation Data Inspector Compares Data”. For more information about how to configure a comparison to check additional metadata, see `Simulink.sdi.compareRuns`.

Options — Comparison configuration

`n-by-2` cell array

This property is read-only.

Configuration options used for the comparison, returned as an `n-by-2` cell array. Each row in the cell array corresponds to an option used by the comparison. Every comparison requires that aligned signal units match, so the `Options` property always includes a row to indicate that units must match. Other possible configuration options correspond to these name-value pairs for the `Simulink.sdi.compareRuns` function:

- `DataType`
- `Time`
- `StartStop`
- `StopOnFirstMismatch`

Status — Status of run comparison

`Completed` | `Canceled` | `Stopped`

This property is read-only.

Status of the run comparison, indicating how the comparison ended, returned as one of the following:

- `Completed` — Comparison finished computing all results
- `Canceled` — Comparison ended because the user canceled the comparison operation in the UI
- `Stopped` — Comparison ended because the comparison detected a mismatch and was configured to stop on the first mismatch

StopReason — Signal result that stopped the run comparison

`Simulink.sdi.DiffSignalResult`

This property is read-only.

Signal result for signal comparison that caused the run comparison to stop without comparing remaining signals, returned as a `Simulink.sdi.DiffSignalResult` object. The `StopReason` property is empty when the comparison completes without detecting a mismatch and when the comparison is not configured to stop on the first mismatch. You can configure a simulation to stop on the first mismatch using the `Simulink.sdi.compareRuns` function and the `'StopOnFirstMismatch'` name-value pair.

Object Functions

getResultByIndex Return signal comparison result
 saveResult Save comparison results to an MLDATX file

Examples

Analyze Simulation Data Using Signal Tolerances

You can programmatically specify signal tolerance values to use in comparisons performed using the Simulation Data Inspector. In this example, you compare data collected by simulating a model of an aircraft longitudinal flight control system. Each simulation uses a different value for the input filter time constant and logs the input and output signals. You analyze the effect of the time constant change by comparing results using the Simulation Data Inspector and signal tolerances.

First, load the session file that contains the simulation data.

```
Simulink.sdi.load('AircraftExample.mldatx');
```

The session file contains four runs. In this example, you compare data from the first two runs in the file. Access the `Simulink.sdi.Run` objects for the first two runs loaded from the file.

```
runIDs = Simulink.sdi.getAllRunIDs;  
runIDTs1 = runIDs(end-3);  
runIDTs2 = runIDs(end-2);
```

Now, compare the two runs without specifying any tolerances.

```
noTolDiffResult = Simulink.sdi.compareRuns(runIDTs1,runIDTs2);
```

Use the `getResultByIndex` function to access the comparison results for the `q` and `alpha` signals.

```
qResult = getResultByIndex(noTolDiffResult,1);  
alphaResult = getResultByIndex(noTolDiffResult,2);
```

Check the `Status` of each signal result to see whether the comparison result fell within our out of tolerance.

```
qResult.Status
```

```
ans =  
    ComparisonSignalStatus enumeration  
    OutOfTolerance
```

```
alphaResult.Status
```

```
ans =  
    ComparisonSignalStatus enumeration  
    OutOfTolerance
```

The comparison used a value of 0 for all tolerances, so the `OutOfTolerance` result means the signals are not identical.

You can further analyze the effect of the time constant by specifying tolerance values for the signals. Specify the tolerances by setting the properties for the `Simulink.sdi.Signal` objects that

correspond to the signals being compared. Comparisons use tolerances specified for the baseline signals. This example specifies a time tolerance and an absolute tolerance.

To specify a tolerance, first access the `Signal` objects from the baseline run.

```
runTs1 = Simulink.sdi.getRun(runIDTs1);
qSig = getSignalsByName(runTs1,'q, rad/sec');
alphaSig = getSignalsByName(runTs1,'alpha, rad');
```

Specify an absolute tolerance of 0.1 and a time tolerance of 0.6 for the `q` signal using the `AbsTol` and `TimeTol` properties.

```
qSig.AbsTol = 0.1;
qSig.TimeTol = 0.6;
```

Specify an absolute tolerance of 0.2 and a time tolerance of 0.8 for the `alpha` signal.

```
alphaSig.AbsTol = 0.2;
alphaSig.TimeTol = 0.8;
```

Compare the results again. Access the results from the comparison and check the `Status` property for each signal.

```
tolDiffResult = Simulink.sdi.compareRuns(runIDTs1, runIDTs2);
qResult2 = getResultByIndex(tolDiffResult,1);
alphaResult2 = getResultByIndex(tolDiffResult,2);
```

```
qResult2.Status
```

```
ans =
  ComparisonSignalStatus enumeration
    WithinTolerance
```

```
alphaResult2.Status
```

```
ans =
  ComparisonSignalStatus enumeration
    WithinTolerance
```

Configure Comparisons to Check Metadata

You can use the `Simulink.sdi.compareRuns` function to compare signal data and metadata, including data type and start and stop times. A single comparison may check for mismatches in one or more pieces of metadata. When you check for mismatches in signal metadata, the `Summary` property of the `Simulink.sdi.DiffRunResult` object may differ from a basic comparison because the `Status` property for a `Simulink.sdi.DiffSignalResult` object can indicate the metadata mismatch. You can configure comparisons using the `Simulink.sdi.compareRuns` function for imported data and for data logged from a simulation.

This example configures a comparison of runs created from workspace data three ways to show how the Summary of the DiffSignalResult object can provide specific information about signal mismatches.

Create Workspace Data

The `Simulink.sdi.compareRuns` function compares time series data. Create data for a sine wave to use as the baseline signal, using the `timeseries` format. Give the `timeseries` the name `Wave Data`.

```
time = 0:0.1:20;
sig1vals = sin(2*pi/5*time);
sig1_ts = timeseries(sig1vals,time);
sig1_ts.Name = 'Wave Data';
```

Create a second sine wave to compare against the baseline signal. Use a slightly different time vector and attenuate the signal so the two signals are not identical. Cast the signal data to the `single` data type. Also name this `timeseries` object `Wave Data`. The Simulation Data Inspector comparison algorithm will align these signals for comparison using the name.

```
time2 = 0:0.1:22;
sig2vals = single(0.98*sin(2*pi/5*time2));
sig2_ts = timeseries(sig2vals,time2);
sig2_ts.Name = 'Wave Data';
```

Create and Compare Runs in the Simulation Data Inspector

The `Simulink.sdi.compareRuns` function compares data contained in `Simulink.sdi.Run` objects. Use the `Simulink.sdi.createRun` function to create runs in the Simulation Data Inspector for the data. The `Simulink.sdi.createRun` function returns the run ID for each created run.

```
runID1 = Simulink.sdi.createRun('Baseline Run','vars',sig1_ts);
runID2 = Simulink.sdi.createRun('Compare to Run','vars',sig2_ts);
```

You can use the `Simulink.sdi.compareRuns` function to compare the runs. The comparison algorithm converts the signal data to the `double` data type and synchronizes the signal data before computing the difference signal.

```
basic_DRR = Simulink.sdi.compareRuns(runID1,runID2);
```

Check the `Summary` property of the returned `Simulink.sdi.DiffRunResult` object to see the result of the comparison.

```
basic_DRR.Summary
ans = struct with fields:
    OutOfTolerance: 1
    WithinTolerance: 0
    Unaligned: 0
    UnitsMismatch: 0
    Empty: 0
    Canceled: 0
    EmptySynced: 0
    DataTypeMismatch: 0
    TimeMismatch: 0
    StartStopMismatch: 0
```

```
Unsupported: 0
```

The difference between the signals is out of tolerance.

Compare Runs and Check for Data Type Match

Depending on your system requirements, you may want the data types for signals you compare to match. You can use the `Simulink.sdi.compareRuns` function to configure the comparison algorithm to check for and report data type mismatches.

```
dataType_DRR = Simulink.sdi.compareRuns(runID1,runID2, 'DataType', 'MustMatch');  
dataType_DRR.Summary
```

```
ans = struct with fields:  
    OutOfTolerance: 0  
    WithinTolerance: 0  
    Unaligned: 0  
    UnitsMismatch: 0  
    Empty: 0  
    Canceled: 0  
    EmptySynced: 0  
    DataTypeMismatch: 1  
    TimeMismatch: 0  
    StartStopMismatch: 0  
    Unsupported: 0
```

The result of the signal comparison is now `DataTypeMismatch` because the data for the baseline signal is double data type, while the data for the signal compared to the baseline is single data type.

Compare Runs and Check for Start and Stop Time Match

You can use the `Simulink.sdi.compareRuns` function to configure the comparison algorithm to check whether the aligned signals have the same start and stop times.

```
startStop_DRR = Simulink.sdi.compareRuns(runID1,runID2, 'StartStop', 'MustMatch');  
startStop_DRR.Summary
```

```
ans = struct with fields:  
    OutOfTolerance: 0  
    WithinTolerance: 0  
    Unaligned: 0  
    UnitsMismatch: 0  
    Empty: 0  
    Canceled: 0  
    EmptySynced: 0  
    DataTypeMismatch: 0  
    TimeMismatch: 0  
    StartStopMismatch: 1  
    Unsupported: 0
```

The signal comparison result is now `StartStopMismatch` because the signals created in the workspace have different stop times.

Alternatives

You can view and inspect comparison results using the Simulation Data Inspector UI. For more information, see “Compare Simulation Data”.

For software tests, see the `Simulink.sdi.constraints.MatchesSignal` constraint.

See Also

`Simulink.sdi.compareRuns` | `Simulink.sdi.DiffSignalResult` | `compare`

Topics

“Inspect and Compare Data Programmatically”

“How the Simulation Data Inspector Compares Data”

“Compare Simulation Data”

Introduced in R2012b

Simulink.sdi.DiffSignalResult

Access signal comparison results

Description

When you compare runs or signals using the **Simulation Data Inspector**, the results are returned as either a `Simulink.sdi.DiffSignalResult` object or a `Simulink.sdi.DiffRunResult` object that contains one or more `Simulink.sdi.DiffSignalResult` objects. The `DiffSignalResult` object contains the data and metadata for signal comparison results, such as the difference signal, tolerance data, and the synchronized signal data.

Creation

When you use the Simulation Data Inspector to compare runs or signals, you can access signal comparison results in a `Simulink.sdi.DiffSignalResult` object two ways:

- By using the `Simulink.sdi.compareSignals` function to compare signals.
- By using the `getResultByIndex` function to access `DiffSignalResult` objects in `Simulink.sdi.DiffRunResult` objects.

Properties

Name — Baseline signal name

character vector

This property is read-only.

Baseline signal name, returned as a character vector. When comparison results are complex, the name of the `DiffSignalResult` object that contains the real data is appended with `(real)`, and the name of the `DiffSignalResult` object that contains the imaginary data is appended with `(imag)`.

Status — Comparison result signal status

`WithinTolerance` | `OutOfTolerance` | `Unaligned` | `Pending` | `Processing` | ...

This property is read-only.

Status of the signal comparison corresponding to the `DiffSignalResult` object, returned as one of the following options. The status can indicate where a given signal comparison is in the comparison process during a long comparison, or it can indicate information about the result of the signal comparison.

- `WithinTolerance` — Signal comparison completed, and all data points compared fell within the specified tolerance.
- `OutOfTolerance` — Signal comparison completed, and some data points compared fell outside of the specified tolerance.

- **Unaligned** — Signal from the baseline run did not align with a signal in the run to compare.
- **Empty** — Aligned signal in the baseline run or run to compare contains no data.
- **EmptySynced** — Synchronized signal in the baseline run or run to compare contains no data. An empty synchronized signal can mean that the signals do not overlap or, if you specified the intersection synchronization method, that they included none of the same time points.
- **Canceled** — Signal result not computed because the user canceled the comparison or the algorithm ended the comparison before computing this signal result.
- **Pending** — Comparison is in progress and the signal result computation has not started.
- **Processing** — Signal result computation in progress.
- **UnitsMismatch** — The signal units in the baseline run and run to compare do not match.
- **DataTypeMismatch** — The signal data types in the baseline run and run to compare do not match. Only results of comparisons configured to check signal data types can have this status.
- **TimeMismatch** — The signal time vectors in the baseline run and run to compare do not match. Only results of comparisons configured to check signal time vectors can have this status.
- **StartStopMismatch** — The signal start and stop times in the baseline run and run to compare do not match. Only results of comparisons configured to check signal start and stop times can have this status.
- **Unsupported** — The Simulation Data Inspector comparison algorithm does not support this type of signal. For example, signals with data types that lose precision when converted to `double` are not supported.

For more information about alignment, tolerances, and synchronization, see “How the Simulation Data Inspector Compares Data”. For more information about configuring comparisons to check for additional metadata, see `Simulink.sdi.compareRuns`.

AlignBy — Property by which signals aligned for comparison

character vector

This property is read-only.

Property by which signals aligned in a run comparison, returned as a character vector. When the `DiffSignalResult` object was created from a signal comparison, the `AlignBy` property is empty. For more information about how run comparisons align signals, see “How the Simulation Data Inspector Compares Data”.

SignalID1 — Baseline signal ID

integer

This property is read-only.

Unique signal identifier for the baseline signal in the comparison, returned as an integer.

SignalID2 — Signal ID of the signal to compare

integer

This property is read-only.

Unique signal identifier for the signal to compare against the baseline signal, returned as an integer.

MaxDifference — Maximum difference

double

This property is read-only.

Maximum difference between the two comparison signals, returned as a double.

Sync1 — Synchronized Baseline signal

`timeseries`

This property is read-only.

Synchronized baseline signal, returned as a `timeseries` object. For more information about synchronization, see “How the Simulation Data Inspector Compares Data”.

Sync2 — Synchronized Compare to signal

`timeseries`

This property is read-only.

Synchronized signal to compare, returned as a `timeseries` object. For more information about synchronization, see “How the Simulation Data Inspector Compares Data”.

Diff — Difference signal

`timeseries`

This property is read-only.

Difference signal resulting from the comparison, returned as a `timeseries` object.

Examples

Compare Two Signals in the Same Run

You can use the Simulation Data Inspector programmatic interface to compare signals within a single run. This example compares the input and output signals of an aircraft longitudinal controller.

First, load the session that contains the data.

```
Simulink.sdi.load('AircraftExample.mldatx');
```

Use the `Simulink.sdi.Run.getLatest` function to access the latest run in the data.

```
aircraftRun = Simulink.sdi.Run.getLatest;
```

Then, you can use the `Simulink.sdi.getSignalsByName` function to access the `Stick` signal, which represents the input to the controller, and the `alpha, rad` signal that represents the output.

```
stick = getSignalsByName(aircraftRun, 'Stick');  
alpha = getSignalsByName(aircraftRun, 'alpha, rad');
```

Before you compare the signals, you can specify a tolerance value to use for the comparison. Comparisons use tolerance values specified for the baseline signal in the comparison, so set an absolute tolerance value of `0.1` on the `Stick` signal.

```
stick.AbsTol = 0.1;
```

Now, compare the signals using the `Simulink.sdi.compareSignals` function. The `Stick` signal is the baseline, and the `alpha, rad` signal is the signal to compare against the baseline.

```
comparisonResults = Simulink.sdi.compareSignals(stick.ID,alpha.ID);
match = comparisonResults.Status

match =
    ComparisonSignalStatus enumeration

    OutOfTolerance
```

The comparison result is out of tolerance. You can use the `Simulink.sdi.view` function to open the Simulation Data Inspector to view and analyze the comparison results.

Alternatives

You can view and inspect comparison results using the Simulation Data Inspector UI. For more information, see “Compare Simulation Data”.

See Also

Functions

`Simulink.sdi.compareRuns` | `Simulink.sdi.compareSignals` | `getResultByIndex`

Objects

`Simulink.sdi.DiffRunResult`

Tools

Simulation Data Inspector

Topics

“Inspect and Compare Data Programmatically”
“How the Simulation Data Inspector Compares Data”
“Compare Simulation Data”

Introduced in R2012b

Simulink.profiler.Data

Programmatically access Simulink Profiler information

Description

The `Simulink.profiler.Data` object provides access to simulation profiling metadata.

Creation

Access the `Simulink.profiler.Data` object from the `SimulationMetadata.TimingInfo` field of the `Simulink.SimulationOutput` object.

Properties

run — Profiling session identifier

character vector | string scalar

This is a read only property.

Identifier of the profiling session, returned as a character vector or string scalar.

Example: 'vdp @ 21-Nov-2019 13:48:00'

Data Types: char | string

UserString — User documentation of profiling session

"" (default) | character vector | string scalar

Use the `UserString` field to document relevant information about the current profiling session

Example: `profilingData.UserString = "Updated gain to reduce chatter.";`

Data Types: char | string

rootUINode — Block hierarchy of the model

`Simulink.profiler.UINode` object

Block hierarchy of the model, returned as a `Simulink.profiler.UINode` object with the following fields:

| Field | Value | Description |
|----------------------------|--------|---|
| <code>totalTime</code> | double | Execution time of the block, as well as its children. |
| <code>selfTime</code> | double | Execution time of the block, excluding its children |
| <code>numberOfCalls</code> | double | Number of times the block was executed during the simulation. |

| Field | Value | Description |
|----------|--------------------------------|--|
| children | Simulink.profiler.UINode array | Contents of the current block |
| path | string scalar | Path of the block relative to the top level of the model. Note The path of the rootUINode field is the name of the model |

A `Simulink.profiler.UINode` object corresponds to a row in the block hierarchy view of the Simulink Profiler.

rootExecNode — Execution stack of the model

`Simulink.profiler.ExecNode`

Execution phases of the model, returned as a `Simulink.profiler.ExecNode` object with the following fields:

| Field | Value | Description |
|---------------|----------------------------------|---|
| totalTime | double | Execution time of the stack element, as well as its children. |
| selfTime | double | Execution time of the stack element, excluding its children |
| numberOfCalls | double | Number of times the stack element was executed during the simulation. |
| location | | Specific phase of the model's execution |
| children | Simulink.profiler.ExecNode array | Similar tasks corresponding to the execution phase of the parent. |
| objectPath | string scalar | Path of the model element corresponding to the current element of the execution stack. Note The objectPath field of the rootExecNode is the name of the model |

A `Simulink.profiler.ExecNode` object corresponds to a row in the execution stack view of the Simulink Profiler.

See Also

Simulink Profiler

Topics

“Understanding Total Time and Self Time in Profiler Reports”

“How Profiler Captures Performance Data”

Introduced in R2020a

Simulink.sdi.Run

Access run signals and metadata

Description

The `Simulink.sdi.Run` object contains run metadata and allows you to access the `Simulink.sdi.Signal` objects that contain data and metadata for the signals in the run. You can also use a `Simulink.sdi.Run` object to import data into the Simulation Data Inspector from the workspace or a file.

Creation

The Simulation Data Inspector creates `Simulink.sdi.Run` objects when you import data or simulate a model that logs data. You can access a Run object in the Simulation Data Inspector three ways:

- When you want to access a run that corresponds to a specific run ID, use the `Simulink.sdi.getRun` function.

Tip Use the `Simulink.sdi.getAllRunIDs` function to get the run IDs for all the runs in the Simulation Data Inspector.

- When you want to access the most recently created run in the Simulation Data Inspector, use the `Simulink.sdi.Run.getLatest` function.
- When you want to access the run that corresponds to the in-progress or most recently completed simulation of a model, use the `Simulink.sdi.getCurrentSimulationRun` function.

You can also programmatically create a `Simulink.sdi.Run` object to import data into the Simulation Data Inspector.

- Create an empty run in the Simulation Data Inspector using the `Simulink.sdi.Run.create` function.
- Create an empty run in the Simulation Data Inspector or import data into the Simulation Data Inspector using the `Simulink.sdi.createRun`.

Tip Use the `add` function or the `Simulink.sdi.addToRun` function to import data into an empty Run object.

Properties

ID — Run ID

integer

This property is read-only.

Unique numerical identification for the run, returned as an integer.

Name — Run name

character vector | string

Run name, specified as a character vector or string.

By default, the `Name` property is empty when you use the `Simulink.sdi.Run.create` function to create a run.

You can specify the run name when you use the `Simulink.sdi.createRun` function to create a run.

When you create a run by simulating a model that logs data, the run name is generated according to the run-naming rule in the Simulation Data Inspector. You can modify the run-naming rule in the Simulation Data Inspector in the UI or by using the `Simulink.sdi.setRunNamingRule` function.

Example: 'Run 1: vdp'

Description — Run description

[] (default) | character vector | string

Description of the run, specified as a character vector or string. By default, `Description` is empty. Use the `Description` property to add notes about the significance of the data within the run, like the test or simulation conditions used to create the data.

Example: 'Initial simulation'

Tag — Information tag

[] (default) | character vector | string

Tag for additional run information, specified as a character vector or string. By default, `Tag` is empty. You can use the `Tag` property to attach additional information to the `Run` object. For example, you could use the `Tag` property to include parameter values used for the simulation that created the run in the `Run` object metadata.

Example: 'Gain = 2'

DateCreated — Run creation timestamp

datetime object

Date and time the run was created, returned as a `datetime` object.

Example: 07-Dec-2019 13:55:25

Data Types: `datetime`

RunIndex — Index of run in Simulation Data Inspector

integer

This property is read-only.

Index of the run in the Simulation Data Inspector when the run was created, returned as an integer. The `RunIndex` matches the run number in the run name when you use the run index as part of the run-naming rule.

If you delete runs from the Simulation Data Inspector, the value of the `RunIndex` property may not match the index of the run ID in the vector returned by the `Simulink.sdi.getAllRunIDs` function.

SignalCount — Number of signals in run

integer

This property is read-only.

Number of signals in the run, returned as an integer.

Model — Model simulated to create run

character vector

Name of the model simulated to create the run, returned as a character vector. The `Model` property is empty for runs created by importing data into the Simulation Data Inspector.

SimMode — Simulation mode

character vector

Simulation mode used in the simulation that created the run, returned as a character vector. The `SimMode` property is empty for runs created by importing data into the Simulation Data Inspector.

StartTime — Run start time

scalar

First time point shared by all signals in the run, returned as a scalar.

StopTime — Run stop time

scalar

Last time point shared by all signals in the run, returned as a scalar.

SLVersion — Software version used for model simulation that created run

character vector

Version of Simulink used for the simulation that created the run, returned as a character vector. The `SLVersion` property is empty for runs created by importing data into the Simulation Data Inspector.

ModelVersion — Version of model simulated to create run

character vector

Version of the model that was simulated to create the run, returned as a character vector. The version of a model is stored in its model properties. The `ModelVersion` property is empty for runs created by importing data into the Simulation Data Inspector.

UserID — System account

character vector

System account used to perform the simulation that created the run, returned as a character vector. The `UserID` property is empty for runs created by importing data into the Simulation Data Inspector.

MachineName — Name of machine used for simulation

character vector

Name of the machine used to perform the simulation that created the run, returned as a character vector. The `MachineName` property is empty for runs created by importing data into the Simulation Data Inspector.

Platform — Operating system on machine used for simulation

character vector

Operating system on the machine used to perform the simulation, returned as a character vector. The `Platform` property is empty for runs that do not correspond to a simulation.

Example: 'PCWIN64'

TaskName — Task name

[] (default) | character vector

Name of the simulation task that corresponds to the run, returned as a character vector. The `TaskName` property is empty unless the run was created using Parallel Computing Toolbox workers.

SolverType — Type of solver used in simulation that created run

'Variable-Step' | 'Fixed-Step'

Type of solver used in the simulation that created the run, returned as 'Variable-Step' or 'Fixed-Step'. The `SolverType` property is empty for runs created by importing data into the Simulation Data Inspector.

SolverName — Name of solver used in simulation that created run

character vector

Name of the solver used in the simulation that created the run, returned as a character vector. The `SolverName` property is empty for runs created by importing data into the Simulation Data Inspector.

Example: ode45

SolverStepSize — Solver step size used in simulation

character vector

Step size used by the solver during the simulation, returned as a character vector. If the simulation used a fixed-step solver, the `SolverStepSize` property indicates the fixed step size used in the simulation. If the simulation used a variable-step solver, the `SolverStepSize` property indicates the maximum step size used in the simulation.

Example: '0.4'

Status — Simulation status

character vector

Simulation status, returned as a character vector. When the simulation is running, the `Status` property is 'Running'. When a simulation is paused or completes, the `Status` property takes the value from the `StopEvent` field of the `Simulink.SimulationMetadata` object `StopEvent` property. The `StopEvent` property has one of these values:

- `ReachedStopTime` — The simulation completed with no reported errors, not including errors reported in the `StopFcn` callback, which executes after the simulation stops.
- `ModelStop` — A block or solver stopped the simulation before the simulation stop time.
- `StopCommand` — A **Stop** button press or `set_param` function call ended the simulation.
- `DiagnosticError` — A reported error ended the simulation.
- `KeyboardControlC` — A Ctrl+C keyboard entry ended the simulation.
- `PauseCommand` — A **Pause** button press or `set_param` function call paused the simulation.
- `ConditionalPause` — A conditional breakpoint paused the simulation.

- **PauseTime** — A specified pause time paused the simulation.
- **StepForward** — The simulation paused after stepping forward while stepping through a simulation.
- **StepBackward** — The simulation paused after stepping backward while stepping through a simulation.
- **Timeout** — The simulation stopped after the simulation execution time exceeded the timeout time specified using the 'Timeout' name-value pair for the `sim` function.

StopEventSource — Block that issued stop event

`Simulink.SimulationData.BlockPath`

Block that issued the stop event that stopped the simulation, returned as a `Simulink.SimulationData.BlockPath` object.

StopEventDescription — Translated description of simulation stop

character vector

Translated description of the simulation stop, returned as a character vector. The `StopEventDescription` includes a description of the stop event and the associated simulation time, if applicable. The `StopEventDescription` property takes its value from the `StopEventDescription` field of the `Simulink.SimulationMetadata` object `ExecutionInfo` property.

Example: 'Pause command issued at time 100'

ExecutionErrors — Errors that occurred during simulation

character vector

Errors that occurred during simulation, returned as a character vector.

ExecutionWarnings — Warnings that occurred during simulation

character vector

Warnings that occurred during simulation, returned as a character vector.

ModelInitializationTime — Time to initialize model for simulation that created run

double

Time required to initialize the model for the simulation that created the run, returned as a double. The `ModelInitializationTime` property is empty for runs created by importing data into the Simulation Data Inspector.

ModelExecutionTime — Execution time for simulation that created run

double

Execution time for the simulation that created the run, returned as a double. The `ModelExecutionTime` property is empty for runs created by importing data into the Simulation Data Inspector.

ModelTerminationTime — Time to terminate simulation that created run

double

Time to terminate the simulation that created the run, returned as a double. The `ModelTerminationTime` property is empty for runs created by importing data into the Simulation Data Inspector.

ModelTotalElapsedTime — Total simulation time for simulation that created run

double

Total simulation time for the simulation that created the run, returned as a double. The `ModelTotalElapsedTime` property is empty for runs created by importing data into the Simulation Data Inspector.

UserString — User-specified string

character vector

User-specified string that corresponds to the simulation, returned as a character vector. Often, the `UserString` provides a brief description of the simulation. You specify the `UserString` for a simulation in the `Simulink.SimulationInput` object for the simulation.

Object Functions

| | |
|---------------------------------|--|
| <code>add</code> | Add signals to <code>Simulink.sdi.Run</code> object |
| <code>export</code> | Export run to base workspace or file |
| <code>getAllSignalIDs</code> | Get all signal IDs for signals in <code>Simulink.sdi.Run</code> object |
| <code>getAllSignals</code> | Get all signals in <code>Simulink.sdi.Run</code> object |
| <code>getDatasetRef</code> | Create a <code>Simulink.sdi.DatasetRef</code> object for a run |
| <code>getSignalByIndex</code> | Get signal in <code>Simulink.sdi.Run</code> object by index |
| <code>getSignalIDByIndex</code> | Get signal ID for signal at specified index in <code>Simulink.sdi.Run</code> object |
| <code>getSignalIDsByName</code> | Get signal IDs for signals inside <code>Simulink.sdi.Run</code> object using signal name |
| <code>getSignalsByName</code> | Access signals in a <code>Simulink.sdi.Run</code> object using signal name |
| <code>isValidSignalID</code> | Check whether signal ID corresponds to signal in <code>Simulink.sdi.Run</code> object |

Examples**Plot Signals from Simulation Run**

This example demonstrates how to access the `Simulink.sdi.Run` object for a Simulation Data Inspector run created by logging signals. From the `Simulink.sdi.Run` object you can get `Simulink.sdi.Signal` objects that contain the logged signal data and metadata. You can use the `Signal` objects and the `plotOnSubPlot` function to plot the data in the Simulation Data Inspector.

Create a Simulation Run and Access the Run Object

The `ex_vdp` model logs two signals. To create a simulation run containing the logged data, simulate the model.

```
sim('ex_vdp');
```

The Simulation Data Inspector keeps track of runs by assigning a unique numeric run ID to each run created by simulation, importing data, or opening a session. To access the run object for the simulation you just performed, use the `Simulink.sdi.getAllRunIDs` function and take the last run ID in the returned vector.

```
runIDs = Simulink.sdi.getAllRunIDs;
runID = runIDs(end);
```

Once you have the run ID for the run, you can use the `Simulink.sdi.getRun` function to get the `Simulink.sdi.Run` object that corresponds to the run. You can use the `Run` object to check the metadata associated with the run, including the number of signals in the run.

```
vdpRun = Simulink.sdi.getRun(runID);  
vdpRun.SignalCount  
ans = int32  
     2
```

Plot Data Using Signal Objects

Use the `getSignalByIndex` function to access signals from the Run object, `fuelRun`.

```
signal1 = getSignalByIndex(vdpRun,1);  
signal2 = getSignalByIndex(vdpRun,2);
```

Use the `Simulink.sdi.setSubPlotLayout` function to specify a 3-by-1 layout.

```
Simulink.sdi.setSubPlotLayout(2,1)
```

Before plotting the data, use the `Simulink.sdi.clearAllSubPlots` function to clear any data that is already plotted.

```
Simulink.sdi.clearAllSubPlots
```

Plot one signal on each subplot. To plot signals on the first subplot, you can set the checked property for the signal. To plot signals on subplots other than the first subplot, use the `plotOnSubPlot` function.

```
signal1.Checked = true;  
plotOnSubPlot(signal2,2,1,true);
```

View the Plotted Data

To view the plots you just created, open the Simulation Data Inspector using the `Simulink.sdi.view` function.

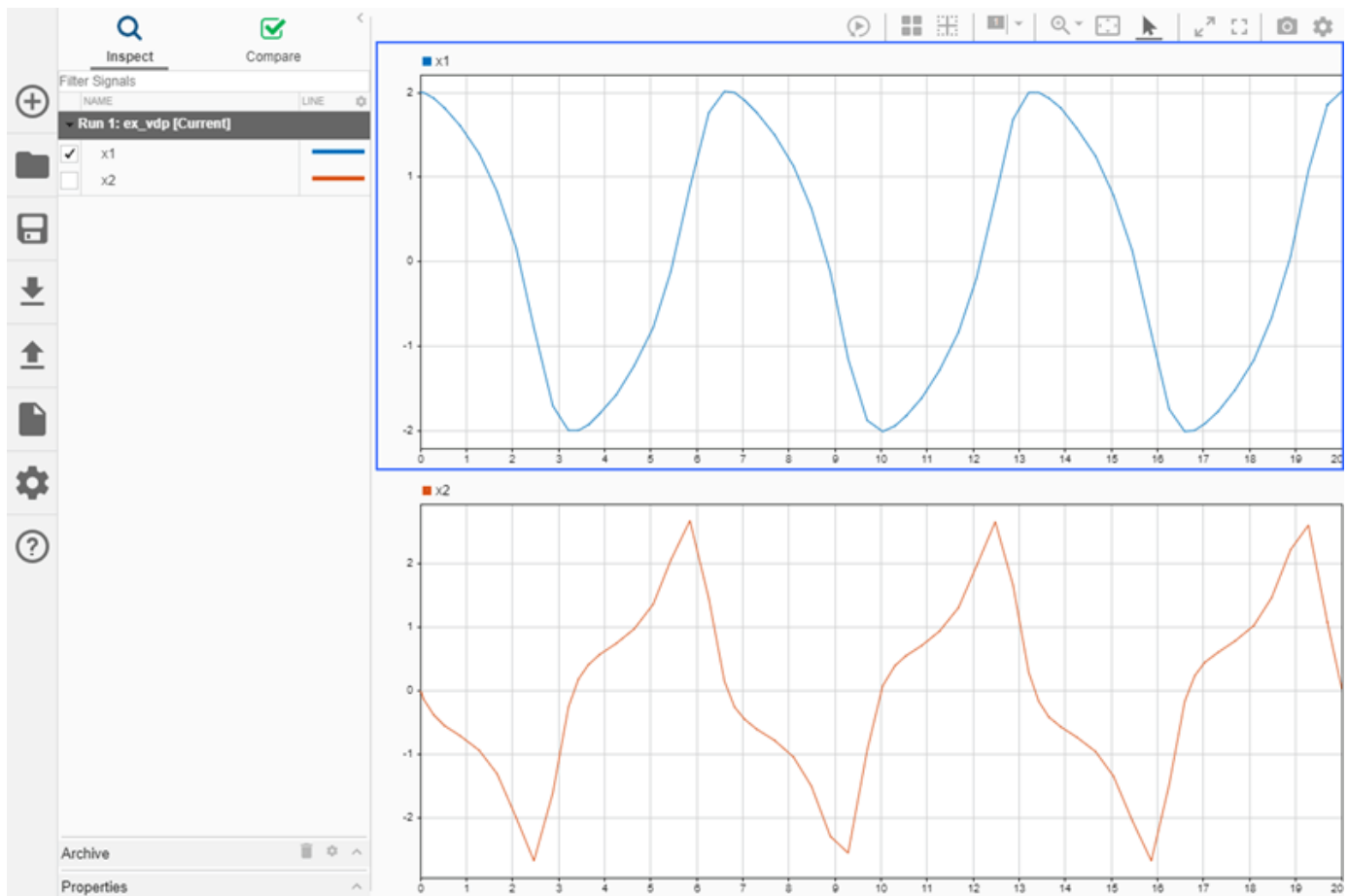

Create a Run and View the Data

This example shows how to create a run, add data to it, and then view the data in the Simulation Data Inspector.

Create Data for the Run

Create timeseries objects to contain data for a sine signal and a cosine signal. Give each timeseries object a descriptive name.

```
time = linspace(0,20,100);

sine_vals = sin(2*pi/5*time);
sine_ts = timeseries(sine_vals,time);
sine_ts.Name = 'Sine, T=5';

cos_vals = cos(2*pi/8*time);
cos_ts = timeseries(cos_vals,time);
cos_ts.Name = 'Cosine, T=8';
```

Create a Run and Add Data

Use the `Simulink.sdi.view` function to open the Simulation Data Inspector.

```
Simulink.sdi.view
```

To import data into the Simulation Data Inspector from the workspace, create a `Simulink.sdi.Run` object using the `Simulink.sdi.Run.create` function. Add information about the run to its metadata using the `Name` and `Description` properties of the Run object.

```
sinusoidsRun = Simulink.sdi.Run.create;
sinusoidsRun.Name = 'Sinusoids';
sinusoidsRun.Description = 'Sine and cosine signals with different frequencies';
```

Use the `add` function to add the data you created in the workspace to the empty run.

```
add(sinusoidsRun, 'vars', sine_ts, cos_ts);
```

Plot the Data in the Simulation Data Inspector

Use the `getSignalByIndex` function to access `Simulink.sdi.Signal` objects that contain the signal data. You can use the `Simulink.sdi.Signal` object properties to specify the line style and color for the signal and plot it in the Simulation Data Inspector. Specify the `LineColor` and `LineDashed` properties for each signal.

```
sine_sig = getSignalByIndex(sinusoidsRun,1);
sine_sig.LineColor = [0 0 1];
sine_sig.LineDashed = '-.';

cos_sig = sinusoidsRun.getSignalByIndex(2);
cos_sig.LineColor = [0 1 0];
cos_sig.LineDashed = '--';
```

Use the `Simulink.sdi.setSubPlotLayout` function to configure a 2-by-1 subplot layout in the Simulation Data Inspector plotting area. Then use the `plotOnSubPlot` function to plot the sine signal on the top subplot and the cosine signal on the lower subplot.

```
Simulink.sdi.setSubPlotLayout(2,1);

plotOnSubPlot(sine_sig,1,1,true);
plotOnSubPlot(cos_sig,2,1,true);
```

Close the Simulation Data Inspector and Save Your Data

When you have finished inspecting the plotted signal data, you can close the Simulation Data Inspector and save the session to an `MLDATX` file.

```
Simulink.sdi.close('sinusoids.mldatx')
```

Access Data from a Parallel Simulation

This example executes parallel simulations of the model `slexAircraftExample` with different input filter time constants and shows several ways to access the data using the Simulation Data Inspector programmatic interface.

Setup

Start by ensuring the Simulation Data Inspector is empty and Parallel Computing Toolbox support is configured to import runs created on local workers automatically. Then, create a vector of filter parameter values to use in each simulation.

```
% Make sure the Simulation Data Inspector is empty, and PCT support is
% enabled.
```

```

Simulink.sdi.clear
Simulink.sdi.enablePCTSupport('local')

% Define Ts values
Ts_vals = [0.01, 0.02, 0.05, 0.1, 0.2, 0.5, 1];

```

Initialize Parallel Workers

Use `gcp` to create a pool of local workers to run parallel simulations if you don't already have one. In an `spm` code block, load the `slexAircraftExample` model and select signals to log. To avoid data concurrency issues using `sim` in `parfor`, create a temporary directory for each worker to use during simulations.

```
p = gcp;
```

```
Starting parallel pool (parpool) using the 'local' profile ...
connected to 4 workers.
```

```
spmd
```

```

% Load system and select signals to log
load_system('slexAircraftExample')
Simulink.sdi.markSignalForStreaming('slexAircraftExample/Pilot', 1, 'on')
Simulink.sdi.markSignalForStreaming('slexAircraftExample/Aircraft Dynamics Model', 4, 'on')

% Create temporary directory on each worker
workDir = pwd;
addpath(workDir)
tempDir = tempname;
mkdir(tempDir)
cd(tempDir)

```

```
end
```

Run Parallel Simulations

Use `parfor` to run the seven simulations in parallel. Select the value for `Ts` for each simulation, and modify the value of `Ts` in the model workspace. Then, run the simulation and build an array of `Simulink.sdi.WorkerRun` objects to access the data with the Simulation Data Inspector. After the `parfor` loop, use another `spmd` segment to remove the temporary directories from the workers.

```
parfor index = 1:7
```

```

% Select value for Ts
Ts_val = Ts_vals(index);

% Change the filter time constant and simulate
modelWorkspace = get_param('slexAircraftExample', 'modelworkspace');
modelWorkspace.assignin('Ts', Ts_val)
sim('slexAircraftExample')

% Create a worker run for each simulation
workerRun(index) = Simulink.sdi.WorkerRun.getLatest

```

```
end
```

```
spmd
```



```

% Remove temporary directories
cd(workDir)
rmdir(tempDir, 's')
rmpath(workDir)

```

```
end
```

Get Dataset Objects from Parallel Simulation Output

The `getDataset` method puts the data from a `WorkerRun` into a `Dataset` object so you can easily post-process.

```
ds(7) = Simulink.SimulationData.Dataset;
```

```
for a = 1:7
    ds(a) = workerRun(a).getDataset;
end
ds(1)
```

```
ans =
Simulink.SimulationData.Dataset '' with 2 elements
```

| | Name | BlockPath |
|----------------|------------|--|
| 1 [1x1 Signal] | alpha, rad | ...rcraftExample/Aircraft Dynamics Model |
| 2 [1x1 Signal] | Stick | slexAircraftExample/Pilot |

- Use braces { } to access, modify, or add elements using index.

Get DatasetRef Objects from Parallel Simulation Output

For big data workflows, use the `getDatasetRef` method to reference the data associated with the `WorkerRun`.

```
for b = 1:7
    datasetRef(b) = workerRun(b).getDatasetRef;
end
```

```
datasetRef(1)
```

```
ans =
DatasetRef with properties:
    Name: 'Run 3: slexAircraftExample'
    Run: [1x1 Simulink.sdi.Run]
numElements: 2
```

Process Parallel Simulation Data in the Simulation Data Inspector

You can also create local `Run` objects to analyze and visualize your data using the Simulation Data Inspector API. This example adds a tag indicating the filter time constant value for each run.

```
for c = 1:7
    Runs(c) = workerRun(c).getLocalRun;
    Ts_val_str = num2str(Ts_vals(c));
    desc = strcat('Ts = ', Ts_val_str);
end
```

```
Runs(c).Description = desc;  
Runs(c).Name = strcat('slexAircraftExample run Ts=', Ts_val_str);
```

```
end
```

Clean Up Worker Repositories

Clean up the files used by the workers to free up disk space for other simulations you want to run on your worker pool.

```
Simulink.sdi.cleanupWorkerResources
```

Alternatives

You can view run metadata and import data using the Simulation Data Inspector UI. For more information, see “View Data in the Simulation Data Inspector”.

See Also

Objects

```
Simulink.sdi.Signal | Simulink.sdi.WorkerRun
```

Functions

```
Simulink.sdi.getRun | Simulink.sdi.createRun | Simulink.sdi.getRunIDByIndex |  
Simulink.sdi.setRunNamingRule | Simulink.sdi.addToRun | getLocalRun
```

Topics

“Inspect and Compare Data Programmatically”

Introduced in R2012b

Simulink.sdi.Signal

Access signal data and metadata

Description

A `Simulink.sdi.Signal` object contains data and metadata for a signal in the **Simulation Data Inspector**. You can use the `Signal` object properties to inspect signal metadata, visualize signals on time plots, and compare signals using the `Simulink.sdi.compareSignals` function.

Creation

A `Simulink.sdi.Signal` object is created for each signal you log in a model simulation or import into the Simulation Data Inspector. You can access `Signal` objects in the Simulation Data Inspector several ways. Generally, to access a `Signal` object, you first need to get the `Simulink.sdi.Run` object that contains the signal.

- The `Simulink.sdi.getSignal` function returns a `Signal` object that corresponds to the signal ID you provide.
- The `getSignal` function returns the `Signal` object with the specified signal ID inside the specified `Run` object.
- The `getSignalByIndex` function returns the `Signal` object at the specified index within the specified `Run` object.

Properties

Signal Properties

ID — Signal identifier

integer

This property is read-only.

Unique number identifying the signal, returned as an integer. The Simulation Data Inspector assigns a unique numeric ID to each run and signal.

RunID — Run identifier

integer

This property is read-only.

Run identifier for the run that contains the signal, returned as an integer. The Simulation Data Inspector assigns a unique numeric ID to each run and signal.

Name — Signal name

character vector | string

Name of the signal, specified as a character vector or a string. When the `Signal` object contains data logged from a simulation, the name matches the name specified for the signal in the model. If the

model does not specify the name, the signal name is the block path to the block that produces the signal.

Example: 'fuel'

Domain – Signal type

'Signals' | 'Outports' | 'States' | 'Data Store Memory' | 'Parameters' | ...

Signal type, specified as one of these options:

- 'Signals' – Signal logging data.
- 'Outports' – Output logging data.
- 'States' – States logging data.
- 'Data Store Memory' – Data store memory logging data.
- 'Parameters' – Logged parameter data.
- 'Stateflow' – Stateflow data.
- 'Simscape' – Simscape data.
- 'Assessments' – Simulink Test assessment data.
- 'Profiling' – Execution profiling data.

The Domain property is empty for data not created by logging simulation data.

Description – Signal description

' ' (default) | character vector | string

Description of the signal, specified as a character vector or a string. You can use the Description property to annotate the signal or identify the signal content beyond the Name. When you log Simscape data to the Simulation Data Inspector, the Description property is populated automatically for each node.

Stored Units – Units of signal data stored on disk

character vector | string

This property is read-only.

Units of signal data stored on disk, specified as a character vector or a string. For signals generated from simulating a model, the stored units of the Signal objects use the units specified in the model. When you specify display units for a signal without units, the same units are used to set the stored units. To analyze a signal alongside another that uses different units, modify the display units for the signal. The Simulation Data Inspector performs the conversion to plot the data using the display units.

You can convert the stored units for a signal using the convertUnits function. Stored unit conversion does not support undo and may result in precision loss.

Example: 'g/s'

Display Units – Units used to display signal data in the Simulation Data Inspector

character vector | string

Units used to display signal data in the Simulation Data Inspector, specified as a character vector or a string. The display units for a signal may differ from the stored units that reflect the data stored on disk. Modify signal display units to analyze data in the Simulation Data Inspector. Unit preferences in

the Simulation Data Inspector may change the display units for logged and imported signal data. For more information, see “Signal Display Units”.

Example: 'm/s'

Data Type — Data type for signal data

character vector | string

This property is read-only.

Data type of signal data, returned as a character vector or string.

Example: 'double'

Complexity — Complexity of signal data

"real" | "complex"

This property is read-only.

Complexity of signal data, returned as "real" or "complex".

Example: "real"

SampleTime — Signal sample time

character vector

This property is read-only.

Signal sample time, returned as a character vector or scalar. A value of 'Continuous' indicates a variable-step simulation.

Example: 'Continuous'

Example: '0.1'

Model — Name of model that produced signal

character vector

This property is read-only.

Name of the model that produced the signal, returned as a character vector. The `Model` property is empty for `Signal` objects that contain data that was not produced by simulating a model.

Example: 'sldemo_fuelsys'

BlockPath — Block path for block that produced signal

character vector

This property is read-only.

Block path for the block that produced the signal, returned as a character array. The `BlockPath` property is a relative path that does not include model hierarchy. The `BlockPath` property is empty for `Signal` objects that contain data that was not produced by simulating a model.

Example: 'sldemo_fuelsys/Engine Gas Dynamics'

FullBlockPath — Complete block path for block that produced the signal

character vector | cell array

This property is read-only.

Complete block path for the block that produced the signal, including the full model hierarchy, returned as a character vector. For signals within referenced models, `FullBlockPath` is a cell array that contains the full path. For other signals, `FullBlockPath` is identical to `BlockPath`. The `FullBlockPath` property is empty for `Signal` objects that contain data that was not produced by simulating a model.

BlockName — Name of block that produced signal

character vector

This property is read-only.

Name of the block that produced the signal, returned as a character vector. The `BlockName` property is empty for `Signal` objects that contain data that was not produced by simulating a model.

Example: 'Engine Gas Dynamics'

PortIndex — Block port index

integer

This property is read-only.

Index of the output port connected to the signal on the block that produces the signal. The `PortIndex` property is empty for `Signal` objects that contain data that was not produced by simulating a model.

Example: 1

Dimensions — Signal dimensions

integer | integer array

This property is read-only.

Signal dimensions, returned as an integer or integer array.

Example: [1 2]

Channel — Index of signal within matrix

integer array

This property is read-only.

Index of the signal within a matrix, returned as an integer array.

NumPoints — Number of samples in signal

integer

This property is read-only.

Number of samples in the signal, returned as an integer.

Values — Signal values

timeseries | structure

Time and data values for the signal, returned as a `timeseries` object for non-bus signals or structure matching the bus hierarchy for bus signals.

RootSource — High-level structure that contains the imported signal

character vector

This property is read-only.

Name of the high-level structure containing the signal, returned as a character vector. The `RootSource` property only has value for imported signals.

Example: When you import the `Simulink.SimulationOutput` object `simOut` containing structure `xout`, the `RootSource` is `'simOut.get('xout')`

TimeSource — Source of imported signal time data

character vector

This property is read-only.

Path to the signal time data, returned as a character vector. The `TimeSource` property only has value for imported signals.

Example: When you import the `Simulink.SimulationOutput` object `simOut` containing structure `xout`, the `TimeSource` is `'simOut.get('xout').time'`

DataSource — Source of imported signal data

character vector

This property is read-only.

Path to the signal sample values, returned as a character array. The `DataSource` property only has value for imported signals.

Example: When you import the `Simulink.SimulationOutput` object `simOut` containing structure `xout`, the `DataSource` is `'simOut.get('xout').signals(1).values'`

Children — Signals contained by composite signal`Simulink.sdi.Signal` vector

This property is read-only.

Signals contained by the composite signal, returned as `Simulink.sdi.Signal` objects. The `Children` property is empty for scalar signals.

Visualization Properties**ComplexFormat — Display format for complex signals**`"real-imaginary" | "magnitude" | "magnitude-phase" | "phase"`

Complex format used to display complex signal data in the Simulation Data Inspector, specified as one of the following values. You can modify the `ComplexFormat` property for a `Signal` object to change how the Simulation Data Inspector displays the signal data when the object contains data for a complex signal.

- `"real-imaginary"` — The real and imaginary components of the signal display together when you plot the signal. The imaginary component of the signal is plotted with a different shade of the **Line Color**.
- `"magnitude"` — The magnitude of the signal displays when you plot the signal.

- "magnitude-phase" — The magnitude and phase of the signal display together when you plot the signal.
- "phase" — The phase of the signal displays when you plot the signal. The phase is plotted with a different shade of the **Line Color**.

Data Types: char | string

Checked — Whether signal is plotted

0 or false (default) | 1 or true

Whether the signal is plotted, specified as a logical value. Setting Checked to false clears the signal from all subplots. Setting Checked to true plots the signal on the active subplot.

Data Types: logical

LineColor — Signal line color

1-by-3 vector

Color of signal in plots, specified as a 1-by-3 RGB vector with values between 0 and 1.

Example: [0 0.5 0.5]

Data Types: double

LineDashed — Signal line style

'-' | '--' | ':' | '-.'

Signal line style used when the signal is plotted in the Simulation Data Inspector, specified as one of these options:

- '-' — Solid
- '--' — Dashed
- ':' — Dotted
- '-.' — Dash-dotted

LineWidth — Signal line width

1 (default) | integer between 1 and 20

Signal line width used when the signal is plotted in the Simulation Data Inspector, specified as an integer between 1 and 20, inclusive.

InterpMethod — Interpolation method

'linear' (default) | 'zoh' | 'none'

Interpolation method used in data visualization and the synchronization step of comparisons, specified as one of the following values:

- 'zoh' — Zero-order hold interpolation
- 'linear' — Linear interpolation
- 'none' — No interpolation

For more information about the interpolation options, see “How the Simulation Data Inspector Compares Data”.

Comparison Properties

AbsTol — Absolute tolerance

0 (default) | scalar

Absolute tolerance to use in signal comparisons, specified as a positive-valued scalar.

The Simulation Data Inspector uses tolerances specified in the signal properties of the baseline signal when the `OverrideGlobalTol` property is set to `1` or `true`. For more information about tolerances in the Simulation Data Inspector, see “How the Simulation Data Inspector Compares Data”.

Example: `0.1`

Data Types: `double`

RelTol — Relative tolerance

0 (default) | scalar

Relative tolerance to use in signal comparisons, specified as a positive-valued scalar. The relative tolerance is expressed as a fractional multiplier. For example, `0.1` specifies a 10 percent tolerance.

The Simulation Data Inspector uses tolerances specified in the signal properties of the baseline signal when the `OverrideGlobalTol` property is set to `1` or `true`. For more information about tolerances in the Simulation Data Inspector, see “How the Simulation Data Inspector Compares Data”.

Example: `0.05`

Data Types: `double`

TimeTol — Time tolerance

0 (default) | scalar

Time tolerance for the signal used in signal comparisons, specified as a positive-valued scalar. Specify the time tolerance in seconds.

The Simulation Data Inspector uses tolerances specified in the signal properties of the baseline signal when the `OverrideGlobalTol` property is set to `1` or `true`. For more information about tolerances in the Simulation Data Inspector, see “How the Simulation Data Inspector Compares Data”.

Example: `0.1`

Data Types: `double`

OverrideGlobalTol — Whether comparisons use signal tolerance

0 or `false` (default) | `1` or `true`

Whether comparisons use signal tolerance values instead of global tolerance values, specified as a logical value. Set the `OverrideGlobalTol` property to `1` or `true` to use the tolerance values defined in the `Signal` object properties. Set the property to `0` or `false` to use global tolerance values.

For more information about tolerances in the Simulation Data Inspector, see “How the Simulation Data Inspector Compares Data”.

Data Types: `logical`

SyncMethod — Synchronization method

'union' (default) | 'intersection'

Method used to synchronize signals in comparisons, specified as 'union' or 'intersection'. For more information about the synchronization options, see “How the Simulation Data Inspector Compares Data”.

Object Functions

| | |
|----------------------------|---|
| <code>convertUnits</code> | Convert units of <code>Simulink.sdi.Signal</code> object |
| <code>export</code> | Export <code>Simulink.sdi.Signal</code> object to workspace or file |
| <code>getAsTall</code> | Create tall timetable from <code>Simulink.sdi.Signal</code> object |
| <code>plotOnSubPlot</code> | Plot <code>Simulink.sdi.Signal</code> object on Simulation Data Inspector subplot |

Examples

Analyze Simulation Data Using Signal Tolerances

You can programmatically specify signal tolerance values to use in comparisons performed using the Simulation Data Inspector. In this example, you compare data collected by simulating a model of an aircraft longitudinal flight control system. Each simulation uses a different value for the input filter time constant and logs the input and output signals. You analyze the effect of the time constant change by comparing results using the Simulation Data Inspector and signal tolerances.

First, load the session file that contains the simulation data.

```
Simulink.sdi.load('AircraftExample.mldatx');
```

The session file contains four runs. In this example, you compare data from the first two runs in the file. Access the `Simulink.sdi.Run` objects for the first two runs loaded from the file.

```
runIDs = Simulink.sdi.getAllRunIDs;  
runIDs1 = runIDs(end-3);  
runIDs2 = runIDs(end-2);
```

Now, compare the two runs without specifying any tolerances.

```
noTolDiffResult = Simulink.sdi.compareRuns(runIDs1,runIDs2);
```

Use the `getResultByIndex` function to access the comparison results for the `q` and `alpha` signals.

```
qResult = getResultByIndex(noTolDiffResult,1);  
alphaResult = getResultByIndex(noTolDiffResult,2);
```

Check the `Status` of each signal result to see whether the comparison result fell within our out of tolerance.

```
qResult.Status
```

```
ans =  
    ComparisonSignalStatus enumeration  
    OutOfTolerance
```

```
alphaResult.Status
```

```
ans =  
    ComparisonSignalStatus enumeration
```

OutOfTolerance

The comparison used a value of 0 for all tolerances, so the `OutOfTolerance` result means the signals are not identical.

You can further analyze the effect of the time constant by specifying tolerance values for the signals. Specify the tolerances by setting the properties for the `Simulink.sdi.Signal` objects that correspond to the signals being compared. Comparisons use tolerances specified for the baseline signals. This example specifies a time tolerance and an absolute tolerance.

To specify a tolerance, first access the `Signal` objects from the baseline run.

```
runTs1 = Simulink.sdi.getRun(runIDTs1);
qSig = getSignalsByName(runTs1, 'q, rad/sec');
alphaSig = getSignalsByName(runTs1, 'alpha, rad');
```

Specify an absolute tolerance of 0.1 and a time tolerance of 0.6 for the `q` signal using the `AbsTol` and `TimeTol` properties.

```
qSig.AbsTol = 0.1;
qSig.TimeTol = 0.6;
```

Specify an absolute tolerance of 0.2 and a time tolerance of 0.8 for the `alpha` signal.

```
alphaSig.AbsTol = 0.2;
alphaSig.TimeTol = 0.8;
```

Compare the results again. Access the results from the comparison and check the `Status` property for each signal.

```
tolDiffResult = Simulink.sdi.compareRuns(runIDTs1, runIDTs2);
qResult2 = getResultByIndex(tolDiffResult, 1);
alphaResult2 = getResultByIndex(tolDiffResult, 2);
```

```
qResult2.Status
```

```
ans =
  ComparisonSignalStatus enumeration
    WithinTolerance
```

```
alphaResult2.Status
```

```
ans =
  ComparisonSignalStatus enumeration
    WithinTolerance
```

Define Comparison and Visualization Properties for a Signal

This example shows how to obtain a `Simulink.sdi.Signal` object and modify its properties using the Simulation Data Inspector programmatic interface.

Create Data in the Simulation Data Inspector

When you simulate a model that logs data, a run is created in the Simulation Data Inspector to contain the logged data. You can also create a run in the Simulation Data Inspector by importing data. This example simulates the `slexAircraftExample` model and logs the data in Dataset format.

```
simOut = sim('slexAircraftExample', 'SaveFormat', 'Dataset');
```

Get a Simulink.sdi.Signal Object

The programmatic simulation returns the logged data in the workspace variable `simOut`. You can access the logged data in that variable. However, to use the Simulation Data Inspector programmatic interface, you need to access the logged data in `Simulink.sdi.Run` and `Simulink.sdi.Signal` objects.

First, use the `Simulink.sdi.getCurrentSimulationRun` to get the Run object that was created when you simulated the `slexAircraftExample` model.

```
aircraftRun = Simulink.sdi.getCurrentSimulationRun('slexAircraftExample');
```

You can use the `getAllSignals` function to access the Signal objects for all the signals in the run. From the returned array of Signal objects, select the first signal.

```
signals = getAllSignals(aircraftRun);
sig = signals(1);
```

Modify the Signal Properties

The `Simulink.sdi.Signal` object has properties that specify options for comparing and visualizing the signal. Specify a line style and color for the signal. Then, use the `Simulink.sdi.setSubPlotLayout` to configure the Simulation Data Inspector to show a single subplot, and use the `plotOnSubPlot` function to plot the signal.

```
sig.LineColor = [1 0.4 0.6];
sig.LineDashed = '-';
```

```
Simulink.sdi.setSubPlotLayout(1,1)
plotOnSubPlot(sig,1,1,true)
```

Use the `Simulink.sdi.view` function to open the Simulation Data Inspector and view the plotted signal.

Compare Two Signals in the Same Run

You can use the Simulation Data Inspector programmatic interface to compare signals within a single run. This example compares the input and output signals of an aircraft longitudinal controller.

First, load the session that contains the data.

```
Simulink.sdi.load('AircraftExample.mldatx');
```

Use the `Simulink.sdi.Run.getLatest` function to access the latest run in the data.

```
aircraftRun = Simulink.sdi.Run.getLatest;
```

Then, you can use the `Simulink.sdi.getSignalsByName` function to access the `Stick` signal, which represents the input to the controller, and the `alpha`, `rad` signal that represents the output.

```
stick = getSignalsByName(aircraftRun, 'Stick');
alpha = getSignalsByName(aircraftRun, 'alpha, rad');
```

Before you compare the signals, you can specify a tolerance value to use for the comparison. Comparisons use tolerance values specified for the baseline signal in the comparison, so set an absolute tolerance value of 0.1 on the `Stick` signal.

```
stick.AbsTol = 0.1;
```

Now, compare the signals using the `Simulink.sdi.compareSignals` function. The `Stick` signal is the baseline, and the `alpha, rad` signal is the signal to compare against the baseline.

```
comparisonResults = Simulink.sdi.compareSignals(stick.ID,alpha.ID);
match = comparisonResults.Status
```

```
match =
    ComparisonSignalStatus enumeration
        OutOfTolerance
```

The comparison result is out of tolerance. You can use the `Simulink.sdi.view` function to open the Simulation Data Inspector to view and analyze the comparison results.

Plot Signals from Simulation Run

This example demonstrates how to access the `Simulink.sdi.Run` object for a Simulation Data Inspector run created by logging signals. From the `Simulink.sdi.Run` object you can get `Simulink.sdi.Signal` objects that contain the logged signal data and metadata. You can use the `Signal` objects and the `plotOnSubPlot` function to plot the data in the Simulation Data Inspector.

Create a Simulation Run and Access the Run Object

The `ex_vdp` model logs two signals. To create a simulation run containing the logged data, simulate the model.

```
sim('ex_vdp');
```

The Simulation Data Inspector keeps track of runs by assigning a unique numeric run ID to each run created by simulation, importing data, or opening a session. To access the run object for the simulation you just performed, use the `Simulink.sdi.getAllRunIDs` function and take the last run ID in the returned vector.

```
runIDs = Simulink.sdi.getAllRunIDs;
runID = runIDs(end);
```

Once you have the run ID for the run, you can use the `Simulink.sdi.getRun` function to get the `Simulink.sdi.Run` object that corresponds to the run. You can use the `Run` object to check the metadata associated with the run, including the number of signals in the run.

```
vdpRun = Simulink.sdi.getRun(runID);
```

```
vdpRun.SignalCount
```

```
ans = int32
     2
```

Plot Data Using Signal Objects

Use the `getSignalByIndex` function to access signals from the Run object, `fuelRun`.

```
signal1 = getSignalByIndex(vdpRun,1);  
signal2 = getSignalByIndex(vdpRun,2);
```

Use the `Simulink.sdi.setSubPlotLayout` function to specify a 3-by-1 layout.

```
Simulink.sdi.setSubPlotLayout(2,1)
```

Before plotting the data, use the `Simulink.sdi.clearAllSubPlots` function to clear any data that is already plotted.

```
Simulink.sdi.clearAllSubPlots
```

Plot one signal on each subplot. To plot signals on the first subplot, you can set the checked property for the signal. To plot signals on subplots other than the first subplot, use the `plotOnSubPlot` function.

```
signal1.Checked = true;  
plotOnSubPlot(signal2,2,1,true);
```

View the Plotted Data

To view the plots you just created, open the Simulation Data Inspector using the `Simulink.sdi.view` function.

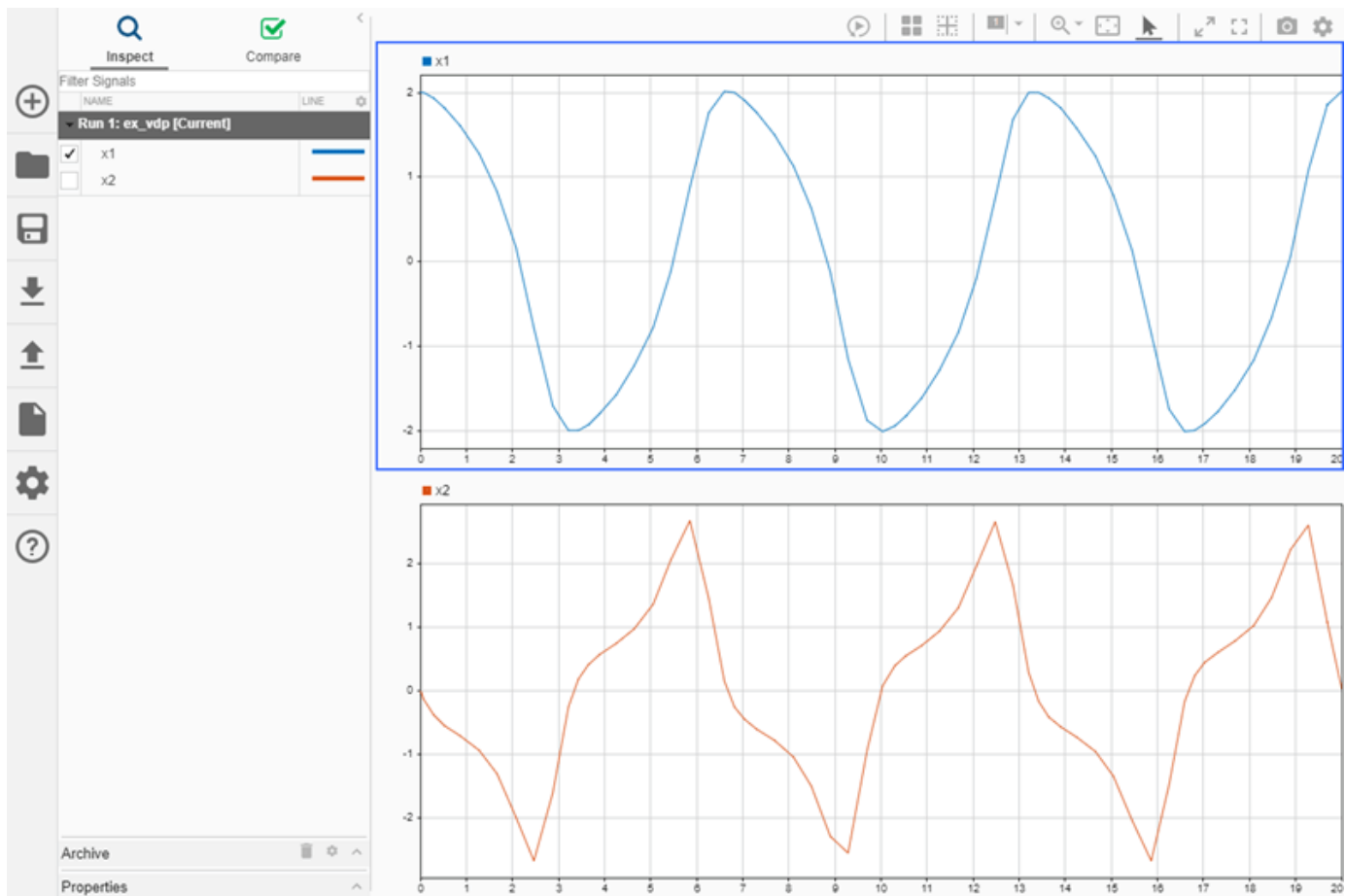

See Also

Objects

Simulink.sdi.Run

Functions

Simulink.sdi.getSignal | Simulink.sdi.createRun | getSignalByIndex | getSignalIDByIndex | getSignal

Tools

Simulation Data Inspector

Topics

“Inspect and Compare Data Programmatically”

“How the Simulation Data Inspector Compares Data”

Introduced in R2012b

Simulink.Signal

Specify instance-specific properties of signal or discrete state

Description

This object enables you to create workspace objects that you can use to assign or validate the attributes of a signal or discrete state, such as its data type, numeric type, dimensions, and so on.

You can use a signal object to:

- Assign values to signal attributes that are left unassigned (have a value of `-1` or `auto`) by the signal source.
- Validate signal attributes whose values are explicitly assigned by the signal source. Such attributes have values other than `-1` or `auto`. Successful validation guarantees that the signal has the attributes that you intended it to have.

You can create a `Simulink.Signal` object in the MATLAB workspace or in a model workspace.

Use signal objects to assign or validate signal or discrete state attributes by giving the signal or discrete state the same name as the workspace variable that references the `Simulink.Signal` object.

For more information about using signal objects, see “Use Simulink.Signal Objects to Specify and Control Signal Attributes” and “Data Objects”.

To assign or validate the properties of signals based on an application-specific type, such as wind velocity, use a `Simulink.ValueType` object.

Creation

Create a `Simulink.Signal` object:

- By using the Model Data Editor. See “For Signals”.
- By using the Model Explorer. See “Create Data Objects from Built-In Data Class Package Simulink”.
- Directly from a signal properties dialog box or the Property Inspector in a model. See “Create Signal Object from Signal Properties Dialog Box”.
- By using the `Simulink.Signal` function, described below.

Syntax

```
signalObj = Simulink.Signal
```

Description

`signalObj = Simulink.Signal` returns a `Simulink.Signal` object with default property values.

Properties

For information about properties in the property dialog box of a `Simulink.Signal` object, see “Property Dialog Box”.

CoderInfo — Specifications for generating code for signal

`Simulink.CoderInfo` object

Information used by Simulink Coder for generating code for this signal. The value of this property is an object of `Simulink.CoderInfo` class.

For more information, see “C Code Generation Configuration for Model Interface Elements” (Simulink Coder) and “Choose Storage Class for Controlling Data Representation in Generated Code” (Embedded Coder).

Complexity — Numeric complexity of signal

'auto' (default) | 'real' | 'complex'

Character vector specifying the numeric type of this signal. Valid values are 'auto' (determined by Simulink), 'real', or 'complex'.

Data Types: char

DataType — Data type of signal

'auto' (default) | character vector

Character vector specifying the data type of this signal.

The default value, 'auto', specifies that Simulink should determine the data type. You can specify a built-in data type (for example, 'uint8' or 'single'), a data type such as 'half', or a custom data type. To specify a custom data type, use a MATLAB expression that specifies the type, (for example, the name of a `Simulink.NumericType` object that you create in the base workspace).

To specify a bus object as the data type for the signal object, use the 'Bus: <object_name>' syntax. See “Bus Support” for details about what you need to do if you specify a bus object as the data type.

Example: 'auto'

Example: 'int8'

Example: 'fixdt(1,16,5)'

Example: 'myAliasTypeObject'

Example: 'Enum: myEnumType'

Example: 'Bus: myBusObject'

Data Types: char

Description — Custom description of signal

'' (empty character vector) (default) | character vector

Description of this signal. This field is intended for use in documenting this signal.

This property is used by the Simulink Report Generator and for code generation.

If you have an Embedded Coder license, you can add the signal description as a comment for the variable declaration in generated code:

- Specify a storage class for the signal object other than `Auto`.
- On the **Code Generation > Comments** pane of the model Configuration Parameters dialog box, select the model configuration parameter **Simulink data object descriptions**. For more information, see “Simulink data object descriptions” (Embedded Coder).

Example: `'This signal represents the rotation speed of the engine.'`

Data Types: `char`

Dimensions — Dimensions of signal

`-1` (default) | row vector | character vector

Scalar or vector specifying the dimensions of this signal.

Valid values are `-1` (the default) specifying any dimensions, `N` specifying a vector signal of size `N`, or `[M N]` specifying an `MxN` matrix signal.

To use symbolic dimensions, specify a character vector.

Example: `[1 3]`

Example: `'[1 myDimParam]'`

Data Types: `double` | `char`

DimensionsMode — Dimension mode of signal

`'auto'` (default) | `'Fixed'` | `'Variable'`

Dimensions mode of the signal. Valid values are:

- `'auto'` — Allows variable-size and fixed-size signals.
- `'Fixed'` — Allows only fixed-size signals. Does not allow variable-size signals.
- `'Variable'` — Allows only variable-size signals.

For information about variable-size signals, see “Variable-Size Signal Basics”.

Max — Maximum value of signal

`[]` (empty) (default) | real double scalar

Maximum value that this signal can have.

The default value is `[]` (unspecified). Specify a finite, real, double, scalar value.

Note If you specify a bus object as the data type for a signal, do not set the maximum value for bus data on the signal property dialog box. Simulink ignores this setting. Instead, set the maximum values for bus elements of the bus object specified as the data type. For information on the Maximum property of a bus element, see `Simulink.BusElement`.

Simulink uses this value in the following ways:

- When updating the diagram or starting a simulation, Simulink generates an error if the initial value of the signal is greater than the maximum value or if the maximum value is outside the range of the data type of the signal.
- When you enable the **Simulation range checking** diagnostic, Simulink alerts you during simulation if the signal value is greater than the maximum value (see “Simulation range checking”).

Example: 5.32

Data Types: double

Min — Minimum value of signal

[] (empty) (default) | real double scalar

Minimum value that this signal can have.

The default value is [] (unspecified). Specify a finite, real, double, scalar value.

Note If you specify a bus object as the data type for a signal, do not set the minimum value for bus data on the signal property dialog box. Simulink ignores this setting. Instead, set the minimum values for bus elements of the bus object specified as the data type. For information on the Minimum property of a bus element, see `Simulink.BusElement`.

Simulink uses this value in the following ways:

- When updating the diagram or starting a simulation, Simulink generates an error if the signal's initial value is less than the minimum value or if the minimum value is outside the range for the data type of the signal.
- When you enable the **Simulation range checking** diagnostic, Simulink alerts you during simulation if the signal value is less than the minimum value (see “Simulation range checking”).

Example: -0.92

Data Types: double

InitialValue — Initial value of signal or state

' ' (empty character vector) (default) | character vector

Signal or state value before a simulation takes its first time step.

You can specify any MATLAB expression, including the name of a workspace variable, that evaluates to a numeric scalar value or array.

At the command prompt or in a script, even if you use a number, specify the initial value as a character vector.

```
mySigObject.InitialValue='5.3';
```

```
mySigObject.InitialValue = 'myNumericVariable';
```

To specify an initial value for a signal that uses a numeric data type other than `double`, cast the initial value to the signal data type. For example, you can specify `'single(73.3)'` to use 73.3 as the initial value for a signal of data type `single`.

If you use a bus object as the data type for the signal object, set `InitialValue` to a character vector containing either `0` or a MATLAB structure that matches the bus object. See “Bus Support” for details.

If the initial value evaluates to a MATLAB structure, then in the **Configuration Parameters** dialog box, set “Underspecified initialization detection” to `Simplified`.

If necessary, Simulink converts the initial value to ensure type, complexity, and dimension consistency with the corresponding block parameter value. If you specify an invalid value or expression, an error message appears when you update the model. Also, Simulink performs range checking of the initial value. The software alerts you when the initial value of the signal lies outside a range that corresponds to its specified minimum and maximum values and data type.

Classic initialization mode: In this mode, initial value settings for signal objects that represent the following signals and states override the corresponding block parameter initial values if undefined (specified as `[]`):

- Output signals of conditionally executed subsystems and Merge blocks
- Block states

Simplified initialization mode: In this mode, if a signal object is attached to the signal line connected to the Outport block of a conditionally executed subsystem, Simulink uses the `InitialValue` from the `Simulink.signal` object.

Example: `'15.23'`

Example: `'myInitParam'`

Data Types: `char`

SampleTime — Sample time of signal

`-1` (default) | `double` scalar or array

Rate at which this signal should be updated.

See “Specify Sample Time” for details.

Example: `0.001`

Example: `2`

Data Types: `double`

Unit — Physical unit of signal value

`''` (default) | valid unit

Physical unit used for expressing this signal value (for example, inches).

For more information, see “Unit Specification in Simulink Models”.

Example: `'degC'`

Data Types: `char`

Examples

Simulink.Signal Examples

For examples that show how to use `Simulink.Signal` objects, see “Use Simulink.Signal Objects to Specify and Control Signal Attributes” and “Data Objects”.

Extended Capabilities

C/C++ Code Generation

Generate C and C++ code using MATLAB® Coder™.

To control the appearance of a `Simulink.Signal` object in the generated code, use the **Storage class** property.

Fixed-Point Conversion

Design and simulate fixed-point systems using Fixed-Point Designer™.

See Also

`Simulink.Parameter` | `Simulink.CoderInfo` | `AUTOSAR.Signal`

Topics

“Determine Where to Store Variables and Objects for Simulink Models”

“Control Data Types of Signals”

“C Code Generation Configuration for Model Interface Elements” (Simulink Coder)

“Define Data Classes”

“Signal Basics”

“Data Objects”

“Data Types Supported by Simulink”

“MPT Data Object Properties” (Embedded Coder)

Introduced before R2006a

Simulink.SimulationData.Dataset

Access logged simulation data or group simulation input data

Description

A `Simulink.SimulationData.Dataset` object groups related data. Logged simulation results are often grouped in `Dataset` objects. You can also use a `Dataset` object to group simulation input data when you load initial states and when you load external input data using `Inport` blocks or the `Signal Editor` block.

A `Dataset` object created by logging simulation data contains one or more elements. Each element contains data for one logged signal, output, data store, or state. Each element is an object, and the type of the object depends on the data it contains.

- Signals and outputs — `Simulink.SimulationData.Signal` object
- States and final states — `Simulink.SimulationData.State` object
- Data stores — `Simulink.SimulationData.DataStoreMemory` object

When you create a `Dataset` object that groups simulation input data, each element contains data for a signal, bus, or array of buses. You can add data in any format supported by the loading method you use.

| Type of Input | Data Formats |
|--|---|
| Scalar, vector, or multidimensional signal | <ul style="list-style-type: none"> • <code>timeseries</code> • <code>timetable</code> • <code>Simulink.SimulationData.Signal</code> • <code>matlab.io.datastore.SimulationDataStore</code> • <code>matlab.io.datastore.sd datastore</code> • Structure with one field called <code>signals.values</code> that contains data for a single signal and a field called <code>time</code> that optionally includes time data • Array where the first column contains time data and subsequent columns contain data for a signal |
| Bus | <ul style="list-style-type: none"> • Structure of <code>timeseries</code>, <code>timetable</code>, or <code>matlab.io.datastore.SimulationDataStore</code> objects that matches the hierarchy of the bus • <code>Simulink.SimulationData.Signal</code> |
| Array of buses | <ul style="list-style-type: none"> • Array of structures • <code>Simulink.SimulationData.Signal</code> |

| Type of Input | Data Formats |
|----------------------|---|
| Function-call signal | <ul style="list-style-type: none"> N-by-1 vector <code>Simulink.SimulationData.Signal</code> |

Creation

Logging simulation data often creates a `Simulink.SimulationData.Dataset` object, including when you:

- Log data using signal logging.
- Log outputs, states, or final states using the `Dataset` format.
- Log data stores.
- Log data to the workspace or a MAT file using the Record block.
- Log data in `Dataset` format using a Scope block.
- Log data using a Floating Scope or Scope Viewer.

To group external input data for a model in a `Dataset` object, you can:

- Create an empty `Dataset` object and add the input data using the `addElement` function.
- Use the `createInputDataset` to create a `Dataset` object that contains an element for each root-level Inport block or In Bus Element block in a model. Then, specify the data for each element.
- Use the Signal Editor to interactively create and edit `Dataset` objects that contain simulation input data. For details, see “Create and Edit Signal Data”.

You can also create a `Dataset` object by converting data that uses another format to use the `Dataset` format. Having all data in a common format can facilitate postprocessing. For details, see “Convert Logged Data to Dataset Format”.

Syntax

```
ds = Simulink.SimulationData.Dataset
ds = Simulink.SimulationData.Dataset(dataToConvert)
ds = Simulink.SimulationData.Dataset(dataToConvert, "DatasetName", dsName)
```

Description

`ds = Simulink.SimulationData.Dataset` creates an empty, unnamed `Dataset` object to which you can add elements. Use this syntax to manually create a `Dataset` object that contains external input data to load using Inport or In Bus Element blocks.

`ds = Simulink.SimulationData.Dataset(dataToConvert)` creates an unnamed `Dataset` object that contains one or more elements that contain the data `dataToConvert`. Use this syntax to convert data that uses another format to use the `Dataset` format. For details, see “Convert Logged Data to Dataset Format”.

The conversion process only converts data for one input at a time. To convert data for multiple variables, convert each variable one at a time, then use the `concat` function to combine the resulting `Dataset` objects.

`ds = Simulink.SimulationData.Dataset(dataToConvert, "DatasetName", dsName)` creates a `Dataset` object with the name specified by `dsName` that contains one or more elements that contain the data `dataToConvert`. Use this syntax to convert data that uses another format to use the `Dataset` format. For details, see “Convert Logged Data to Dataset Format”.

Input Arguments

dataToConvert — Data to convert to Dataset format

`timeseries` object | `timetable` | `structure` | `array` | `Simulink.ModelDataLogs` object

Data to convert to `Dataset` format, specified as a `timeseries` object, a `timetable`, a `structure`, an `array`, or a `Simulink.ModelDataLogs` object. The results of conversion depend on the format of the input data.

| Input Data | Conversion Results |
|---|--|
| <code>timeseries</code> object or <code>timetable</code> | <code>Dataset</code> object that contains one <code>Simulink.SimulationData.Signal</code> object with the <code>timeseries</code> or <code>timetable</code> data in its <code>Values</code> property. |
| <code>ModelDataLogs</code> object | <code>Dataset</code> object that contains one or more <code>Simulink.SimulationData.Signal</code> objects that contain the data for each signal in the input object. |
| <code>Structure</code> that matches the <code>Structure</code> with <code>time</code> logging format. | <code>Dataset</code> object that contains one or more <code>Simulink.SimulationData.Signal</code> objects that contain the data for each signal in the input <code>structure</code> . |
| <code>Structure</code> that matches the <code>Structure</code> logging format | <code>Dataset</code> object that contains one or more <code>Simulink.SimulationData.Signal</code> objects that contain the data for each signal in the input <code>structure</code> . Because the input does not contain time data, the conversion creates a time vector for each signal that starts at 0 and uses a sampling interval of 1. |
| <code>Array</code> | <code>Dataset</code> object that contains one <code>Simulink.SimulationData.Signal</code> object. The <code>Values</code> property of the <code>Signal</code> object contains a <code>timeseries</code> object, and the <code>Data</code> property of the <code>timeseries</code> object contains the entire array. Because the input does not contain time data, the conversion creates a time vector for the signal that starts at 0 uses a sampling interval of 1. |

For more information, see “Convert Logged Data to Dataset Format” and “Dataset Conversion for Logged Data”.

dsName — Dataset object name

`string` | `character vector`

Dataset object name, specified as a string or character vector.

Output Arguments

ds — Dataset object

`Simulink.SimulationData.Dataset` object

Dataset object, returned as a `Simulink.SimulationData.Dataset` object. The Dataset object is empty when you do not specify input arguments. Create an empty Dataset object when you want to group simulation input data in a single variable.

When you specify input arguments, the Dataset object contains one or more elements that contain the input data. The results of conversion depend on the format of the input data.

| Input Data | Conversion Results |
|---|--|
| timeseries object | Dataset object that contains one <code>Simulink.SimulationData.Signal</code> object with the timeseries data in its <code>Values</code> property. |
| ModelDataLogs object | Dataset object that contains one or more <code>Simulink.SimulationData.Signal</code> objects that contain the data for each signal in the input object. |
| Structure that matches the Structure with time logging format | Dataset object that contains one or more <code>Simulink.SimulationData.Signal</code> objects that contain the data for each signal in the input structure. |
| Structure that matches the Structure logging format | Dataset object that contains one or more <code>Simulink.SimulationData.Signal</code> objects that contain the data for each signal in the input structure. Because the input does not contain time data, the conversion creates a time vector for each signal that starts at 0 and uses a sampling interval of 1. |
| Array | Dataset object that contains one <code>Simulink.SimulationData.Signal</code> object. The <code>Values</code> property of the Signal object contains a timeseries object, and the <code>Data</code> property of the timeseries object contains the entire array. Because the input does not contain time data, the conversion creates a time vector for the signal that starts at 0 uses a sampling interval of 1. |

For more information, see “Convert Logged Data to Dataset Format” and “Dataset Conversion for Logged Data”.

Properties

Name — Dataset object name

string | character vector

Dataset object name, specified as a string or character vector. When you create a Dataset object to group simulation input data, you specify the name for the Dataset object. The name you specify does not need to match the name of the variable that contains the Dataset object.

The Name property of Dataset objects created by logging simulation data is set to match the logging variable name specified in the model configuration parameters.

- **Output** — Default: yout
- **Signal logging** — Default: logout
- **States** — Default: xout
- **Data stores** — Default: dsmout
- **Final states** — Default: xFinal

Object Functions

| | |
|-------------------------|---|
| addElement | Add element to end of a Dataset object |
| concat | Concatenate dataset to another dataset |
| exportToPreviousRelease | Save a Dataset object to a MAT-file you can open in any release |
| extractTimetable | Extract data from Simulink.SimulationData.Dataset or Simulink.SimulationData.Signal objects into timetables |
| find | Get element or collection of elements from dataset |
| get | Get element or collection of elements from dataset |
| getElementNames | Return names of all elements in dataset |
| numElements | Get number of elements in data set |
| plot | Plot data in the Simulation Data Inspector |
| setElement | Change element stored at specified index |

Examples

Access Data Logged Using Dataset Format

Log the outputs of the vdp model and access the logged data.

Open the model. Configure output logging using the Dataset format and simulate the model using the sim function.

```
open_system('vdp');
out = sim('vdp', 'SaveOutput', 'on', 'SaveFormat', 'Dataset');
```

All logged data is returned in a single variable, out, as a Simulink.SimulationOutput object. The SimulationOutput object contains a Simulink.SimulationData.Dataset object that groups each kind of logged data. This example only logs outputs, so there is one Dataset object, yout.

```
out
```

```
out =
  Simulink.SimulationOutput:
```

```

        yout: [1x1 Simulink.SimulationData.Dataset]

SimulationMetadata: [1x1 Simulink.SimulationMetadata]
ErrorMessage: [0x0 char]

```

Access the `Dataset` object that includes the logged output data using a dot and the name of the `Dataset` object. The `Dataset` object contains a `Simulink.SimulationData.Signal` object for each output.

```
outputs = out.yout
```

```
outputs =
Simulink.SimulationData.Dataset 'yout' with 2 elements
```

| | Name | BlockPath |
|----------------|------|-----------|
| 1 [1x1 Signal] | x1 | vdp/Out1 |
| 2 [1x1 Signal] | x2 | vdp/Out2 |

- Use braces { } to access, modify, or add elements using index.

The `Signal` object has metadata about the signal, including the path to the block and index of the port that produces the signal. Use the `getElement` function to access the `Signal` object that contains the data for signal `x1` by name. You can also use curly braces({}) to access elements in a `Dataset` object by index.

```
outputX1 = getElement(outputs, 'x1')
```

```
outputX1 =
Simulink.SimulationData.Signal
Package: Simulink.SimulationData

Properties:
    Name: 'x1'
    PropagatedName: ''
    BlockPath: [1x1 Simulink.SimulationData.BlockPath]
    PortType: 'inport'
    PortIndex: 1
    Values: [1x1 timeseries]
```

Methods, Superclasses

The signal data is stored in the `Values` property of the `Signal` object as a `timeseries` object. The time values are in the `Time` property of the `timeseries` object. The signal values are in the `Data` property.

```
outputValsX1 = outputX1.Values
```

```
timeseries

Common Properties:
    Name: 'x1'
    Time: [64x1 double]
    TimeInfo: tsdata.timemetadadata
```

```
        Data: [64x1 double]
        DataInfo: tsdata.datametadate

outputTimesX1 = outputValsX1.Time
outputTimesX1 = 64x1

    0
    0.0001
    0.0006
    0.0031
    0.0157
    0.0785
    0.2844
    0.5407
    0.8788
    1.2788
    :
```

```
outputDataX1 = outputValsX1.Data
outputDataX1 = 64x1

    2.0000
    2.0000
    2.0000
    2.0000
    1.9998
    1.9943
    1.9379
    1.8155
    1.5990
    1.2687
    :
```

You can also access the time values or data values by combining the steps into a single line of code.

```
outputDataX1 = getElement(out.yout, 'x1').Values.Data
outputDataX1 = 64x1

    2.0000
    2.0000
    2.0000
    2.0000
    1.9998
    1.9943
    1.9379
    1.8155
    1.5990
    1.2687
    :
```

Group Simulation Inputs Using Dataset Object

Create data for three simulation input signals and group them in a `Dataset` object. A simple model loads the contents of the `Dataset` object using three root-level Inport blocks. Dashboard Scope blocks in the model display each signal created using the loaded input data.

First, create the signal data to load into the model. Use the expression in this example to create the evenly-spaced time vector for an input signal, especially when modeling discrete input signals. MATLAB® supports several other methods for creating an evenly-spaced vector, but other methods can introduce double-precision rounding errors in the time data, which can lead to unexpected simulation results.

```
sampleTime = 0.01;
numSteps = 1001;
time = sampleTime*(0:numSteps-1);
time = time';
```

Create signal data for a sine signal, a cosine signal, and a linear signal.

```
sineVals = sin(2*pi/3*time);
cosVals = cos(2*pi/3*time);
lineVals = time;
```

Create a `timeseries` object to contain the data for each signal. Give each `timeseries` object a descriptive name so signals are easy to identify once they are grouped in the `Dataset` object.

```
sineTS = timeseries(sineVals,time,'Name','Sine Wave');
cosTS = timeseries(cosVals,time,'Name','Cosine Wave');
lineTS = timeseries(lineVals,time,'Name','Line');
```

Create a `Dataset` object and use the `addElement` function to add each `timeseries` object to the `Dataset` object.

```
inputData = Simulink.SimulationData.Dataset;
inputData.Name = 'inputData';
inputData = addElement(inputData,sineTS);
inputData = addElement(inputData,cosTS);
inputData = addElement(inputData,lineTS)
```

```
inputData =
Simulink.SimulationData.Dataset 'inputData' with 3 elements
```

| | | Name | BlockPath |
|---|------------------|-------------|-----------|
| 1 | [1x1 timeseries] | Sine Wave | '' |
| 2 | [1x1 timeseries] | Cosine Wave | '' |
| 3 | [1x1 timeseries] | Line | '' |

- Use braces { } to access, modify, or add elements using index.

When you load external input data using root-level Inport blocks, you specify the data to load using the **Input** parameter in the Model Configuration Parameters on the Data Import/Export pane. Open the model `LoadInputDataset` and see that the **Input** parameter is specified as `inputData`.

```
open_system('LoadInputDataset.slx');
```

Simulate the model. The Dashboard Scope block connected to the first Inport block shows the sine signal, the Dashboard Scope block connected to the second Inport block shows the cosine signal, and the Dashboard Scope block connected to the third Inport block shows the linear signal.

```
out = sim('LoadInputDataset.slx');
```

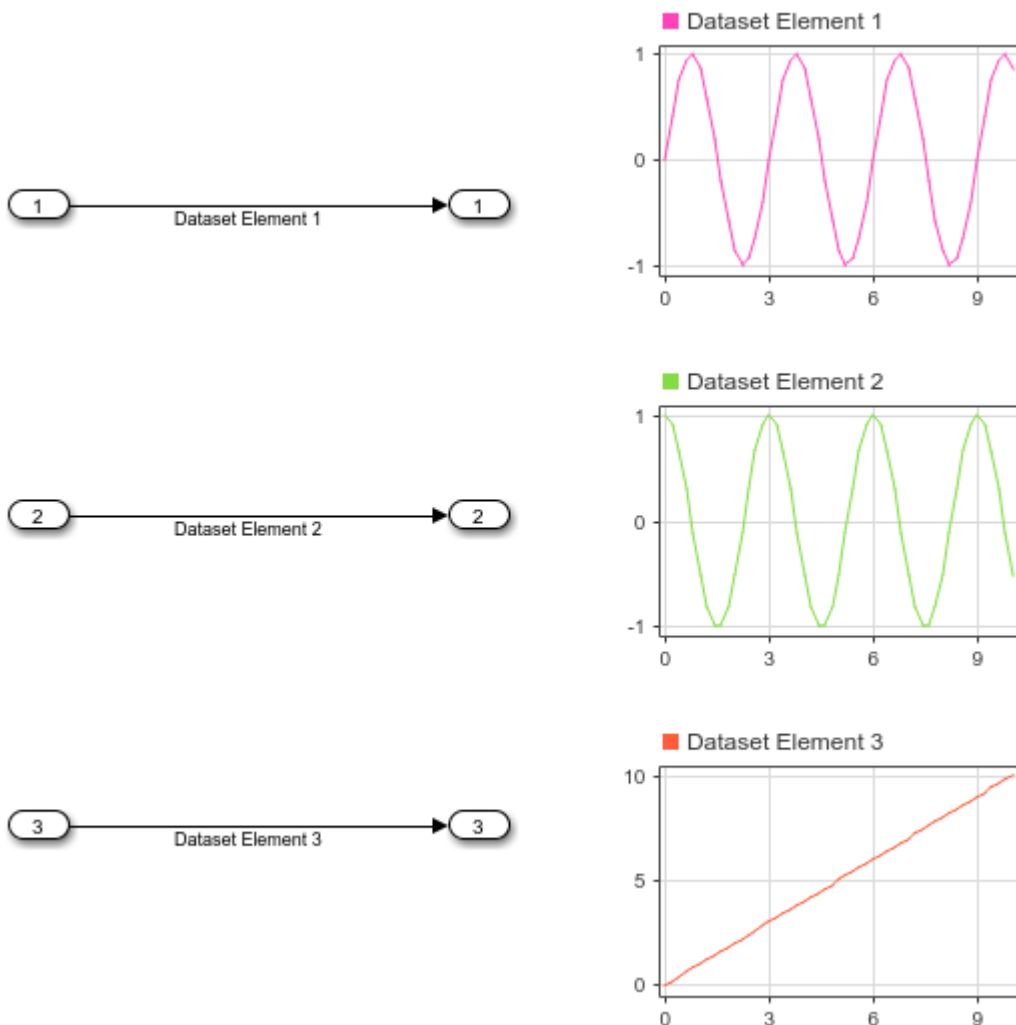

You can swap the order of elements in the Dataset object and see the change reflected in how the elements are mapped to the Inport blocks.

```
inputData{1} = lineTS;
inputData{3} = sineTS
```

```
inputData =
Simulink.SimulationData.Dataset 'inputData' with 3 elements
```

| | Name | BlockPath |
|---|-------------|-----------|
| 1 | Line | '' |
| 2 | Cosine Wave | '' |
| 3 | Sine Wave | '' |

- Use braces { } to access, modify, or add elements using index.

Simulate the model again. The Dashboard Scope block that displays the first element now shows the line, and the Dashboard Scope block that displays the third element shows the sine wave, reflecting the new order of elements in the Dataset object.

```
out = sim('LoadInputDataset.slx');
```

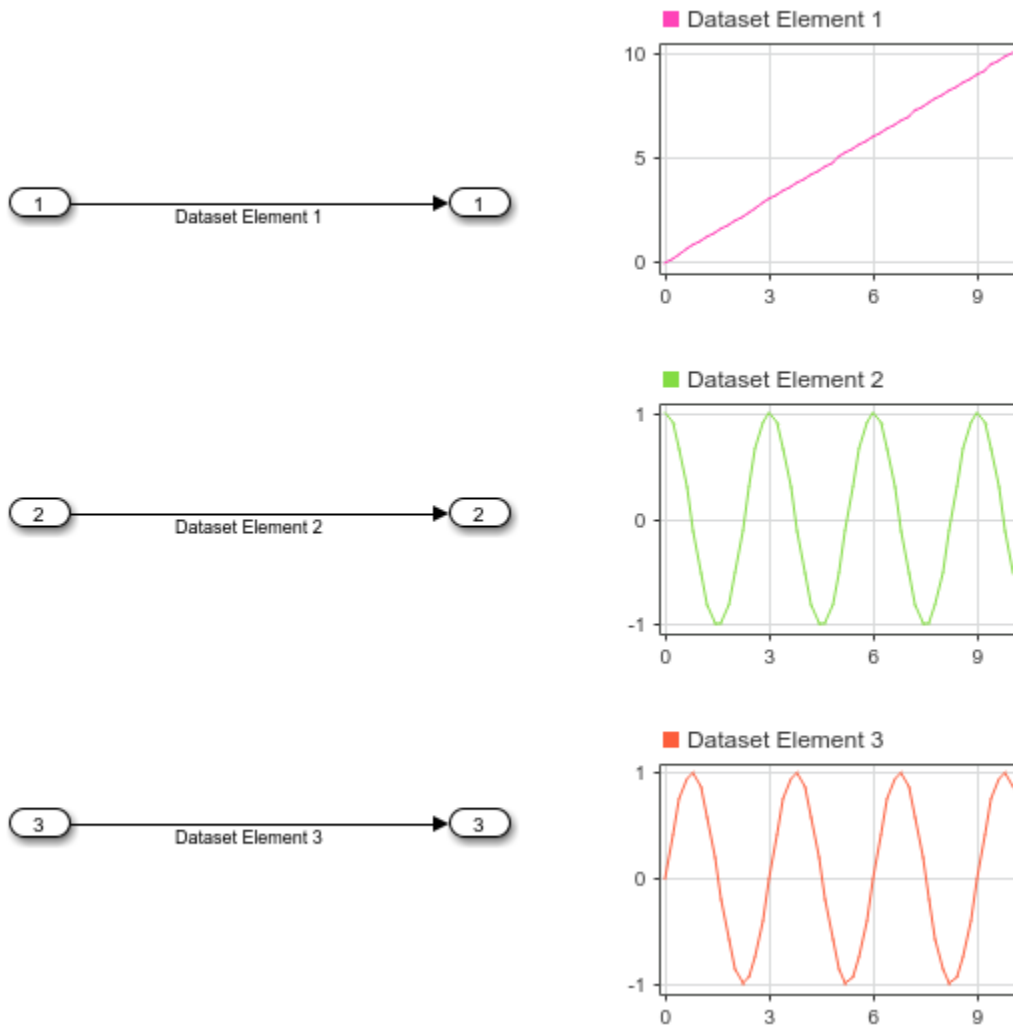

Tips

- You can use curly braces ({}) to access, add, or modify an element in a Dataset object by index.
- To access, add, or modify an element of a Dataset object by name, use the getElement, addElement, and setElement functions.
- When you group simulation inputs using Dataset objects, you can use the Signal Editor or the Signal Editor block to easily change which Dataset object provides input for the simulation.

- When you load external input data from a `Dataset` object using root-level Inport blocks, you can use the Root Inport Mapper to map each element in the `Dataset` object to an Inport block by block name, block path, signal name, or port order. You can also write your own function to map the data. For more information, see “Map Root Inport Signal Data”.
- When you save data in a `Dataset` object to a MAT file, consider saving to a Version 7.3 MAT file if the contents of the `Dataset` object are too large to fit in memory. You can create a `Simulink.SimulationData.DatasetRef` that references a `Dataset` object in a MAT file without loading the data into memory for data processing or for loading big data. For more information, see “Load Big Data for Simulations”.
- To save a `Dataset` object to a MAT file that you can open in an earlier release, use the `exportToPreviousRelease` function instead of the `save` function.
- You can write your own reader to import data from a file into a `Dataset` object in the base workspace, the model workspace, or the Signal Editor using the `Simulink.io.FileType` class. For more information, see “Create Custom File Type for Import to Signal Editor”.

See Also

Objects

`Simulink.SimulationOutput` | `Simulink.SimulationData.Signal` |
`Simulink.SimulationData.Parameter` | `Simulink.SimulationData.DataStoreMemory` |
`Simulink.SimulationData.State` | `timeseries` | `timetable` |
`Simulink.SimulationData.DatasetRef`

Functions

`createInputDataset` | `signalEditor`

Simulink Configuration Parameters

Signal logging | **Output** | **States** | **Data stores** | **Final states** | **Format** | **Single simulation output** | **Input**

Topics

“Load Data to Root-Level Input Ports”
“Export Signal Data Using Signal Logging”
“Log Data Stores”
“Convert Logged Data to Dataset Format”

Introduced in R2011a

sltrace.Graph

Provide tracing information as graph for structure analysis

Description

An `sltrace.Graph` object stores tracing information generated by the `sltrace` function.

Creation

You can create `sltrace.Graph` object using the `sltrace` function.

Properties

TraceGraph — Tracing graph with edges and nodes

`digraph`

Tracing graph with edges and nodes, returned as a `digraph` object. A node in the graph is decided by a block port on the tracing path and shown as `'NodeIndex'`. For each node, `TraceGraph.Nodes` provides a table with more details, including `Block`, `PortNumber` and `PortType`. If `'BlockPath'` is set to `'on'` in `sltrace`, then the `Block` column of the `TraceGraph.Nodes` table will be shown as `Simulink.BlockPath`.

`TraceGraph.Edges` shows a table that contains the `EndNodes` of the `digraph` object, and the `Segments` between them. `Segments` is an array of segment handles that are connected together to form a line between two blocks. If the `EndNodes` belong to the same block, their `Segments` is marked as `'Internal'`. If the end nodes are from connectionless block pairs, such as the pair formed by `'From'` and `'Goto'`, then their `Segments` is marked as `'Hidden'`.

SrcBlocks, DstBlocks — Blocks on the tracing path

array of block handles | `Simulink.BlockPath` array

Blocks on tracing path, specified as an array of block handles or `Simulink.BlockPath` objects. If tracing in the direction of source, source blocks are returned in `g.SrcBlocks`. If tracing in the direction of the destination, destination blocks are returned in `g.DstBlocks`.

Object Functions

`highlight` Highlight tracing results
`removeHighlight` Remove highlighted tracing results

Examples

Trace All Sources in Model

This example shows how to trace from the first inport of the block `vdp/x1` to all sources.

```
open_system('vdp')
G = sltrace('vdp/x1', 'Source', 'Port', 1, 'TraceAll', 'on');
```

Highlight the tracing results and plot the trace graph.

```
highlight(G)
```

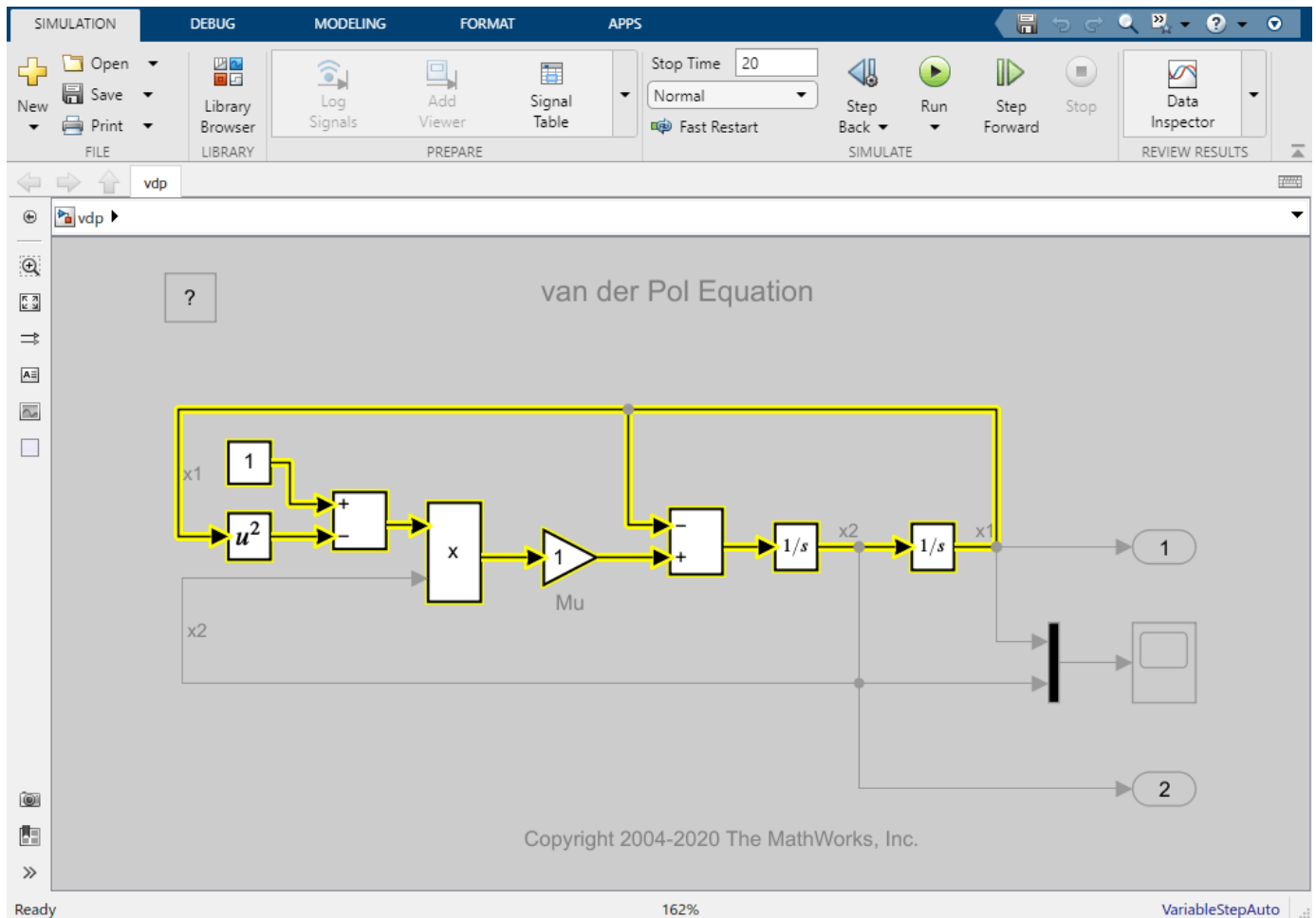

```
plot(G.TraceGraph)
```

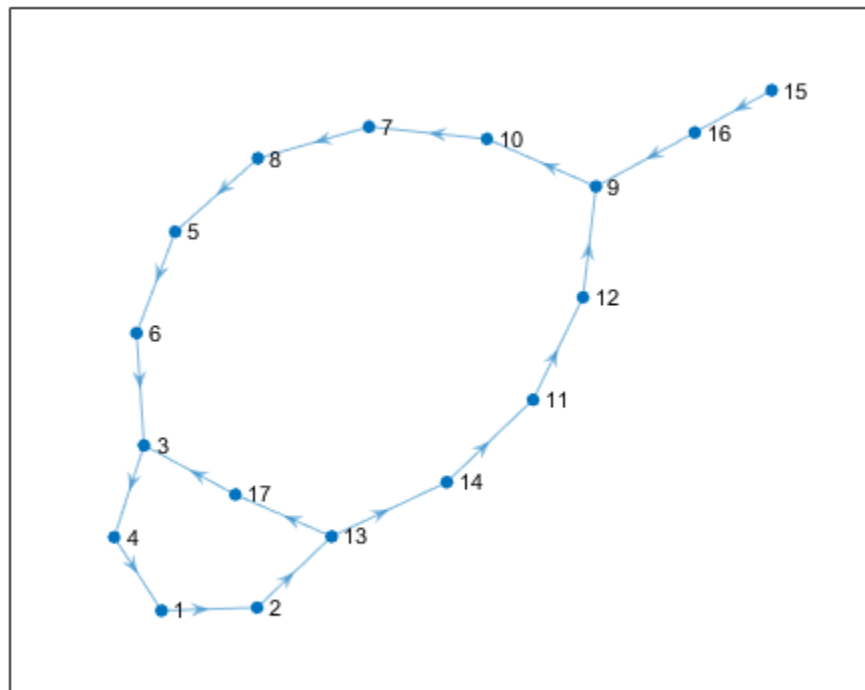

Highlight the block vdp/Scope and the line connecting to the inport of vdp/Scope.

```
bh = get_param('vdp/Scope', 'Handle');  
inportH = get_param('vdp/Scope', 'PortHandles').Inport;  
lh = get_param(inportH, 'line');  
highlight(G, [bh, lh])
```

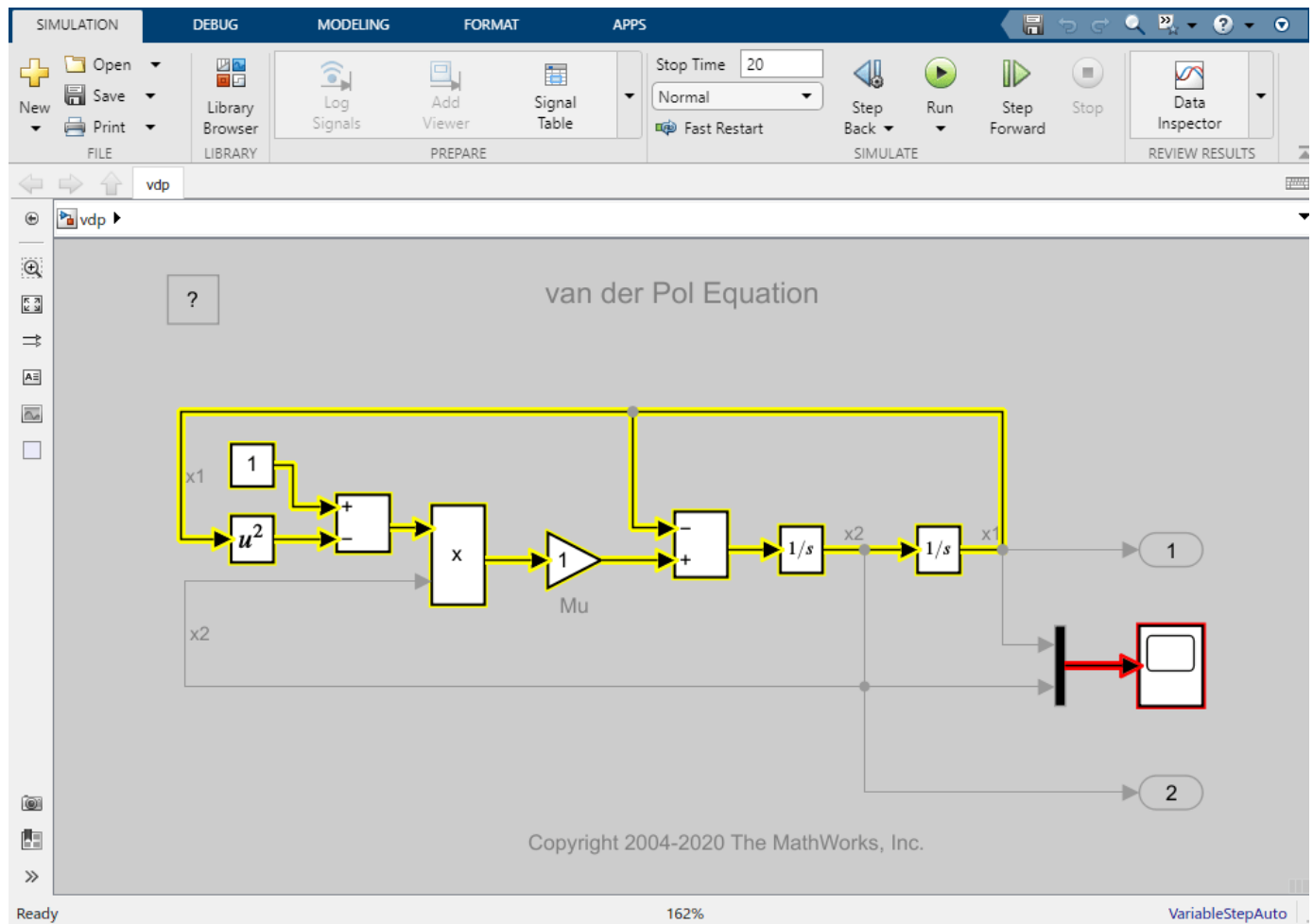

Remove the highlighting.

`removeHighlight(G)`

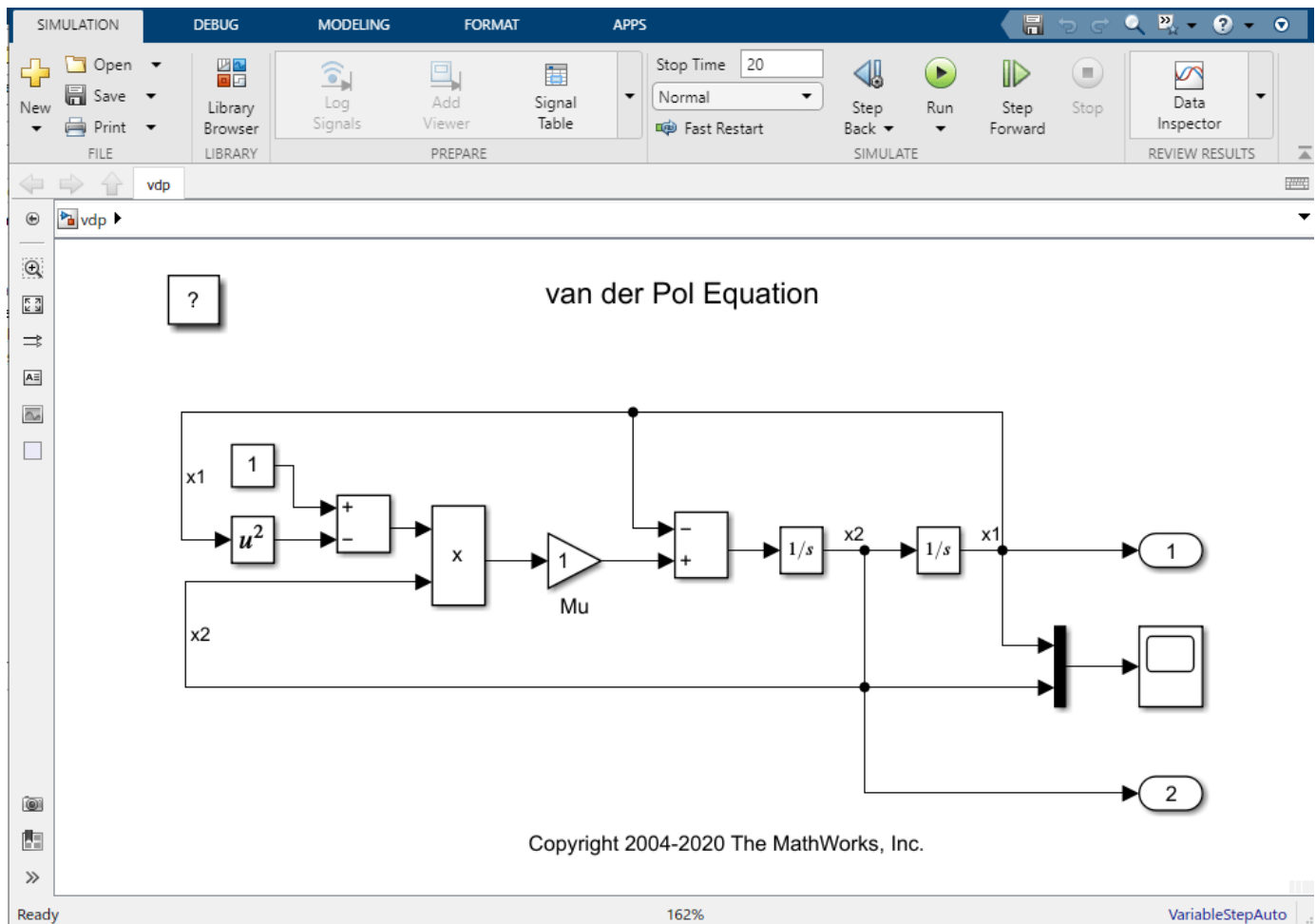

See Also

sltrace

Topics

“Find Shortest Control Path in Simulink Model” on page 13-637

Introduced in R2021b

Simulink.ValueType

Specify properties of signals based on application-specific value types

Description

A `Simulink.ValueType` object is an application-specific set of properties that corresponds to a type of value, such as wind velocity. With `ValueType` objects, you specify the properties once and reuse that specification for each signal that represents the same type of value.

To create and modify `ValueType` objects in the base workspace or a data dictionary, you can use the **Model Explorer** or MATLAB commands. You cannot store `ValueType` objects in model workspaces.

Specify a `ValueType` object:

- At an interface with `Inport`, `Outport`, `In Bus Element`, or `Out Bus Element` blocks
- In a model with `Signal Specification` blocks
- In a `Simulink.BusElement` object

Use `ValueType` objects to validate the properties of a signal and enforce consistency between connected blocks at an interface.

Creation

Use either the `Simulink.ValueType` function described here or the **Model Explorer** to create a `ValueType` object.

Syntax

```
vt = Simulink.ValueType
```

Description

`vt = Simulink.ValueType` returns a `ValueType` object with default property values.

Properties

Data Type — Data type

'double' (default) | character vector | string scalar

Data type, specified as a character vector or string scalar.

You can specify any of these options:

- Built-in Simulink data type — For example, specify `'single'` or `'uint8'`. See “Data Types Supported by Simulink”.
- Fixed-point data type — Use the `fixdt` function. For example, specify `'fixdt(1,16,0)'`.

- Enumerated data type — Use the name of the type preceded by Enum:. For example, specify 'Enum: myEnumType'.
- Custom data type — Use a MATLAB expression that specifies the type. For example, you can specify a Simulink.NumericType object whose DataTypeMode property is set to a value other than 'Fixed-point: unspecified scaling'.

Data Types: char | string

Min — Minimum value

[] (default) | scalar

Minimum value, specified as a finite real double scalar.

Data Types: double

Max — Maximum value

[] (default) | scalar

Maximum value, specified as a finite real double scalar.

Data Types: double

Unit — Physical unit

' ' (default) | character vector | string scalar

Physical unit, specified as a character vector or string scalar.

For more information, see “Unit Specification in Simulink Models”.

Example: 'inches'

Data Types: char | string

Complexity — Numeric type

'real' (default) | 'complex'

Numeric type, specified as 'real' or 'complex'.

Data Types: char | string

Dimensions — Dimensions

1 (default) | scalar | vector

Dimensions, specified as a scalar or vector.

Data Types: double

DimensionsMode — Option to allow only fixed-size or variable-size signals

'Fixed' (default) | 'Variable'

Option to allow only fixed-size or variable-size signals, specified as 'Fixed' or 'Variable', respectively.

Data Types: char | string

Description — Description

' ' (default) | character vector | string scalar

Description, specified as a character vector or string scalar. Use the description to document information about the `ValueType` object, such as the kind of signal it applies to. This information does not affect Simulink processing.

Data Types: `char` | `string`

Examples

Specify Signal Properties for Value Type

In the MATLAB Command Window, define a reusable set of properties that correspond to wind velocity by using the `Simulink.ValueType` function.

Create a `ValueType` object with default properties.

```
windVelocity = Simulink.ValueType
```

```
windVelocity =  
  ValueType with properties:  
  
      DataType: 'double'  
           Min: []  
           Max: []  
          Unit: ''  
    Complexity: 'real'  
    Dimensions: 1  
DimensionsMode: 'Fixed'  
    Description: ''
```

Specify the desired property values for wind velocity.

```
windVelocity.DataType = 'single';  
windVelocity.Min = 11;  
windVelocity.Max = 17;  
windVelocity.Unit = 'm/s';  
windVelocity.Dimensions = [2 4 3];  
windVelocity.Description = 'Wind velocity value type'
```

```
windVelocity =  
  ValueType with properties:  
  
      DataType: 'single'  
           Min: 11  
           Max: 17  
          Unit: 'm/s'  
    Complexity: 'real'  
    Dimensions: [2 4 3]  
DimensionsMode: 'Fixed'  
    Description: 'Wind velocity value type'
```

See Also

`Simulink.BusElement` | `systemcomposer.ValueType`

Topics

“Specify Application-Specific Signal Properties”

“Display Signal Attributes”

“Signal Basics”

Introduced in R2021b

Stateflow.EMChart

Stateflow interface to MATLAB Function block

Description

Use `Stateflow.EMChart` objects to configure MATLAB Function blocks through the Stateflow programmatic interface. For more information, see “Overview of the Stateflow API” (Stateflow).

Tip You can also configure the properties of a MATLAB Function block programmatically by using a `MATLABFunctionConfiguration` object. This object provides a direct interface to the properties of a MATLAB Function block. For more information, see “Configure MATLAB Function Blocks Programmatically”.

Creation

Each MATLAB Function block has its own `Stateflow.EMChart` object. When you add a MATLAB Function block to a Simulink model, a `Stateflow.EMChart` object is automatically created for it. For example, you can use the function `add_block`:

```
add_block('simulink/User-Defined Functions/MATLAB Function', ...
         'myModel/MATLAB Function')
```

Then, to access the `Stateflow.EMChart` object, call the `find` function for the `Simulink.Root` object:

```
rt = sfroot;
block = find(rt, '-isa', 'Stateflow.EMChart', ...
            'Path', 'myModel/MATLAB Function')
```

Properties

Stateflow API objects have properties that correspond to the values you set in the Stateflow Editor. To access or modify a property, use dot notation. To access or modify multiple properties for multiple API objects, use the `get` and `set` functions, respectively. For more information, see “Modify Properties and Call Functions of Stateflow Objects” (Stateflow).

Content

Name — Name of MATLAB Function block

'MATLAB Function' (default) | character vector

Name of the MATLAB Function block, specified as a character vector.

Script — Code for MATLAB Function block

character vector

Code for the MATLAB Function block, specified as a character vector. To enter multiple lines of code, you can:

- Call the MATLAB function `sprintf` and use `\n` to insert newline characters:

```
str = sprintf('function y=f(x)\ny=x+1;\nend');
block.Script = str;
```

- Enter a concatenated text expression that uses the integer 10 as the ASCII equivalent of a newline character:

```
str = ['function y=f(x)',10, ...
      'y=x+1;',10, ...
      'end'];
block.Script = str;
```

SupportVariableSizing — Whether MATLAB Function block supports variable-size data

true or 1 (default) | false or 0

Whether the MATLAB Function block supports variable-size data, specified as a numeric or logical 1 (true) or 0 (false). Only variable-size data can change dimension during simulation. For more information, see “Declare Variable-Size Inputs and Outputs”.

AllowDirectFeedthrough — Whether MATLAB Function block supports direct feedthrough semantics

true or 1 (default) | false or 0

Whether the MATLAB Function block supports direct feedthrough semantics, specified as a numeric or logical 1 (true) or 0 (false). For more information, see “Allow direct feedthrough”.

VectorOutputs1D — Whether MATLAB Function block outputs column vectors as one-dimensional data

false or 0 (default) | true or 1

Whether the MATLAB Function block outputs column vectors as one-dimensional data, specified as a numeric or logical 0 (false) or 1 (true). For more information, see “Interpret output column vectors as one-dimensional data”.

Interface

Inputs — Input arguments

array of `Stateflow.Data` objects

This property is read-only.

Input arguments of the MATLAB Function block, specified as an array of `Stateflow.Data` objects. The value of this property depends on the inputs defined in the `Script` property for the block.

Outputs — Output arguments

array of `Stateflow.Data` objects

This property is read-only.

Output arguments of the MATLAB Function block, specified as an array of `Stateflow.Data` objects. The value of this property depends on the outputs defined in the `Script` property for the block.

Discrete and Continuous-Time Semantics

ChartUpdate — Activation method for MATLAB Function block

'INHERITED' (default) | 'CONTINUOUS' | 'DISCRETE'

Activation method for the MATLAB Function block, specified as 'CONTINUOUS', 'DISCRETE', or 'INHERITED'. For more information, see “Update method”.

SampleTime — Sample time for activating MATLAB Function block

'-1' (default) | character vector

Sample time for activating the MATLAB Function block, specified as a character vector. This property applies only when the ChartUpdate property for the MATLAB function is 'DISCRETE'.

Integer and Fixed-Point Data

SaturateOnIntegerOverflow — Whether data saturates on integer overflow

true or 1 (default) | false or 0

Whether the data in the MATLAB Function block saturates on integer overflow, specified as a numeric or logical 1 (true) or 0 (false). When this property is disabled, the data in the function wraps on integer overflow. For more information, see “Saturate on integer overflow”.

TreatAsFi — Inherited Simulink signals to treat as fi objects

'Fixed-point' (default) | 'Fixed-point & Integer'

Inherited Simulink signals to treat as Fixed-Point Designer fi objects, specified as one of these values:

- 'Fixed-point' — The MATLAB Function block treats all fixed-point inputs as fi objects.
- 'Fixed-point & Integer' — The MATLAB Function block treats all fixed-point and integer inputs as fi objects.

EmlDefaultFimath — Default fimath properties

'Same as MATLAB Default' (default) | 'Other:UserSpecified'

Default fimath properties for the MATLAB Function block, specified as one of these values:

- 'Same as MATLAB Default' — Use the same fimath properties as the current default fimath object.
- 'Other:UserSpecified' — Use the InputFimath property to specify the default fimath object.

InputFimath — Default fimath object

character vector

Default fimath object, specified as a character vector. When the EmlDefaultFimath property for the MATLAB Function block is 'Other:UserSpecified', you can use this property to:

- Enter an expression that constructs a fimath object.
- Enter the variable name for a fimath object in the MATLAB or model workspace.

Hierarchy

Machine — Machine that contains MATLAB Function block

Stateflow.Machine object

This property is read-only.

Machine that contains the MATLAB Function block, specified as a Stateflow.Machine object.

Path — Location of MATLAB Function block in model hierarchy

character vector

This property is read-only.

Location of the MATLAB Function block in the model hierarchy, specified as a character vector.

Dirty — Whether MATLAB Function block has changed

true or 1 | false or 0

Whether the MATLAB Function block has changed after being opened or saved, specified as a numeric or logical 1 (true) or 0 (false).

Locked — Whether MATLAB Function block is locked

false or 0 (default) | true or 1

Whether the MATLAB Function block is locked, specified as a numeric or logical 1 (true) or 0 (false). Enable this property to prevent changes in the MATLAB Function block.

Iced — Whether MATLAB Function block is locked

false or 0 (default) | true or 1

This property is read-only.

Whether the MATLAB Function block is locked, specified as a numeric or logical 1 (true) or 0 (false). This property is equivalent to the property Locked, but is used internally to prevent changes in the MATLAB Function block during simulation.

Identification**Description — Description**

' ' (default) | character vector

Description for the MATLAB Function block, specified as a character vector.

Document — Document link

' ' (default) | character vector

Document link for the MATLAB Function block, specified as a character vector.

Tag — User-defined tag

[] (default) | any data type

User-defined tag for the MATLAB Function block, specified as data of any type.

Id — Unique identifier

scalar

This property is read-only.

Unique identifier, specified as an integer scalar. Use this property to distinguish the MATLAB Function block from other objects in the model. The value of this property is reassigned every time you start a new MATLAB session and may be recycled after an object is deleted.

Object Functions

| | |
|-------------|---|
| find | Identify specified objects in hierarchy |
| getChildren | Identify children of object |
| dialog | Open properties dialog box |
| view | Display object in editing environment |

Examples

Program MATLAB Function Block

Access the Stateflow.EMChart object for a MATLAB Function block.

```
block = find(sfroot, '-isa', 'Stateflow.EMChart');
```

Store the MATLAB code to calculate the mean and standard deviation for a vector of values as a character vector.

```
str = ['function [mean,stdev] = stats(vals)',10, ...  
'% Calculates a statistical mean and a standard',10, ...  
'% deviation for the values in vals.',10,10, ...  
'len = length(vals);',10, ...  
'mean = avg(vals,len);',10, ...  
'stdev = sqrt(sum(((vals-avg(vals,len)).^2))/len);',10, ...  
'plot(vals,'-+');',10,10,...  
'function mean = avg(array,size)',10, ...  
'mean = sum(array)/size;'];
```

Populate the block with code by modifying the Script property of the corresponding Stateflow.EMChart object.

```
block.Script = str;
```

Open the function in the MATLAB Function Block Editor.

```
view(block)
```

The editor shows this code.

```
function [mean,stdev] = stats(vals)  
% Calculates a statistical mean and a standard  
% deviation for the values in vals.  
  
len = length(vals);  
mean = avg(vals,len);  
stdev = sqrt(sum(((vals-avg(vals,len)).^2))/len);  
plot(vals,'-+');  
  
function mean = avg(array,size)  
mean = sum(array)/size;
```

Import Code from MATLAB Function

Open a Simulink model called myModel.

```
open_system('myModel')
```

Add a MATLAB Function block to myModel.

```
blockPath = 'myModel/My Function';
add_block('simulink/User-Defined Functions/MATLAB Function',blockPath)
```

Populate the block with code from the MATLAB function myFunction.m.

```
block = find(sfroot, '-isa', 'Stateflow.EMChart', ...
    'Path', newBlockPath);
block.Script = fileread('myFunction.m');
```

Find Number of MATLAB Function Blocks in Model

Open a Simulink model called myModel.

```
open_system('myModel')
```

Access the Simulink.Root object at the top level of the Stateflow hierarchy.

```
rt = sfroot;
```

Find the MATLAB Function blocks in the model.

```
blocks = find(rt, '-isa', 'Stateflow.EMChart');
```

Count the number of blocks.

```
numel(blocks);
```

See Also

Blocks

MATLAB Function

Functions

sfroot | add_block | fileread | numel

Objects

MATLABFunctionConfiguration

Topics

“Overview of the Stateflow API” (Stateflow)

“Implementing MATLAB Functions Using Blocks”

“Create Custom Functionality Using MATLAB Function Blocks”

“Specify MATLAB Function Block Properties”

“List of Stateflow API Properties” (Stateflow)

Introduced in R2011a

Model Advisor Checks

Simulink Checks

In this section...

- "Simulink Check Overview" on page 9-4
- "Migrating to Simplified Initialization Mode Overview" on page 9-4
- "Identify unconnected lines, input ports, and output ports" on page 9-4
- "Check root model Inport block specifications" on page 9-5
- "Check optimization settings" on page 9-6
- "Check diagnostic settings ignored during accelerated model reference simulation" on page 9-8
- "Check for parameter tunability information ignored for referenced models" on page 9-9
- "Check for implicit signal resolution" on page 9-9
- "Check for optimal bus virtuality" on page 9-10
- "Check for Discrete-Time Integrator blocks with initial condition uncertainty" on page 9-10
- "Identify disabled library links" on page 9-11
- "Check for large number of function arguments from virtual bus across model reference boundary" on page 9-12
- "Identify parameterized library links" on page 9-12
- "Identify unresolved library links" on page 9-13
- "Identify configurable subsystem blocks for converting to variant subsystem blocks" on page 9-14
- "Identify Variant Model blocks and convert those to Variant Subsystem containing Model block choices" on page 9-14
- "Identify Variant blocks using Variant objects with empty conditions" on page 9-14
- "Check usage of function-call connections" on page 9-15
- "Check Data Store Memory blocks for multitasking, strong typing, and shadowing issues" on page 9-15
- "Check if read/write diagnostics are enabled for data store blocks" on page 9-16
- "Check data store block sample times for modeling errors" on page 9-17
- "Check for potential ordering issues involving data store access" on page 9-18
- "Check structure parameter usage with bus signals" on page 9-19
- "Check Delay, Unit Delay and Zero-Order Hold blocks for rate transition" on page 9-20
- "Check for calls to slDataTypeAndScale" on page 9-21
- "Check bus signals treated as vectors" on page 9-22
- "Check for potentially delayed function-call subsystem return values" on page 9-23
- "Identify block output signals with continuous sample time and non-floating point data type" on page 9-24
- "Check usage of Merge blocks" on page 9-25
- "Check usage of Outport blocks" on page 9-27
- "Check usage of Discrete-Time Integrator blocks" on page 9-34
- "Check model settings for migration to simplified initialization mode" on page 9-35
- "Check S-functions in the model" on page 9-36

In this section...

- "Check for non-continuous signals driving derivative ports" on page 9-37
- "Runtime diagnostics for S-functions" on page 9-38
- "Identify unit mismatches in the model" on page 9-38
- "Identify automatic unit conversions in the model" on page 9-39
- "Identify disallowed unit systems in the model" on page 9-39
- "Identify undefined units in the model" on page 9-40
- "Identify ambiguous units in the model" on page 9-40
- "Check model for block upgrade issues" on page 9-41
- "Check model for block upgrade issues requiring compile time information" on page 9-41
- "Check if SLX file compression is off" on page 9-42
- "Check that the model or library is saved in current version" on page 9-43
- "Check model for SB2SL blocks" on page 9-43
- "Check Model History properties" on page 9-44
- "Identify Model Info blocks that can interact with external source control tools" on page 9-45
- "Identify Model Info blocks that use the Configuration Manager" on page 9-45
- "Check model for upgradable SerDes Toolbox blocks" on page 9-46
- "Check model for legacy 3DoF or 6DoF blocks" on page 9-46
- "Check model for Aerospace Blockset navigation blocks" on page 9-47
- "Check and update masked blocks in library to use promoted parameters" on page 9-47
- "Check and update mask image display commands with unnecessary imread() function calls" on page 9-48
- "Check and update mask to affirm icon drawing commands dependency on mask workspace" on page 9-49
- "Identify masked blocks that specify tabs in mask dialog using MaskTabNames parameter" on page 9-49
- "Identify questionable operations for strict single-precision design" on page 9-50
- "Check get_param calls for block CompiledSampleTime" on page 9-51
- "Check if all simulation outputs are returned as a single Simulink.SimulationOutput object" on page 9-53
- "Check model for parameter initialization and tuning issues" on page 9-53
- "Check for virtual bus across model reference boundaries" on page 9-54
- "Check model for custom library blocks that rely on frame status of the signal" on page 9-55
- "Check model for S-function upgrade issues" on page 9-56
- "Update System object syntax" on page 9-57
- "Check Rapid accelerator signal logging" on page 9-57
- "Check virtual bus inputs to blocks" on page 9-58
- "Check for root outports with constant sample time" on page 9-61
- "Analyze model hierarchy and continue upgrade sequence" on page 9-61
- "Check Access to Data Stores" on page 9-63

In this section...

“Check relative execution orders for Data Store Read and Data Store Write blocks” on page 9-63

“Check for case mismatches in references to models and libraries” on page 9-64

“Check model for Signal Builder blocks” on page 9-64

“Check output dimensions of MATLAB Function blocks” on page 9-64

“Check model for RF Blockset Divider blocks using Wilkinson power divider component with broken connections” on page 9-65

“Identify Environment Controller Blocks and Replace Them with Variant Source Blocks” on page 9-66

Simulink Check Overview

Use the Simulink Model Advisor checks to configure your model for simulation.

See Also

- “Run Model Advisor Checks”
- “Simulink Coder Checks” (Simulink Coder)
- “Simulink Check Checks” (Simulink Check)

Migrating to Simplified Initialization Mode Overview

Simplified initialization mode was introduced in R2008b to improve the consistency of simulation results. This mode is especially important for models that do not specify initial conditions for conditionally executed subsystem output ports. For more information, see “Simplified Initialization Mode” and “Classic Initialization Mode”.

Use the Model Advisor checks in **Migrating to Simplified Initialization Mode** to help migrate your model to simplified initialization mode.

See Also

- “Simplified Initialization Mode”
- “Classic Initialization Mode”
- “Underspecified initialization detection”
- “Check usage of Merge blocks” on page 9-25
- “Check usage of Output blocks” on page 9-27
- “Check usage of Discrete-Time Integrator blocks” on page 9-34
- “Check model settings for migration to simplified initialization mode” on page 9-35

Identify unconnected lines, input ports, and output ports

Check ID: `mathworks.design.UnconnectedLinesPorts`

Check for unconnected lines or ports.

Description

This check lists unconnected lines or ports. These can have difficulty propagating signal attributes such as data type, sample time, and dimensions.

Note Ports connected to ground/terminator blocks will pass this test.

Results and Recommended Actions

| Condition | Recommended Action |
|--|--|
| Lines, input ports, or output ports are unconnected. | Connect the signals. Double-click the list of unconnected items to locate failure. |

Capabilities and Limitations

You can:

- Run this check on your library models.
- Exclude blocks and charts from this check if you have a Simulink Check license.

Tips

Use the `PortConnectivity` command to obtain an array of structures describing block input or output ports.

See Also

“Common Block Properties” on page 6-12 for information on the `PortConnectivity` command.

“Model Advisor Exclusion Overview” (Simulink Check)

Check root model Inport block specifications

Check ID: `mathworks.design.RootInportSpec`

Check that root model Inport blocks fully define dimensions, sample time, and data type.

Description

Using root model Inport blocks that do not fully define dimensions, sample time, or data type can lead to undesired simulation results. Simulink software back-propagates dimensions, sample times and data types from downstream blocks unless you explicitly assign them values.

Results and Recommended Actions

| Condition | Recommended Action |
|---|--|
| Root-level Inport blocks have undefined attributes. | Fully define the attributes of the root-level Inport blocks. |

Capabilities and Limitations

If you have a Simulink Check license, you can exclude blocks and charts from this check.

Tips

The following configurations pass this check:

- **Configuration Parameters > Solver > Periodic sample time constraint** is set to Ensure sample time independent
- For export-function models, *inherited sample time* is not flagged.

See Also

- “About Data Types in Simulink”.
- “Determine Signal Dimensions”.
- “Specify Sample Time”.
- “Model Advisor Exclusion Overview” (Simulink Check)

Check optimization settings

Check ID: `mathworks.design.OptimizationSettings`

Check for optimizations that can lead to non-optimal code generation and simulation.

Description

This check reviews the status of optimizations that can improve code efficiency and simulation time.

Results and Recommended Actions

| Condition | Recommended Action |
|---|---|
| <p>The specified optimizations are off.</p> | <p>Select the following optimization check boxes on the Optimization pane in the Configuration Parameters dialog box:</p> <ul style="list-style-type: none"> • “Remove root level I/O zero initialization” (Embedded Coder) • “Remove internal data zero initialization” (Embedded Coder) <p>Select the following optimization check boxes on the Optimization pane in the Configuration Parameters dialog box:</p> <ul style="list-style-type: none"> • “Inline invariant signals” (Simulink Coder) (only if you have a Simulink Coder license) <p>Select the following optimization check boxes in the Configuration Parameters dialog box:</p> <ul style="list-style-type: none"> • “Block reduction” • “Conditional input branch execution” • “Implement logic signals as Boolean data (vs. double)” • “Use memset to initialize floats and doubles to 0.0” (Simulink Coder) • “Remove code from floating-point to integer conversions that wraps out-of-range values” (Simulink Coder) (only if you have a Simulink Coder license) • “Signal storage reuse” (Simulink Coder) (only if you have a Simulink Coder license) • “Enable local block outputs” (Simulink Coder) • “Reuse local block outputs” (Simulink Coder) • “Eliminate superfluous local variables (Expression folding)” (Simulink Coder) <p>Select the following optimization check boxes on the Optimization pane in the Configuration Parameters dialog box:</p> <hr/> <p>Note Model Advisor checks these parameters only if there is a Stateflow chart in the model.</p> <hr/> <ul style="list-style-type: none"> • “Use bitsets for storing state configuration” (Simulink Coder) • “Use bitsets for storing Boolean data” (Simulink Coder) |
| <p>“Application lifespan (days)” is set as infinite. This could lead to expensive 64-bit counter usage.</p> | <p>Choose a stop time if this is not intended.</p> |

| Condition | Recommended Action |
|--|--|
| The specified diagnostics, which can increase the time it takes to simulate your model, are set to warning or error. | Select none for: <ul style="list-style-type: none"> • Solver data inconsistency • Array bounds exceeded • Diagnostics > Data Validity > Simulation range checking |
| The specified Embedded Coder parameters are off. | If you have an Embedded Coder license and you are using an ERT-based system target file: <ul style="list-style-type: none"> • Select Single output/update function. For details, see “Single output/update function” (Simulink Coder). • Select Ignore test point signals. For details, see “Ignore test point signals” (Embedded Coder). • Set Pass reusable subsystem outputs as to <code>Individual</code> arguments. For details, see “Pass reusable subsystem outputs as” (Embedded Coder). |

Tips

If the system contains Model blocks and the referenced model is in Accelerator mode, simulating the model requires generating and compiling code.

check

See Also

- “Model Configuration Parameters: Code Generation Optimization” (Simulink Coder)

Check diagnostic settings ignored during accelerated model reference simulation

Check ID: `mathworks.design.ModelRefSIMConfigCompliance`

Checks for referenced models for which Simulink changes configuration parameter settings during accelerated simulation.

Description

For models referenced in accelerator mode, Simulink ignores the settings of the following configuration parameters that you set to a value other than None.

- **Array bounds exceeded**
- **Diagnostics > Data Validity > Inf or NaN block output**
- **Diagnostics > Data Validity > Division by singular matrix**
- **Diagnostics > Data Validity > Wrap on overflow**

Also, for models referenced in accelerator mode, Simulink ignores the following **Configuration Parameters > Diagnostics > Data Validity > Data Store Memory block** parameters if you set them to a value other than `Disable all`. For details, see “Data Store Diagnostics”.

- **Detect read before write**

- **Detect write after read**
- **Detect write after write**

Results and Recommended Actions

| Condition | Recommended Action |
|--|--|
| You want to see the results of running the identified diagnostics with settings to produce warnings or errors. | Simulate the model in Normal mode and resolve diagnostic warnings or errors. |

Check for parameter tunability information ignored for referenced models

Check ID: `mathworks.design.ParamTunabilityIgnored`

Checks if parameter tunability information is included in the Model Parameter Configuration dialog box.

Description

Simulink software ignores tunability information specified in the Model Parameter Configuration dialog box. This check identifies those models containing parameter tunability information that Simulink software will ignore if the model is referenced by other models.

Results and Recommended Actions

| Condition | Recommended Action |
|--|--|
| Model contains ignored parameter tunability information. | Click the links to convert to equivalent Simulink parameter objects in the MATLAB workspace. |

See Also

- “Create Tunable Calibration Parameter in the Generated Code” (Simulink Coder)

Check for implicit signal resolution

Check ID: `mathworks.design.ImplicitSignalResolution`

Identify models that attempt to resolve named signals and states to `Simulink.Signal` objects.

Description

Requiring Simulink software to resolve all named signals and states is inefficient and slows incremental code generation and model reference. This check identifies those signals and states for which you may turn off implicit signal resolution and enforce resolution.

Results and Recommended Actions

| Condition | Recommended Action |
|--|---|
| Not all signals and states are resolved. | Turn off implicit signal resolution and enforce resolution for each signal and state that does resolve. |

See Also

“Resolve Signal Objects for Output Data”.

Check for optimal bus virtuality

Check ID: `mathworks.design.OptBusVirtuality`

Identify virtual buses that could be made nonvirtual. Making these buses nonvirtual improves generated code efficiency.

Description

This check identifies blocks incorporating virtual buses that cross a subsystem boundary. Changing these to nonvirtual improves generated code efficiency.

Results and Recommended Actions

| Condition | Recommended Action |
|--|---|
| Blocks that specify a virtual bus crossing a subsystem boundary. | Change the highlighted bus to nonvirtual. |

Capabilities and Limitations

You can:

- Run this check on your library models.
- Exclude blocks and charts from this check if you have a Simulink Check license.

See Also

- “Signal Basics”
- “Types of Composite Signals”
- “Model Advisor Exclusion Overview” (Simulink Check)

Check for Discrete-Time Integrator blocks with initial condition uncertainty

Check ID: `mathworks.design.DiscreteTimeIntegratorInitCondition`

Identify Discrete-Time Integrator blocks with state ports and initial condition ports that are fed by neither an Initial Condition nor a Constant block.

Description

Discrete-Time Integrator blocks with state port and initial condition ports might not be suitably initialized unless they are fed from an Initial Condition or Constant block. This is more likely to happen when Discrete-Time Integrator blocks are used to model second-order or higher-order dynamic systems.

Results and Recommended Actions

| Condition | Recommended Action |
|--|--|
| Discrete-Time Integrator blocks are not initialized during the model initialization phase. | Add a Constant or Initial Condition block to feed the external Initial Condition port. |

Capabilities and Limitations

You can:

- Run this check on your library models.
- Exclude blocks and charts from this check if you have a Simulink Check license.

See Also

- IC block
- Discrete-Time Integrator block
- Constant block
- “Model Advisor Exclusion Overview” (Simulink Check)

Identify disabled library links

Check ID: `mathworks.design.DisabledLibLinks`

Search model for disabled library links.

Description

Disabled library links can cause unexpected simulation results. Resolve disabled links before saving a model.

Note This check may overlap with “Check model for block upgrade issues” on page 9-41.

Results and Recommended Actions

| Condition | Recommended Action |
|-----------------------------|---|
| Library links are disabled. | Click the Library Link > Resolve link option in the context menu. |

Capabilities and Limitations

You can:

- Run this check on your library models.
- Exclude blocks and charts from this check if you have a Simulink Check license.

Tips

- Use the Model Browser to find library links.
- To enable a broken link, right-click a block in your model to display the context menu. Select **Library Link > Resolve link**.

See Also

“Restore Disabled Links”

“Model Advisor Exclusion Overview” (Simulink Check)

Check for large number of function arguments from virtual bus across model reference boundary

Check ID: `mathworks.design.CheckVirtualBusAcrossModelReferenceArgs`

Checks virtual bus signals that cross model reference boundaries and flags cases where using virtual buses across a model reference boundary increases the number of function arguments significantly.

Description

To improve the speed of the code generation process, you can use this check to reduce the number of generated function arguments. If the check finds a model that where many arguments will be generated for a function, you can click **Update Model** to modify the model so that it generates fewer arguments.

Results and Recommended Action

Methods that generate many function arguments as the result of a virtual bus signal crossing model reference boundary slow down the code generation process.

| Condition | Recommended Action |
|---|-----------------------------|
| Methods are listed that generate a large number of arguments for the current the model configuration that this check can reduce by modifying the model. | Click Update Model . |

Clicking **Update Model** resets Inport and Outport block parameters and inserts Signal Conversion blocks, as necessary, to reduce the number of generated function arguments for the model.

See Also

“Use Buses at Model Interfaces”

Identify parameterized library links

Check ID: `mathworks.design.ParameterizedLibLinks`

Search model for parameterized library links.

Description

Parameterized library links that are unintentional can result in unexpected parameter settings in your model. This can result in improper model operation.

Results and Recommended Actions

| Condition | Recommended Action |
|---------------------------------|---|
| Parameterized links are listed. | Verify that the links are intended to be parameterized. |

Capabilities and Limitations

You can:

- Run this check on your library models.
- Exclude blocks and charts from this check if you have a Simulink Check license.

Tips

- Right-click a block in your model to display the context menu. Choose **Link Options** and click **Go To Library Block** to see the original block from the library.
- To parameterize a library link, choose **Look Under Mask**, from the context menu and select the parameter.

See Also

“Restore Disabled Links”

“Model Advisor Exclusion Overview” (Simulink Check)

Identify unresolved library links

Check ID: mathworks.design.UnresolvedLibLinks

Search the model for unresolved library links, where the specified library block cannot be found.

Description

Check for unresolved library links. Models do not simulate while there are unresolved library links.

Results and Recommended Actions

| Condition | Recommended Action |
|-------------------------------|---|
| Library links are unresolved. | Locate missing library block or an alternative. |

Capabilities and Limitations

You can:

- Run this check on your library models.
- Exclude blocks and charts from this check if you have a Simulink Check license.

See Also

“Fix Unresolved Library Links”

“Model Advisor Exclusion Overview” (Simulink Check)

Identify configurable subsystem blocks for converting to variant subsystem blocks

Check ID: `mathworks.design.CSStoVSSConvert`

Search the model to identify configurable subsystem blocks at the model or subsystem level.

Results and Recommended Actions

| Condition | Recommended Action |
|---|---|
| Configurable subsystem blocks are identified. | Convert these blocks to variant subsystem blocks to avoid compatibility issues. See Configurable Subsystem. |

Capabilities and Limitations

You can run this check on your library models.

See Also

“Convert to Variant Subsystem” on page 1-180

Identify Variant Model blocks and convert those to Variant Subsystem containing Model block choices

Check ID: `mathworks.design.ConvertMdlrefVarToVSS`

Search the model to identify Variant Model blocks.

Results and Recommended Actions

| Condition | Recommended Action |
|---|---|
| Variant Model blocks available in the model are listed. | Convert these blocks to Variant Subsystem blocks. |

See Also

“Convert to Variant Subsystem Block”

Identify Variant blocks using Variant objects with empty conditions

Check ID: `mathworks.design.emptyVariant0bjects`

Search the model to identify the Variant blocks or library having empty Variant objects.

Results and Recommended Actions

| Condition | Recommended Action |
|---|--|
| The Variant blocks in the model or library having empty Variant objects are listed. | Use valid conditions in the variant objects. |

See Also

“Introduction to Variant Controls”

Check usage of function-call connections

Check ID: `mathworks.design.CheckForProperFcnCallUsage`

Check model diagnostic settings that apply to function-call connectivity and that might impact model execution.

Description

Check for connectivity diagnostic settings that might lead to non-deterministic model execution.

Results and Recommended Actions

| Condition | Recommended Action |
|---|--|
| Diagnostic > Connectivity > Context-dependent inputs is set to <code>Disable All</code> or <code>Use local settings</code> . This might lead to non-deterministic model execution. | Set Diagnostics > Connectivity > Context-dependent inputs to <code>Enable all</code> as errors. |

See Also

Function-Call Subsystem

Check Data Store Memory blocks for multitasking, strong typing, and shadowing issues

Check ID: `mathworks.design.DataStoreMemoryBlkIssue`

Look for modeling issues related to Data Store Memory blocks.

Description

Checks for multitasking data integrity, strong typing, and shadowing of data stores of higher scope.

Results and Recommended Actions

| Condition | Recommended Action |
|---|--|
| The Duplicate data store names check is set to <code>none</code> or <code>warning</code> . | Consider setting the “Duplicate data store names” check to <code>error</code> in the Configuration Parameters dialog box, on the Diagnostics > Data Validity pane. |

| Condition | Recommended Action |
|--|--|
| <p>The data store variable names are not strongly typed in one of the following:</p> <ul style="list-style-type: none"> • Signal Attributes pane of the Block Parameters dialog for the Date Store Memory block • Global data store name | <p>Specify a data type other than auto by taking one of the following actions:</p> <ul style="list-style-type: none"> • Choose a data type other than <code>Inherit: auto</code> on the Signal Attributes pane of the Block Parameters dialog for the Date Store Memory block. • If you are using a global data store name, then specify its data type in the <code>Simulink.Signal</code> object. |
| <p>The Multitask data store check is set to none or warning.</p> | <p>Consider setting the “Multitask data store” check to error in the Configuration Parameters dialog box, on the Diagnostics > Data Validity pane.</p> |

Capabilities and Limitations

If you have a Simulink Check license, you can exclude blocks and charts from this check.

See Also

- “Local and Global Data Stores”
- “Storage Classes for Data Store Memory Blocks” (Simulink Coder)
- Data Store Memory
- Data Store Read
- Data Store Write
- “Duplicate data store names”
- “Multitask data store”
- “Model Advisor Exclusion Overview” (Simulink Check)

Check if read/write diagnostics are enabled for data store blocks

Check ID: `mathworks.design.DiagnosticDataStoreBlk`

For data store blocks in the model, enable the read-and-write diagnostics order checking to detect run-time issues.

Description

Check for the read-and-write diagnostics order checking. By enabling the read-and-write diagnostics, you detect potential run-time issues.

Results and Recommended Actions

| Condition | Recommended Action |
|---|---|
| <p>The Detect read before write check is disabled.</p> | <p>Consider enabling “Detect read before write” in the Configuration Parameter dialog box Diagnostics > Data Validity pane.</p> |

| Condition | Recommended Action |
|--|---|
| The Detect write after read check is disabled. | Consider enabling “Detect write after read” in the Configuration Parameter dialog box Diagnostics> Data Validity pane. |
| The Detect write after write check is disabled. | Consider enabling “Detect write after write” in the Configuration Parameter dialog box Diagnostics> Data Validity pane. |

Capabilities and Limitations

Exclude blocks and charts from this check if you have a Simulink Check license.

Tips

.

- The run-time diagnostics can slow simulations down considerably. Once you have verified that Simulink does not generate warnings or errors during simulation, set them to **Disable all**.

See Also

- “Local and Global Data Stores”
- Data Store Memory
- Data Store Read
- Data Store Write
- “Detect read before write”
- “Detect write after read”
- “Detect write after write”
- “Check for potential ordering issues involving data store access” on page 9-18
- “Model Advisor Exclusion Overview” (Simulink Check)

Check data store block sample times for modeling errors

Check ID: `mathworks.design.DataStoreBlkSampleTime`

Identify modeling errors due to the sample times of data store blocks.

Description

Check data store blocks for continuous or fixed-in-minor-step sample times.

Results and Recommended Actions

| Condition | Recommended Action |
|--|--|
| Data store blocks in your model have continuous or fixed-in-minor-step sample times. | Consider making the listed blocks discrete or replacing them with either Memory or Goto and From blocks. |

Capabilities and Limitations

If you have a Simulink Check license, you can exclude blocks and charts from this check.

See Also

- “Local and Global Data Stores”
- Data Store Memory
- Data Store Read
- Data Store Write
- “Fixed-in-Minor-Step”
- “Model Advisor Exclusion Overview” (Simulink Check)

Check for potential ordering issues involving data store access

Check ID: `mathworks.design.OrderingDataStoreAccess`

Look for read/write issues which may cause inaccuracies in the results.

Description

During an **Update Diagram**, identify potential issues relating to read-before-write, write-after-read, and write-after-write conditions for data store blocks.

Results and Recommended Actions

| Condition | Recommended Action |
|---|---|
| Reading and writing (read-before-write or write-after-read condition) occur out of order. | Consider restructuring your model so that the Data Store Read block executes before the Data Store Write block. |
| Multiple writes occur within a single time step. | Change the model to write data only once per time step or refer to the following Tips section. |

Capabilities and Limitations

If you have a Simulink Check license, you can exclude blocks and charts from this check.

Tips

This check performs a static analysis which might not identify every instance of improper usage. Specifically, Function-Call Subsystems, Stateflow Charts, MATLAB for code generation, For Iterator Subsystems, and For Each Subsystems can cause both missed detections and false positives. For a more comprehensive check, consider enabling the following diagnostics on the **Diagnostics > Data Validity** pane in the Configuration Parameters dialog box: “Detect read before write”, “Detect write after read”, and “Detect write after write”.

See Also

- “Local and Global Data Stores”
- Data Store Memory

- Data Store Read
- Data Store Write
- “Detect read before write”
- “Detect write after read”
- “Detect write after write”
- “Model Advisor Exclusion Overview” (Simulink Check)

Check structure parameter usage with bus signals

Check ID: `mathworks.design.MismatchedBusParams`

Identify blocks and `Simulink.Signal` objects that initialize bus signals by using mismatched structures.

Description

In a model, you can use a MATLAB structure to initialize a bus signal. For example, if you pass a bus signal through a Unit Delay block, you can set the **Initial condition** parameter to a structure. For basic information about initializing buses by using structures, see “Specify Initial Conditions for Bus Elements”.

Run this check to generate efficient and readable code by matching the shape and numeric data types of initial condition structures with those of bus signals. Matching these characteristics avoids unnecessary explicit typecasts and replaces field-by-field structure assignments with, for example, calls to `memcpy`.

Partial Structures

This check lists blocks and `Simulink.Signal` objects that initialize bus signals by using partial structures. During the iterative process of creating a model, you can use partial structures to focus on a subset of signal elements in a bus. For a mature model, use full structures to:

- Generate readable and efficient code.
- Support a modeling style that explicitly initializes unspecified signals. When you use partial structures, Simulink implicitly initializes unspecified signals.

For more information about full and partial structures, see “Create Full Structures for Initialization” and “Create Partial Structures for Initialization”.

Data Type Mismatches

This check lists blocks and `Simulink.Signal` objects whose initial condition structures introduce data type mismatches. The fields of these structures have numeric data types that do not match the data types of the corresponding bus signal elements.

This check does not detect a mismatch for blocks, such as the Unit Delay block, that implicitly convert the data type of initial condition to the input signal.

When you configure an initial condition structure to appear as a tunable global structure in the generated code, avoid unnecessary explicit typecasts by matching the data types. See “Generate Tunable Initial Condition Structure for Bus Signal” (Simulink Coder).

Results and Recommended Actions

| Condition | Recommended Action |
|---|--|
| Block or signal object uses partial structure | Consider using the function <code>Simulink.Bus.createMATLABStructure</code> to create a full initial condition structure. |
| Data types of structure fields do not match data types of corresponding signal elements | Consider defining the structure as a <code>Simulink.Parameter</code> object, and creating a <code>Simulink.Bus</code> object to use as the data type of the bus signal and of the parameter object. To control numeric data types, use the <code>Simulink.BusElement</code> objects in the bus object. |

See Also

- “Specify Initial Conditions for Bus Elements”
- “Generate Tunable Initial Condition Structure for Bus Signal” (Simulink Coder)
- “Data Stores with Signal Objects”
- `Simulink.Bus.createMATLABStruct`
- `Simulink.Signal`

Check Delay, Unit Delay and Zero-Order Hold blocks for rate transition

Check ID: `mathworks.design.ReplaceZOHDelayByRTB`

Identify Delay, Unit Delay, or Zero-Order Hold blocks that are used for rate transition. Replace these blocks with actual Rate Transition blocks.

Description

If a model uses Delay, Unit Delay, or Zero-Order Hold blocks to provide rate transition between input and output signals, Simulink makes a hidden replacement of these blocks with built-in Rate Transition blocks. In the compiled block diagram, a yellow symbol and the letters “RT” appear in the upper-left corner of a replacement block. This replacement can affect the behavior of the model, as follows:

- These blocks lose their algorithmic design properties to delay a signal or implement zero-order hold. Instead, they acquire rate transition behavior.
- This modeling technique works only in specific transition configurations (slow-to-fast for Delay and Unit Delay blocks, and fast-to-slow for Zero-Order Hold block). Set the block sample time to be equal to the slower rate (source for the Delay and Unit Delay blocks and destination for the Zero-Order Hold block).
- When the block sample time of a downstream or upstream block changes, these Delay, Unit Delay and Zero-Order Hold blocks might not perform rate transition. For example, setting the source and destination sample times equal stops rate transition. The blocks then assume their original algorithmic design properties.
- The block sample time shows incomplete information about sample time rates. The block code runs at two different rates to handle data transfer. However, the block sample time and sample time color show it as a single-rate block. Tools and MATLAB scripts that use sample time information base their behavior on this information.

An alternative is to replace Delay, Unit Delay, or Zero-Order Hold blocks with actual Rate Transition blocks.

- The technique ensures unambiguous results in block behavior. Delay, Unit Delay, or Zero-Order Hold blocks act according to their algorithmic design to delay and hold signals respectively. Only Rate Transition blocks perform actual rate transition.
- Using an actual Rate Transition block for rate transition offers a configurable solution to handle data transfer if you want to specify deterministic behavior or the type of memory buffers to implement.

Use this check to identify instances in your model where Delay, Unit Delay or Zero-Order Hold blocks undergo hidden replacement to provide rate transition between signals. Click **Upgrade Model** to replace these blocks with actual Rate Transition blocks.

Results and Recommended Actions

| Condition | Recommended Action |
|--|---|
| Model has no instances of Delay, Unit Delay, or Zero-Order Hold blocks used for rate transition. | No action required. |
| Model has instances of Delay, Unit Delay, or Zero-Order Hold blocks used for rate transition. | <p>The check identifies these instances and allows you to upgrade the model.</p> <ol style="list-style-type: none"> 1 Click Upgrade Model to replace with actual Rate Transition blocks. 2 Save changes to your model. |

If you do not choose to replace the Delay, Unit Delay, and/or Zero-Order Hold blocks with actual Rate Transition blocks, Simulink continues to perform a hidden replacement of these blocks with built-in rate transition blocks.

Capabilities and Limitations

You can:

- Run this check on your library models.
- Exclude blocks and charts from this check if you have a Simulink Check license.

See Also

- “Run Model Advisor Checks”
- “Model Upgrades”
- Rate Transition
- “Model Advisor Exclusion Overview” (Simulink Check)

Check for calls to `slDataTypeAndScale`

Check ID: `mathworks.design.CallsSlDataTypeAndScale`

Identify calls to the internal function `slDataTypeAndScale`.

Description

In some previous versions of Simulink, opening a model that had been saved in an earlier version triggers an automatic upgrade to code for data type handling. The automatic upgrade inserts calls to the internal function `slDataTypeAndScale`. Although Simulink continues to support some uses of the function, if you eliminate calls to it, you get cleaner and faster code.

Simulink does not support calls to `slDataTypeAndScale` when:

- The first argument is a `Simulink.AliasType` object.
- The first argument is a `Simulink.NumericType` object with property `IsAlias` set to true.

Running **Check for calls to `slDataTypeAndScale`** identifies calls to `slDataTypeAndScale` that are required or recommended for replacement. In most cases, running the check and following the recommended action removes the calls. You can ignore calls that remain. Run the check unless you are sure there are not calls to `slDataTypeAndScale`.

Results and Recommended Actions

| Condition | Recommended Action |
|-------------------------------|---|
| Required Replacement Cases | Manually or automatically replace calls to <code>slDataTypeAndScale</code> . Cases listed require you to replace calls to <code>slDataTypeAndScale</code> . |
| Recommended Replacement Cases | For the listed cases, it is recommended that you manually or automatically replace calls to <code>slDataTypeAndScale</code> . |
| Manual Inspection Cases | Inspect each listed case to determine whether it should be manually upgraded. |

Capabilities and Limitations

If you have a Simulink Check license, you can exclude blocks and charts from this check.

Tips

- Do not manually insert a call to `slDataTypeAndScale` into a model. The function was for internal use only.
- Running **Check for calls to `slDataTypeAndScale`** calls the Simulink function `slRemoveDataTypeAndScale`. Calling this function directly provides a wider range of conversion options. However, you very rarely need more conversion options.

See Also

- For more information about upgrading data types and scales, in the MATLAB Command Window, execute the following:
 - `help slDataTypeAndScale`
 - `help slRemoveDataTypeAndScale`
- “Model Advisor Exclusion Overview” (Simulink Check)

Check bus signals treated as vectors

Check ID: `mathworks.design.BusTreatedAsVector`

Identify bus signals that Simulink treats as vectors.

Description

You cannot use bus signals that the Simulink software implicitly converts to vectors. Instead, either insert a Bus to Vector conversion block between the bus signal and the block input port that it feeds, or use the `Simulink.BlockDiagram.addBusToVector` command.

Results and Recommended Actions

| Condition | Recommended Action |
|--|--|
| Bus signals are implicitly converted to vectors. | Use <code>Simulink.BlockDiagram.addBusToVector</code> or insert a Bus to Vector block. |
| Model is not configured to identify bus signals that Simulink treats as vectors. | In the Configuration Parameters dialog box, on the Diagnostics > Connectivity pane, set Bus signal treated as vector to error . |

Action Results

Clicking **Modify** inserts a Bus to Vector block at the input ports of blocks that implicitly convert bus signals to vectors.

Tips

- Run this check before running **Check consistency of initialization parameters for Output and Merge blocks**.
- For more information, see “Identify Automatic Bus Conversions”.

See Also

- “Identify Automatic Bus Conversions”
- Bus to Vector block
- “Bus signal treated as vector”
- “Migrating to Simplified Initialization Mode Overview” on page 9-4
- `Simulink.BlockDiagram.addBusToVector`

Check for potentially delayed function-call subsystem return values

Check ID: `mathworks.design.DelayedFcnCallSubsys`

Identify function-call return values that might be delayed because Simulink software inserted an implicit Signal Conversion block.

Description

So that signals reside in contiguous memory, Simulink software can automatically insert an implicit Signal Conversion block in front of function-call initiator block input ports. This can result in a one-step delay in returning signal values from calling function-call subsystems. The delay can be avoided by ensuring the signal originates from a signal block within the function-call system. Or, if the delay is acceptable, insert a Unit Delay block in front of the affected input ports.

Results and Recommended Actions

| Condition | Recommended Action |
|--|--|
| The listed block input ports could have an implicit Signal Conversion block. | <p>Decide if a one-step delay in returning signal values is acceptable for the listed signals.</p> <ul style="list-style-type: none"> • If the delay is not acceptable, rework your model so that the input signal originates from within the calling subsystem. • If the delay is acceptable, insert a Unit Delay block in front of each listed input port. |

Capabilities and Limitations

If you have a Simulink Check license, you can exclude blocks and charts from this check.

See Also

Signal Conversion block

Unit Delay block

“Model Advisor Exclusion Overview” (Simulink Check)

Identify block output signals with continuous sample time and non-floating point data type

Check ID: `mathworks.design.OutputSignalSampleTime`

Find continuous sample time, non-floating-point output signals.

Description

Non-floating-point signals might not represent continuous variables without loss of information.

Results and Recommended Actions

| Condition | Recommended Action |
|---|---|
| Signals with continuous sample times have a non-floating-point data type. | On the identified signals, either change the sample time to be discrete or fixed-in-minor-step ([0 1]). |

Capabilities and Limitations

If you have a Simulink Check license, you can exclude blocks and charts from this check.

See Also

“What Is Sample Time?”.

“Model Advisor Exclusion Overview” (Simulink Check)

Check usage of Merge blocks

Check ID: `mathworks.design.MergeBlkUsage`

Identify Merge blocks with parameter settings that can lead to unexpected behavior, and help migrate your model to simplified initialization mode.

Note Run this check along with the other checks in the “Migrating to Simplified Initialization Mode Overview” on page 9-4.

Description

Simplified initialization mode was introduced in R2008b to improve the consistency of simulation results. For more information, see “Simplified Initialization Mode” and “Classic Initialization Mode”.

This Model Advisor check identifies settings in the Merge blocks in your model that can cause problems if you use classic initialization mode. It also recommends settings for consistent behavior of Merge blocks. The results of the subchecks contain two types of statements: Failed and Warning. Failed statements identify issues that you must address manually before you can migrate the model to the simplified initialization mode. Warning statements identify issues or changes in behavior that can occur after migration.

Results and Recommended Actions

| Condition | Recommended Action |
|--|--|
| Check the run-time diagnostic setting of the Merge block. | <ol style="list-style-type: none"> 1 In the Configuration Parameters dialog box, set “Detect multiple driving blocks executing at the same time step” to <code>error</code>. 2 Verify that the model simulates without errors before running this check again. |
| Check for Model blocks that are using the PIL simulation mode. | The simplified initialization mode does not support the Processor-in-the-loop (PIL) simulation for model references. |
| Check for library blocks with instances that cannot be migrated. | Examine the failed subcheck results for each block to determine the corrective actions. |
| Check for single-input Merge blocks. | <p>Replace both the Mux block used to produce the input signal and the Merge block with one multi-input Merge block.</p> <p>Single-input Merge blocks are not supported in the simplified initialization mode.</p> |

| Condition | Recommended Action |
|---|---|
| Check for root Merge blocks that have an unspecified Initial output value. | <p>If you do not specify an explicit value for the Initial output parameter of root Merge blocks, then Simulink uses the default initial value of the output data type.</p> <p>A root Merge block is a Merge block with an output port that does not connect to another Merge block. For information on the default initial value, see “Initialize Signal Values”.</p> |
| Check for Merge blocks with nonzero input port offsets. | <p>Clear the Allow unequal port widths parameter of the Merge block.</p> <hr/> <p>Note Consider using Merge blocks only for signal elements that require true merging. You can combine other elements with merged elements using the Concatenate block.</p> |
| Check for Merge blocks that have unconnected inputs or that have inputs from non-conditionally executed subsystems. | <p>Set the Number of inputs parameter of the Merge block to the number of Merge block inputs. You must connect each input to a signal.</p> <p>Verify that each Merge block input is driven by a conditionally executed subsystem. Merge blocks cannot be driven directly by an Iterator Subsystem or a block that is not a conditionally executed subsystem.</p> |
| Check for Merge blocks with inputs that are combined or reordered outside of conditionally executed subsystems. | <p>Verify that combinations or reordering of Merge block input signals takes place within a conditionally executed subsystem. Such designs may use Mux, Bus Creator, or Selector blocks.</p> |
| Check for Merge blocks with inconsistent input sample times. | <p>Verify that input signals to each Merge block have the same Sample time.</p> <p>Failure to do so could result in unpredictable behavior. Consequently, the simplified initialization mode does not allow inconsistent sample times.</p> |
| Check for Merge blocks with multiple input ports that are driven by a single source. | <p>Verify that the Merge block does not have multiple input signals that are driven by the same conditionally executed subsystem or conditionally executed Model block.</p> |

| Condition | Recommended Action |
|--|---|
| Check for Merge blocks that use signal objects to specify the Initial output value. | <p>Verify that the following behavior is acceptable.</p> <p>In the simplified initialization mode, signal objects cannot specify the Initial output parameter of the Merge block. While you can still initialize the output signal for a Merge block using a signal object, the initialization result may be overwritten by that of the Merge block.</p> <hr/> <p>Note Simulink generates a warning that the initial value of the signal object has been ignored.</p> |

See Also

- “Migrating to Simplified Initialization Mode Overview” on page 9-4
- “Model Advisor Exclusion Overview” (Simulink Check)

Check usage of Outport blocks

Check ID: `mathworks.design.InitParamOutportMergeBlk`

Identify Outport blocks and conditional subsystems with parameter settings that can lead to unexpected behavior, and help migrate your model to simplified initialization mode.

Note Run this check along with the other checks in the “Migrating to Simplified Initialization Mode Overview” on page 9-4.

Description

Simplified initialization mode was introduced in R2008b to improve the consistency of simulation results. This mode is especially important for models that do not specify initial conditions for conditionally executed subsystem output ports. For more information, see “Simplified Initialization Mode” and “Classic Initialization Mode”.

This Model Advisor check identifies Outport blocks and conditional subsystems in your model that can cause problems if you use the simplified initialization mode. It also recommends settings for consistent behavior of Outport blocks. The results of the subchecks contain two types of statements: Failed and Warning. Failed statements identify issues that you must address manually before you can migrate the model to the simplified initialization mode. Warning statements identify issues or changes in behavior that can occur after migration.

Results and Recommended Actions

| Condition | Recommended Action |
|--|--|
| Check for blocks inside of the Iterator Subsystem that require elapsed time. | <p>Within an Iterator Subsystem hierarchy, do not use blocks that require a service that maintains the time that has elapsed between two consecutive executions.</p> <p>Since an Iterator Subsystem can execute multiple times at a given time step, the concept of elapsed time is not well-defined between two such executions. Using these blocks inside of an Iterator Subsystem can cause unexpected behavior.</p> |
| Check for Outport blocks that have conflicting signal buffer requirements. | <p>The Outport block has a function-call trigger or function-call data dependency signal passing through it, along with standard data signals. Some of the standard data signals require an explicit signal buffer for the initialization of the output signal of the corresponding subsystem. However, buffering function-call related signals lead to a function-call data dependency violation.</p> <p>Consider modifying the model to pass function-call related signals through a separate Outport block. For examples of function-call data dependency violations, see the example model <code>sl_subsys_semantics</code>.</p> <p>A standard data signal may require an additional signal copy for one of the following reasons:</p> <ul style="list-style-type: none"> • The Outport block is driven by a block with output that cannot be overwritten. The Ground block and the Constant block are examples of such blocks. • The Outport block shares the same signal source with another Outport block in the same subsystem or in one nested within the current subsystem but having a different initial output value. • The Outport block connects to the input of a Merge block • One of the input signals of the Outport block is specifying a <code>Simulink.Signal</code> object with an explicit initial value. |

| Condition | Recommended Action |
|--|--|
| Check for Outport blocks that are driven by a bus signal and whose Initial output value is not scalar. | For Outport blocks driven by bus signals, classic initialization mode does not support Initial Condition (IC) structures, while simplified initialization mode does. Hence, when migrating a model from classic to simplified mode, specify a scalar for the Initial Output parameter. After migration completes, to specify different initial values for different elements of the bus signal, use IC structures. For more information, see "Create Initial Condition Structures". |
| Check for Outport blocks that require an explicit signal copy. | <p>An explicit copy of the bus signal driving the Outport block is required for the initialization of the output signal of the corresponding subsystem. Insert a Signal Conversion block before the Outport block, then set the Output parameter of the Signal Conversion block to Bus copy.</p> <p>A standard data signal may require an additional signal copy for one or more of the following reasons:</p> <ul style="list-style-type: none"> • A block with output that cannot be overwritten is driving the Outport block. The Ground block and the Constant block are examples of such blocks. • The Outport block shares the same signal source with another Outport block in the same subsystem or in one nested within the current subsystem but having a different initial output value. • The Outport block connects to the input of a Merge block • One of the input signals of the Outport block is specifying a <code>Simulink.Signal</code> object with an explicit initial value. |
| Check for merged Outport blocks that inherit the Initial Output value from Outport blocks that have been configured to reset when the blocks become disabled. | When Outport blocks are driving a Merge block, do not set their Output when disabled parameters to reset . |
| Check for merged Outport blocks that are driven by nested conditionally executed subsystems. | Determine if the new behavior of the Outport blocks is acceptable. If it is not acceptable, modify the model to account for the new behavior before migrating to the simplified initialization mode. |

| Condition | Recommended Action |
|--|---|
| Check for merged Outport blocks that reset when the blocks are disabled. | <p>Set the Output when disabled parameter of the Outport block to <code>held</code>. This setting is required because the Outport block connects to a Merge block.</p> <p>For more information, see Outport.</p> |
| Check for Outport blocks that have an undefined Initial output value with invalid initial condition sources. | <p>Verify that the following behavior is acceptable.</p> <p>When the Initial output parameter is unspecified (<code>[]</code>), it inherits the initial output from the source blocks. If at least one of the sources of the Outport block is not a valid source to inherit the initial value, the block uses the default initial value for that data type.</p> <p>For simplified initialization mode, valid sources an Outport blocks can inherit the Initial output value from are: Constant, Initial Condition, Merge (with initial output), Stateflow chart, function-call model reference, or conditionally executed subsystem blocks.</p> |
| Check Outport blocks that have automatic rate transitions. | <p>Simulink has inserted a Rate Transition block at the input of the Outport block. Specify the Initial output parameter for each Outport block.</p> <p>Otherwise, perform the following procedure:</p> <ol style="list-style-type: none"> 1 In the Configuration Parameters dialog box, on the Solver pane, clear the option “Automatically handle rate transition for data transfer”. 2 Run this Model Advisor check again. |
| Check Outport blocks that have a special signal storage requirement and have an undefined Initial output value. | <p>Verify that the following behavior is acceptable.</p> <p>Specify the Initial output parameter for the Outport block. Set this value to <code>[]</code> (empty matrix) to use the default initial value of the output data type.</p> |
| Check the Initial output setting of Outport blocks that reset when they are disabled. | <p>Specify the Initial output parameter of the Outport block.</p> <p>You must specify the Initial output value for blocks that are configured to reset when they become disabled.</p> |

| Condition | Recommended Action |
|--|--|
| Check the Initial output setting for Outport blocks that pass through a function-call data dependency signal. | <p>You cannot specify an Initial output value for the Outport block because function-call data dependency signals are passing through it. To set the Initial output value:</p> <ol style="list-style-type: none"> 1 Set the Initial output parameter of the Outport block to []. 2 Provide the initial value at the source of the data dependency signal rather than at the Outport block. |
| Check for Outport blocks that use signal objects to specify the Initial output value. | <p>Verify that the following behavior is acceptable.</p> <p>In the simplified initialization mode, signal objects cannot specify the Initial output parameter of an Outport block. You can still initialize the input or output signals for an Outport block using signal objects, but the initialization results may be overwritten by those of the Outport block.</p> <p>Note If you are working with a conditionally executed subsystem Outport block, Simulink generates a warning that the initial value of the signal object has been ignored.</p> |
| Check for library blocks with instances that have warnings. | Examine the warning subcheck results for each block before migrating to the simplified initialization mode. |
| Check for merged Outport blocks that are either unconnected or connected to a Ground block. | <p>Verify that the following behavior is acceptable.</p> <p>The Outport block is driving a Merge block, but its inputs are either unconnected or connected to Ground blocks. In the classic initialization mode, unconnected or grounded outputs do not update the merge signal even when their parent conditionally executed subsystems are executing. In the simplified initialization mode, however, these outputs will update the merge signal with a value of zero when their parent conditionally executed subsystems are executing.</p> |

| Condition | Recommended Action |
|--|---|
| <p>Check for Outport blocks that obtain the Initial output value from an input signal when they are migrated.</p> | <p>Verify that the following behavior is acceptable.</p> <p>The Initial output parameter of the Outport block is not specified. As a result, the simplified initialization mode will assume that the Initial output value for the Outport block is derived from the input signal. This assumption may result in different initialization behavior.</p> <p>If this behavior is not acceptable, modify your model before you migrate to the simplified initialization mode.</p> |
| <p>Check for outer Outport blocks that have an explicit Initial output.</p> | <p>Verify that the following behavior is acceptable.</p> <p>In classic initialization mode, the Initial output and Output when disabled parameters of the Outport block must match those of their source Outport blocks.</p> <p>In simplified initialization mode, Simulink sets the Initial output parameter of outer Outport blocks to [] (empty matrix) and Output when disabled parameter to held.</p> |
| <p>Check for blocks that read input from conditionally executed subsystems during initialization.</p> | <p>Verify that the following behavior is acceptable.</p> <p>Some blocks, such as the Discrete-Time Integrator block, read their inputs from conditionally executed subsystems during initialization in the classic initialization mode. Simulink performs this step as an optimization technique.</p> <p>This optimization is not allowed in the simplified initialization mode because the output of a conditionally executed subsystem at the first time step after initialization may be different than the initial value declared in the corresponding Outport block. In particular, this discrepancy occurs if the subsystem is active at the first time step.</p> |

| Condition | Recommended Action |
|--|---|
| <p>Check for a migration conflict for Outport blocks that use a Dialog as the Source of initial output value.</p> | <p>Other instances of Outport blocks with the same library link either cannot be migrated or are being migrated in a different manner. Review the results from the Check for library blocks with instances that cannot be migrated to learn about the different migration paths for other instances of each Outport block.</p> <p>The Outport block will maintain its current settings and use its specified Initial output value.</p> |
| <p>Check for a migration conflict for Outport blocks that use Input signal as the Source of initial output value.</p> | <p>Other instances of Outport blocks with the same library link either cannot be migrated or are being migrated in a different manner. Review the results from the Check for library blocks with instances that cannot be migrated to learn about the different migration paths for other instances of each Outport block.</p> <p>The Outport block currently specifies an Initial output of [] (empty matrix), and the Output when disabled as held. This means that each output does not perform initialization, but implicitly relies on source blocks to initialize its input signal.</p> <p>After migration, the parameter Source of initial output value will be set to Input signal to reflect this behavior.</p> |
| <p>Check for a migration conflict for Outport blocks that have SimEvents semantics.</p> | <p>Other instances of Outport blocks with the same library link either cannot be migrated or are being migrated in a different manner. Review the results from the Check for library blocks with instances that cannot be migrated to learn about the different migration paths for other instances of each Outport block.</p> <p>The Outport blocks will continue to use an Initial output value of [] (empty matrix) and an Output when disabled setting of held. Simulink will maintain these settings because their parent conditionally executed subsystems are connected to SimEvents blocks.</p> |

| Condition | Recommended Action |
|--|--|
| Check for a migration conflict for innermost Outport blocks with variable-size input and unspecified Initial output . | <p>For these Outport blocks, the signal size varies only when the parent subsystem of the block is re-enabled. Therefore, Simulink implicitly assumes that the Initial output parameter is equal to 0, even though the parameter is unspecified, []. Consequently, unless you specify the parameter, the Model Advisor will explicitly set the parameter to 0 when the model is migrated to the simplified initialization mode.</p> <p>Other instances of Outport blocks with the same library link either cannot be migrated or are being migrated in a different manner. Review the results from the Check for library blocks with instances that cannot be migrated to learn about the different migration paths for other instances of each Outport block.</p> |
| Check for a migration conflict for Outport blocks that use a default ground value as the Initial output. | The parameter Initial output is set to [] (empty matrix) and the source of the Outport is an invalid initial condition source. Thus, the block uses the default initial value as the initial output in the simplified initialization mode. Other instances of Outport blocks with the same library link either have errors or are being migrated differently. |
| Check for a migration conflict for merged Outport blocks without explicit specification of Initial output . | Review the results from the subcheck Check for library blocks with instances that cannot be migrated to learn about different migration paths for other instances of each Outport block. For the remaining Outport blocks, Initial output is set to [] (empty matrix) and Output when disabled is set to held respectively, in simplified initialization mode. |

See Also

- “Migrating to Simplified Initialization Mode Overview” on page 9-4
- “Model Advisor Exclusion Overview” (Simulink Check)

Check usage of Discrete-Time Integrator blocks

Check ID: mathworks.design.DiscreteBlock

Identify Discrete-Time Integrator blocks with parameter settings that can lead to unexpected behavior, and help migrate your model to simplified initialization mode.

Note Run this check along with the other checks in the “Migrating to Simplified Initialization Mode Overview” on page 9-4.

Description

Simplified initialization mode was introduced in R2008b to improve the consistency of simulation results. For more information, see “Simplified Initialization Mode” and “Classic Initialization Mode”.

This Model Advisor check identifies settings in Discrete-Time Integrator blocks in your model that can cause problems if you use the simplified initialization mode. It also recommends settings for consistent behavior of Discrete-Time Integrator blocks. The results of the subchecks contain two types of statements: Failed and Warning. Failed statements identify issues that you must address manually before you can migrate the model to the simplified initialization mode. Warning statements identify issues or changes in behavior that can occur after migration.

Results and Recommended Actions

| Condition | Recommended Action |
|---|---|
| Check for Discrete-Time Integrator blocks whose parameter Initial condition setting is set to Output. | Determine if the new behavior of the Discrete-Time Integrator blocks is acceptable. If it is not acceptable, modify the model to account for the new behavior before migrating to the simplified initialization mode. |
| Check for Discrete-Time Integrator blocks whose Initial condition setting parameter is set to State (most efficient) and are in a subsystem that uses triggered sample time. | Use periodic sample time for the block, or set Initial Condition setting to Output. |
| Check for blocks inside of the Iterator Subsystem that require elapsed time. | <p>Within an Iterator Subsystem hierarchy, do not use blocks that require a service that maintains the time that has elapsed between two consecutive executions.</p> <p>Since an Iterator Subsystem can execute multiple times at a given time step, the concept of elapsed time is not well-defined between two such executions. Using these blocks inside of an Iterator Subsystem can cause unexpected behavior.</p> |

See Also

- “Migrating to Simplified Initialization Mode Overview” on page 9-4
- “Model Advisor Exclusion Overview” (Simulink Check)

Check model settings for migration to simplified initialization mode

Note Do not run this check in isolation. Run this check along with the other checks in the “Migrating to Simplified Initialization Mode Overview” on page 9-4.

Check ID: `mathworks.design.ModelLevelMessages`

Identify settings in Model blocks and model configuration parameters that can lead to unexpected behavior, and help migrate your model to simplified initialization mode.

Description

Simplified initialization mode was introduced in R2008b to improve consistency of simulation results. For more information, see “Simplified Initialization Mode” and “Classic Initialization Mode”.

This Model Advisor check identifies issues in the model configuration parameters and Model blocks in your model that can cause problems when you migrate to simplified initialization mode. The results of the subchecks contain two types of statements: Failed and Warning. Failed statements identify issues that you must address manually before you can migrate the model to simplified initialization mode. Warning statements identify issues or changes in behavior that can occur after migration.

After running this Model Advisor consistency check, if you click **Explore Result** button, the messages pertain only to blocks that are not library-links.

Note Because it is difficult to undo these changes, select **File > Save Restore Point As** to back up your model before migrating to the simplified initialization mode.

For more information, see “Model Configuration Parameters: Connectivity Diagnostics”.

Results and Recommended Actions

| Condition | Recommended Action |
|--|--|
| Verify that all Model blocks are using the simplified initialization mode. | Migrate the model referenced by the Model block to the simplified initialization mode, then migrate the top model. |
| Verify simplified initialization mode setting | Set Configuration Parameters > Underspecified initialization detection to Simplified . |

Action Results

Clicking **Modify Settings** causes the following:

- The Model parameter is set to **simplified**
- If an Output block has the **Initial output** parameter set to the empty character vector, [], then the **SourceOfInitialOutputValue** parameter is set to **Input signal**.
- If an Outputport has an empty **Initial output** and a variable-size signal, then the **Initial output** is set to zero.

See Also

- “Migrating to Simplified Initialization Mode Overview” on page 9-4
- “Model Advisor Exclusion Overview” (Simulink Check)

Check S-functions in the model

Check ID: mathworks.design.SFuncAnalyzer

Perform quality checks on S-functions in Simulink models or subsystems.

Description

The S-function analyzer performs quality checks on S-functions to identify improvements and potential problems in the specified model.

Results and Recommended Actions

| Condition | Recommended Action |
|---|--|
| Continuous states are modified in <code>mdlOutputs</code> method. | Modify Continuous States at a major time step and use <code>ssSetSolverNeedsReset</code> function in S-function code. |
| Continuous states are modified in the <code>mdlUpdate</code> method. | Modify Continuous States only at a major time step and use <code>ssSetSolverNeedsReset</code> function in S-function code. |
| S-function discrete states are modified in the <code>mdlOutputs</code> at a minor step. | Modify the discrete states only at a major step guarded by <code>ssIsMajorTimeStep</code> function. |
| S-function mode vector is modified in the <code>mdlOutputs</code> method at a minor step. | Modify the mode vector only at a major step guarded by <code>ssIsMajorTimeStep</code> function. |
| S-function is using static or global variables to declare internal states. | Declare the states explicitly using <code>ssSetNumDiscStates</code> function or "Model Global Data by Creating Data Stores". |
| S-function has continuous states but sample time is not declared continuous. | Specify continuous sample time using <code>ssSetSampleTime</code> function. |
| S-function has discrete states but the <code>mdlOutputs</code> and <code>mdlUpdate</code> methods are combined. | Define the <code>mdlOutputs</code> and <code>mdlUpdate</code> methods separately and modify discrete states only in <code>mdlUpdate</code> method. |
| S-function sets the <code>SS_OPTION_CAN_BE_CALLED_CONDITIONALLY</code> option when having state-like data or multiple sample times. | Remove the options when the S-function has state-like data or multiple sample times. |
| MEX compilers do not exist on the machine. | Check for the presence or install MEX compilers on the machine. |
| S-function encounters errors while compiling the model. | Check the Diagnostic Viewer output and recompile the model. |

Check for non-continuous signals driving derivative ports

Check ID: `mathworks.design.NonContSigDerivPort`

Identify noncontinuous signals that drive derivative ports.

Description

Noncontinuous signals that drive derivative ports cause the solver to reset every time the signal changes value, which slows down simulation.

Results and Recommended Actions

| Condition | Recommended Action |
|--|---|
| There are noncontinuous signals in the model driving derivative ports. | <ul style="list-style-type: none"> • Make the specified signals continuous. • Replace the continuous blocks receiving these signals with discrete state versions of the blocks. |

Capabilities and Limitations

If you have a Simulink Check license, you can exclude blocks and charts from this check.

See Also

- “Simulink Models” on page 11-6
- “Simulation Phases in Dynamic Systems”
- “Model Advisor Exclusion Overview” (Simulink Check)

Runtime diagnostics for S-functions

Check ID: `mathworks.design.DiagnosticSFcn`

Check array bounds and solver consistency if S-Function blocks are in the model.

Description

Validates whether S-Function blocks adhere to the ODE solver consistency rules that Simulink applies to its built-in blocks.

Results and Recommended Actions

| Condition | Recommended Action |
|--|---|
| Solver data inconsistency is set to none. | In the Configuration Parameters dialog box, set Solver data inconsistency to warning or error. |
| Array bounds exceeded is set to none. | In the Configuration Parameters dialog box, set Array bounds exceeded to warning or error |

Capabilities and Limitations

If you have a Simulink Check license, you can exclude blocks and charts from this check.

See Also

- “What Is an S-Function?”
- “How S-Functions Work”
- “Model Advisor Exclusion Overview” (Simulink Check)

Identify unit mismatches in the model

Check ID: `mathworks.design.UnitMismatches`

Identify instances of unit mismatches between ports in the model.

Description

Check for instances of unit mismatches between ports in the model.

Results and Recommended Actions

| Condition | Recommended Action |
|-----------------------|---|
| Unit mismatches found | Change one of the mismatched unit settings to match the unit settings for the other port. |

See Also

- “Unit Specification in Simulink Models”.

Identify automatic unit conversions in the model

Check ID: `mathworks.design.AutoUnitConversions`

Identify instances of automatic unit conversions in the model.

Description

Identify instances of automatic unit conversions in the model.

Results and Recommended Actions

| Condition | Recommended Action |
|----------------------------------|--|
| Automatic unit conversions found | Check that the converted units are expected for the model. |

See Also

- “Unit Specification in Simulink Models”.

Identify disallowed unit systems in the model

Check ID: `mathworks.design.DisallowedUnitSystems`

Identify instances of disallowed unit systems in the model.

Description

Identify instances of disallowed unit systems in the model.

Results and Recommended Actions

| Condition | Recommended Action |
|-------------------------------|--|
| Disallowed unit systems found | Either choose a unit that conforms to the configured unit system, or select another unit system. For more information, see “Restricting Unit Systems”. |

See Also

- “Unit Specification in Simulink Models”.

Identify undefined units in the model

Check ID: `mathworks.design.UndefinedUnits`

Identify instances of unit specifications, not defined in the unit database, in the model.

Description

Identify instances of unit specifications, not defined in the unit database, in the model.

Results and Recommended Actions

| Condition | Recommended Action |
|-----------------------|--|
| Undefined units found | Change the unit to one that Simulink supports. |

See Also

- “Unit Specification in Simulink Models”.
- Allowed Units

Identify ambiguous units in the model

Check ID: `mathworks.design.AmbiguousUnits`

Identify instances of ambiguous unit specifications, such as duplicate unit names in the unit database, in the model.

Description

Identify instances of ambiguous unit specifications, such as duplicate unit names in the unit database, in the model.

Results and Recommended Actions

| Condition | Recommended Action |
|-----------------------|--|
| Ambiguous units found | You can ignore the warning or specify the unit with corresponding unit system using the format <code>unit_system::unit_name</code> . |

See Also

- “Unit Specification in Simulink Models”.
- Allowed Units

Check model for block upgrade issues

Check ID: `mathworks.design.Update`

Check for common block upgrade issues.

Description

Check blocks in the model for compatibility issues resulting from using a new version of Simulink software.

Results and Recommended Actions

| Condition | Recommended Action |
|--|---|
| Blocks with compatibility issues found. | Click Modify to fix the detected block issues. |
| Check update status for the Level 2 API S-functions. | Consider replacing Level 1 S-functions with Level 2. |

Action Results

Clicking **Modify** replaces blocks from a previous release of Simulink software with the latest versions.

See Also

- “Write Level-2 MATLAB S-Functions”.
- “Consult the Upgrade Advisor”.
- “Model Upgrades”

Check model for block upgrade issues requiring compile time information

Check ID: `mathworks.design.UpdateRequireCompile`

Check for common block upgrade issues.

Description

Check blocks for compatibility issues resulting from upgrading to a new version of Simulink software. Some block upgrades require the collection of information or data when the model is in the compile mode. For this check, the model is set to compiled mode and then checked for upgrades.

Results and Recommended Actions

| Condition | Recommended Action |
|--|---|
| Model contains Lookup Table or Lookup Table (2-D) blocks and some of the blocks specify Use Input Nearest or Use Input Above for a lookup method. | Replace Lookup Table blocks and Lookup Table (2-D) blocks with n-D Lookup Table blocks. Do not apply Use Input Nearest or Use Input Above for lookup methods; select another option. |
| Model contains Lookup Table or Lookup Table (2-D) blocks and some blocks perform multiplication first during interpolation. | Replace Lookup Table blocks and Lookup Table (2-D) blocks with n-D Lookup Table blocks. However, because the n-D Lookup Table block performs division first, this replacement might cause a numerical difference in the result. |
| Model contains Lookup Table or Lookup Table (2-D) blocks. Some of these blocks specify Interpolation-Extrapolation as the Lookup method but their input and output are not the same floating-point type. | Replace Lookup Table blocks and Lookup Table (2-D) blocks with n-D Lookup Table blocks. Then change the extrapolation method or the port data types for block replacement. |
| Model contains Unit Delay blocks with Sample time set to -1 that inherit a continuous sample time. | Replace Unit Delay blocks with Memory blocks. |

Check Data Store Memory blocks for multitasking

Action Results

Clicking **Modify** replaces blocks from a previous release of Simulink software with the latest versions.

See Also

- n-D Lookup Table
- Unit Delay
- “Consult the Upgrade Advisor”
- “Model Upgrades”

Check if SLX file compression is off

Check ID: `mathworks.design.CheckSLXFileCompressionLevel`

Check if SLX file compression is turned off to reduce Git™ repository size.

Description

Check whether compression for the SLX model is turned off.

Results and Recommended Actions

| Condition | Recommended Action |
|---|---|
| Model, library, or subsystem is saved in SLX format. File compression is turned on. | Consider turning off file compression to optimize storage under source control. |

Capabilities and Limitations

You can run this check on models, libraries, and subsystems checked in to Git source control.

See Also

- “Consult the Upgrade Advisor”.
- “Model Upgrades”

Check that the model or library is saved in current version

Check ID: `mathworks.design.CheckSavedInCurrentVersion`

Check that the model, library, or subsystem is saved in the current version of Simulink.

Description

Check whether the model file is saved in the current Simulink release.

Results and Recommended Actions

| Condition | Recommended Action |
|--|--|
| Model, library, or subsystem not saved in the current version of Simulink. | Consider resaving the model file in the current version of Simulink. |

Capabilities and Limitations

You can run this check on your models, libraries, and subsystems.

Tips

Projects can help you save all the models and libraries in your project to the current Simulink release. See “Upgrade All Project Models, Libraries, and MATLAB Code Files”.

See Also

- “Consult the Upgrade Advisor”.
- “Model Upgrades”
- “Upgrade All Project Models, Libraries, and MATLAB Code Files”

Check model for SB2SL blocks

Check ID: `mathworks.simulink.SB2SL.Check`

Check that the model does not have outdated SB2SL blocks.

Description

Check if the model contains outdated SB2SL blocks.

Results and Recommended Actions

| Condition | Recommended Action |
|--------------------------------------|---|
| Model contains outdated SB2SL blocks | Consider upgrading the model to current SB2SL blocks. |

Action Results

Clicking **Update SB2SL Blocks** replaces blocks with the latest versions.

See Also

- “Consult the Upgrade Advisor”.

Check Model History properties

Check ID: mathworks.design.SLXModelProperties

Check for edited model history properties

Description

Check models for edited Model History property values that could be used with source control tool keyword substitution. This keyword substitution is incompatible with SLX file format.

In the MDL file format you can configure some model properties to make use of source control tool keyword substitution. If you save your model in SLX format, source control tools cannot perform keyword substitution. Information in the model file from such keyword substitution is cached when you first save the MDL file as SLX, and is not updated again. The Model Properties History pane and Model Info blocks in your model show stale information from then on.

Results and Recommended Actions

| Condition | Recommended Action |
|---------------------------------|---|
| Edited model history properties | Manually or automatically reset the properties to the default values. Click the button to reset, or to inspect and change these properties manually, open the Model Properties dialog and look in the History pane. |

Capabilities and Limitations

You can run this check on your library models.

See Also

- “Consult the Upgrade Advisor”.
- “Model Upgrades”

Identify Model Info blocks that can interact with external source control tools

Check ID: `mathworks.design.ModelInfoKeywordSubstitution`

Use this check to find Model Info blocks that can be altered by external source control tools through keyword substitution.

Description

This check searches for character vectors in the Model Info block enclosed within dollar signs that can be overwritten by an external source control tool. Using third-party source control tool keyword expansion might corrupt your model files when you submit them. Keyword substitution is not available in SLX model file format.

For a more flexible interface to source control tools, use a Simulink project instead of the Model Info block. See “About Source Control with Projects”.

Results and Recommended Actions

| Condition | Recommended Action |
|--|---|
| The Model Info block contains fields like this: <code>\$keyword\$</code> | Review the list of fields in the report, then remove the keyword character vectors from the Model Info block. |

See Also

- “Consult the Upgrade Advisor”.
- “About Source Control with Projects”

Identify Model Info blocks that use the Configuration Manager

Check ID: `mathworks.design.ModelInfoConfigurationManager`

Use this check to find Model Info blocks that use the Configuration Manager.

Description

Model Info blocks using the Configuration Manager allow risky keyword substitution using external source control tools. Using third-party source control tool keyword expansion might corrupt your model files when you submit them. Keyword substitution is not available in SLX model file format. The Configuration Manager for the Model Info block will be removed in a future release.

For a more flexible interface to source control tools, use a Simulink project instead of the Model Info block. See “About Source Control with Projects”.

Results and Recommended Actions

| Condition | Recommended Action |
|--|---|
| A Model Info block is using the Configuration Manager. | Click Remove the Configuration Manager . |

See Also

- “Consult the Upgrade Advisor”.
- “About Source Control with Projects”

Check model for upgradable SerDes Toolbox blocks

Check ID: `mathworks.design.serdesUpgrades`

Lists blocks saved in a previous version of SerDes Toolbox™ that are outdated.

Description

This check searches for and lists SerDes Toolbox blocks that can be upgraded for compatibility with the current release.

Results and Recommended Actions

| Condition | Recommended Action |
|---|--|
| Blocks saved in older versions of SerDes Toolbox are found. | Click Upgrade SerDes Toolbox Blocks to upgrade the SerDes Toolbox blocks to be compatible with the current release. |

Action Results

Clicking **Upgrade SerDes Toolbox Blocks** upgrades the outdated SerDes Toolbox blocks to be compatible with the current release.

See Also

- “Design and Simulate SerDes Systems” (SerDes Toolbox)

Check model for legacy 3DoF or 6DoF blocks

Check ID: `mathworks.design.Aeroblks.CheckD0F`

Lists 3DoF and 6DoF blocks are outdated.

Description

This check searches for 3DoF and 6DoF blocks from library versions prior to 3.13 (R2014a).

Results and Recommended Actions

| Condition | Recommended Action |
|---|---|
| Blocks configured with old versions of 3DoF or 6DoF blocks found. | Click Replace 3DoF and 6DoF Blocks to replace the blocks with latest versions. |

Action Results

Clicking **Replace 3DoF and 6DoF Blocks** replaces blocks with the latest versions.

See Also

- “Equations of Motion” (Aerospace Blockset)

Check model for Aerospace Blockset navigation blocks

Check ID: `mathworks.design.Aeroblks.CheckNAV`

Searches for Three-Axis Inertial Measurement Unit, Three-Axis Gyroscope, and Three-Axis Accelerometer blocks prior to 3.21 (R2018a).

Description

This check searches for Three-Axis Inertial Measurement Unit, Three-Axis Gyroscope, and Three-Axis Accelerometer blocks that have been updated in R2018a.

Results and Recommended Actions

| Condition | Recommended Action |
|--|--|
| Three-Axis Inertial Measurement Unit, Three-Axis Gyroscope, and Three-Axis Accelerometer blocks prior to R2018a. | In R2018a or later, if you did not previously solve for steady state conditions, save the model now. If you previously solved for steady state conditions for the model, solve for these steady state conditions again, and then save the model. |

See Also

- Three-axis Accelerometer
- Three-axis Gyroscope
- Three-axis Inertial Measurement Unit

Check and update masked blocks in library to use promoted parameters

Check ID: `mathworks.design.CheckAndUpdateOldMaskedBuiltinBlocks`

Check for libraries that should be updated to use promoted parameters.

Description

This check searches libraries created before R2011b for masked blocks that should be updated to use promoted parameters. Since R2011b, if a block parameter is not promoted, its value in the linked

block is locked to its value in the library block. This check excludes blocks of type Subsystem, Model reference, S-Function and M-S-Function.

Results and Recommended Actions

| Condition | Recommended Action |
|---|---|
| Libraries that need to be updated are found | Click Update . Once the libraries have been updated, run the check again |

Capabilities and Limitations

You can:

- Run this check on your library models.
- Exclude blocks and charts from this check if you have a Simulink Check license.

See Also

- “Consult the Upgrade Advisor”.
- “Model Upgrades”
- “Model Advisor Exclusion Overview” (Simulink Check)

Check and update mask image display commands with unnecessary imread() function calls

Check ID: `mathworks.design.CheckMaskDisplayImageFormat`

Check identifies masks using image display commands with unnecessary calls to the `imread()` function.

Description

This check searches for the mask display commands that make unnecessary calls to the `imread()` function, and updates them with mask display commands that do not call the `imread()` function. Since 2013a, a performance and memory optimization is available for mask images specified using the image path instead of the RGB triple matrix.

Results and Recommended Actions

| Condition | Recommended Action |
|--|---|
| Mask display commands that make unnecessary calls to the <code>imread()</code> function are found. | Click Update . Once the blocks have been updated, run the check again. |

Capabilities and Limitations

You can:

- Run this check on your library models.
- Exclude blocks and charts from this check if you have a Simulink Check license.

See Also

- “Consult the Upgrade Advisor”.
- “Model Upgrades”
- “Model Advisor Exclusion Overview” (Simulink Check)

Check and update mask to affirm icon drawing commands dependency on mask workspace

Check ID: `mathworks.design.CheckMaskRunInitFlag`

Check identifies if the mask icon drawing commands have dependency on the mask workspace.

Description

This check identifies if the mask icon drawing commands have dependency on the mask workspace and updates the `RunInitForIconRedraw` property accordingly. If there is no mask workspace dependency, the value of `RunInitForIconRedraw` is set to `off`, whereas, if there is mask workspace dependency the values is set to `on`.

Setting the values of `RunInitForIconRedraw` to `off` when there is no mask workspace dependency optimizes the performance by not executing the mask initialization code before drawing the block icon.

Results and Recommended Actions

| Condition | Recommended Action |
|--|---|
| Mask drawing commands that are dependent or independent of the mask workspace are found. | Click Update . Once the blocks have been updated, run the check again. |

Capabilities and Limitations

You can:

- Run this check on your library models.
- Exclude blocks and charts from this check if you have a Simulink Check license.

See Also

- “Consult the Upgrade Advisor”.
- “Model Upgrades”
- “Model Advisor Exclusion Overview” (Simulink Check)

Identify masked blocks that specify tabs in mask dialog using MaskTabNames parameter

Check ID: `mathworks.design.CheckAndUpdateOldMaskTabnames`

This check identifies masked blocks that specify tabs in mask dialog using the `MaskTabNames` parameter.

Description

This check identifies masked blocks that use the `MaskTabNames` parameter to programmatically create tabs in the mask dialog. Since R2013b, dialog controls are used to group parameters in a tab on the mask dialog.

Results and Recommended Actions

| Condition | Recommended Action |
|--|--|
| Masked blocks that use the <code>MaskTabNames</code> parameter to create tabs programmatically in the mask dialog are found. | Click Upgrade available in the Action section. Once the blocks have been updated, run the check again. |

Capabilities and Limitations

You can run this check on your library models.

See Also

- “Consult the Upgrade Advisor”.
- “Model Upgrades”

Identify questionable operations for strict single-precision design

Check ID: `mathworks.design.StowawayDoubles`

For a strict single-precision design, this check identifies the blocks that introduce double-precision operations, and non-optimal model settings.

Description

For a strict single-precision design, this check identifies the blocks that introduce double-precision operations, and non-optimal model settings.

Results and Recommended Actions

| Condition | Recommended Action |
|--|---|
| Double-precision floating-point operations found in model. | Verify that: <ul style="list-style-type: none"> • Block input and output data types are set correctly. • In the Configuration Parameters dialog box, Default for underspecified data type is set to <code>single</code>. |

| Condition | Recommended Action |
|--|--|
| Model uses a library standard that is not optimal for strict-single designs. | Verify that: <ul style="list-style-type: none"> All target-specific math libraries used by the model support single-precision implementations. Set Configuration Parameters > Language standard to C99 (ISO). |
| Logic signals are not implemented as Boolean data. | Verify that: <ul style="list-style-type: none"> In the Configuration Parameters dialog box, Implement logic signals as Boolean data is selected. |

Capabilities and Limitations

If you have a Simulink Check license, you can exclude blocks and charts from this check.

See Also

- “Validate a Floating-Point Embedded Model”
- “Consult the Upgrade Advisor”.
- “Model Upgrades”
- “Model Advisor Exclusion Overview” (Simulink Check)

Check `get_param` calls for block `CompiledSampleTime`

Check ID: `mathworks.design.CallsGetParamCompiledSampleTime`

Use this check to identify MATLAB files in your working environment that contain `get_param` function calls to return the block `CompiledSampleTime` parameter.

Description

For multi-rate blocks (including subsystems), Simulink returns the block compiled sample time as a cell array of the sample rates in the block. The return value is a cell array of pairs of doubles. MATLAB code that accepts this return value only as pairs of doubles can return an error when called with a multi-rate block. Use this check to identify such code in your environment. Modify these instances of code to accept a cell array of pairs of doubles instead.

For example, consider a variable `blkTs`, which has been assigned the compiled sample time of a multi-rate block.

```
blkTs = get_param(block, 'CompiledSampleTime');
```

Here are some examples in which the original code works only if `blkTs` is a pair of doubles and the block is a single-rate block:

- Example 1

```
if isinf(blkTs(1))
    disp('found constant sample time')
end
```

Since blkTs is now a cell array, Simulink gives this error message:

Undefined function 'isinf' for input arguments of type 'cell'

Instead, use this code, for which blkTs can be a cell array or a pair of doubles.

```
if isequal(blkTs, [inf,0])
    disp('found constant sample time')
end
```

- Example 2

```
if all(blkTs == [-1,-1])
    disp('found triggered sample time')
end
```

For the above example, since blkTs is now a cell array, Simulink gives this error:

Undefined function 'eq' for input arguments of type 'cell'

Instead, use this code, for which blkTs can be a cell array or a pair of doubles.

```
if isequal(blkTs, [-1,-1])
    disp('found triggered sample time')
end
```

- Example 3

```
if (blkTs(1) == -1)
    disp('found a triggered context')
end
```

Again, since blkTs is now a cell array, Simulink gives this error:

Undefined function 'eq' for input arguments of type 'cell'

Instead, use this code.

```
if ~iscell(blkTs)
    blkTs = {blkTs};
end
for idx = 1:length(blkTs)
    thisTs = blkTs{idx};
    if (thisTs(1) == -1)
        disp('found a triggered context')
    end
end
```

The above code checks for a triggered type sample time (triggered or async). In cases in which a block has constant sample time ([inf,0]) in addition to triggered or async or when a block has multiple async rates, this alternative property detects the triggered type sample time.

This check scans MATLAB files in your environment. If the check finds instances of MATLAB code that contain `get_param` calls to output the block compiled sample time, Upgrade Advisor displays these results. It suggests that you modify code that accepts the block compiled sample time from multi-rate blocks.

Results and Recommended Actions

| Condition | Recommended Action |
|---|---|
| No MATLAB files call <code>get_param(block,CompiledSampleTime)</code> | None |
| Some MATLAB files call <code>get_param(block,CompiledSampleTime)</code> | If files use the block <code>CompiledSampleTime</code> parameter from multi-rate blocks, modify these files to accept the parameter as a cell array of pairs of doubles |

See Also

- “Sample Times in Subsystems”
- “Block Compiled Sample Time”

Check if all simulation outputs are returned as a single `Simulink.SimulationOutput` object

Check ID: `mathworks.design.CheckSingleSimulationOutput`

Use this check to identify if the simulation result is returned as a single `Simulink.SimulationOutput` object.

Description

This check scans your model to verify if the parameter `ReturnWorkspaceOutputs` is enabled. Enabling this parameter, returns simulation outputs in a `Simulink.SimulationOutput` when simulating interactively. Simulation outputs include signal, state, output, DSM logging, and scope and To Workspace block logging.

When `ReturnWorkspaceOutputs` is enabled, it provides:

- Easier management of simulation data.
- Automatic access to `SimulationMetadata`.
- Compatibility with multiple parallel simulations and batch simulations.

Results and Recommended Actions

| Condition | Recommended Action |
|---|---|
| Simulation outputs are not returned as a single <code>Simulink.SimulationOutput</code> object | Return all simulation outputs as a single <code>Simulink.SimulationOutput</code> object |

See Also

- “Single simulation output”
- `Simulink.SimulationOutput`

Check model for parameter initialization and tuning issues

Check ID: `mathworks.design.ParameterTuning`

Use this check to identify issues in the model that occur when you initialize parameters or tune them.

Description

This check scans your model for parameter initialization and tuning issues like:

- Rate mismatch between blocks
- Divide by zero issue in conditionally executed subsystems
- Invalid control port value in Index Vector blocks

Results and Recommended Actions

| Condition | Recommended Action |
|---|---|
| The model has rate transition issues. | Select Automatically handle rate transition for data transfer in the Solver pane of the model configuration parameters. |
| The model has a divide by zero issue in a conditionally executed subsystem with a control port. | At the command prompt, run <code>set_param(control_port, 'DisallowConstTsAndPrmTs', 'on')</code> |
| The model has an invalid control port value in a conditionally executed subsystem. | At the command prompt, run <code>set_param(control_port, 'DisallowConstTsAndPrmTs', 'on')</code> |

Action Results

Select **Upgrade model** to resolve issues in the model related to parameter initialization and tuning.

See Also

- “Automatic Rate Transition”

Check for virtual bus across model reference boundaries

Check ID: `mathworks.design.CheckVirtualBusAcrossModelReference`

Check virtual bus signals that cross model reference boundaries.

Description

This check identifies root-level Inport and Outport blocks in referenced models and Model blocks with virtual bus outputs that require updates to change to nonvirtual bus signals.

If the check identifies issues, click **Update Model** to convert root-level Inport and Outport blocks configured for virtual buses to use nonvirtual buses in these situations:

- For root-level Inport blocks — Enable the **Output as nonvirtual bus** parameter and insert a Signal Conversion block after the Inport block. The Signal Conversion block is configured to output a virtual bus.
- For root-level Outport blocks — Enable the **Output as nonvirtual bus in parent model** parameter.

- For Model blocks — For ports whose Outport blocks were updated to address issues, insert a Signal Conversion block after the corresponding ports of the Model block. The Signal Conversion block is configured to output a virtual bus.

Recommended Action and Results

To resolve issues, click **Upgrade Model**.

Note Run the **Analyze model hierarchy and continue upgrade sequence** check on the top-level model and then down through the model reference hierarchy.

Clicking **Upgrade Model** converts affected root-level Inport and Outport blocks configured for virtual buses to use nonvirtual buses in models where you:

- Use function prototype control
- Perform C++ code generation with the I/O arguments step method option.

Alternatively, you can change the C++ code generation function specification setting to Default step method:

- 1 In the **Configuration Parameters > Code Generation > Interface** pane, click **Configure C++ Class Interface**.
 - 2 In the dialog box, set the **Function specification** parameter to Default step method.
- Use buses that have variable-dimension signals
 - Use an associated non-auto storage class for Outport block signals
 - The conversion for non-auto storage class occurs only if you have the target generation license that the model requires. For example, an ERT target requires an Embedded Coder license.
 - Use Export-function models where an Outport block is driven by a nonvirtual bus
 - Have Model blocks that reference models containing Outport blocks that have been fixed — Clicking **Upgrade Model** updates Model blocks referencing the models that had Outport blocks fixed by the **Analyze model hierarchy and continue upgrade sequence** check.

See Also

- “Use Buses at Model Interfaces”

Check model for custom library blocks that rely on frame status of the signal

Check ID: `mathworks.design.DSPFrameUpgrade`

This check identifies custom library blocks in the model that depend on the frame status of the signal.

Description

This check searches for the custom library blocks in a model that depend on the frame status of the signal. The check analyzes the blocks, recommends fixes, and gives reasons for the fixes. You must make the fixes manually.

Results and Recommended Actions

| Condition | Recommended Action |
|--|---|
| The check finds custom library blocks that depend on the frame status of the signal. | Follow the recommendation given by the Upgrade Advisor. |

Capabilities and Limitations

You can run this check only on custom library blocks in your model.

You must make the fixes manually.

This check appears only if you have the DSP System Toolbox installed.

See Also

“Frame-based processing” (DSP System Toolbox)

Check model for S-function upgrade issues

Check ID: 'mathworks.design.CheckForSFcnUpgradeIssues'

Use this check on your model to identify your S-function's upgrade compatibility issues. These issues may include the use of 32-bit APIs, compilation with incompatible options, or use of deprecated separate complex APIs. Some common issues and information related to the fixes are described in results and recommendations section below.

Description

When upgrading your S-functions to use the features in the latest release, this check scans your model to warn against S-function upgrade incompatibility issues. If the result of this check gives a warning or error, fix your C MEX S-functions according to the description.

Results and Recommended Actions

| Condition | Recommended Action |
|--|---|
| Custom-built S-functions are not supported. | Recompile your S-function with available compatible options. See “Custom-built MEX File Not Supported In Current Release” for more information. |
| S-function is not compiled with the latest API (mex -R2018a). | Recompile using the latest flag (mex -R2018a). See “MEX File Is Compiled With Outdated Option” for more information. |
| S-function uses 32-bit functions. | Modify your code according to the instructions in “MEX File Calls A 32-bit Function”. |
| S-function is using deprecated separate complex APIs (mxGetPi, mxSetPi, mxGetImagData, mxSetImagData). | Use interleaved complex APIs and recompile your code with the latest flag (mex -R2018a). See “Upgrade MEX Files to Use Interleaved Complex API” for more information. |
| S-function is using deprecated type-unsafe data API (mxGetData, mxSetData). | Use type-safe data APIs and recompile your code. See “MEX File Calls An Untyped Data Access Function” for more information. |

| Condition | Recommended Action |
|--|--|
| S-function is compiled with a future release and not supported in current release. | See “MEX File Built In MATLAB Release Not Supported In Current Release” to recompile your files. |

See Also

- “MATLAB Data in C S-Functions”

Update System object syntax

Check ID: 'mathworks.design.CheckSystemObjectUpdate'

Use this check to identify and update any custom MATLAB System object in your model that have outdated syntax.

Description

This check scans your model to identify outdated System object syntax. If the check passes, all the syntax is up to date. If the check fails, you can update the syntax.

Results and Recommended Actions

| Condition | Recommended Action |
|---------------------------------------|--|
| System object syntax is up to date. | None. |
| System object syntax requires update. | A report is generated for each unique System object associated with a MATLAB System block. Use Update to update the syntax. |

See Also

- “Consult the Upgrade Advisor”

Check Rapid accelerator signal logging

Check ID: mathworks.design.CheckRapidAcceleratorSignalLogging

When simulating your model in rapid accelerator mode, use this check to find signals logged in your model that are globally disabled. Rapid accelerator mode supports signal logging. Use this check to enable signal logging globally.

Description

This check scans your model to see if a simulation is in rapid accelerator mode and whether the model contains signals with signal logging. If the check finds an instance and signal logging is globally disabled, an option to turn on signal logging globally appears.

Results and Recommended Actions

| Condition | Recommended Action |
|---|---|
| Simulation mode is not rapid accelerator. | None. You can enable signal logging in rapid accelerator mode. |
| Simulation mode is rapid accelerator. Upgrade Advisor did not find signals with signal logging enabled. | None. The model does not use signal logging. Enable signal logging for signals and globally if you want to log signals. |
| Simulation mode is rapid accelerator. Upgrade Advisor found signals with signal logging enabled. However, global setting for signal logging was disabled. | Enable signal logging globally if you want to log signals with signal logging enabled. |
| Signal logging was already globally enabled. | None. |

Action Results

Selecting **Modify** enables signal logging globally in your model.

See Also

- “Consult the Upgrade Advisor”.

Check virtual bus inputs to blocks

Check ID: `mathworks.design.VirtualBusUsage`

Check bus input signals for a set of blocks.

Description

Check bus input signals for a set of blocks.

Starting in R2015b, virtual bus signal inputs to blocks that require nonbus or nonvirtual bus input can cause an error. Examples of blocks that can specify a bus object as their output data type include a Bus Creator block and a root Inport block. The blocks that cause an error when they have a virtual bus input in this situation are:

- Assignment
- Delay

The Delay block causes an error only if you use the Block Parameters dialog box to:

- Set an initial condition that is a MATLAB structure or zero.
- Specify a value for **State name**.
- Permute Dimension
- Reshape
- Selector
- Unit Delay

The Unit Delay block causes an error only if you use the Block Parameters dialog box to:

- Set an initial condition that is a MATLAB structure or zero.
- Specify a value for **State name**.
- Vector Concatenate

Results and Recommended Actions

| Condition | Recommended Action |
|---|--|
| Virtual bus signal input to these blocks: <ul style="list-style-type: none"> • Assignment • Delay (if you specify an initial condition from the dialog box that is a MATLAB structure or zero and the value for State name is not empty) • Permute Dimension • Reshape • Selector • Unit Delay (if you specify an initial condition that is a MATLAB structure or zero and the value for State name is not empty) • Vector Concatenate | In the Upgrade Advisor, click Modify . The check inserts a Bus to Vector block to attempt to convert virtual bus input signals to vector signals. For issues that the Upgrade Advisor identifies but cannot fix, modify the model manually. For details, see “Identify Automatic Bus Conversions”. |

Action Results

Clicking **Modify** inserts a Bus to Vector block at the input ports of blocks.

For many models, running the Upgrade Advisor modifies your model so that bus signals are not treated as vectors. However, for some models you can encounter compatibility issues even after running the check. Modify your model manually to address those issues.

After you compile the model using Upgrade Advisor, the Simulink Editor sometimes indicates that you need to save the model (the model is dirty), even though you did not make changes. To prevent this issue from reoccurring for this model, save the model.

| Modeling Pattern | Issue | Solution |
|---|--|--|
| Data Store Memory block with Data Type set to Inherit: auto | A Data Store Memory block whose associated Data Store Read or Data Store Write blocks read or write bus signal data must use a bus object. | In the Data Store Memory block, set the Data Type signal attribute to Bus: <BusObject> . |
| Signal Conversion block Output parameter matches input bus type | A Signal Conversion block whose Output parameter is set to Nonvirtual bus requires a virtual bus input. A Signal Conversion block whose Output parameter is set to Virtual bus requires a nonvirtual bus input. | To create a copy of the input signal, set Output to Signal copy . |

| Modeling Pattern | Issue | Solution |
|--|---|--|
| Merge, Switch, or Multiport Switch block with multiple bus inputs | Merge, Switch, or Multiport Switch blocks with multiple bus inputs require those inputs to have the same names and hierarchy. | Reconfigure the model so that the bus inputs have the same names and hierarchy. |
| Root Inport block outputting a virtual bus and specifying a value for Port dimensions | A root Inport block that outputs to a virtual bus must inherit the dimensions. | Set the Inport block Port dimensions signal attribute to 1 or -1 (inherit). |
| Mux block with nonvirtual bus inputs | A Mux block cannot accept nonvirtual bus signals. | To treat the output as an array, replace the Mux block with a Vector Concatenate block. If you want a virtual bus output, use a Bus Creator block to combine the signals. |
| Bus to Vector block without a virtual bus signal input | A nonbus signal does not need a Bus to Vector block. | Remove the Bus to Vector block. |
| Assignment block with virtual bus inputs | The Upgrade Advisor converts the Assignment block Y0 port bus input to a vector. | Add a Bus to Vector block before the Assignment block. |
| S-function using a nonvirtual bus | An S-function that is not a Level-2 C S-function does not support nonvirtual bus signals. | Change the S-function to be a Level-2 C S-function. Consider using an S-Function Builder block to create a Level-2 C S-function. |
| Stateflow chart with parameterized data type | In a Stateflow chart, you cannot parameterize the data type of an input or output in terms of another input or output if the data type is a bus object. | For the parameterized port, set Data Type to Bus: <object name>. |
| Subsystem with bus operations in a Stateflow chart | An Inport block inside a subsystem in a Stateflow chart requires a bus object data type if its signal is a bus. | In the Inport block, set Data type to Bus: <object name>. |
| Ground block used as a bus source | The output signal of a Ground block cannot be a source for a bus. | Use a Constant block with Constant value set to 0 and the Output data type signal attribute set to Bus: <object name>. |
| Root Outport block with a single-element bus object data type | The input to the Outport block must be a bus if it specifies a bus object as its data type. | In the Outport block, set Data type to Inherit: auto . |

See Also

- Bus to Vector block
- “Identify Automatic Bus Conversions”

- “Migrating to Simplified Initialization Mode Overview” on page 9-4
- `Simulink.BlockDiagram.addBusToVector`

Check for root outports with constant sample time

Check ID: `mathworks.design.CheckConstRootOutportWithInterfaceUpgrade`

Use this check to identify root outports with a constant sample time used with an AUTOSAR target, Function Prototype Control, or the model C++ class interface.

Description

Root outports with constant sample time are not supported when using an AUTOSAR target, Function Prototype Control, or the model C++ class interface. Use this check to identify root Outport blocks with this condition and modify the blocks as recommended.

Results and Recommended Actions

| Condition | Recommended Action |
|--|---|
| Root outport with constant sample time used with an AUTOSAR target, Function Prototype Control or the model C++ class interface. | Consider one of the following: <ul style="list-style-type: none"> • Set the sample time of the block to the fundamental sample time. • Identify the source of the constant sample time and set its sample time to the fundamental sample time. • Place a Rate Transition block with inherited sample time (-1) before the block. |

See Also

- “Consult the Upgrade Advisor”.

Analyze model hierarchy and continue upgrade sequence

Check ID: `com.mathworks.Simulink.UpgradeAdvisor.UpgradeModelHierarchy`

Check for child models and guide you through upgrade checks.

Description

This check identifies child models of this model, and guides you through upgrade checks to run both non-compile and compile checks. The Advisor provides tools to help with these tasks:

- If the check finds child models, it offers to run the Upgrade Advisor upon each child model in turn and continue the upgrade sequence. If you have a model hierarchy you need to check and update each child model in turn.
- If there are no child models, you still need to continue the check sequence until you have run both non-compile and compile checks.

You must run upgrade checks in this order: first the checks that do not require compile time information and do not trigger an Update Diagram, then the compile checks.

Click **Continue Upgrade Sequence** to run the next checks. If there are child models, this will open the next model. Keep clicking **Continue Upgrade Sequence** until the check passes.

Results and Recommended Actions

| Condition | Recommended Action |
|---|--|
| Child models found | Click Continue Upgrade Sequence to run the next checks. If there are child models, this will close the current Upgrade Advisor session, and open Upgrade Advisor for the next model in the hierarchy. |
| No child models, but more checks to run | If there are no child models, click Continue Upgrade Sequence to refresh the Upgrade Advisor with compilation checks selected. The compile checks trigger an Update Diagram (marked with ^). Run the next checks and take advised actions. When you return to this check, click Continue Upgrade Sequence until this check passes. |

Tips

Best practice for upgrading a model hierarchy is to check and upgrade each model starting at the leaf end and working up to the root model.

When you click **Continue Upgrade Sequence**, the Upgrade Advisor opens the leaf model as far inside the hierarchy as it can find. Subsequent steps guide you through upgrading your hierarchy from leaf to root model.

When you open the Upgrade Advisor, the checks that are selected do not require compile time information and do not trigger an Update Diagram. Checks that trigger an Update Diagram are not selected to run by default, and are marked with ^. When you use the Upgrade Advisor on a hierarchy, keep clicking **Continue Upgrade Sequence** to move through this sequence of analysis:

- 1 The Upgrade Advisor opens each model and library in turn, from leaf to root, and selects the non-compile checks. Run the checks, take any advised actions, then click **Continue Upgrade Sequence** to open the next model and continue.
- 2 When you reach the root end of the hierarchy, the Upgrade Advisor then opens each model again in the same order (but not libraries) and selects only the checks that require a model compile. Run the checks, take any advised actions, then click **Continue Upgrade Sequence** to open the next model. Continue until you reach the end of the hierarchy and this check passes.

See Also

- “Consult the Upgrade Advisor”.
- “Model Upgrades”

Check Access to Data Stores

Check ID: `mathworks.design.ConflictsForDataStoreReadWriters`

Identify potential execution order sensitivity when reading and writing to data stores.

Description

The execution order of blocks that read and write to the same data store can change the simulation result. When blocks in the same hierarchy access the same data store, the execution order is not deterministic.

Results and Recommended Actions

| Condition | Recommended Action |
|--|--|
| Data Store Memory block accessed by multiple blocks in the same hierarchy. | To enforce execution order for the blocks, consider the following: <ul style="list-style-type: none"> • Add a data dependency between the blocks. • Set block priority. • Move blocks into separate Function-Call Subsystem blocks and schedule them. |

See Also

- “Local and Global Data Stores”
- Data Store Memory
- Data Store Read
- Data Store Write

Check relative execution orders for Data Store Read and Data Store Write blocks

Check ID: `mathworks.design.TaskBasedSorting`

Check relative execution order changes between legacy and task-based sorting for Data Store Read and Data Store Write blocks.

Description

Legacy models used block sorting to determine block execution order. With task-based sorting, the relative execution order involving Data Store Memory blocks can change. This check detects the changes and provides an option to update your model with the original execution order.

Results and Recommended Actions

| Condition | Recommended Action |
|--|---------------------------------|
| Execution order with a Data Store Memory block changes. You want the original execution order. | Click the Modify button. |

See Also

- “Control and Display Execution Order”

Check for case mismatches in references to models and libraries

Check ID: `mathworks.design.CaseSensitiveBlockDiagramNames`

Identify and fix case-insensitive references to models and libraries.

Description

Starting R2020a, Simulink model and library names are case-sensitive. This check detects and provides an option to fix case-insensitive references to models and libraries.

Results and Recommended Actions

| Condition | Recommended Action |
|--|---|
| The check finds case mismatches in references to models and libraries. | Follow the recommendation given by the Upgrade Advisor. |

See Also

- “Consult the Upgrade Advisor”

Check model for Signal Builder blocks

Check ID: `mathworks.design.SigblDR.upgradeCheck`

Searches for Signal Builder blocks in models.

Description

Find Signal Builder blocks in models and replace them with equivalently configured Signal Editor blocks.

Results and Recommended Actions

| Condition | Recommended Action |
|---|---|
| Model contains one or more Signal Builder blocks. | To replace all Signal Builder blocks with equivalent Signal Editor blocks, click the associated link. |

See Also

- Signal Editor
- “Consult the Upgrade Advisor”

Check output dimensions of MATLAB Function blocks

Check ID: `mathworks.simulink.MLFBOutputDimensions`

Check lists all the MATLAB Function blocks that have the **Interpret output column vectors as one-dimensional data** parameter enabled. If the parameter is enabled, the block converts output column vectors of size N-by-1 to one-dimensional signals with a signal size equal to N.

Results and Recommended Actions

| Condition | Recommended Action |
|---|---|
| MATLAB function block produces one-dimensional output data and has parameter enabled | Clicking the Fix It button does not disable the parameter for the MATLAB function block. To disable the parameter go to MATLAB function block. Click Ports and Data Manager under the function tab and deselect the parameter. Check the simulation behavior of the model, as disabling the parameter changes the size propagation of the MATLAB function block. |
| MATLAB function block does not produce one-dimensional data and has parameter enabled | Click the Fix It button to disable the parameter for the MATLAB function block. |

See Also

- “Consult the Upgrade Advisor”
- “Interpret output column vectors as one-dimensional data”

Check model for RF Blockset Divider blocks using Wilkinson power divider component with broken connections

Check ID: mathworks.design.rfblockset.ce.checkDisconnectedDividerBlocks

Search the model and list the RF Blockset™ Divider blocks using the Wilkinson power divider component with broken port connections on port **3**.

Description

Starting R2021a, port positions of the RF Blockset Divider blocks using the Wilkinson power divider component are changed. This check searches and lists the Divider blocks using the Wilkinson power divider component model with broken port connections on port 3 prior to R2021a. You can then rewire the connections using the Modify button.

Results and Recommended Actions

| Condition | Recommended Action |
|--|--|
| Models have RF Blockset Divider blocks using the Wilkinson power divider component with broken port connections on port 3. | Click the Modify button to rewire the broken connections on port 3 of the RF Blockset Divider blocks. |

Action Results

Clicking **Modify** rewires the broken port connections on port 3 of the RF Blockset Divider blocks.

Note The **Modify** button will attempt to automatically rewire all the broken connections at port 3 of the Divider blocks using the Wilkinson power divider component in your model. To ensure accuracy, you must subsequently:

- Examine the details listed under the **Result** pane of the Upgrade Advisor.
 - The first list enumerates the RF Blockset Divider blocks using the Wilkinson power divider component that require manual rewiring due to model complexity.
 - The second list enumerates the automatically rewired blocks.
 - Fixed and unfixed Divider blocks are temporarily highlighted in colors green and red, respectively. Click the **Remove all temporary block highlighting** link at the bottom of the **Result** pane to remove the highlights.
-

See Also

- “Consult the Upgrade Advisor”

Identify Environment Controller Blocks and Replace Them with Variant Source Blocks

Check ID:mathworks.design.ReplaceEnvironmentControllerBlk

Search for Environment Controller blocks in the model.

Description

Find Environment Controller blocks in the model and replace them with Variant Source blocks with the **Variant control mode** parameter set to 'sim codegen switching'.

Results and Recommended Actions

| Condition | Recommended Action |
|---|---|
| Model contains one or more Environment Controller blocks. | Replace Environment Controller blocks with Variant Source blocks with the Variant control mode parameter set to 'sim codegen switching'. |

Capabilities and Limitations

- You can run this check on your library models.
- You cannot use this check to identify Environment Controller blocks in referenced models and linked blocks.

See Also

- “Environment Controller block has been removed” on page 1-565
- Variant Source

Performance Advisor Checks

Simulink Performance Advisor Checks

In this section...

“Simulink Performance Advisor Check Overview” on page 10-2

“Baseline” on page 10-3

“Checks that Require Update Diagram” on page 10-3

“Checks that Require Simulation to Run” on page 10-3

“Check Simulation Modes Settings” on page 10-3

“Check Compiler Optimization Settings” on page 10-3

“Check Hardware Acceleration Settings” on page 10-3

“Create baseline” on page 10-4

“Identify resource-intensive diagnostic settings” on page 10-4

“Check optimization settings” on page 10-4

“Identify inefficient lookup table blocks” on page 10-4

“Check MATLAB System block simulation mode” on page 10-5

“Identify Interpreted MATLAB Function blocks” on page 10-5

“Identify simulation target settings” on page 10-5

“Check model reference rebuild setting” on page 10-6

“Identify Scope blocks” on page 10-6

“Identify active instrumentation settings on the model” on page 10-6

“Check model reference parallel build” on page 10-6

“Check Delay block circular buffer setting” on page 10-7

“Check continuous and discrete rate coupling” on page 10-8

“Check zero-crossing impact on continuous integration” on page 10-8

“Check discrete signals driving derivative port” on page 10-9

“Check solver type selection” on page 10-9

“Select multi-thread co-simulation setting on or off” on page 10-10

“Identify co-simulation signals for numerical compensation” on page 10-10

“Check Dataflow Domain Settings” on page 10-10

“Select simulation mode” on page 10-11

“Select compiler optimizations on or off” on page 10-11

“Select hardware acceleration setting” on page 10-12

“Final Validation” on page 10-12

Simulink Performance Advisor Check Overview

Use Performance Advisor checks to improve model simulation time.

See Also

“Improve Simulation Performance Using Performance Advisor”

Baseline

Establish a measurement to compare the performance of a simulation after Performance Advisor implements improvements.

See Also

“Create a Performance Advisor Baseline Measurement”

Checks that Require Update Diagram

These checks require that **Update Diagram** occurs in order to run.

See Also

“Improve Simulation Performance Using Performance Advisor”

Checks that Require Simulation to Run

These checks require simulation to run in order to collect sufficient performance data. Performance Advisor reports the results after simulation completes.

See Also

“Improve Simulation Performance Using Performance Advisor”

Check Simulation Modes Settings

These checks evaluate simulation modes (Normal, Accelerator, Rapid Accelerator, Rapid Accelerator with up-to-date check off) and identify the optimal mode to achieve fastest simulation.

See Also

“What Is Acceleration?”

Check Compiler Optimization Settings

Use these checks to select compiler optimization settings for improved performance.

See Also

“Compiler optimization level”

Check Hardware Acceleration Settings

Use the check to compare three hardware acceleration options based on their simulation times.

See Also

“Hardware acceleration”

Create baseline

Select this check to create a baseline when Performance Advisor runs. You can also create a baseline manually. A baseline is the measurement of simulation performance before you run checks in Performance Advisor. The baseline includes the time to run the simulation and the simulation results (signals logged). Before you create a baseline for a model, in the **Data Import/Export** pane of the Configuration Parameters dialog box:

- Select the **States** check box.
- Set the **Format** parameter to `Structure with time`.

See Also

“Create a Performance Advisor Baseline Measurement”

Identify resource-intensive diagnostic settings

To improve simulation speed, disable diagnostics where possible. For example, some diagnostics, such as **Solver data inconsistency** or **Array bounds exceeded**, incur run-time overheads during simulations.

See Also

- “Diagnostics”
- “Improve Simulation Performance Using Performance Advisor”

Check optimization settings

To improve simulation speed, enable optimizations where possible. For example, if some optimizations, such as Block Reduction, are disabled, enable these optimizations to improve simulation speed.

You can also trade off compile-time speed for simulation speed by setting the compiler optimization level. Compiler optimizations for accelerations are disabled by default. Enabling them accelerates simulation runs but results in longer build times. The speed and efficiency of the C compiler used for Accelerator and Rapid Accelerator modes also affects the time required in the compile step.

See Also

- “Model Configuration Parameters: Code Generation Optimization” (Simulink Coder)
- “Improve Simulation Performance Using Performance Advisor”

Identify inefficient lookup table blocks

To improve simulation speed, use properly configured lookup table blocks.

See Also

- “Lookup Tables”
- “Optimize Generated Code for Lookup Table Blocks”
- “Optimize Breakpoint Spacing in Lookup Tables”

- “Improve Simulation Performance Using Performance Advisor”

Check MATLAB System block simulation mode

In general, to improve simulation speed, choose `Code generation` for the **Simulate using** parameter of the MATLAB System block. Because data exchange between MATLAB and Simulink passes through several software layers, `Interpreted execution` usually slows simulations, particularly if the model needs many data exchanges.

This check identifies which MATLAB System blocks can generate code and changes the **Simulate using** parameter value to `Code generation` where possible.

While `Code generation` does not support all MATLAB functions, the subset of the MATLAB language that it does support is extensive. By using this `Code generation`, you can improve performance.

See Also

- MATLAB System
- “Simulation Modes”
- “Improve Simulation Performance Using Performance Advisor”

Identify Interpreted MATLAB Function blocks

To improve simulation speed, replace `Interpreted MATLAB Function` blocks with `MATLAB Function` blocks where possible. Because data exchange between MATLAB and Simulink passes through several software layers, `Interpreted MATLAB Function` blocks usually slow simulations, particularly if the model needs many data exchanges.

Additionally, because you cannot compile an `Interpreted MATLAB Function`, an `Interpreted MATLAB Function` block impedes attempts to use an acceleration mode to speed up simulations.

While `MATLAB Function` blocks do not support all MATLAB functions, the subset of the MATLAB language that it does support is extensive. By replacing your `interpreted MATLAB` code with code that uses only this embeddable MATLAB subset, you can improve performance.

See Also

- MATLAB Function
- “Improve Simulation Performance Using Performance Advisor”

Identify simulation target settings

To improve simulation speed, disable simulation target settings where possible. For example, in the Configuration Parameters dialog box, clear the **Simulation Target > Echo expression without semicolons** check box to improve simulation speed.

See Also

- “Model Configuration Parameters: Simulation Target”
- “Improve Simulation Performance Using Performance Advisor”

Check model reference rebuild setting

To improve simulation speed, in the Configuration Parameters dialog box, verify that the **Model Referencing > Rebuild** parameter is set to **If any changes in known dependencies detected**.

See Also

- “Rebuild”
- “Improve Simulation Performance Using Performance Advisor”

Identify Scope blocks

Opened and uncommented Scope blocks can impact simulation performance. To improve simulation performance, close and comment out Scope blocks. Right-click a scope block, and then select **Comment Out**.

For opened Scopes, you can improve simulation speed by reducing updates. From the Scope **Simulation** menu, select **Reduce Updates to Improve Performance**.

See Also

- “Improve Simulation Performance Using Performance Advisor”

Identify active instrumentation settings on the model

Identify active instrumentation settings on the model. The fixed-point instrumentation mode controls which objects log minimum, maximum, and overflow data during simulation. Instrumentation is required to collect simulation ranges using the Fixed-Point Tool. These ranges are used to propose data types for the model (requires Fixed-Point Designer). When you are not actively converting your model to fixed point, disable the fixed-point instrumentation to restore the maximum simulation speed to your model.

In the **Apps** tab, select **Fixed-Point Tool**. Under **System under design**, click **Continue**.

In the Model Hierarchy pane, the Fixed-Point Tool denotes systems that currently have instrumentation turned on with **(mmo)**, or **(o)**. Right-click the system in the model hierarchy and, under **Fixed-point instrumentation mode**, select **Use local settings** or **Force off**.

See Also

- Fixed-Point Instrumentation and Data Type Override (Fixed-Point Designer)

Check model reference parallel build

To improve simulation, verify the number of referenced models in the model. If there are two or more referenced models, build the model in parallel if possible.

Performance Advisor analyzes the model and estimates the build time on the current computer as if it were using several cores. It also estimates the parallel build time for the model in the same way an estimation would be performed if Parallel Computing Toolbox or MATLAB Parallel Server software were installed on the computer. Performance Advisor performs this estimate as follows:

- 1 Search the model for referenced models that do not refer to other referenced models.
- 2 Calculate the average number of blocks in each of the referenced models that do not refer to other referenced models.
- 3 Of the list of referenced models that do not refer to others, select a referenced model whose number of blocks is closest to the calculated average.
- 4 Build this model to obtain the build time.
- 5 Based on the number of blocks and the build time for this referenced model, estimate the build time for all other referenced models.
- 6 Based on these build times, estimate the parallel build time for the top model.

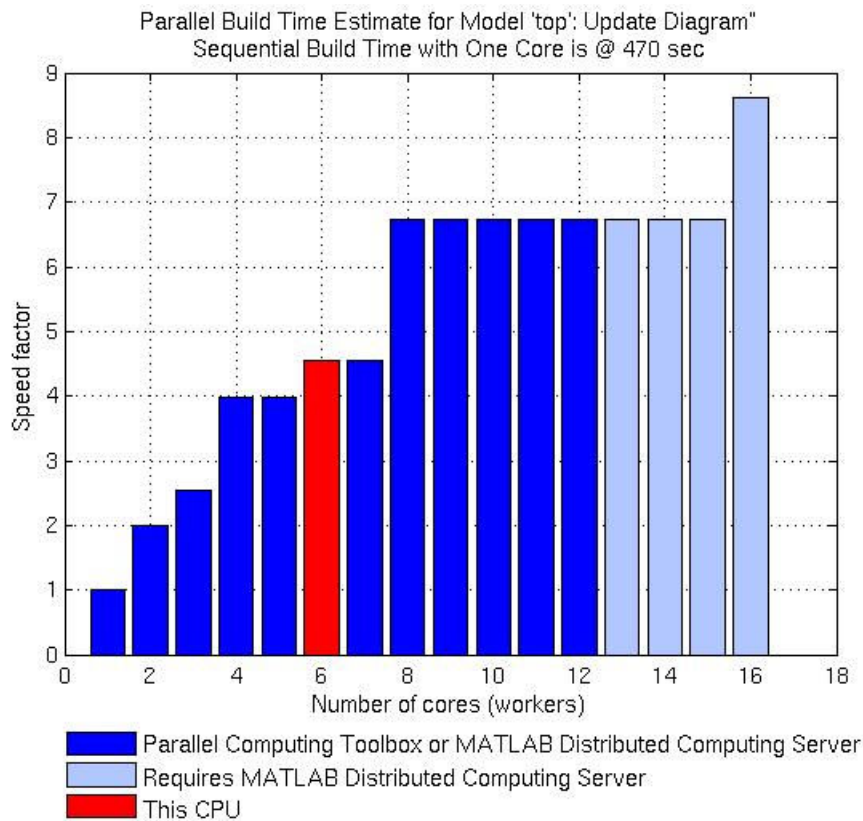

To calculate the overhead time introduced by the parallel build mechanism, set the Parallel Build Overhead Time Estimation Factor. Performance Advisor calculates the estimated build time with overhead as:

$$(1 + \text{Parallel Build Overhead Time Estimation Factor}) * (\text{Build time on a single machine})$$

See Also

- “Enable parallel model reference builds”
- “Improve Simulation Performance Using Performance Advisor”

Check Delay block circular buffer setting

To improve simulation, check that each Delay block in the model uses the appropriate buffer type. By default, the block uses an array buffer (the **Use circular buffer for state** option is not selected).

However, when the delay length is large, a circular buffer can improve execution speed by keeping the number of copy operations constant.

If the Delay block is currently using an array buffer, and all of the following conditions are true, Performance Advisor selects a circular buffer:

- The Delay block is in sample-based mode, i.e., either the **Input processing** parameter is set to `Elements as channels (sample based)`, or the input signal type is set to `Sample based`.
- The value or upper limit of the delay length is 10 or greater.
- The size of the state—equal to the delay length multiplied by the total of all output signal widths—is 1000 or greater.

See Also

- Delay
- “Improve Simulation Performance Using Performance Advisor”

Check continuous and discrete rate coupling

If your model contains both discrete and continuous rates, the coupling between these rates can slow down simulation. Performance Advisor checks for these conditions in your model.

- The model is using a variable step solver.
- The model contains both continuous and discrete rates.
- The fastest discrete rate is relatively smaller than **Max step size** determined by the solver.

Setting the `DecoupledContinuousIntegration` parameter to on might speed up simulation.

See Also

- “Solver Selection Criteria”
- “Speed Up Simulation”
- “Improve Simulation Performance Using Performance Advisor”

Check zero-crossing impact on continuous integration

If your model contains zero-crossings which do not impact the continuous integration, the simulation might slow down when all the following conditions are satisfied:

- The model uses a variable-step solver.
- The model contains blocks that have continuous states and zero-crossings.
- Some of the zero-crossings do not affect the integration of the continuous states.

Setting the `MinimalZcImpactIntegration` parameter to On might speed up simulation.

See Also

- “Speed Up Simulation”
- “Solver Selection Criteria”
- “Improve Simulation Performance Using Performance Advisor”

Check discrete signals driving derivative port

Run this check if your simulation has many unnecessary resets. A discrete signal driving a block with continuous states triggers a reset at every sample time hit of the block. These resets are computationally expensive. Performance Advisor checks for these signals and blocks and provides a list of the same.

You can edit the model around the discovered discrete signals that drive these blocks to remove such cases. For example, inserting a Zero Order Hold block between the discrete signal and the corresponding block with continuous states might help resolve the issue.

See Also

- “Speed Up Simulation”
- “Modeling Techniques That Improve Performance”

Check solver type selection

To improve simulation, check that the model uses the appropriate solver type.

Explicit vs. Implicit Solvers

Selecting a solver depends on the approximation of the model stiffness at the beginning of the simulation. A stiff system has both slowly and quickly varying continuous dynamics. Implicit solvers are specifically designed for stiff problems, whereas explicit solvers are designed for non-stiff problems. Using non-stiff solvers to solve stiff systems is inefficient and can lead to incorrect results. If a non-stiff solver uses a very small step size to solve your model, check to see if you have a stiff system.

| Model | Recommended Solver |
|-----------------------------------|--------------------|
| Represents a stiff system | ode15s |
| Does not represent a stiff system | ode45 |

Performance Advisor uses the heuristic shown in the table to choose between explicit and implicit solvers.

| Original Solver | Performance Advisor Action |
|------------------------------|--|
| Variable step solver | Calculates the system stiffness at 0 first. Then: <ul style="list-style-type: none"> • If the stiffness is greater than 1000, Performance Advisor chooses ode15s. • If the stiffness is less than 1000, Performance Advisor chooses ode45. |
| Fixed-step continuous solver | <ul style="list-style-type: none"> • If the stiffness is greater than 1000, Performance Advisor chooses ode14x. • If the stiffness is less than 1000, Performance Advisor chooses ode3. |

This heuristic works best if the system stiffness does not vary during simulation. If the system stiffness varies with time, choose the most appropriate solver for that system rather than the one Performance Advisor suggests.

See Also

- “Solver Selection Criteria”
- “Speed Up Simulation”
- “Improve Simulation Performance Using Performance Advisor”

Select multi-thread co-simulation setting on or off

Adjust co-simulation settings for better performance and accuracy.

- Validate and revert changes if simulation time increases — Performance Advisor reverts previous co-simulation settings when the simulation time increases.
- Validate and revert changes if degree of accuracy is greater than tolerance — Performance Advisor reverts previous co-simulation settings if the degree of accuracy is greater than tolerance.

Tip You can use the `tic` and `toc` functions to measure the simulation time.

See Also

- `tic`
- `toc`
- `sim`

Identify co-simulation signals for numerical compensation

Identify co-simulation signals that may need explicit numerical compensation.

- Validate and revert changes if time of simulation increases — Performance Advisor reverts previous co-simulation settings the simulation time increases.
- Validate and revert changes if degree of accuracy is greater than tolerance — Performance Advisor reverts co-simulations if the degree of accuracy is greater than tolerance.

Tip You can use the `tic` and `toc` functions to measure the simulation time.

See Also

- `tic`
- `toc`
- `sim`

Check Dataflow Domain Settings

To increase the throughput of a dataflow domain, it can be advantageous to increase the latency of the system. The Performance Advisor analyzes the dataflow domains in your model and finds the optimal latency settings. The analysis also identifies any other multithreading limitations in the dataflow domains.

The dataflow analysis is a multistep process where the analysis may simulate the model with run-time profiling enabled for each block inside the dataflow domains before running partitioning analysis.

After the analysis completes, the Performance Advisor suggests a latency value that optimizes the throughput of the system for the multicore CPU architecture of the host computer and identifies any other multithreading limitations in the dataflow domains

See Also

- “Dataflow Domain” (DSP System Toolbox)

Select simulation mode

To achieve fastest simulation time, use this check to evaluate the following modes and identify the optimal selection:

- Normal
- Accelerator
- Rapid Accelerator
- Rapid Accelerator with up-to-date check off

In Normal mode, Simulink interprets your model during each simulation run. If you change the model frequently, this is generally the preferred mode to use because it requires no separate compilation step. It also offers the most flexibility to make changes to your model.

In Accelerator mode, Simulink compiles a model into a binary shared library or DLL where possible, eliminating the block-to-block overhead of an interpreted simulation in Normal mode. Accelerator mode supports the debugger and profiler, but not runtime diagnostics.

In Rapid Accelerator mode, simulation speeds are fastest but this mode only works with models where C-code is available for all blocks in the model. Also, this mode does not support the debugger or profiler.

When choosing Rapid Accelerator with up-to-date check off, Performance Advisor does not perform an up-to-date check during simulation. You can run the Rapid Accelerator executable repeatedly while tuning parameters without incurring the overhead of up-to-date checks. For instance, if you have a large model or a model that makes extensive use of model reference, this method of execution can increase efficiency.

For models with 3-D signals, Normal or Accelerator modes work best.

See Also

- “How Acceleration Modes Work”
- “Choosing a Simulation Mode”
- “Comparing Performance”
- “Run Simulations Programmatically”

Select compiler optimizations on or off

Use this check to determine whether performing compiler optimization can help improve simulation speed. The optimization can only be performed in Accelerator or Rapid Accelerator modes.

Note This check will be skipped if MATLAB is not configured to use an optimizing compiler.

See Also

- “How Acceleration Modes Work”
- “Choosing a Simulation Mode”
- “Comparing Performance”
- “Improve Simulation Performance Using Performance Advisor”

Select hardware acceleration setting

This check will compare three hardware acceleration options based on their simulation times.

- **Off** — Hardware acceleration is disabled and no SIMD is used.
- **Leverage generic hardware (Faster, no rebuild)** — Leverage SIMD instructions for hardware generic to Simulink system requirements. This option does not require rebuilding the model for simulation when the host computer changes.
- **Leverage native hardware (Fastest, rebuild allowed)** — Leverage SIMD instructions for hardware native to the host computer. This option may require rebuilding the model for simulation when the host computer changes.

You can select the hardware acceleration based on the comparison.

See Also

- “Hardware acceleration”

Final Validation

This check validates the overall performance improvement of simulation time and accuracy in a model. If the performance is worse than the original model, Performance Advisor discards all changes to the model and loads the original model.

Global settings for validation do not apply to this check. If you have not validated the performance improvement from changes resulting from other checks, use this check to perform a final validation of all changes to a model.

See Also

- “Comparing Performance”
- “Improve Simulation Performance Using Performance Advisor”

Simulink Limits

- “Maximum Size Limits of Simulink Models” on page 11-2
- “Systems and Models” on page 11-3
- “Simulink Models” on page 11-6
- “Simulink Simulation” on page 11-28
- “Simulink Tools” on page 11-33
- “Programming Constructs in Simulink” on page 11-44
- “Model Development Processes” on page 11-46
- “What is Simulink Online?” on page 11-49

Maximum Size Limits of Simulink Models

The following table documents some limits on the size and complexity of Simulink models.

| Model Feature | Limit |
|--|---------------------------------------|
| Maximum number of levels in a block diagram | 1024 |
| Maximum number of branches in a line | 1024 |
| Maximum length of a parameter name | 63 |
| Maximum length of a parameter character vector value | 32768 |
| Maximum size of a model window, as determined by supported coordinates | -1073740824 to 1073740823, inclusive |
| Maximum number of bytes for a single logged data point | 90 MB |
| Maximum number of bytes of logged simulation data | Limited by available hard drive space |
| Maximum number of bytes for an individual block I/O buffer length | $2^{31}-1$ bytes |
| Maximum number of bytes for an individual DWork buffer length | $2^{31}-1$ bytes |
| Maximum length of integer and fixed-point data types | 128 bits |
| Maximum length of string data type | 32,766 characters |

Systems and Models

The concepts in this topic provide a consistent and common language for using Simulink software tools.

System

A system is a group of interdependent physical and functional parts with measurable characteristics that change over time.

For example, a vehicle is a *system* with multiple parts. Measurable characteristics include the linear speed of the vehicle and the rotational speed of the wheels.



System Component

A system component is part of a *system* that interacts with the other parts of the *system*. The interactions between components define the structure and behavior of the *system*.

For example, a cruise control module is a *system component* in a vehicle *system*. A microcontroller and the hardware associated with it define the structure while a software algorithm to control speed defines the behavior.

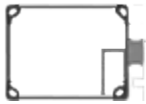

Model

A model is a mathematical description of a *system* derived either from physical laws or experimental data. The description typically uses a set of variables with a set of differential and difference equations that define the relationships between the variables.

In the following example for a vehicle, $u(t)$ is the force (N) moving a vehicle forward, $v(t)$ is the velocity (m/s), b is a drag coefficient (N·s/m), and m is the mass of the vehicle (kg).



The vehicle is a continuous system. For continuous systems, differential equations describe the rate of change for variables with the equations defined for all values of time. The velocity of the vehicle $v(t)$ and its acceleration $v'(t)$ are defined with the following first order differential equation.

$$mv'(t) + bv(t) = u(t)$$

You can create a Simulink model for this equation by adding blocks, specifying block behavior, and using signal lines to connect the blocks to each other. The following Simulink block diagram implements the differential equation.

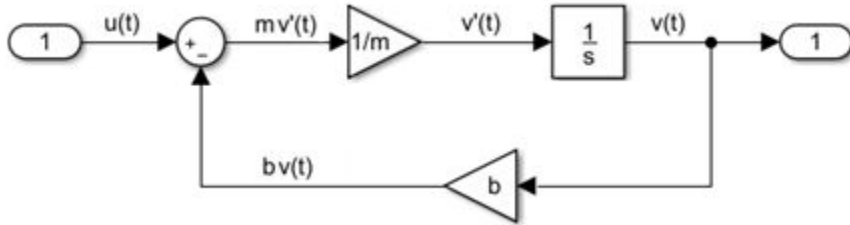

Model Component

A model component is part of a *model* that interacts with the other parts through an interface of inputs and outputs. Simulink implements *model components* using Subsystem and Model blocks. A Model block references another Simulink model saved in a separate file.

In the following example, the control model was saved in the Simulink model file `control_model.slx`, and then referenced from a Model block in a second Simulink model. A Subsystem block was added for modeling the vehicle mechanics.

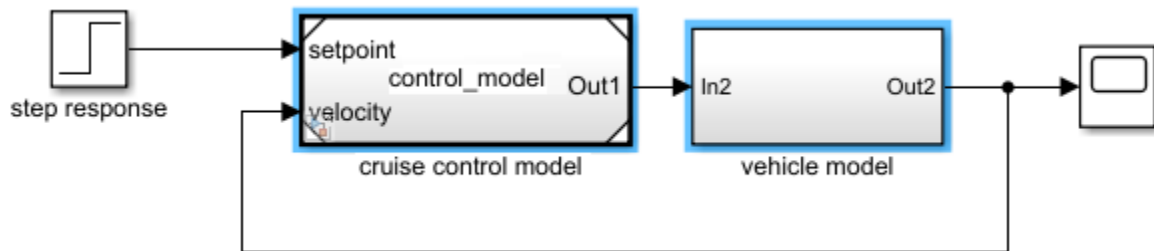

Typically, controllers are built with discrete systems using a computer to implement the control algorithm. For discrete systems, difference equations describe the rate of change for variables defined only at specific times. For example, the control signal for a simple discrete PI (proportional-integral) controller can be defined with the following difference equation.

$$PI[n] = e[n]K_p + (e[n] + \text{integral}[n-1])K_i$$

Where $e[n]$ is the error between a signal whose value is controlled (velocity) and the specified value (set velocity), K_p is the proportion constant, K_i is the integration constant, and n is the time step.

The following Simulink *block diagram* implements the difference equation.

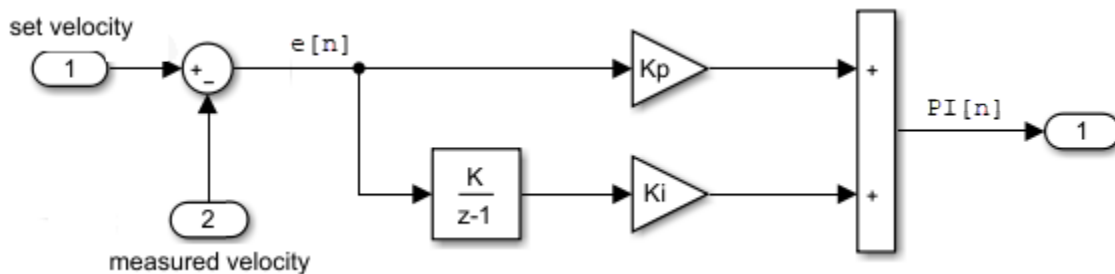

See also: “Model a Continuous System”, “Component-Based Modeling Guidelines”, “Create Custom Library”, “Model Reference Basics”.

Differential Algebraic Equations

Some systems of equations contain additional constraints that involve the independent variable and the state vector in addition to differential equations. Such systems are called differential algebraic equations (DAEs),

The term algebraic refers to equations that do not involve any derivatives.

In Simulink models, algebraic loops are algebraic constraints. Models with algebraic loops define a system of differential algebraic equations.

For example,

$$\begin{aligned}x' &= x \\ 0 &= -x + u - 2x\end{aligned}$$

is a system of differential algebraic equations implemented in the following Simulink model

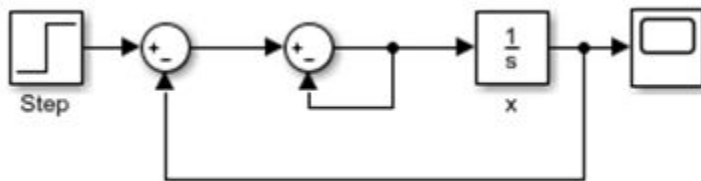

Simulink Models

A model is an abstract and simplified description of a system using mathematical equations and diagrams. The modeling concepts in this topic provide context for understanding the process of mathematically describing a system with Simulink software tools.

Block Diagram

A block diagram is a visual representation of a model in the Simulink Editor. The editor allows you to add blocks selected from block libraries representing elementary model components. Elementary components include integrator, gain, and sum blocks. Blocks are connected to each other with signal and event lines to visually construct the model equations.

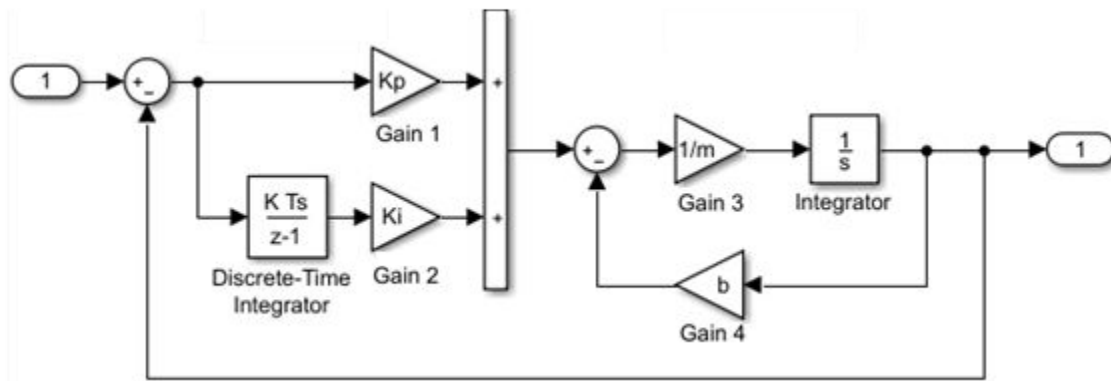

Block Diagram Semantics

A classic block diagram of a system is drawn graphically with blocks and lines. The history of these block diagrams is derived from engineering areas such as Feedback Control Theory and Signal Processing. A block within a block diagram defines a model in itself. The relationships between elementary models are represented by signal lines connecting the blocks. The blocks and lines in a block diagram collectively describe the overall model of a system.

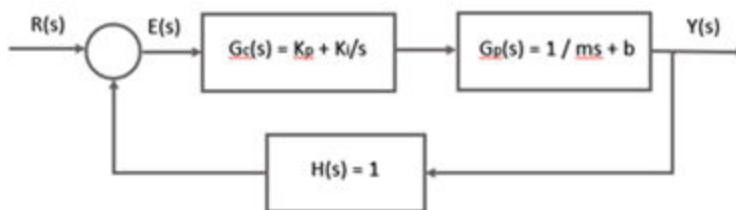

Simulink extends classic block diagrams by:

- Adding a set of equations (block methods) to each block that defines the time-based relationships between the input signals, output signals, and block state variables.
- Adding parameters to each block that specify the coefficients from the model equations.
- Providing an engine for numerical solution of the block diagram by evaluating the relationships over time, where time starts at a user-specified “start time” and ends at a user-specified “stop time.”

See also: “Simulink Block Diagrams”, “Build and Edit a Model Interactively”, “Simulation”.

Blocks

A block is a basic modeling construct of the Simulink Editor. Add blocks from the built-in Simulink libraries to perform specific operations. You can also create custom blocks. Some blocks have input signals, output signals, and states. Most blocks have parameters that you use to specify block behavior. Whether a block has parameters and the nature of those parameters is specific to each block.



Each block represents a set of equations for the Simulink engine. The equations are represented as block methods. The blocks shown above have the following block methods.

$$\begin{cases} x[n+1] = u[n] \\ y[n] = x[n] \end{cases} \quad \begin{cases} \frac{dx}{dt} = u(t) \\ y(t) = x(t) \end{cases} \quad y(t) = 2 * x(t) \quad y(t) = 5$$

Block methods are evaluated during the simulation of a block diagram. The evaluation of the block methods is performed within a simulation loop, where each cycle through the simulation loop represents the evaluation of the block diagram at a given point in time.

Virtual Blocks

Virtual blocks organize and provide graphical hierarchy in a model, but they do not affect the simulation result. During model simulation, Simulink expands the blocks in place before execution, a process known as flattening. This expansion is similar to the way macros work in a programming language such as C or C++.

Simulink defines the following virtual blocks:

- Virtual Subsystem - Use a virtual subsystem to encapsulate related and functional parts within a larger model. A Virtual Subsystem block has the check box for the parameter **Treat as atomic unit** cleared.

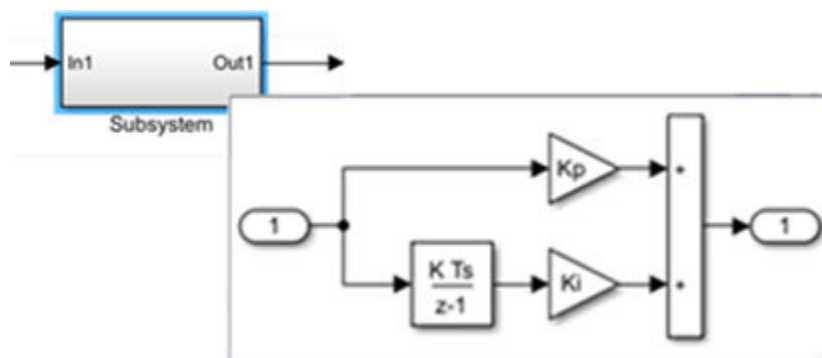

- Inport and Outport - Use port blocks to move data (signals) and events (function calls) from outside a Subsystem block or Model block to within the block, and vice versa.

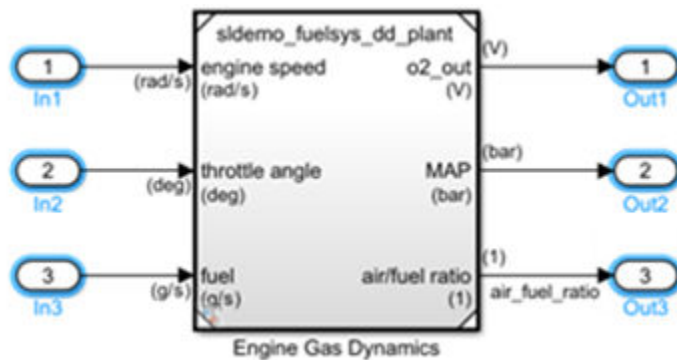

- Bus Creator, Bus Assignment, Bus Selector - Bus blocks combine signals into a virtual bus and manage the routing of signals around a complex block diagram. Virtual buses are a graphical convenience and do not change the behavior of the model.

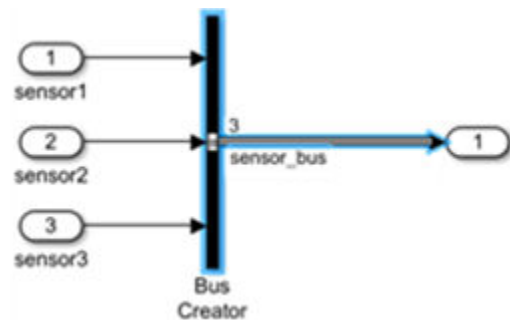

See “Nonvirtual and Virtual Blocks”, “Signal Types”, “Types of Composite Signals”.

Nonvirtual Blocks

Nonvirtual blocks provide execution control and graphical hierarchy in a model. Simulink defines the following nonvirtual Subsystem and Model blocks:

- Atomic Subsystem and Model - Blocks within an Atomic Subsystem block or a Model block that references a model execute as a single unit (atomic execution) at each time step. For an Atomic Subsystem block, the check box for the parameter **Treat as atomic unit** is selected.

You can place any Simulink block in an Atomic Subsystem or referenced model, including blocks with different execution rates. This flexibility provides the advantage of grouping functional aspects of a model at the execution level.

In the following example, the vehicle model is an Atomic Subsystem block containing blocks that model the mechanics of a car. The control model is referenced from a Model block.

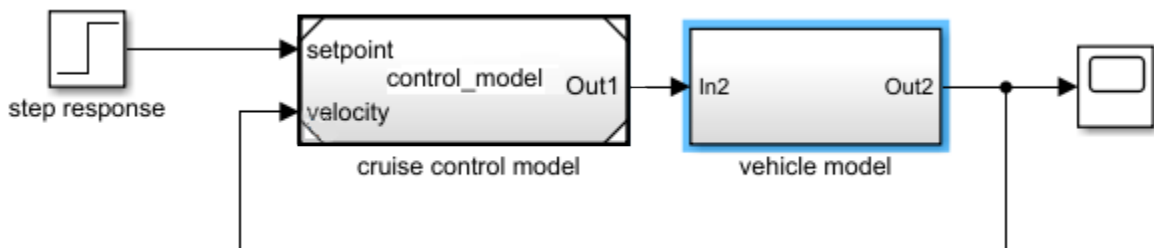

- Enabled and/or Triggered - Atomic Subsystem or Model block whose execution is controlled by external data from a signal. Contains an Enable or Trigger block, or both. For the Trigger block, the parameter **Trigger type** is set to rising, falling, or either.

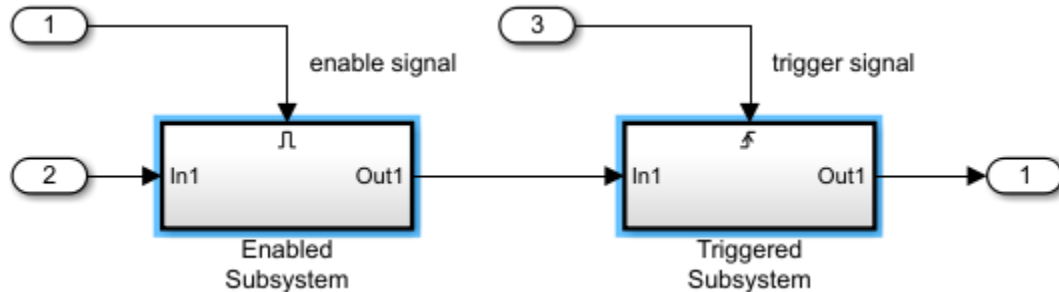

- Function-Call - Atomic Subsystem or Model block whose execution is controlled by an event from a function-call initiator (such as a Stateflow chart or a Function-Call Generator, S-Function, or Hit Crossing block). Contains a Trigger block with **Trigger type** set to function-call.

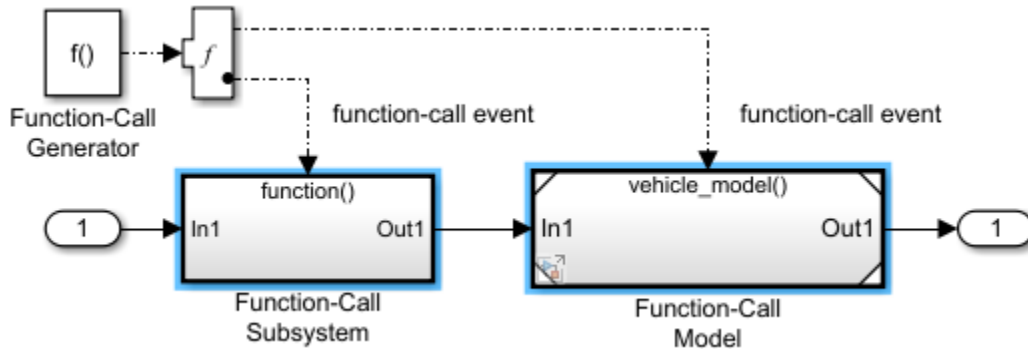

Simulink defines the following nonvirtual components only for Subsystem blocks.

- Action Subsystem - Atomic Subsystem block whose execution is controlled by an event from an action initiator (e.g., If or Switch Case block). Contains an Action Port block within the Subsystem block.

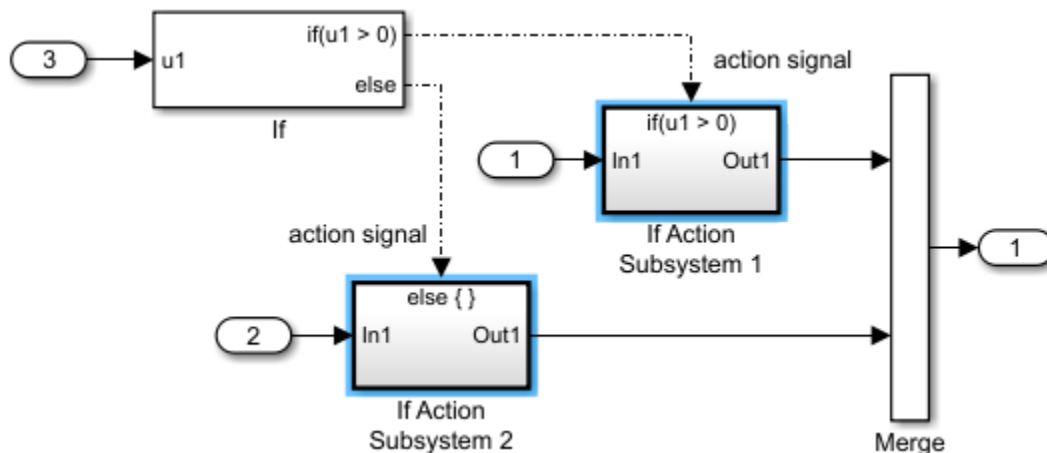

- While Iterator Subsystem - Atomic Subsystem block that runs multiple iterations during each model time step. Contains a While Iterator block that controls the number of iterations by evaluating a logical condition.

A while iterator subsystem is similar to a function-call subsystem in that it can run for any number of iterations at a given time step. The while iterator subsystem differs from a function-call subsystem in that there is no separate initiator.

- For Iterator Subsystem - Atomic Subsystem block that runs a fixed number of iterations during each model time step. Contains a For Iterator block that controls the number of iterations.

See “Nonvirtual and Virtual Blocks”.

Block Mask

A block mask is a custom block parameter interface that displays only selected block parameters. A mask for a Subsystem block allows you to provide an interface for setting parameters on blocks inside the Subsystem block without having to navigate the model hierarchy.

See “Masking Fundamentals”.

Custom Blocks

Custom blocks are new blocks that extend the built-in functionality of Simulink. You can create libraries of custom blocks to use in your model.

The following blocks define the algorithm of a custom block either graphically with a block diagram or programmatically:

- MATLAB Function - Code a MATLAB function using the MATLAB language that runs in a Simulink model. See “Implementing MATLAB Functions Using Blocks”.
- MATLAB System - Bring existing System objects based on `matlab.System` into Simulink. See “MATLAB System Block”.
- Subsystem - Draw a block diagram representing an algorithm, wrap this diagram in an instance of the Simulink Subsystem block, then provide the block with a parameter dialog using a Simulink block mask. See Subsystem, Atomic Subsystem, CodeReuse Subsystem.
- C Caller - Integrate your external C code into a Simulink model. See “Integrate C Code Using C Caller Blocks”.
- S-Function - Create a custom block programmatically by creating a MATLAB file or a MEX file that contains the block's system functions. The resulting file is called an S-function. You then associate the S-function with instances of the Simulink S-Function block in your model. See S-Function.

See “Types of Custom Blocks”, “Block Authoring and Simulation Integration”.

Lines

A line is a basic modeling construct of the Simulink Editor. Lines connect the output ports of blocks with the input ports of other blocks.

Signal Lines

Signal lines transfer data during a simulation from one block to another block. Signals are time-varying quantities that have values at all points in time (continuous) or at specified time points

(discrete). The source of a signal corresponds to the block that writes to the signal during evaluation of its block output method. The destination of a signal is the block that reads the signal during the evaluation of its block input method.

You can specify signal attributes, including signal name, data type (e.g., double, 32-bit integer), numeric type (e.g., real, complex) and dimension (e.g., one-dimensional, two-dimensional, multi-dimension array). Many blocks can accept or output a signal of any data type or dimensionality. Other blocks impose restrictions on the attributes of the signals they can handle.

During a simulation, save data from a signal by logging the signals.

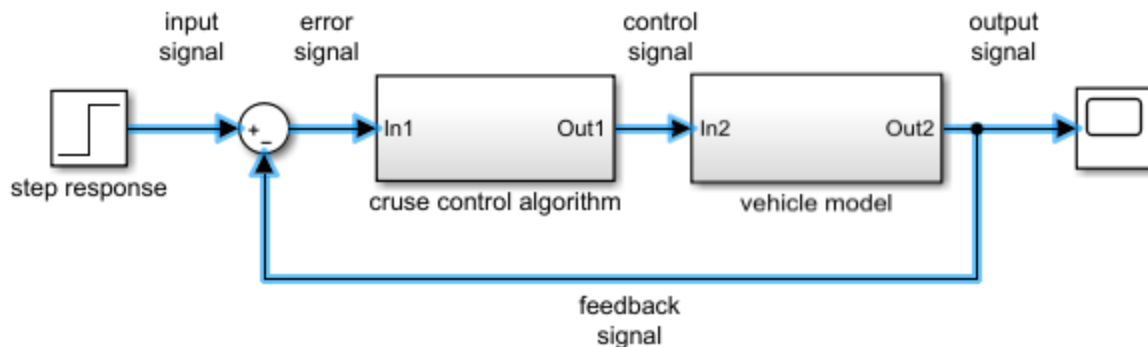

Event Lines

In response to a function-call or action initiator, event lines send an event to a Subsystem or Model block. The block that receives the event executes the blocks within it one or more times during a time step. Function-call initiators include Stateflow charts, Function-Call Generator blocks, S-Function blocks, and Hit Crossing blocks. Action initiators include If and Switch Case blocks.

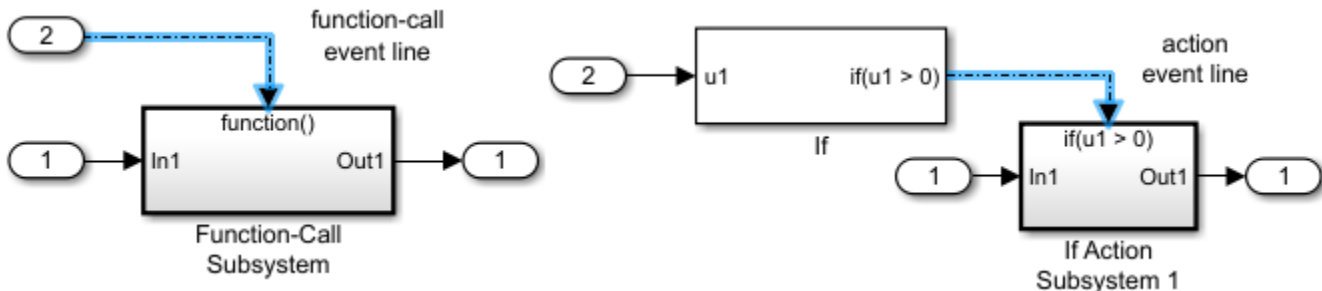

See “Signals” and “Signal Basics”.

Data

Data includes the parameter and input signal values that Simulink uses to produce the output values resulting from simulating the behavior of a model.

Types of data:

- Model parameters - Variables to specify block and signal parameters in a model. Includes MATLAB variables, parameter and signal data objects, data type objects, and bus objects.
- Model configuration parameters - Parameters that determine how your model runs by specifying the settings that control model behavior.

- Simulation data - Input data to drive a simulation and output data generated by a simulation.
- Data Objects - Instances of data classes that allow you to specify characteristics of signals, states, and block parameters. Use the `Simulink.Signal` and `Simulink.Parameter` classes to create data objects. See “Data Objects”.

Location of data:

- **Block parameters** - Use block parameters to directly specify numerical values. You can also enter a variable name and define its value in the Simulink model workspace, a Simulink data dictionary, or the MATLAB base workspace.

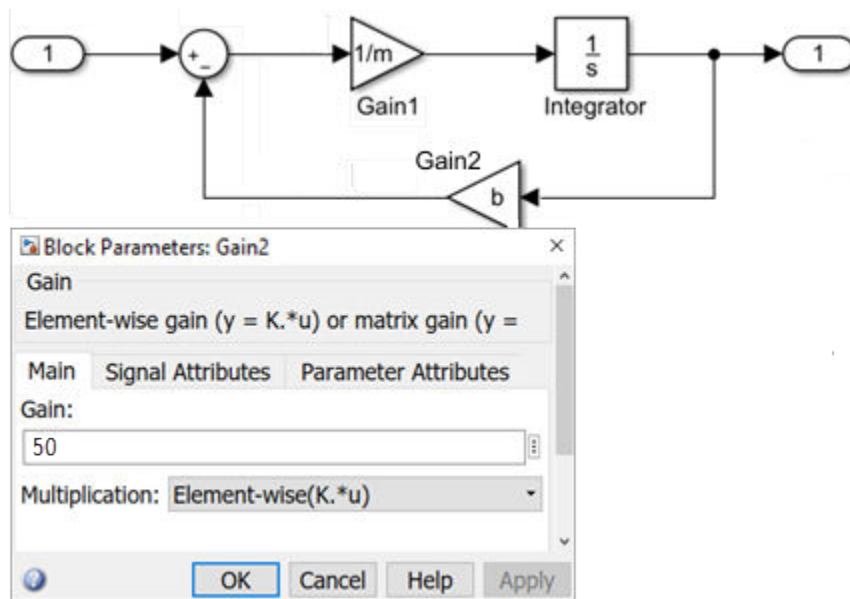

- **MATLAB base workspace** - Use the MATLAB base workspace to save variables that are separate from the model in a MAT-file or MATLAB script.



Simulink treats the base workspace and the data dictionary as a single global name space. If the base workspace and a referenced data dictionary have identical variable names, Simulink uses the variable value in the data dictionary.

The MATLAB base workspace contains variables that are global and visible to all Simulink models.

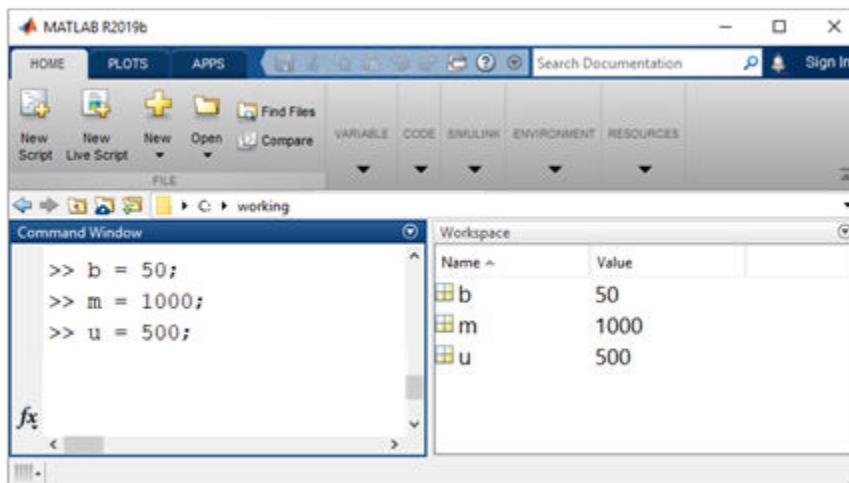

See “Comparison of Signal Loading Techniques”, “Export Simulation Data”.

- **Simulink model workspace** - Use the model workspace to define and store local data variables. Variables defined in a model workspace are visible only within the scope of the model with a unique name space. Therefore, you can use the same variable name in multiple model workspaces and you can assign a unique variable value to the name in each model.

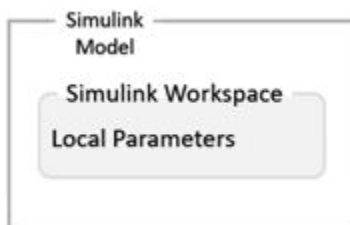

Define variables in the data dictionary using Model Explorer. In the **Modeling** tab, click **Model Explorer** . In the left pane, select Model Workspace.

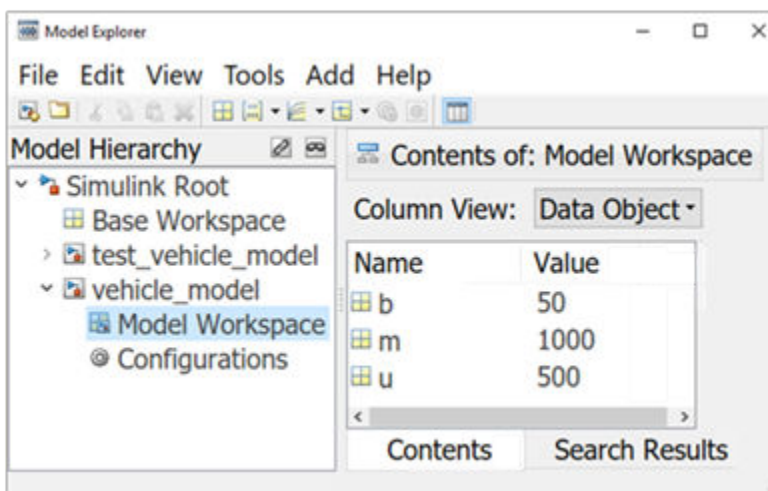

Values for the model workspace variables are initialized from values saved with the model, from a separate MAT-file or MATLAB file, or using MATLAB code saved with the model.

See “Model Workspaces”, “Specify Source for Data in Model Workspace”.

- **Simulink data dictionary** - Use a data dictionary to define and store global data, share data between models, and track changes made to the data. Data is saved in a file separate from the model.



Create a data dictionary file. In the **Modeling** tab, under **Design**, click **Data Dictionary** . Click **New** and enter a file name with an extension `.sldd`.

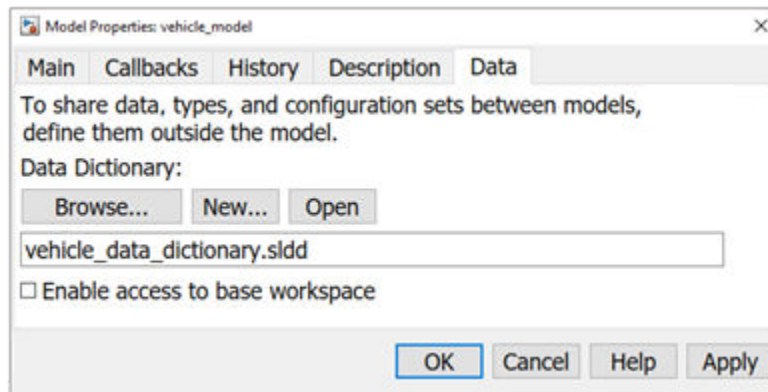

Define variables in the data dictionary using Model Explorer. In the **Modeling** tab, click **Model Explorer** . In the left pane, select **Design Data**.

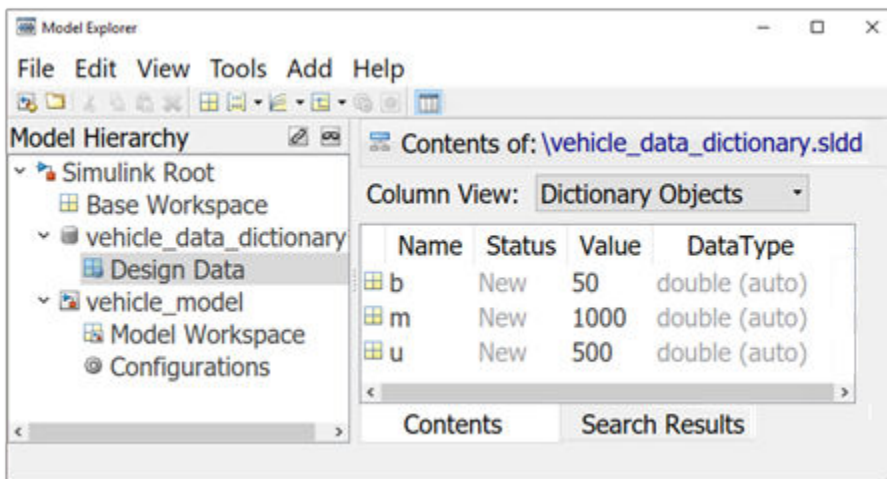

See “What Is a Data Dictionary?”.

- **Imported and exported data** - Import signals for a simulation from the MATLAB base workspace, a MAT-file, or a spreadsheet. Create input signals using a source block or the Signal Editor block. Use signal logging to export simulation results. Signals are saved as vectors [t, X, Y] for time, state and output at each major time step.

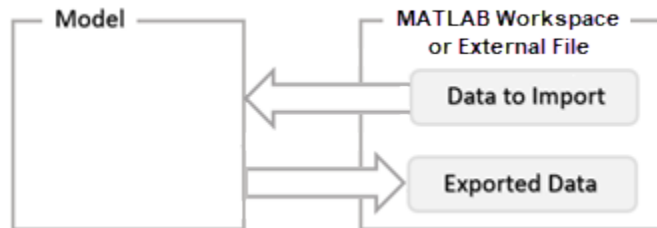

See also: “Determine Where to Store Variables and Objects for Simulink Models”, “Symbol Resolution”.

Parameters

Parameters are Simulink model characteristics that affect the simulation and code generation result.

Model Configuration Parameters

Model configuration parameters specify model behavior during compilation, simulation, and code generation, such as the solver to use and the types of errors and warnings to display.

To specify model configuration parameters, in the **Modeling** tab, click **Model Settings**. The Configuration Parameters dialog box opens.

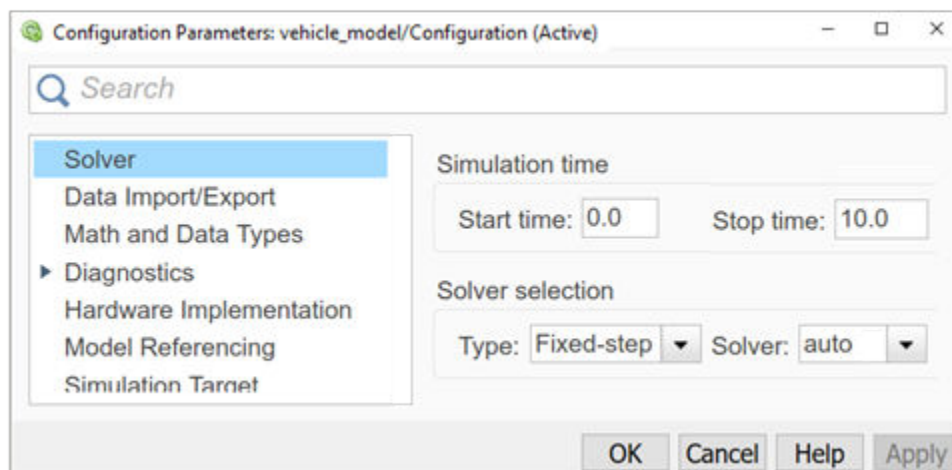

See “Set Model Configuration Parameters for a Model”.

Block Parameters

Block parameters define model dynamics and mathematics. Whether a block has parameters that you can set and the nature of those parameters is specific to each block. To specify block parameters, open the block parameter dialog box, or in the **Modeling** tab, under **Design**, click one of the following:

- **Property Inspector** – Specify block parameters directly or enter a variable name for a parameter value.
- **Model Data Editor** – Specify block parameters with variables.
- **Model Explorer** – Specify block parameters with variables.

See “Set Block Parameter Values”.

Block Parameter Variables

If you have a single parameter used in many locations across a large model, updating every instance of that parameter can be a difficult task. Instead, enter a variable name as the value of a parameter, then define the variable once using one of the following methods:

- **Simulink Model Workspace** – Create model workspace variables and assign values to the variables. The parameters you define are specific to the model and saved with the model. Use a MATLAB variable for ease of maintenance. Use a `Simulink.Parameter` object to control additional properties including data type, dimensions, and units. See “Edit and Manage Workspace Variables by Using Model Explorer”.
- **Simulink Data Dictionary** – Create design data variables in a data dictionary and link the dictionary to a model. During model simulation, Simulink retrieves data from the data dictionary.
- **MATLAB Base Workspace** – In the MATLAB base workspace, define parameters using any MATLAB mechanism for defining a variable. For example, you can use a MAT-file and load the variables when you open the model. Use MATLAB expressions to specify parameter variable values. Simulink evaluates the expressions before running a simulation. See “Save and Load Workspace Variables”.

Using the MATLAB base workspace or a Simulink data dictionary to define variables is useful when you are using the same set of parameters for more than one model. This mechanism also allows you to use different sets of parameter values for the same model.

See also: “Share and Reuse Block Parameter Values by Creating Variables”, “Create, Edit, and Manage Workspace Variables”.

Model Argument and Instance Parameters

When you reference the same model from multiple Model blocks, you create instances of the model. You can set block parameters to use the same value or a different value for each instance of the model.

To use different values,

- 1 In the model workspace for the referenced model, create a MATLAB variable or `Simulink.Parameter` object.
- 2 Enter a parameter name and a default parameter **Value**. Select the **Argument** check box to create a model argument.
- 3 For a block in the referenced model, enter the name of the model argument for the value of a block parameter.
- 4 For each Model block, open the block parameters dialog box, select the **Instance parameters** tab, and enter a value for the instance parameter with the model argument name.

See also: “Parameterize Instances of a Reusable Referenced Model”.

Tunable Block Parameters

You can change the value of a tunable block parameter during a simulation. This allows you to determine interactively the most suitable value for a parameter. When you change the value of a tunable parameter, the change takes effect at the start of the next time step. For example, the gain parameter of the Gain block is tunable. You can change the block gain while a simulation is running. See “Tune and Experiment with Block Parameter Values”.

Setting Block Parameters with the Property Inspector

To specify parameters, in the **Modeling** tab, under **Design**, click **Property Inspector**. Click a block to display the block parameters and properties.

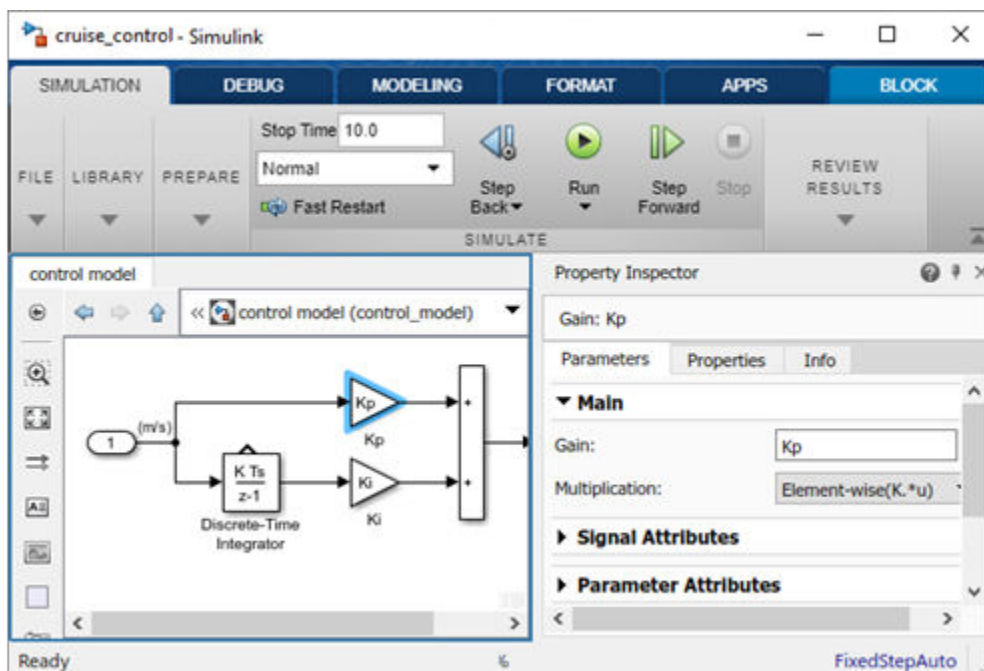

See also: “Specify Block Properties”.

Properties

Properties are Simulink model characteristics that generally do not affect the simulation result. To specify properties, in the **Modeling** tab, under **Design**, click **Property Inspector**.

Model Properties

With the Property Inspector opened, click a blank space within a block diagram, or in the **Modeling** tab, select **Model Settings > Model Properties**. Model properties include:

- General - Name and location of model file.
- Design Data - Variables defined outside the model that parameterize the model and its blocks and signals.
- Callbacks - Commands that execute when a specific model event occurs.

See “Manage Model Versions and Specify Model Properties”.

Block Properties

With the Property Inspector opened, select a block, then select the **Properties** tab. Block properties include:

- Block Annotation - Values of selected block parameters displayed below the block.
- Callbacks - Commands that execute when a specific block event occurs. For example, you can set up a MATLAB script to load and define block parameter variables using expressions.
- Priority - Set the relative execution order of blocks. A lower value executes the block before a larger priority value.
- Tags - Block identifiers that are programmatically searchable.

Port Properties

With the Property Inspector opened, select a port, then select the **Properties** tab. You can modify properties of port objects, signals, and port blocks with the Property Inspector. The ports on a subsystem block also have a port block tab, which contains properties of the associated port block.

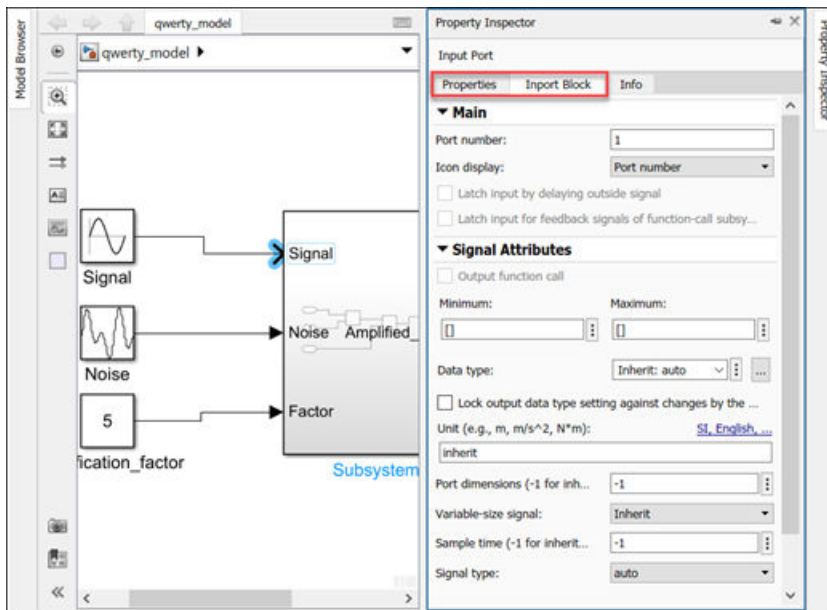

- The port block properties are displayed for these subsystem blocks:
 - Subsystem, Atomic Subsystem, CodeReuse Subsystem
 - Variant Subsystem, Variant Model
 - For Each
 - For Iterator Subsystem
 - Function-Call Feedback Latch
 - Function-Call Subsystem
 - Function-Call Generator
 - Function-Call Split
 - If

- While Iterator Subsystem
- The ports on these blocks show a tab with the same name as the type of port block and list the properties that are shown in the Model Explorer window. For example, an **EnablePort Block** tab is shown for ports on an Enable block, and **Data**, **Message**, or **Event** tabs are shown for ports on Stateflow blocks.
- Enable block
- Trigger block
- Function Call block
- Reset block
- Action Port block
- Chart
- Truth Table
- State Transition Table
- Test Sequence
- matlabFunctionBlock

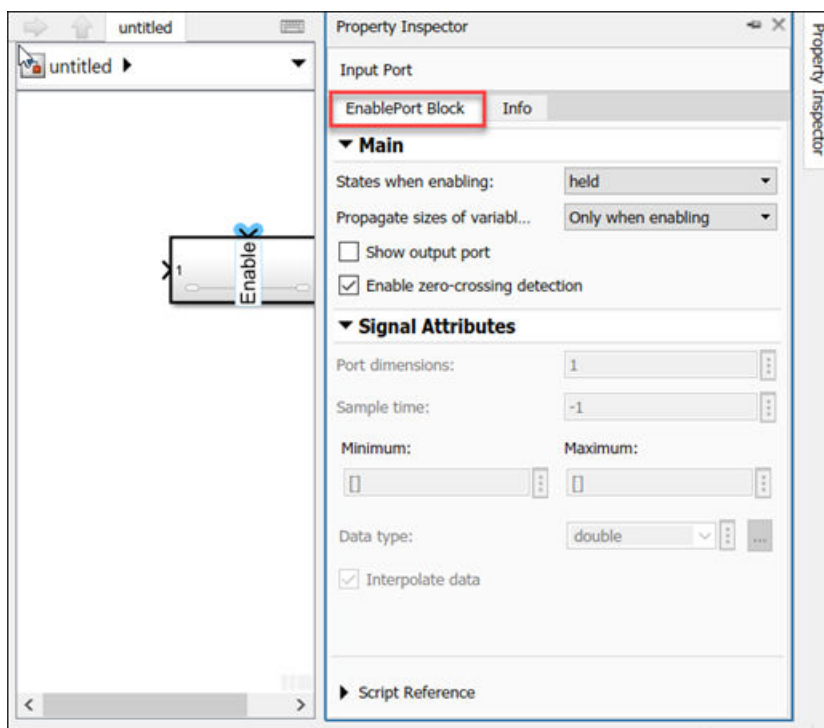

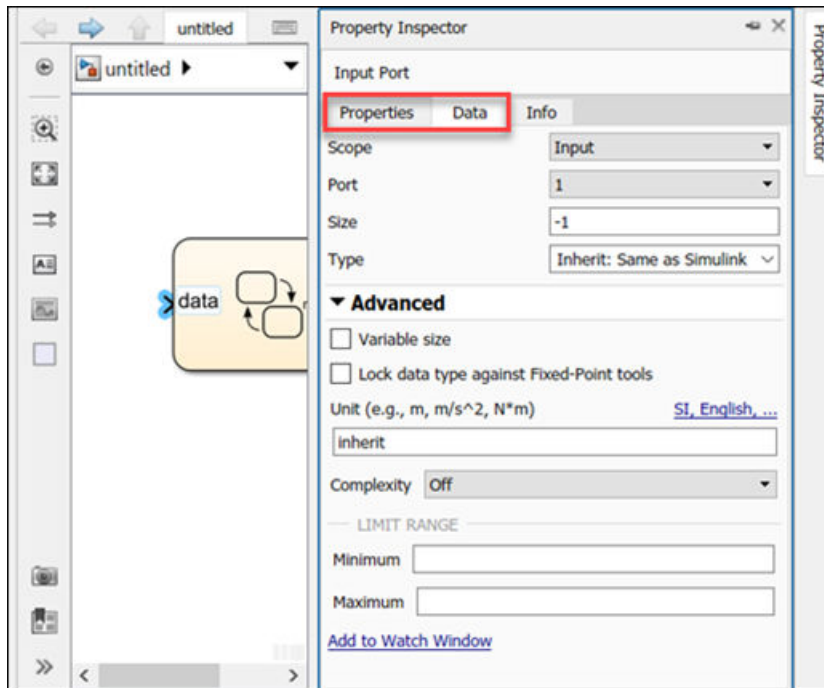

- The port properties of read-only blocks are not editable. For example, the port properties of locked linked library blocks, masked blocks, and protected referenced models are read-only.
- The port block properties on Model blocks are shown only if the model is loaded.

Setting Model and Block Properties with Property Inspector

To set properties, in the **Simulation** tab, under **Prepare**, click **Property Inspector**. Click an empty space to display the model properties. Click a block to display the block properties.

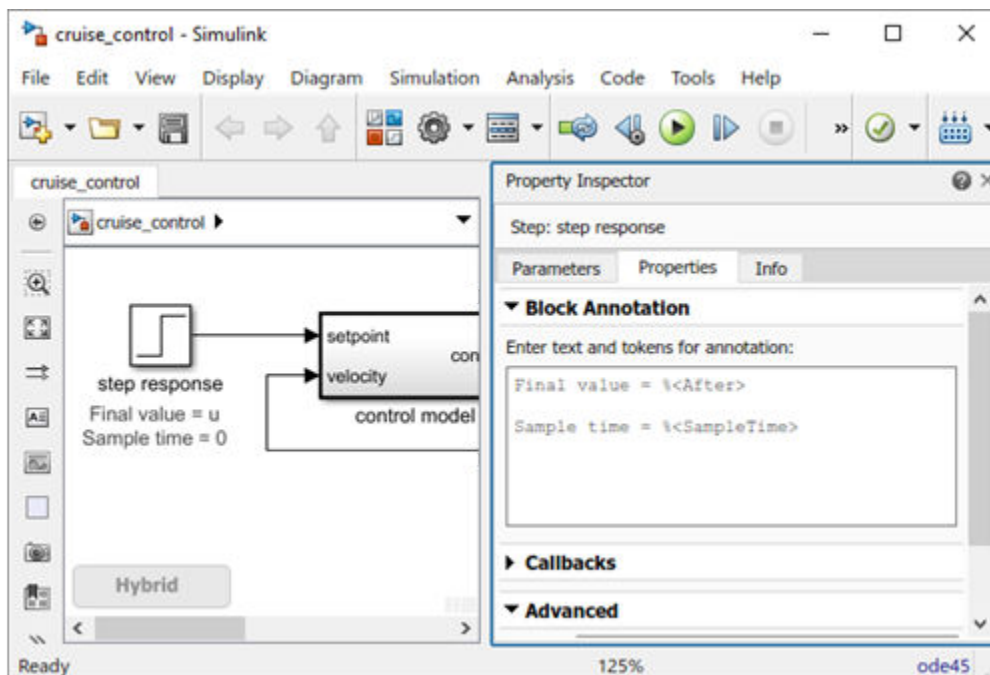

See also: “Specify Block Properties”, “Callbacks for Customized Model Behavior”.

State variables

The state of a model is defined by the values of its state variables. State variables are the set of variables whose values at time zero, along with the values of model inputs and the model equations, can determine the behavior of a model during a simulation. Examples of state variables include motor position and velocity, inductor current, capacitor voltage, solution temperature, and gas pressure.

If the current output value of a block is a function of the previous output value, the block defines a state variable that needs to be saved between time steps. Computing a block output hence entails saving the value of the state variable at the current time step for use in computing the output at a subsequent time step.

Working with States

The following facilities are provided for determining, initializing, and logging model states during simulation:

- The **Data Import/Export** pane of a model's Configuration Parameters dialog box (see “State Information”) allows you to specify initial values for model states, and to record the values of the states at each time step during simulation as an array or structure variable in the MATLAB workspace.

Open the Configuration Parameters dialog box. Select the **States** check block for logging to the MATLAB variable `xout`.

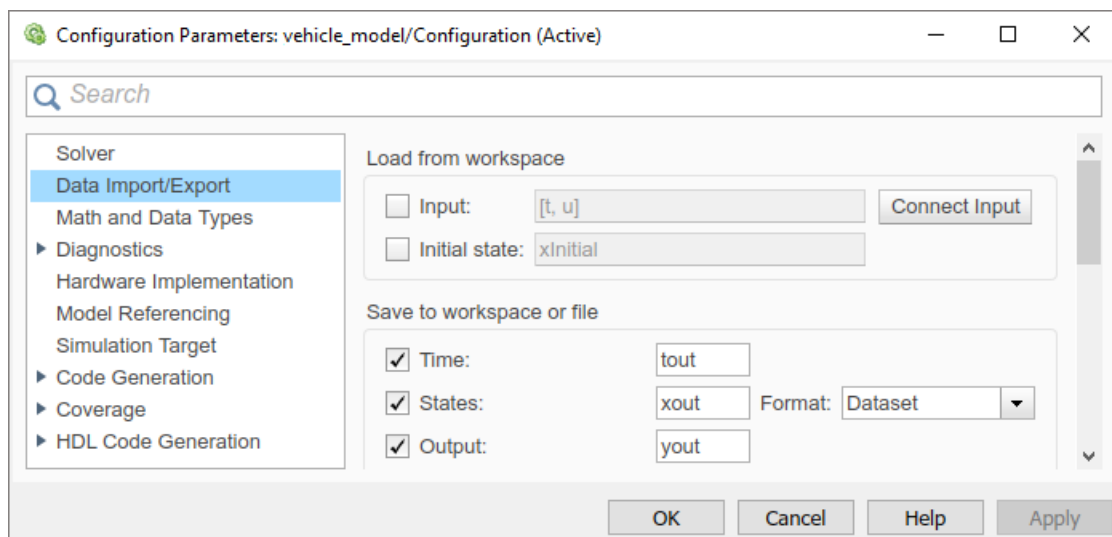

In the MATLAB Command Window, list the logged values for state of the Integrator block at each time step.

```
>> xout{1}.Values.Data
ans =
    0.0000
    1.8127
```

```
3.2968
4.5119 . . .
```

- The `model` command displays information about the states defined by a model, including the total number of states and the block that defines each state with its initial value.

List blocks in the model `vehicle_model` with states. In the MATLAB Command Window, enter the model function, then list blocks with states.

```
[sys,x0,str,ts] = vehicle_model([],[],[],'sizes')
str =
    {'vehicle_model/Integrator'}
```

- The Simulink debugger displays the value of a state at each time step during a simulation, and the Simulink debugger's `states` command displays information about the model's current states (see "Simulink Debugger").

In the MATLAB Command Window, start the Simulink debugger, then enter the command `states`.

```
sldebug 'vehicle_model'
(sldebug @0): >> states
```

```
Continuous States for 'vehicle_model':
Idx Value (system:block:element Name 'BlockName')
0. 0 (0:0:0 CSTATE 'vehicle_model/Integrator')
```

- The Block Parameters dialog box (and the `ContinuousStateAttributes` parameter) allows you to give names to states for those blocks (such as the Integrator) that employ continuous states. This can simplify analyzing data logged for states, especially when a block has multiple states.

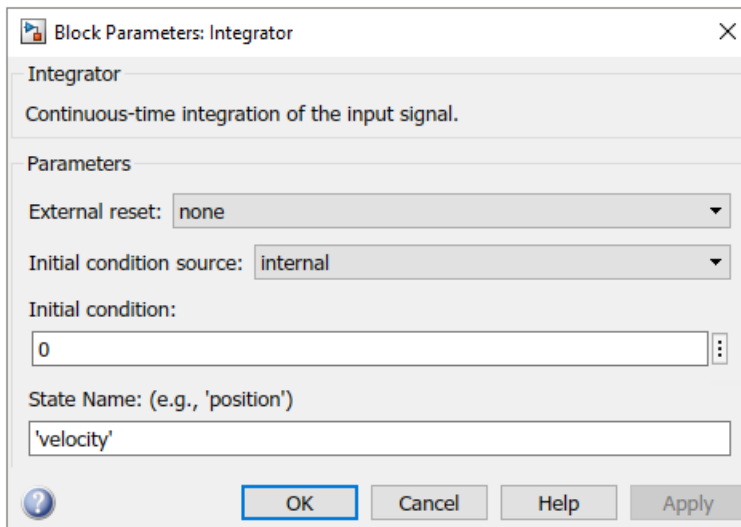

Continuous States

A continuous state is defined for all values of time. An example of a continuous state would be the speed of a car shown on an analog speedometer with a needle position that changes continuously with the rotation of a tire.

Blocks with continuous states and the block parameter **Initial condition** include:

- Integrator

- State-Space
- Transfer Fcn

In general, excluding simple models, analytical methods do not exist for integrating states represented by ordinary differential equations. Integrating the states requires the use of numerical methods.

Discrete States

A discrete state is defined only at specific times. It is an approximation of a continuous state where the state is updated at periodic or aperiodic time intervals. An example of a discrete state would be the speed of a car shown on a digital speedometer that is updated every second as opposed to continuously.

Blocks with discrete states include:

- Discrete-Time Integrator
- Discrete State-Space
- Discrete Transfer Fcn
- Delay

Computing the discrete state for a block requires knowing its value at the previous time step and also the current input value to the block. Simulink provides two types of discrete solvers:

- Fixed-step discrete solver - determines a fixed step size that hits all the sample times for all the model's discrete states, regardless of whether the states actually change value at the sample time hits.
- Variable-step discrete solver - varies the step size to ensure that sample time hits occur only at times when the states change value.

Modeling Hybrid Systems

A hybrid model has both continuous and discrete states. Solving such a model entails choosing a step size that satisfies both the precision constraint on the continuous state integration and the sample time interval constraint on the discrete states. Simulink meets this requirement by passing the next sample time interval for the discrete solver as an additional constraint on the continuous solver. The continuous solver chooses a step size that advances the simulation up to but not beyond the time of the next discrete sample time. The continuous solver can take a time step short of the next sample time hit to meet its accuracy constraint but it cannot take a step beyond the next sample time hit even if its accuracy constraint allows it to.

You can simulate hybrid systems using any of the integration methods, but certain methods are more effective than others. For most hybrid systems, `ode23` and `ode45` are superior to the other solvers in terms of efficiency. Because of discontinuities associated with the sample and hold of the discrete blocks, do not use the `ode15s` and `ode113` solvers for hybrid systems.

Sample Time

Sample time is the time interval that specifies the rate ($1 / \text{sample time}$) for executing block methods to produce outputs and update the internal states of blocks. Time is an inherent component of a block diagram in that the simulation results of a block diagram change with time.

Sample time is specified as:

- Continuous - Blocks run at variable times based on solver settings.
- Discrete - Blocks run at specific times that are explicitly specified.

In the following example, the controller runs at a discrete rate specified with a sample time of 0.01 seconds while Simulink determines the vehicle model to have a continuous sample time.

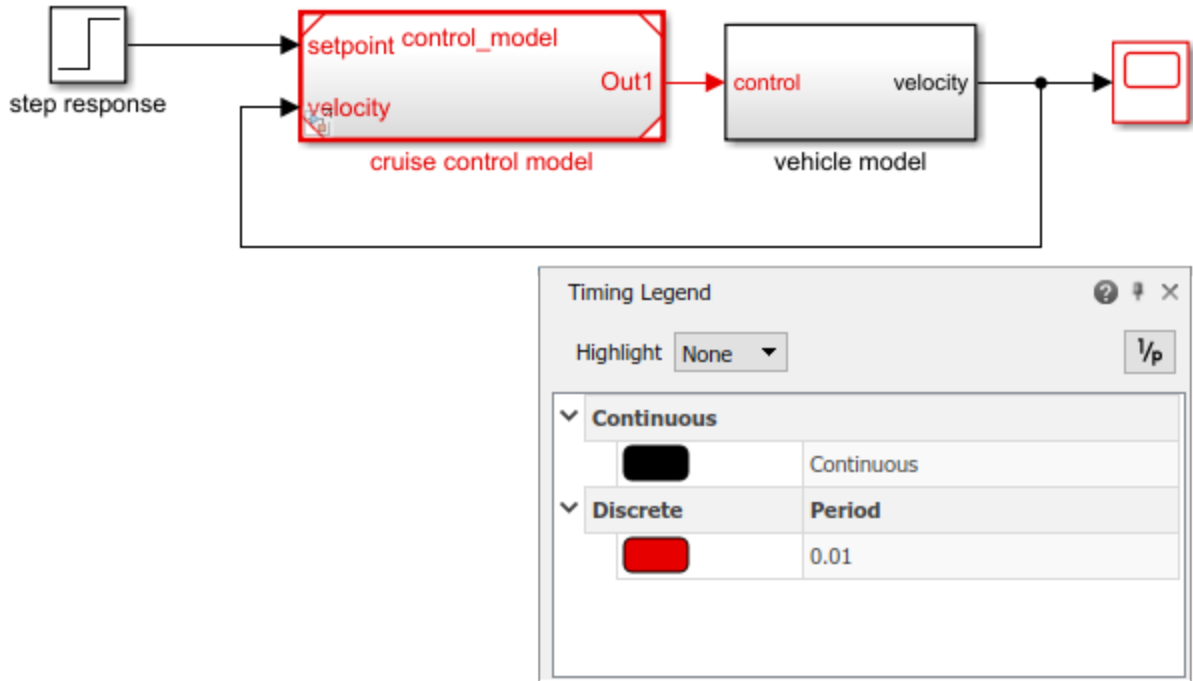

Determining a system's behavior over time thus entails repeatedly solving the model at intervals, called time steps or time intervals, from the start of the time span to the end of the time span. The process of solving a model at successive time steps is referred to as simulating the system that the model represents.

See also “What Is Sample Time?”, “Types of Sample Time”, “Specify Sample Time”, “View Sample Time Information”.

Block Sample Times

Every Simulink block has a sample time which defines when the block will execute. Most blocks allow you to specify the sample time via a SampleTime parameter. Common choices include discrete, continuous, and inherited sample times.

| Common Sample Time Types | Sample Time | Examples |
|--------------------------|--------------|----------------------------|
| Discrete | $[T_s, T_o]$ | Unit Delay, Digital Filter |
| Continuous | $[0, 0]$ | Integrator, Derivative |
| Inherited | $[-1, 0]$ | Gain, Sum |

For discrete blocks, the sample time is a vector $[T_s, T_o]$ where T_s is the time interval or period between consecutive sample times and T_o is an initial offset to the sample time. In contrast, the sample times for nondiscrete blocks are represented by ordered pairs that use zero, a negative

integer, or infinity to represent a specific type of sample time. For example, continuous blocks have a nominal sample time of $[0, 0]$ and are used to model systems in which the states change continuously (e.g., a car accelerating), whereas you indicate the sample time type of an inherited block symbolically as $[-1, 0]$, and Simulink then determines the actual value based upon the context of the inherited block within the model.

Note that not all blocks accept all types of sample times. For example, a discrete block cannot accept a continuous sample time.

For a visual aid, Simulink allows the optional color-coding and annotation of any block diagram to indicate the type and speed of the block sample times. You can capture all of the colors and the annotations within a legend (see “View Sample Time Information”).

For a more detailed discussion of sample times, see “Sample Time”.

Units

Units are used to measure the total amount of a quantity.

Simulink units are specified as an Inport block or Outport block parameter at the boundaries of a Simulink model component. Simulink model components include Subsystem blocks, Model blocks, Stateflow charts, and Simulink to Simscape converter blocks. To display units on a model, in the **Debug** tab, select **Information Overlays > Units**.

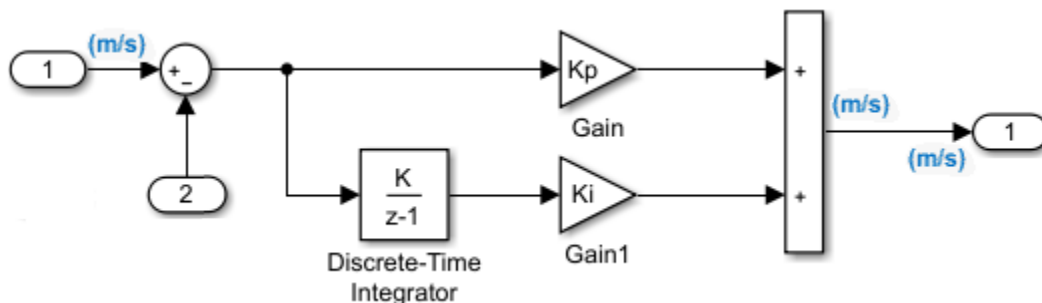

See also: “Unit Specification in Simulink Models”, “Converting Units”.

Direct Feedthrough

Direct feedthrough is where the output port signal of a block is computed from the values of its input port signals. The output signal value is a function of the input signal values.

Blocks with direct feedthrough include the Gain, Product, Sum, and Math Function blocks.



Algebraic Loop

A signal loop between blocks with direct feedthrough is called an algebraic loop. An algebraic loop generally occurs when an input port of a block with direct feedthrough is driven directly by the output port of the same block or indirectly through other blocks with direct feedthrough.

In the following model, the two Gain blocks with direct feedthrough create an algebraic loop:

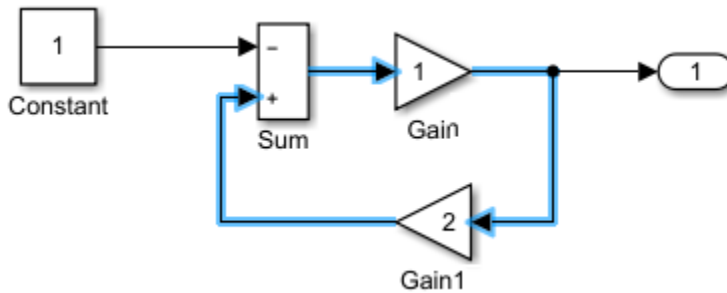

See also: “Algebraic Loop Concepts”.

Artificial Algebraic Loops

An *artificial algebraic loop* occurs when an atomic subsystem or Model block causes Simulink to detect an algebraic loop, even though the contents of the subsystem do not contain a direct feedthrough from the input to the output. When you create an atomic subsystem, all Inport blocks are direct feedthrough, resulting in an algebraic loop.

Start with the included model, which represents a simple proportional control of the plant described by

$$G(s) = \frac{1}{s^2 + 2s + 1}$$

which can be rewritten in state-space form as

$$\dot{x} = \begin{bmatrix} -2 & -1 \\ 1 & 0 \end{bmatrix} x + \begin{pmatrix} 0 \\ 1 \end{pmatrix} u$$

$$y = [0 \quad 1] x$$

The system has neither algebraic variables nor direct feedthrough and does not contain an algebraic loop.

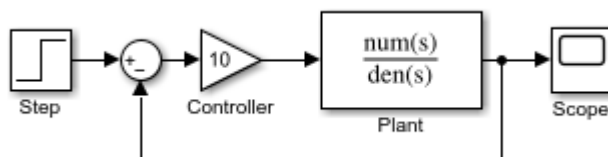

Modify the model as described in the following steps:

- 1 Enclose the Controller and Plant blocks in a subsystem.
- 2 In the subsystem dialog box, select **Treat as atomic unit** to make the subsystem atomic.
- 3 In the **Diagnostics** pane of the Model Configuration Parameters, set the **Algebraic Loop** parameter to error.

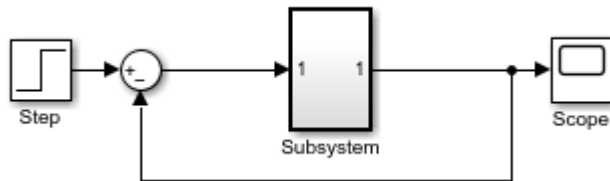

When simulating this model, an algebraic loop occurs because the subsystem is direct feedthrough, even though the path within the atomic subsystem is not direct feedthrough. Simulation stops with an algebraic loop error.

Zero-Crossing Detection

Simulink uses a technique known as zero-crossing detection to accurately locate a discontinuity without resorting to excessively small time steps during a simulation. Usually this technique improves simulation run times.

Simulink Simulation

Simulating the model of a dynamic system allows you to gain insight about the behavior of a proposed system design without the time consuming process of actually building the system. The concepts in this topic provide a context for understanding how to control a model simulation with Simulink software tools.

Compilation

Compilation is the Simulink process where the block diagram is translated to an internal representation that interacts with the Simulink engine.

There are no model-level sets of differential equations that are solved numerically as a whole. Instead, the model-level equations correspond to the individual block equations that are solved numerically in a specific order.

Block Methods

The functionality of a single block is defined by multiple equations. These equations are represented as block methods. These block methods are evaluated (executed) during the execution of a block diagram. The evaluation of these block methods is performed within a simulation loop, where each cycle through the simulation loop represent the evaluation of the block diagram at a given point in time. Common block methods include:

- Derivative - Computes the derivatives of the block's continuous states at the current time step, given the block inputs and the values of the states at the previous time step.
- Update - Computes the value of the block's discrete states at the current time step, given its inputs at the current time step and its discrete states at the previous time step.
- Output - Computes the outputs of a block given its inputs at the current time step and its states at the previous time step.

$$\left\{ \begin{array}{ll} X = [x_c, x_d] & \text{Model states} \\ \dot{x}_c = f_c(X, U, t) & \text{Derivative method} \\ x_d[n + 1] = f_d(X, U, t) & \text{Update method} \\ Y = [y_1, y_2] & \\ Y = g(X, U, t) & \text{Output method} \end{array} \right.$$

$$X(t_0) = X_0 \quad \text{Initial model states}$$

Model Method

In addition to block methods, a set of methods is provided that compute the model properties and its outputs. The Simulink software similarly invokes these methods during simulation to determine a model's properties and its outputs. The model methods generally perform their tasks by invoking block methods of the same type. For example, the model Outputs method invokes the Outputs methods of the blocks that it contains in the order specified by the model to compute its outputs. The model Derivatives method similarly invokes the Derivatives methods of the blocks that it contains to determine the derivatives of its states.

See also: "Simulation Phases in Dynamic Systems".

Callback

Callbacks are MATLAB expressions that execute in response to a specific modeling action. Simulink provides model, block, and port callback parameters that identify specific kinds of modeling actions. You provide the code for callback parameters. Simulink executes the callback code when the associated modeling action occurs.

Model Callback

Model callback parameters include:

- `PreloadFcn` - Executes before a model loads. For example, you can provide code that loads the variable values a model uses into the MATLAB workspace.

See “Model Callbacks”.

Block Callback

Block callback parameters include:

- `OpenFcn` - Execute when you open a Subsystem block.
- `LoadFcn` - Execute after a diagram is loaded. For a Subsystem blocks, also execute block callback parameters for the blocks within Subsystem block.

Port Callback

Port callback parameter:

- `ConnectionCallback` - Execute code every time the connectivity of a port changes.

See “Port Callbacks”.

Execution Order

The Execution order is the sequence in which block output methods are called after evaluating direct feedthrough of each input port. To display execution order, in the **Debug** tab, select **Information Overlays > Execution Order**.

In the following model, the Integrator block output runs first, and then the loop of blocks connected to the Integrator block input. Missing execution numbers in a sequence are usually due to so-called “hidden buffer” blocks; see “Ensure Outputport is Virtual”.

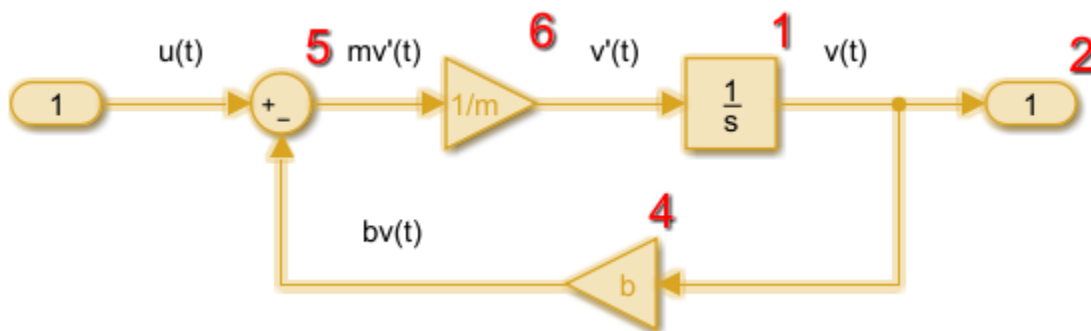

See also: “Control and Display Execution Order”, “Simulation Phases in Dynamic Systems”.

Simulation

Simulation is the process after model *compilation* where block method outputs and states are computed at successive time steps over a specified time range using a numerical solver.

During each simulation loop, Simulink calculates a Δt to determine the time step $t(k+1) = t(k) + \Delta t$. The size of Δt is based on an estimated error between the simulated solution and the actual solution. At the end of a simulation, data results are given as vectors $[t, X, Y]$ for time, state and output at each time step.

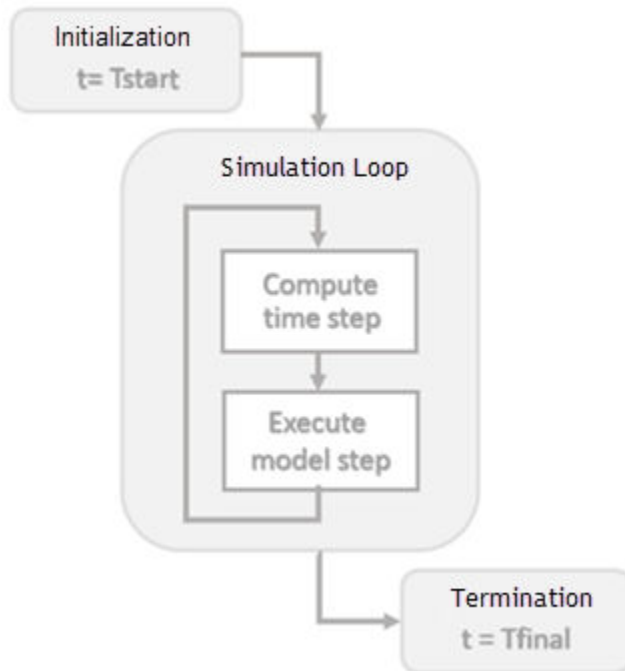

See also: “Simulation Phases in Dynamic Systems”, “Simulate a Model Interactively”, “Speed Up Simulation”.

Solver

A Solver finds an approximate solution for a set of model equations. Simulink uses established numerical solvers for this task.

Solver step size can be fixed or variable:

- Fixed step - Time step $T(k+1) = T(k) + \Delta t$ where Δt is constant. If step size is too large, simulation results can have a large error. In the following example, a step size of 2 distorts the shape of a sine wave signal. You can specify the size of the time step in the case of fixed-step solvers, or the solver can automatically determine the step size in the case of variable-step solvers.

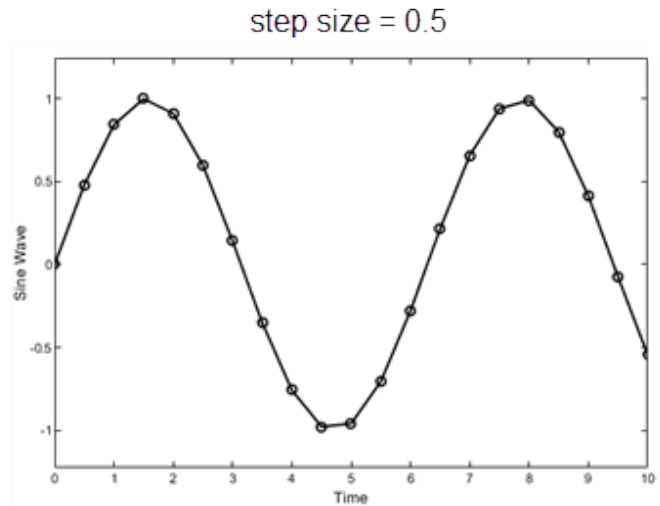
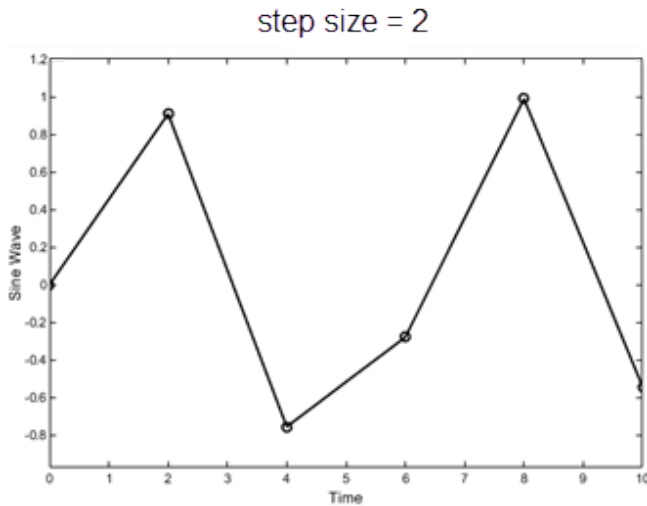

- Variable step - Variable step solvers iterate to reach a solution based on an error tolerance. Time step $T(k+1) = T(k) + \Delta t_k$ where Δt_k changes from one simulation step to the next depending on the estimated error. Smaller time steps increase the accuracy of the simulation results. To minimize the computation workload, a variable-step solver chooses the largest step size consistent with achieving an overall level of precision specified by the error tolerance and observing zero-crossings. This ensures that all model states are computed to the accuracy specified by the user.

Choosing a solver method depends on the nature of the model equations. Euler's method is a simple numerical solver that calculates the next value of y by using the slope (y') of a tangent line to y . If y is a function that integrates a ramp function x with a slope of 1, $y' = x$, and a numerical solver would use the following equations.

$$x[n+1] = x[n] + \Delta t * 1$$

$$y[n+1] = y[n] + \Delta t * x[n+1]$$

Decreasing the step size increases the accuracy of the results. but it increases the time to complete a simulation. In the following example, a step size of 2 shows an error of about 20 percent after 10 seconds while a step size of 0.5 produces a result that is closer to the actual solution.

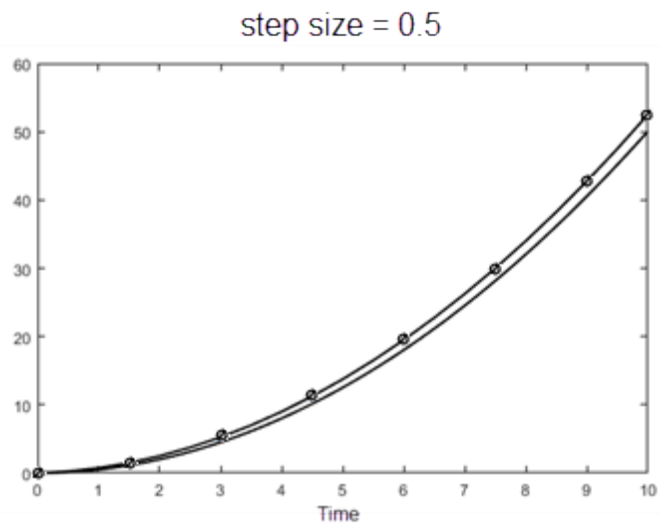
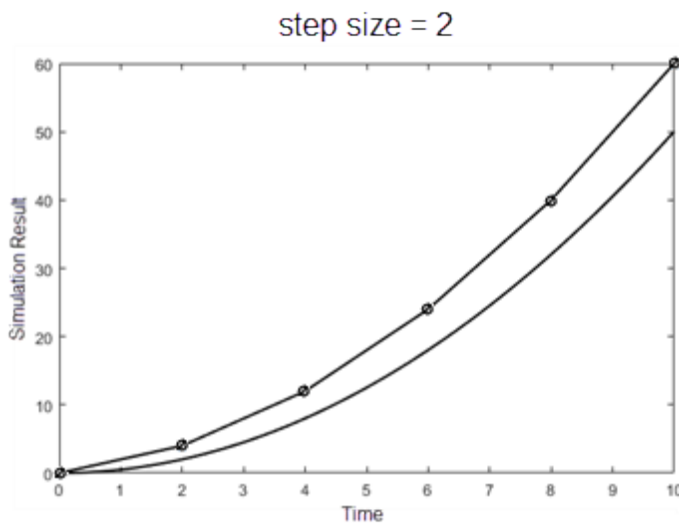

See also: "Simulation Phases in Dynamic Systems", "Compare Solvers", "Check and Improve Simulation Accuracy", "Choose a Solver".

.

Simulink Tools

Code Generation Advisor - Simulink tool that checks a model for how objectives such as efficiency, traceability, and safety, map to code generation options in a model configuration set. To open and run the advisor, in the **Modeling** tab, click **Model Advisor**, and then click **Code Generation Advisor**.

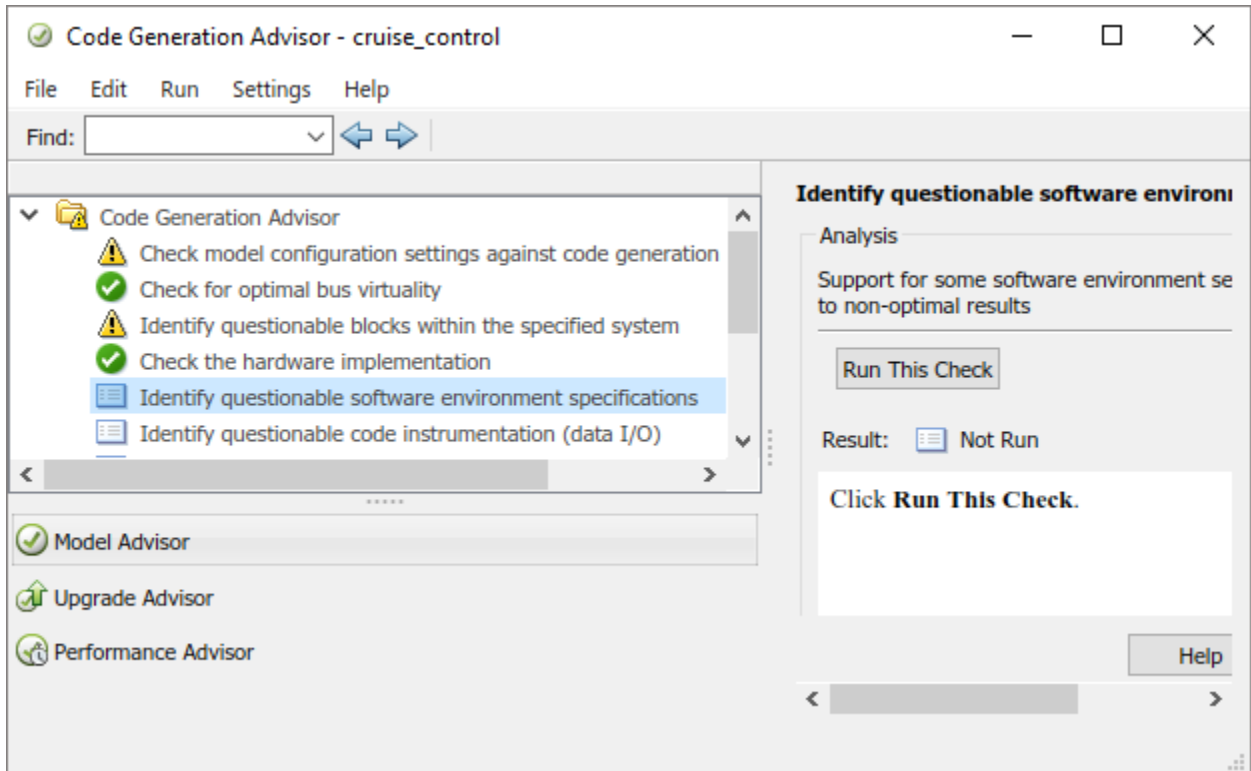

Configuration Parameter dialog - Simulink tool to select and specify *model parameters*. To open the dialog box, in the **Simulation** tab, under **Configuration & Simulation**, click **Model Settings**.

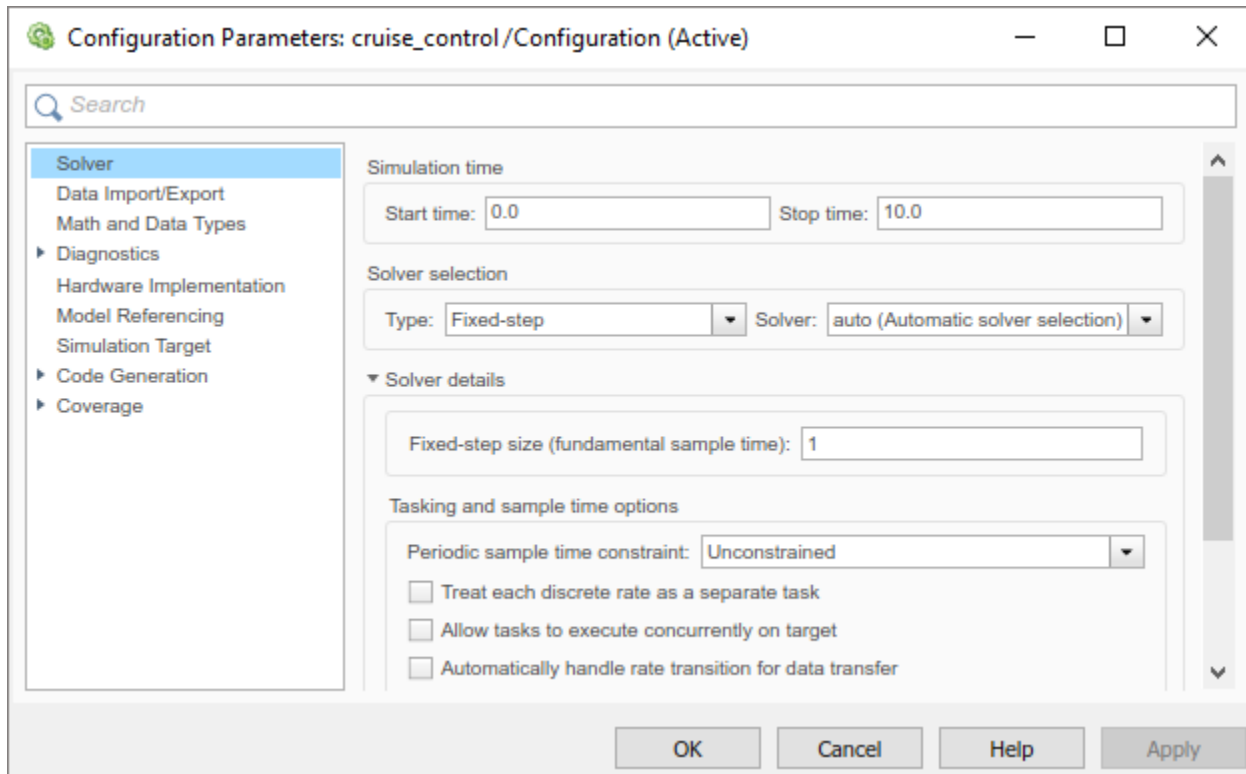

Performance Advisor - Simulink tool that checks for conditions that might slow down a simulation. The advisor can automatically make changes to a model to address these conditions or you can review and apply suggested changes manually. To open the advisor, in the **Debug** tab, click **Performance Advisor**.

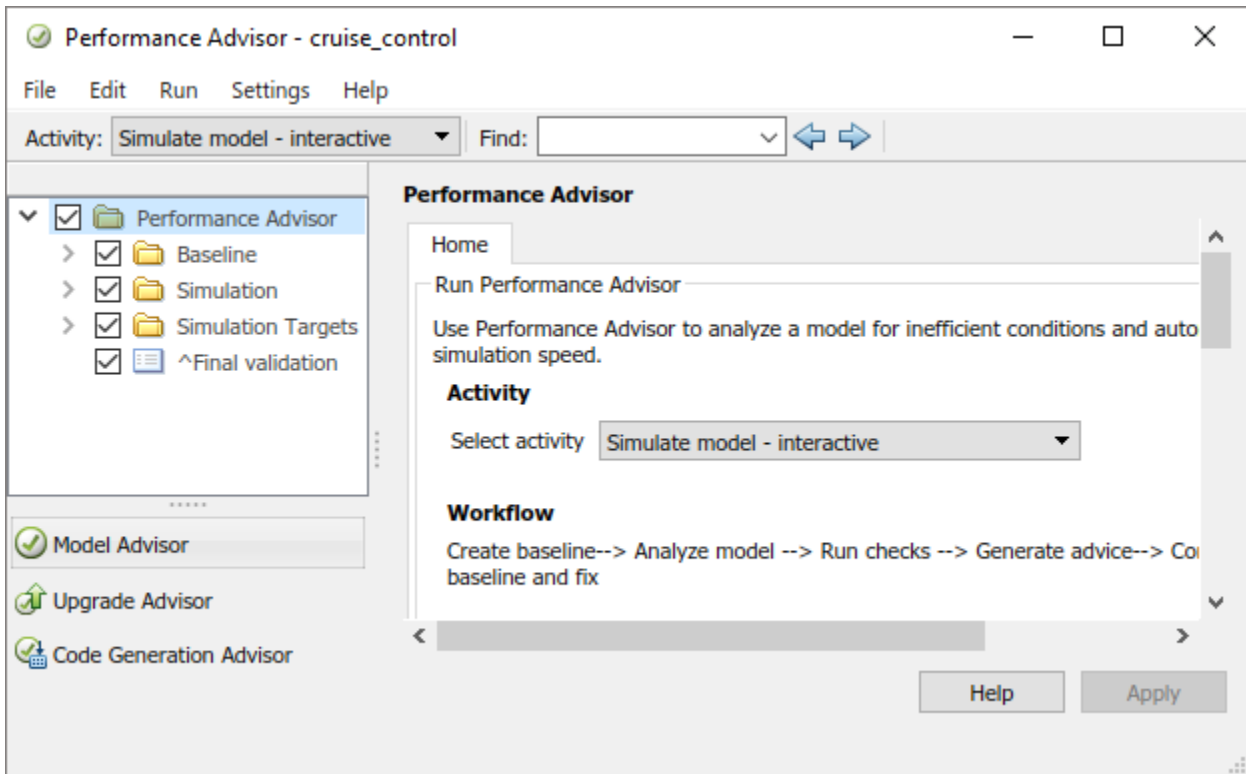

Property Inspector - Simulink tool to define and edit parameters and properties for models and blocks. To open the inspector in a Simulink Editor pane, in the **Modeling** tab, under **Design**, click **Property Inspector**.

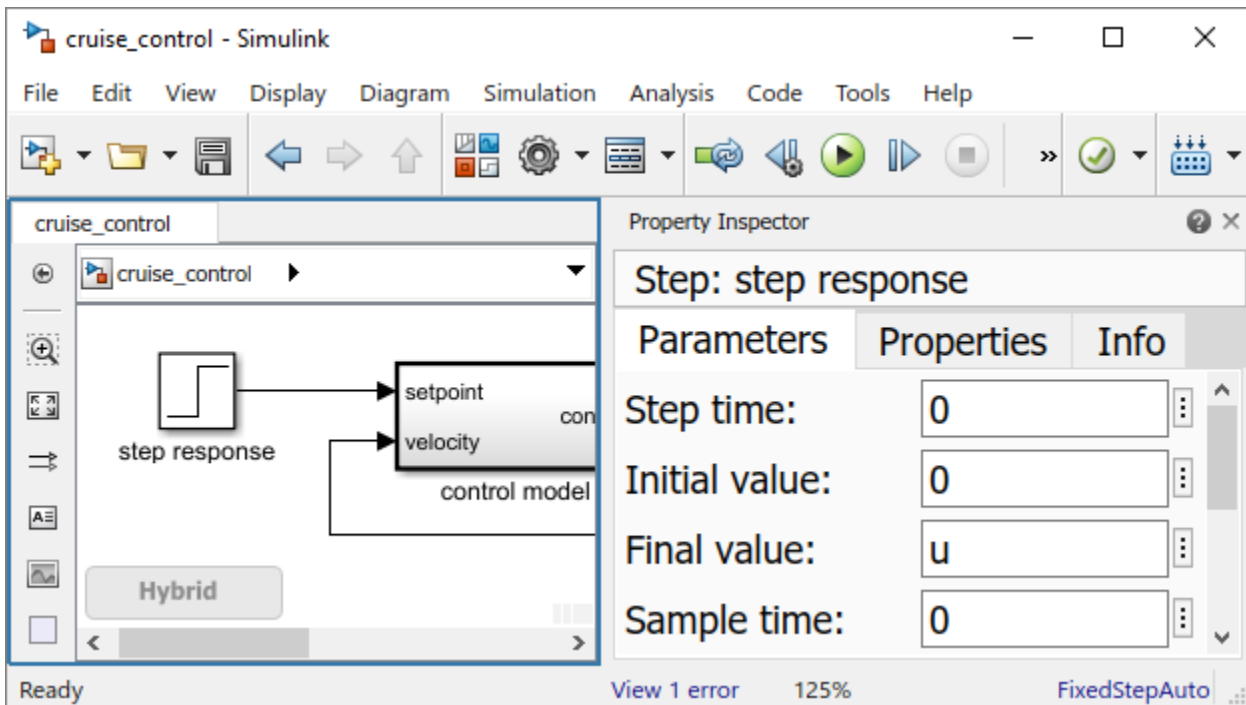

Simulation Data Inspector - Simulink tool to visualize simulation results and compare results from multiple simulations. Select signals to log by right-clicking a signal and then selecting **Log Selected Signals**. After running a simulation, open the inspector by clicking the toolbar icon .

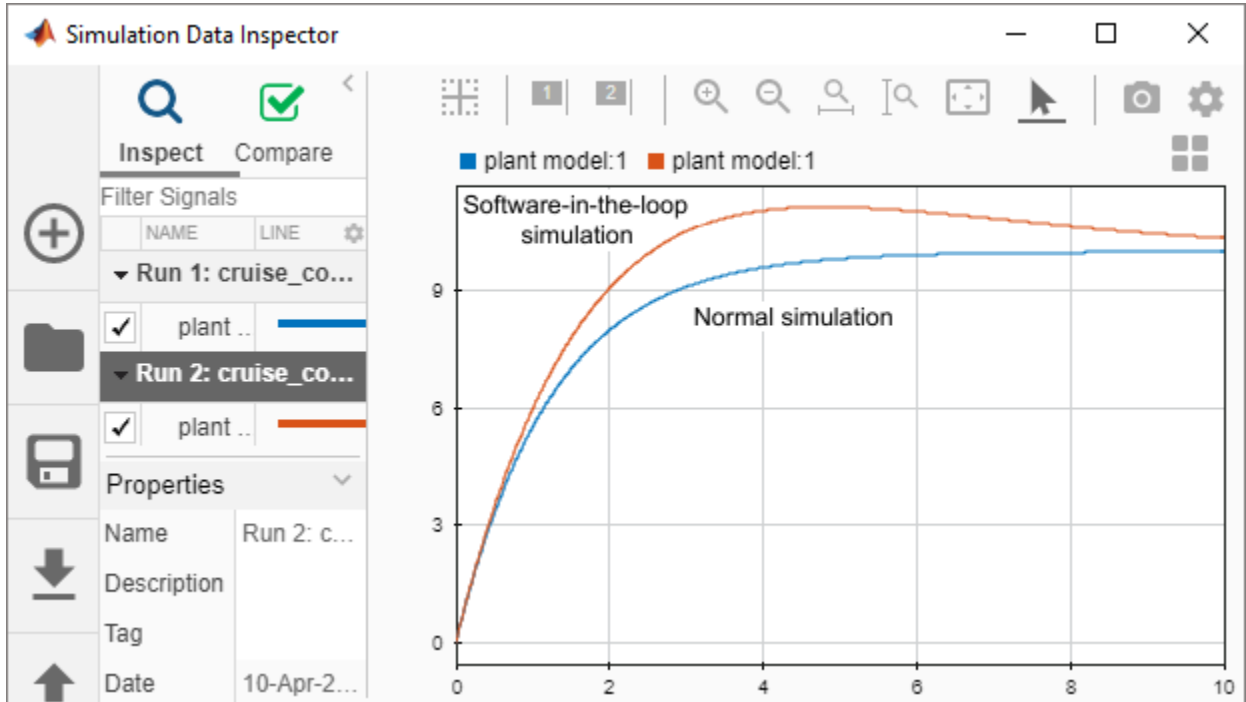

Upgrade Advisor - Simulink tool to identify new feature benefits and needed changes to your model when upgrading to a new release. To open the advisor, in the **Modeling** tab, select **Model Advisor** > **Upgrade Advisor**.

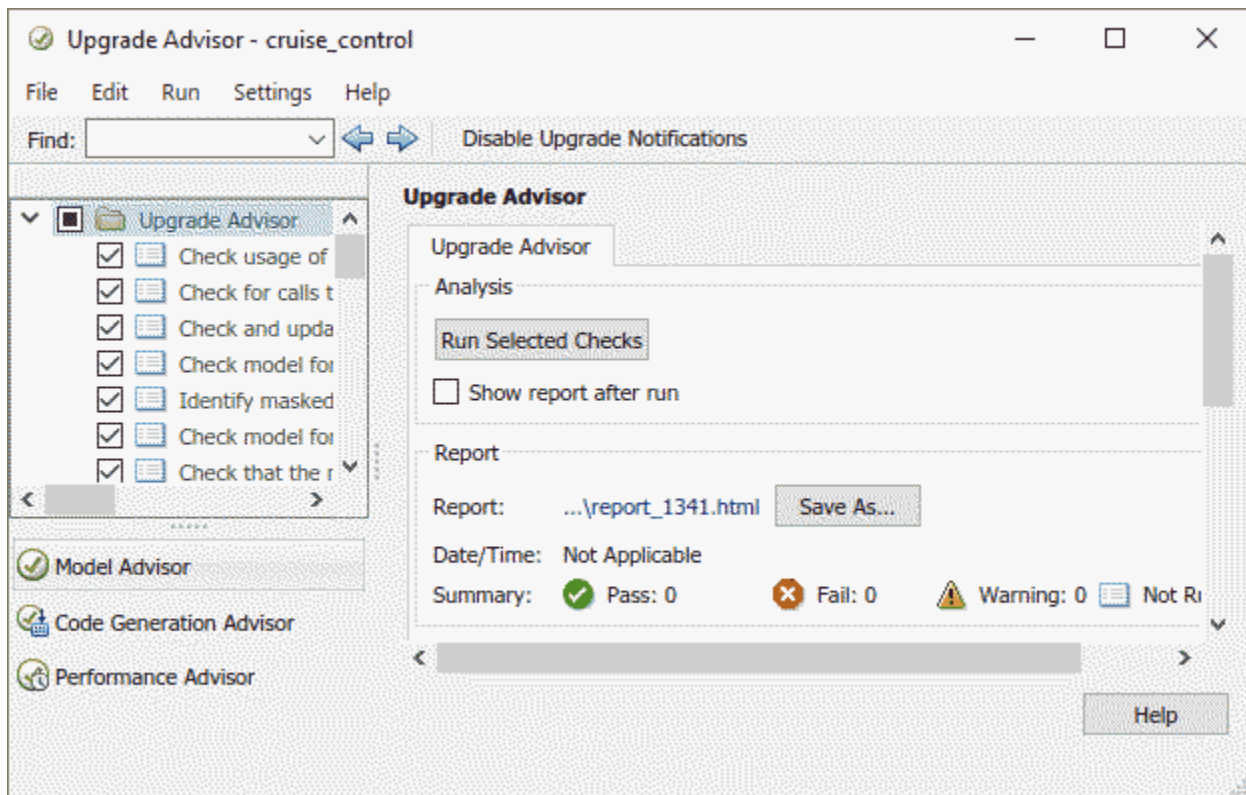

debugger, Simulink debugger - Simulink tool to troubleshoot model simulations by stepping through calls to the block-level methods. To open the debugger, in the **Debug** tab, select **Breakpoints List > Debug Model**.

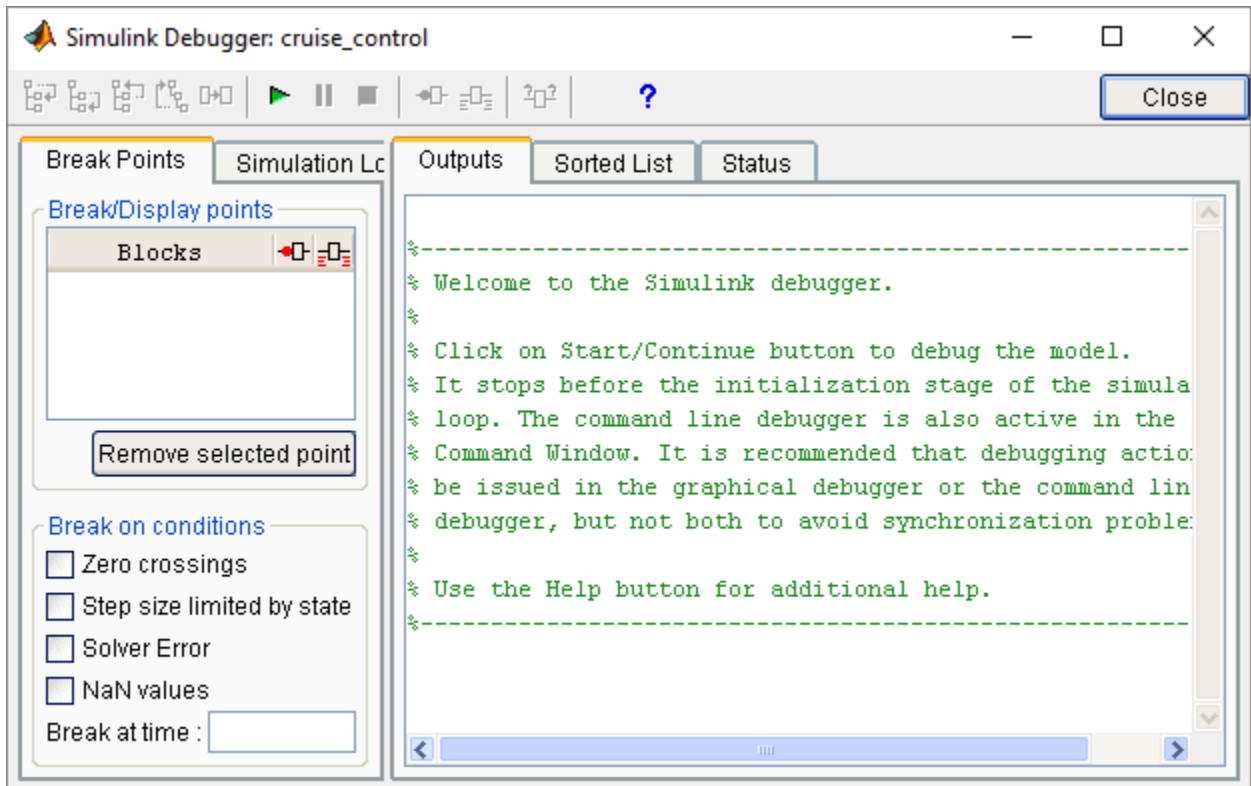

Diagnostic Viewer - Simulink tool that displays error, warning, and information messages for conditions detected during a Simulink operation. To open the viewer, in the **Debug** tab, click **Diagnostics**.

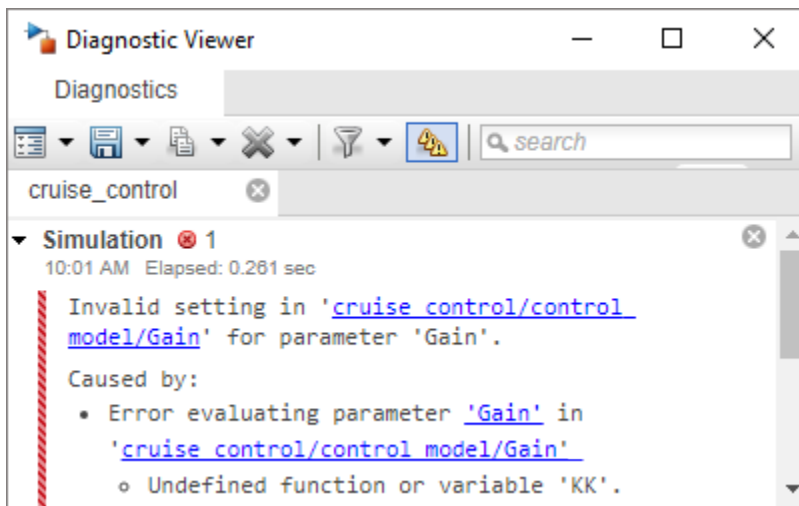

Library Browser, Simulink Library Browser - Simulink tool for searching and selecting model blocks. To open the browser, click the Simulink Editor toolbar icon .

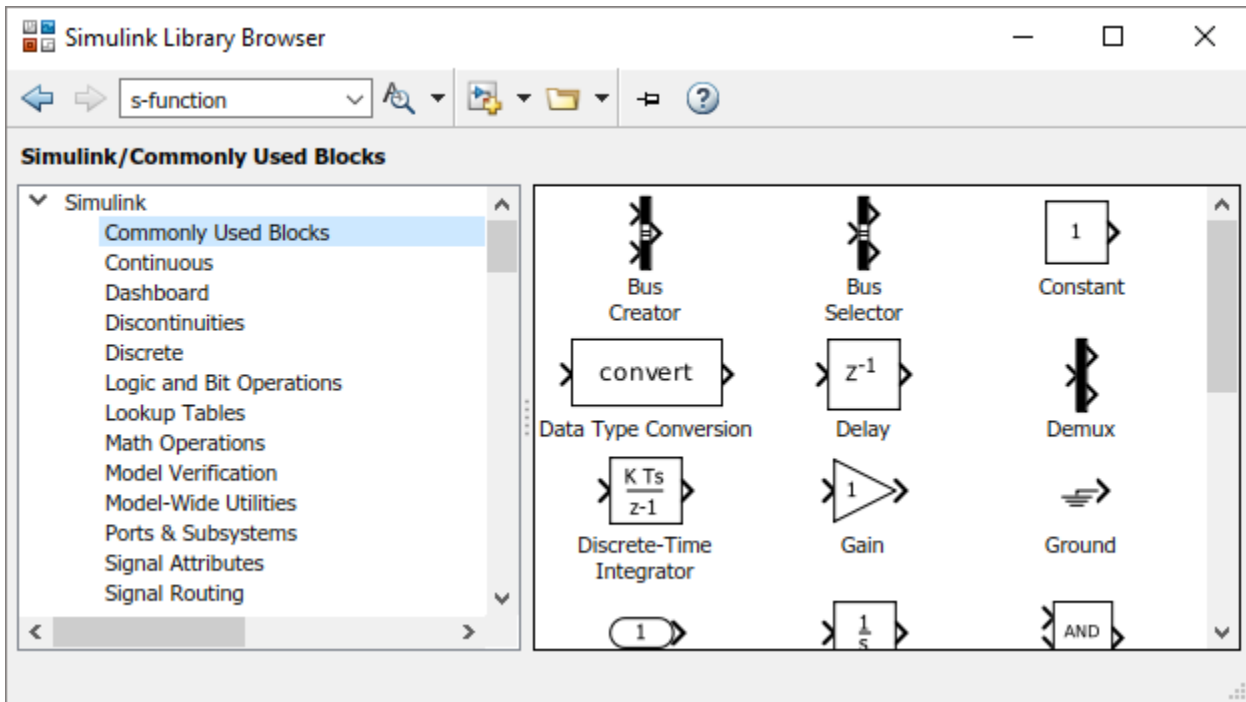

Model Advisor - Simulink tool that checks a Simulink model for conditions and configuration settings that cause inaccurate or inefficient simulation of a *model*. To open and run the advisor, in the **Modeling** tab, click **Model Advisor**.

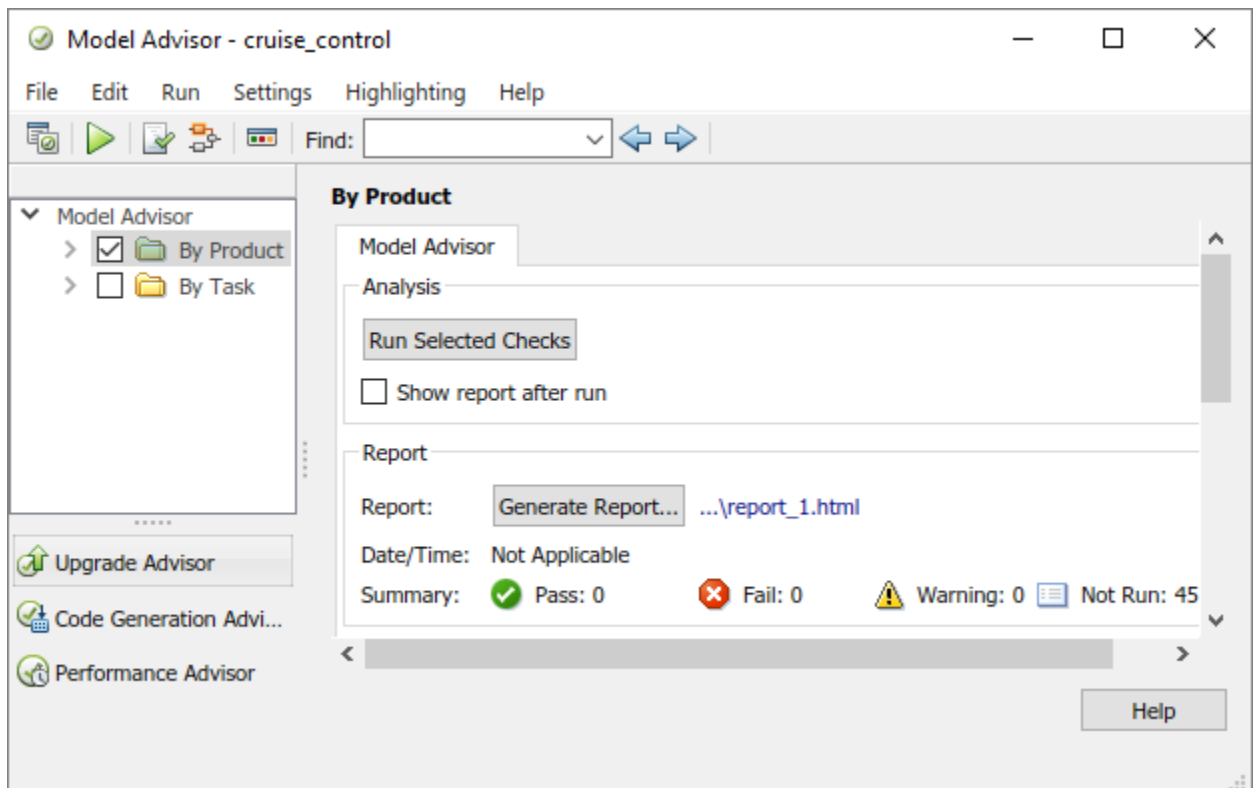

Model Browser - Simulink tool to view and navigate the structure of a *model*. To open the Model Browser in a Simulink Editor pane, in the **Modeling** tab, select **Environment** > **Model Browser**.

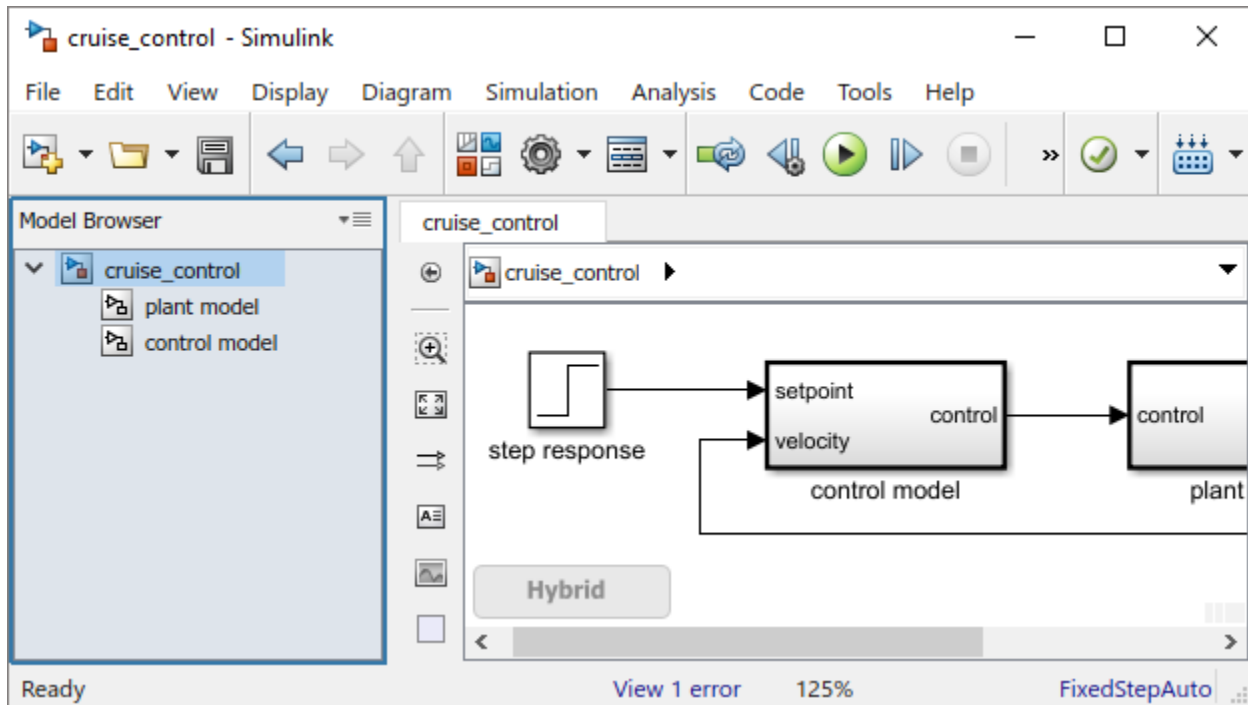

Model Data Editor - Simulink tool to define and edit data items in a list that you can sort, group, and filter. For example, enter property and parameter values, such as data types and dimensions without having to locate the items in the block diagram. To open the Model Data Editor, in the Simulink Editor, in the **Modeling** tab, under **Design**, click **Model Data Editor**.

The screenshot displays the Simulink Model Data Editor for the 'cruise_control' model. The main workspace shows a block diagram with a 'step response' block, a 'control model' block (containing 'setpoint' and 'velocity' inputs), a 'plant model' block (containing 'control' and 'velocity' inputs), and an output scope. The 'control model' block is highlighted with a blue border. Below the diagram is a 'Hybrid' button.

The Model Data Editor window is open, showing the 'Signals' tab. The table below lists the dependencies for the 'control m...', 'plant mo...', and 'step resp...' blocks.

| | Source | Name | Data Type | Min | Max | Dimensions | Complexity | Sample Time | Unit | Resolve | |
|--|--------------|------|-----------|------|-----|------------|------------|-------------|---------|--------------------------|--------------------------|
| | control m... | | double | -Inf | Inf | 1 | real | [0 0] | m/s | <input type="checkbox"/> | |
| | plant mo... | | double | -Inf | Inf | 1 | real | [0 0] | inherit | <input type="checkbox"/> | |
| | step resp... | | double | -Inf | Inf | 1 | real | 0 | [0 0] | m/s | <input type="checkbox"/> |

Ready 125% auto(ode3)

Model Dependency Viewer - Simulink tool to graph the models and libraries referenced directly or indirectly by the parent model. To open the viewer, in the **Modeling** tab, select **Compare > Dependencies > Models & Libraries**. In the following example, the `plant_model` is referenced from the parent `cruise_control` model.

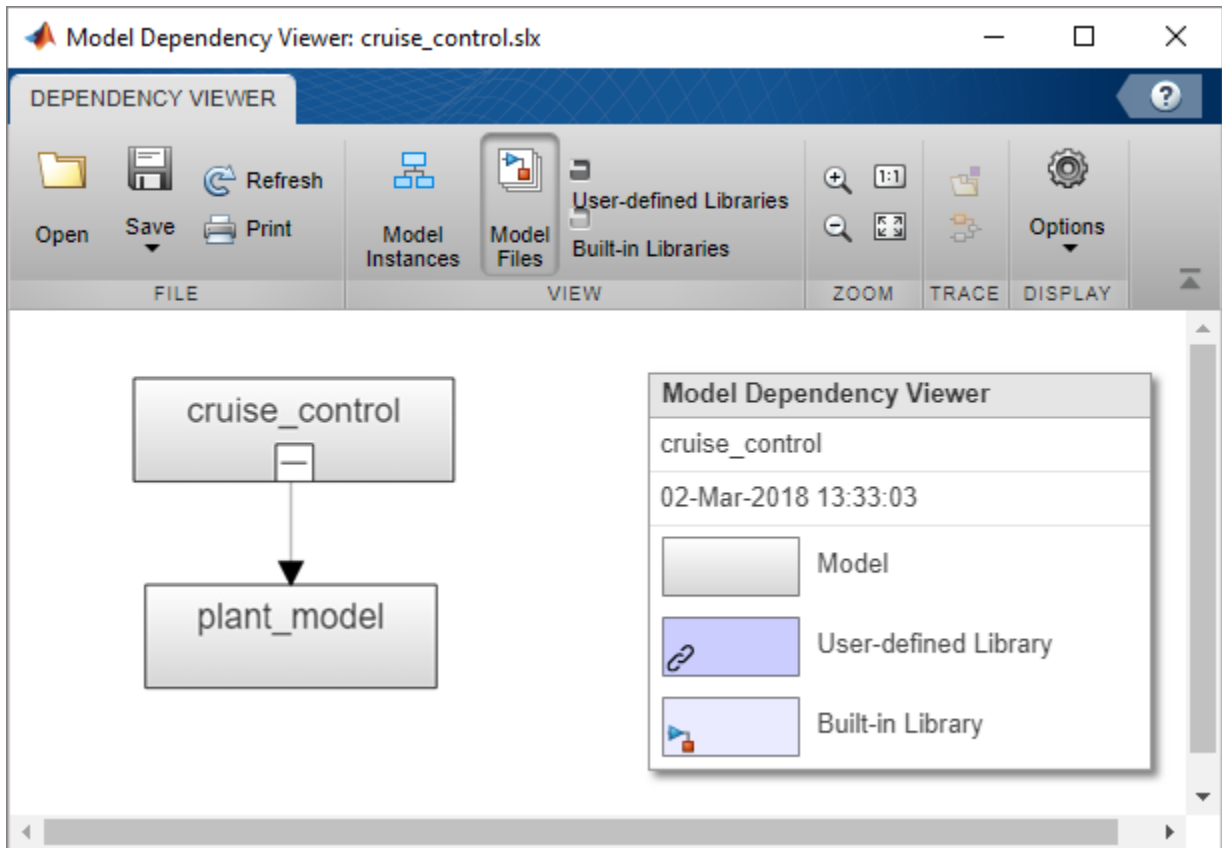

Model Explorer - Simulink tool to view and modify elements of a Simulink model, Stateflow chart, or model workspace variables. To open the explorer window, in the **Modeling** tab, click **Model Explorer**.

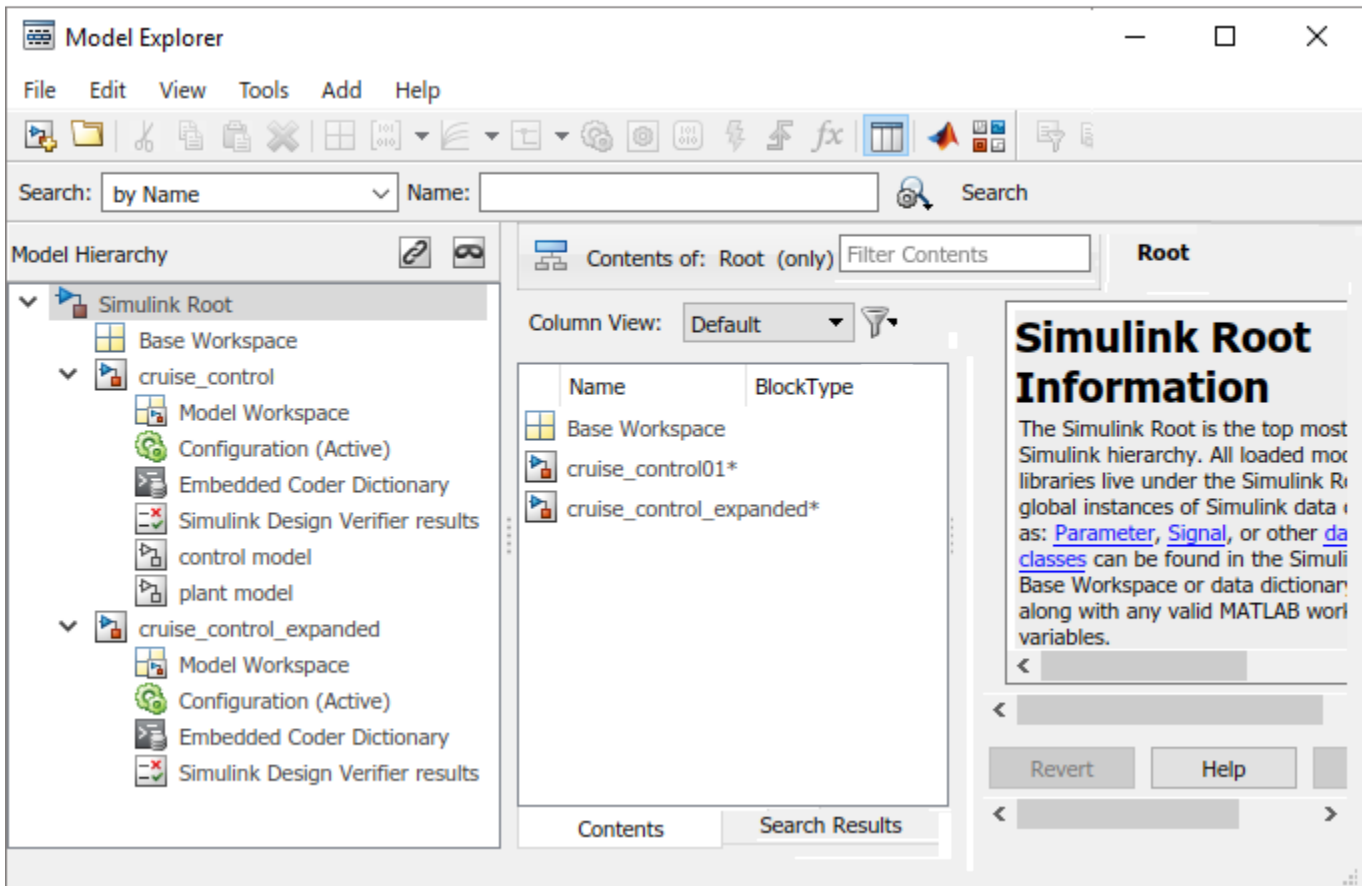

Programming Constructs in Simulink

Simulink command - MATLAB command that is specific to Simulink modeling or simulation. Enter Simulink commands in the MATLAB Command Window or use in MATLAB scripts for testing a model programmatically. The following commands set simulation parameters, run a simulation, and saves the simulation results. In the first statement, `sim` is a *Simulink command* for running a simulation.

```
simOut = sim('cruise_control','SimulationMode','normal',...
            'AbsTol','1e-5','SaveState','on',...
            'StateSaveName','xout','SaveOutput','on',...
            'OutputSaveName','yout','SaveFormat','Dataset');
outputs = simOut.get('yout')
```

callback, model callback - MATLAB code that executes in response to a specific *model* or *block* action. To add a model callback, in the **Modeling** tab, under **Design**, click **Property Inspector**, then in the **Properties** tab, select a function from the **Callbacks** list, and then enter MATLAB code or the name of a MATLAB script.

In the following example, when Simulink loads a model it also loads a file into the MATLAB workspace with parameters values for the model.

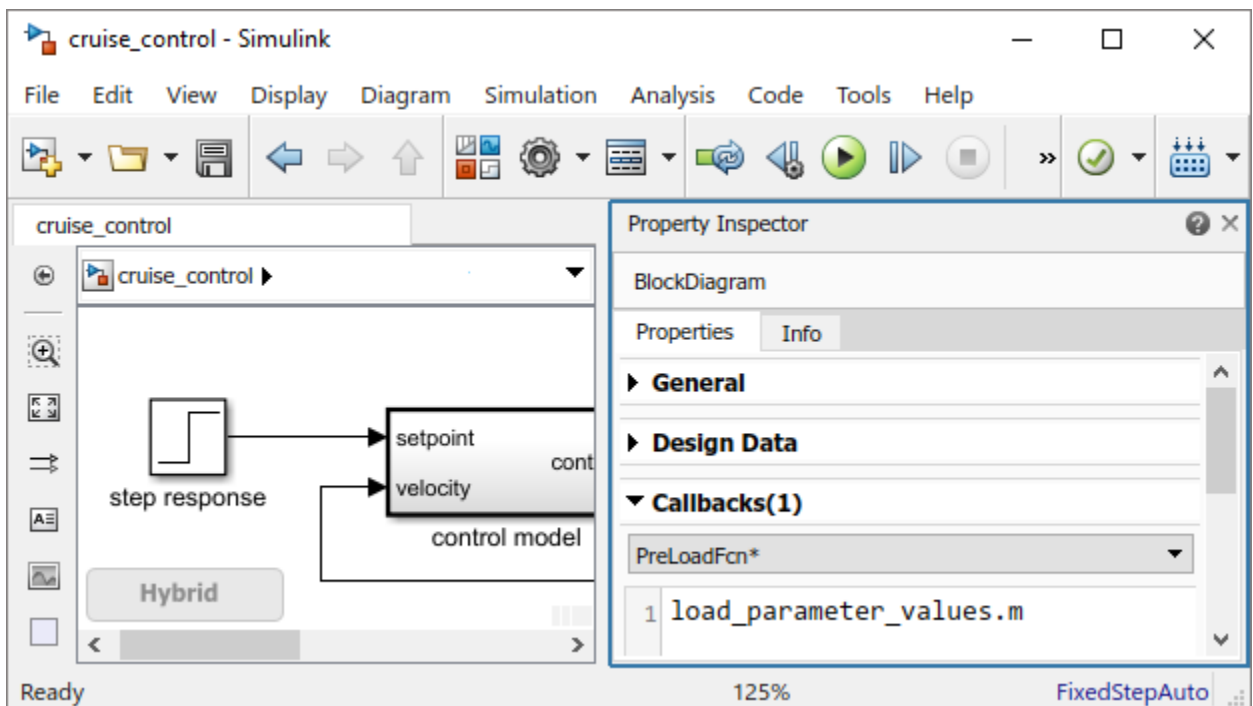

Simulink function - Computational unit that calculates a set of outputs when provided with a set of inputs. A common text interface between function caller and function definition allows various definition formats using a Simulink Function block, exported Stateflow graphical function, or exported Stateflow MATLAB function.

MATLAB Function -

S-function, system-function - Computer language description of a Simulink S-Function block written in MATLAB code, C, C++, or Fortran. C, C++, and Fortran S-functions are compiled as MEX files using the MATLAB mex utility.

```
Editor - E:\matlab\toolbox\simulink\simdemos\simfeatures\src\sfunmem.c
sfunmem.c* x +
1  /* File      : sfunmem.c
2  * Abstract:
3  *      A one integration-step delay and hold "memory" function.
4  *      Syntax: [sys, x0] = sfunmem(t,x,u,flag)
5
6  #define S_FUNCTION_NAME sfunme
7  #include "simstruc.h"
8
9  /*=====
10 * S-function methods *
11 *=====*/
12 /* Function: mdlInitializeSizes =====
13 * Abstract:
14 *      Call mdlCheckParameters to verify that the parameters are okay,
15 *      then setup sizes of the various vectors.
16 */
17 static void mdlInitializeSizes(SimStruct *S)
18 {
19     ssSetNumSFcnParams(S, 0); /* Number of expected parameters */
20     if (ssGetNumSFcnParams(S) != ssGetSFcnParamsCount(S)) {
21         return; /* Parameter mismatch will be reported by Simulink */
22     }
```

Model Development Processes

model-based design - Development process that uses a system model as an executable specification throughout development. The process supports model and model component design, model simulation of dynamic behavior, code generation from the model, and continuous test and verification.

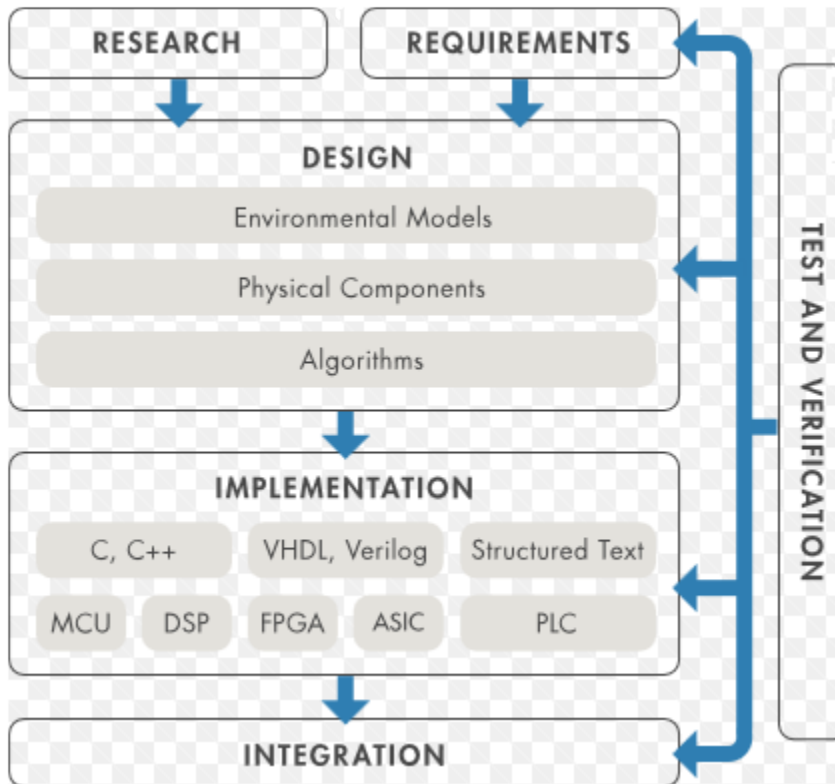

software-in-the-loop (SIL) simulation - Development process where compiled source code on a development computer executes as a separate process from the rest of the Simulink model. Typical goals include initial source code testing and verification by comparing *software-in-the-loop* results with model simulation results and system requirements.

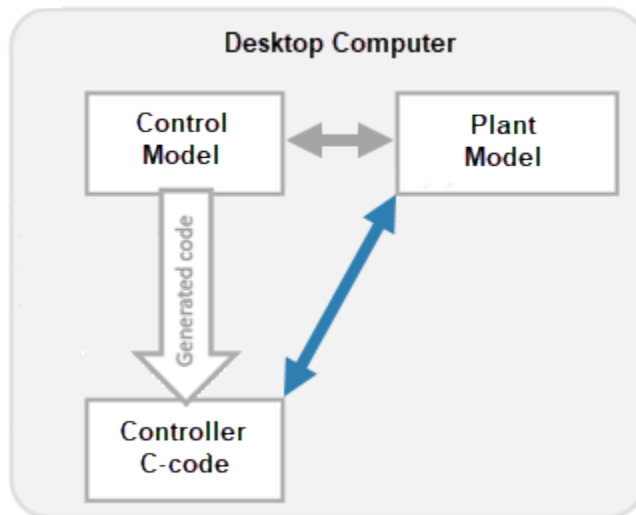

In the following example, to run a software-in-the-loop simulation for the controller, right-click the Model block labeled `control_model` and then select **Block parameters**. From the **Simulation mode** list, select Software-in-the-loop (SIL).

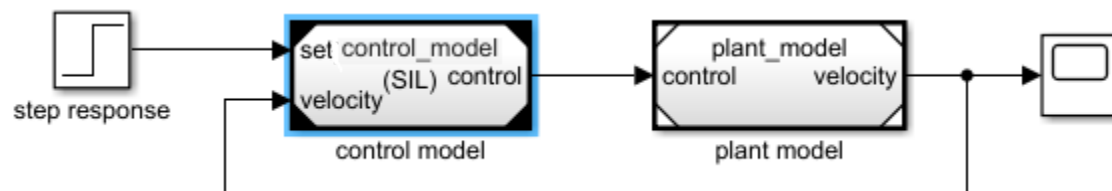

processor-in-the-loop (PIL) simulation - Development process that cross-compiler source code and runs the resulting object code on a target processor using hardware-specific data attributes and sample time attributes. Typical goals include object code verification by comparing *processor-in-the-loop* results with model simulation and *software-in-the-loop (SIL)* results.

hardware-in-the-loop (HIL) simulation - Development process that pairs physical components, such as the hardware and software for a controller, with a virtual real-time implementation of a physical component, such as a plant.

In the following example, code for the controller model is generated and downloaded to the production controller hardware. Code is generated for the plant model and downloaded to a real-time hardware computer (e.g. Simulink Realtime).

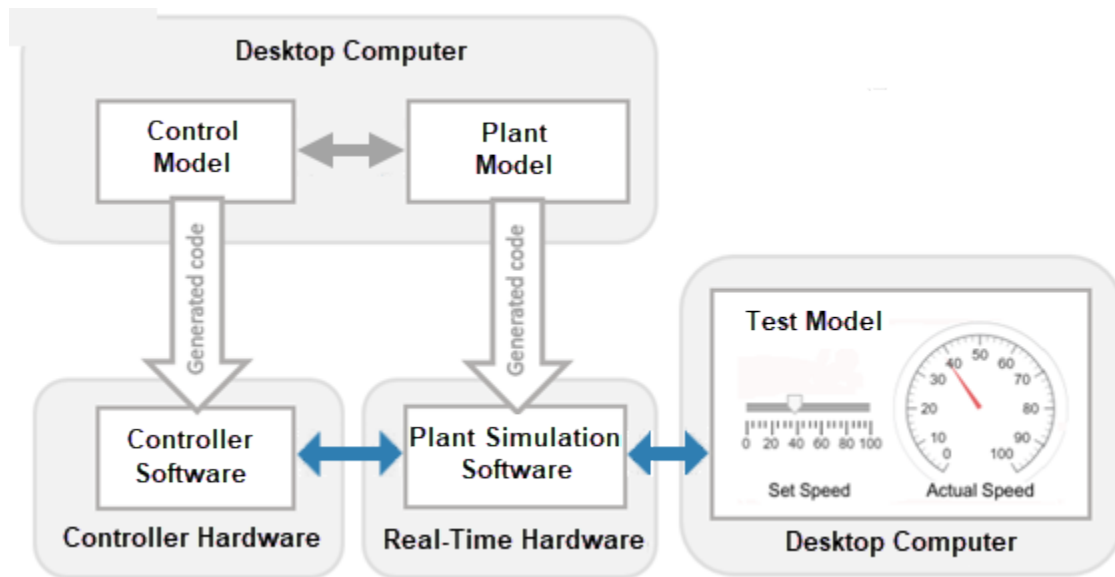

Test Harness

Simulink model that provides a framework for testing the simulation behavior and outputs of another *model* or *model component*. Objectives of the *test harness* are to automate the testing process, execute a test suite with multiple test cases, and analyze results.

In the following model, a Signal Builder block provides test signals while outputs are logged for analysis in the *Simulation Data Inspector* or MATLAB.

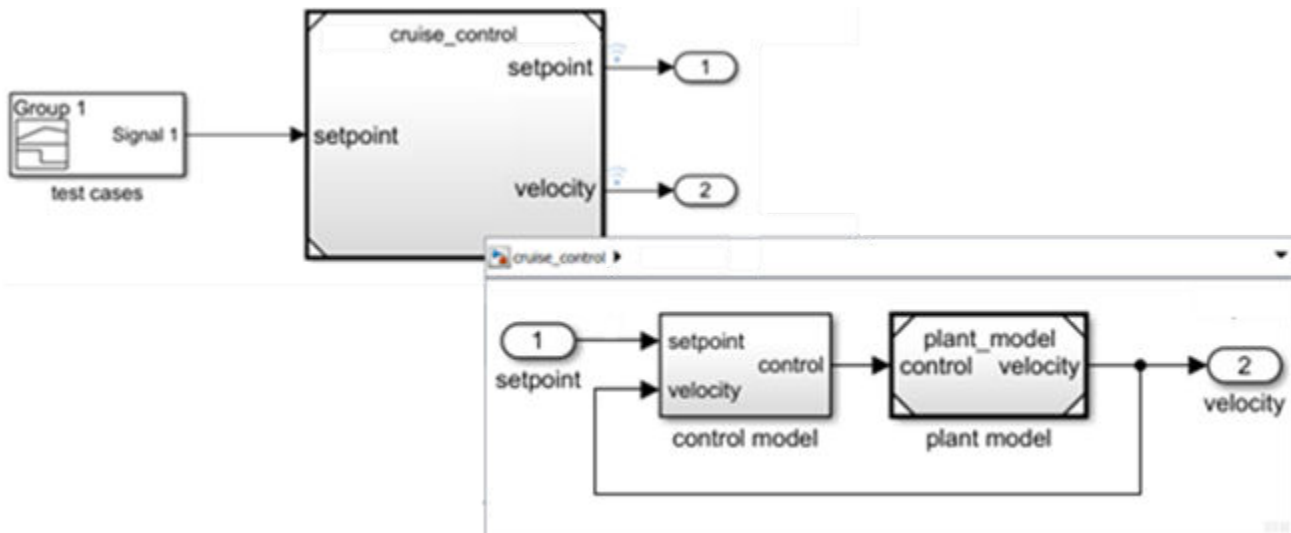

What is Simulink Online?

Simulink Online™ provides access to the latest version of Simulink from a standard web browser using MathWorks hosted computing resources and storage.

With Simulink Online, you can:

- Access the latest version of Simulink with all the latest features available to you through your current license.
- Use Simulink in your web browser without any downloads, installation, or maintenance.
- Store up to 5 GB of MATLAB and Simulink files in your MATLAB Drive™.
- Collaborate with other Simulink users by giving them view-only or can-edit access to your files.
- Create a link to your work and share it globally.
- Synchronize your desktop files with Simulink Online and MATLAB Drive using the MATLAB Drive Connector.

To start using Simulink Online, go to <https://matlab.mathworks.com/>.

For more information about Simulink Online, including supported license types, specifications, limitations, and system requirements, see [Simulink Online](#).

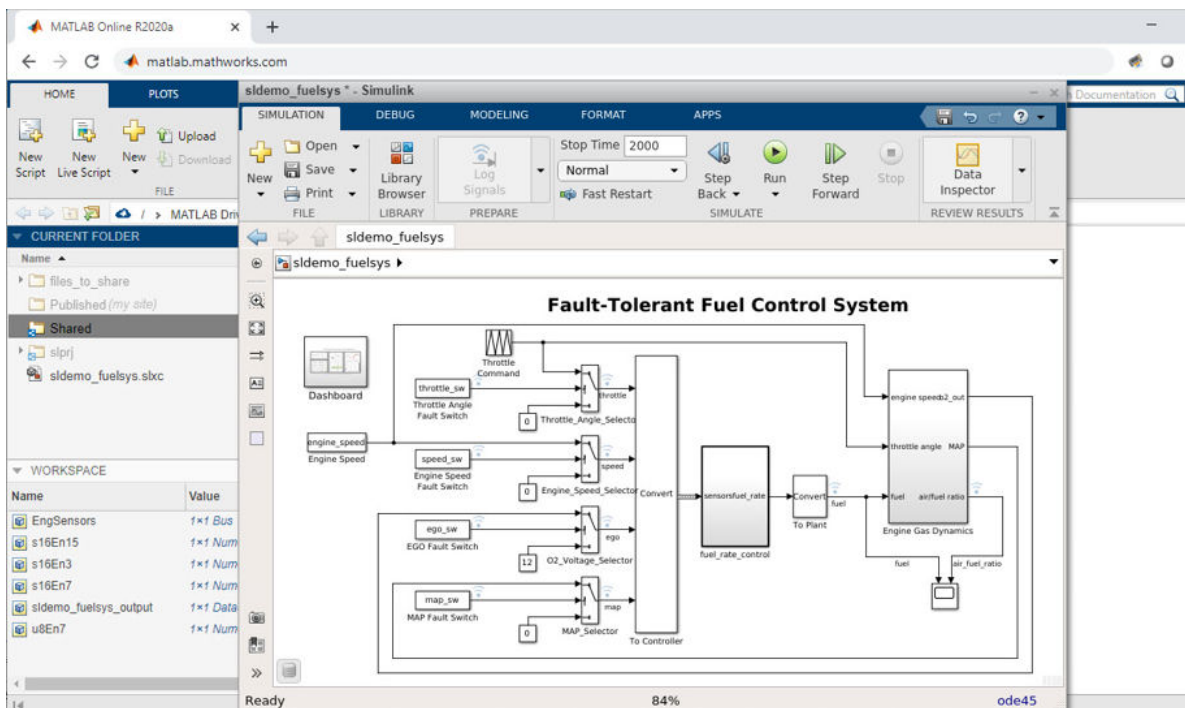

See Also

Block Reference Page Examples

- “Create Mux Signal and Extract Elements” on page 12-5
- “Manage Bus-to-Vector Conversions” on page 12-6
- “Assign Signal Values to a Bus” on page 12-8
- “Initialize Your Model Using the Callback Button Block” on page 12-9
- “Control a Parameter Value with Callback Button Blocks” on page 12-10
- “Control the Duty Cycle of a PWM Signal Using Dashboard Blocks” on page 12-11
- “Control Merging Signals with the Push Button Block” on page 12-13
- “Tune the Relative Slip for an Anti-Lock Braking System” on page 12-15
- “Interactively Simulate a Vehicle Climate Control System” on page 12-17
- “Interactively Simulate a Thermal Model of a House” on page 12-20
- “Create a Realistic Dashboard Using the Circular Gauge Block” on page 12-22
- “Solve a Linear System of Algebraic Equations” on page 12-25
- “Model a Planar Pendulum” on page 12-26
- “Improved Linearization with Transfer Fcn Blocks” on page 12-29
- “View Dead Zone Output on Sine Wave” on page 12-30
- “View Backlash Output on Sine Wave” on page 12-31
- “Prelookup With External Breakpoint Specification” on page 12-32
- “Prelookup with Evenly Spaced Breakpoints” on page 12-33
- “Configure the Prelookup Block to Output Index and Fraction as a Bus” on page 12-34
- “Approximating the sinh Function Using the Lookup Table Dynamic Block” on page 12-35
- “Create a Logarithm Lookup Table” on page 12-36
- “Providing Table Data as an Input to the Direct Lookup Table Block” on page 12-37
- “Specifying Table Data in the Direct Lookup Table Block Dialog Box” on page 12-38
- “Using the Quantizer and Saturation blocks in sldemo_boiler” on page 12-39
- “Scalar Expansion with the Coulomb and Viscous Friction Block” on page 12-40
- “Sum Block Reorders Inputs” on page 12-41
- “Iterated Assignment with the Assignment Block” on page 12-42
- “View Sample Time Using the Digital Clock Block” on page 12-43
- “Bit Specification Using a Positive Integer” on page 12-44
- “Bit Specification Using an Unsigned Integer Expression” on page 12-45
- “Track Running Minimum Value of Chirp Signal” on page 12-46
- “Horizontal Matrix Concatenation” on page 12-47
- “Vertical Matrix Concatenation” on page 12-48
- “Multidimensional Matrix Concatenation” on page 12-49
- “Unary Minus of Matrix Input” on page 12-50

- “Sample Time Math Operations Using the Weighted Sample Time Math Block” on page 12-51
- “Construct Complex Signal from Real and Imaginary Parts” on page 12-52
- “Construct Complex Signal from Magnitude and Phase Angle” on page 12-53
- “Find Nonzero Elements in an Array” on page 12-54
- “Calculate the Running Minimum Value with the MinMax Running Resettable Block” on page 12-55
- “Find Maximum Value of Input” on page 12-57
- “Permute Array Dimensions” on page 12-59
- “Multiply Inputs of Different Dimensions with the Product Block” on page 12-60
- “Multiply and Divide Inputs Using the Product Block” on page 12-61
- “Divide Inputs of Different Dimensions Using the Divide Block” on page 12-62
- “Complex Division Using the Product of Elements Block” on page 12-63
- “Element-Wise Multiplication and Division Using the Product of Elements Block” on page 12-64
- “sin Function with Floating-Point Input” on page 12-65
- “sincos Function with Fixed-Point Input” on page 12-66
- “Trigonometric Function Block Behavior for Complex Exponential Output” on page 12-67
- “Control Algorithm Execution Using Enumerated Signal” on page 12-68
- “Integer and Enumerated Data Type Support in the Ground Block” on page 12-70
- “Fixed-Point Data Type Support in the Ground Block” on page 12-71
- “Read 1-D Array and Structure From Workspace” on page 12-72
- “Read Structure From Workspace Using Model Sample Time” on page 12-73
- “Read 2-D Signals in Structure Format From Workspace” on page 12-74
- “From File Block Loading Timeseries Data” on page 12-75
- “Eliminate Singleton Dimension with the Squeeze Block” on page 12-76
- “Difference Between Time- and Sample-Based Pulse Generation” on page 12-77
- “Specify a Waveform with the Repeating Sequence Block” on page 12-79
- “Tune Phase Delay on Pulse Generator During Simulation” on page 12-80
- “Difference Sine Wave Signal” on page 12-81
- “Discrete-Time Derivative of Floating-Point Input” on page 12-82
- “First-Order Sample-and-Hold of a Sine Wave” on page 12-83
- “Calculate and Display Simulation Step Size using Memory and Clock Blocks” on page 12-84
- “Capture the Velocity of a Bouncing Ball with the Memory Block” on page 12-85
- “Implement a Finite-State Machine with the Combinatorial Logic and Memory Blocks” on page 12-87
- “Discrete-Time Integration Using the Forward Euler Integration Method” on page 12-88
- “Signal Routing with the From, Goto, and Goto Tag Visibility Blocks” on page 12-89
- “Zero-Based and One-Based Indexing with the Index Vector Block” on page 12-91
- “Noncontiguous Values for Data Port Indices of Multiport Switch Block” on page 12-92
- “Using Variable-Size Signals on the Delay Block” on page 12-93

- “Buses with the Delay Block for Frame-Based Processing” on page 12-94
- “Control Execution of Delay Block with Enable Port” on page 12-95
- “Zero-Based Indexing for Multiport Switch Data Ports” on page 12-96
- “One-Based Indexing for Multiport Switch Data Ports” on page 12-97
- “Enumerated Names for Data Port Indices of the Multiport Switch Block” on page 12-98
- “Prevent Block Windup in Multiloop Control” on page 12-99
- “Bumpless Control Transfer” on page 12-100
- “Bumpless Control Transfer with a Two-Degree-of-Freedom PID Controller” on page 12-101
- “Using a Bit Set block” on page 12-102
- “Using a Bit Clear block” on page 12-103
- “Two-Input AND Logic” on page 12-104
- “Circuit Logic” on page 12-105
- “Unsigned Inputs for the Bitwise Operator Block” on page 12-106
- “Signed Inputs for the Bitwise Operator Block” on page 12-107
- “Merge Block with Input from Atomic Subsystems” on page 12-108
- “Index Options with the Selector Block” on page 12-109
- “Switch Block with a Boolean Control Port Example” on page 12-110
- “Merge Block with Unequal Input Widths Example” on page 12-111
- “Detect Rising Edge of Signals” on page 12-113
- “Detect Falling Edge Using the Detect Fall Nonpositive Block” on page 12-115
- “Detect Increasing Signal Values with the Detect Increase Block” on page 12-116
- “Extract Bits from Stored Integer Value” on page 12-117
- “Detect Signal Values Within a Dynamically Specified Interval” on page 12-118
- “Model a Digital Thermometer Using the Polynomial Block” on page 12-120
- “Convert Data Types in Simulink Models” on page 12-121
- “Control Data Types with the Data Type Duplicate Block” on page 12-123
- “Probe Sample Time of a Signal” on page 12-124
- “Convert Signals Between Continuous Time and Discrete Time” on page 12-125
- “Convert Muxed Signal to a Vector” on page 12-127
- “Create Contiguous Copy of a Bus Signal” on page 12-128
- “Convert Virtual Bus to a Nonvirtual Bus” on page 12-129
- “Convert Nonvirtual Bus to Virtual Bus” on page 12-130
- “Remove Scaling from a Fixed-Point Signal” on page 12-131
- “Stop Simulation Block with Relational Operator Block” on page 12-132
- “Output Simulation Data with Blocks” on page 12-133
- “Increment and Decrement Real-World Values” on page 12-137
- “Increment and Decrement Stored Integer Values” on page 12-139
- “Specify a Vector of Initial Conditions for a Discrete Filter Block” on page 12-140
- “Generate Linear Models for a Rising Edge Trigger Signal” on page 12-142

- “Generate Linear Models at Predetermined Times” on page 12-144
- “Capture Measurement Descriptions in a DocBlock” on page 12-145
- “Square Root of Negative Values” on page 12-146
- “Signed Square Root of Negative Values” on page 12-147
- “rSqrt of Floating-Point Inputs” on page 12-148
- “rSqrt of Fixed-Point Inputs” on page 12-149
- “Model a Series RLC Circuit” on page 12-150
- “Extract Vector Elements and Distribute Evenly Across Outputs” on page 12-153
- “Extract Vector Elements Using the Demux Block” on page 12-154
- “Detect Change in Signal Values” on page 12-155
- “Detect Fall to Negative Signal Values” on page 12-156
- “Detect Decreasing Signal Values” on page 12-157
- “Function-Call Blocks Connected to Branches of the Same Function-Call Signal” on page 12-158
- “Function-Call Feedback Latch on Feedback Signal Between Child and Parent” on page 12-159
- “Single Function-Call Subsystem” on page 12-160
- “Function-Call Subsystem with Merged Signal As Input” on page 12-161
- “Partitioning an Input Signal with the For Each Block” on page 12-162
- “Specifying the Concatenation Dimension in the For Each Block” on page 12-163
- “Working with the Initialize Function, Reset Function, and Terminate Function Blocks” on page 12-164
- “Reading and Writing States with the Initialize Function and Terminate Function Blocks” on page 12-165
- “PWM Control of a Boost Converter” on page 12-166
- “Voltage Controlled Oscillator” on page 12-169
- “Check Signal Lower Bound with Check Dynamic Lower Bound Block” on page 12-171
- “Check Signal Upper Bound with Check Dynamic Upper Bound Block” on page 12-173
- “Check Signal Lower Bound with Check Static Lower Bound Block” on page 12-175
- “Check Signal Range with Check Static Range Block” on page 12-177
- “Check Signal Upper Bound with Check Static Upper Bound Block” on page 12-179
- “Check Signal Slope with Check Discrete Gradient Block” on page 12-181
- “Check Signal Value with Check Dynamic Gap Block” on page 12-183
- “Check Signal Value with Check Static Gap Block” on page 12-185
- “Check Signal Range with Check Dynamic Range Block” on page 12-187
- “Check Signal Resolution with Check Input Resolution Block” on page 12-189

Create Mux Signal and Extract Elements

This example shows how to create a mux signal and extract elements from the mux signal.

Open and simulate the example model, which creates a mux signal that contains three signals and extracts those signals using Demux and Selector blocks.

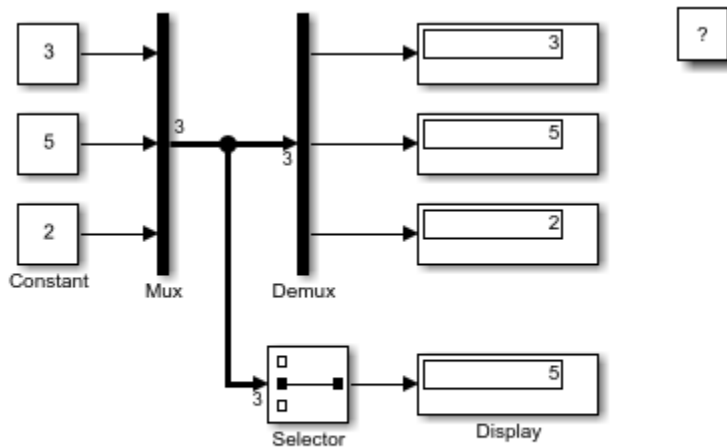

Copyright 2019 The MathWorks, Inc.

The **Signal Dimensions** information overlay displays the number of signals that the mux signal contains.

The **Nonscalar Signals** information overlay displays mux signals with thicker lines than scalar signals.

The Demux block extracts the elements of the mux signal in the order that the Mux block receives them.

The Selector block extracts the elements of the mux signal based on the specified **Index** in the dialog box. Because mux signals are vectors that provide index-based access to their elements, the Selector block uses `Index vector (dialog)` for the **Index Option**.

See Also

Mux | Demux

More About

- “Types of Composite Signals”

Manage Bus-to-Vector Conversions

This example shows how to find and manage implicit bus-to-vector conversions.

Blocks that do not accept buses may implicitly convert buses to vectors. When a bus is treated as a vector, bus elements become inaccessible.

Some buses cannot convert to vectors. For more information, see [Bus to Vector](#).

Identify Implicit Bus-to-Vector Conversions

Open and simulate model `ex_bus_to_vector`.

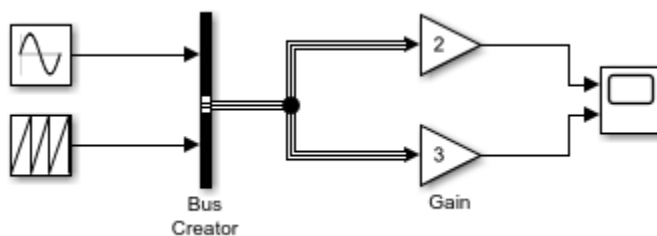

To accept the bus, the Gain blocks implicitly convert the bus to a vector.

To identify buses treated as vectors before simulation, use function `Simulink.BlockDiagram.addBusToVector`.

```
[blocks] = Simulink.BlockDiagram.addBusToVector('ex_bus_to_vector')

### Processing block diagram 'ex_bus_to_vector'
### Number of blocks left that are connected to a bus being used as a vector: 2
### Done processing block diagram 'ex_bus_to_vector'

blocks =

    1x2 struct array with fields:

        BlockPath
        InputPort
        LibPath
```

To identify buses treated as vectors during simulation, set the **Bus signal treated as vector** configuration parameter to `warning` or `error`. The default setting for **Bus signal treated as vector** is `none`, which generates no warning or error message when a block implicitly converts a bus to a vector.

Explicitly Define Bus-to-Vector Conversions

To insert Bus to Vector blocks where blocks implicitly convert buses to vectors, use function `Simulink.BlockDiagram.addBusToVector` with `reportOnly` set to `false`. When you use function `Simulink.BlockDiagram.addBusToVector` with `reportOnly` set to `false`, the function saves the model. To create a writable copy of model `ex_bus_to_vector`, this example uses the `save_system` function.

```
save_system('ex_bus_to_vector','ex_bus_to_vector_blocks');
[blocks,busToVectors] =
Simulink.BlockDiagram.addBusToVector('ex_bus_to_vector_blocks',true,false);
```

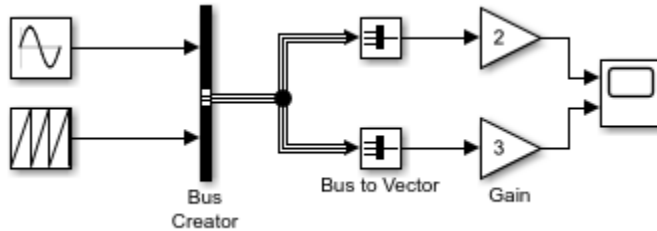

The Gain blocks no longer implicitly convert the bus to a vector. The inserted Bus to Vector blocks perform the conversion explicitly.

Bus to Vector blocks are virtual and do not affect simulation results, code generation, or performance.

Function `Simulink.BlockDiagram.addBusToVector` returns no remaining implicit bus-to-vector conversions.

```
[blocks] = Simulink.BlockDiagram.addBusToVector('ex_bus_to_vector_blocks')
```

```
###No buses used as vectors left to process
```

```
blocks =
```

```
1x0 empty struct array with fields:
```

```
BlockPath
InputPort
MixedAttributes
```

By specifying acceptable bus-to-vector conversions with Bus to Vector blocks, you can more easily identify unexpected conversions. Having configuration parameter **Bus signal treated as vector** set to **warning** or **error** alerts you when an unexpected bus-to-vector conversion occurs.

Assign Signal Values to a Bus

This example shows how to use a Bus Assignment block to change a bus element value without adding Bus Selector and Bus Creator blocks to select bus elements and reassemble them into a bus.

Open the model and simulate it.

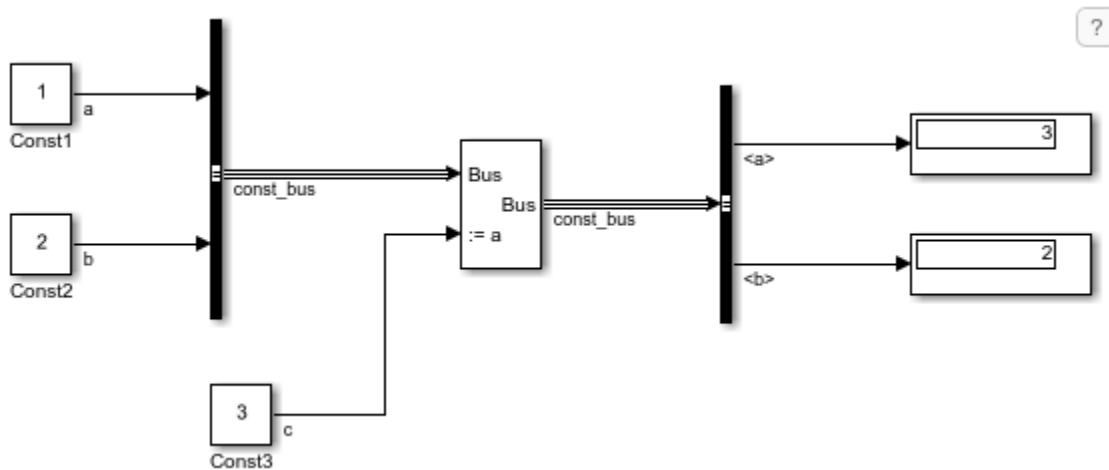

Initially, the value of signal a is 1. However, the Bus Assignment block replaces that initial value of signal a with the value of signal c, which is 3. The const_bus output signal has a value of 3 for signal a, as the Display block shows.

Initialize Your Model Using the Callback Button Block

This example shows how to use the Callback Button block to perform initialization routines on your model.

Explore the Model

The example model builds on the `sldemo_fuelsys` featured model. When you open the model, to bind the workspace variables to their Dashboard blocks, you have to update the model diagram. Here, the Callback Button block at the bottom of the Dashboard subsystem in the model has been configured to update the diagram on the release of the mouse button when you click the block.

Fault-Tolerant Fuel Control System Dashboard

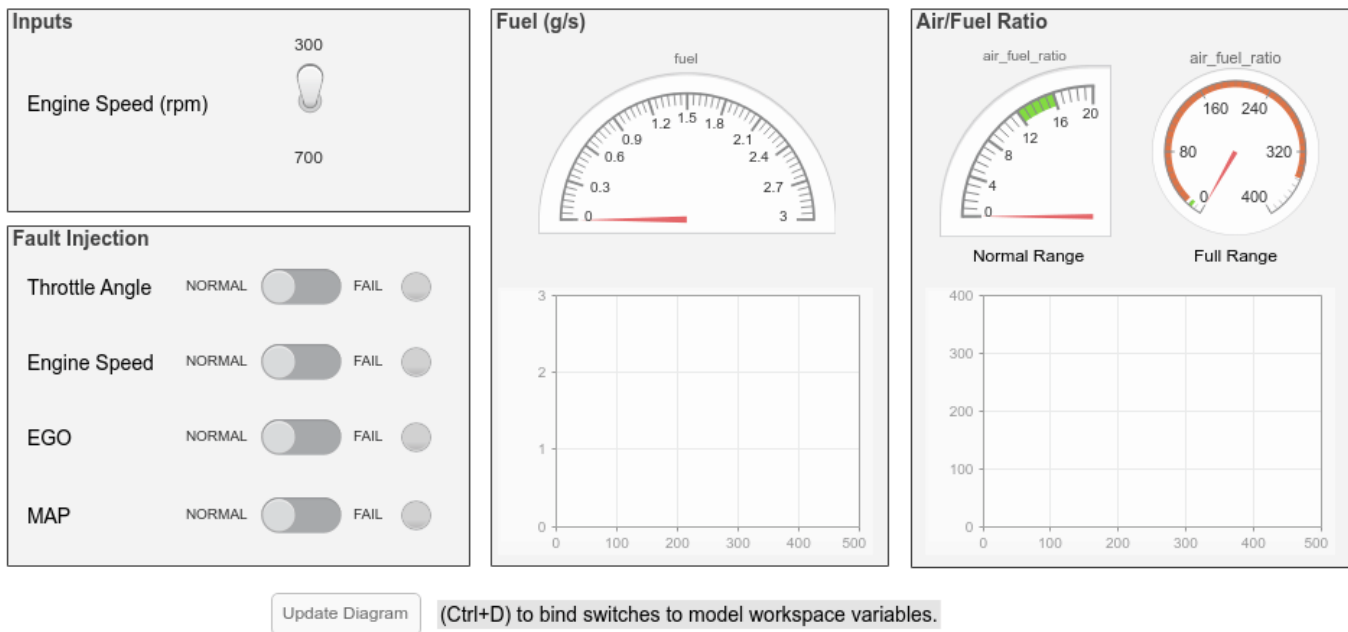

You do not need to start a simulation for the Callback Button to react to your input. Just select and then click the Callback Button to run the initialization code. Double-click the Callback Button block to view and edit its parameters, including the press and click scripts.

See Also

More About

- “Modeling a Fault-Tolerant Fuel Control System” on page 13-112

Control a Parameter Value with Callback Button Blocks

This example models control of a system that consists of two masses attached on either side of a spring. A control loop damps the oscillation of the spring that results when an external force acts on the system. The model uses Callback Button blocks to provide an interface for you to adjust the frequency of the external force before and during simulation.

Explore the Model

The model for this example adds two Callback Button blocks, labeled Frequency + and Frequency - to the Double Mass-Spring System model. When you simulate the model, an animation visualizes the system.

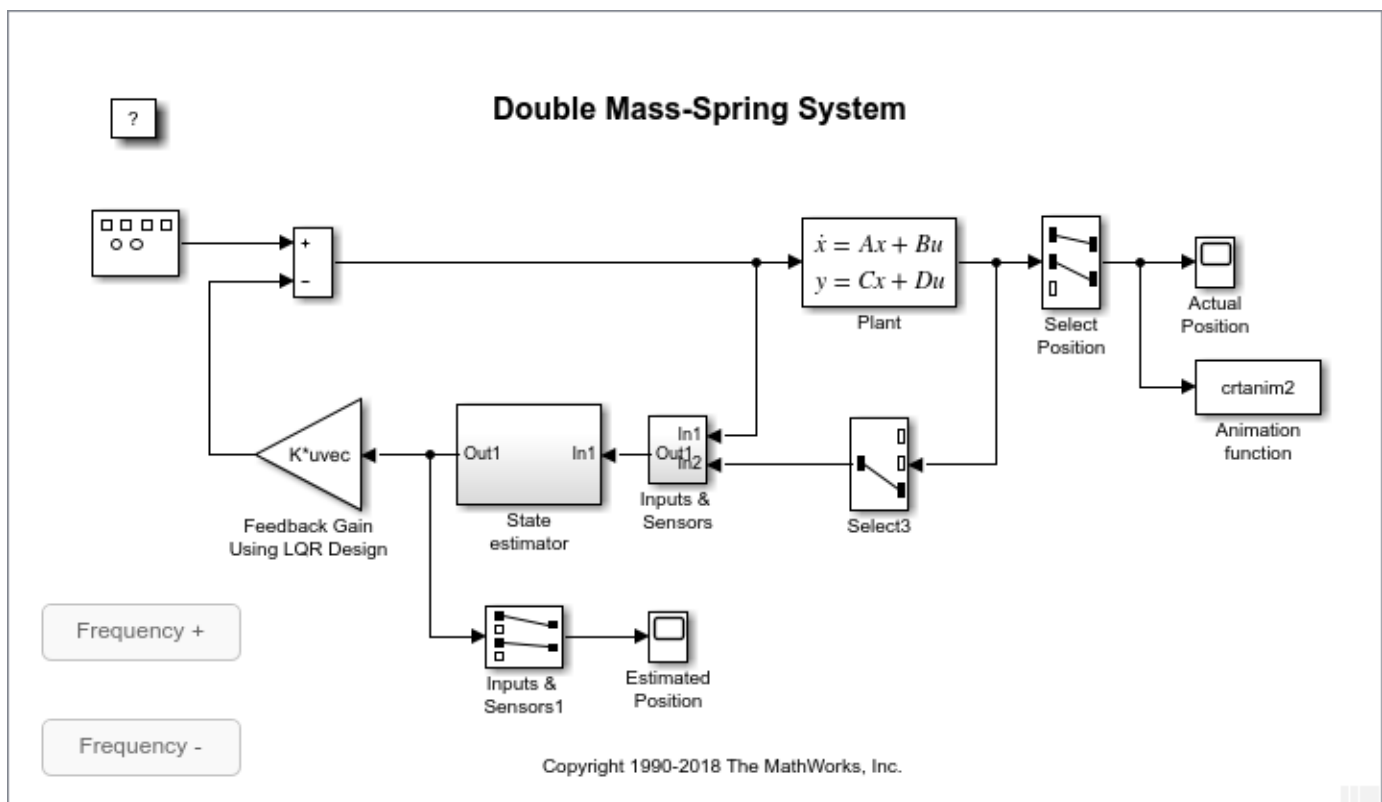

Click the button labeled Frequency + to increase the oscillation frequency. When you adjust the frequency of the external force, the Callback Button block displays a message in the command window indicating the new frequency value. You can adjust the parameter during a simulation and while the model is idle.

Both Callback Button blocks in this model are configured with a ClickFcn that responds to your clicks and a PressFcn that executes when you press the Callback Button block. Double-click the Frequency + Callback Button block to view its parameters.

When you click the Frequency + Callback Button block, the ClickFcn increases the frequency of the external force by 0.1. If you press the Callback Button block for more than the 500 ms Press Delay, the PressFcn increases the frequency of the external force by 0.1 every second.

Control the Duty Cycle of a PWM Signal Using Dashboard Blocks

This example shows how a simulation dashboard built using Dashboard blocks controls the duty cycle of a PWM signal generated by the model. The example is a modified version of the `sfncdemo_pwm` example. The PWM Generator block takes a duty cycle and period as inputs to generate a PWM output. You can control the source for the duty cycle using a switch.

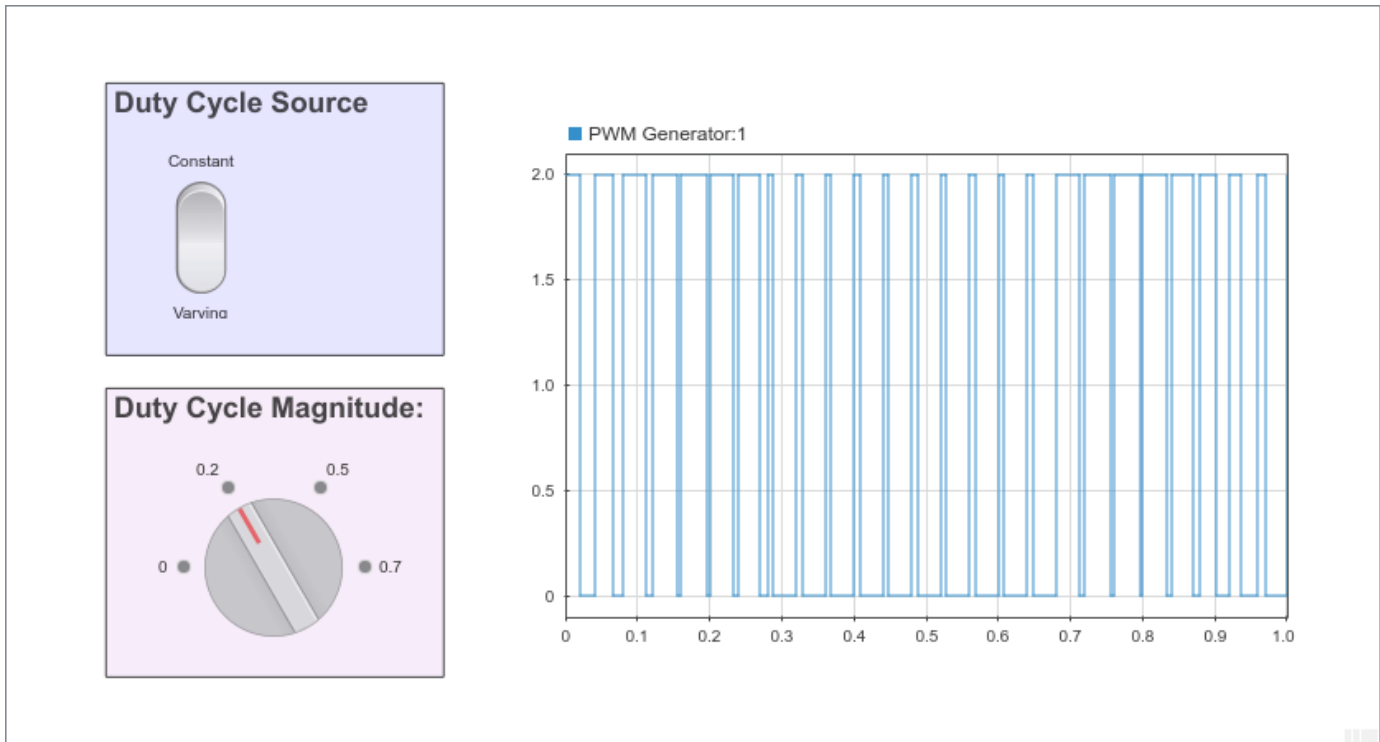

Build the Dashboard Subsystem

To create the Dashboard subsystem in this example:

1. Add a Subsystem block to the model.
2. Delete the pre-populated contents of the subsystem.
3. Add the contents of the dashboard. The dashboard in this example includes a Rocker Switch block and a Knob block, which allow you to modify variables during simulation. The Dashboard Scope block displays the generated PWM signal.

Use areas in the Dashboard subsystem to group and label Dashboard blocks. For more information about creating areas, see "Box and Label Areas of a Model".

Connect Blocks in the Model

In this model, the Rocker Switch block in the Dashboard subsystem provides the interface for selecting the duty cycle source. A Switch block with a Constant block as its control input replaces the Manual Switch in the `sfncdemo_pwm` model. Replacing the Manual Switch block requires three

blocks but allows you to gather model controls and visualizations in a single view. The Rocker Switch block connects to the value of the Constant block. In this model, the Constant block value is set by the variable `duty_cycle_source`.

This model also uses the variable `duty_cycle` to set the magnitude of the duty cycle for both the duty cycle (constant) and duty cycle (varying) sources. The Knob block in the Dashboard subsystem connects to the `duty_cycle` variable, allowing you to modify its value during simulation.

The Dashboard Scope block displays the output of the PWM Generator block, allowing you to observe the generated PWM signal during simulation.

Interactively Simulate

This model uses simulation pacing to slow model execution so you can interact with the model during simulation. For more information, see “Simulation Pacing”.

Run the simulation. Use the Rocker Switch block to select the varying duty cycle input and observe the resulting PWM waveform on the Dashboard Scope block. Change the magnitude of the duty cycle using the Knob block and observe the effect on the generated PWM signal.

Control Merging Signals with the Push Button Block

This example model is a modified version of the “Merging Signals” on page 13-318 example. The mergedemo model illustrates how to use Simulink® to merge two different signals using source blocks and triggered subsystems. In the mergedemo model, a square wave enables and disables the triggered subsystems that provide input to the Merge block. In this model, you can control the enable signal for the triggered subsystems using the Signal Select Push Button block.

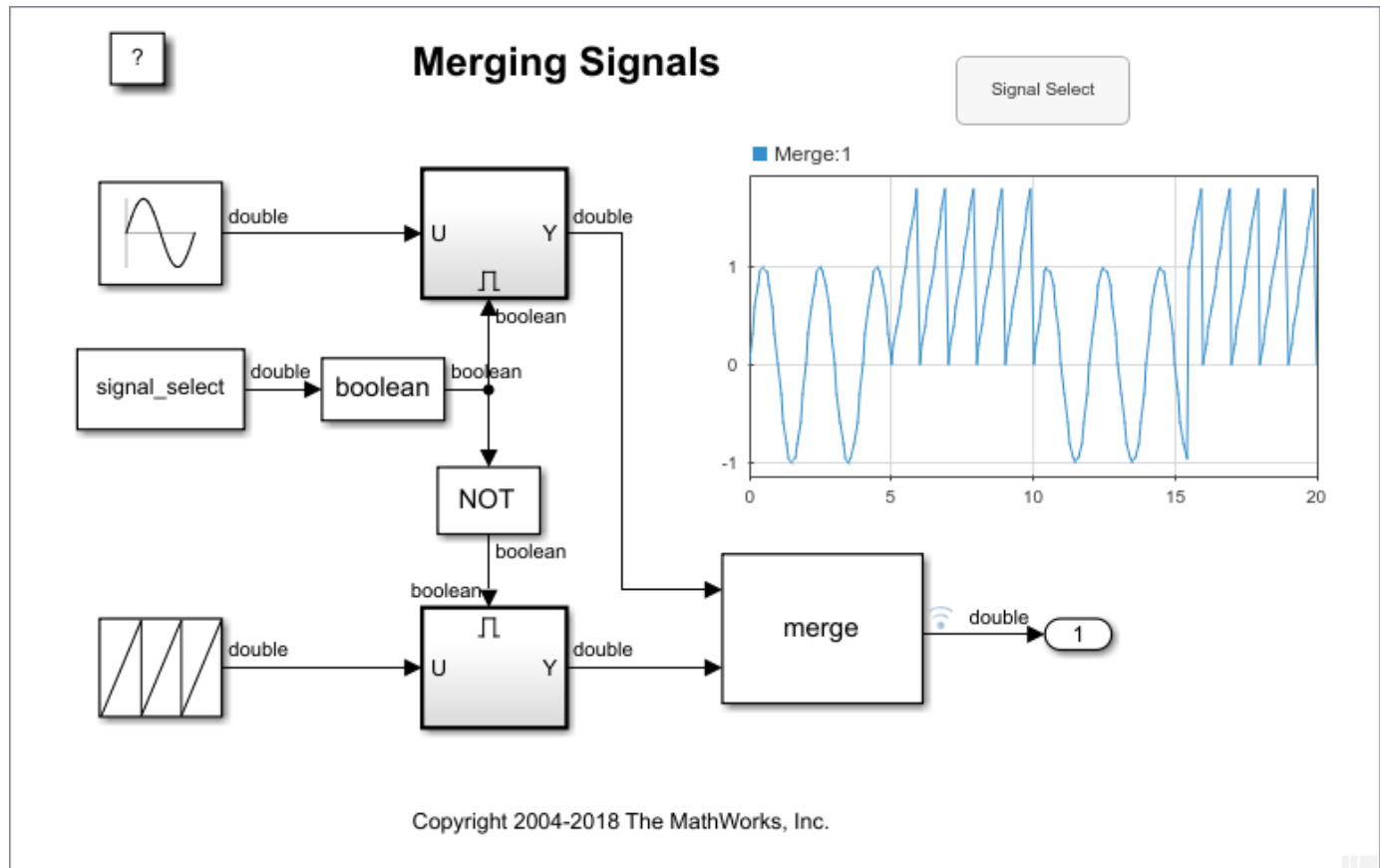

Model Modifications

To create this model from the mergedemo example:

1. Delete the Discrete Pulse Generator block controlling the triggered subsystem and the Scope block.
2. Add a Push Button block, an Outport block, a Constant block, and a Dashboard Scope block.
3. Connect the Outport block to the output of the Merge block.
4. Display the output signal of the Merge block on the Dashboard Scope.
5. Connect the Constant block to the input of the Data Type Conversion block and specify a variable name as its value. This model uses the variable name `signal_select`. Click the `Unrecognized functions or variables` error, and create the variable in the Model Workspace.

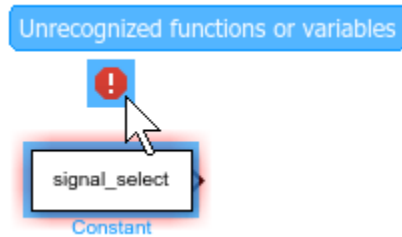

Now, the variable `signal_select` controls the triggered subsystems.

6. Press Ctrl+D to update the diagram so the variable you just created is available for connection.

7. Connect the Push Button block to the `signal_select` variable.

In this example, the On Value for the Push Button block is set to 0. When you press the Push Button block, the value of `signal_select` changes to 0, enabling the triggered subsystem connected to the sawtooth wave. If you want pressing the Push Button block to enable the triggered subsystem connected to the sine wave, set the On Value for the Push Button block to 1.

Interactive Simulation

This model uses simulation pacing to slow model execution so you can interact with the model during simulation. For more information about simulation pacing, see "Simulation Pacing".

Run the simulation. As the model simulates, press and hold the Signal Selection Push Button block. You can observe the effect of pressing the Push Button block on the Dashboard Scope block.

Tune the Relative Slip for an Anti-Lock Braking System

This example shows how to use a subsystem made of Dashboard blocks to tune the value of the `Desired relative slip` for the “Modeling an Anti-Lock Braking System” on page 13-160 example. You can use the Slider block or the Edit block to change the value of the `Desired relative slip` and observe the results during simulation on the Dashboard Scope block.

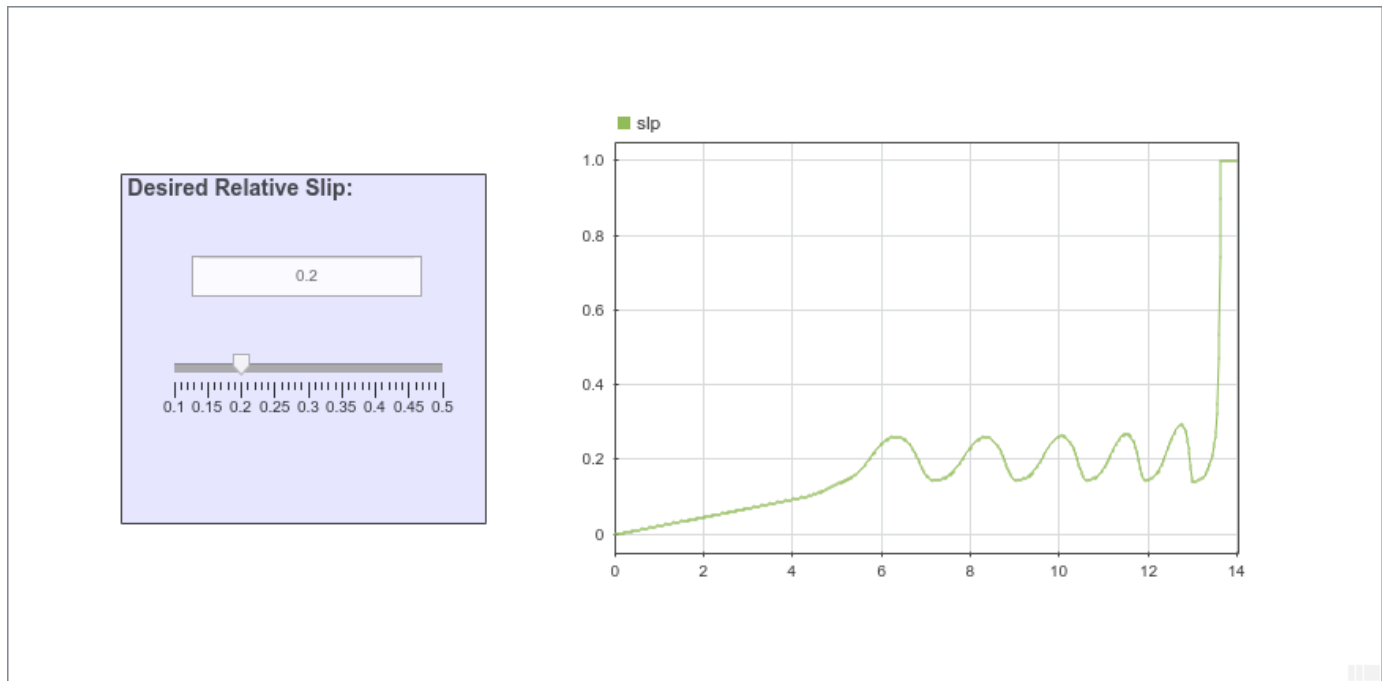

Build the Dashboard Subsystem

This model uses a Subsystem block to gather the controls and displays for the model in a single interface. To create the subsystem for this model:

1. Add a Subsystem block to the `sldemo_absbrake` model.
2. Delete the pre-populated contents of the subsystem. A subsystem of Dashboard blocks does not need Inport or Outport blocks because Dashboard blocks do not use ports to make connections.
3. Add the components of the dashboard.

The dashboard for this model includes an Edit block and a Slider block that both control the value of the `Desired relative slip` input. The Dashboard Scope block displays the resulting slip value, `slp` throughout the simulation.

You can use areas in the subsystem to group and label related controls and displays. For more information about creating areas, see “Box and Label Areas of a Model”.

Interactively Simulate

You can use the Dashboard subsystem as a convenient interface to configure separate simulations that use different values for the `Desired relative slip`.

The Slider block and the Edit block both change the value of the `Desired relative slip` input. Use the Slider block to fine tune the value of the relative slip input, and use the Edit block to enter an exact value.

Interactively Simulate a Vehicle Climate Control System

In this example, you use a Dashboard of controls and displays to interactively simulate a climate control system of a car. You can adjust the fan and air recycling controls as well as set the internal temperature and modify the external temperature. A Linear Gauge block, a Dashboard Scope block, and a Display block show the internal temperature of the car. The model in this example adds the Dashboard to the `sldemo_auto_climatecontrol` model. For more information about the underlying model, see “Simulating Automatic Climate Control Systems” on page 13-185.

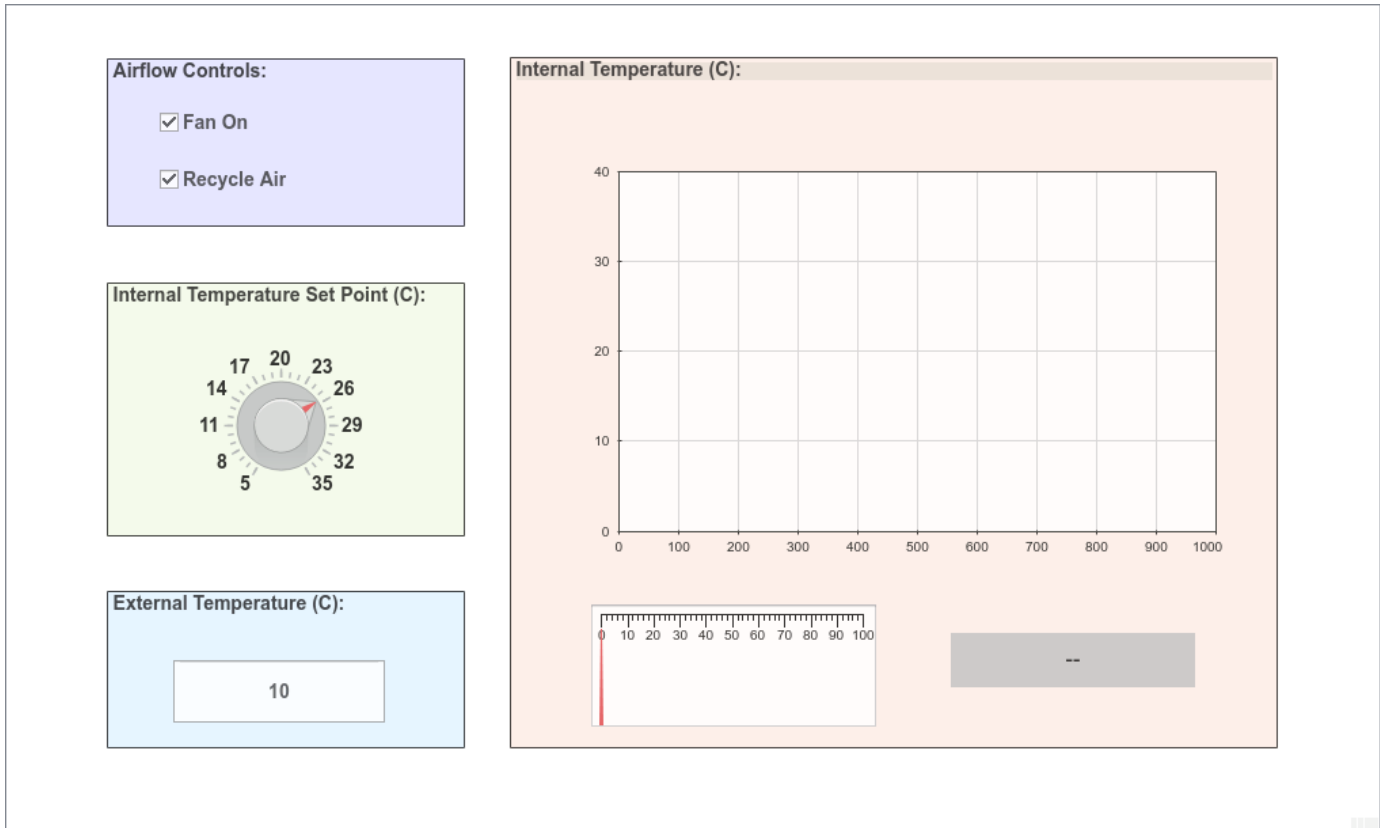

Build the Dashboard Subsystem

This model uses a Subsystem block to gather the controls and displays in a single interface for the model. To create the subsystem in this example:

1. Add a Subsystem block to the `sldemo_auto_climatecontrol` model.
2. Delete the prepopulated contents of the subsystem. The subsystem does not need inports or outports because the Dashboard blocks do not use ports to make connections.
3. Add the contents of the dashboard.

In the dashboard for this model:

- Two Check Box blocks turn the fans and air recycling on and off.
- A Knob block sets the internal temperature.

- An Edit block allows you to specify the external temperature.
- A Dashboard Scope block displays the value of the internal temperature over time.
- A Linear Gauge block displays the instantaneous internal temperature value.
- A Display block shows the instantaneous internal temperature value.

You can use areas in the subsystem to group and label related controls and displays. For more information about creating areas, see “Box and Label Areas of a Model”.

Connect Blocks in the Model

To explore connections between each block in the Dashboard subsystem and the model, you can select a block in the dashboard, pause on the ellipsis that appears above it, and click Jump to Connected Element. The Simulink® editor navigates to and highlights the block or signal connected to that block in the dashboard.

The Check Box blocks connect to the `dist_req` and `recycle_air` constant blocks. In the `sldemo_auto_climatecontrol` model, the fan and air recycling signals are controlled by Manual Switch blocks with two Constant blocks as inputs.

To replace a Manual Switch block in the `sldemo_auto_climatecontrol` model with a Check Box block:

1. Delete the Manual Switch block and one of the Constant blocks.
2. Connect the other Constant block directly to the Mux block.
3. Specify a variable as the Constant block value.

This model uses the variable `dist_req` to control the fans and the variable `recycle_air` to control air recycling.

4. Click the Unrecognized functions or variables error, and create the variable in the Model Workspace.

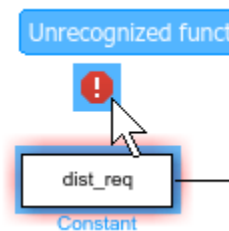

Now, the variable `dist_req` holds the state of the fans.

5. Press Ctrl+D to update the diagram so the variable you just created is available for connection.
6. Connect the Check Box block to the `dist_req` variable.

Follow a similar process to replace the air recycling manual switch.

The Knob block connects to the `USet` parameter of the User Setpoint in Celsius masked subsystem. Similarly, the Edit block connects to the `x` parameter of the External Temperature in Celsius masked

subsystem. The Dashboard Scope, Linear Gauge, and Display blocks all connect to the output signal of the Kelvin to Celsius subsystem.

Interactive Simulation

This model uses simulation pacing to slow model execution so you can interact with the model during simulation. For more information, see “Simulation Pacing”.

Run the simulation. Use the Check Box blocks to control the fans and air recycling. Use the Knob block to adjust the internal temperature set point, and specify the external temperature with the Edit block. You can observe the resulting internal temperature on the Dashboard Scope block, the Linear Gauge block, and the Display block.

Interactively Simulate a Thermal Model of a House

This example uses a dashboard of controls and indicators to configure and then interactively simulate a thermal model of a house. You can configure the simulation to use either traditional or renewable energy sources and to use an outdoor temperature setpoint based on the season. During the simulation, you can adjust the thermostat and monitor the indoor temperature and heat cost. The model in this example adds a subsystem named Dashboard to the `sldemo_househeat` model. For more information about the underlying model, see “Thermal Model of a House” on page 13-21.

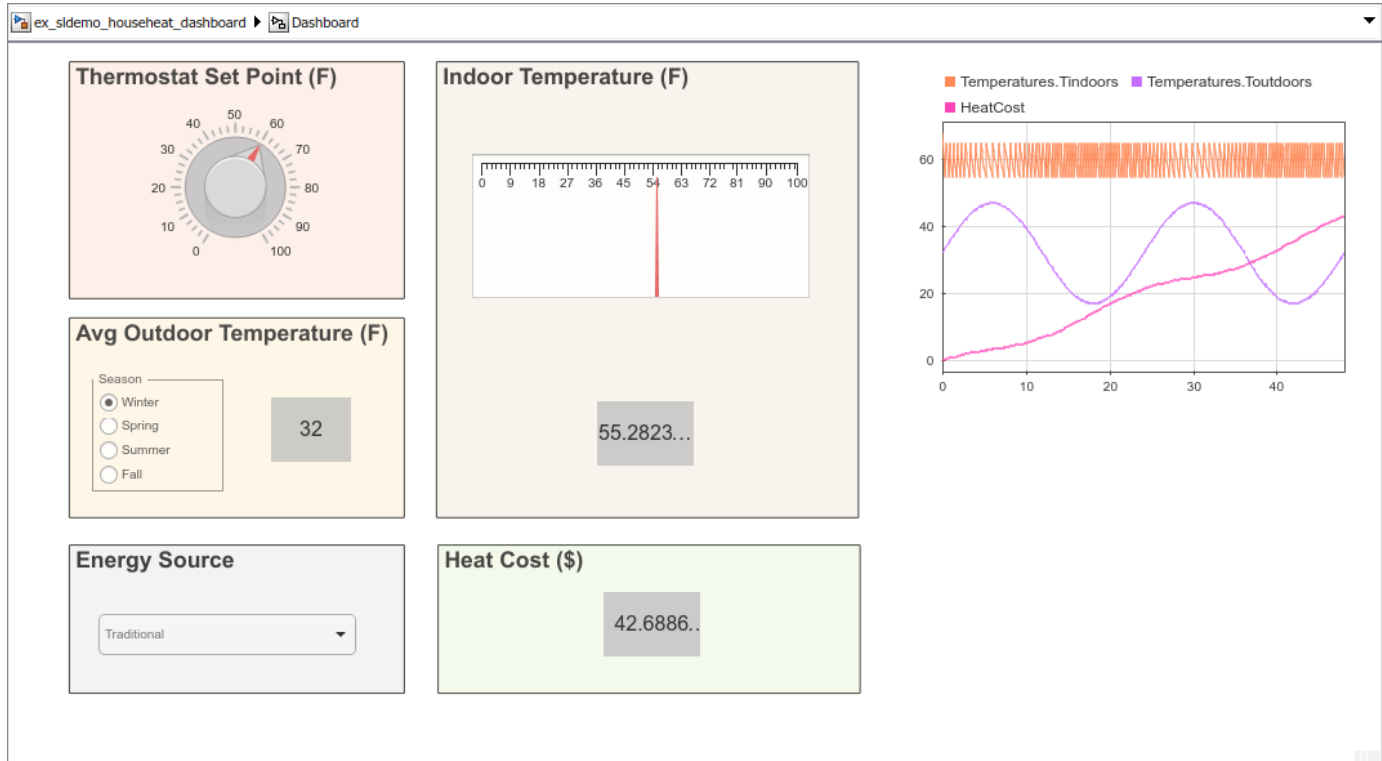

Build the Dashboard Subsystem

This model uses a Subsystem block to organize the controls and displays for the model in a single interface. To create the subsystem in this example:

1. Add a Subsystem block to the model.
2. Delete the prepopulated contents of the subsystem. A subsystem of Dashboard blocks does not require Inport or Outport blocks because Dashboard blocks do not use ports to make connections.
3. Add the components of the dashboard.

The dashboard for this model includes a Knob block, a Radio Button block, and a Combo Box block to modify simulation parameters. A Linear Gauge block, three Display blocks, and a Dashboard Scope block display key signals during simulation.

You can use areas in the subsystem to group and label related controls and displays. For more information about creating areas, see “Box and Label Areas of a Model”.

Connect Dashboard Blocks to the Model

To explore connections between each block in the Dashboard subsystem and the model, you can select a block in the dashboard, pause on the ellipsis that appears above it, and click Jump to Connected Element. The Simulink® editor navigates to and highlights the block or signal connected to that block in the dashboard.

- The Knob block connects to the Set Point block and allows you to adjust the thermostat set point in the model during simulation.
- The Radio Button Block connects to the Avg Outdoor Temp block and maps seasonal average temperatures for Boston, MA, to season labels. Right-click the Radio Button block and select Block Parameters from the context menu to modify the average temperature value used for each season.
- The Display block in the Avg Outdoor Temperature area shows the outdoor temperature value used in the simulation based on the selected season.
- The Combo Box block connects to the Gain block used to calculate the cost during simulation. Right-click the Combo Box block and select Block Parameters from the context menu to view or modify the cost, specified in units of cents per Joule.
- The Linear Scale and Display blocks in the Indoor Temperature area provide analog and digital indications of the instantaneous value of the house temperature during simulation.
- The Display block in the Heat Cost area shows the cumulative cost of heating the house over the course of the simulation is shown on a Display block.
- The Dashboard Scope block displays the heat cost, indoor temperature, and outdoor temperature in the same plot.

Interactively Simulate

This model uses simulation pacing to slow model execution so you can interact with the model during simulation. For more information, see “Simulation Pacing”.

The simulation is set up to run for 48 hours. Within that time period, it makes sense to use the Radio Button block and Combo Box block to configure a simulation for a particular season and energy source. If you want to run another type of simulation where you interactively modify the season or energy source, consider lengthening the simulation time to something more realistic for those types of changes.

Choose the season and energy source for a 48-hour simulation, and then run the simulation. During the simulation, use the Knob block to adjust the set point for the house thermostat, and observe the effect of the change on the indoor temperature and heat cost.

Create a Realistic Dashboard Using the Circular Gauge Block

You can use the Circular Gauge block to create a dashboard of controls and indicators for your model that looks how it would in a real system. This example model uses four Circular Gauge blocks and a MultiStateImage block to create a dashboard for the `sf_car` model like one you might see in a real car.



Explore the Model

To understand the connections between the Dashboard subsystem and the model, you can select each block and jump to the signal it displays in the model. To jump to the connected signal, first select a block. For example, select the speedometer gauge on the left. Select the **Gauge** tab that appears in the toolstrip and then select **Show Connection**. The model navigates to where the connected signal exists and briefly highlights the signal.

The Circular Gauge block on the left displays the `vehicle speed` signal, acting as a speedometer on the dashboard. The block uses the default Circular Gauge appearance and a value arc you can see when you simulate the model.



The Circular Gauge blocks at the top of the model display the throttle and brake signals. You can create this type of gauge by deleting the background image and needle image from the default Circular Gauge. Then, adjust the scale arc and select colors for the tick marks, scale, and value arc.



The Circular Gauge block on the right displays the engine RPM signal on a custom gauge face. You can create a gauge like this by deleting the background image in the default Circular Gauge and uploading your own.



The MultiStateImage block on the bottom displays the gear signal using seven segment display style number images that correspond to the value of the gear signal.



Monitor System During Simulation

You can use the dashboard to monitor the system response during simulation. The User Inputs block includes several simulation inputs to model different vehicle maneuvers. To change the simulation input, navigate to the top level of the model and open User Inputs. You can use the drop-down menu to choose the vehicle action for the model to simulate. Choose between a passing maneuver, gradual acceleration, hard braking, and coasting. To monitor the system response during simulation, navigate back to the Dashboard subsystem and press the play button to simulate the model.

Solve a Linear System of Algebraic Equations

Use the Algebraic Constraint block to solve the system

$$\begin{aligned} z_1 + z_2 &= 1 \\ z_2 - z_1 &= 1 \end{aligned}$$

The model represents the problem in a vectorized form as

$$\begin{bmatrix} 1 & 1 \\ -1 & 1 \end{bmatrix} \begin{bmatrix} z_1 \\ z_2 \end{bmatrix} = \begin{bmatrix} 1 \\ 1 \end{bmatrix}$$

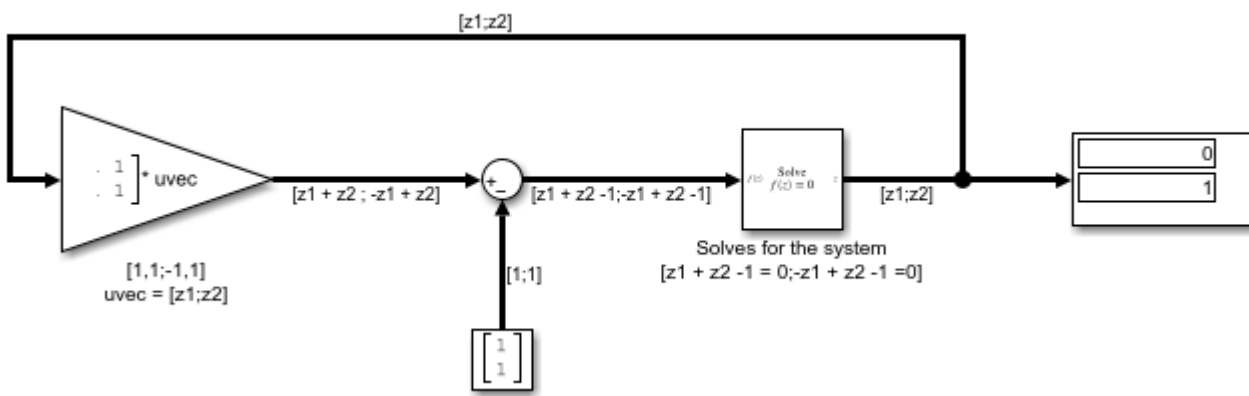

The signal fed to the Algebraic Constraint block $f(z)$ is a 2×1 vector of the form

$$\begin{bmatrix} z_1 + z_2 - 1 \\ -z_1 - 1 + z_2 - 1 \end{bmatrix}$$

The block is configured to constrain $f(z)$ to 0. Thus solving for $f(z) = 0$ yields the solution $z_1 = 0, z_2 = 1$

Model a Planar Pendulum

Consider a point mass m suspended by a massless rod of length l under the influence of gravity. The position of the mass can be expressed in Cartesian coordinates by (x,y) .

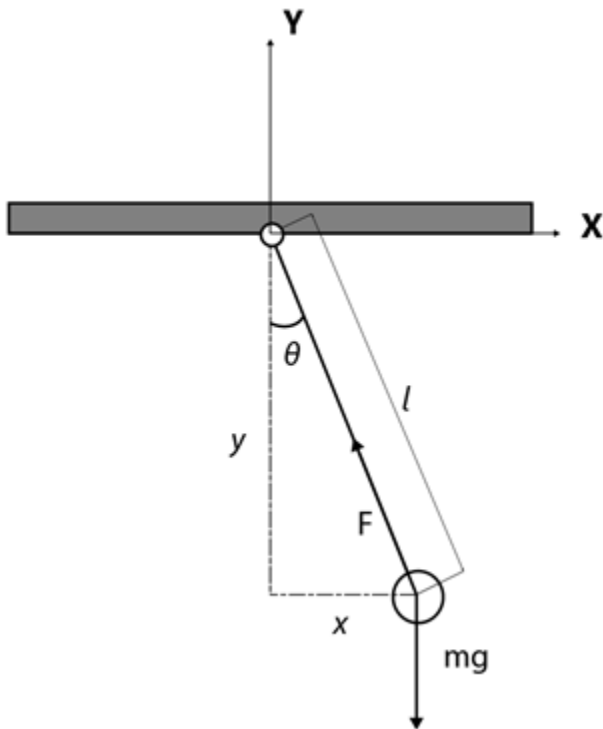

Modeling the System

A force balance of the mass gives the equations of motion in the x and y directions.

$$m\ddot{x} = F \sin \theta \quad (1)$$

$$m\ddot{y} + F \cos \theta = -mg \quad (2)$$

Let (u, v) be the velocities in (x, y) respectively. The system can be rewritten as a system of first order ODEs

$$\dot{x} = u \quad (3)$$

$$\dot{u} = -F \frac{x}{ml} \quad (4)$$

$$\dot{y} = v \quad (5)$$

$$\dot{v} = -F \frac{y}{ml} - g \quad (6)$$

where F is the tension in the rod. The system also possesses the geometric constraint

$$x^2 + y^2 = l^2 \quad (7)$$

Differentiate (7) twice with respect to time t to arrive at

$$m(u^2 + v^2) - Fl - mgy = 0 \quad (8)$$

This relationship is useful since it allows F to be determined at every step for use in modeling the kinematics of the system.

Simulating the System

The system is simulated as shown in the figure below

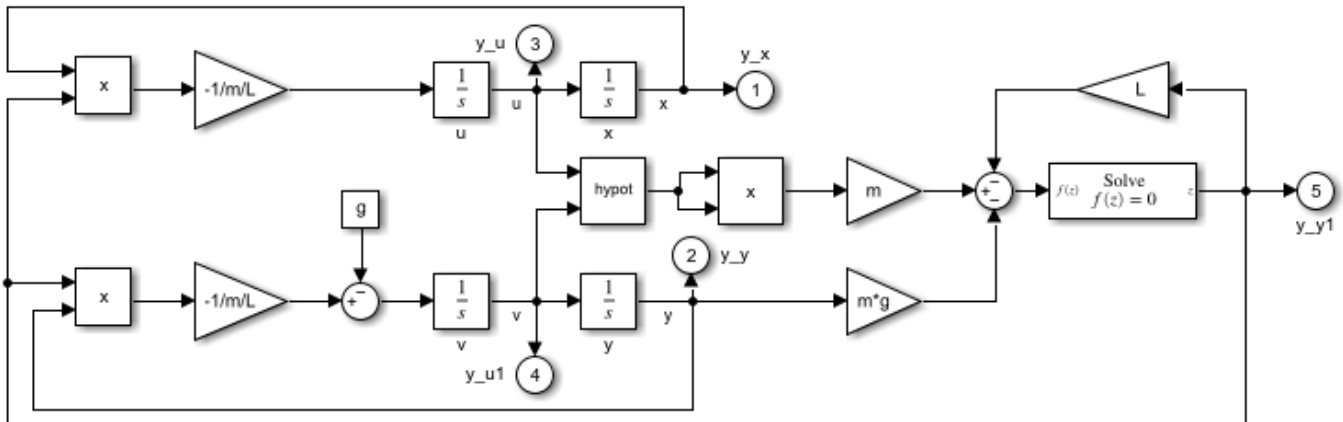

Equation (8) contains one unknown F and is of the form $f(z) = 0$ where $f(z) = m(u^2 + v^2) - Fl - mgy$. The Algebraic Constraint block constrains $f(z)$ to 0 and solves for F in accordance with (8).

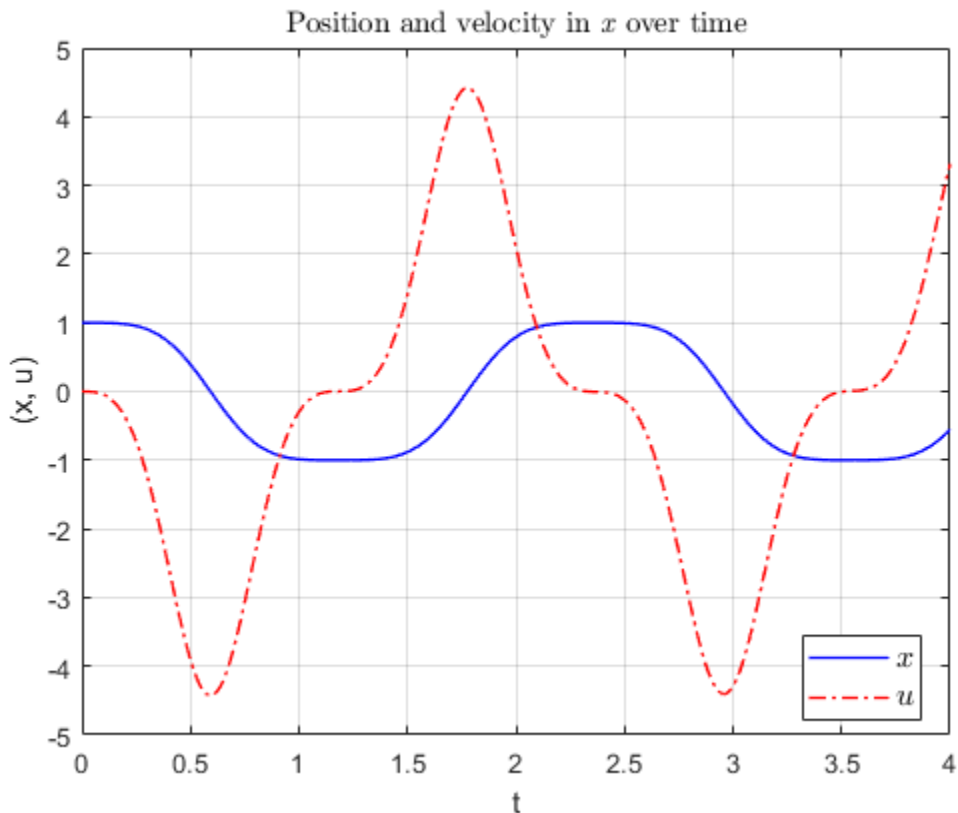

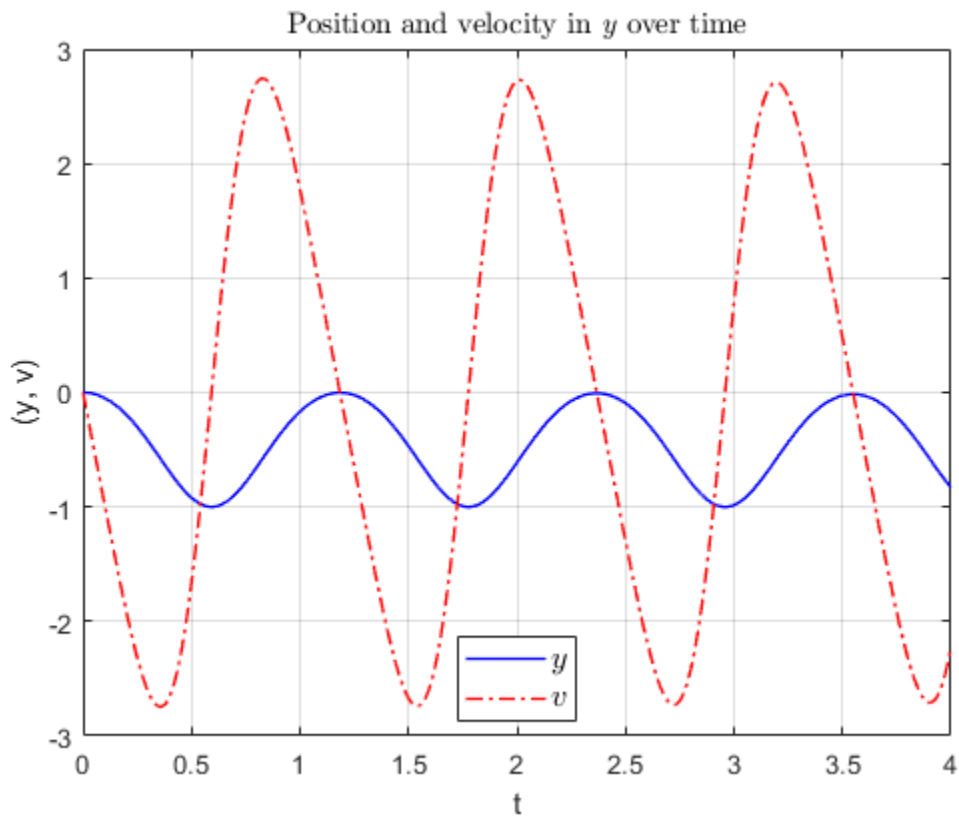

References

Hairer, Ernst, Christian Lubich, and Michel Roche. "The Numerical Solution Of Differential-Algebraic Systems By Runge-Kutta Methods." *Lecture Notes in Mathematics*. Vol. 1409, Berlin: Springer-Verlag, 1989: pp. 8-9.

Improved Linearization with Transfer Fcn Blocks

The Laplace domain transfer function for the operation of differentiation is:

$$\frac{Y(s)}{X(s)} = s$$

This equation is not a proper transfer function, nor does it have a state-space representation. As such, the Simulink software linearizes this block as an effective gain of 0 unless you explicitly specify that a proper first-order transfer function should be used to approximate the linear behavior of this block.

To improve linearization, you can also try to incorporate the derivative term in other blocks. For example, if you have a Derivative block in series with a Transfer Fcn block, try using a single Transfer Fcn block of the form

$$\frac{s}{s+a}$$

For example, you can replace the first set of blocks in this figure with the blocks below them:

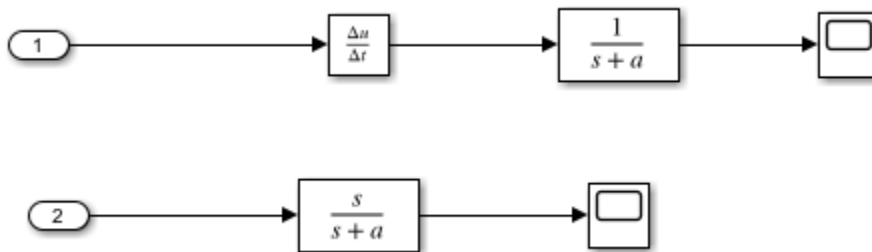

View Dead Zone Output on Sine Wave

This example shows the effect of the Dead Zone block on a sine wave. The model uses a dead zone lower limit of -0.5 and an upper limit as 0.5 . Set these values through the parameters **Start of Dead Zone** and **End of Dead Zone**.

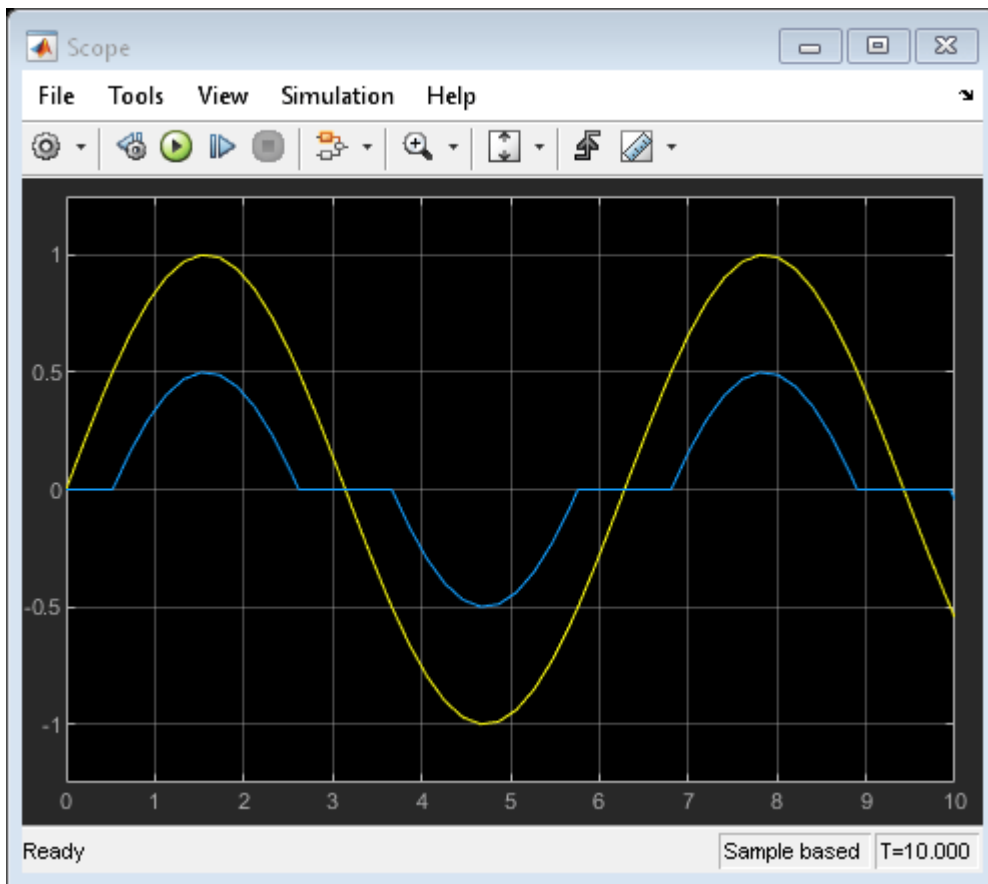
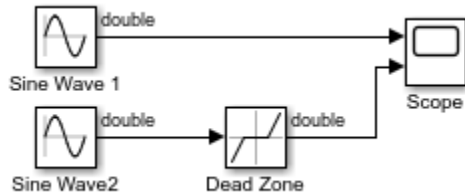

View Backlash Output on Sine Wave

This example shows the effect of the Backlash block on a sine wave using default parameters. The initial **Deadband width** is 1 and the **Initial output** is 0.

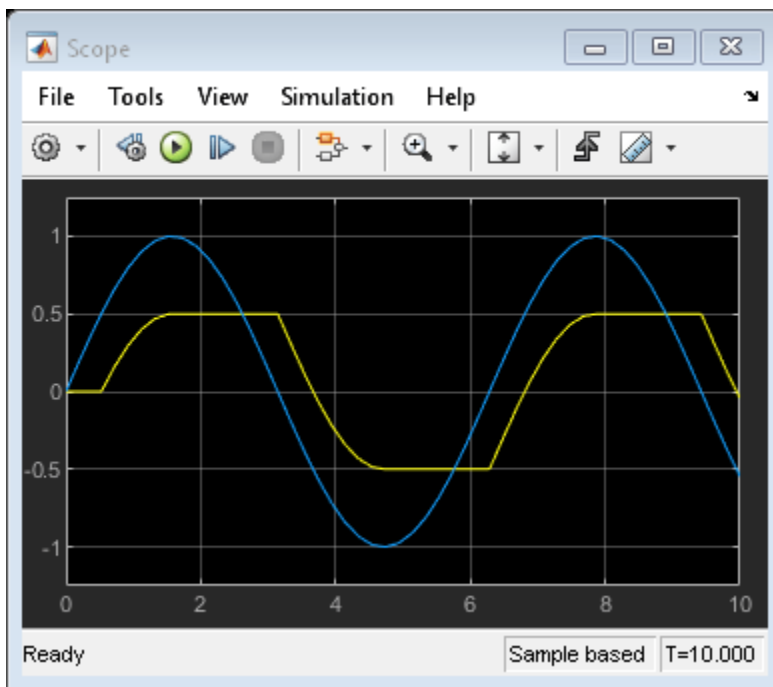
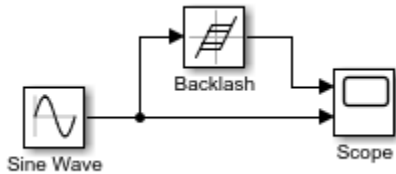

The initial deadband is centered around 0 and has a width of 1, which extends .5 in each direction. The output from the Backlash block begins at 0 and does not change until the input reaches the edge of the deadzone at .5. Then the output engages in a positive direction and changes an equal amount as the input. After the input reaches a value of 1, it starts moving in a negative direction. At this point the output disengages and stays flat until the input passes through the deadband width of 1. Once the input reaches the end of the deadband zone at 0, then the output engages and starts moving in a negative direction with the input.

Prelookup With External Breakpoint Specification

This example shows how to feed a breakpoint dataset from a Constant block to the bp input port of the Prelookup block.

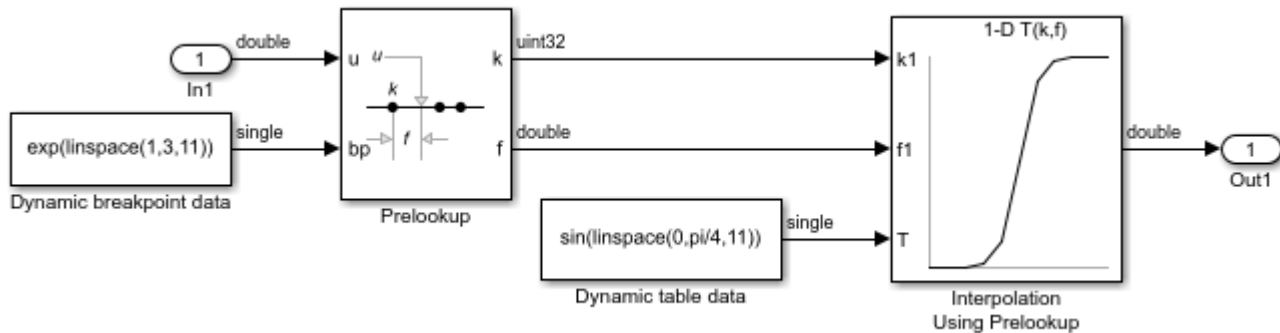

The Prelookup block inherits the following breakpoint attributes from the bp input port:

- **Minimum:** Inf
- **Maximum:** Inf
- **Data type:** single

Similarly, a Constant block feeds the table data values to the T input port of the Interpolation Using Prelookup block, which inherits the following attributes:

- **Minimum:** Inf
- **Maximum:** Inf
- **Data type:** single

Simulink® uses double-precision, floating-point data to perform the computations in this model. However, the model stores the breakpoint and table data as single-precision, floating-point data. Using a lower-precision data type to store breakpoint and table data reduces the memory requirement.

Prelookup with Evenly Spaced Breakpoints

This example shows how to specify evenly spaced breakpoint data in the Prelookup block.

In the **Breakpoints data** section, the **Specification** parameter is set to `Even spacing`. The parameters **First point**, **Spacing**, and **Number of points** are set to 25, 12, and 4 respectively. Specifying these parameters creates four evenly spaced breakpoints: [25, 37, 49, 61].

An alternative way to specify evenly spaced breakpoints is to set **Specification** to `Explicit values` and set **Value** to [25:12:61].

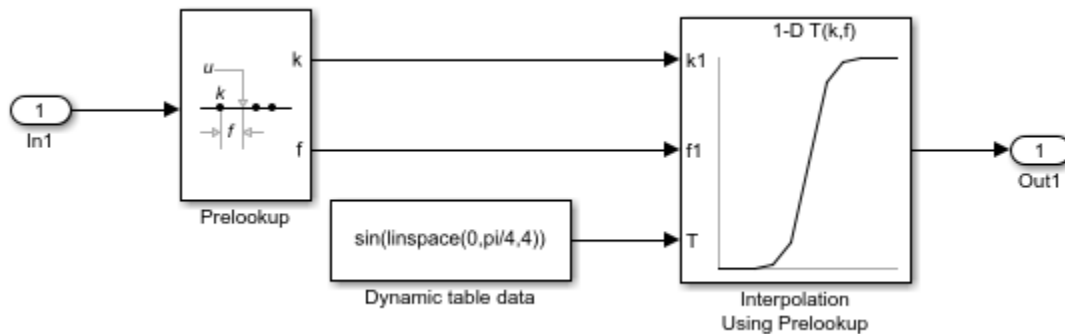

Simulink® uses double-precision, floating-point data to perform the computations in this model. However, the model stores the breakpoints and table data as double.

Configure the Prelookup Block to Output Index and Fraction as a Bus

This example shows how to output a bus containing the index (k) and fraction (f) from the Prelookup block. The bus object can then be used as an input to the Interpolation Using Prelookup block. The example also shows how to get the same results without using a bus object.

Open and simulate the model.

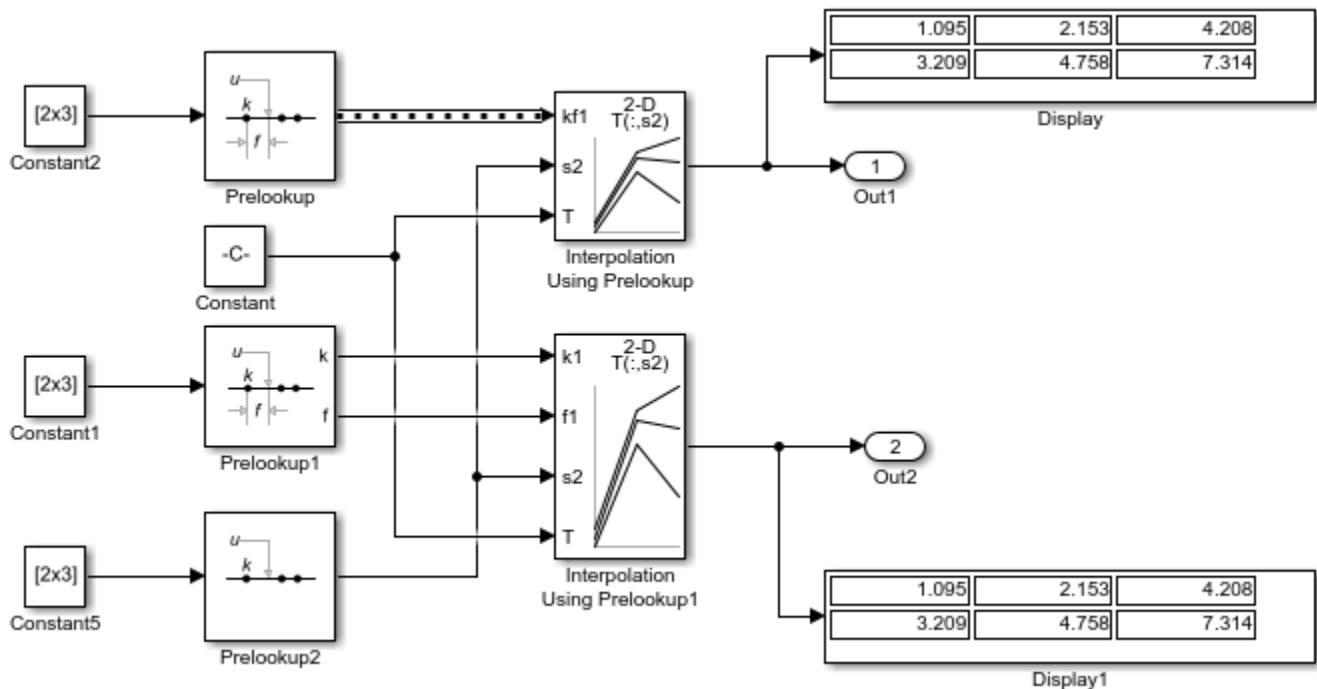

At the top of the model, open the dialog box for the Prelookup block. In the **Main** tab, note that **Output selection** is set to Index and fraction as bus. In the **Data Types** tab, note that **Output** is set to Bus: myBus. In the Simulink® Editor, select **Modeling>Model Settings>Model Properties** and open the **Callbacks** tab. In the model's PreLoadFcn, the code defines the bus object myBus, which specifies the index as the first bus element and the fraction as the second element.

Open the dialog box for the Interpolation Using Prelookup block. In the **Main** tab, note that **Require index and fraction as bus** check box is selected. That option configures the block to use the bus output from the Prelookup block.

Approximating the sinh Function Using the Lookup Table Dynamic Block

This example shows how to use the Lookup Table Dynamic block to approximate the \sinh function. The breakpoint data is given by the vector $[-5:5]$ and the table data is given by the vector $\sinh([-5:5])$. The input x is provided by the Constant block as a 1-by-3 vector containing values that are below, within, and above the breakpoint data values.

To see how each lookup method handles input values that are below, within, and above the breakpoint data values, change the value of the **Lookup Method** parameter on the Lookup Table Dynamic block.

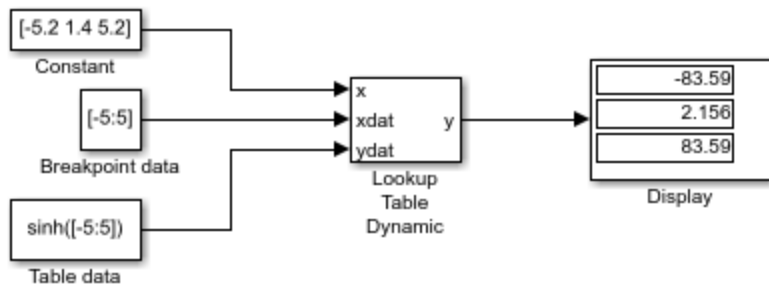

The Lookup Table Dynamic block outputs the following values when using the specified lookup methods and inputs.

| Lookup Method | Input | Output | Comment |
|------------------------------|-------|--------|--|
| Interpolation-Extrapolation | 1.4 | 2.156 | N/A |
| | 5.2 | 83.59 | N/A |
| Interpolation-Use End Values | 1.4 | 2.156 | N/A |
| | 5.2 | 74.2 | The block uses the value for $\sinh(5.0)$. |
| Use Input Above | 1.4 | 3.627 | The block uses the value for $\sinh(2.0)$. |
| | 5.2 | 74.2 | The block uses the value for $\sinh(5.0)$. |
| Use Input Below | 1.4 | 1.175 | The block uses the value for $\sinh(1.0)$. |
| | -5.2 | -74.2 | The block uses the value for $\sinh(-5.0)$. |
| Use Input Nearest | 1.4 | 1.175 | The block uses the value for $\sinh(1.0)$. |

Create a Logarithm Lookup Table

This example shows how to use the n-D Lookup Table block to create a logarithm lookup table. The lookup table allows you to approximate the common logarithm (base 10) over the input range [1,10] without performing an expensive computation.

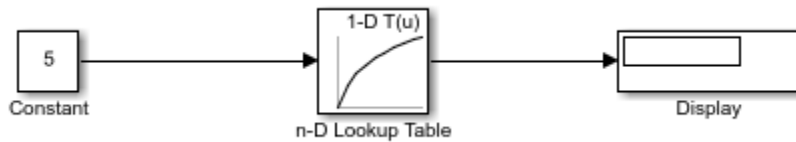

Providing Table Data as an Input to the Direct Lookup Table Block

This example shows how to provide table data as an input to the Direct Lookup Table block. In the following model, `a` is a 4-D array of linearly increasing values that you define with the following model preload function:

```
a = reshape(1:2800, [4 5 20 7]);
```

When you run the model, you get the following results:

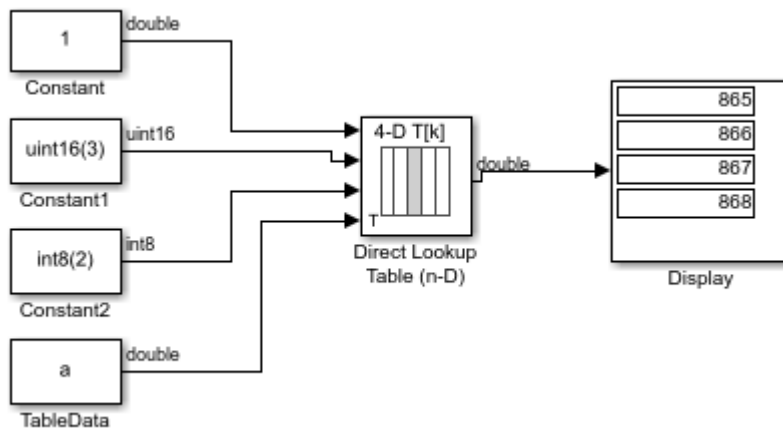

The block labeled TableData feeds a 4-D array to the Direct Lookup Table (n-D) block, with a data type of double. Because the Direct Lookup Table (n-D) block uses zero-based indexing, the output is:

```
a(:,2,4,3)
```

The output has the same data type as the table data input signal: double.

Specifying Table Data in the Direct Lookup Table Block Dialog Box

This example shows how to specify table data on the dialog box of the Direct Lookup Table (n-D) block. In the following model, the table data is a 4-D array of linearly increasing values that you define with the following model preload function:

```
a = reshape(1:2800, [4 5 20 7]);
```

When you run the model, you get the following results:

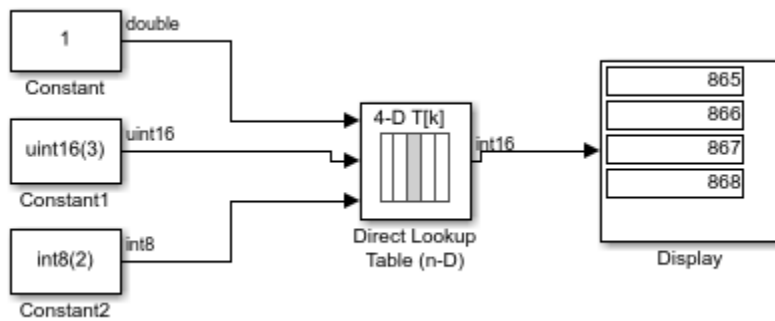

Because the Direct Lookup Table (n-D) block uses zero-based indexing, the output is:

```
a(:,2,4,3)
```

The output data type matches the Direct Lookup Table block's **Table data type**, which is set to `int16`.

Using the Quantizer and Saturation blocks in sldemo_boiler

This example shows how the Quantizer and Saturation blocks are used in the model ex_sldemo_boiler. The ADC subsystem digitizes the input analog voltage by:

- Multiplying the analog voltage by 256/5 with the Gain block
- Rounding the value to integer floor with the Quantizer block
- Limiting the output to a maximum of 255 (the largest unsigned 8-bit integer value) with the Saturation block

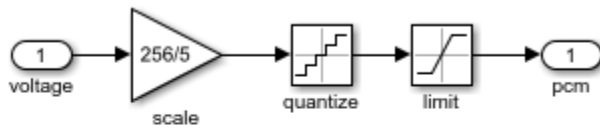

This subsystem models a typical 8-bit analog-to-digital converter having an input range of 0-5 volts

Scalar Expansion with the Coulomb and Viscous Friction Block

This example shows a model with a scalar input to a Coulomb & Viscous Friction block that uses scalar expansion to output a vector.

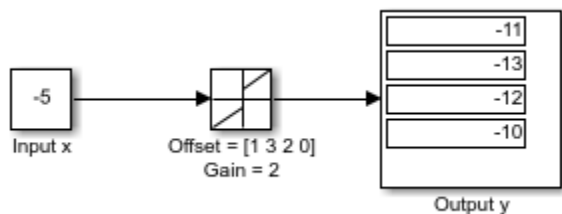

Double click the friction block to see the parameters. **Coefficient of viscous friction (Gain)** is a scalar value 2, but **Coulomb friction value (Offset)** is a vector value [1 3 2 0]. Therefore, the block uses element-wise scalar expansion to compute the output.

Each output is calculated using this formula.

$$y = \text{sign}(x) .* (\text{Gain} .* \text{abs}(x) + \text{Offset})$$

For example, the first offset 1 is calculated as follows.

$$y = - * ((2 * 5) + 1)$$

$$y = -11$$

If the dimensions for the input and Offset are the same, then no expansion is necessary.

Sum Block Reorders Inputs

This example shows how the Sum block reorders inputs. If you use a - sign as the first operation, the block reorders the inputs, if possible, to use a + operation. For example, in the expression $\text{output} = -a - b + c$, the Sum block reorders the input so that $\text{output} = c - a - b$. To initialize the accumulator, the Sum block uses the first + input port.

The block avoids performing a unary minus operation on the first operand a because doing so can change the value of a for fixed-point data types. In that case, the output value differs from the result of accumulating the values for a , b , and c .

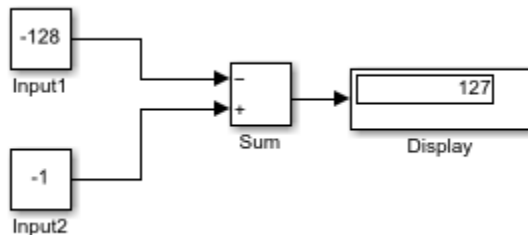

Both the constant inputs use `int8` data types. The Sum block also uses `int8` for the accumulator and output data types and has **Saturate on integer overflow** turned on. The Sum block reorders the inputs to give the ideal result of 127.

- 1 Reorders inputs from $(-Input1 + Input2)$ to $(Input2 - Input1)$.
- 2 Initializes the accumulator by using the first + input port. $\text{Accumulator} = \text{int8}(-1) = -1$
- 3 Continues to accumulate values. $\text{Accumulator} = \text{Accumulator} - \text{int8}(-128) = 127$
- 4 Calculates the block output. $\text{Output} = \text{int8}(127) = 127$

If the Sum block does not reorder the inputs, then you get the nonideal result of 126.

- 1 Initializes the accumulator by using the first input port. $\text{Accumulator} = \text{int8}(-(-128)) = 127$
- 2 Because saturation is on, the initial value of the accumulator saturates at 127 and does not wrap.
- 3 Continues to accumulate values. $\text{Accumulator} = \text{Accumulator} + \text{int8}(-1) = 126$
- 4 Calculates the block output. $\text{Output} = \text{int8}(126) = 126$

To explicitly specify a unary minus operation for $\text{output} = -a - b + c$, you can use the Unary Minus block in the Math Operations library.

Iterated Assignment with the Assignment Block

This example shows using the Assignment block to assign values computed in a For or While Iterator loop to successive elements. You can use vector, matrix or multidimensional signals and do the assignment in a single time step. In this model, the For Iterator block creates a vector signal each of whose elements equals $3 * i$ where i is the index of the element.

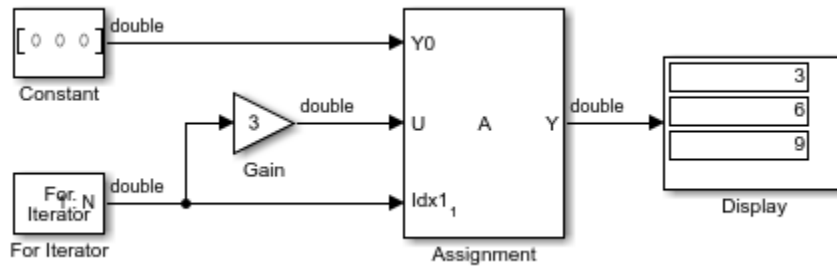

The iterator generates indices for the Assignment block. On the first iteration, the Assignment block copies the first input (Y0) to the output (Y) and assigns the second input (U) to the output Y(E1). On successive iterations, the Assignment block assigns the current value of U to Y(Ei), that is, without first copying Y0 to Y. These actions occur in a single time step.

View Sample Time Using the Digital Clock Block

This example shows how to view the simulation sample time at a specified sampling interval using the Digital Clock block. In this model, the Scope shows the output of a Digital Clock block with the **Sample time** set to 0.2.

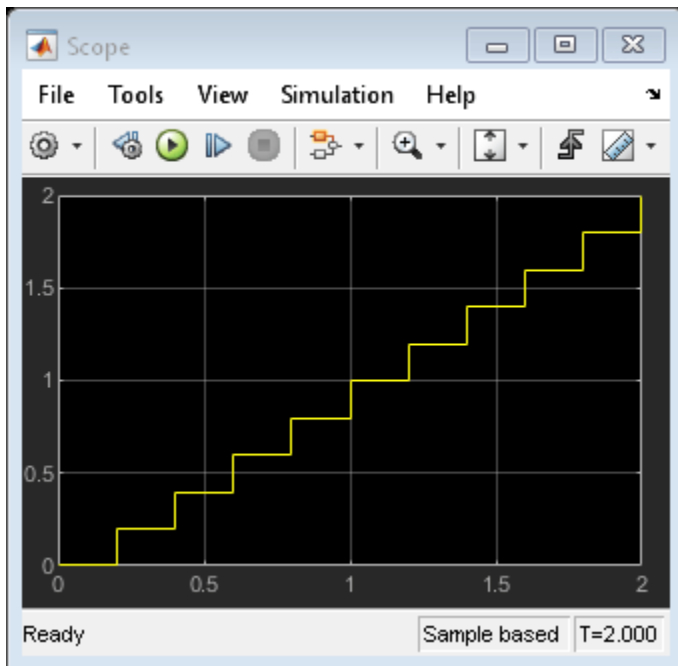
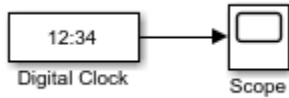

In this configuration, the Digital Clock block outputs the simulation time every 0.2 seconds. Otherwise, the block holds the output at the previous value.

Bit Specification Using a Positive Integer

This example shows how to specify the **Number of bits** in the Counter Free-Running block as a positive integer.

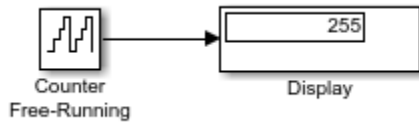

At $t = 255$, the counter reaches the maximum value of $(2^8) - 1$. If you increase the stop time of the simulation to 256, the counter wraps to zero.

Bit Specification Using an Unsigned Integer Expression

This example shows how to specify the **Number of bits** in the Counter Free-Running block as an unsigned integer expression.

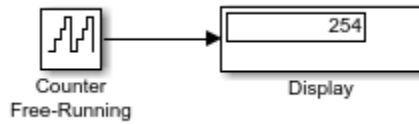

At $t = 254$, the counter reaches the maximum value of $\text{uint8}(2^{(\text{uint8}(8))} - 1)$. If you increase the stop time of the simulation to 255, the counter wraps to zero.

Track Running Minimum Value of Chirp Signal

This example shows how to track the running minimum value of a signal generated by the Chirp Signal block.

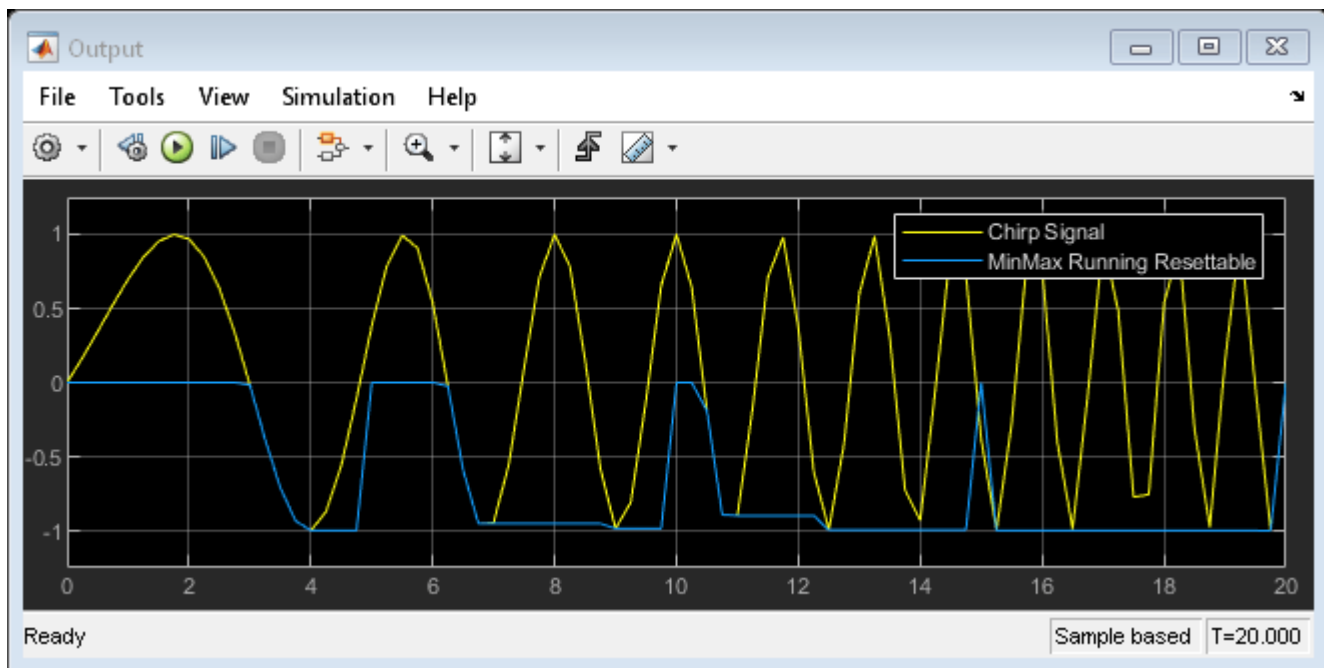
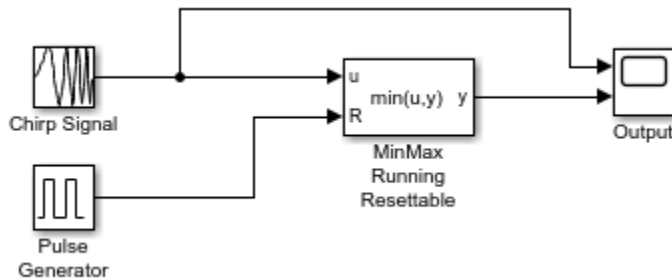

The Chirp Signal block generates a sine wave whose frequency increases at a linear rate with time. The MinMax Running Resettable block tracks the minimum value of that chirp signal over time. The running minimum value is reset every 5 seconds by the Pulse Generator block.

Horizontal Matrix Concatenation

This example shows how to perform a horizontal matrix concatenation with the Matrix Concatenate block. When you set the **Concatenate dimension** parameter to 2 and the inputs are 2-D matrices, the block performs horizontal matrix concatenation and places the input matrices side-by-side to create the output matrix.

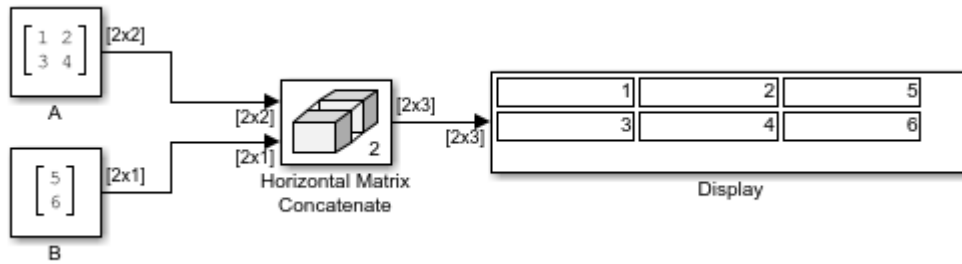

Vertical Matrix Concatenation

This example shows how to perform a vertical matrix concatenation with the Matrix Concatenate block. When you set the **Concatenate dimension** parameter to 1 and the inputs are 2-D matrices, the block performs vertical matrix concatenation and places the input matrices on top of each other to create the output matrix.

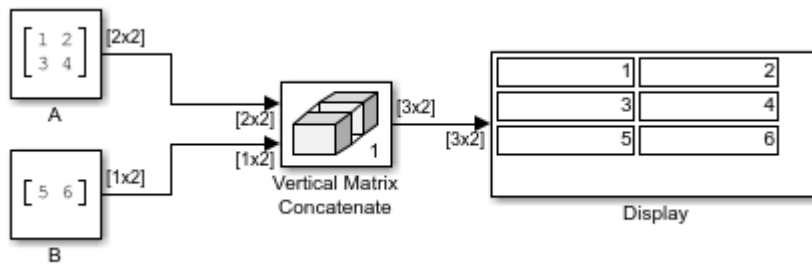

Multidimensional Matrix Concatenation

This example shows how to perform multidimensional matrix concatenation with the Matrix Concatenate block. When you set the **Concatenate dimension** parameter to 3 and the inputs are 2-D matrices, the block performs multidimensional matrix concatenation.

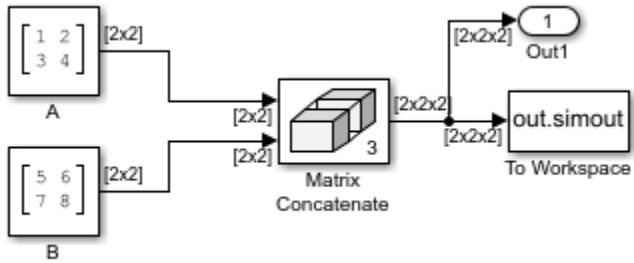

Unary Minus of Matrix Input

This example shows how to compute the unary minus of a matrix input.

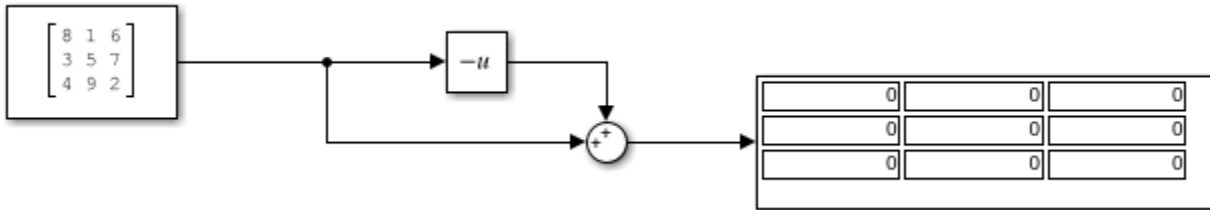

Sample Time Math Operations Using the Weighted Sample Time Math Block

This example shows how to add the sample time value to a signal using the Weighted Sample Time Math block.

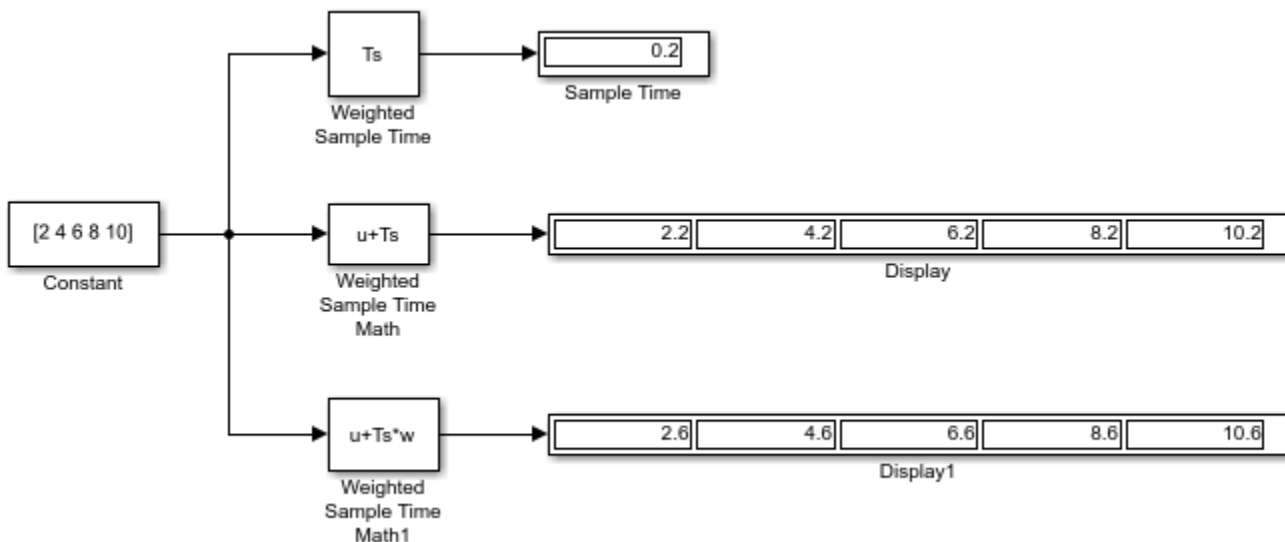

Using the Weighted Sample Time block, you can see the sample time of this model is 0.2 . When you set the **Operation** parameter to $+$ and the **Weight value** to 1 on the Weighted Sample Time Math block, the block adds the sample time value of 0.2 to the input signal. When you set the **Weight value** to 3 in the Weighted Sample Time Math1 block, the block adds T_s*3 to the input signal, thus increasing each value by 0.6 .

Construct Complex Signal from Real and Imaginary Parts

This example shows how to use the Real-Imag to Complex block to construct a complex-valued signal from real and imaginary parts. You can provide both the real and imaginary parts as block inputs, or provide one value as an input, and the other on the block dialog box.

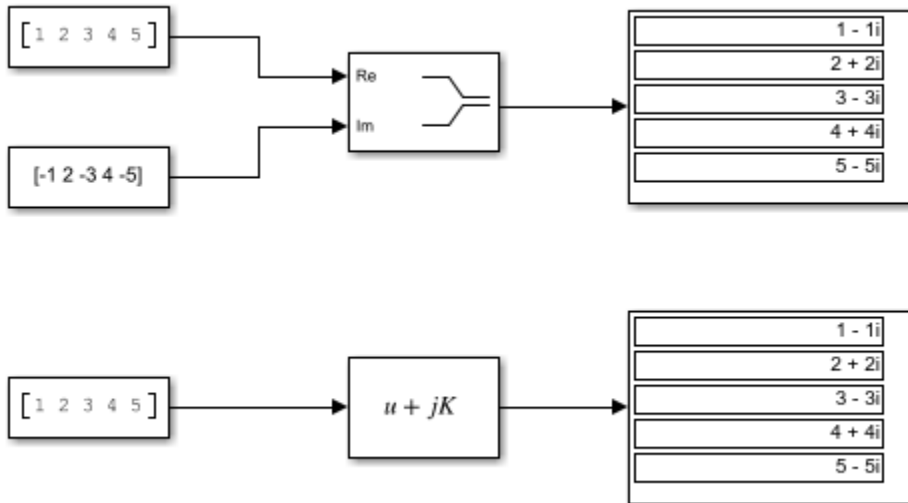

Construct Complex Signal from Magnitude and Phase Angle

This example shows how to use the Magnitude-Angle to Complex block to construct a complex-valued signal. You can provide both the magnitude and phase angle as block inputs, or provide one value as an input, and the other on the block dialog box.

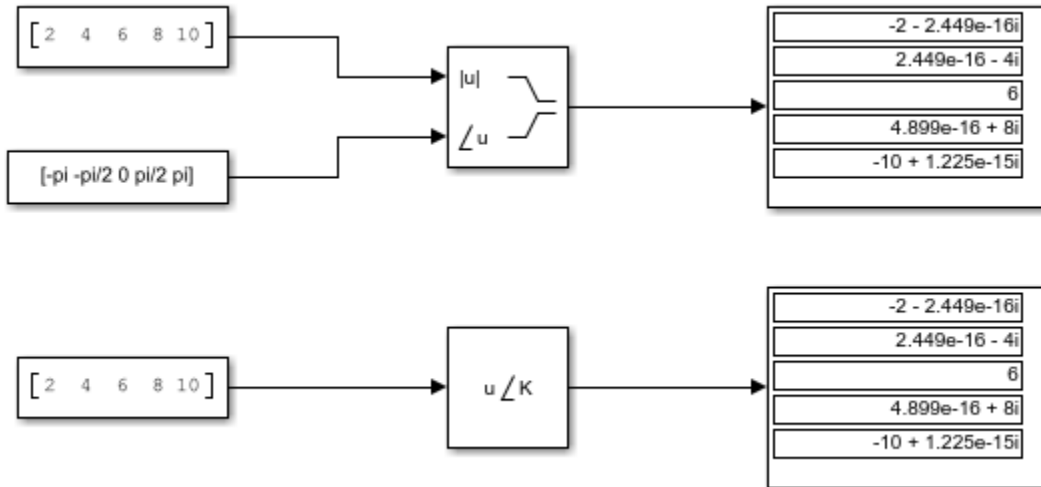

Find Nonzero Elements in an Array

This example shows how to use the Find block to find nonzero elements in an array. In the following model, the block is configured to output both the one-based linear index and the value of each nonzero element.

ans =

```
Simulink.SimulationOutput:  
    tout: [51x1 double]  
  
SimulationMetadata: [1x1 Simulink.SimulationMetadata]  
ErrorMessage: [0x0 char]
```

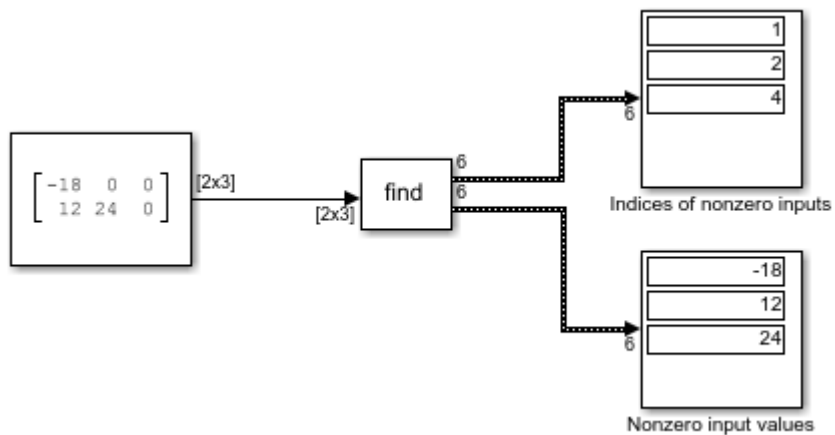

Calculate the Running Minimum Value with the MinMax Running Resettable Block

This example shows how to use the MinMax Running Resettable block to calculate the running minimum value. To watch how the running minimum value changes at each time step, you can use the Step Forward button to advance the simulation one step at a time.

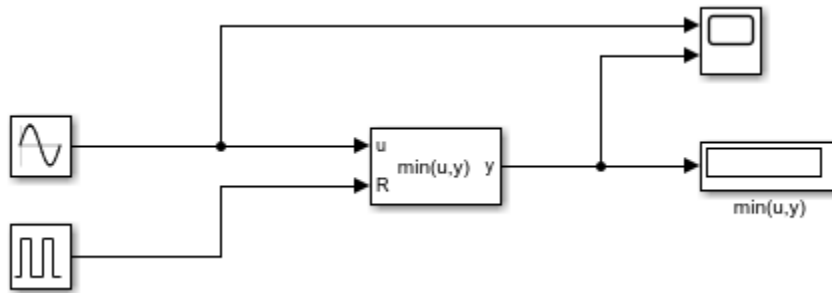

After running the full simulation, you can view the results in the Scope. The initial value of the running minimum is 0. It begins tracking the Sine Wave signal when the sine wave values turn negative. When the MinMax Running Resettable block receives a reset signal at $T=8$, the block resets the running minimum value to 0. The running minimum value tracks at 0 for a few time steps, until the sine wave values turn negative again.

ans =

```
Simulink.SimulationOutput:
      tout: [26x1 double]

SimulationMetadata: [1x1 Simulink.SimulationMetadata]
      ErrorMessage: [0x0 char]
```

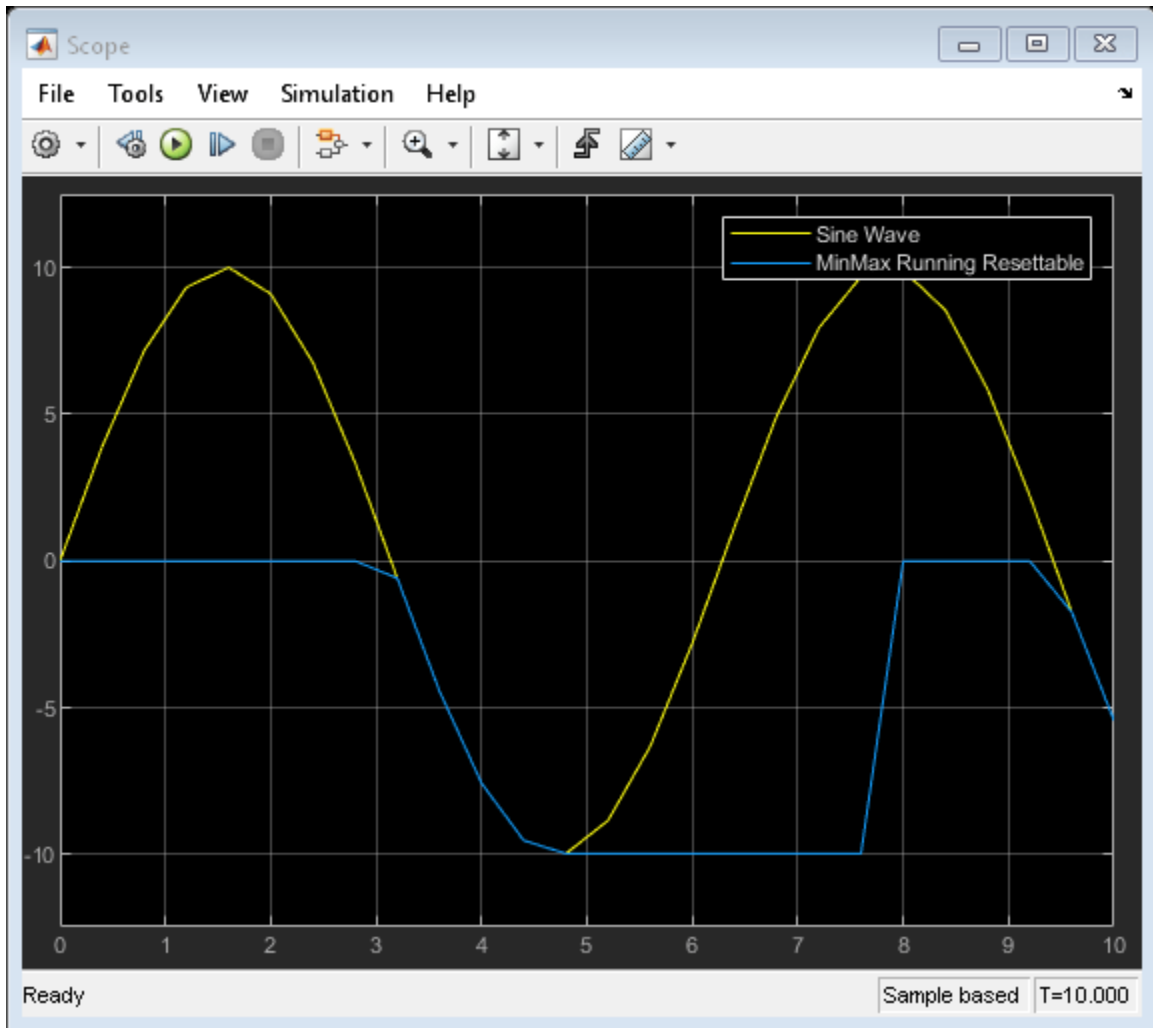

Find Maximum Value of Input

This example shows how to use the MinMax block to output the maximum value of two sine waves.

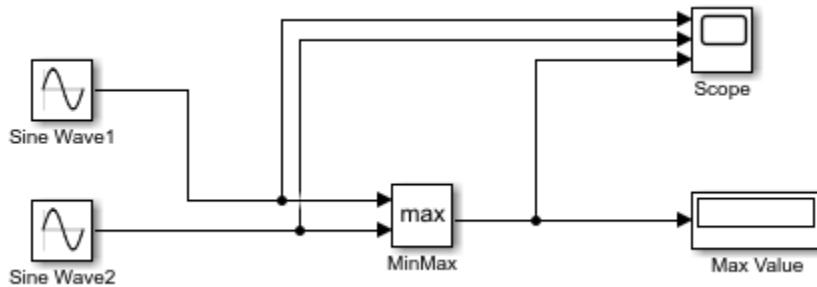

After running the full simulation, you can view the results in the Scope. Initially, the maximum value (orange line) tracks SineWave2. When the SineWave2 values turn negative, the maximum value begins tracking SineWave1. When the SineWave2 values become positive again, the maximum value resumes tracking SineWave2.

ans =

```
Simulink.SimulationOutput:
      tout: [57x1 double]

SimulationMetadata: [1x1 Simulink.SimulationMetadata]
      ErrorMessage: [0x0 char]
```

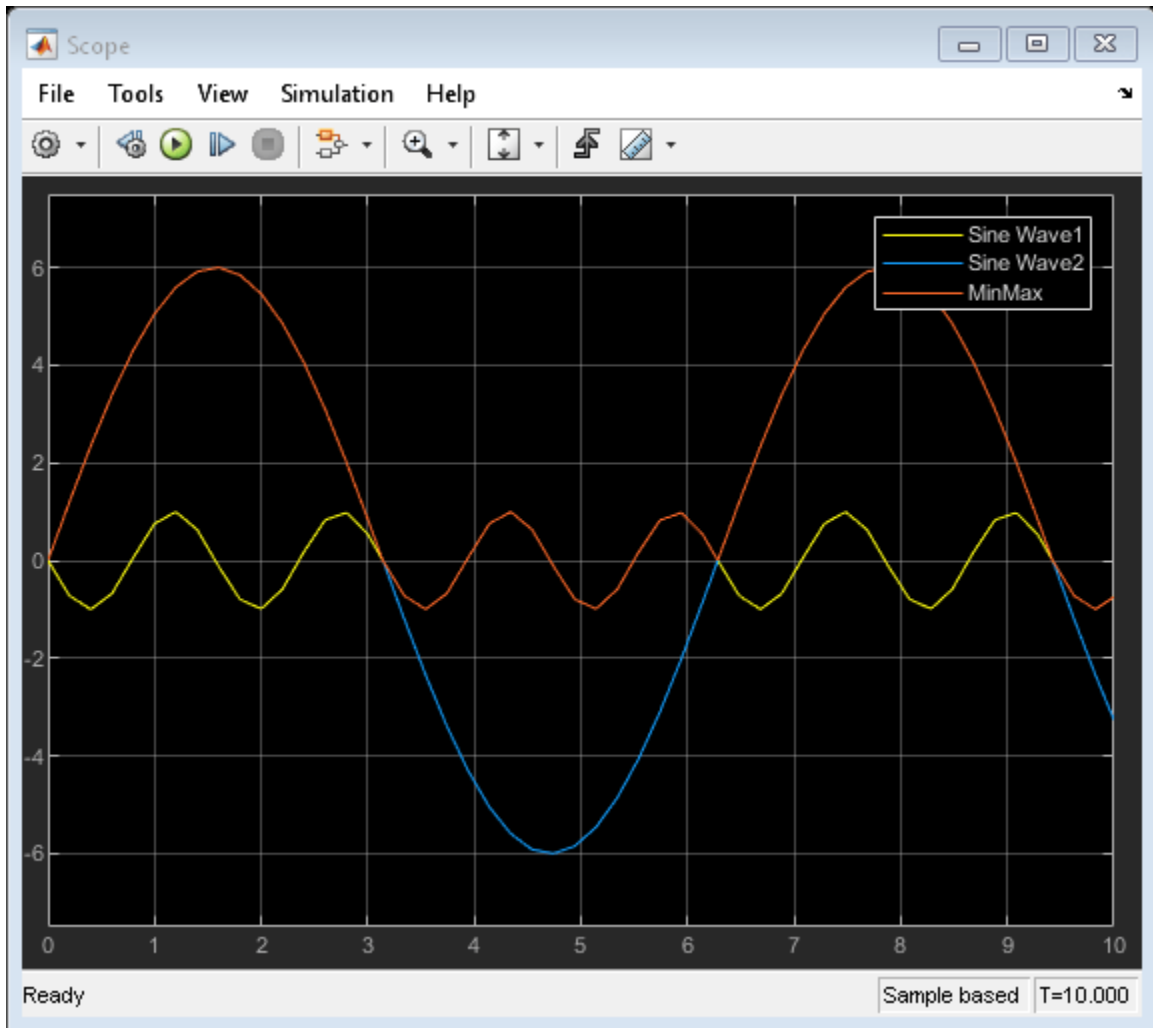

Permute Array Dimensions

This example shows how to use the Permute Dimensions block to permute the first and third dimensions of a 3-by-4-by-5 input array.



When you set the **Order** parameter to `[3, 2, 1]`, the block permutes the first and third dimensions, and outputs a 5-by-4-by-3 array.

Multiply Inputs of Different Dimensions with the Product Block

This example shows how to perform element-wise (\cdot) multiplication of inputs using the Product block. In this example, the Product block multiplies two scalars, a scalar and a vector, and two 2x2 matrices.

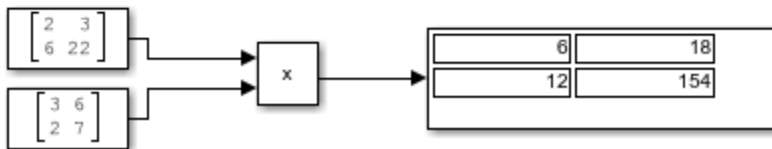
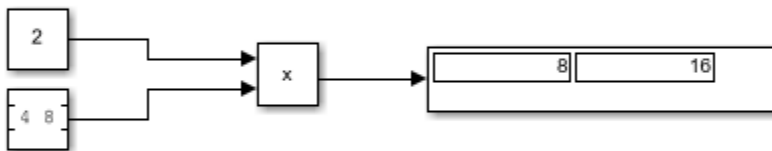
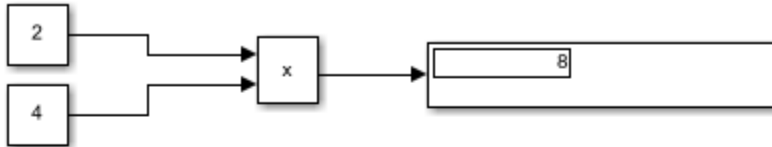

Multiply and Divide Inputs Using the Product Block

This example shows how to multiply and divide several input signals using the Product block.

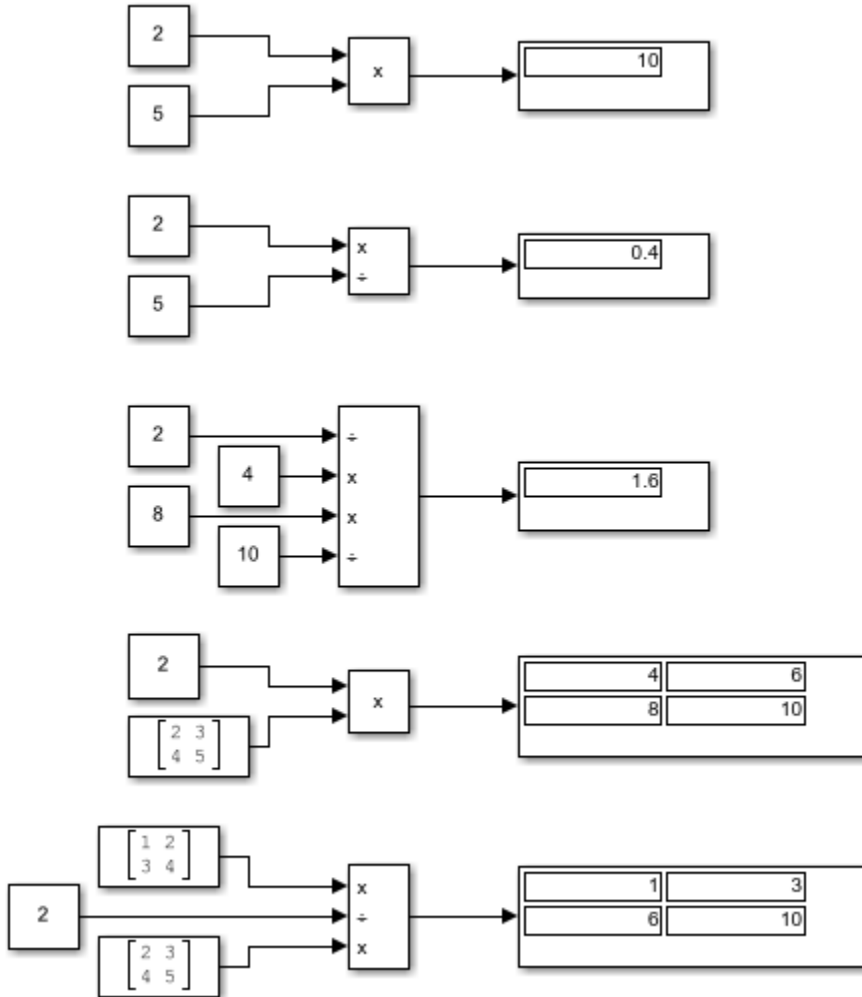

Divide Inputs of Different Dimensions Using the Divide Block

This example shows how to perform element-wise (`./`) division of two inputs using the Divide block. In this example, the Divide block divides two scalars, a vector by a scalar, a scalar by a vector, and two matrices.

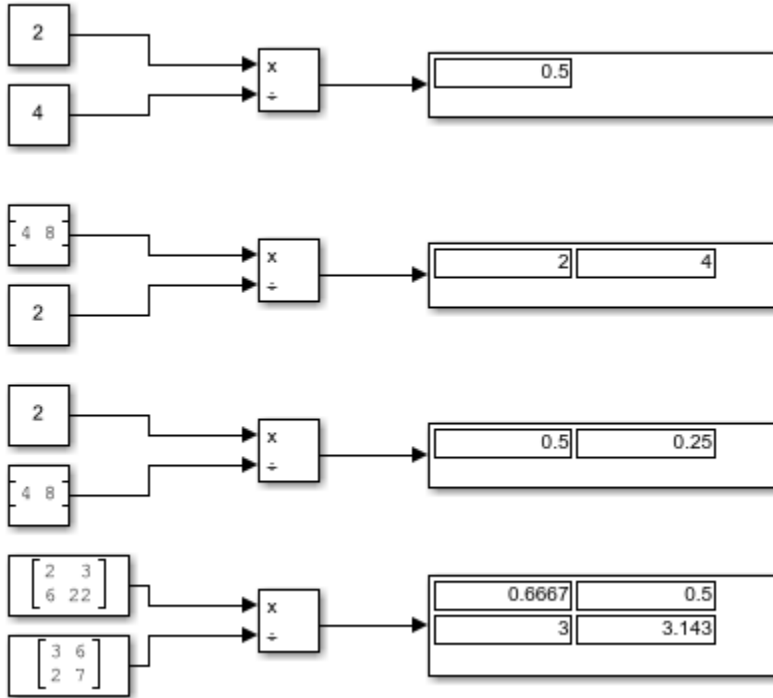

Complex Division Using the Product of Elements Block

This example shows how to perform element-wise complex division using the Product of Elements block.

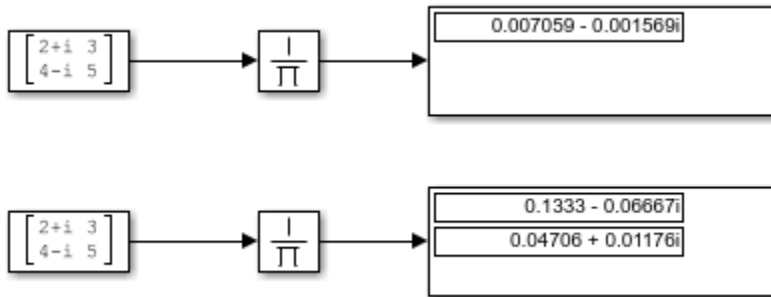

The top Product of Elements block collapses the matrix input to a scalar by taking successive inverses of the four elements:

- $y = (((1/2+i)/3)/4-i)/5$

The bottom Product of Elements block collapses the matrix input to a vector by taking successive inverses along the second dimension:

- $y(1) = ((1/2+i)/3)$
- $y(2) = ((1/4-i)/5)$

Element-Wise Multiplication and Division Using the Product of Elements Block

This example shows how to use the Product of Elements block to perform element-wise multiplication and division of inputs.

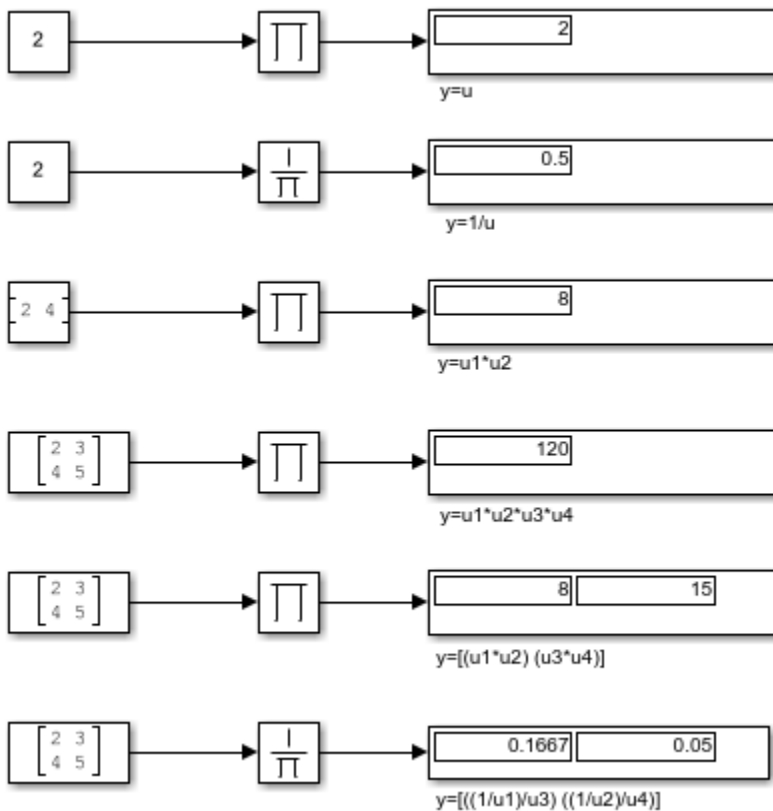

sin Function with Floating-Point Input

This example shows how to use the Trigonometric Function block to compute the sine of a floating-point input. The output of the Trigonometric Function block has the same data type as the input because the input data type is floating-point and the **Approximation method** is none.

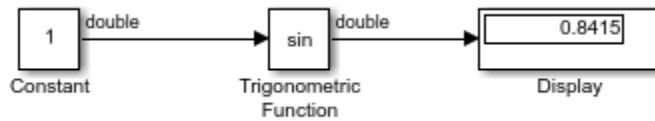

sincos Function with Fixed-Point Input

This example shows how to use the Trigonometric Function block to compute the CORDIC approximation of sincos for a fixed-point input signal.

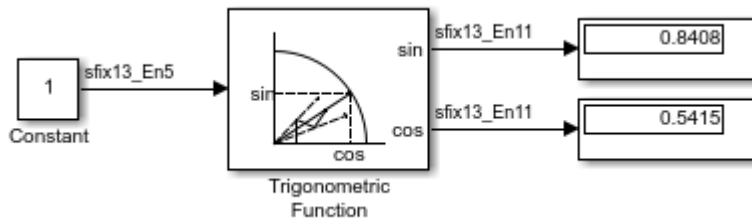

The Trigonometric Function block parameters are:

- **Function:** sincos
- **Approximation method:** CORDIC
- **Number of iterations:** 11

When using the CORDIC approximation method, the input to the Trigonometric Function block must be in the range $[-2\pi, 2\pi)$. The output type of the Trigonometric Function block is `fixdt(1,13,11)` because the input is a fixed-point signal and the **Approximation method** is set to CORDIC. The output fraction length equals the input word length minus two.

Trigonometric Function Block Behavior for Complex Exponential Output

This example compares the complex exponential output for two different configurations of the Trigonometric Function block.

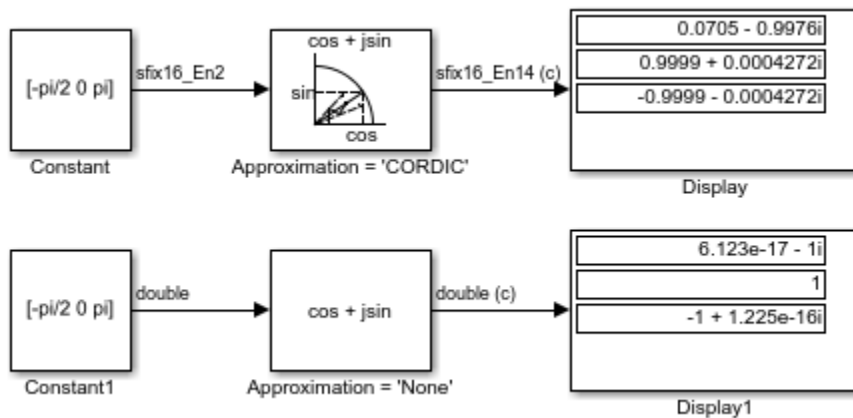

When the **Approximation method** is CORDIC, the input data type can be fixed point, in this case: `fixdt(1,16,2)`. The output data type is `fixdt(1,16,14)` because the output fraction length equals the input word length minus two.

When the **Approximation method** is None, the input data type must be floating point. The output data type is the same as the input data type.

Control Algorithm Execution Using Enumerated Signal

This example shows how to use a signal of an enumerated data type to control the execution of a block algorithm. For basic information about using enumerated data types in models, see “Use Enumerated Data in Simulink Models”.

Define Enumerated Type

Copy the enumerated type definition `ex_SwitchCase_MyColors` into a script file in your current folder.

```
classdef ex_SwitchCase_MyColors < Simulink.IntEnumType
    enumeration
        Red(0)
        Yellow(1)
        Blue(2)
        Mauve(3)
    end
end
```

Alternatively, you can use the function `Simulink.defineIntEnumType` to define the type.

```
Simulink.defineIntEnumType('ex_SwitchCase_MyColors',...
    {'Red','Yellow','Blue','Mauve'},[0;1;2;3])
```

Explore Example Model

Open the example model `ex_enum_switch_case`.

```
open_system('ex_enum_switch_case')
```

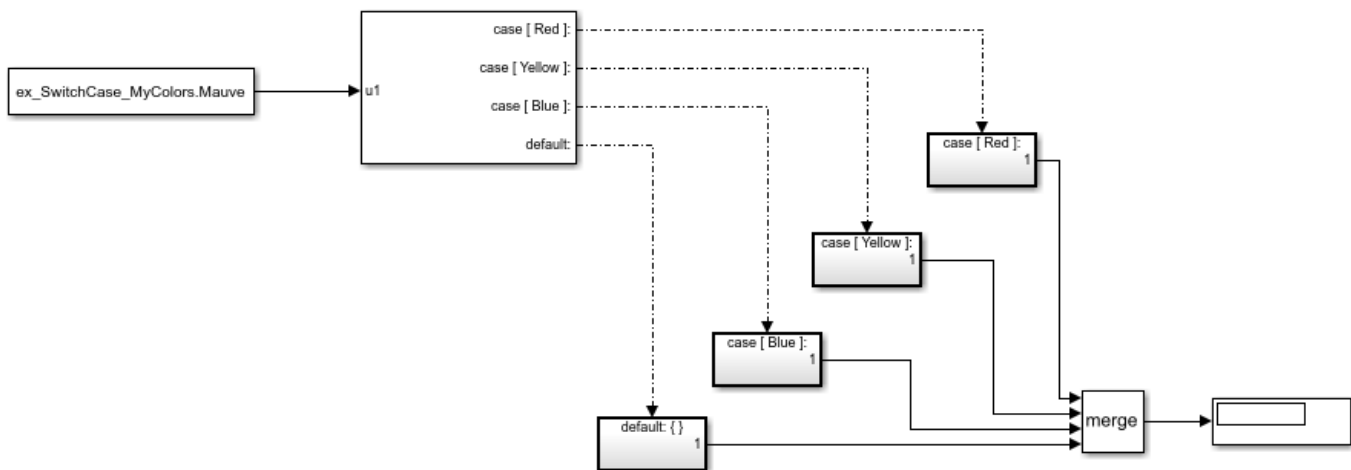

Open the Enumerated Constant block dialog box. The constant output value is `ex_SwitchCase_MyColors.Blue`.

Open the Switch Case block dialog box. The **Case conditions** box is specified as a cell array containing three of the four possible enumeration members. The block has four outputs corresponding to the three specified enumeration members and a default case.

Open the Switch Case Action Subsystem blocks. The subsystems each contain a Constant block that uses a different constant value.

Control Execution During Simulation

Simulate the model. The Display block shows the value 5, which corresponds to the case `ex_SwitchCase_MyColors.Blue`.

In the Enumerated Constant block dialog box, specify **Value** as `ex_SwitchCase_MyColors.Red` and click **Apply**. The Display block shows 19.

Specify **Value** as `ex_SwitchCase_MyColors.Mauve` and click **Apply**. The Display block shows 3, which corresponds to the default case.

Integer and Enumerated Data Type Support in the Ground Block

This example shows how to use the Ground block to ground block input ports that have integer and enumerated data types. In top row of this example, the output of the Constant block determines the data type (`int8`) of the port to which the Ground block is connected. That port determines the output data type of the Ground block, and the Ground block outputs a signal with zero value, and data type `int8`.

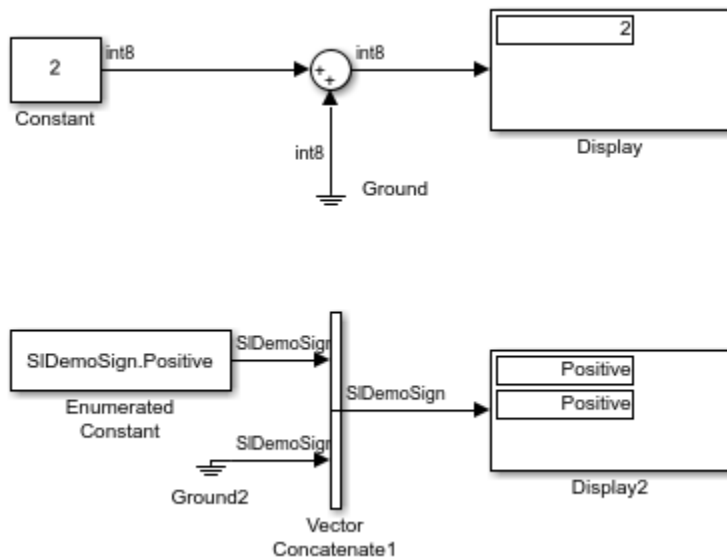

In the bottom row of this example, the Ground block is connected to a port with an enumerated data type. For enumerated data types, the Ground block outputs the default value of the enumeration. This behavior applies whether or not:

- The enumeration can represent zero
- The default value of the enumeration is zero

If the enumerated type does not have a default value, the Ground block outputs the first enumeration value in the type definition.

Fixed-Point Data Type Support in the Ground Block

This example shows how to use the Ground block to ground block input ports that have fixed-point data types. The top row of this example illustrates the Ground block behavior when the fixed-point data type can represent zero. In that case, the Ground block outputs a signal with zero value, and the same fixed-point data type as the port it is connected to.

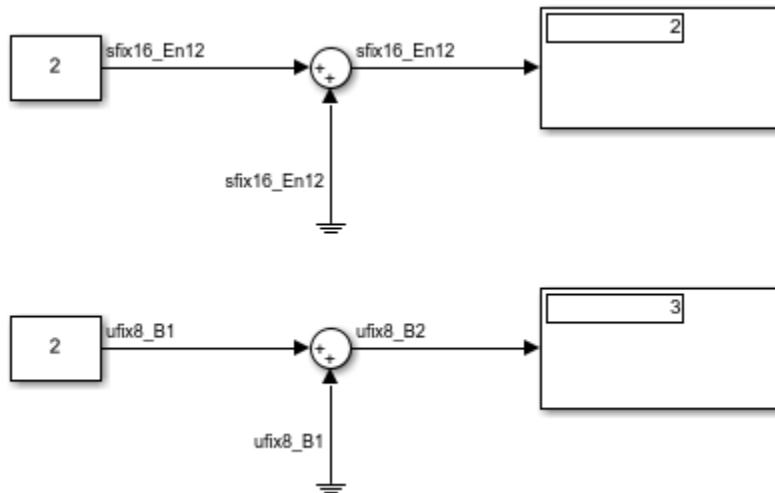

In the bottom row of this example, the output of the Constant block determines the data type of the port to which the Ground block is connected ($\text{fixdt}(0, 8, 1, 1)$). Because zero cannot be represented exactly by the data type $\text{fixdt}(0, 8, 1, 1)$, the Ground block outputs a nonzero value that is the closest possible value to zero (in this case, 1).

Read 1-D Array and Structure From Workspace

This example shows how to read 1-D signals from the MATLAB workspace. When you open the model, the following code is executed by a PreLoadFcn callback:

```
t = 0.2 * [0:49]';  
x = sin(t);  
y = 10*sin(t);  
wave.time = t;  
wave.signals.values = [x,y];  
wave.signals.dimensions = 2;
```

In the top row of the model, the From Workspace block reads the array [t, x, y] from the MATLAB workspace.



In the bottom row of the model, the From Workspace block reads the same values from the workspace, but this time they are read from a structure named `wave`.

Read Structure From Workspace Using Model Sample Time

This example shows how to read a structure from the MATLAB workspace using a sample time specified in the From Workspace block. When you open the model, the following code is executed by a PreLoadFcn callback:

```
t = 0.2 * [0:49]';
x = sin(t);
y = 10*sin(t);
wave.time = [];
wave.signals.values = [x,y];
wave.signals.dimensions = 2;
```

The From Workspace block is configured as follows:

- **Sample time:** 0.2
- **Interpolate data:** off
- **Form output after final data value by:** Setting to zero

When you run the model, the From Workspace block reads the structure wave from the workspace. After the last time hit for which workspace data is available, the block outputs 0.

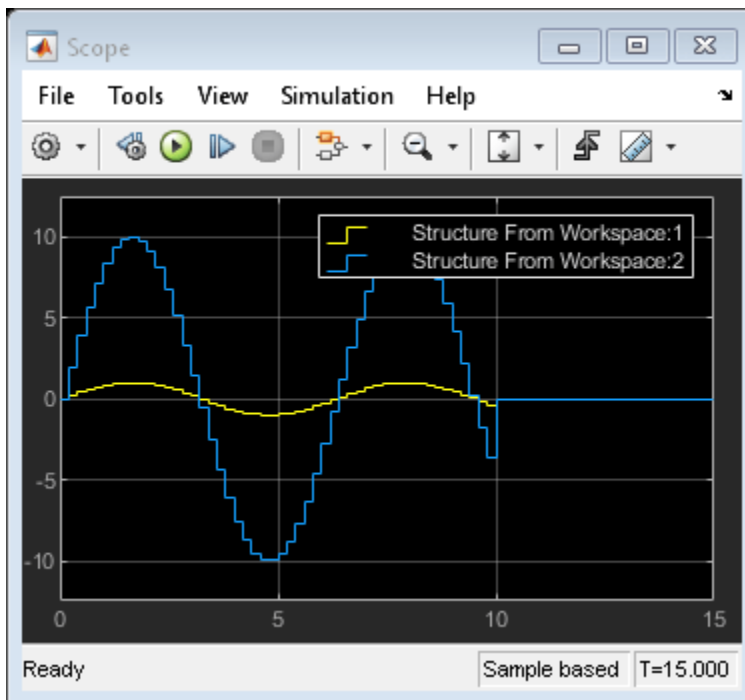
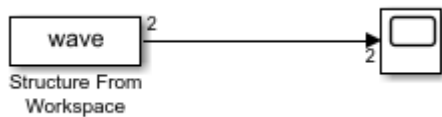

Read 2-D Signals in Structure Format From Workspace

This example shows how to read a 2-D structure from the MATLAB workspace. When you open the model, the following code is executed by a PreLoadFcn callback:

```
t1 = 0.2 * [0:49]';
m = magic(10);
M = repmat(m,[1 1 length(t1)]);
data.time=t1;
data.signals.values = M;
data.signals.dimensions=[10 10];
```

This code creates 10-by-10 matrix (2-D signal) by using the `magic` function, and then creates a 3-D matrix by adding a time vector. The time vector must be a column vector. The `signals.values` field is a 3-D matrix where the third dimension corresponds to time. The `signals.dimensions` field is a two-element vector. The first element is the number of rows and the second element is the number of columns in the `signals.values` field.

When you run the model, the From Workspace block reads the structure `data` from the workspace.

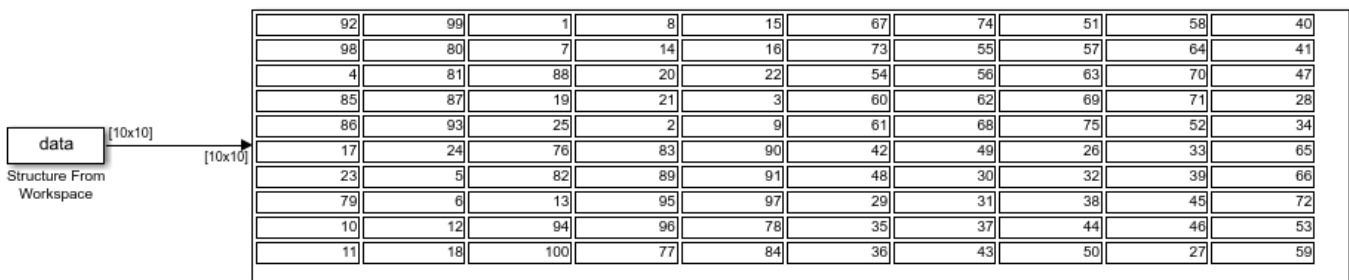

From File Block Loading Timeseries Data

Create a MATLAB® `timeseries` object with time and signal values. Save the `timeseries` object to a MAT-file and load into a model using a From File block.

Create an array with the time and signal data, specifying signal data for 10 time steps.

```
t = .1*(1:10);  
d = .2*(1:10);  
x = [t;d];
```

Create a MATLAB `timeseries` object.

```
ts = timeseries(x(2:end,:),x(1,:))
```

```
timeseries
```

```
Common Properties:
```

```
    Name: 'unnamed'  
    Time: [10x1 double]  
    TimeInfo: tsdata.timemetadata  
    Data: [1x1x10 double]  
    DataInfo: tsdata.datametadata
```

Save the `timeseries` object in a Version 7.3 MAT-file.

```
save('mySignals','ts','-v7.3')
```

Add a From File block and set the **File name** parameter of that block to `mySignals.mat`.

Simulate the model. The Scope block reflects the data loaded from the `mySignals.mat` file.

Eliminate Singleton Dimension with the Squeeze Block

This example shows a model using the Squeeze block to eliminate a dimension of size 1.

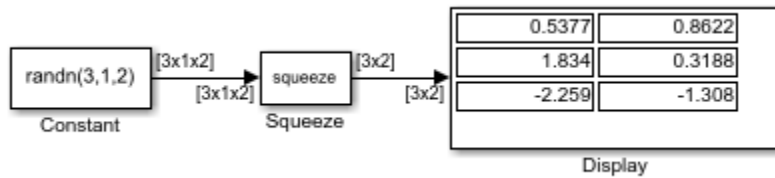

The Squeeze block converts a multidimensional array from the Constant block of size 3-by-1-by-2 into a 3-by-2 signal.

Difference Between Time- and Sample-Based Pulse Generation

This example shows the difference in behavior of the Pulse Generator block in time-based and sample-based modes.

Consider this model, with two Pulse Generator blocks. One block has the **Pulse type** parameter set to Time based, and the other to Sample based. Both blocks are configured to output a pulse with an amplitude of one that is on for five seconds, followed by off for five seconds. The simulation time runs from three seconds to a stop time of 18 seconds. Notice the time offset notice in the lower right corner.

ans =

```
Simulink.SimulationOutput:  
    tout: [61x1 double]  
  
SimulationMetadata: [1x1 Simulink.SimulationMetadata]  
ErrorMessage: [0x0 char]
```

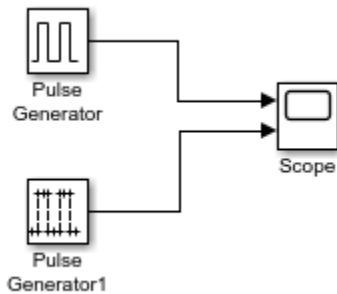

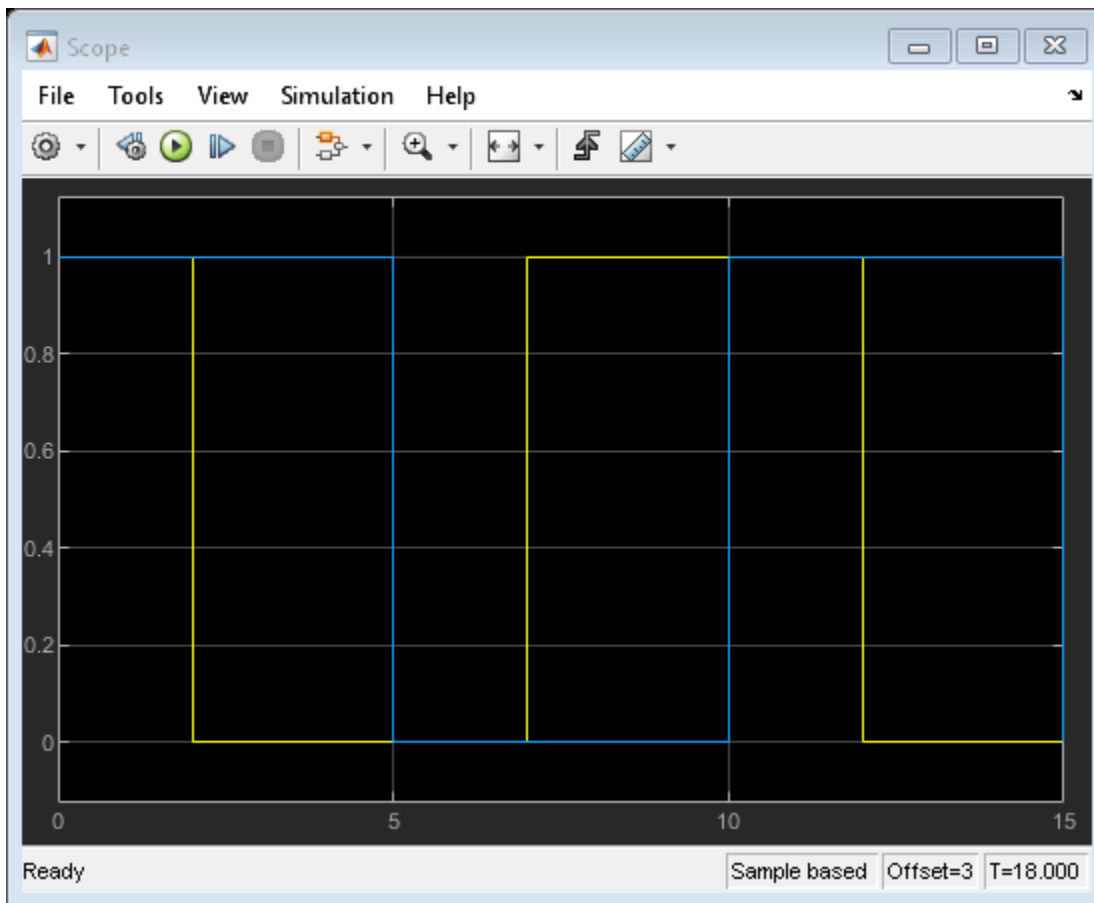

Notice that the time-based Pulse Generator produces an on signal for only two seconds and then switches to off. This is due to the block starting to compute the output from $t=0$ even though it does not output the simulation until $t=3$. The sample-based block outputs a pulse of five seconds on followed by five seconds off. In this case, the block output does not depend on simulation time and starts only when the simulation starts.

Specify a Waveform with the Repeating Sequence Block

This example shows how you specify a waveform with the Repeating Sequence block. In this model, the block defines the **Time values** parameter as $[0:0.1:0.5]$ and the **Output values** parameter as $[0\ 15\ 25\ 09\ 13\ 17]$. The stop time of the simulation is 0.7 second.

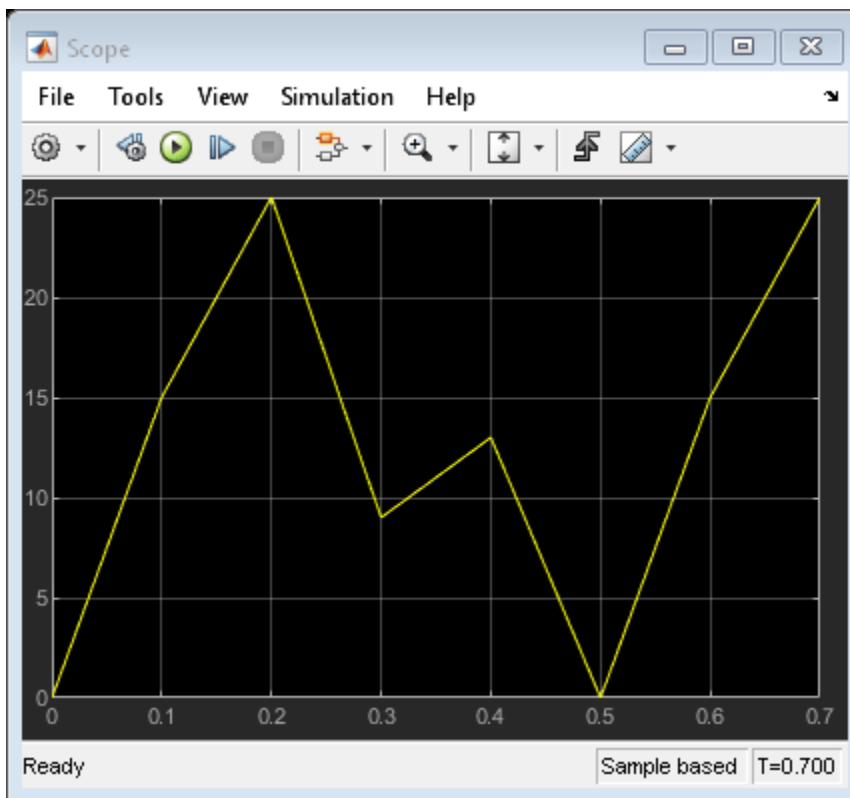
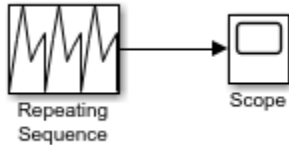

- Input period is 0.5.
- Output at any time t is the output at time $t = t - 0.5n$, where $n = 0,1,2$, and so on.
- Sequence repeats at $t = 0.5n$.

At $t = 0.5$, the expected output is equal to the output at $t = 0$, which is 0. Therefore, the last value in the **Output values** parameter vector $[0\ 15\ 25\ 09\ 13\ 17]$ does not appear.

Tune Phase Delay on Pulse Generator During Simulation

This example shows how to modify a model so that you can change a phase delay for a Pulse Generation block during simulation. You cannot tune the value of the **Phase delay** parameter during simulation. As a workaround, add a Constant block and a Variable Time Delay block.

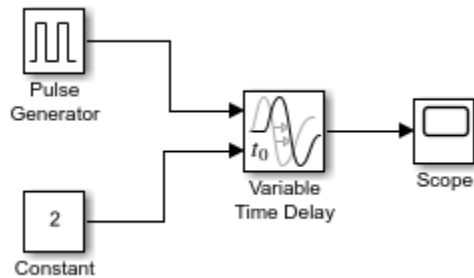

In the Pulse Generator block, set the value of the **Phase delay** parameter to zero. Use the Constant block to specify the delay time in seconds. To tune the delay time during simulation, change the value stored in the Constant block.

Difference Sine Wave Signal

This example shows how to calculate the difference in a sine wave signal at each time step. The input is a 1-by-2 vector of sine waves, with amplitude 1 and 3. The difference block calculates the difference in each sine wave signal at every time step. The Scope block displays both the original sine waves and the output of the difference block.

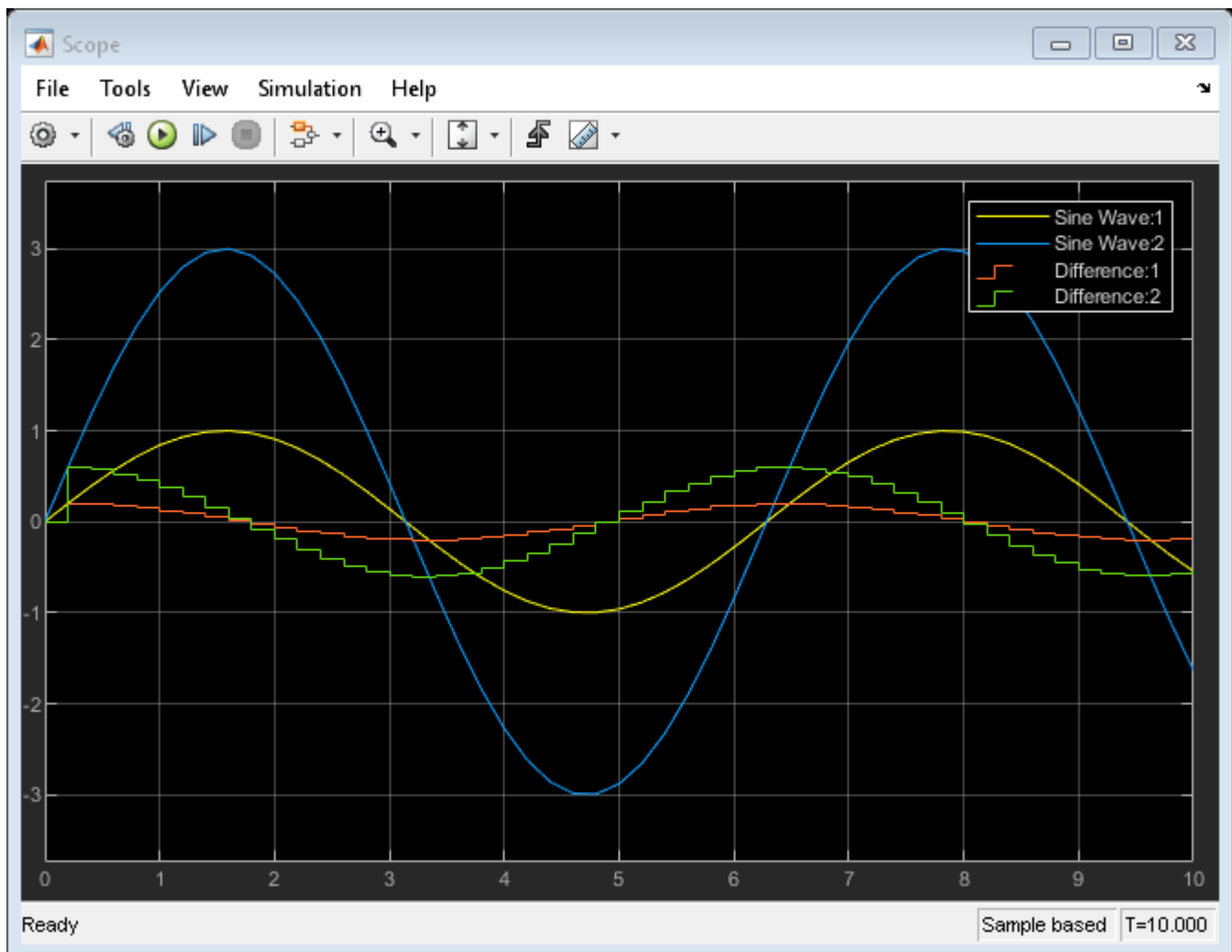
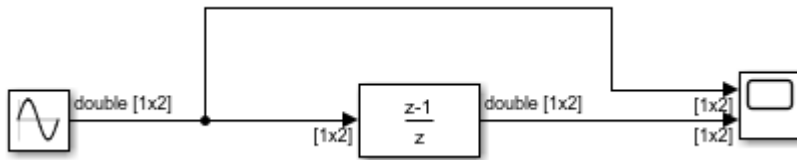

Discrete-Time Derivative of Floating-Point Input

This example shows how to use the Discrete Derivative block to compute the discrete-time derivative of a floating-point input signal. The unfiltered discrete-time derivative is compared to a filtered discrete-time derivative that is computed by the Discrete Filter block.

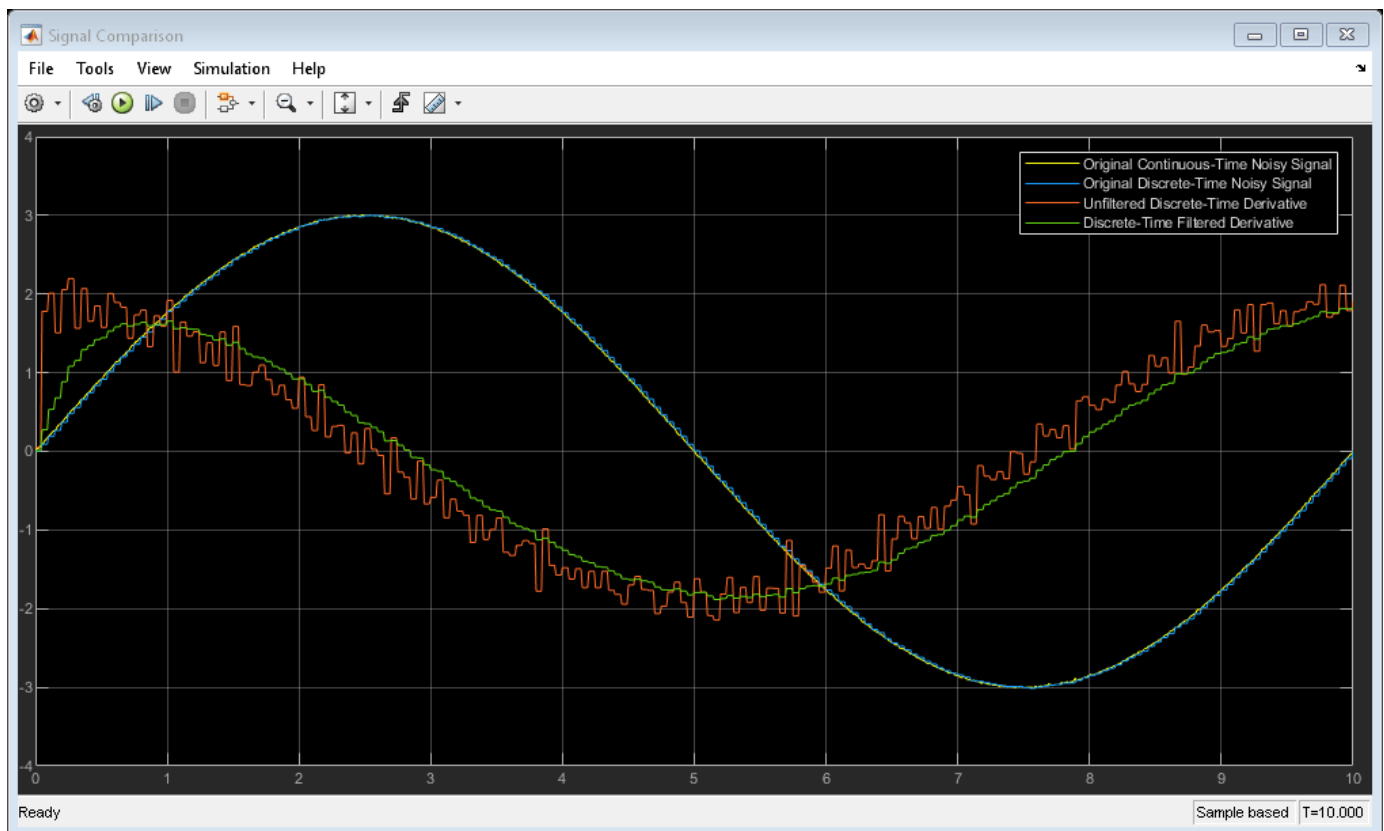
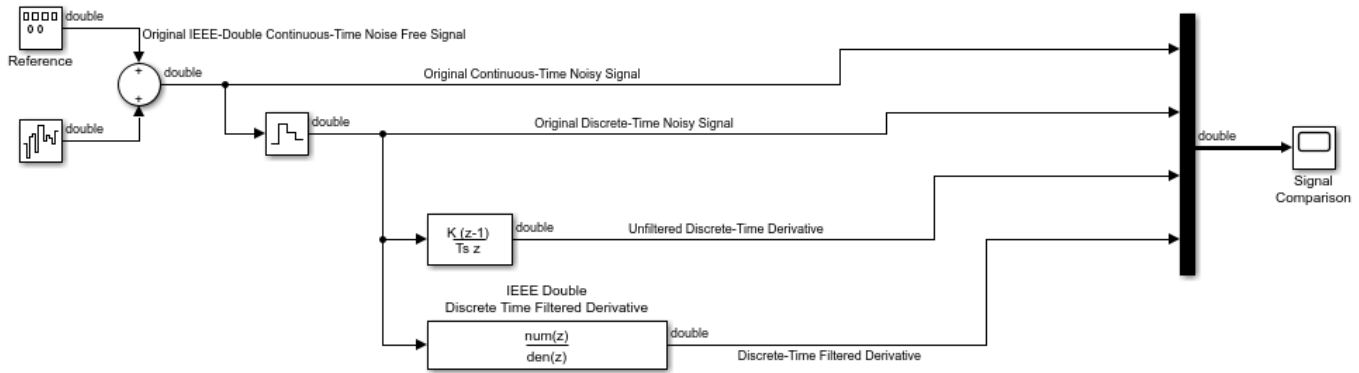

First-Order Sample-and-Hold of a Sine Wave

This example shows how to perform a first-order sample-and-hold of a sine wave signal using the First-Order Hold block.

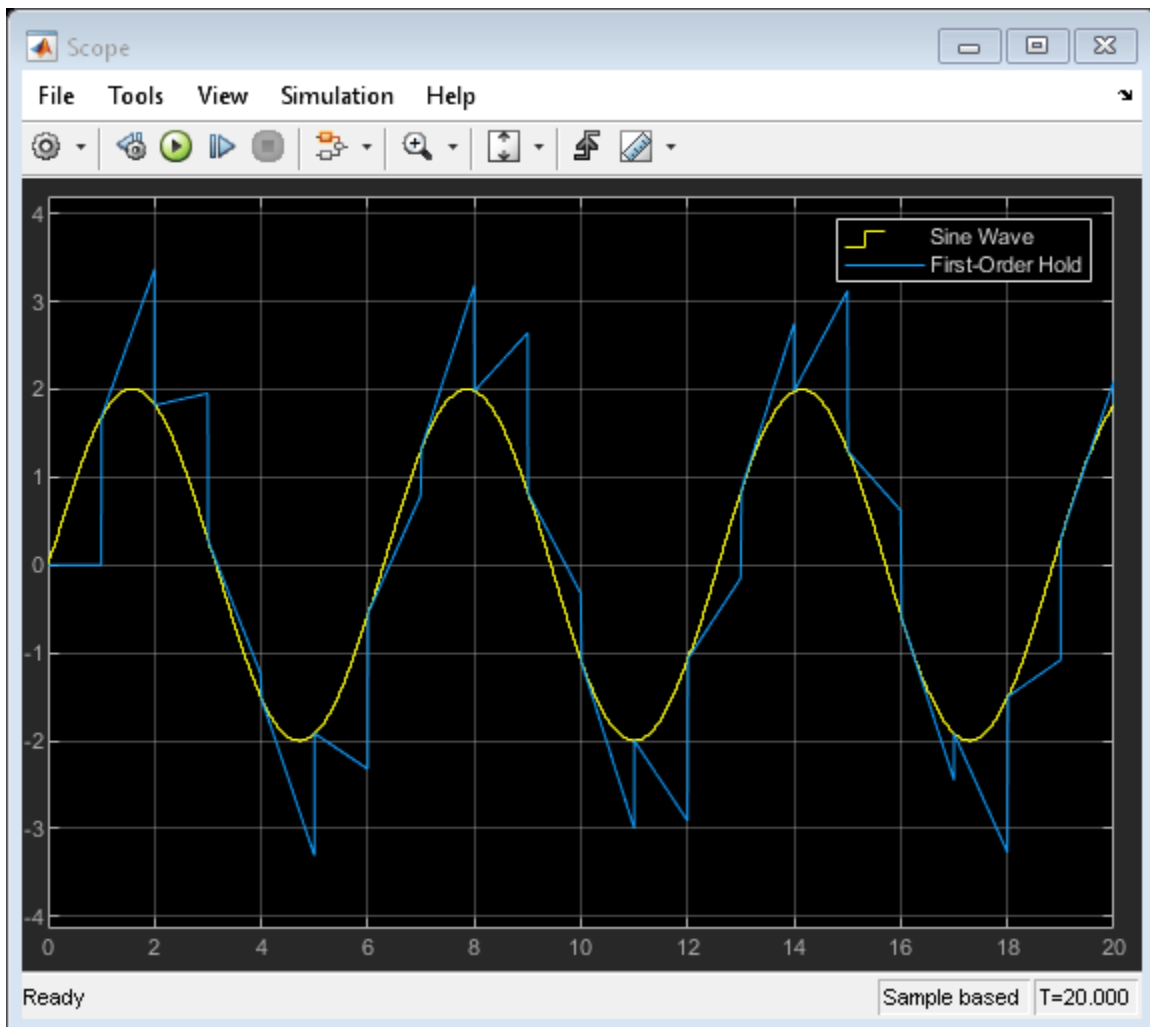
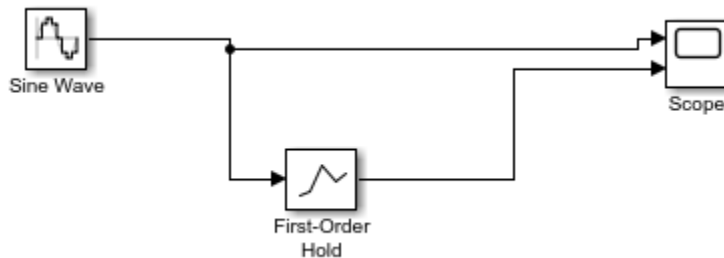

Calculate and Display Simulation Step Size using Memory and Clock Blocks

This example shows how to use the Memory and Clock blocks to calculate and display the step size in a simulation. The Sum block subtracts the time at the previous time step, which the Memory block generates, from the current time, which the Clock block generates.

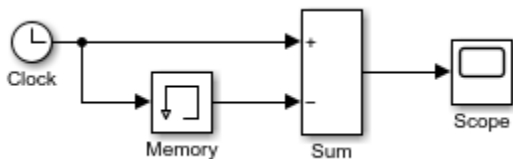

Because **Inherit sample time** is not selected for the Memory block, the block sample time depends on the type of solver for simulating the model. In this case, the model uses a fixed-step solver. Therefore, the sample time of the Memory block is the solver step size, or 1.

If you replace the Memory block with a Unit Delay block, you get the same results. The Unit Delay block inherits a discrete sample time of 1.

Capture the Velocity of a Bouncing Ball with the Memory Block

The `sldemo_bounce` example shows how to use the Second-Order Integrator and Memory blocks to capture the velocity of a bouncing ball just before it hits the ground.

```
open_system('sldemo_bounce');
```

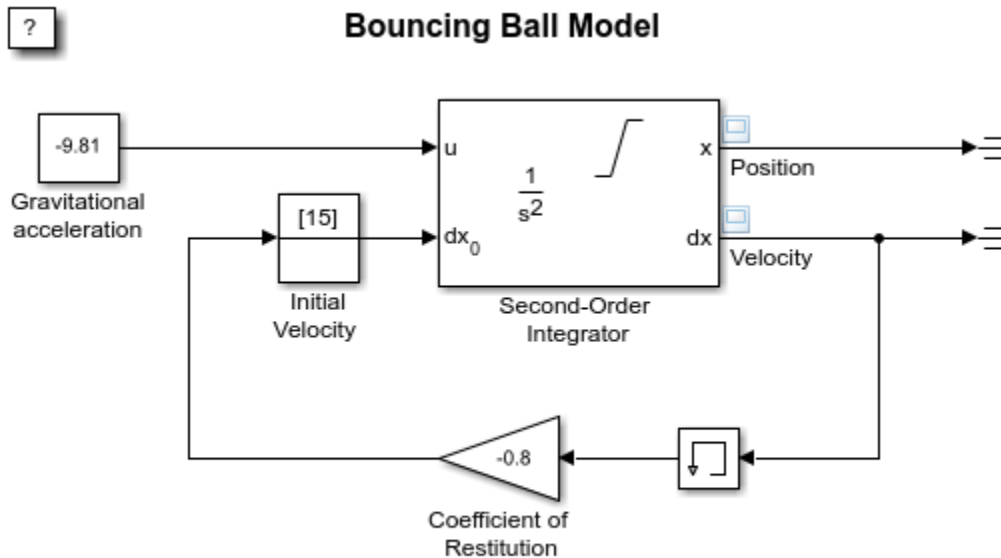

Copyright 2004-2013 The MathWorks, Inc.

Because **Inherit sample time** is not selected for the Memory block, the block sample time depends on the type of solver for simulating the model. In this case, the model uses a variable-step (ode23) solver. Therefore, the sample time of the Memory block is continuous but fixed in minor time step: $[0, 1]$. When you run the model, you get these results.

```
sim('sldemo_bounce');
```

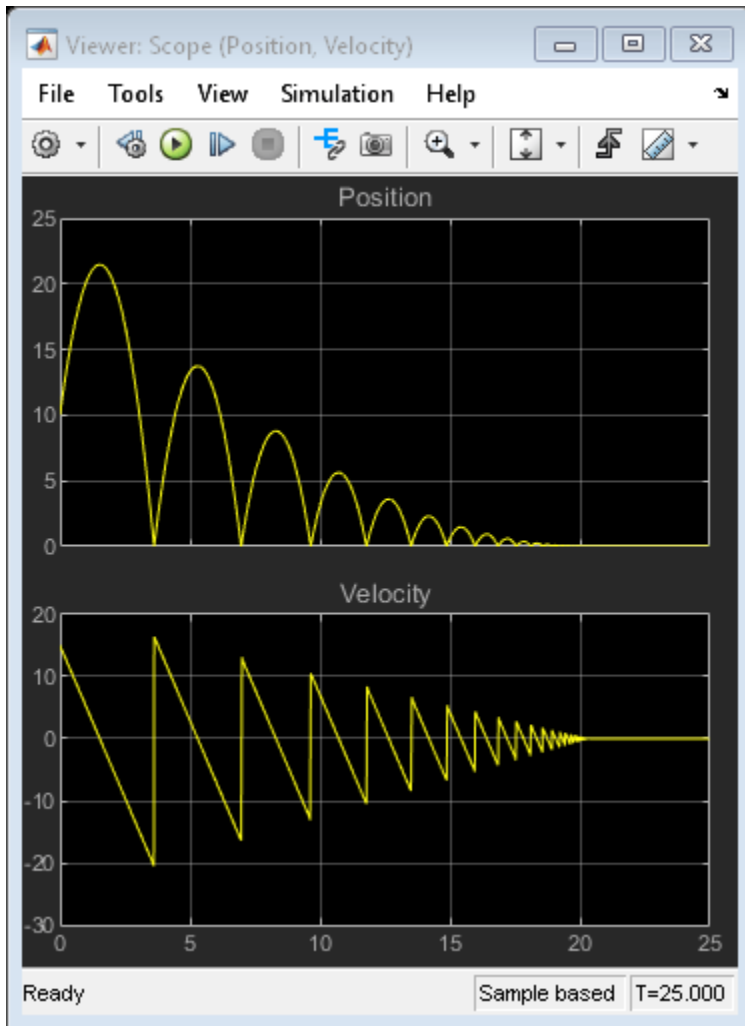

If you replace the Memory block with a Unit Delay block, you get the same results. However, a warning also appears due to the discrete Unit Delay block inheriting a continuous sample time.

For more information, see the model description.

Implement a Finite-State Machine with the Combinatorial Logic and Memory Blocks

The `ex_sl_demo_clutch` example shows how you can use the Memory block with the Combinatorial Logic block to implement a finite-state machine. This construct appears in the Friction Mode Logic/Lockup FSM subsystem:

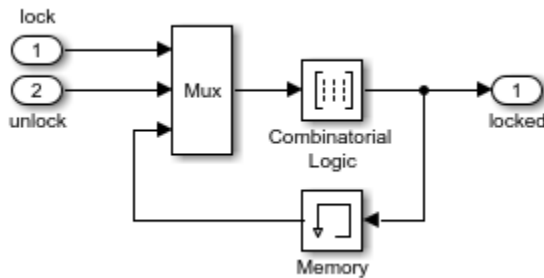

Because **Inherit sample time** is not selected for the Memory block, the block sample time depends on the type of solver for simulating the model. In this case, the model uses a variable-step (`ode23`) solver. Therefore, the sample time of the Memory block is continuous but fixed in minor time step: $[0, 1]$.

See Also

More About

- “Building a Clutch Lock-Up Model” on page 13-144

Discrete-Time Integration Using the Forward Euler Integration Method

The `sldemo_fuelsys` model uses a Discrete-Time Integrator block in the `fuel_rate_control/airflow_calc` subsystem. This block uses the Forward Euler integration method.

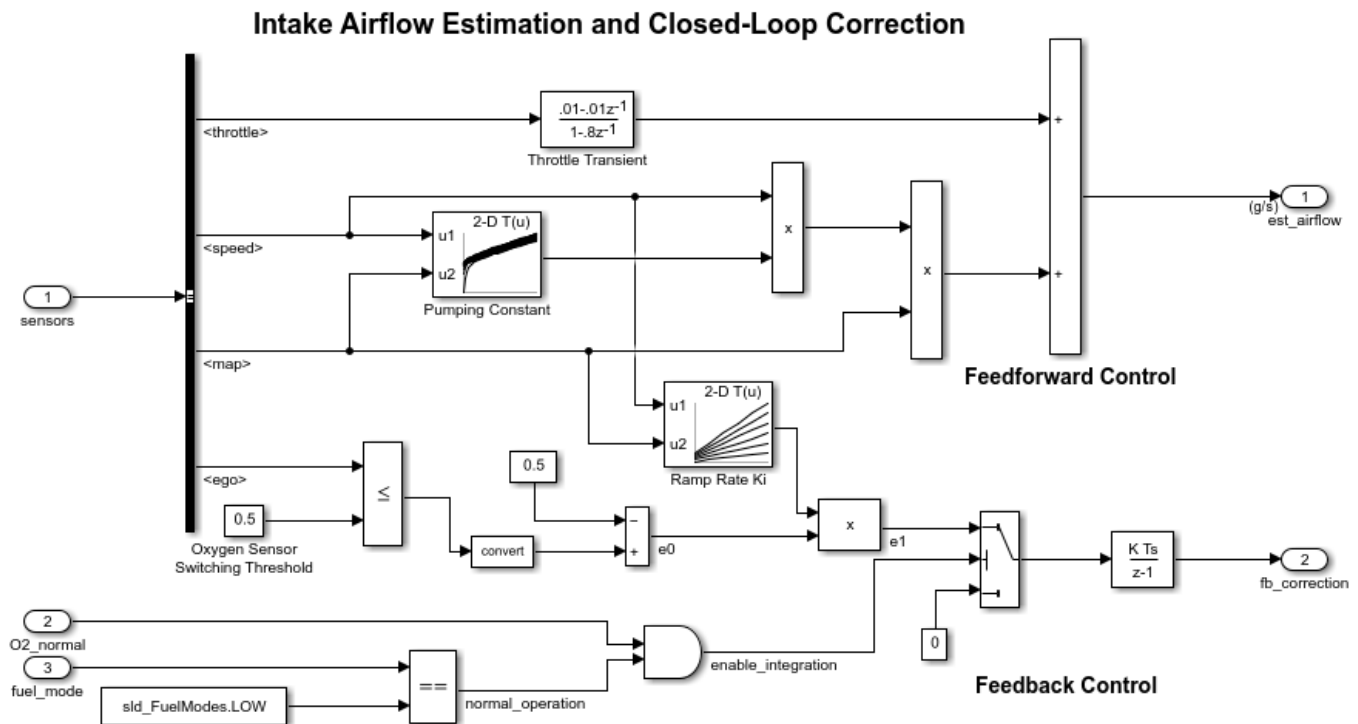

When the Switch block feeds a nonzero value into the Discrete-Time Integrator block, integration occurs. Otherwise, integration does not occur.

See Also

More About

- “Modeling a Fault-Tolerant Fuel Control System” on page 13-112

Signal Routing with the From, Goto, and Goto Tag Visibility Blocks

This example shows how to use the From, Goto, and Goto Tag Visibility blocks to route signals in your model. The GotoGlobal block at the top-level of the model has the **Goto tag** parameter set to G and the **Tag visibility** set to global. Thus, the G tag can be seen by From and Goto blocks at any level of the model hierarchy, except locations that span nonvirtual subsystem boundaries (like the Atomic Subsystem in this model). The From block at the top level of the model can see and connect to the global G tag, but cannot see or connect to the scoped S tag or L local tag that are specified on Goto blocks further down in the model hierarchy.

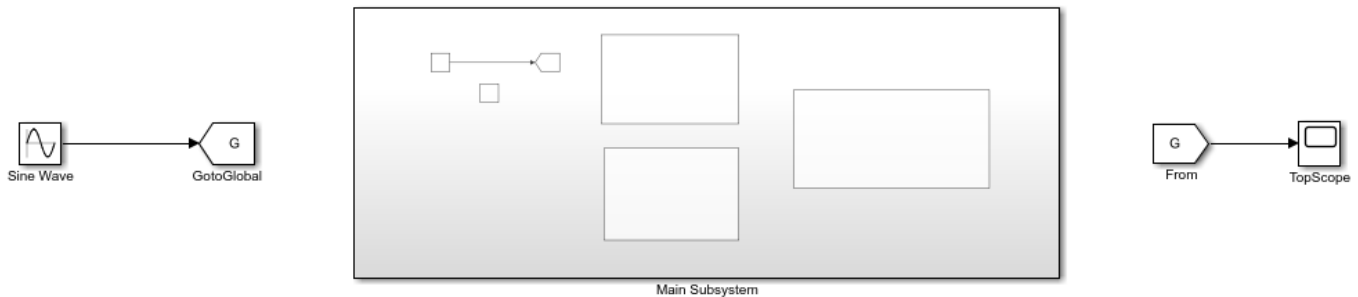

Inside of the Main Subsystem, the Goto block with **Goto tag** set to S has a **Tag visibility** of scoped. The Goto Tag Visibility block placed at the same level as that Goto block indicates the S tag can be seen by all From and Goto blocks at that level and below, except for locations that cross a nonvirtual subsystem boundary (i.e. the boundary with the Atomic Subsystem). Inside of Subsystem1 and Subsystem2, the From blocks can see and connect to the global Goto tag G, and the scoped Goto tag S.

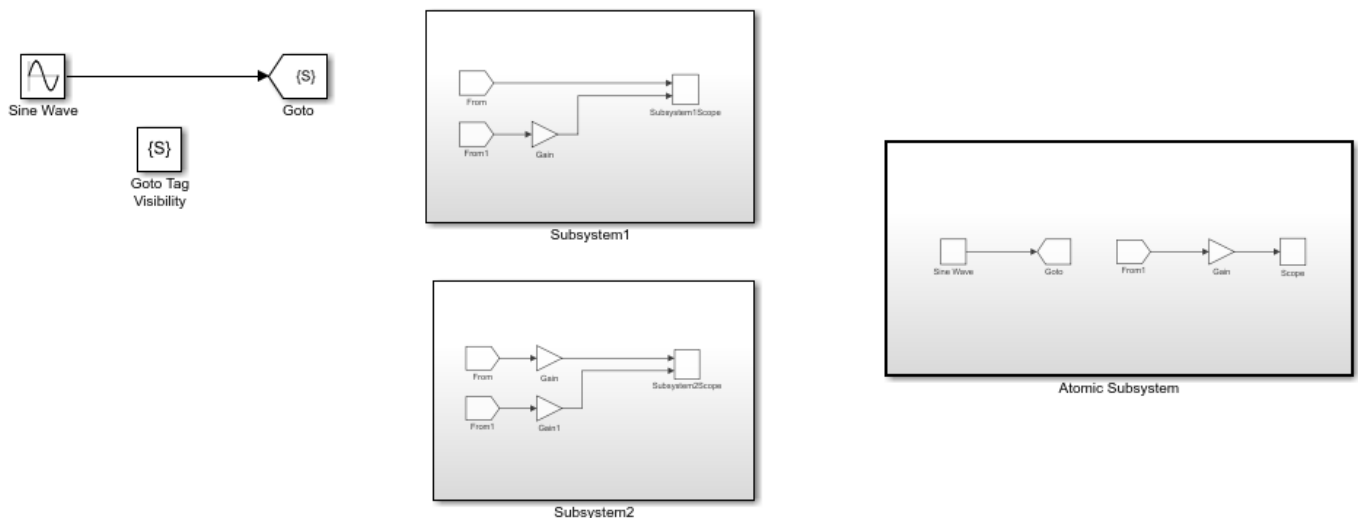

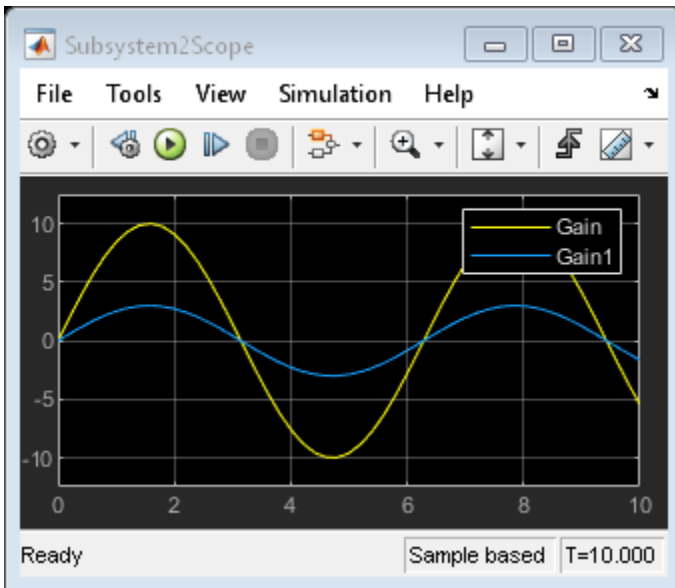
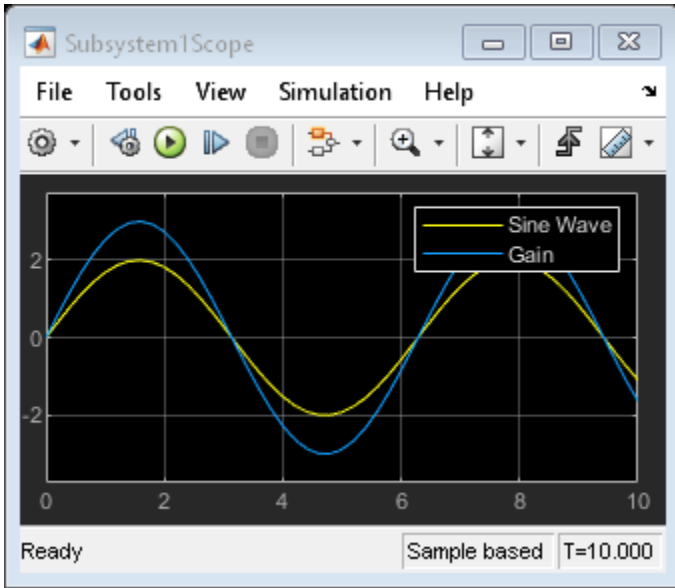

Zero-Based and One-Based Indexing with the Index Vector Block

This example shows how the Index Vector block works with zero-based and one-based indexing.

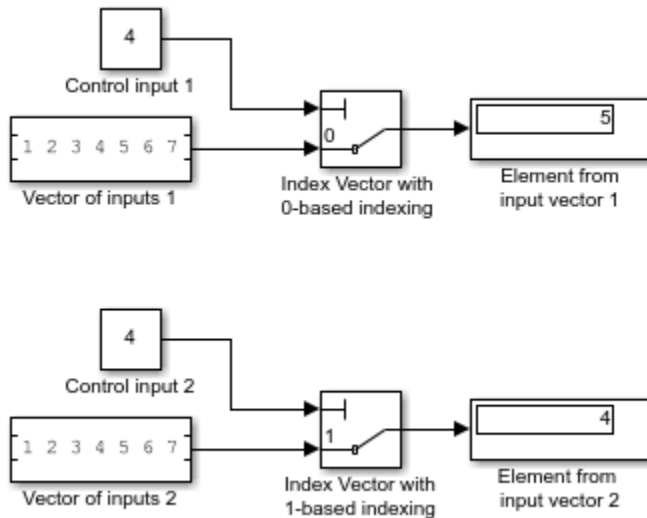

The Index Vector block is from the Simulink Signal Routing library. It is a special configuration of the Multiport Switch block. To configure the Multiport Switch block as an Index Vector block, set the **Number of data ports** to 1 and **Data port order** to Zero-based contiguous.

Noncontiguous Values for Data Port Indices of Multiport Switch Block

This example shows how to use a Multiport Switch block that specifies noncontiguous integer values for data ports. The values of the indices are visible on the data port labels. You do not have to open the block dialog box to determine which value maps to each data port.

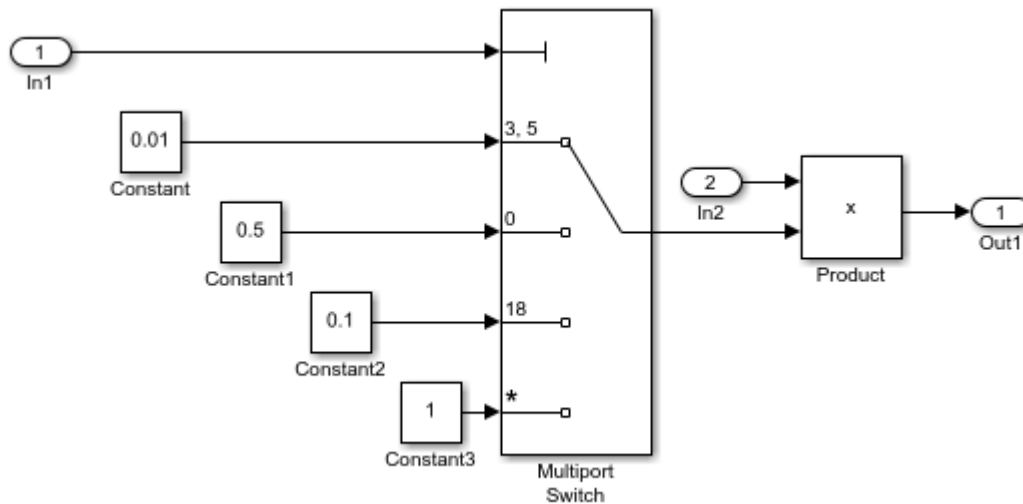

When you set **Data port for default case** to `Additional data port`, an extra port with a * label appears. This port corresponds to the default case, which applies when the control input does not match the data port indices 3, 5, 0, or 18. When that happens in this example, the Multiport Switch block outputs a value of 1.

Using Variable-Size Signals on the Delay Block

This example shows how the Delay block supports variable-size signals for sample-based processing. The Switch block controls whether the input signal to the enabled subsystem is a 3-by-3 or 3-by-2 matrix.

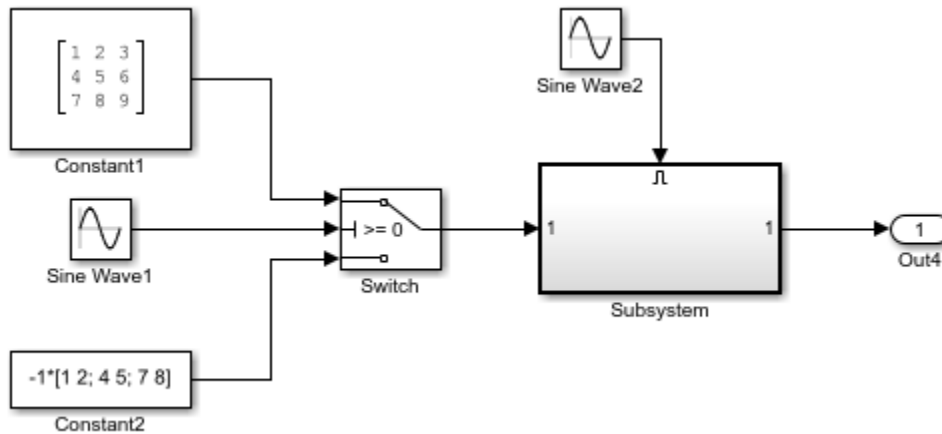

The Delay block appears inside the enabled subsystem.

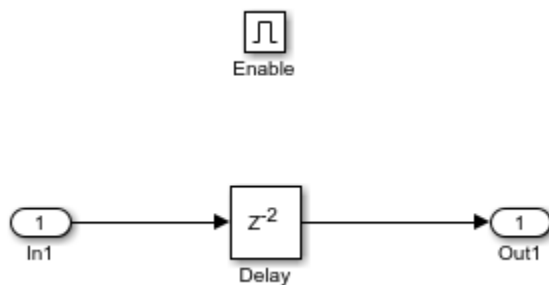

The model follows these rules for variable-size signals while using sample-based processing.

- Signal dimensions change only during state reset when the block is enabled.
- Initial condition must be scalar.

The rules are implemented by these blocks.

- Enable block sets **Propagate sizes of variable-size signals** to Only when enabling.
- Delay block sets the **Initial condition** to the scalar value 0.0.

Buses with the Delay Block for Frame-Based Processing

This example shows how the Delay block supports buses for frame-based processing.

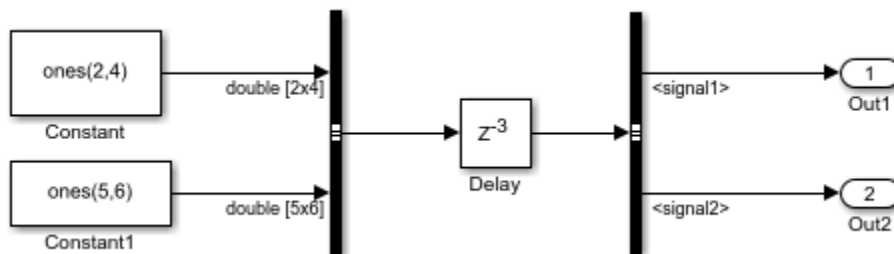

Each Constant block supplies an input signal to the Bus Creator block, which outputs a two-dimensional bus. After the Delay block delays the bus by three sample periods, the Bus Selector block separates the bus back into the two original signals.

The model follows these rules for buses:

- For the initial condition, set the value on the dialog box.
- For frame-based processing, signal dimensions of the data input port u cannot be larger than two.

The model implements the rules by:

- Setting **Initial condition** to a scalar value of 0.
- Setting bus input to the Delay block as two dimensions.

Control Execution of Delay Block with Enable Port

This example shows how you can enable or disable the execution of the Delay block using an enable port. In this model, a ramp input signal feeds into a Delay block. The execution of the block is controlled by an enabling signal from the Pulse Generator block.

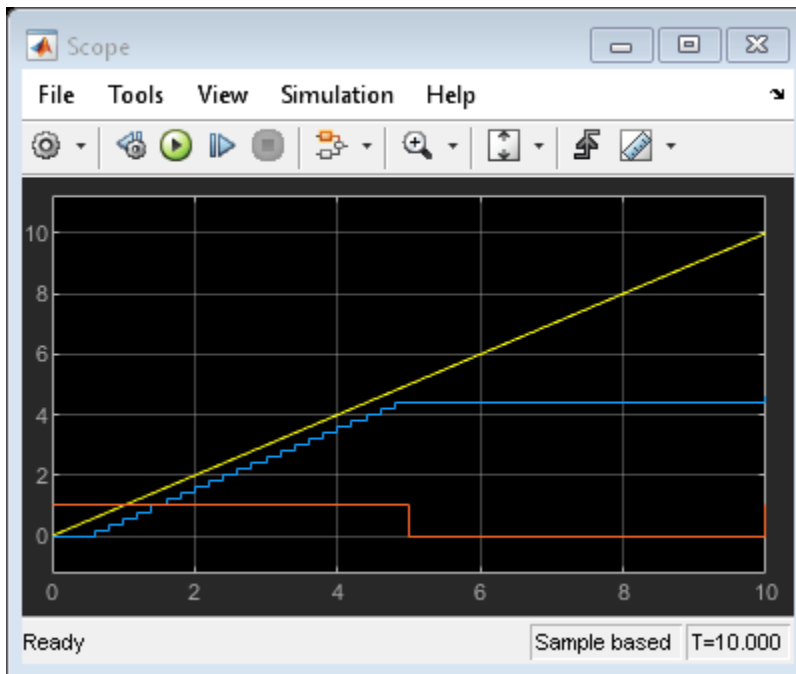
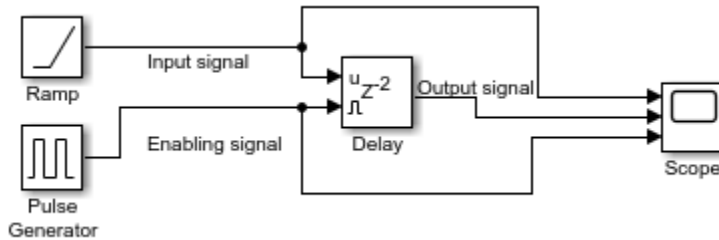

The blue line shows that the Delay block outputs the input signal value delayed by one time step while the enabling signal has a value of one. At $t=5$ the enabling signal transitions to zero and the Delay block stops executing. The output is held at the last value until the block is enabled again.

Zero-Based Indexing for Multiport Switch Data Ports

This example shows a Multiport Switch block that uses zero-based indexing for contiguous ordering of three data ports.

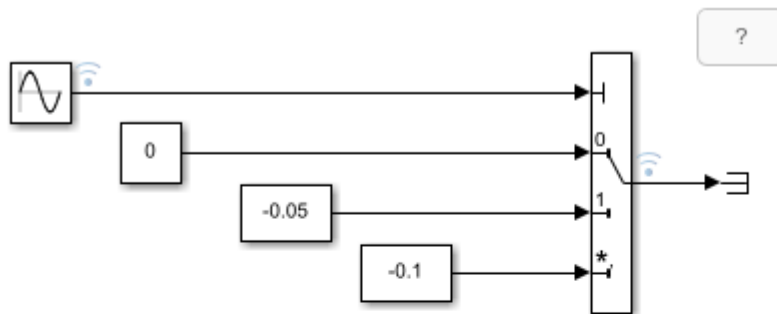

Copyright 2020 The MathWorks, Inc.

The indices are visible on the data port labels. You do not have to open the block dialog box to determine if the data ports use zero-based or one-based indexing.

When you set **Data port for default case** to Last data port, the last data port includes a * on the label (in this case, the label is *, 2). The comma after the * indicates that the data port index has a value. This port corresponds to the default case, which applies when the control input does not match the data port indices. In this example, the Multiport Switch block outputs a value of -0.1 when the control input does not match the data port indices of 0, 1, or 2.

One-Based Indexing for Multiport Switch Data Ports

The `sf_semantics_hotel_checkin` model uses a Multiport Switch block. This block uses one-based indexing for contiguous ordering of three data ports.

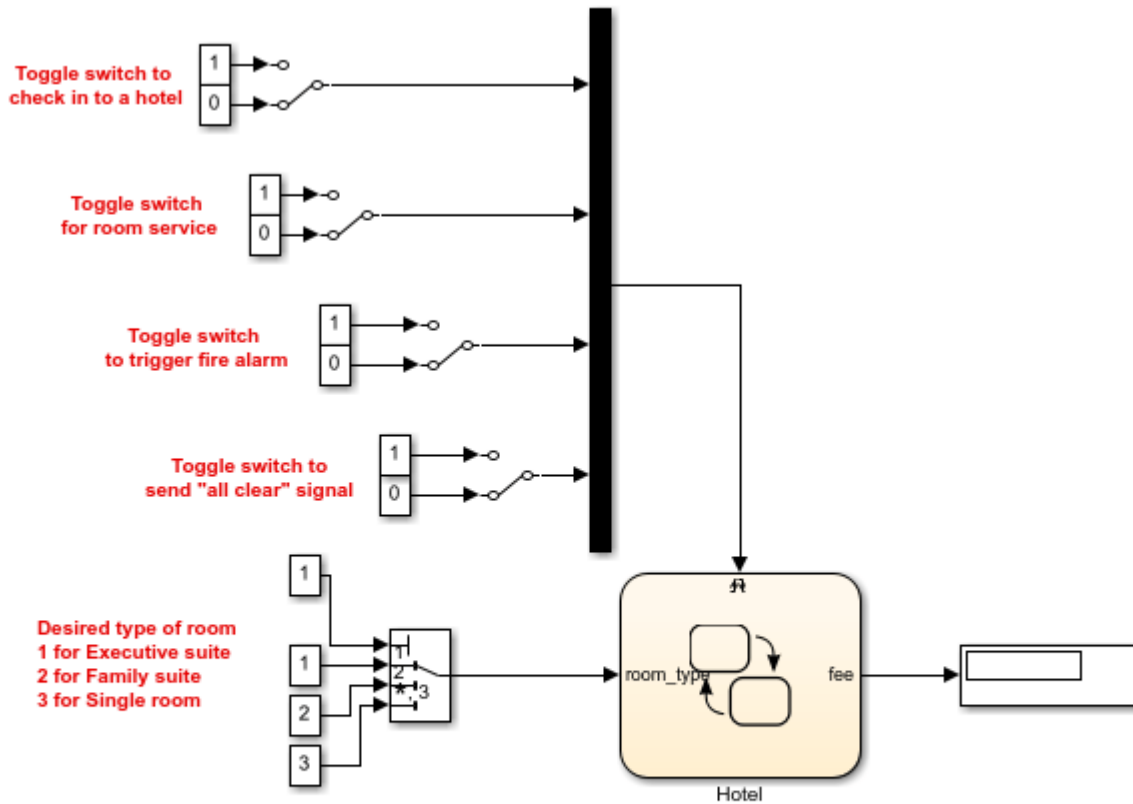

Copyright 2008-2013 The MathWorks, Inc.

When you increase the size of the block icon, the indices are visible on the data port labels. You do not have to open the block dialog box to determine whether the data ports use zero-based or one-based indexing.

Enumerated Names for Data Port Indices of the Multiport Switch Block

The `sldemo_fuelsys` model uses a Multiport Switch block in the `fuel_rate_control/fuel_calc/feedforward_fuel_rate` subsystem. This block uses the enumerated type `slc_FuelModes` to specify three data port indices: LOW, RICH, and DISABLED.

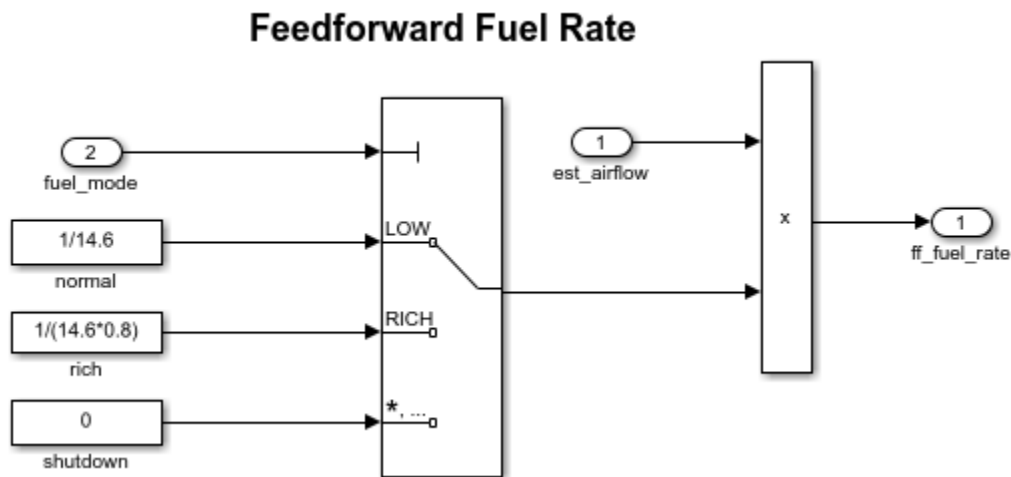

When you set **Data port for default case** to Last data port, the last data port includes a * on the label. The comma and ellipsis after the * indicate that the data port index has a value. This port corresponds to the default case, which applies when the control input does not match the data port indices LOW, RICH, or DISABLED. In this case, the Multiport Switch block outputs a value of 0.

See Also

More About

- “Modeling a Fault-Tolerant Fuel Control System” on page 13-112

Prevent Block Windup in Multiloop Control

This example shows how to use signal tracking to prevent block windup in a two-loop control system.

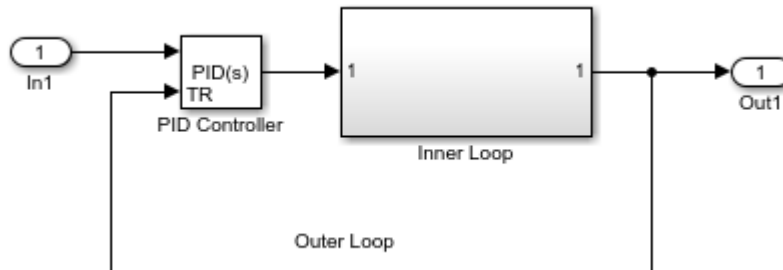

The Inner Loop subsystem contains a saturation limit:

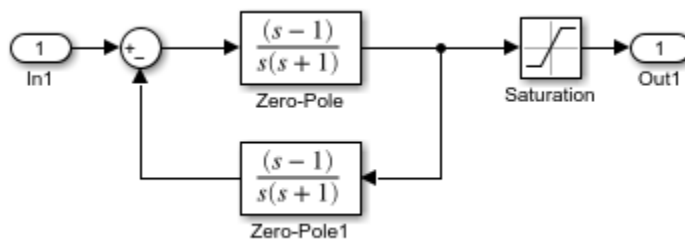

In this example, the inner loop has an effective gain of 1 when it does not saturate. When the inner loop does saturate, however, the integrator in the PID Controller can begin to wind up.

If the PID controller tracks the output of the inner loop, then its output never exceeds the saturated inner-loop output. To achieve this tracking, connect the Saturation block output to the tracking input of the PID Controller.

Bumpless Control Transfer

This example shows how to use signal tracking to achieve bumpless control transfer in a system that switches between a PID Controller block and another controller. You can make the PID controller track the output of the other controller by connecting the signal you want to track to the TR port of the PID Controller block. For example:

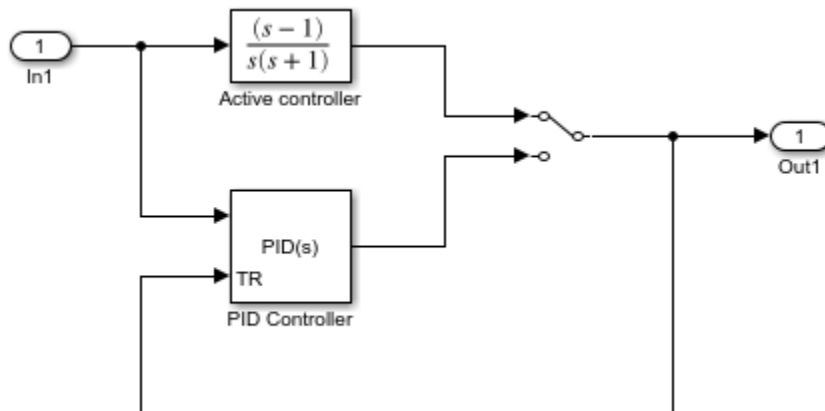

The input **In1** takes a reference signal that feeds both controllers. The output **Out1** drives a controlled system (not shown). A switch transfers control between the Active controller block (a Zero-Pole block) and the PID Controller block. When the Active controller is in the loop, the PID Controller block tracks its output. Thus, the two controllers have the same output when you switch to PID control, ensuring smooth operation.

Bumpless Control Transfer with a Two-Degree-of-Freedom PID Controller

This example shows how to use signal tracking to achieve bumpless control transfer in a system that switches between a PID Controller (2DOF) block and another controller. You can make the PID controller track the output of the other controller by connecting the signal you want to track to the TR port of the PID Controller block. For example:

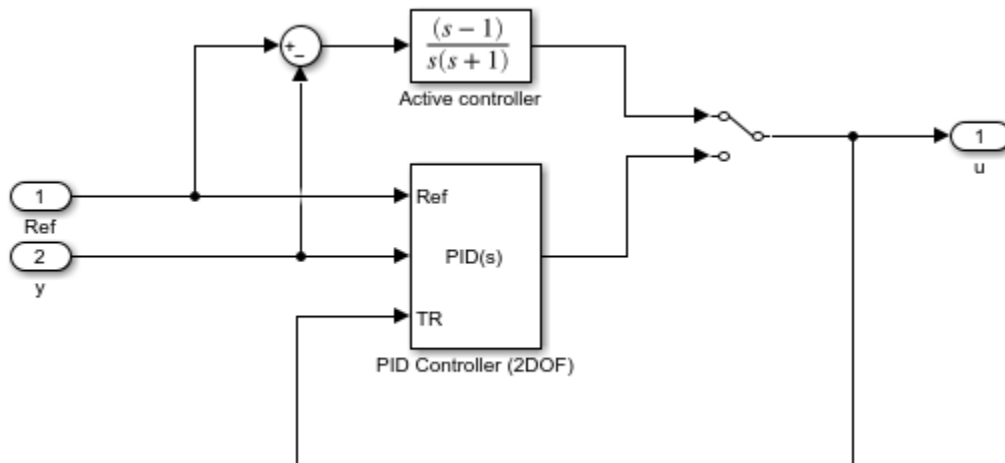

The input Ref takes a reference signal, and the input y takes the measured feedback from the plant. These signals feed the 2DOF controller, and the difference between them feeds the Active controller block (a Zero-Pole block). The output u drives the plant. A switch transfers control between the active controller and the PID Controller (2DOF) block. When the Active controller is in the loop, the PID Controller (2DOF) block tracks its output. Thus, the two controllers have the same output when you switch to PID control, ensuring smooth operation.

Using a Bit Set block

If the Bit Set block is turned on for bit 2 bit 2 is set to 1.

A vector of constants $2.^{[0\ 1\ 2\ 3\ 4]}$ is represented in binary as [00001 00010 00100 01000 10000].

With bit 2 set to 1, the result is [00101 00110 00100 01100 10100], which is represented in decimal as [5 6 4 12 20].

Using a Bit Clear block

If the Bit Clear block is turned on for bit 2, bit 2 is set to 0.

A vector of constants $2.^{[0\ 1\ 2\ 3\ 4]}$ is represented in binary as [00001 00010 00100 01000 10000].

With bit 2 set to 1, the result is [00101 00110 00100 01100 10100], which is represented in decimal as [5 6 4 12 20].

With bit 2 set to 0, the result is [00001 00010 00000 01000 10000], which is represented in decimal as [1 2 0 8 16].

Two-Input AND Logic

This example builds a two-input AND function, which returns 1 when both input elements are 1, and 0 otherwise. To implement this function, specify the **Truth table** parameter value as [0; 0; 0; 1]. The portion of the model that provides the inputs to and the output from the Combinatorial Logic block might look like this:

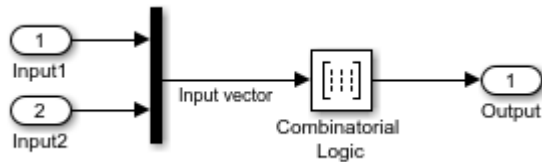

The following table indicates the combination of inputs that generate each output. The input signal labeled **Input** corresponds to the column in the table labeled **Input 1**. Similarly, the input signal **Input 2** corresponds to the column with the same name. The combination of these values determines the row of the **Output** column of the table that is passed as block output. For example, if the input vector is [1 0], the input references the third row:

($2^{1*1} + 1$) The output value is 0.

| Row | Input 1 | Input 2 | Output |
|-----|---------|---------|--------|
| 1 | 0 | 0 | 0 |
| 2 | 0 | 1 | 0 |
| 3 | 1 | 0 | 0 |
| 4 | 1 | 1 | 1 |

Circuit Logic

This sample circuit has three inputs: the two bits (**a** and **b**) to be summed and a carry-in bit (**c**). It has two outputs: the carry-out bit (**c'**) and the sum bit (**s**).

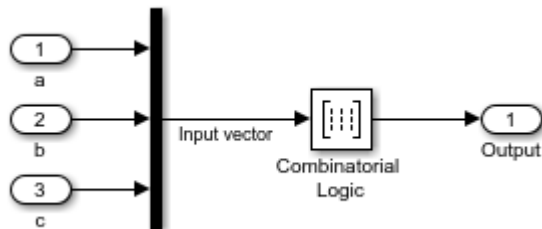

The truth table and corresponding outputs for each combination of input values for this circuit appear in the following table.

| Inputs | | | Outputs | |
|--------|---|---|---------|---|
| a | b | c | c' | s |
| 0 | 0 | 0 | 0 | 0 |
| 0 | 0 | 1 | 0 | 1 |
| 0 | 1 | 0 | 0 | 1 |
| 0 | 1 | 1 | 1 | 0 |
| 1 | 0 | 0 | 0 | 1 |
| 1 | 0 | 1 | 1 | 0 |
| 1 | 1 | 0 | 1 | 0 |
| 1 | 1 | 1 | 1 | 1 |

To implement this adder with the Combinatorial Logic block, you enter the 8-by-2 matrix formed by columns **c'** and **s** as the **Truth table** parameter. You can also implement sequential circuits (that is, circuits with states) with the Combinatorial Logic block by including an additional input for the state of the block and feeding the output of the block back into this state input.

Unsigned Inputs for the Bitwise Operator Block

The following model shows how the Bitwise Operator block works for unsigned inputs.

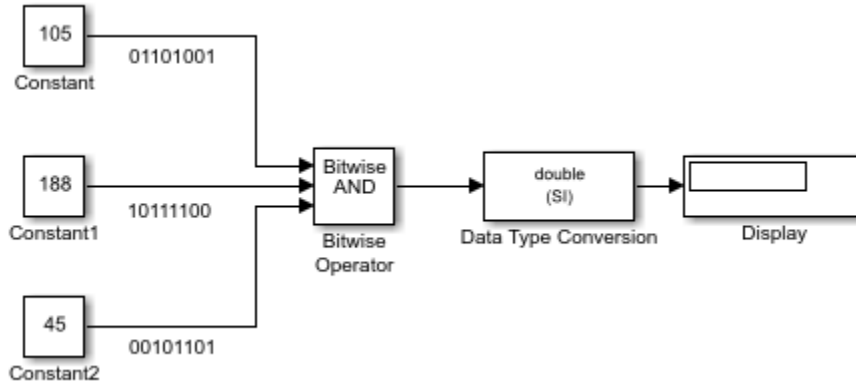

Each Constant block outputs an 8-bit unsigned integer (uint8). To determine the binary value of each Constant block output, use the dec2bin function. The results for all logic operations appear in the next table.

| Operation | Binary Value | Decimal Value |
|-----------|--------------|---------------|
| AND | 00101000 | 40 |
| OR | 11111101 | 253 |
| NAND | 11010111 | 215 |
| NOR | 00000010 | 2 |
| XOR | 11111000 | 248 |
| NOT | N/A | N/A |

Signed Inputs for the Bitwise Operator Block

The following model shows how the Bitwise Operator block works for signed inputs.

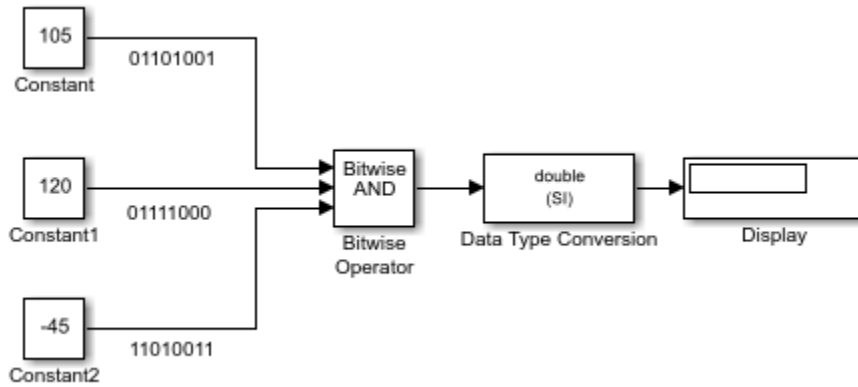

Each Constant block outputs an 8-bit signed integer (`int8`). To determine the binary value of each Constant block output, use the `dec2bin` function. The results for all logic operations appear in the next table.

| Operation | Binary Value | Decimal Value |
|-----------|--------------|---------------|
| AND | 01000000 | 64 |
| OR | 11111011 | -5 |
| NAND | 10111111 | -65 |
| NOR | 00000100 | 4 |
| XOR | 11000010 | -62 |
| NOT | N/A | N/A |

Merge Block with Input from Atomic Subsystems

This example shows a Merge block with inputs from two atomic subsystems.

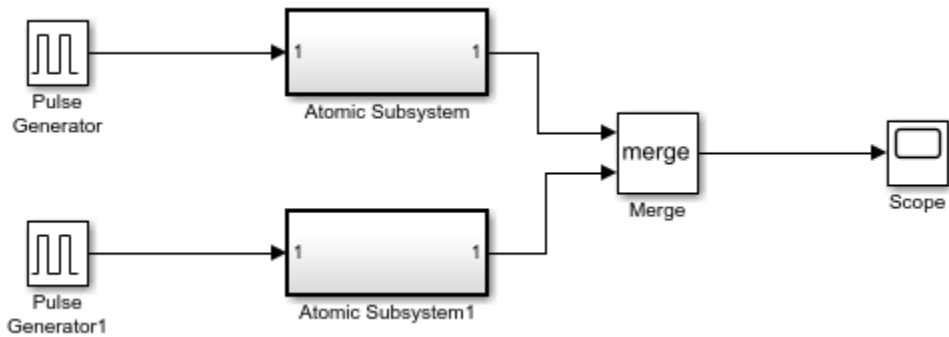

Each Atomic Subsystem block contains an enabled subsystem. This satisfies the requirement that inputs to a Merge block are from a conditionally executed subsystem.

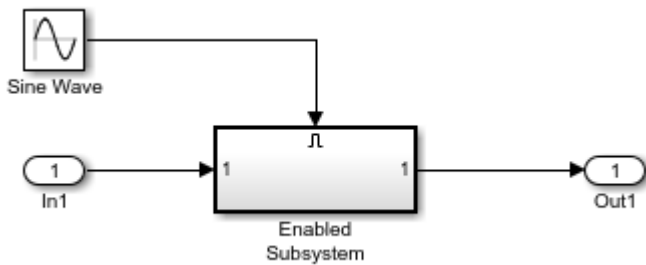

Index Options with the Selector Block

This example shows two Selector blocks with the same kind of input signals, but two different **Index Option** settings.

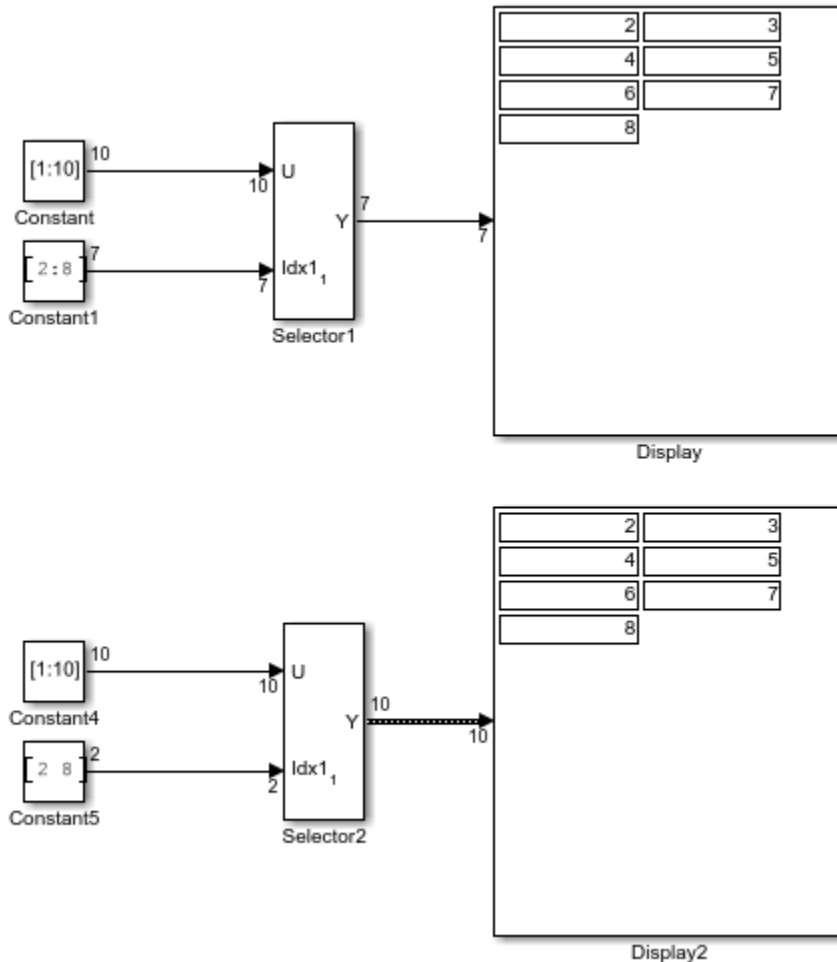

Both Selector blocks select 7 values from the input signal that feeds the input port. The Selector1 block outputs a fixed-size signal, whereas the Selector2 block outputs a variable-size signal whose compiled signal dimension is 10 instead of 7.

The Selector1 block sets **Index Option** to **Index vector (port)**, which uses the input signal from Constant1 as the index vector. The dimension of the input signal is 7, so the Display block shows the 7 values of the Constant1 block. The Selector2 block sets the **Input port size** parameter to 10, which is the size of the largest input signal to the Selector2 block.

The Selector2 block also sets the **Index Option** to **Starting and ending indices (port)**. The output is then set to the size of **Input port size** parameter (10), even though the size of the input signal is 7.

Switch Block with a Boolean Control Port Example

This example shows a Switch block with a Boolean input for the control port.

```
open_system('sldemo_fuelsys');
open_system('sldemo_fuelsys/fuel_rate_control/airflow_calc');
```

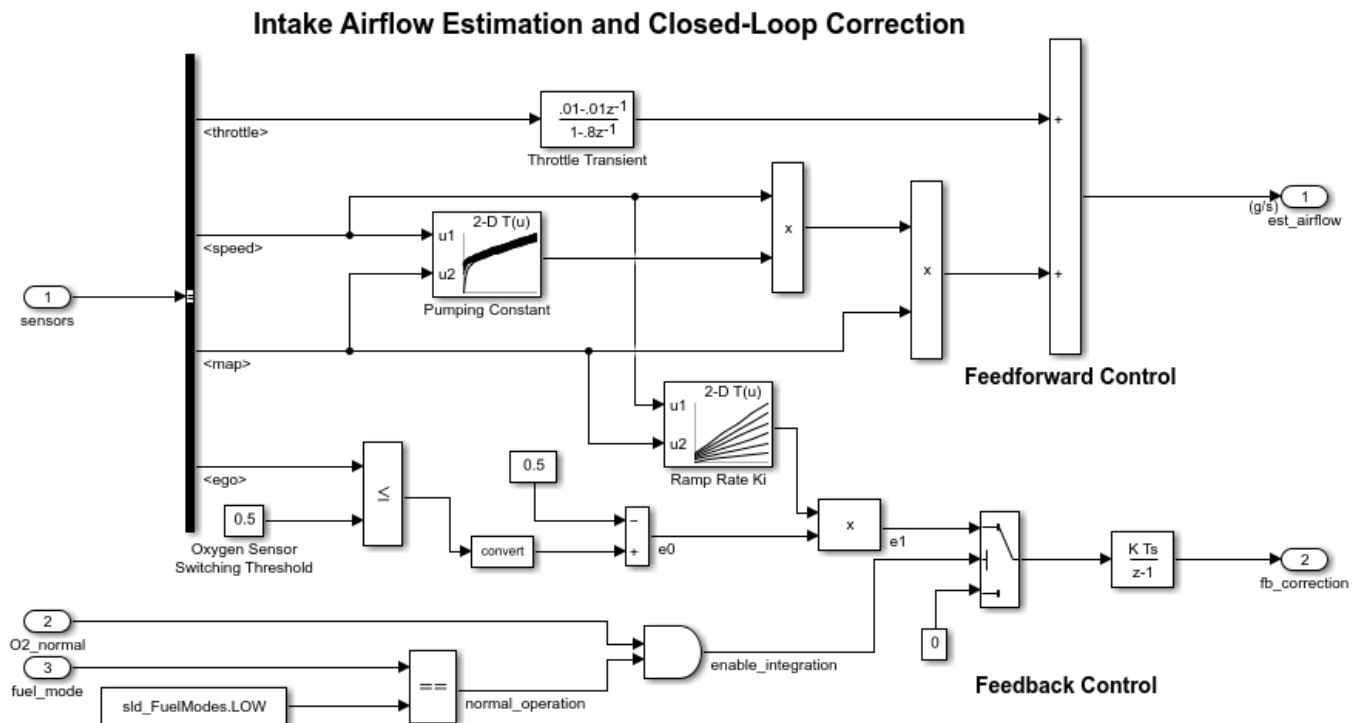

The value of the control port on the Switch block determines whether or not the feedback correction occurs. The control port value depends on the output of the Logical Operator block. When the Logical Operator block output is `true`, then the Switch block control port is 1 and the feedback control occurs. If the Logical Operator block output is `false` then the feedback control does not occur.

See Also

More About

- “Modeling a Fault-Tolerant Fuel Control System” on page 13-112

Merge Block with Unequal Input Widths Example

This example shows how to use the Merge block with inputs ports that have different widths. If you select **Allow unequal port widths**, the block accepts scalar and vector inputs having differing numbers of elements. You can specify an offset for each input signal relative to the beginning of the output signal. The width of the output signal is:

$$\max(w_1 + o_1, w_2 + o_2, \dots, w_n + o_n)$$

where w_n are the widths of the input signals, and o_n are the offsets.

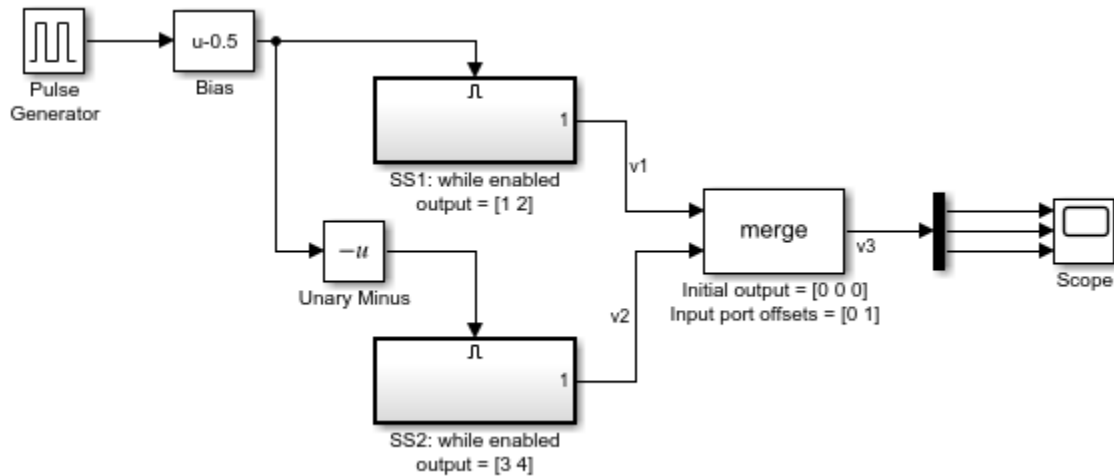

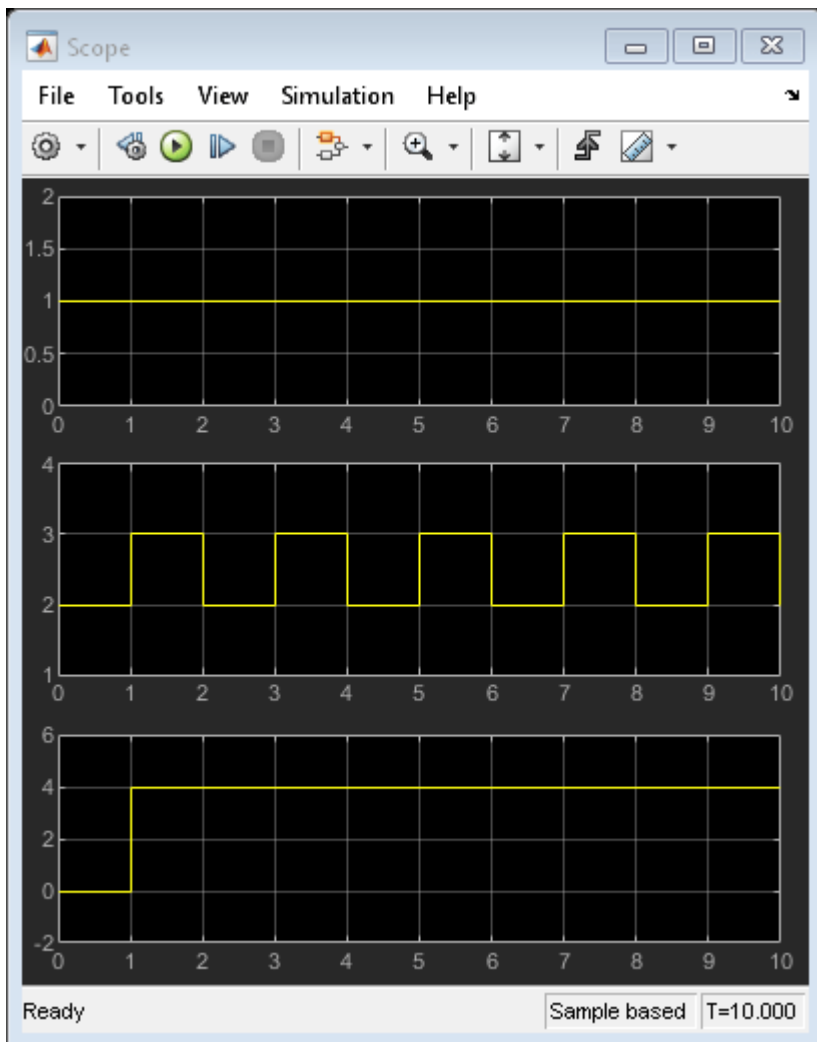

The Merge block has the following output width.

$$\max(2 + 0, 2 + 1) = 3$$

In this example, the offset of v_1 is 0 and the offset of v_2 is 1. The Merge block maps the elements of v_1 to the first two elements of v_3 and the elements of v_2 to the last two elements of v_3 . Only the second element of v_3 is effectively merged, as show in the scope output.

If you use Simplified Initialization Mode, you must clear the `Allow unequal port widths` check box. The input port offsets for all signals must be zero.

Detect Rising Edge of Signals

This example shows how to detect the rising edge of a signal using the Detect Rise Nonnegative and Detect Rise Positive blocks.

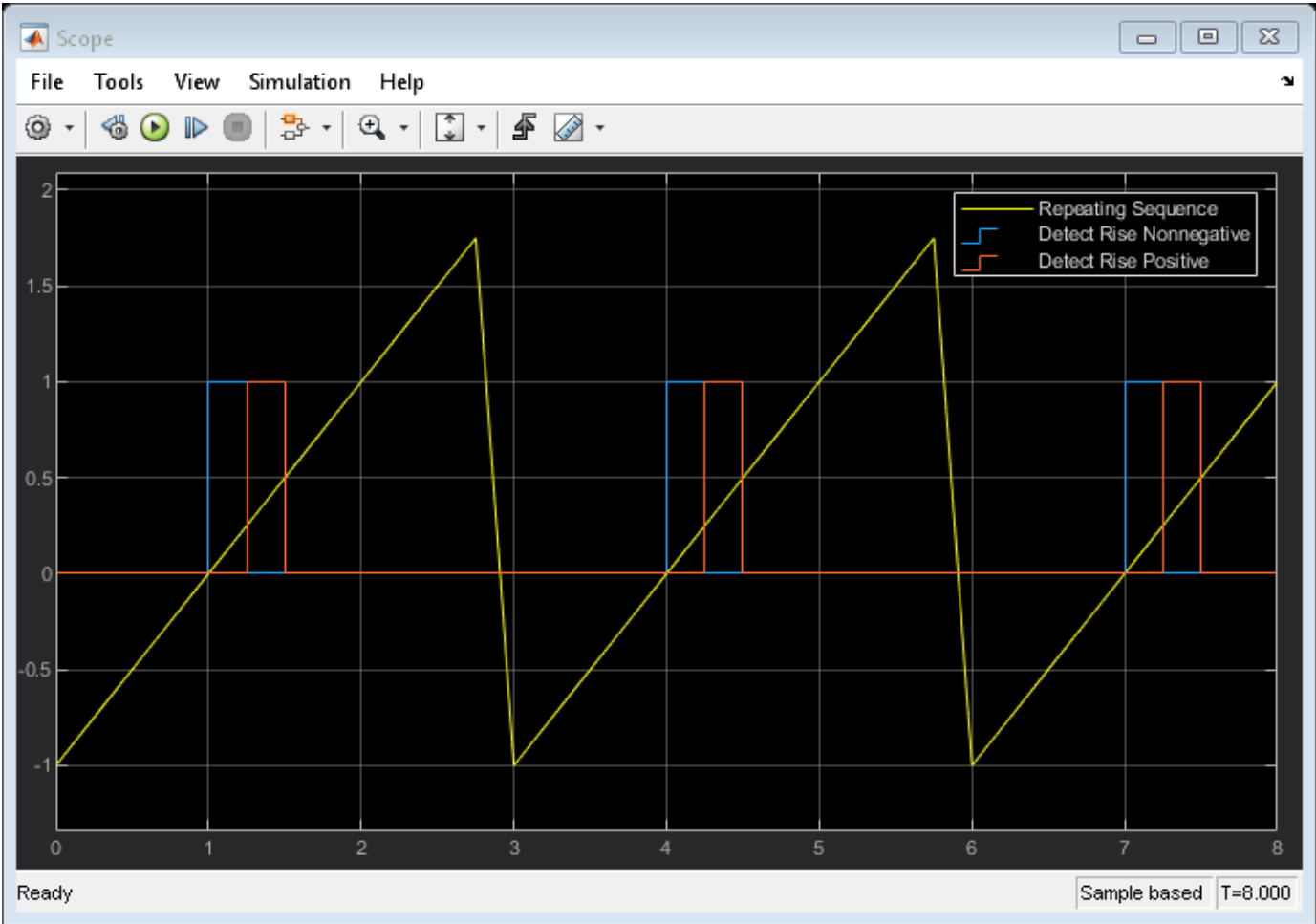
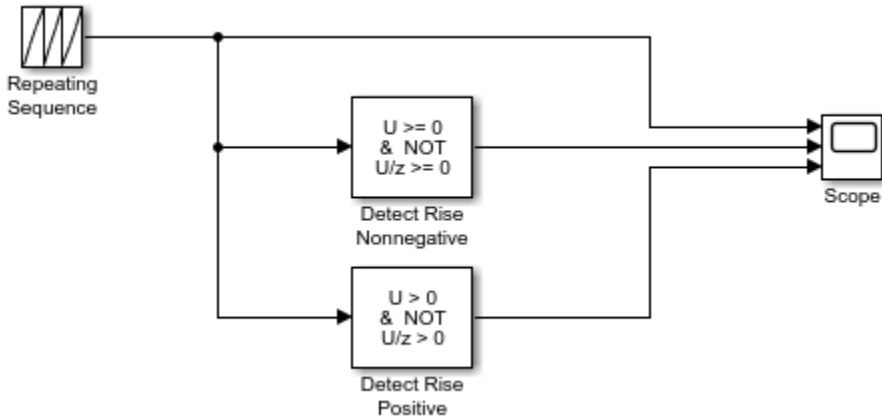

With a fixed-step size of 0.25, this example illustrates the difference between the Detect Rise Nonnegative and Detect Rise Positive blocks. The Detect Rise Nonnegative block outputs true (1) at $t=1$ because the input signal increased from a negative value to a nonnegative value (0). The Detect Rise Positive block outputs true (1) at $t=1.25$ because the input signal increased from a nonpositive value (0) to a strictly positive value.

Detect Falling Edge Using the Detect Fall Nonpositive Block

This example shows how to use the Detect Fall Nonpositive block to detect a falling edge in the input signal. The block detects a falling edge when the signal value decreases from a strictly positive value to a nonpositive value. In this example, the **Initial condition** of the Detect Fall Nonpositive block is set to 1. This means that the Boolean expression $U/z \leq 0$ evaluates to true and the block assumes the initial value of the input signal is nonpositive.

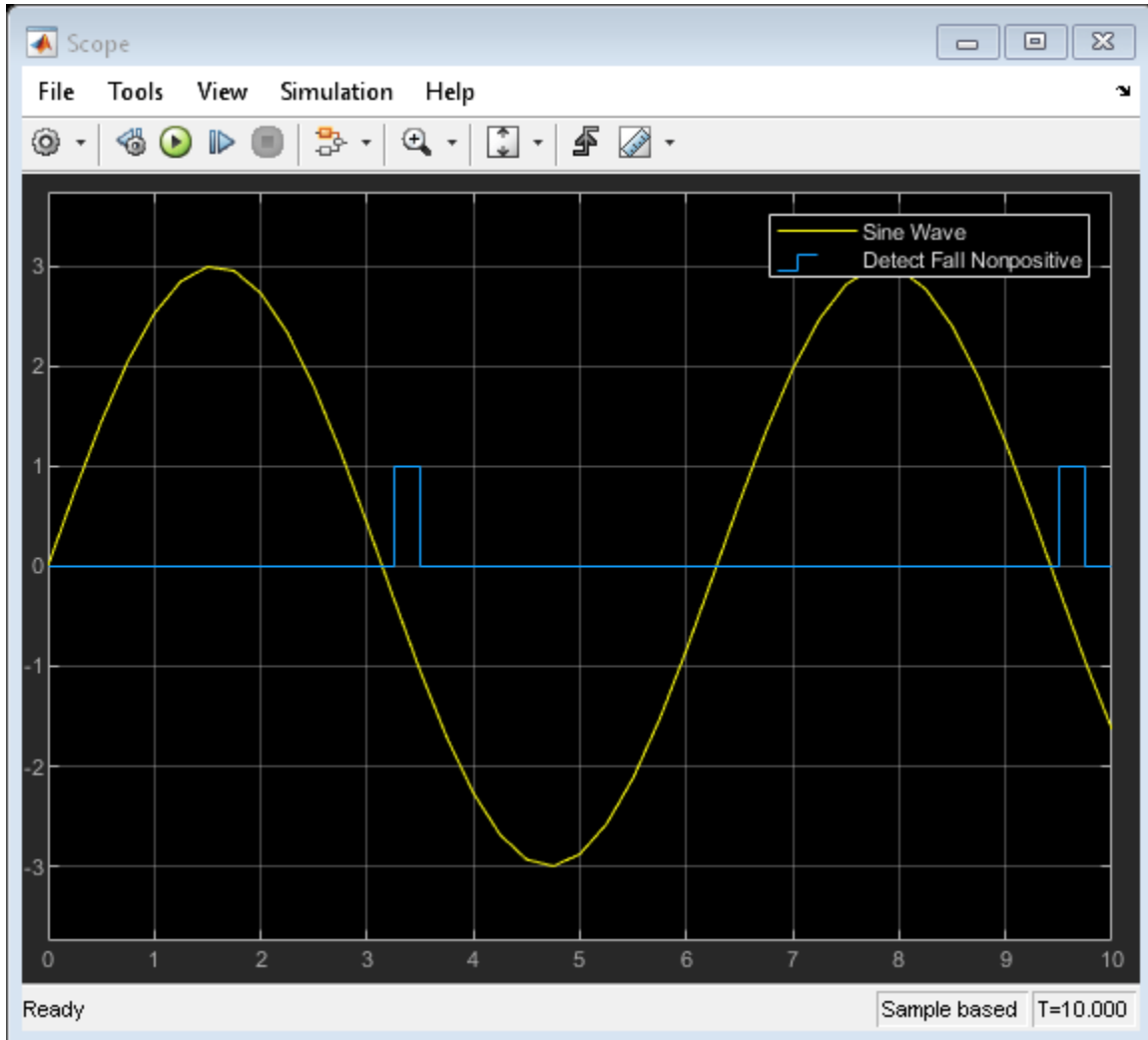
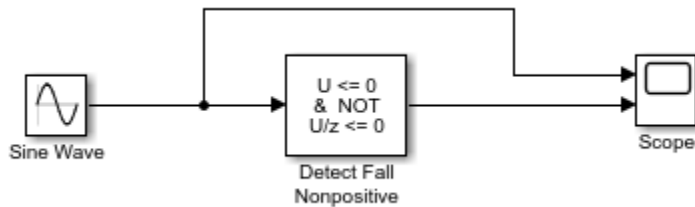

Detect Increasing Signal Values with the Detect Increase Block

This example shows how to use the Detect Increase Block to detect increasing signal values. Because the **Initial condition** is set to -1, the block detects an increasing signal value starting at time $t=0$. If you change the **Initial condition** parameter to a nonnegative value, the block detects the first increasing signal value at $t=0.25$.

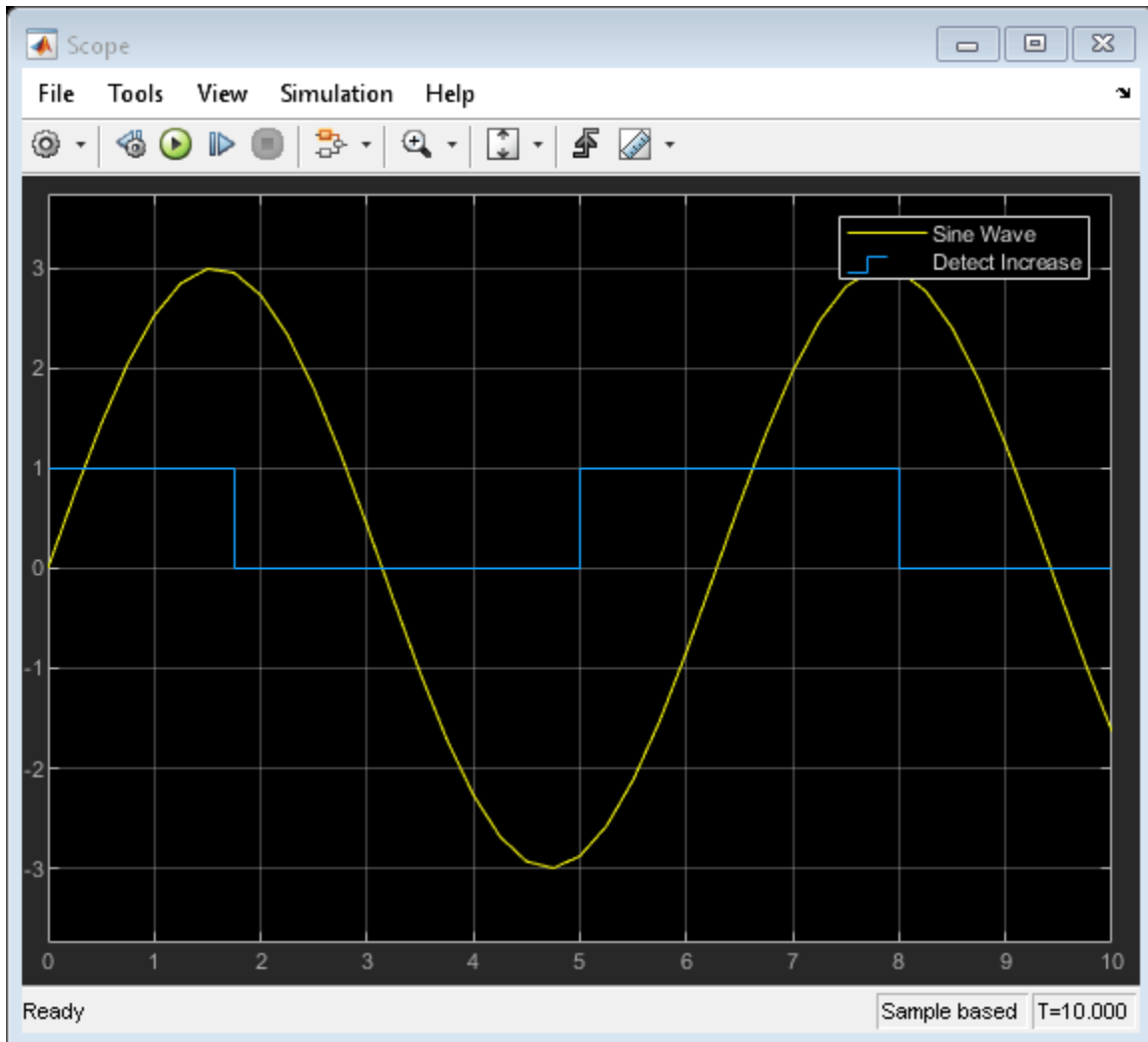
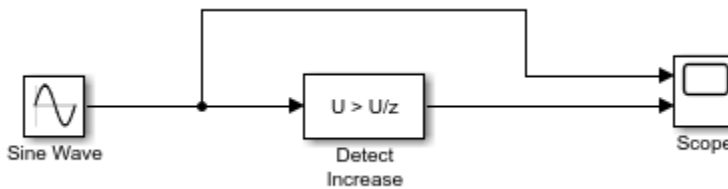

Extract Bits from Stored Integer Value

This example shows how to extract specific bits from the stored integer value of an input signal.

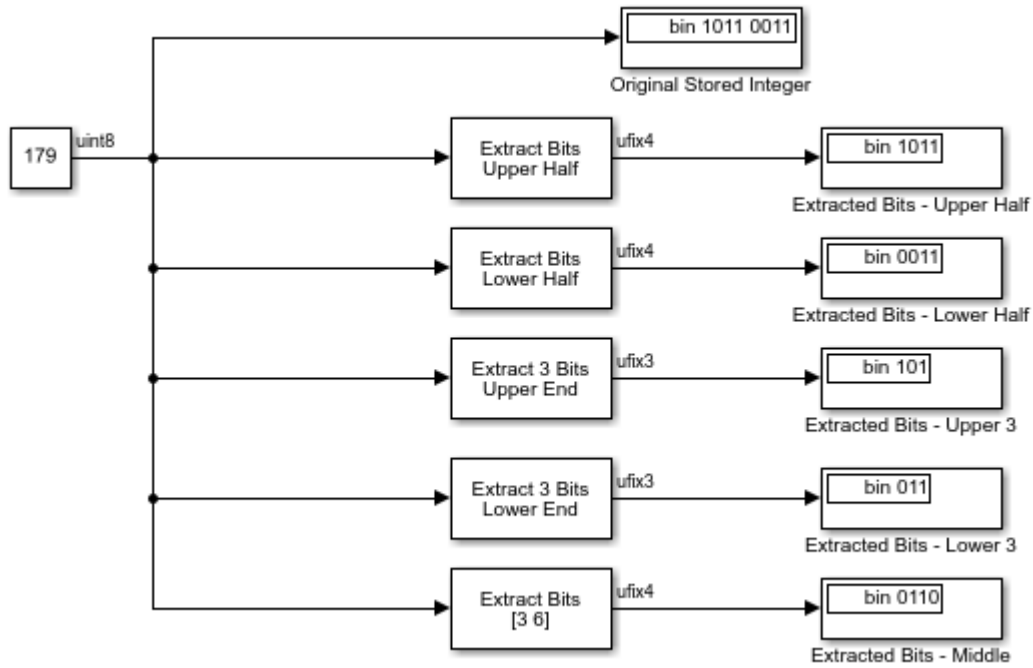

Detect Signal Values Within a Dynamically Specified Interval

This example shows how to detect when an input signal falls within a dynamically specified interval. The interval is defined by two Sine Wave blocks. When the input to the Interval Test Dynamic block falls between those sine waves, the Interval Test Dynamic block outputs true (1).

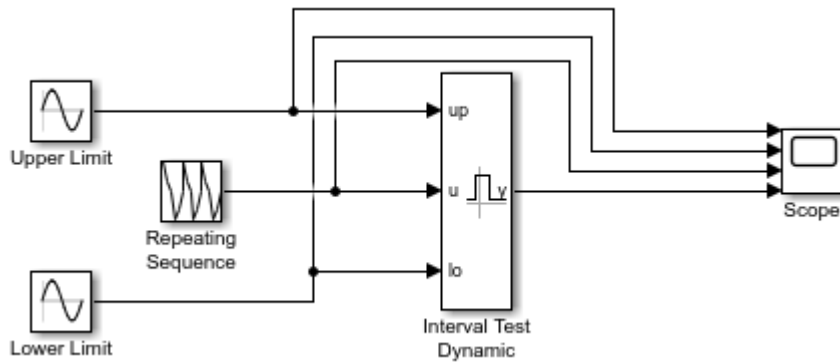

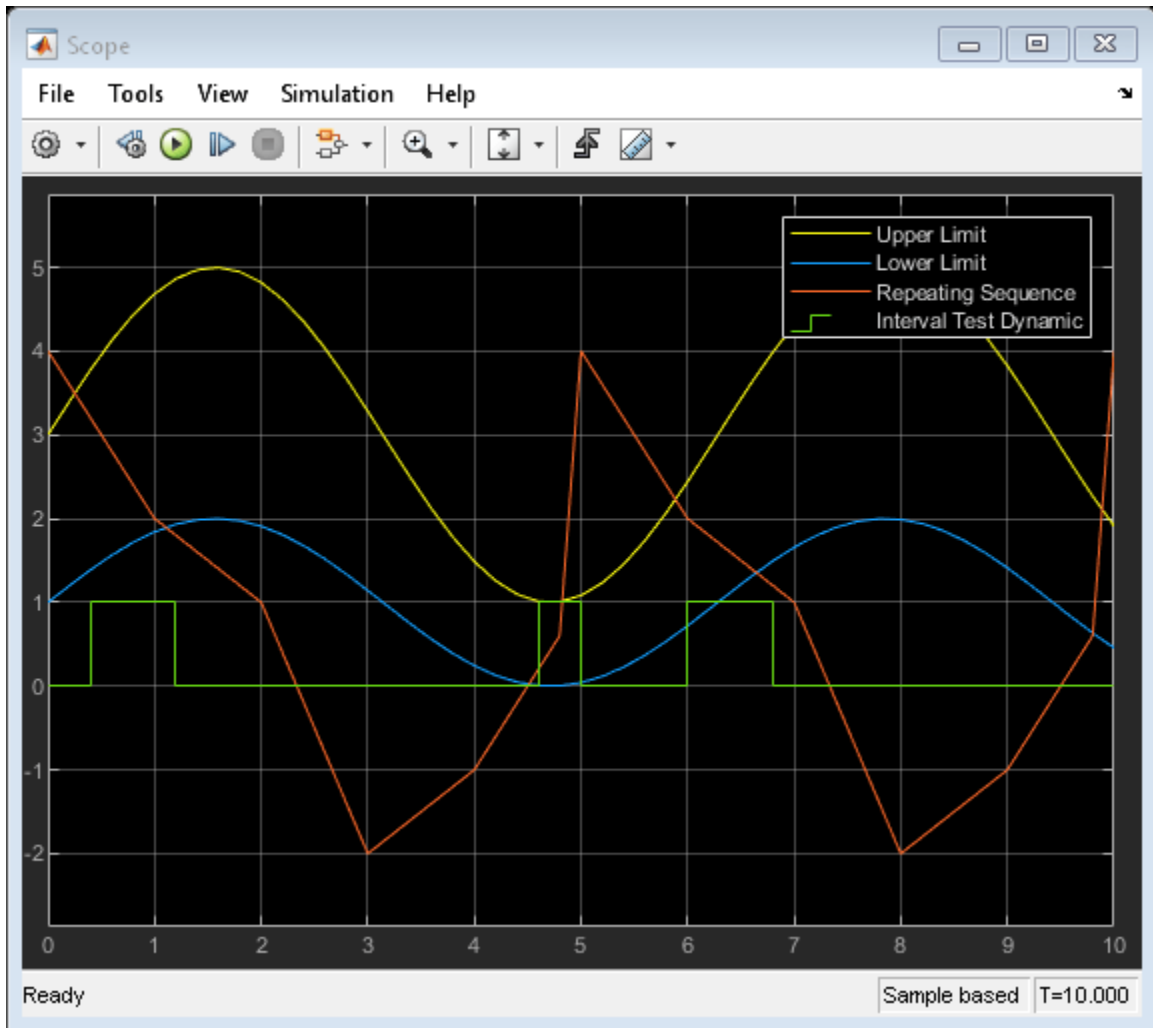

Model a Digital Thermometer Using the Polynomial Block

This example shows how the `ex_sl-demo_boiler` model uses the Polynomial block.

In the Boiler Plant model/digital thermometer subsystem, the Polynomial Block models a first-order polynomial using the coefficients [0.05 0.75]

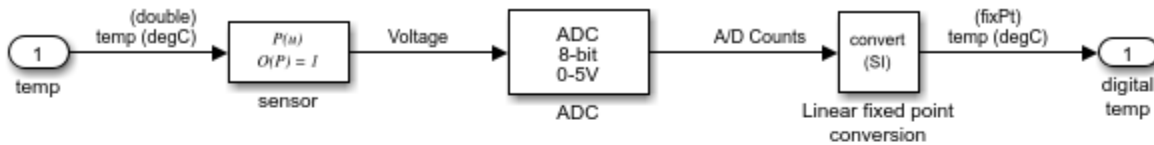

This subsystem models a digital thermometer composed of a simple temperature sensor and an ADC. The transfer function of the sensor is:

$$V = .05 * T + 0.75$$

for T in degrees C.

The conversion block inverts the combined transfer function of the sensor and ADC so that the output is an `sfix(8)` code representing T in degrees C.

Convert Data Types in Simulink Models

This example shows three different methods of converting data types in your model using the Data Type Conversion and Data Type Conversion Inherited blocks. In this model, a Sine Wave block generates the input signal. The Sine Wave block only outputs double-precision data types, so to generate a sine wave with a data type of single, you must perform a data type conversion.

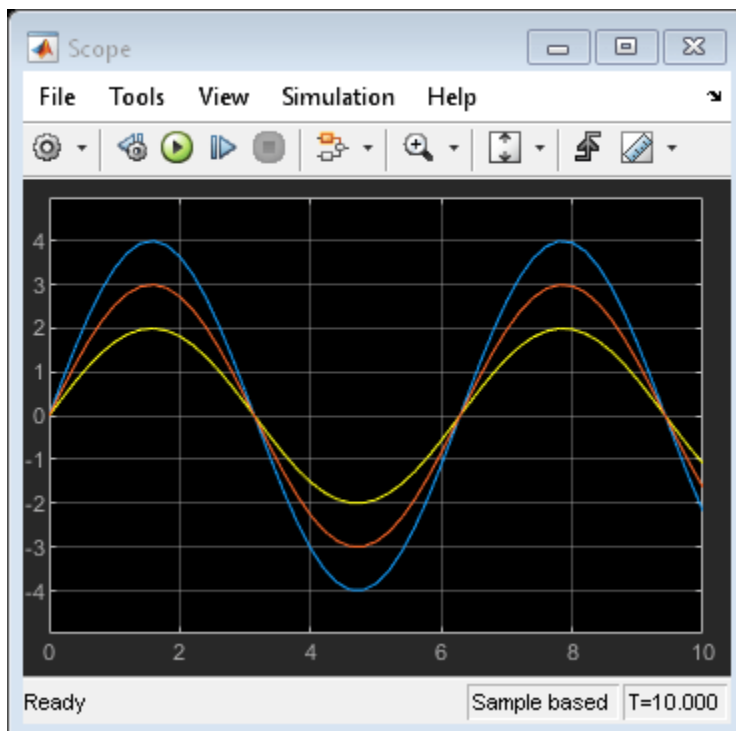
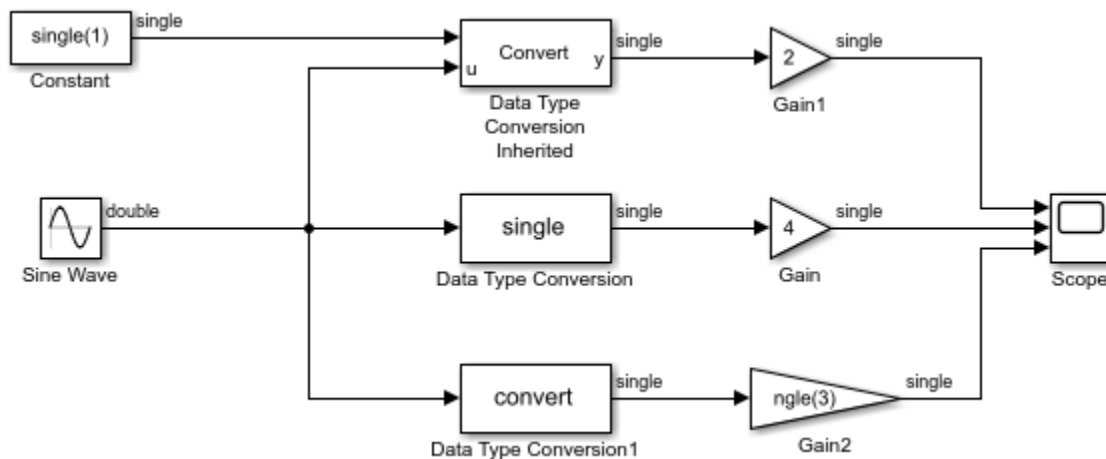

In the first row, the Data Type Conversion Inherited block uses the data type coming from the Constant block (single) as the reference data type, and converts the sine wave to single.

In the second row, the Data Type Conversion block has the **Output data type** set to single, and the sine wave is converted accordingly.

In the third row, the Data Type Conversion1 block has the **Output data type** set to **Inherit via back propagation**. Because the downstream Gain2 block has a data type of single, the Data Type Conversion1 block converts the sine wave to a data type of single.

Control Data Types with the Data Type Duplicate Block

This example shows how to control data types in your model using the Data Type Duplicate block. In this model, the data type of the Constant block (currently `single`) drives the data types throughout the model.

The Constant1 block has its **Output data type** parameter set to `Inherit: Inherit via back propagation`. Because the Constant1 and Constant blocks are both connected to the Data Type Duplicate block, the Constant1 block can inherit its data type from the Constant block. The Sum block has its **Output data type** set to `Inherit: Same as first input`, so it is also able to inherit its data type from the Constant block.

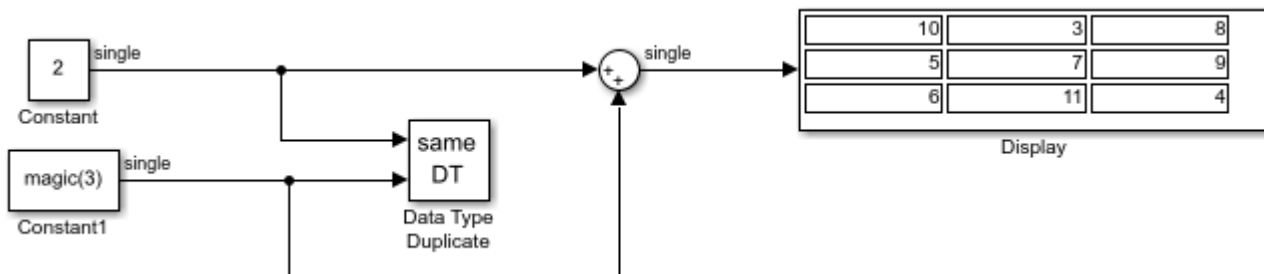

If you change the data type of the Constant block from `single` to `int32`, the `int32` data type propagates throughout the model.

Probe Sample Time of a Signal

The `sldemo_fuelsys` model shows how to check the sample time of a signal using the Probe block. This enables you to verify that the sample time matches the assumed value of the design.

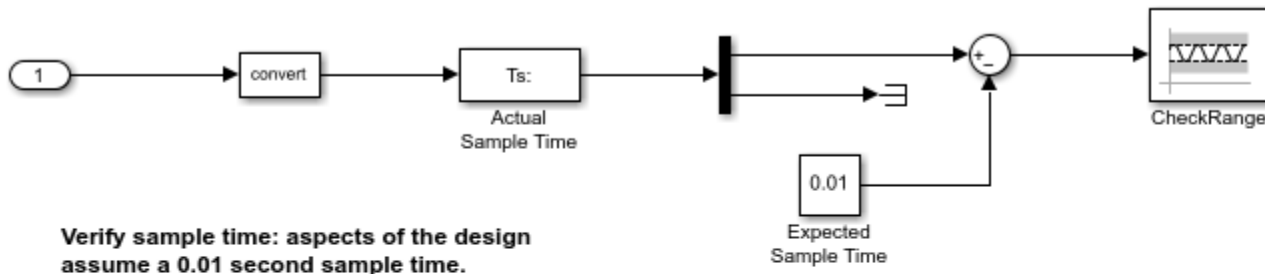

The contents of this subsystem are excluded from the code Simulink Coder generates.

To work correctly this system must continue to

- * Contain no output ports
- * Enable its 'Treat as Atomic Unit' parameter
- * Specify its 'Mask type' parameter as "VerificationSubsystem"

See Also

More About

- "Modeling a Fault-Tolerant Fuel Control System" on page 13-112

Convert Signals Between Continuous Time and Discrete Time

The `sldemo_fuelsys` model shows how to use the Rate Transition block to convert signals between continuous time and discrete time.

Fault-Tolerant Fuel Control System

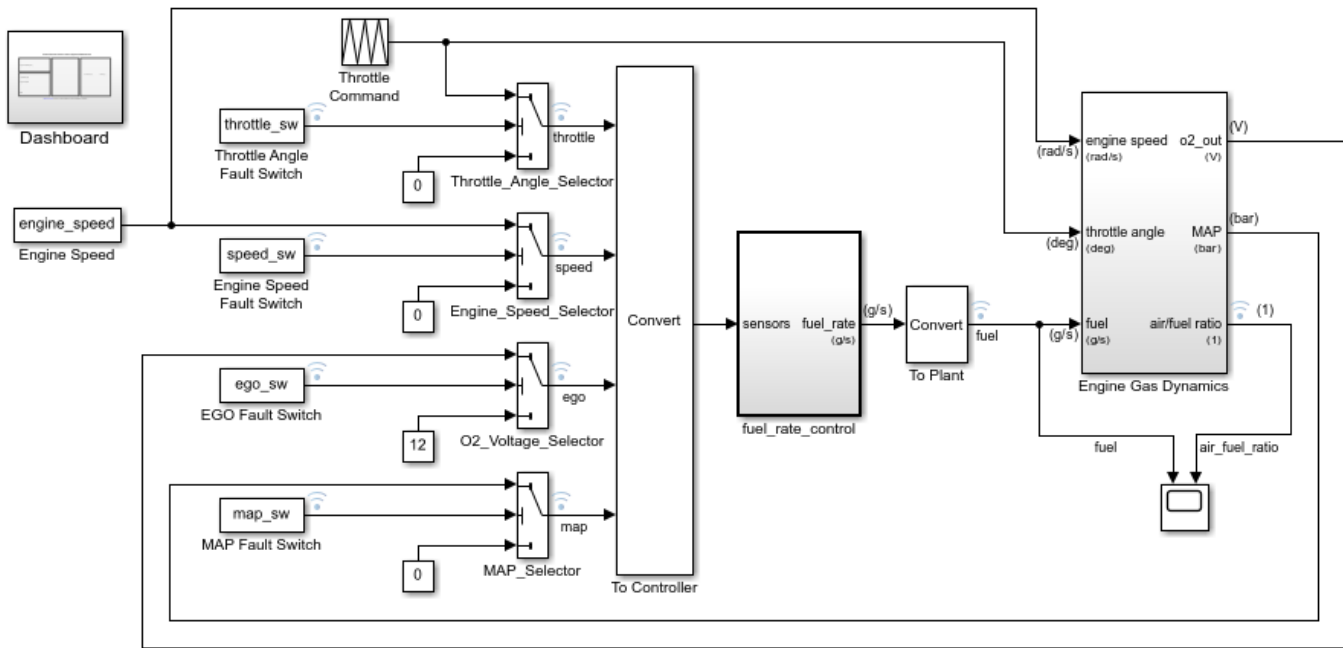

[Open the Dashboard](#) subsystem to simulate any combination of sensor failures.

Copyright 1990-2017 The MathWorks, Inc.

In the `To Controller` subsystem, the Rate Transition block converts the signal from continuous time to discrete time. This discrete-time signal can then be processed by the `fuel_rate_control` subsystem.

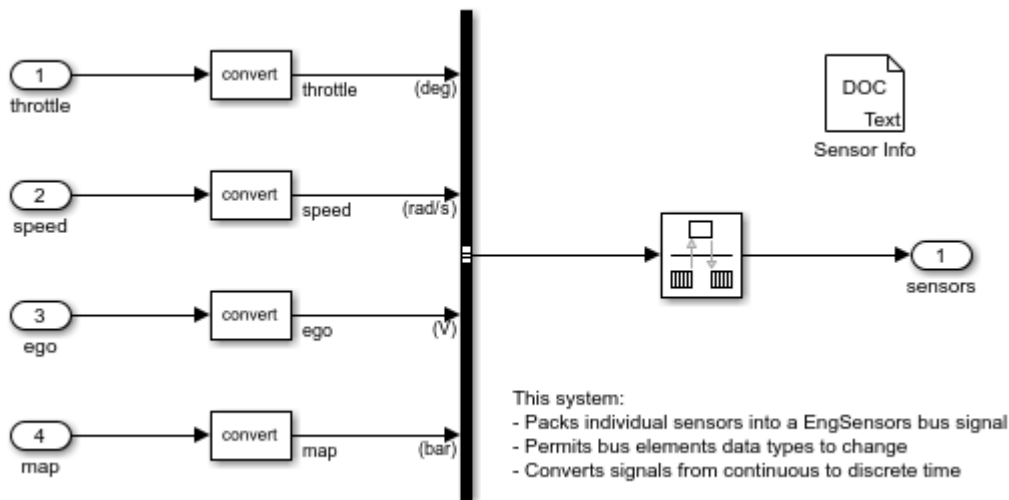

The To Plant subsystem uses the Rate Transition block to convert the discrete-time output of the fuel_rate_control subsystem back to continuous time.



- This system:
- Permits upstream signal data type to change
 - Converts signals from discrete to continuous time

See Also

More About

- “Modeling a Fault-Tolerant Fuel Control System” on page 13-112

Convert Muxed Signal to a Vector

This example shows how to use the Signal Conversion block to convert a muxed input signal to a vector.

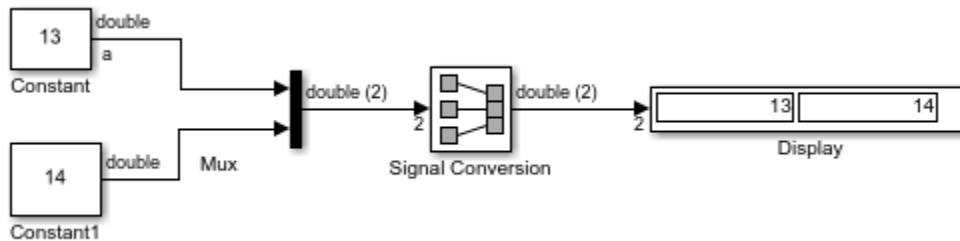

To convert the muxed signal to a vector, the **Output** parameter of the Signal Conversion block is set to `Signal copy`.

Create Contiguous Copy of a Bus Signal

This example shows how to use the Signal Conversion block to create a contiguous copy of a bus signal.

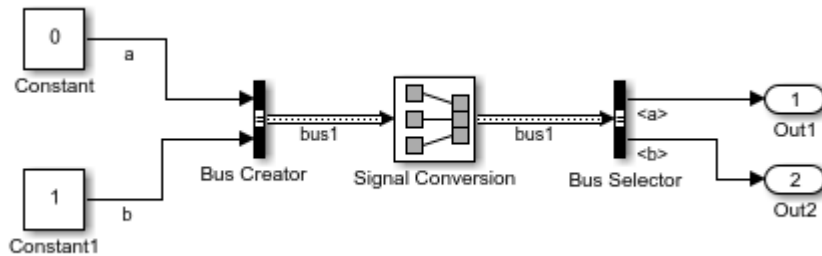

The Bus Creator block creates a nonvirtual bus signal that is input to the Signal Conversion block. With the **Output** parameter set to **Signal copy**, the Signal Conversion block creates another contiguous copy of that input bus signal.

Convert Virtual Bus to a Nonvirtual Bus

In the following example, the Signal Conversion block converts a virtual bus signal from the first Bus Selector block to a nonvirtual bus signal that inputs to the second Bus Selector block. The Signal Conversion block has its **Output** parameter set to `Nonvirtual bus`, and specifies a bus object that matches the bus signal hierarchy of the bus that the first Bus Creator block outputs.

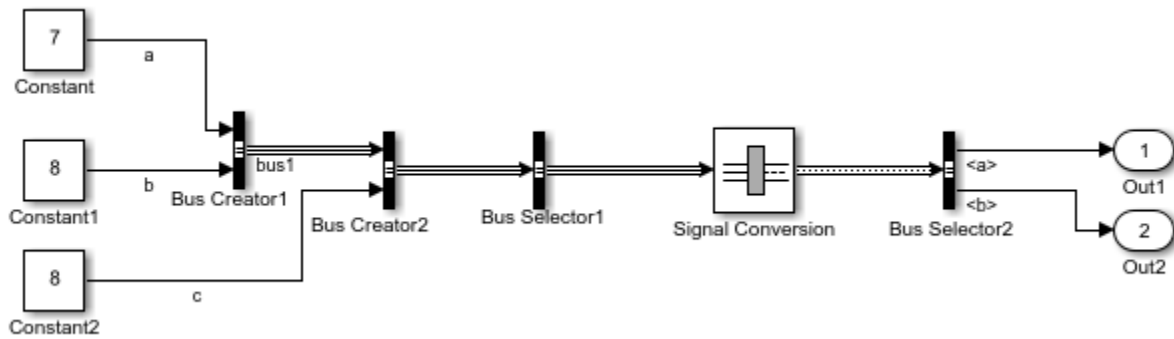

Convert Nonvirtual Bus to Virtual Bus

In the following example, the Signal Conversion block converts the nonvirtual bus signal from the Bus Creator block to a virtual bus signal that inputs to the Bus Selector block. The Signal Conversion block has its **Output** set to Virtual bus.

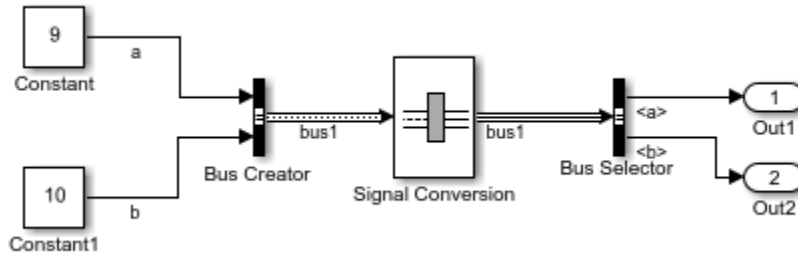

Remove Scaling from a Fixed-Point Signal

This example shows how to strip the scaling from a fixed-point input signal. To do so, the Data Type Scaling Strip block maps the input to the smallest built-in data type that has enough data bits to hold the input. The stored integer value of the input is the value of the output.

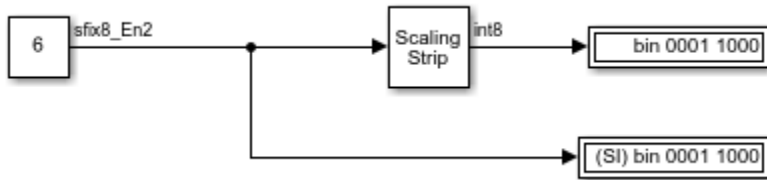

Stop Simulation Block with Relational Operator Block

This example shows how to control when a simulation stops by using a Stop Simulation block with a Relational Operator block. When you simulate the model, the model stops simulation when the simulation time reaches 10.

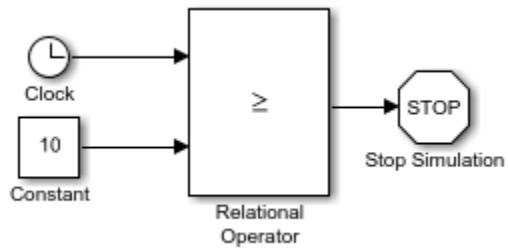

Output Simulation Data with Blocks

This example shows how To Workspace and To File blocks write data to the workspace and to a file respectively.

Open Example Model

```
open_system('ex_ToWorkspace_ToFile');
```

Output Simulation Data with Blocks

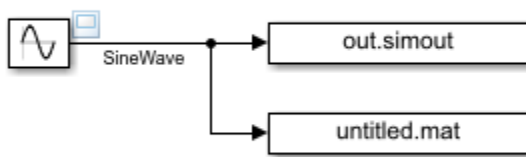

Copyright 1990-2018 The MathWorks, Inc.

Simulate with Default Parameter Values

1. To name the output variables and file, modify the **Variable name** and **File name** block parameter values by using the Block Parameters dialog boxes or the command line.

```
set_param('ex_ToWorkspace_ToFile/To Workspace',...
    'VariableName','simoutToWorkspace')
```

```
set_param('ex_ToWorkspace_ToFile/To File',...
    'FileName','simoutToFile.mat',...
    'MatrixName','simoutToFileVariable')
```

2. Simulate the model.

```
out = sim('ex_ToWorkspace_ToFile');
```

3. To view the input signal for the To Workspace and To File blocks, open the scope viewer.

4. To access the data stored by the To File block, load the output file.

```
load('simoutToFile.mat')
```

5. Plot the data stored by the To Workspace and To File blocks.

```
subplot(2,1,1)
plot(out.simoutToWorkspace,'-o')
legend('simoutToWorkspace')
```

```
subplot(2,1,2)
plot(simoutToFileVariable,'-o')
legend('simoutToFileVariable')
```

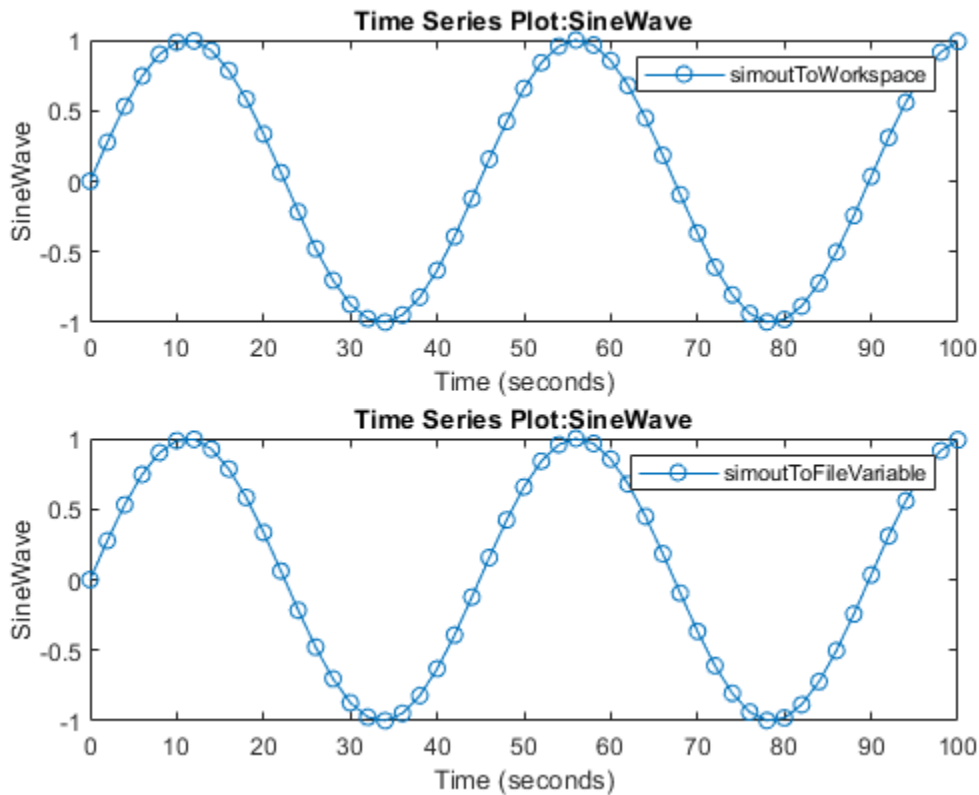

As shown by the plots, the data stored by each block is the same given the default block parameter values.

Simulate with Custom Parameter Values

1. To keep the data from the previous simulation, specify new names for the output variables and file.

```
set_param('ex_ToWorkspace_ToFile/To Workspace',...
    'VariableName', 'simoutToWorkspace2')
```

```
set_param('ex_ToWorkspace_ToFile/To File',...
    'FileName', 'simoutToFile2.mat',...
    'MatrixName', 'simoutToFileVariable2')
```

2. To change the amount of data collected, modify the **Limit data points to last**, **Decimation**, and **Sample time** block parameter values.

```
set_param('ex_ToWorkspace_ToFile/To Workspace',...
    'MaxDataPoints', '3',...
    'Decimation', '20',...
    'SampleTime', '0.5')
```

```
set_param('ex_ToWorkspace_ToFile/To File',...
    'Decimation', '20',...
    'SampleTime', '1')
```

The To File block does not provide the option to limit data points to the last data points collected.

3. Select **Single simulation output**, then modify the **Logging intervals** configuration parameter value.

```
set_param('ex_ToWorkspace_ToFile',...
    'ReturnWorkspaceOutputs','on',...
    'LoggingIntervals','[20,90]')
```

4. Simulate the model.

```
out = sim('ex_ToWorkspace_ToFile');
```

5. To access the data stored by the To File block, load the output file.

```
load('simoutToFile2.mat')
```

6. Plot the data stored by the To Workspace and To File blocks.

```
subplot(2,1,1)
hold on
plot(out.simoutToWorkspace2,'-*','DisplayName','simoutToWorkspace2')
hold off
```

```
subplot(2,1,2)
hold on
plot(simoutToFileVariable2,'-*','DisplayName','simoutToFileVariable2')
hold off
```

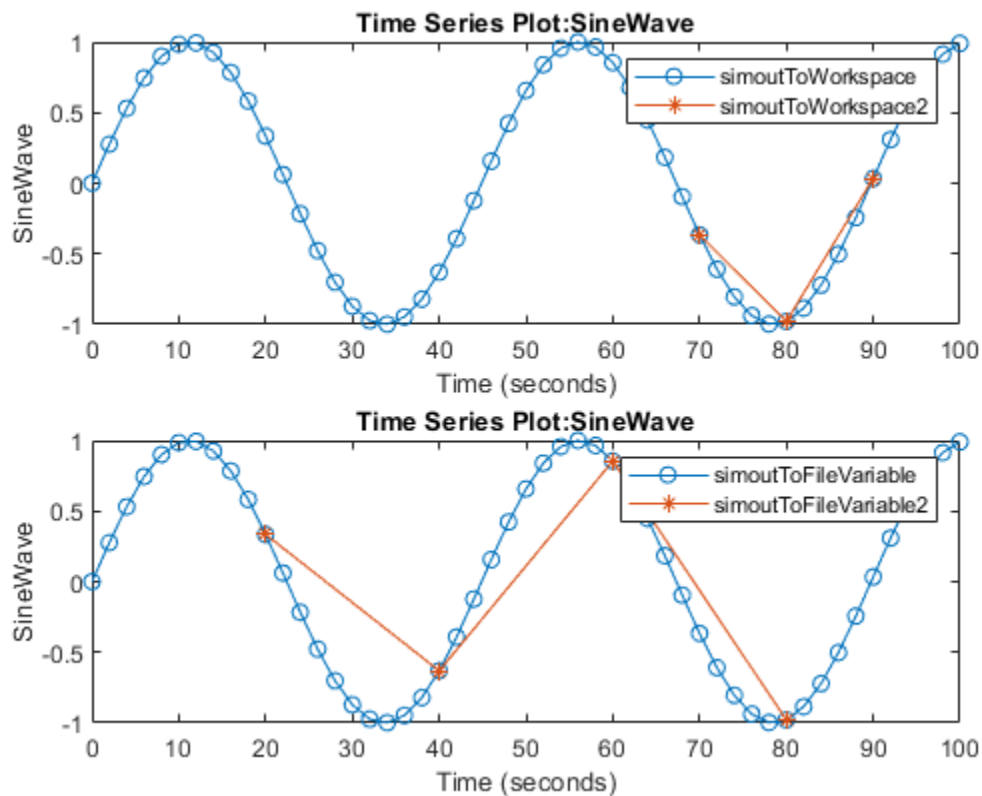

In this example, the To Workspace block collects data at 20, 30, 40, ..., 90 seconds. The data represents every 20th sample time within the logging intervals. When the simulation is completed or

paused, the To Workspace block writes only the last three collected sample points to the workspace: 70, 80, and 90 seconds.

The To File block collects data at 20, 40, 60, and 80 seconds. The data similarly represents every 20th sample time within the logging intervals. However, the sample time for the To File block is double the sample time for the To Workspace block.

Increment and Decrement Real-World Values

This example shows how to increase and decrease the real-world value of a signal using the following blocks:

- Increment Real World
- Decrement Real World
- Decrement Time To Zero
- Decrement To Zero

The Scope block shows the output of a Sine Wave block with amplitude 5, as well as the real-world value of that signal incremented and decremented by one.

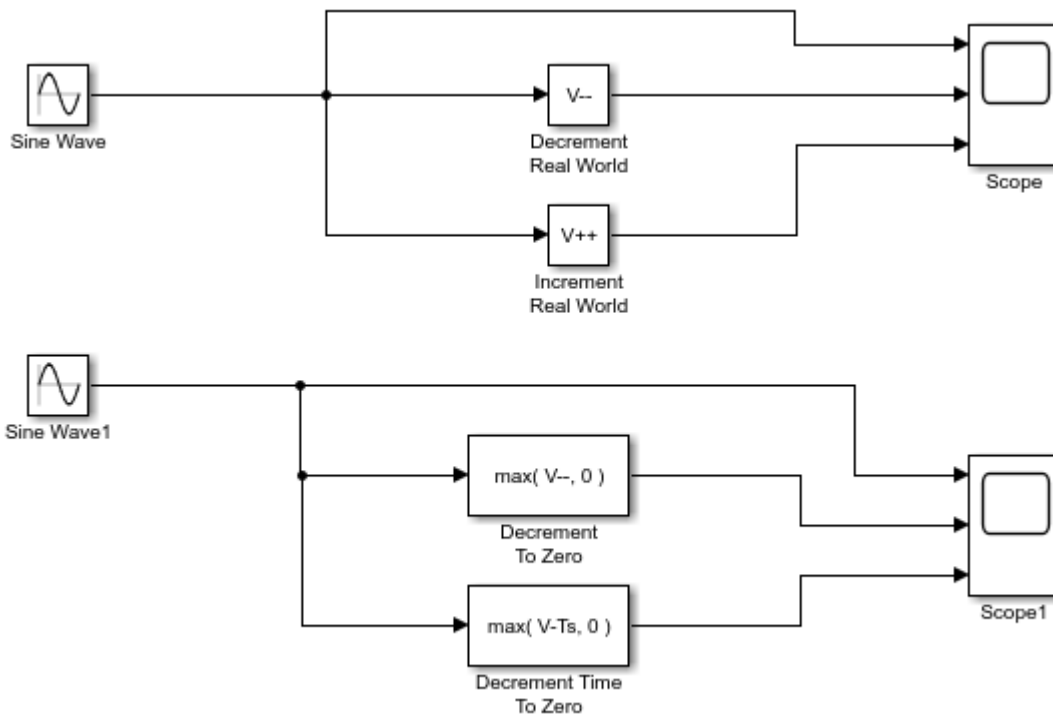

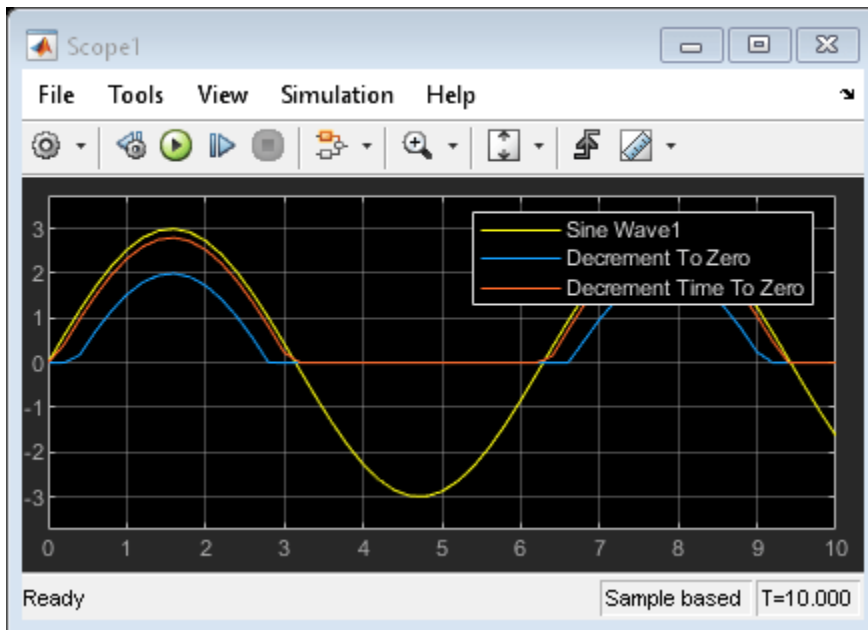
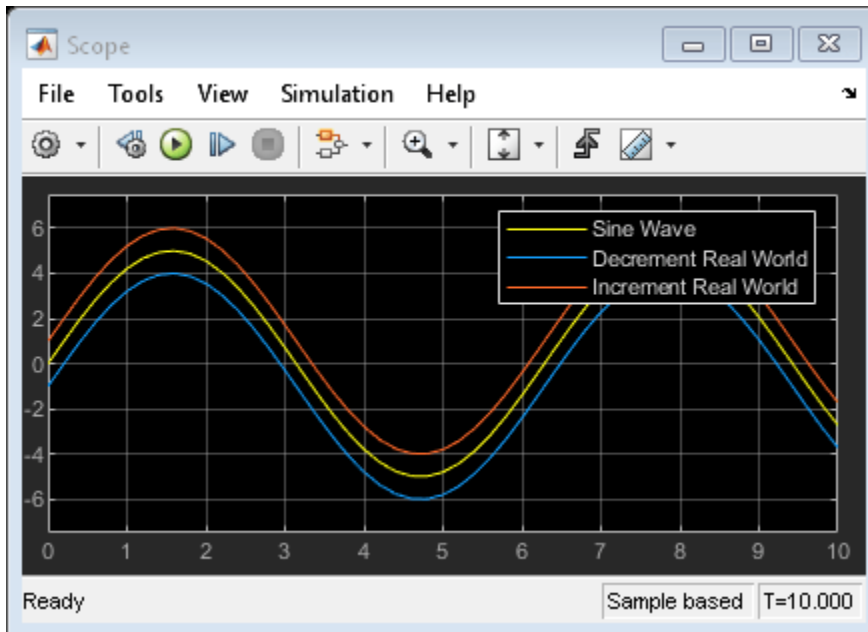

The Scope1 block shows the output of a Sine Wave block with amplitude 3, as well as the output of the Decrement To Zero and Decrement Time To Zero blocks:

- The Decrement To Zero block decreases the input sine wave signal by one, and ensures the value never goes below zero.
- The Decrement Time To Zero block decreases the input sine wave signal by the sample time, T_s , and ensures that the value never goes below zero.

Increment and Decrement Stored Integer Values

This example shows how to increase and decrease the stored integer value of a signal by one.

- The Increment Stored Integer block increases the stored integer value of the input signal by one.
- The Decrement Stored Integer block decreases the stored integer value of the input signal by one.

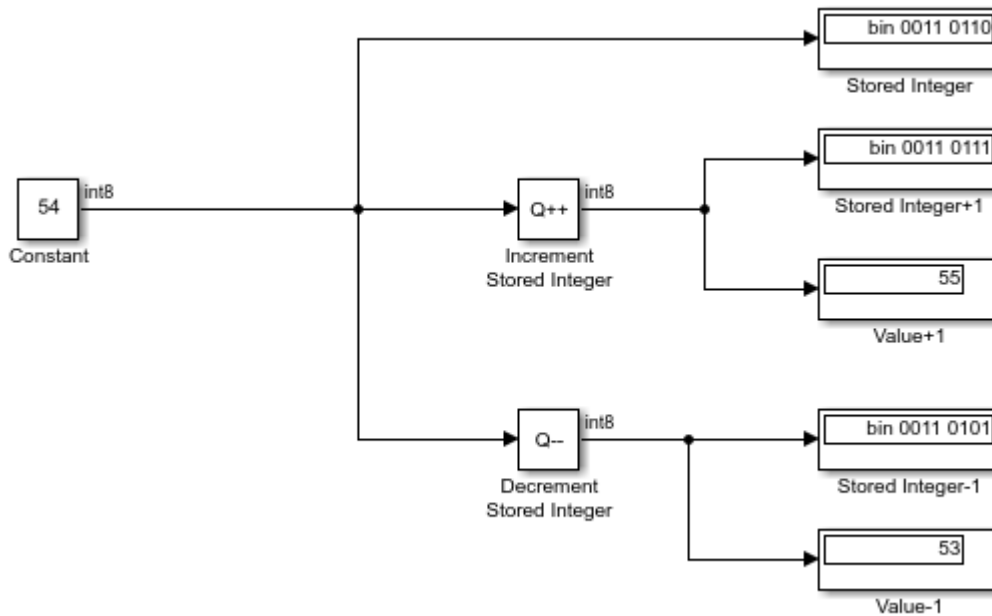

If you change the value of the input signal to 127 (the maximum value representable by an `int8` data type), incrementing the stored integer value by one causes an overflow. Because overflows in the Increment and Decrement Stored Integer blocks always wrap, the Increment Stored Integer block will output a value of -128.

Specify a Vector of Initial Conditions for a Discrete Filter Block

This example shows how to specify a vector of non-zero initial conditions for the Discrete Filter block.

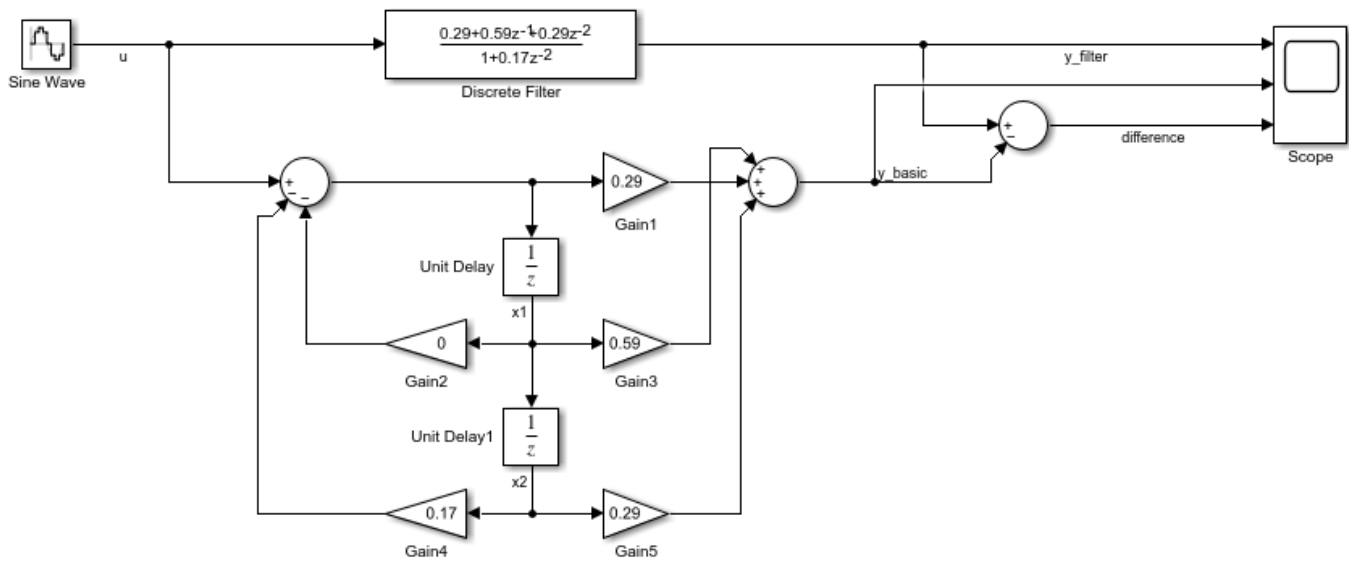

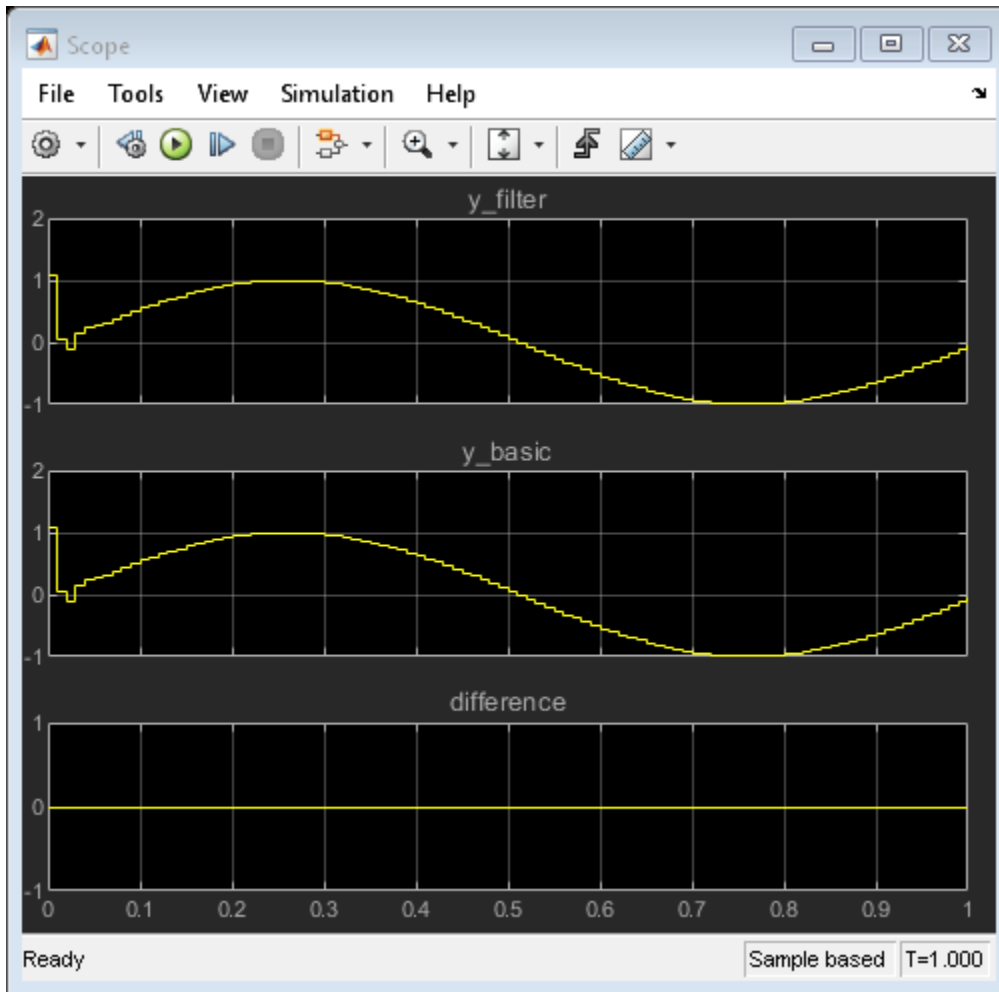

The Scope shows that with the **Initial states** of the Discrete Filter block set to $[1 \ 2]$, the difference between the signal filtered by the Discrete Filter block and the signal from the filter's building blocks is zero. This demonstrates that you can enter the initial conditions of the Discrete Filter block as a vector of $[1 \ 2]$. As an alternative, to achieve the same result, you can set the initial condition of Unit Delay to 1 and Unit Delay1 to 2.

Generate Linear Models for a Rising Edge Trigger Signal

You can use state and simulation time logging to extract the model states at operating points. In this example, the model is configured to get the states when the x1 signal triggers the Trigger-Based Linearization block on a rising edge.

In this model, the **Trigger type** of the Trigger-Based Linearization block is set to **rising**. On the Data Import/Export pane of the Model Configuration Parameters dialog box, the States and Time check boxes are selected.

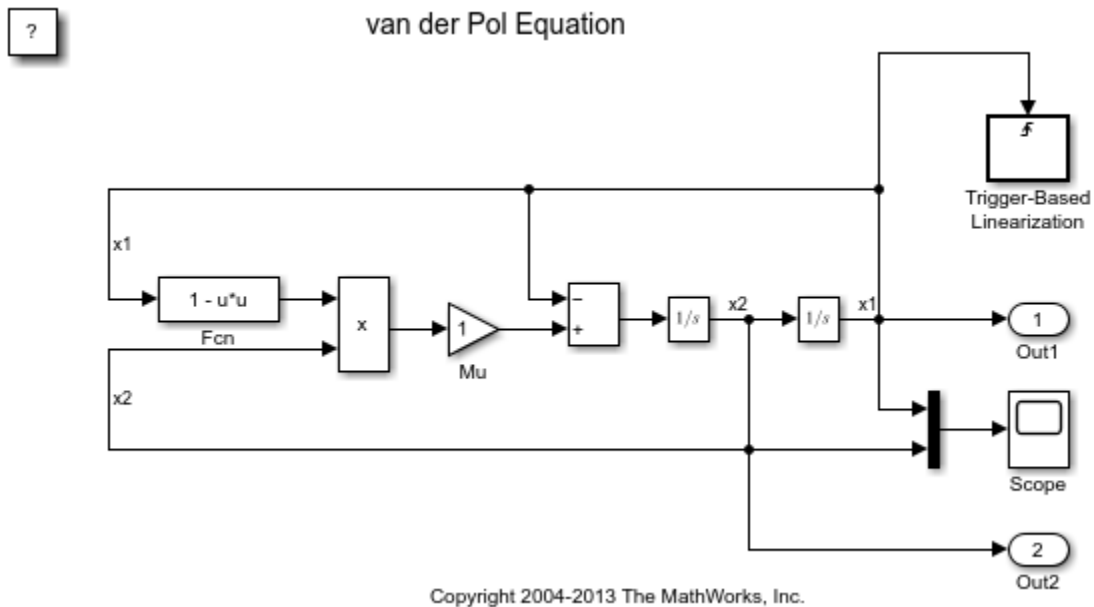

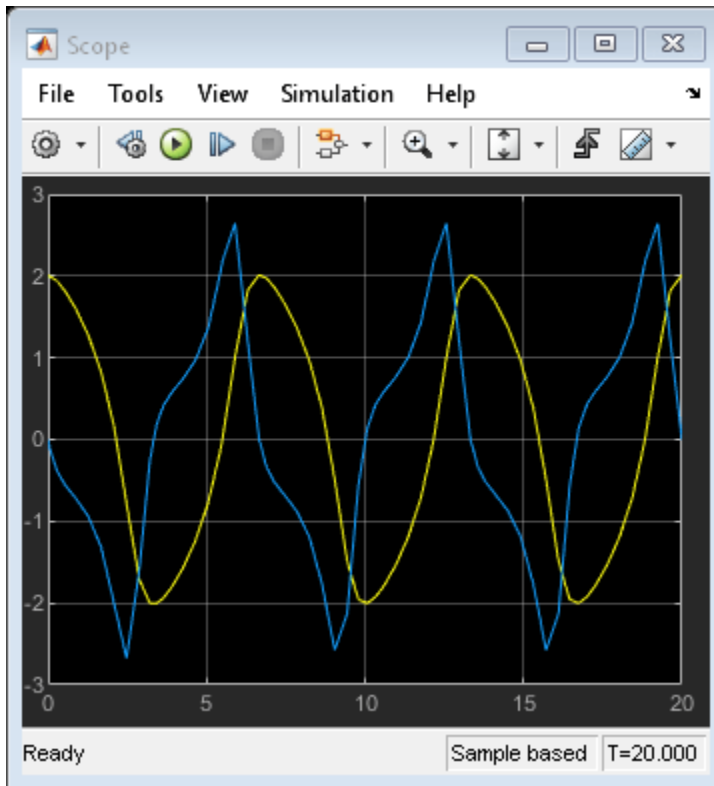

After simulating the model, the following variables appear in the MATLAB workspace:

- `ex_vdp_triggered_linearization_Trigger_Based_Linearization`
- `tout`
- `xout`

To get the index to the first operating point time, execute the following command:

```
ind1 = find(ex_vdp_triggered_linearization_Trigger_Based_Linearization(1).OperPoint.t==tout);
```

To get the state vector at this operating point, execute the following command:

```
x1 = xout(ind1,:);
```

Generate Linear Models at Predetermined Times

This example shows how to use the Timed-Based Linearization block to generate linear models at predetermined times.

In this model, the **Linearization time** of the Timed-Based Linearization block is set to [2 5]. On the Data Import/Export pane of the Model Configuration Parameters dialog box, the States and Time check boxes are selected. These settings enable you to get the states of the model at the simulation times of 2 and 5 seconds.

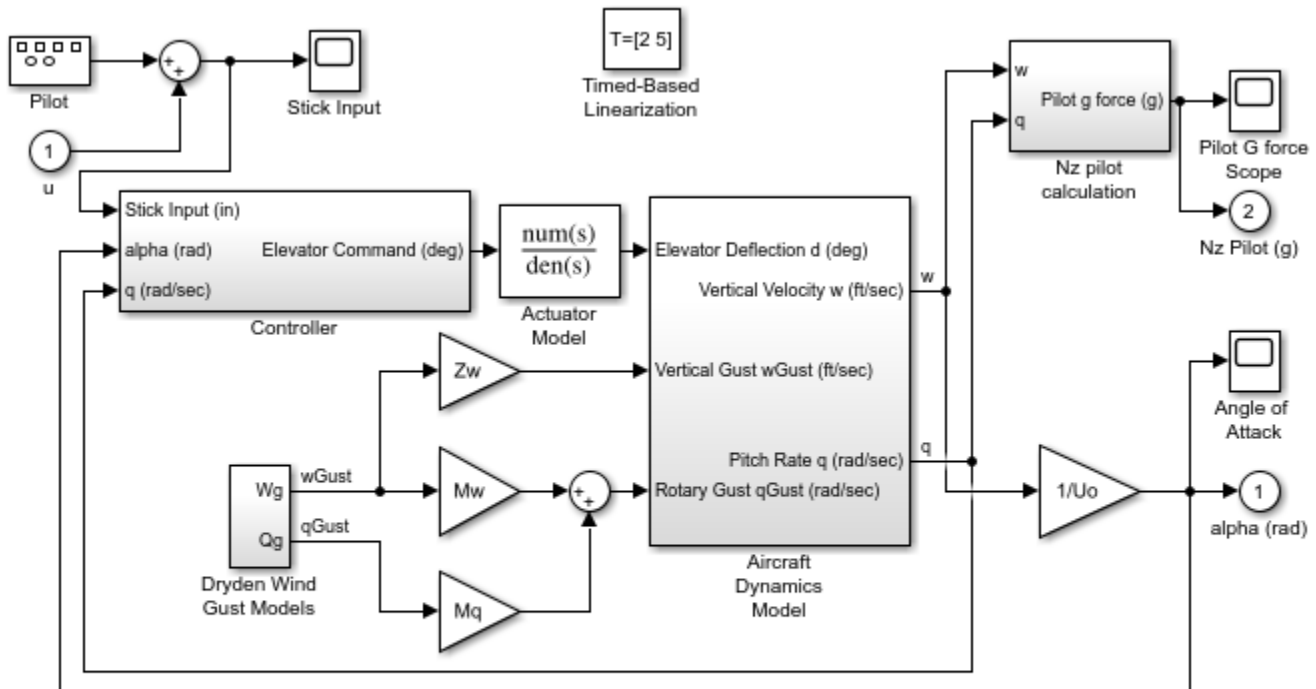

F-14 Flight Control

Copyright 1990-2014 The MathWorks, Inc.

After simulating the model, the following variables appear in the MATLAB workspace:

- `ex_f14_linearization_Timed_Based_Linearization`
- `tout`
- `xout`

To get the indices to the operating point times, execute the following command:

```
ind1 = find(ex_f14_linearization_Timed_Based_Linearization(1).OperPoint.t==tout);
```

To get the state vectors at the operating points, execute the following command:

```
ind2 = find(ex_f14_linearization_Timed_Based_Linearization(1).OperPoint.t==tout);
```

Capture Measurement Descriptions in a DocBlock

This example shows how to use a DocBlock to capture information about a model. In the `sldemo_fuelsys` model, a DocBlock labeled `Sensor Info` is used to document measurement descriptions inside of the `To_Controller` subsystem.

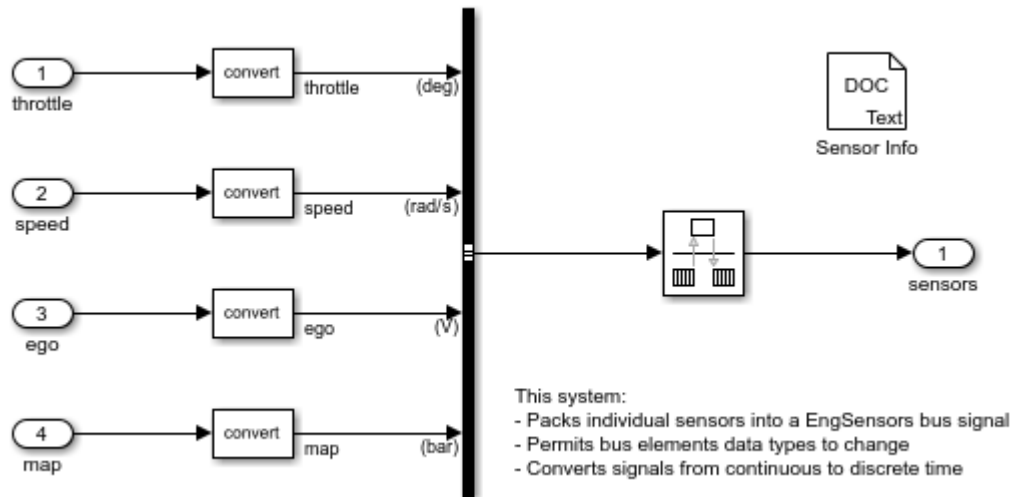

See Also

More About

- “Modeling a Fault-Tolerant Fuel Control System” on page 13-112

Square Root of Negative Values

This example shows how to compute the square root of a negative-valued input signal as complex-valued output.

ans =

```
Simulink.SimulationOutput:  
    tout: [51x1 double]  
  
SimulationMetadata: [1x1 Simulink.SimulationMetadata]  
ErrorMessage: [0x0 char]
```



By setting the **Function** to `sqrt` and **Output signal type** to `complex`, the block produces the correct result of $0 + 10i$ for an input of -100 . If you change the **Output signal type** to `auto` or `real`, the block outputs NaN.

Signed Square Root of Negative Values

This example shows how to compute the signed square root of a negative-valued input signal.

ans =

```
Simulink.SimulationOutput:
      tout: [51x1 double]

SimulationMetadata: [1x1 Simulink.SimulationMetadata]
ErrorMessage: [0x0 char]
```

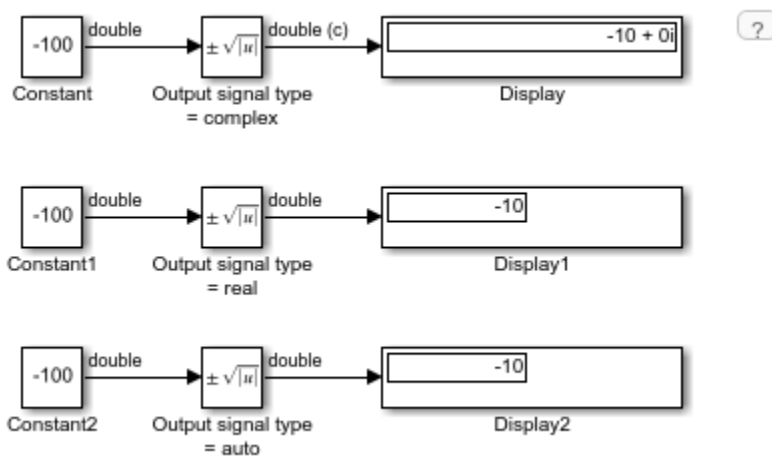

When the block input is negative and you set the **Function** to `signedSqrt`, the Sqrt block output is the same for any setting of the **Output signal type** parameter. By setting the **Numerica display format** of the first Display block to `decimal (Stored Integer)`, you can see the value of the imaginary part for the complex output.

rSqrt of Floating-Point Inputs

This example shows how to compute the rSqrt of a floating-point input signal. The Sqrt block has the following settings:

- **Method** = Newton-Raphson
- **Number of iterations** = 1
- **Intermediate results data type** = Inherit: Inherit from input

After one iteration of the Newton-Raphson algorithm, the block output is within 0.0004 of the final value (0.4834).

ans =

```
Simulink.SimulationOutput:  
    tout: [51x1 double]  
  
SimulationMetadata: [1x1 Simulink.SimulationMetadata]  
ErrorMessage: [0x0 char]
```

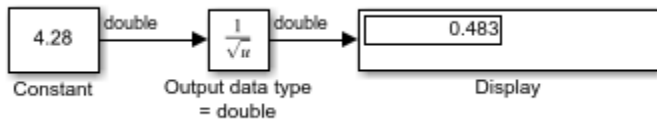

rSqrt of Fixed-Point Inputs

This example shows how to compute the rSqrt of a fixed-point input signal. The Sqrt block has the following settings:

- **Method** = Newton-Raphson
- **Number of iterations** = 1
- **Intermediate results data type** = Inherit: Inherit from input

After one iteration of the Newton-Raphson algorithm, the block output is within 0.0459 of the final value (0.4834).

ans =

```
Simulink.SimulationOutput:  
    tout: [51x1 double]  
  
SimulationMetadata: [1x1 Simulink.SimulationMetadata]  
ErrorMessage: [0x0 char]
```

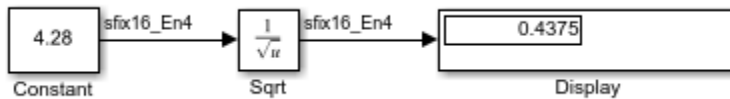

Model a Series RLC Circuit

Physical systems can be described as a series of differential equations in an implicit form,

$$F(t, x, \{\dot{x}\}) = 0, \text{ or in the implicit state-space form } E\dot{x} = Ax + Bu$$

If E is nonsingular, then the system can be easily converted to a system of ordinary differential equations (ODEs) and solved as such:

$$\dot{x} = (E^{-1}A)x + (E^{-1}B)u$$

Many times, states of a system appear without a direct relation to their derivatives, usually representing physical conservation laws. For example:

$$\begin{aligned} \dot{x}_1 &= x_2 \\ 0 &= x_1 + x_2 \end{aligned}$$

In this case, E is singular and cannot be inverted. This class of systems are commonly called *descriptor* systems and the equations are called differential-algebraic equations (DAEs).

Series RLC Circuit

Consider the simple series RLC circuit.

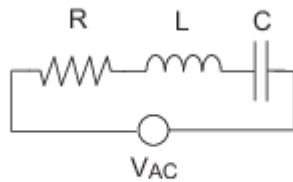

From Kirchoff's Voltage Law, the voltage drop across the circuit is equal to the sum of the voltage drop across each of its elements:

$$V_{AC} = V_R + V_L + V_C$$

From Kirchoff's Current Law:

$$I_{AC} = I_R = I_L = I_C$$

where the subscripts R , L , and C denote the resistance, inductance, and capacitance respectively.

$$V_R = I(t)R$$

$$V_L = LI_L \text{ or } \dot{I}_L = \frac{1}{L}V_L$$

$$V_C = V_{AC}(0) + \int_0^t I_C(\tau) d\tau \text{ or } \dot{V}_c = \frac{1}{C}I_c$$

In Implicit State-Space Form

Model the system in Simulink with $R = 10 \Omega$, $L = 1 \times 10^{-6} H$, $C = 1 \times 10^{-4} F$ to find the voltage across the resistor V_R . To use the Descriptor State-Space block, the system can be written in the implicit, or *descriptor*, state-space form $E\dot{x} = Ax + Bu$ as shown below.

$$\begin{bmatrix} 1 & 0 & 0 & 0 & 0 \\ 0 & 0 & 0 & 0 & 0 \\ 0 & 0 & 0 & 0 & 0 \\ 0 & 0 & 0 & 1 & 0 \\ 0 & 0 & 0 & 0 & 0 \end{bmatrix} \begin{bmatrix} \dot{V}_C \\ \dot{V}_L \\ \dot{V}_R \\ \dot{I}_L \\ \dot{I}_{AC} \end{bmatrix} = \begin{bmatrix} 0 & 0 & 0 & \frac{1}{C} & 0 \\ 1 & 1 & 1 & 0 & 0 \\ 0 & 0 & -1 & R & 0 \\ 0 & \frac{1}{L} & 0 & 0 & 0 \\ 0 & 0 & 0 & 1 & -1 \end{bmatrix} \begin{bmatrix} V_C \\ V_L \\ V_R \\ I_L \\ I_{AC} \end{bmatrix} + \begin{bmatrix} 0 \\ -1 \\ 0 \\ 0 \\ 0 \end{bmatrix} V_{AC}$$

where $x = [V_C \ V_L \ V_R \ I_L \ I_{AC}]^T$ is the state vector.

Set $C = [0 \ 0 \ 1 \ 0 \ 0]$ since the voltage across the resistor is being measured.

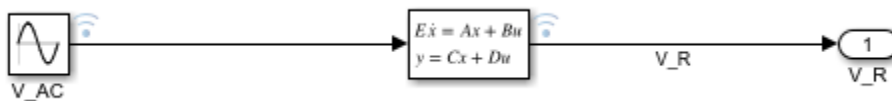

Compare this to modeling the system with an algebraic loop in order to find V_R .

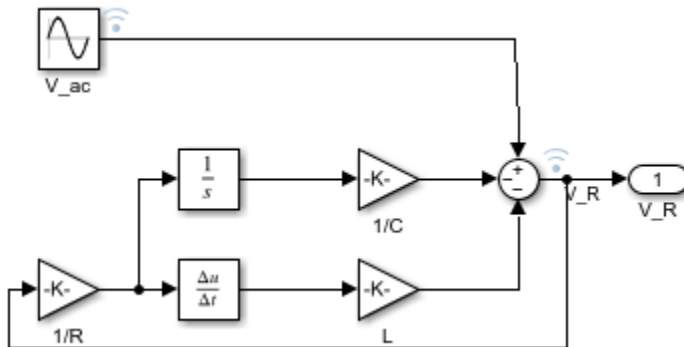

The simulation of both models produces identical results. However, the Descriptor State-Space block allows you to make a simpler block diagram and avoid algebraic loops.

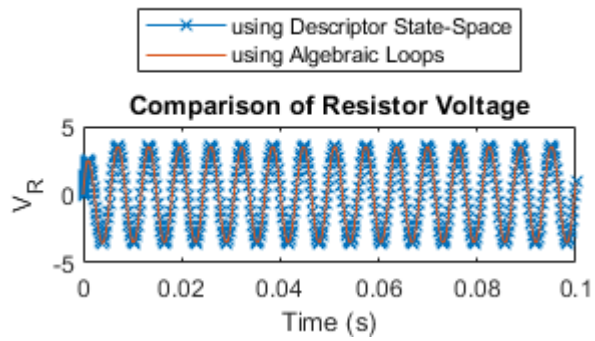

See Also

"Algebraic Loop Concepts"

"Model Differential Algebraic Equations"

Extract Vector Elements and Distribute Evenly Across Outputs

This example shows how you can use the Demux block to distribute an input signal evenly over the desired number of outputs. For an input vector of length 6, when you set the **Number of outputs** parameter to 3, the Demux block creates three output signals, each of size 2.

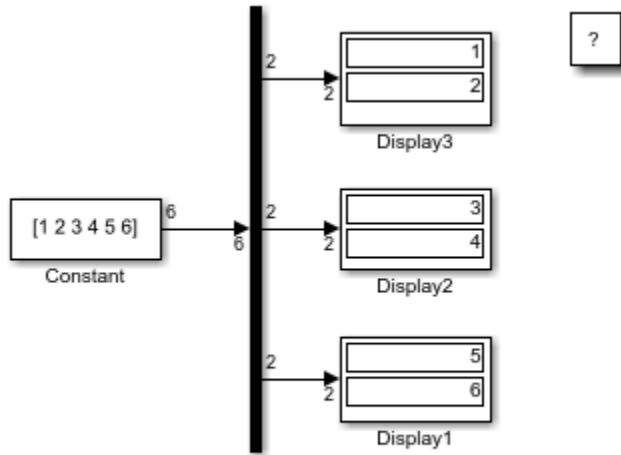

Copyright 2018 The MathWorks, Inc.

See Also

Demux

Extract Vector Elements Using the Demux Block

When using the Demux block to extract and output elements from a vector input, you can use -1 in a vector expression to indicate that the block dynamically sizes the corresponding port. When a vector expression comprises both positive values and -1 values, the block assigns as many elements as needed to the ports with positive values. The block distributes the remaining elements as evenly as possible over the ports with -1 values.

In this example, the **Number of outputs** parameter of the Demux block is set to [-1, 3, -1]. Thus, the block outputs three signals where the second signal always has three elements. The sizes of the first and third signals depend on the size of the input signal. For an input vector with seven elements, the Demux block outputs two elements on the first port, three elements on the second port, and two elements on the third port.

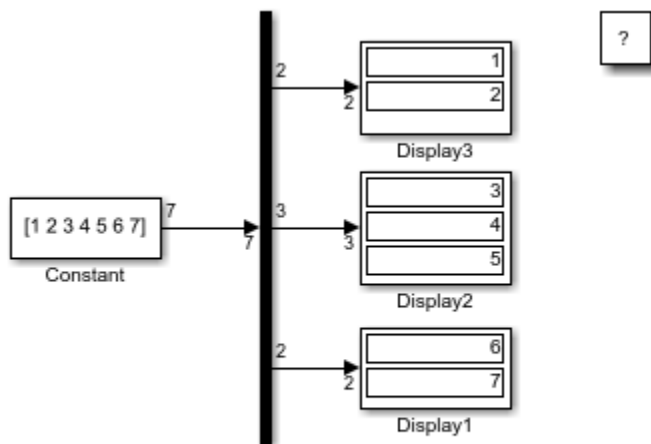

Copyright 2018 The MathWorks, Inc.

See Also

Demux

Detect Change in Signal Values

This example shows how to detect a change in signal values using the Detect Change block. When the input from the Pulse Generator block remains the same, the Detect Change block outputs zero (false), indicating that there was no change in signal values. When the value of the Pulse Generator block changes, the Detect Change block outputs one (true) indicating that the current signal value does not equal its previous value.

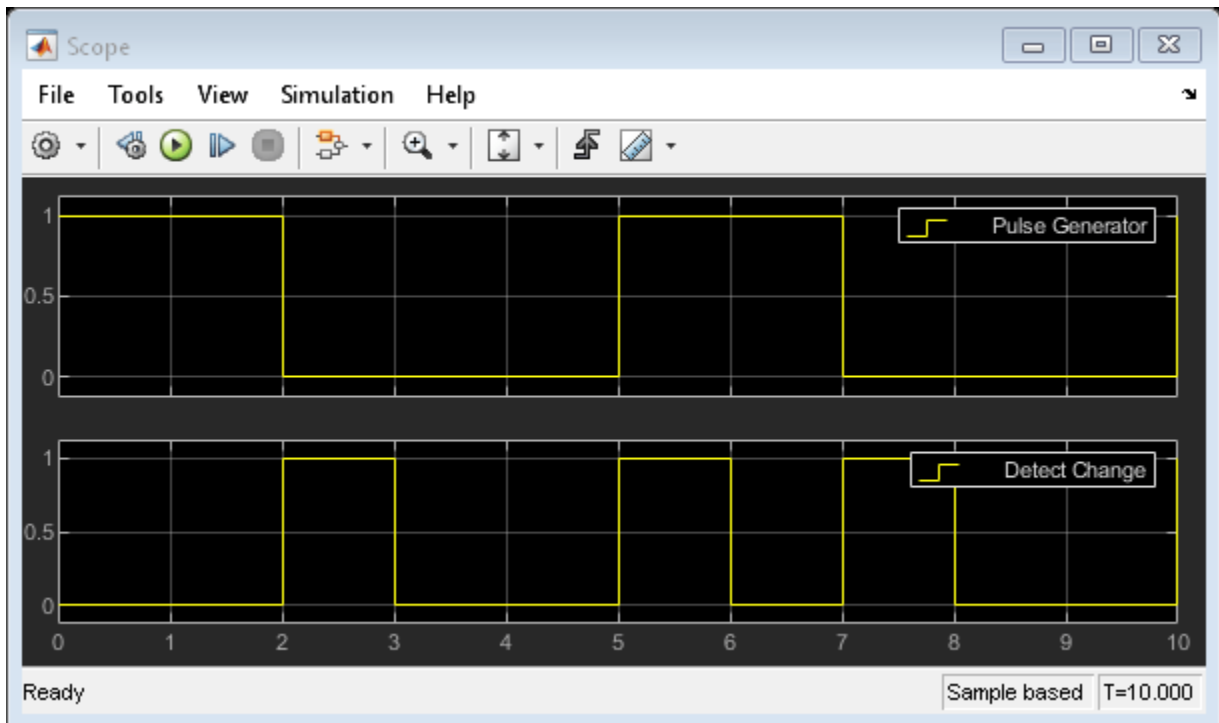
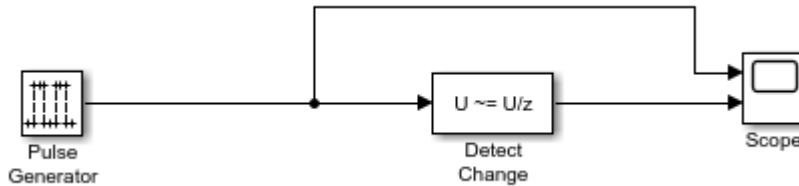

See Also

Detect Change | Pulse Generator | Scope

Detect Fall to Negative Signal Values

This example shows how to detect when a signal value decreases to a strictly negative value from a value that was greater than or equal to zero.

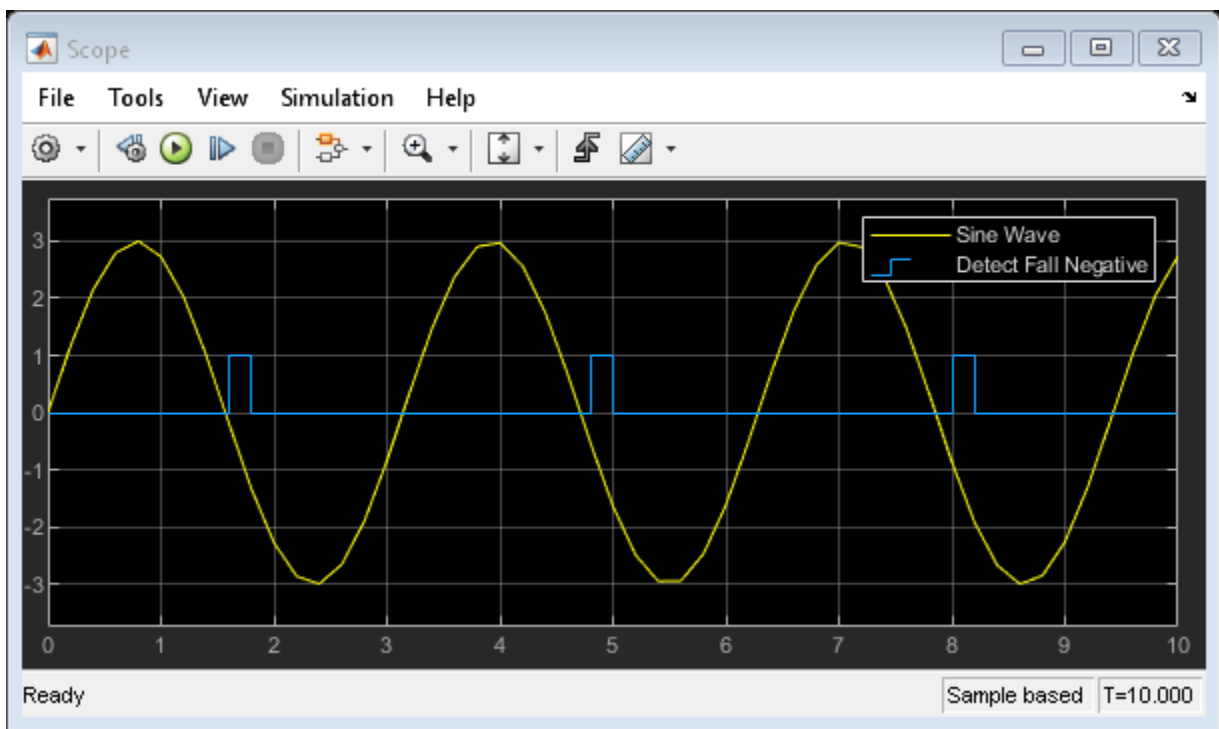
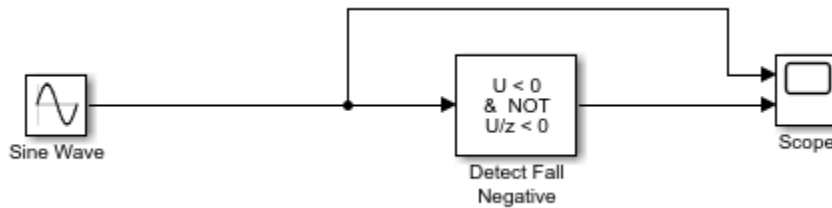

See Also

Detect Fall Negative | Scope | Sine Wave

Detect Decreasing Signal Values

This example shows how to determine if an input signal is strictly less than its previous value using the Detect Decrease block. When the current input to the Detect Decrease block is less than its previous value, the block outputs one (true). When the current input is greater than or equal to the previous signal value, the Detect Decrease block outputs zero (false).

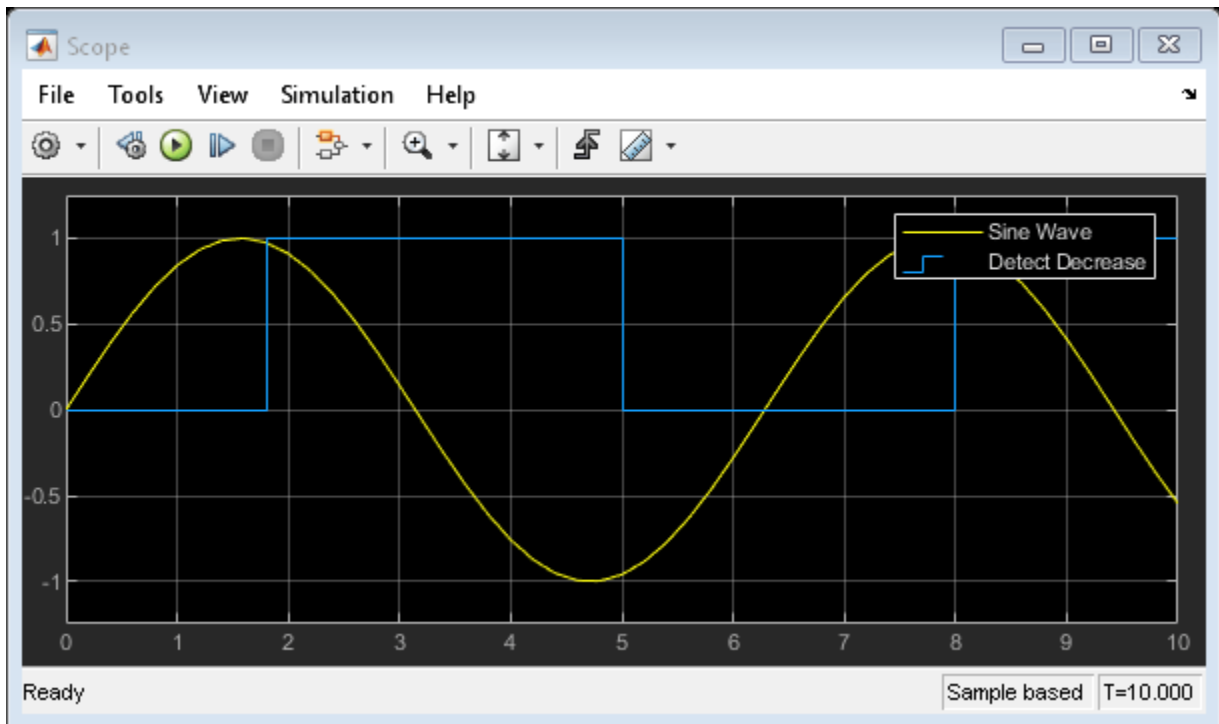
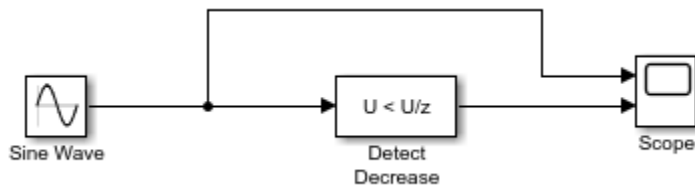

See Also

[Detect Decrease](#) | [Scope](#) | [Sine Wave](#)

Function-Call Blocks Connected to Branches of the Same Function-Call Signal

In this model, a Function-Call Feedback Latch block is on the feedback signal between the branched blocks. As a result, the latch block delays the signal at the input of the destination function-call block, and the destination function-call block executes prior to the source function-call block of the latch block.

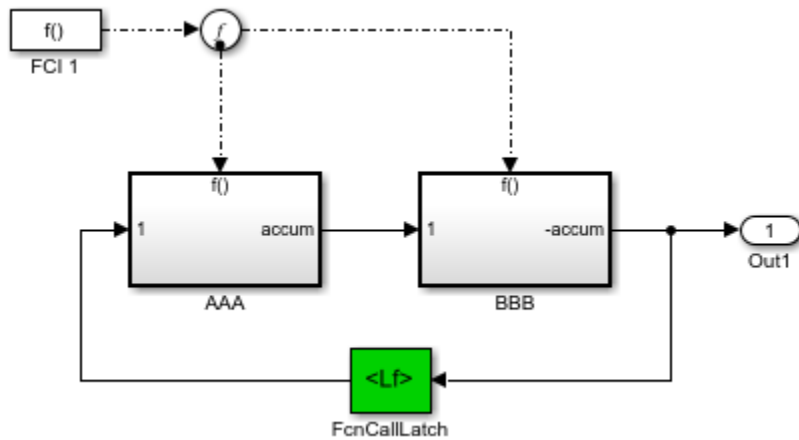

See Also

Function-Call Feedback Latch | Function-Call Generator | Function-Call Subsystem | Function-Call Split

Function-Call Feedback Latch on Feedback Signal Between Child and Parent

In this model, the Function-Call Feedback Latch block is on the feedback signal between the child and the parent. This arrangement prevents the signal value, read by the parent (FCSS1), from changing during execution of the child. In other words, the parent reads the value from the previous execution of the child (FCSS2).

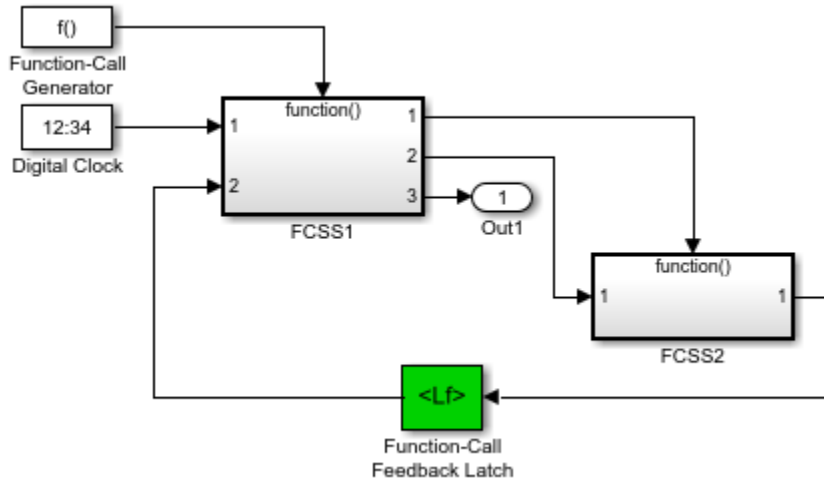

See Also

[Function-Call Feedback Latch](#) | [Function-Call Generator](#) | [Function-Call Subsystem](#) | [Digital Clock](#)

Single Function-Call Subsystem

In this example, a single function-call subsystem output serves as its own input.

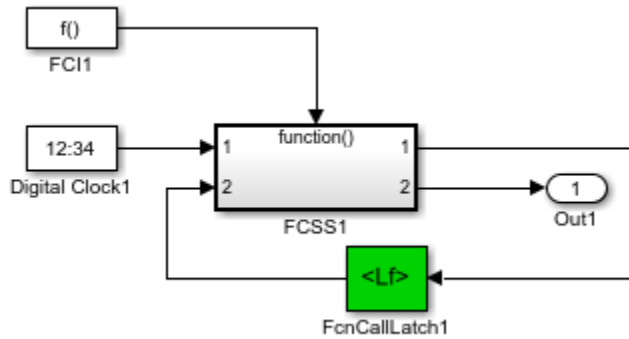

See Also

[Function-Call Feedback Latch](#) | [Function-Call Generator](#) | [Function-Call Subsystem](#) | [Digital Clock](#)

Function-Call Subsystem with Merged Signal As Input

In this model a merged signal serves as the input to a function-call subsystem. Latching is necessary if one of the signals entering the Merge block forms a feedback loop with the function-call subsystem. In this example, one of the output signals from FCSS2 combines with the output of an Enabled Subsystem block and then feeds back into an inport of FCSS2.

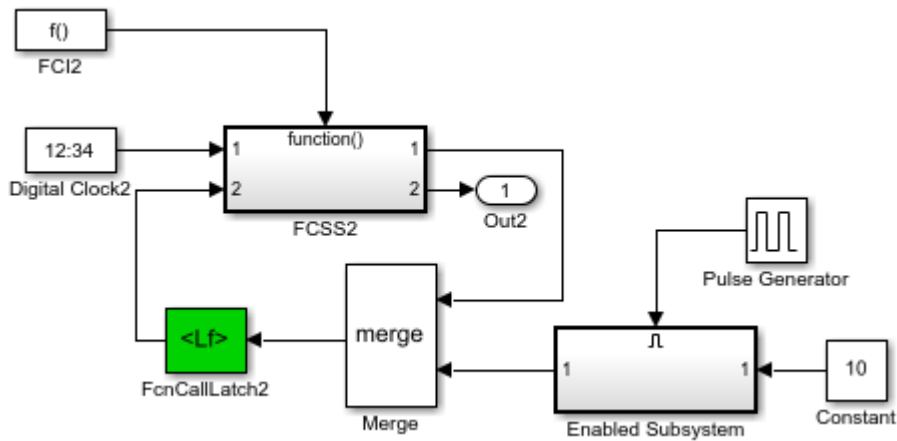

See Also

Function-Call Feedback Latch | Function-Call Generator | Function-Call Subsystem | Merge | Enabled Subsystem | Pulse Generator | Digital Clock

Partitioning an Input Signal with the For Each Block

The following model demonstrates the partitioning of an input signal by a For Each block. Each row of this 2-by-3 input array contains three integers that represent the (x, y, z)-coordinates of a point. The goal is to translate each of these points based on a new origin at (-20, -10, -5) and to display the results.

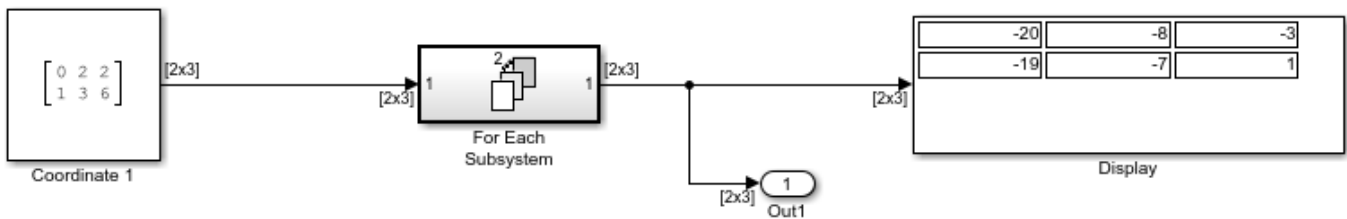

By placing the process of summing an input signal and the new origin inside of a For Each Subsystem block, you can operate on each set of coordinates by partitioning the input signal into two row vectors. To accomplish such partitioning, use the default settings of 1 for both the partition dimension and the partition width. If you also use the default concatenation dimension of 1, each new set of coordinates stacks in the d1 direction, making your display a 2-by-3 array.

See Also

For Each | For Each Subsystem

Specifying the Concatenation Dimension in the For Each Block

This example shows how to specify a concatenation dimension in the For Each block. When you specify a **Concatenation Dimension** of 2 on the **Output Concatenation** tab, each set of results stacks in the d2 direction, and the result is a single row vector.

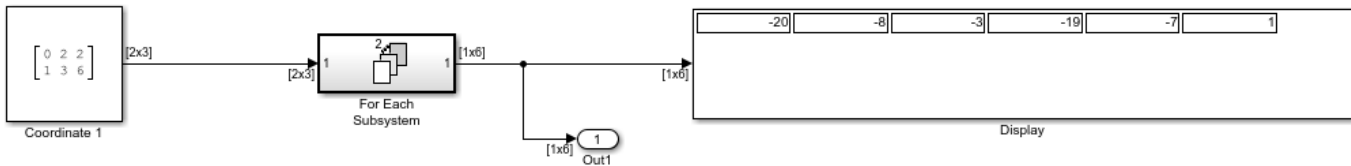

To learn how the For Each block and subsystem handle a model with states, see the For Each Subsystem block reference page.

See Also

For Each | For Each Subsystem

Working with the Initialize Function, Reset Function, and Terminate Function Blocks

This example shows how to use the Initialize Function, Reset Function, and Terminate Function blocks to read and write states in a Simulink model. For more information on configuring the block settings, see “Using Initialize, Reset, and Terminate Functions”.

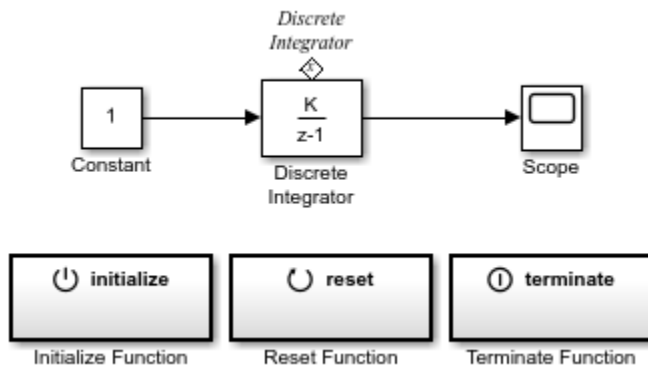

See Also

[Initialize Function](#) | [Reset Function](#) | [Terminate Function](#) | [Event Listener](#) | [State Writer](#) | [State Reader](#) | [Discrete-Time Integrator](#)

Related Examples

- “Using Initialize, Reset, and Terminate Functions”

Reading and Writing States with the Initialize Function and Terminate Function Blocks

In this example, the Initialize Function block uses the State Writer block to set the initial condition of a Discrete Integrator block to 10. The Terminate Function block includes a State Reader block, which reads the state of the Discrete Integrator block. The **Event type** parameter of the Event Listener block for the initialize and terminate functions is set to `Initialize` and `Terminate`, respectively.

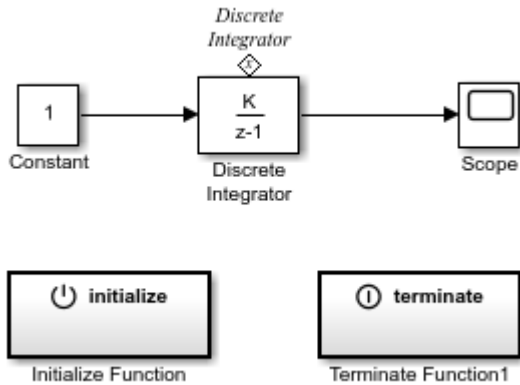

See Also

[Initialize Function](#) | [Terminate Function](#) | [Event Listener](#) | [State Writer](#) | [State Reader](#) | [Discrete-Time Integrator](#)

Related Examples

- "Using Initialize, Reset, and Terminate Functions"

PWM Control of a Boost Converter

This example shows you how to control a boost converter using the PWM block in Simulink. The boost converter is implemented using the Boost Converter (Simscape Electrical) block in the Simscape™ Electrical™ library.

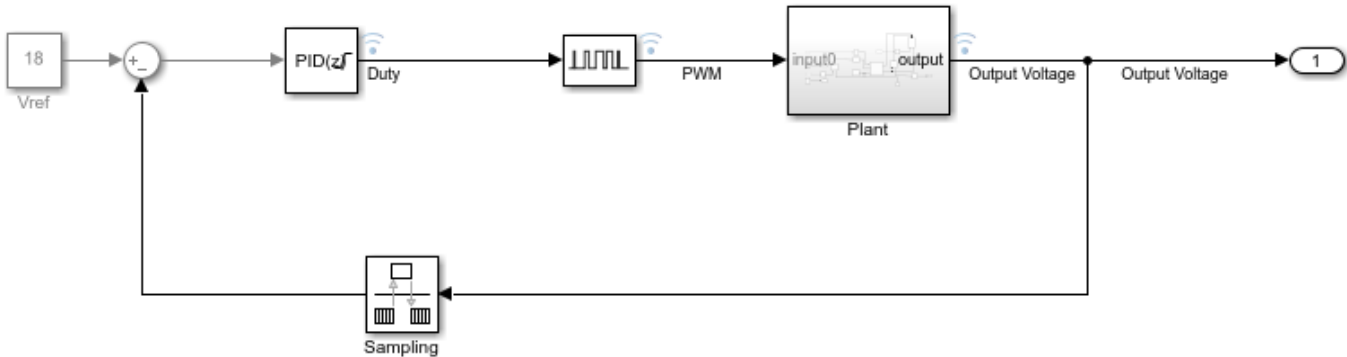

A PWM signal is used to control the switching device, or gate, of the boost converter. The command signal, or duty cycle, is generated from the PID controller to track the desired step-up voltage (V_{ref}) of 18V

This is a relatively high frequency application; the switching gate operates at around 200kHz. Therefore, a pulse period of $1/200,000$ or $5e-6s$ is chosen for the PWM signal.

Given the small time steps, the `boostconverter_pwm` model provided with the example is loaded from a steady state at 0.069s.

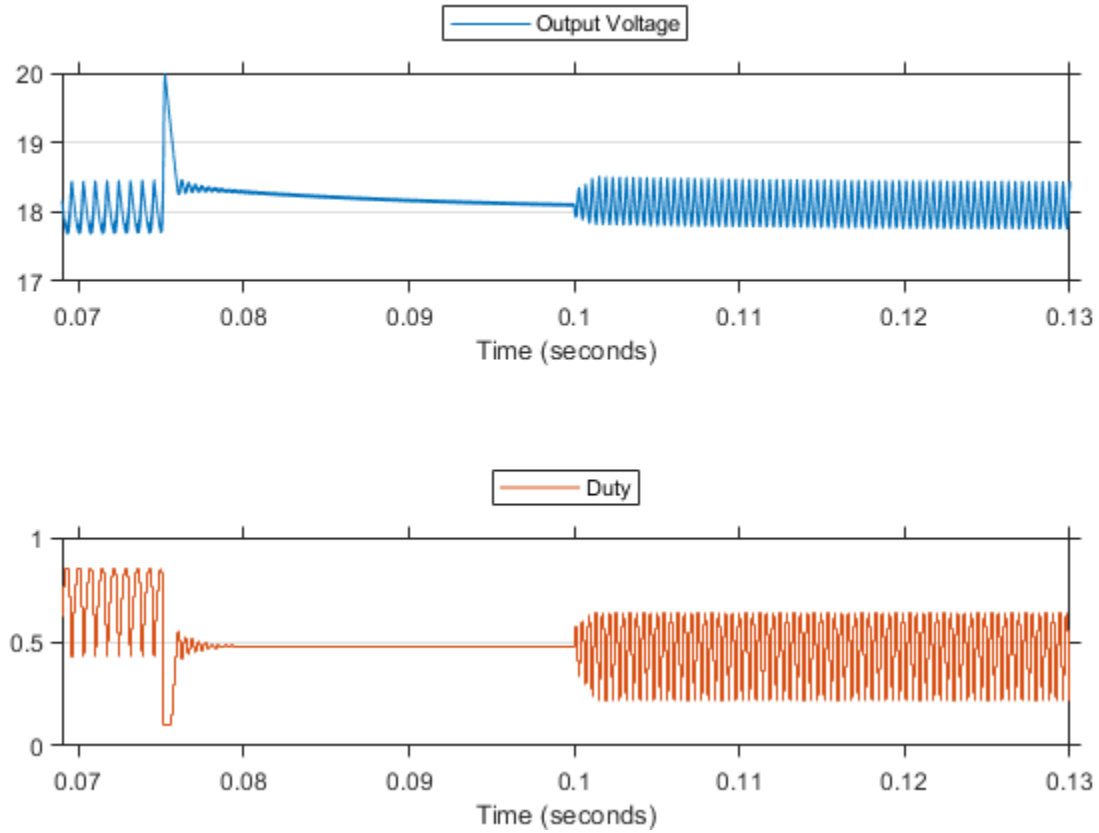

A visualization of the boost converter operation around the 0.1s mark is shown below.

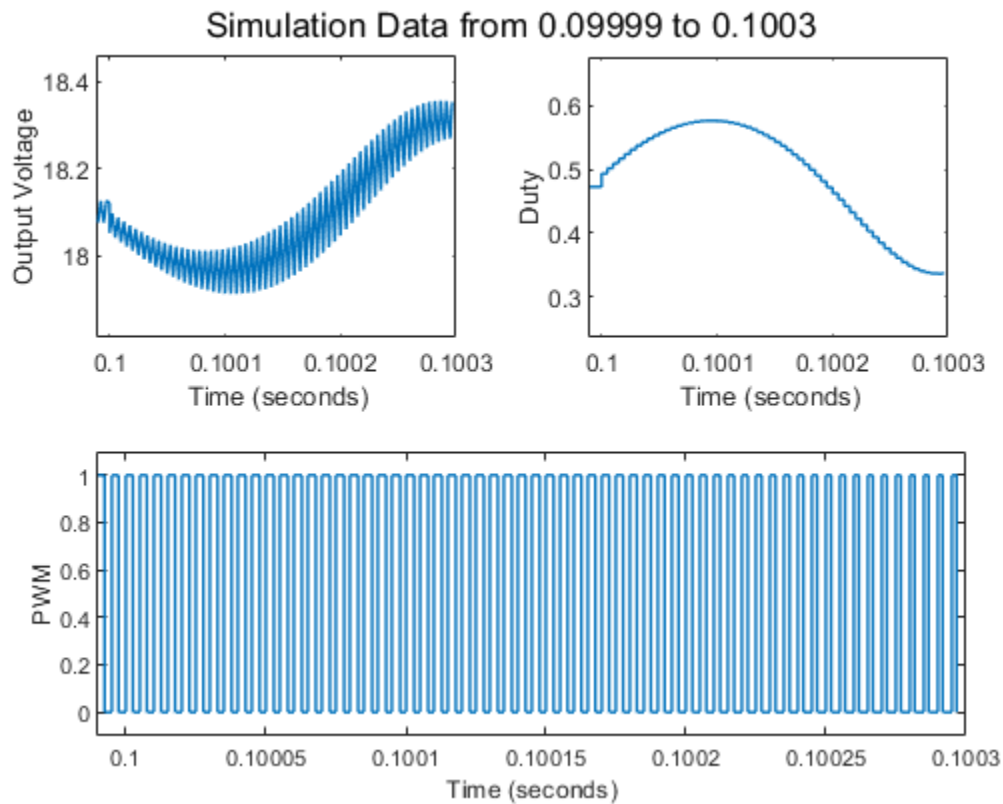

For alternate physical modeling implementations of PWM control, see “Pulse Width Modulation” (Simscape Electrical).

See Also

PWM | Variable Pulse Generator

Related Examples

- “Voltage Controlled Oscillator” on page 12-169

More About

- “Pulse Width Modulation” (Simscape Electrical)

Voltage Controlled Oscillator

This example shows you how to model an ideal voltage controlled oscillator using the Variable Pulse Generator block to create the frequency oscillations.

A voltage controlled oscillator uses an input tuning voltage to produce waveforms of varying frequency. Over a small range of voltages, the relationship between the input voltage (V_{in}) and the output oscillation frequency (F) is proportional and can be expressed as

$$F(t) = K_c \cdot V_{in}(t) + F_0(1)$$

where

- K_c is the oscillator sensitivity in Hz/V
- f_0 is the quiescent frequency, or nominal frequency of the oscillator at $V_{in} = 0$

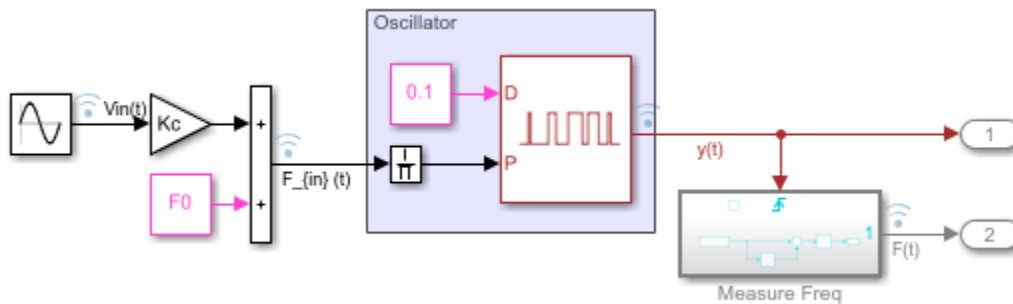

In the included `vco_using_vpg` model, the desired oscillation frequency signal $F_{in}(t)$ is generated using the formula shown in equation (1). In this model, the tuning voltage V_{in} is a sinusoidal waveform.

Nominal Frequency $f_0 = 42$ Hz

Oscillator Gain $K_c = 3$

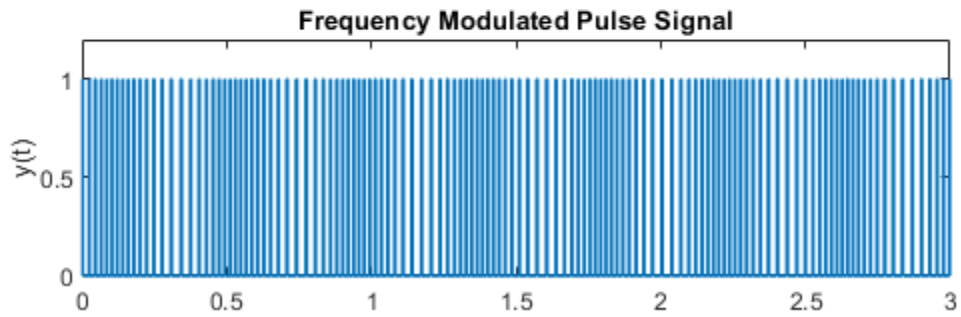
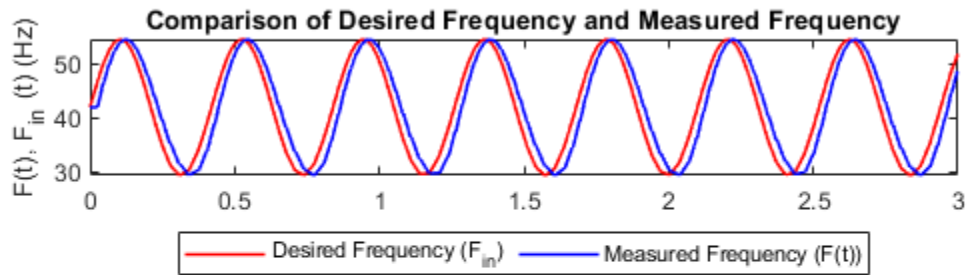

See Also

PWM | Variable Pulse Generator

More About

- “Pulse Width Modulation” (Simscape Electrical)
- “PWM Control of a Boost Converter” on page 12-166

Check Signal Lower Bound with Check Dynamic Lower Bound Block

Using the Check Dynamic Lower Bound block, you can check if an input signal falls below a changing lower bound during a simulation.

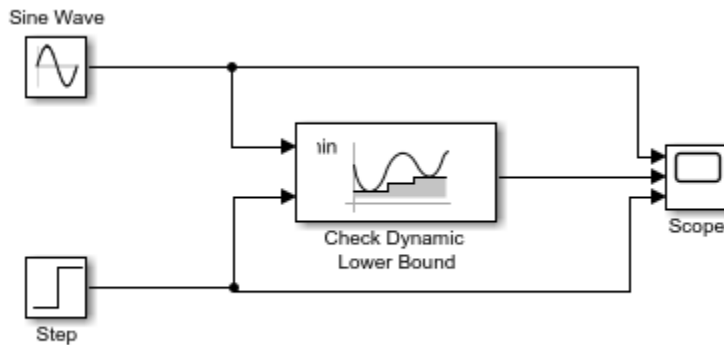

Copyright 2018 The MathWorks, Inc.

In this example, the Check Dynamic Lower Bound block compares the value of a tested input signal from a Step block at the **u** port to a Sine Wave block at the **min** port. The Check Dynamic Lower Bound block checks if the value of the signal at the **min** port is less than the value of the tested input signal. If it is, the block asserts `true` (1). Because the **Output assertion signal** parameter of the Check Dynamic Lower Bound block is selected, the block outputs the assertion value. Run the simulation to observe the model output.

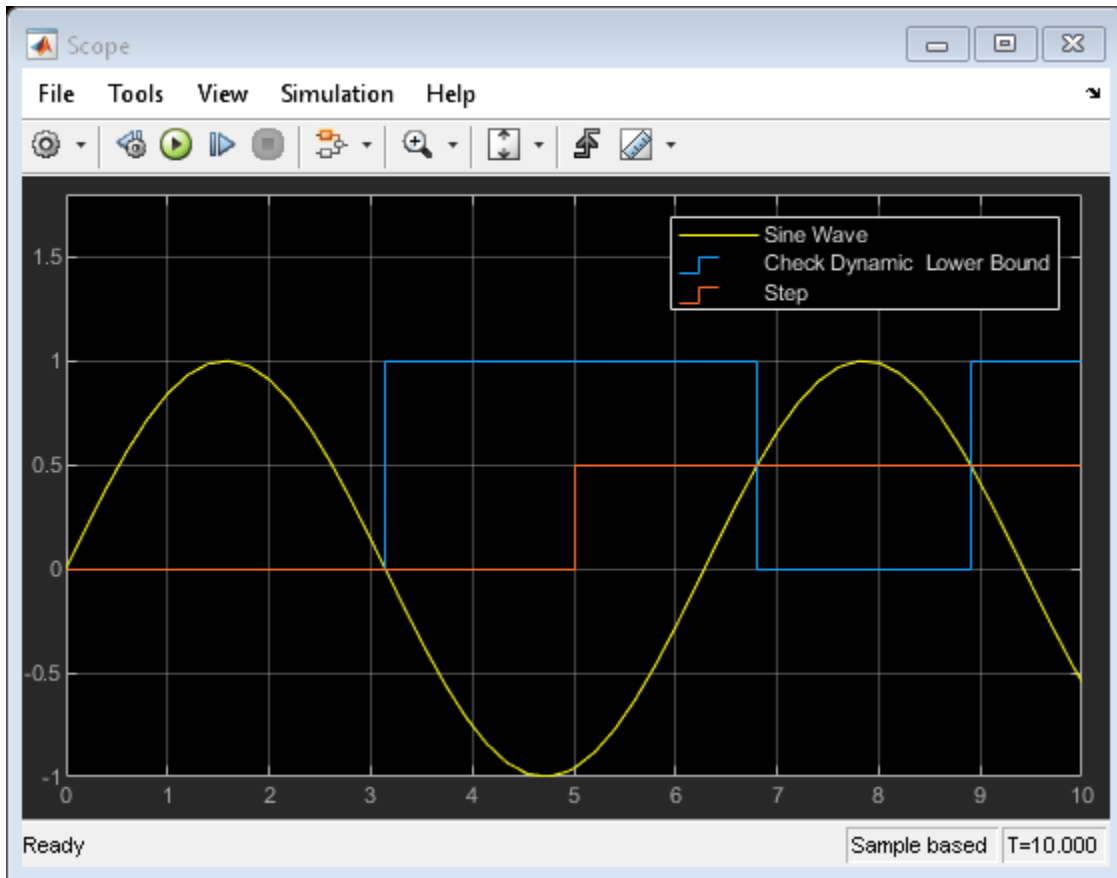

At the start of the simulation, the Check Dynamic Lower Bound block outputs 0 because the value of the Sine Wave block is greater than the value of the Step block. At a time of 3.14, the sine wave dips below 0, causing the value of the Step block to exceed the sine wave. The Check Dynamic Lower Bound block recognizes this change and outputs 1.

At a time of 5, the Step block outputs a value of 0.5, which is still greater than the sine wave. The Step block value stays greater than the sine wave until the time reaches 6.81. The Check Dynamic Lower Bound block recognizes this change and the assertion fails. The assertion stays at 0 until the time reaches 8.90, where the sine wave goes below the value of the Step block.

See Also

Assertion | Check Dynamic Lower Bound

Check Signal Upper Bound with Check Dynamic Upper Bound Block

Using the Check Dynamic Upper Bound block, you can check if an input signal rises above a changing upper bound during a simulation.

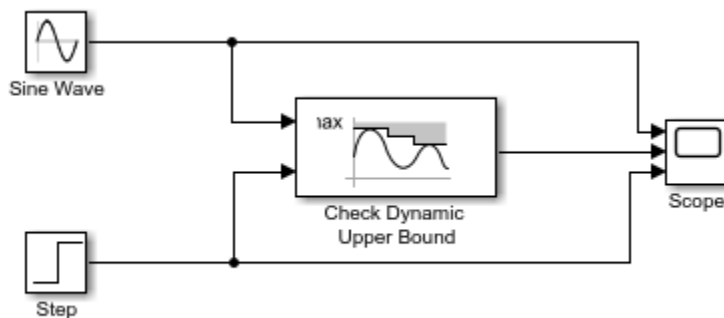

Copyright 2018 The MathWorks, Inc.

In this example, the Check Dynamic Upper Bound block compares the value of a tested input signal from a Step block at the **u** port to a Sine Wave block at the **max** port. The Check Dynamic Upper Bound block checks if the value of the signal at the **max** port is greater than the value of the tested input signal. If it is, the block asserts `true` (1). Because the **Output assertion signal** parameter of the Check Dynamic Upper Bound block is selected, the block outputs the assertion value. Run the simulation to observe the model output.

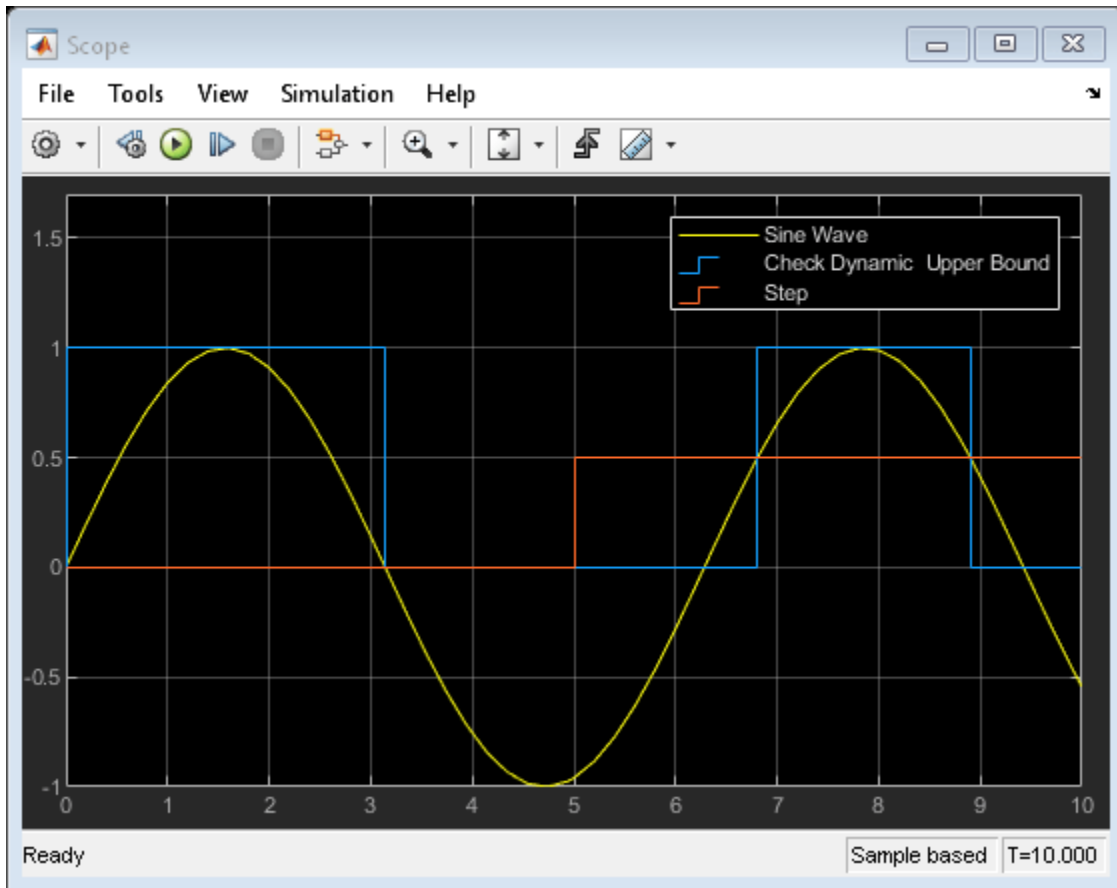

At the start of the simulation, the Check Dynamic Upper Bound block outputs 1 because the value of the Sine Wave block is greater than the value of the Step block. At a time of 3.14, the sine wave dips below 0, causing the value of the Step block to exceed the sine wave. The Check Dynamic Upper Bound block recognizes this change and outputs 0.

At a time of 5, the Step block outputs a value of 0.5, which is still greater than the sine wave. The Step block value stays greater than the sine wave until the time reaches 6.81. The Check Dynamic Upper Bound block recognizes this change and the assertion passes. The output stays at 1 until the time reaches 8.90, where the sine wave goes below the value of the Step block.

See Also

Assertion | Check Dynamic Upper Bound

Check Signal Lower Bound with Check Static Lower Bound Block

Using the Check Static Lower Bound block, you can check if an input signal falls below a defined value.

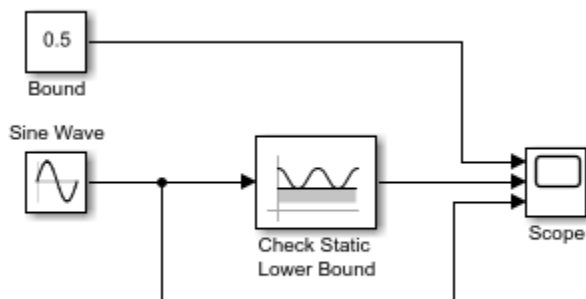

Copyright 2018 The MathWorks, Inc.

In this example, the Check Static Lower Bound block compares the value of a Sine Wave block to the value entered in the **Lower bound** parameter, which is 0.5. The Constant block, labeled Bound, illustrates this parameter in the Scope block but does not affect the parameter value. The Check Static Lower Bound block checks if the value of the input signal is greater than the **Lower bound**. If it is, the block asserts `true` (1). Because the **Output assertion signal** parameter of the block is selected, the block outputs the assertion value. Run the simulation to observe the model output.

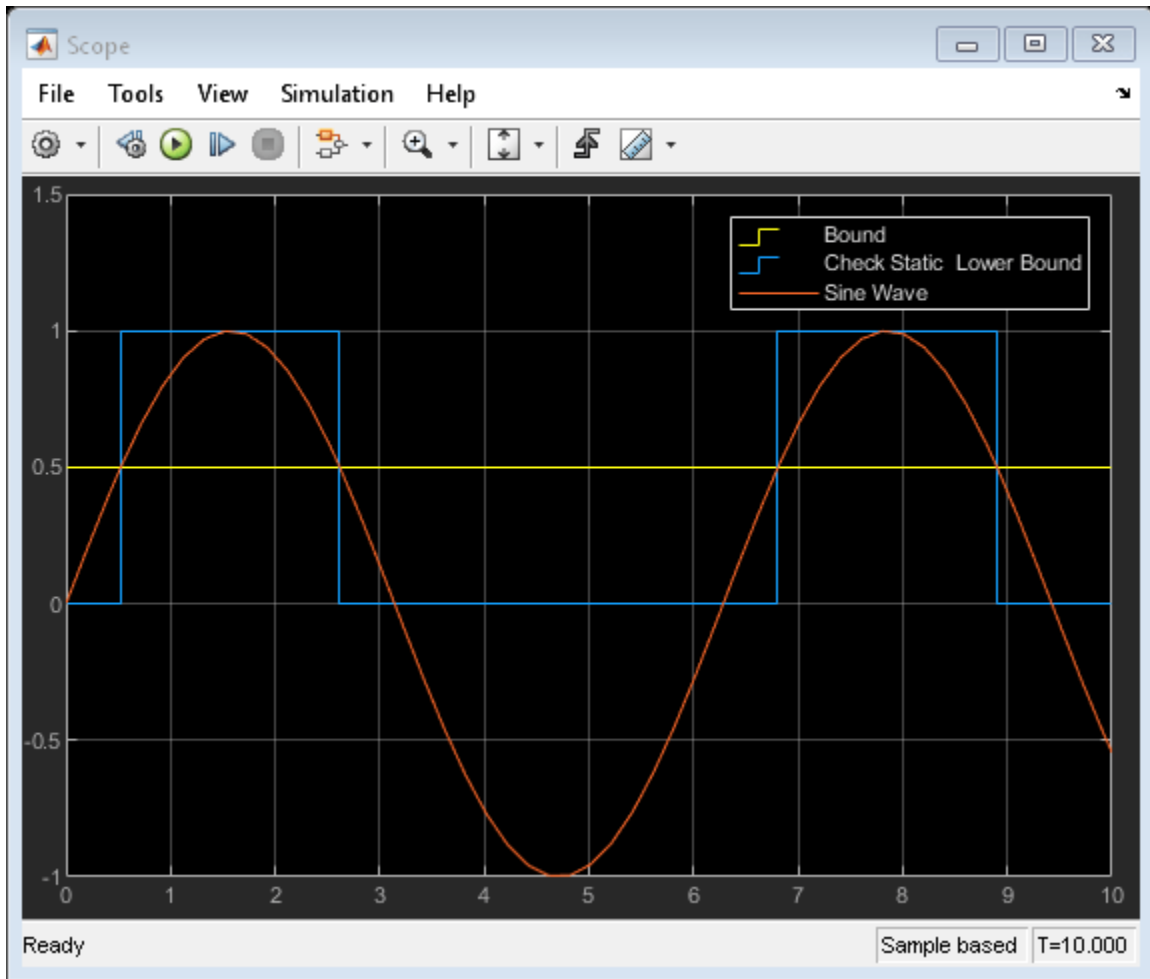

At the start of the simulation, the Check Static Lower Bound block outputs 0 because the value of the Sine Wave block is less than the bound. At a time of 0.52, the sine wave exceeds 0.5. The Check Static Lower Bound block recognizes this change and outputs 1. When the time reaches 2.62, the sine wave falls below the bound and the assertion is false. This pattern repeats until the simulation end time.

See Also

Assertion | Check Static Lower Bound

Check Signal Range with Check Static Range Block

Using the Check Static Range block, you can check if an input signal falls outside of an unchanging range of values.

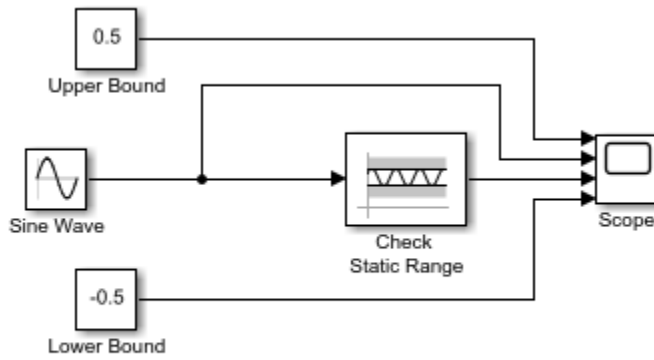

Copyright 2018 The MathWorks, Inc.

In this example, the Check Static Range block compares the value of a Sine Wave block to the values entered in the **Upper bound** and **Lower bound** parameters, which are 0.5 and -0.5. The Constant blocks, labeled Upper Bound and Lower Bound, illustrate these parameters in the Scope block but do not affect the parameter values. The Check Static Range block checks if the value of the input signal is greater than the **Lower bound** value or less than the **Upper bound** value. If it is, the block asserts `true (1)`. Because the **Output assertion signal** parameter of the block is selected, the block outputs the assertion value. Run the simulation to observe the model output.

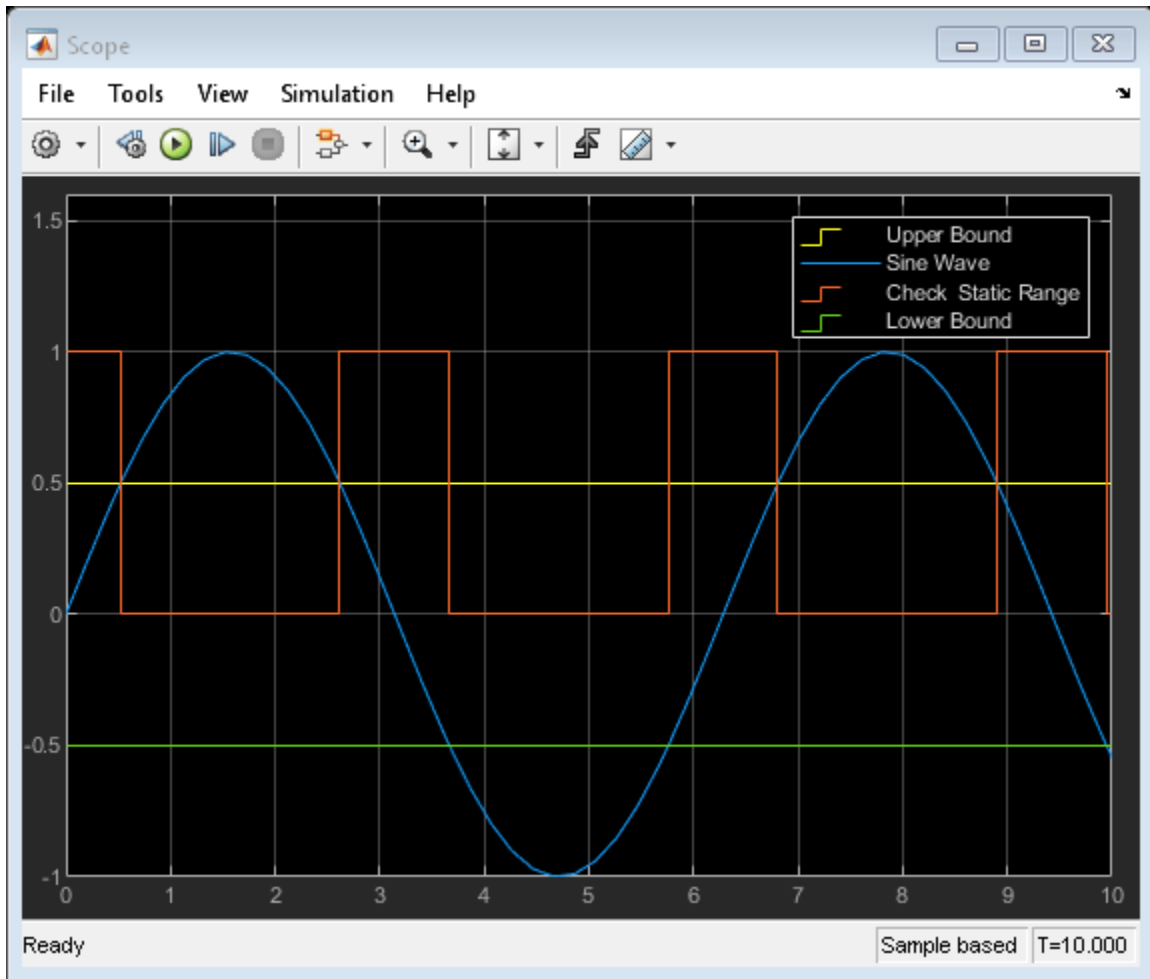

At the start of the simulation, the Check Static Range block outputs 1 because the value of the Sine Wave block is less than the **Upper bound** value. At a time of 0.52, the sine wave exceeds 0.5. The Check Static Range block recognizes this change and outputs 0. When the time reaches 2.62, the sine wave falls below the **Upper bound** value and the assertion is true. When the time reaches 3.67, the sine wave falls below the **Lower bound** value. The Check Static Range block recognizes this change and outputs 0. The output stays at 0 until the time is 5.76, when the sine wave then exceeds the **Lower bound** value. This pattern repeats until the simulation end time.

See Also

Assertion | Check Static Range

Check Signal Upper Bound with Check Static Upper Bound Block

Using the Check Static Upper Bound block, you can check if an input signal exceeds a defined value.

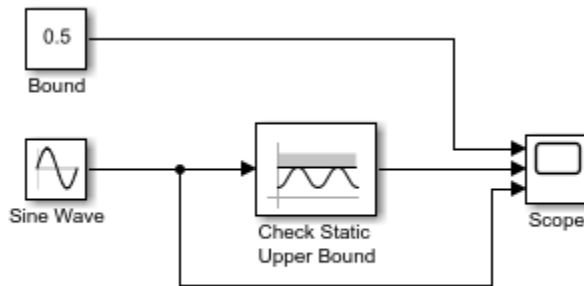

Copyright 2018 The MathWorks, Inc.

In this example, the Check Static Upper Bound block compares the value of a Sine Wave block to the value entered in the **Upper bound** parameter, which is 0.5. The Constant block, labeled Bound, illustrates this parameter in the Scope block but does not affect the parameter value. The Check Static Upper Bound block checks if the value of the input signal is less than the **Upper bound**. If it is, the block asserts `true (1)`. Because the **Output assertion signal** parameter of the block is selected, the block outputs the assertion value. Run the simulation to observe the model output.

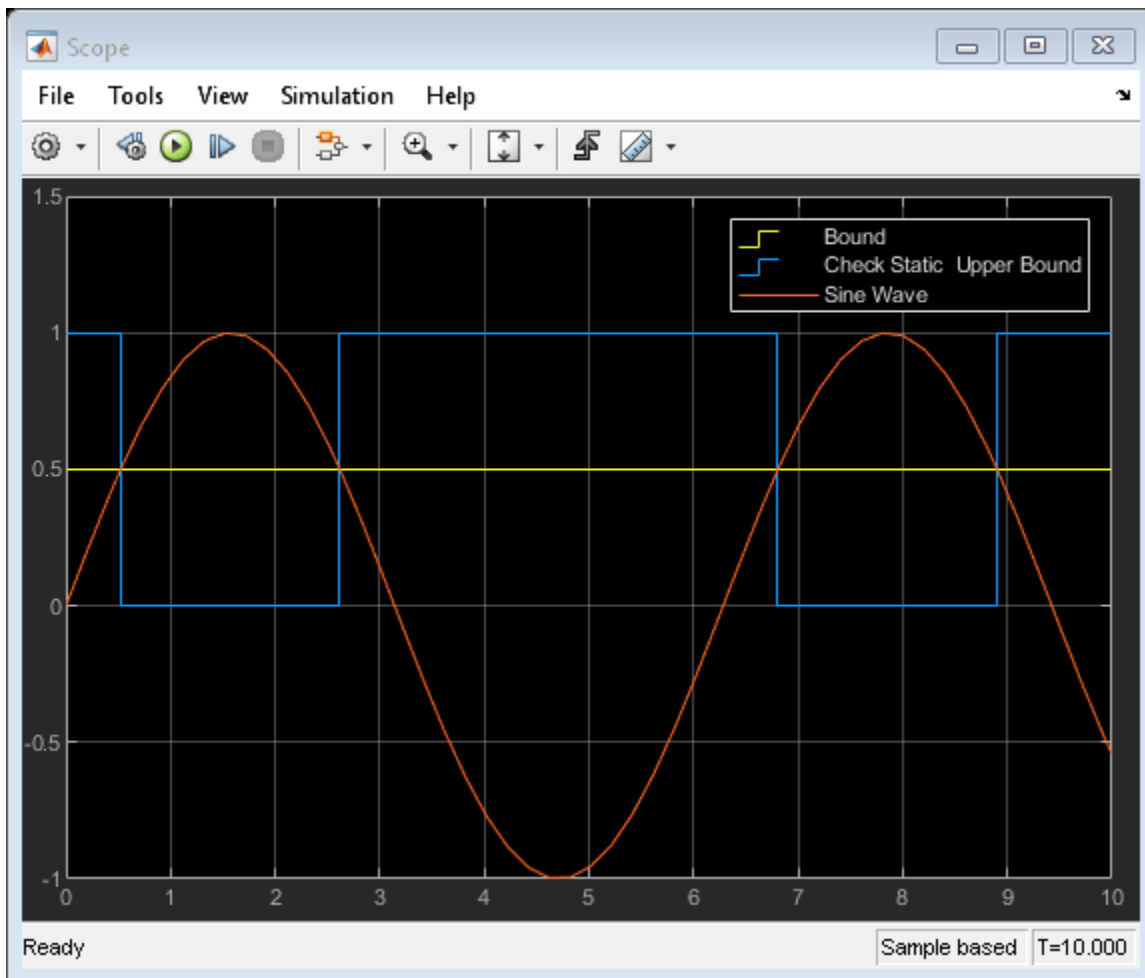

At the start of the simulation, the Check Static Upper Bound block outputs 1 because the value of the Sine Wave block is less than the bound. At a time of 0.52, the sine wave exceeds 0.5. The Check Static Upper Bound block recognizes this change and outputs 0. When the time reaches 2.62, the sine wave falls below the bound and the assertion is true. This pattern repeats until the simulation end time.

See Also

Assertion | Check Static Upper Bound

Check Signal Slope with Check Discrete Gradient Block

Using the Check Discrete Gradient block, you can check if the absolute value of the difference between successive samples of a signal is less than a defined value.

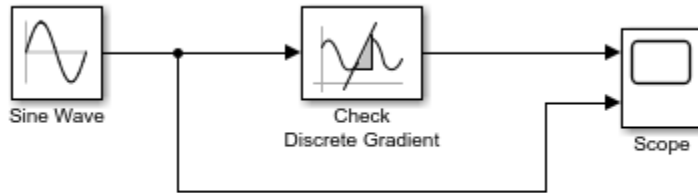

Copyright 2018, The MathWorks, Inc.

In this example, the Check Discrete Gradient block compares the value of an input signal from a Sine Wave block to the **Maximum gradient** parameter value, which is 0.1 . If the absolute value of the difference between successive samples of the signal is less than 0.1 , the block asserts `true (1)`. Because the **Output assertion signal** parameter of the block is selected, the block outputs the assertion value. The block requires a fixed-step discrete solver, which has been selected in the model. Run the simulation to observe the model output.

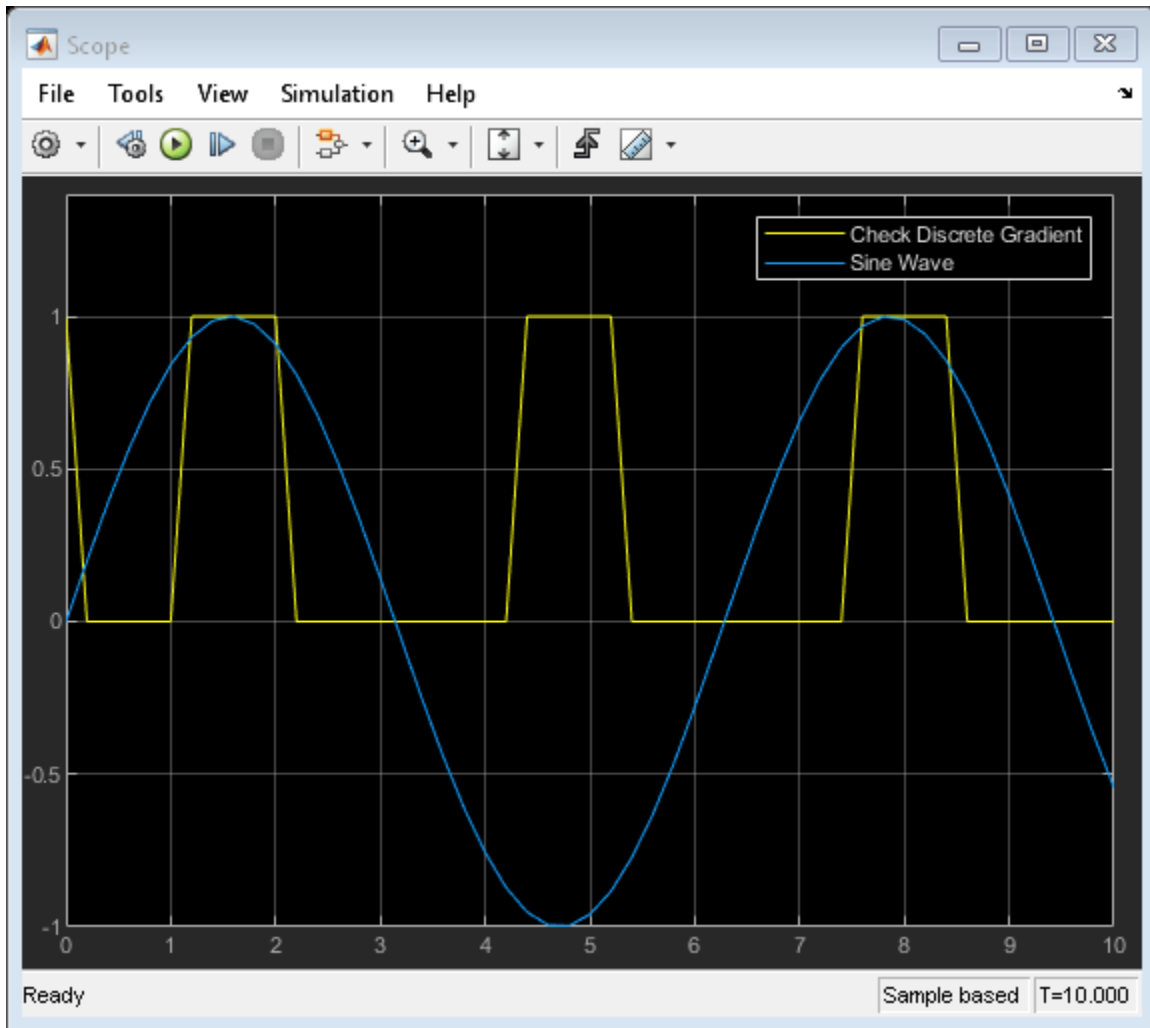

The block asserts `true` when the sine wave is near a maximum or minimum. In these sections of the signal, the absolute value of the gradient is less than the **Maximum gradient** value `0.1`. This pattern repeats until the simulation end time.

See Also

Assertion | Check Discrete Gradient

Check Signal Value with Check Dynamic Gap Block

You can check if an input signal falls inside of a dynamic upper and lower bound by using the Check Dynamic Gap block.

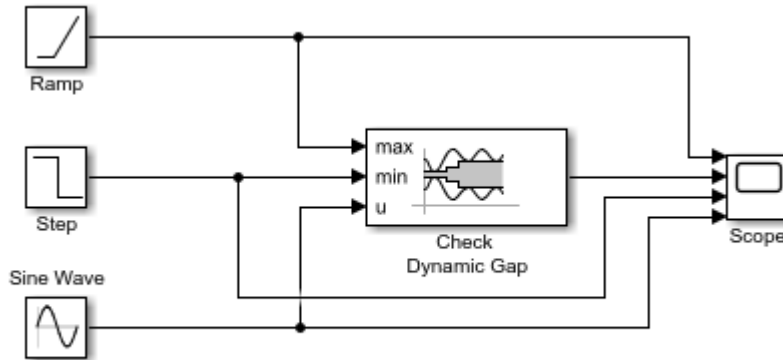

Copyright 2018, The MathWorks, Inc.

In this example, the Check Dynamic Gap block compares the value of a tested input signal from a Sine Wave block at the **u** port to a Ramp block at the **max** port and a Step block and the **min** port. The Check Dynamic Gap block checks if the value of the signal at the **max** port is less than the value of the test signal, and if the value of the signal at the **min** port is greater than the value of the test signal. If it is, the block asserts `true` (1). Because the **Output assertion signal** parameter of the Check Dynamic Gap block is selected, the block outputs the assertion value. Run the simulation to observe the model output.

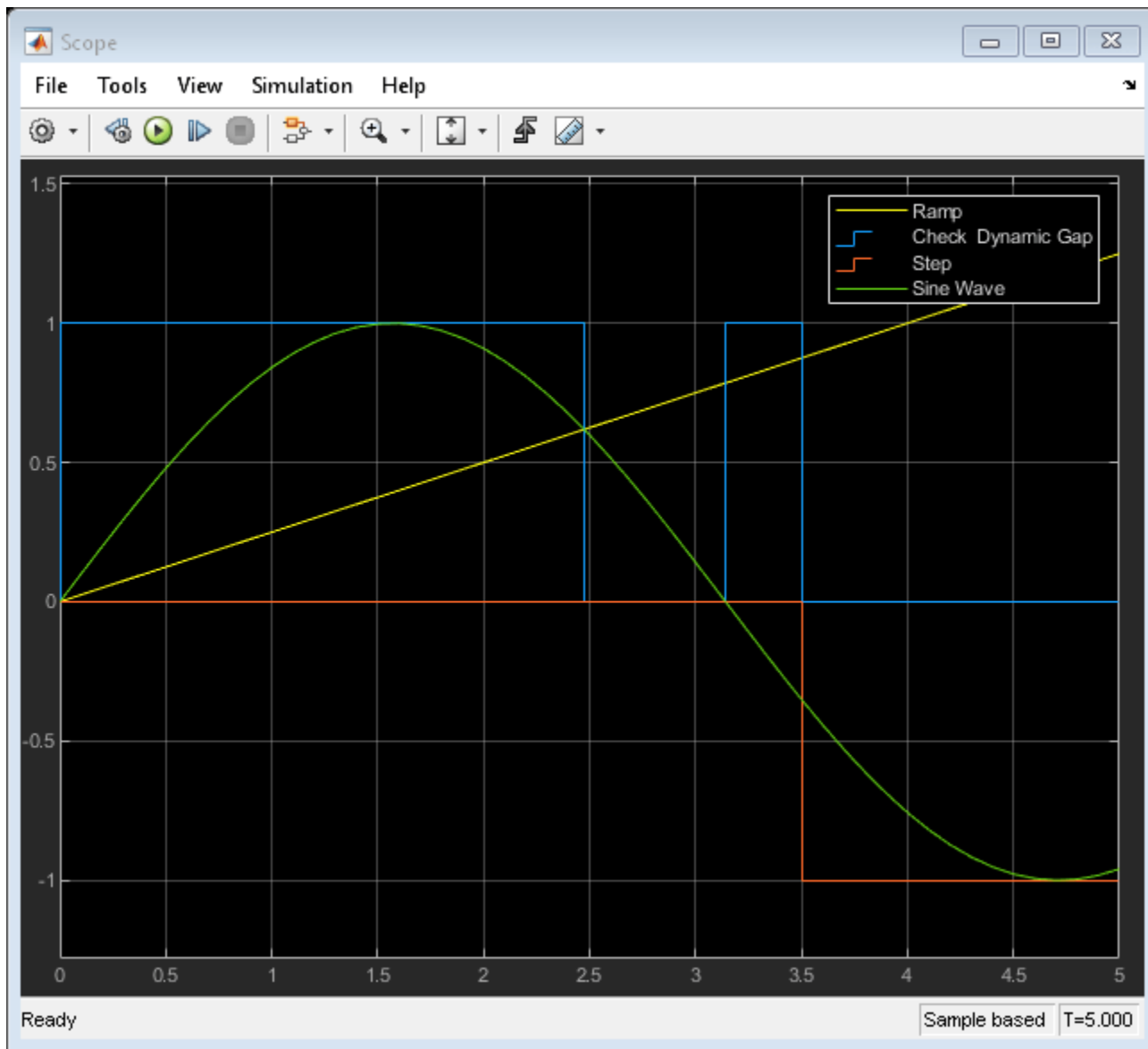

At the start of the simulation, the Check Dynamic Gap block output is 1. The output stays at 1 until the simulation time is 2.47, when the sine wave falls below the value of the Ramp block. The block output stays at 0 until the simulation time reaches 3.14, when the sine wave falls below the value of the Step block. The Step block activates when the simulation time reaches 3.5, placing the sine wave between the bounds. The Check Dynamic Gap block recognizes this change and sets the output to 0.

See Also

Assertion | Check Dynamic Gap

Check Signal Value with Check Static Gap Block

Using the Check Static Gap block, you can check if an input signal enters an unchanging gap of values.

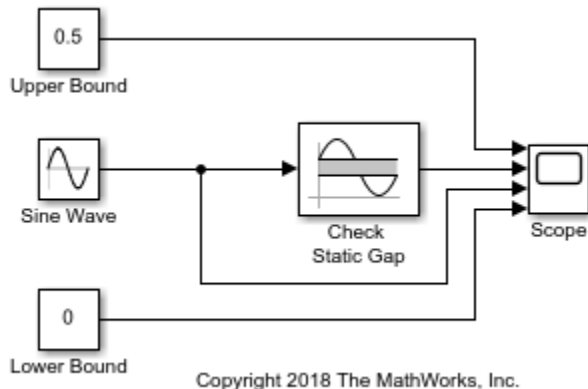

In this example, the Check Static Gap block compares the value of a Sine Wave block to the values entered in the **Upper bound** and **Lower bound** parameters, which are 0.5 and 0. The Constant blocks, labeled Upper Bound and Lower Bound, illustrate these parameters in the Scope block but do not affect the parameter values. The Check Static Gap block checks if the value of the input signal is less than the **Lower bound** value or greater than the **Upper bound** value. If it is, the block asserts `true (1)`. Because the **Output assertion signal** parameter of the block is selected, the block outputs the assertion value. Run the simulation to observe the model output.

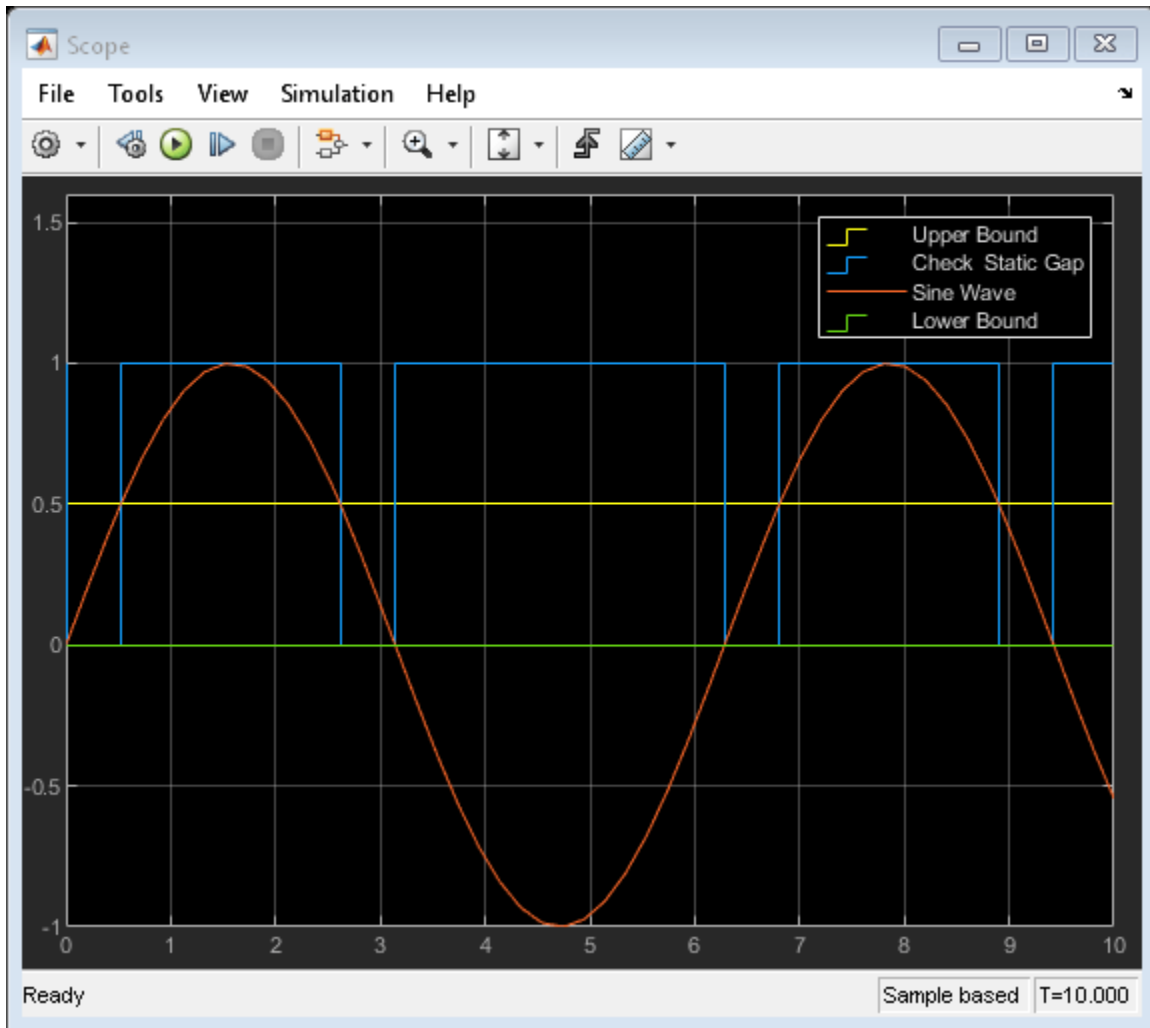

At the start of the simulation, the Check Static Gap block outputs 0 because the value of the Sine Wave block is less than the **Upper bound** value. At a time of 0.52, the sine wave exceeds 0.5. The Check Static Gap block recognizes this change and outputs 1. When the time reaches 2.62, the sine wave falls below the **Upper bound** value and the assertion is false. When the time reaches 3.14, the sine wave falls below the **Lower bound** value. The Check Static Gap block recognizes this change and outputs 1. The output stays at 1 until the time is 6.28, when the sine wave then exceeds the **Lower bound** value. This pattern repeats until the simulation end time.

See Also

Assertion | Check Static Gap

Check Signal Range with Check Dynamic Range Block

You can check if an input signal falls outside of a dynamic upper and lower bound by using the Check Dynamic Range block.

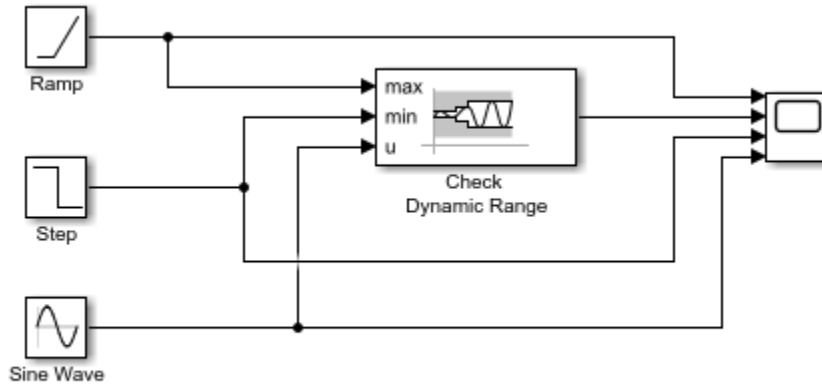

Copyright 2020 The MathWorks, Inc.

This model uses a Sine Wave block as a dynamic test signal. The Check Dynamic Range block determines if the value of the sine wave exceeds the signal from the Ramp block or falls below the signal from the Step block at each time step. In the Check Dynamic Range block, the **Output assertion signal** parameter is selected, so the output signal indicates if the assertion condition is true (1) or false (0). Press **Run** to observe the model output.

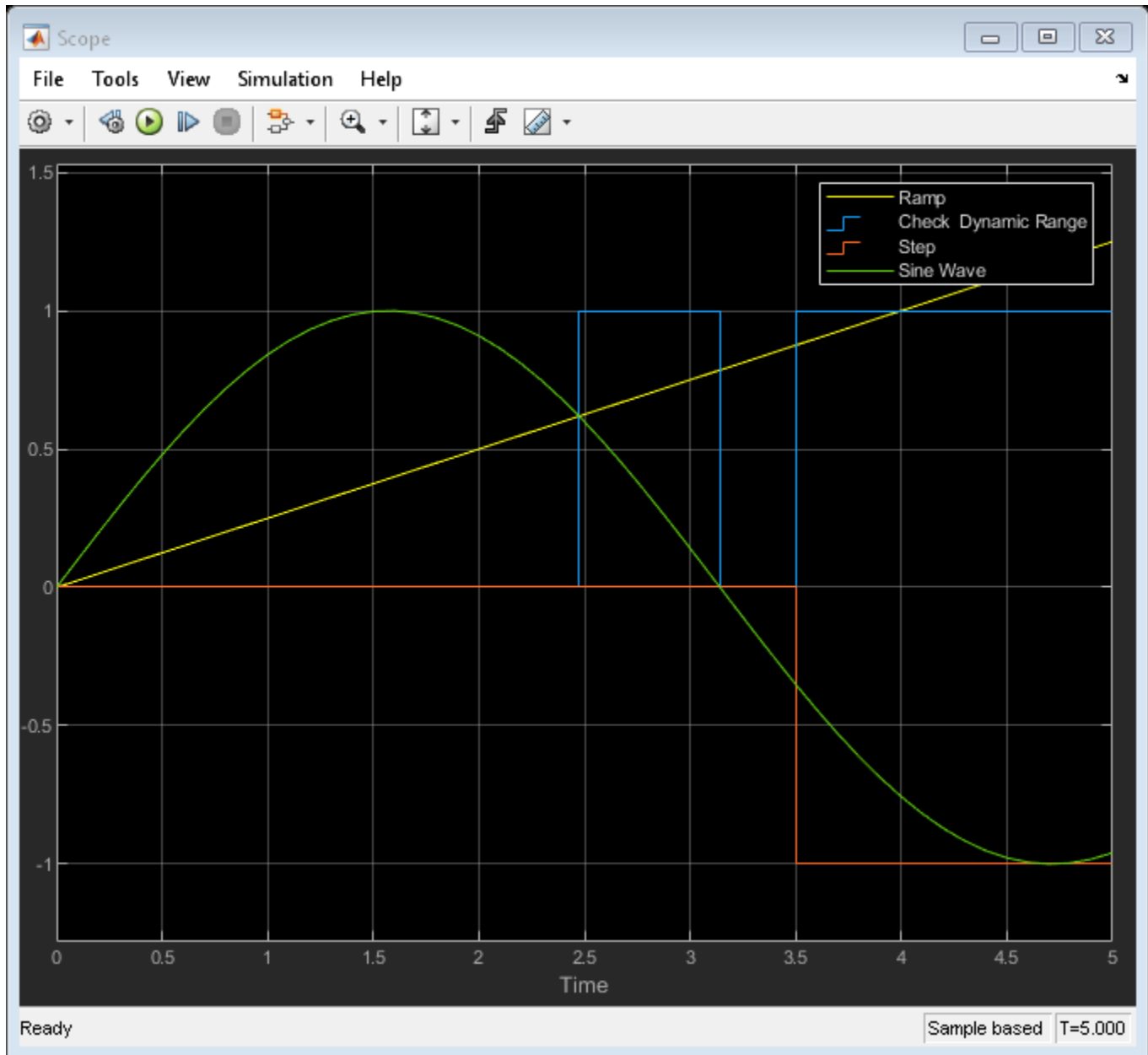

In the Scope block, you can see that the Check Dynamic Range block outputs 0 until the sine wave falls below the value of the Ramp block when the simulation time is 2.47. The block output stays at 1 until the simulation time reaches 3.14, when the sine wave falls below the value of the Step block. The Step block activates when the simulation time reaches 3.5, placing the sine wave between the bounds. The Check Dynamic Range block recognizes this change and outputs 1.

See Also

Assertion | Check Dynamic Range

Check Signal Resolution with Check Input Resolution Block

You can use a Check Input Resolution block to check when a signal has a specified resolution. The block can help verify if a signal is quantized within specification, such as when checking the output of an analog-to-digital converter.

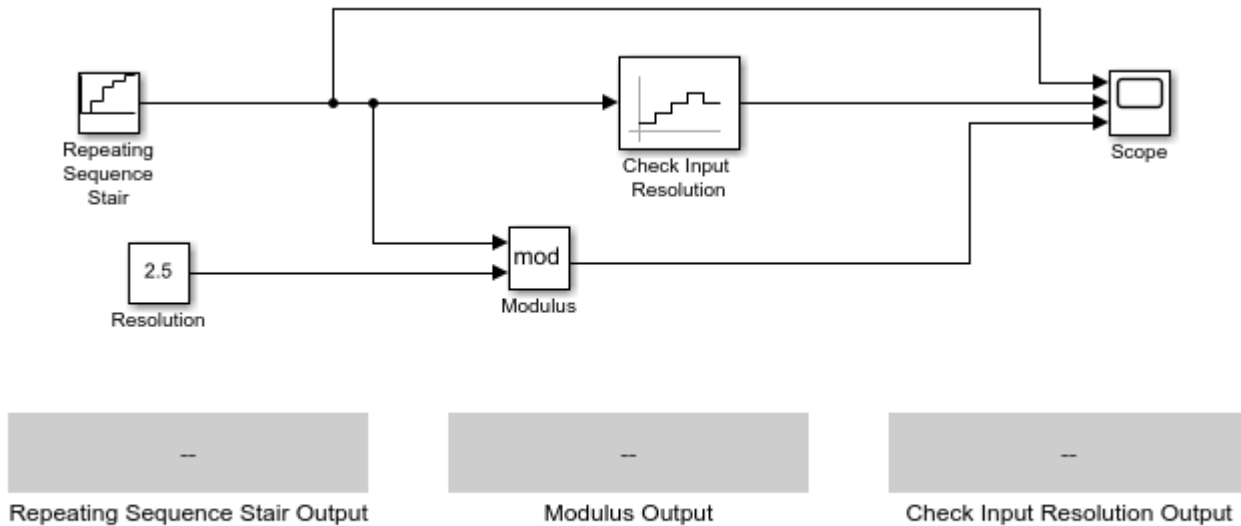

Copyright 2020 The MathWorks, Inc.

In this example, a Repeating Sequence Stair block outputs the values [0 1 2 2.5 3] in sequence starting at 0. During simulation, the block outputs each value in the vector for a time of 1.

First, the Check Input Resolution block calculates a modulus by calculating the remainder of the input value over the value of the **Resolution** parameter, which is set to 2.5. To illustrate this calculation, this example also uses a Math Function block, labeled Modulus, with the **Function** parameter set to `mod`. The Modulus block takes the value of the Repeating Sequence Stair block over the value of a Constant block, labeled Resolution, which has the same value as the **Resolution** parameter.

Then the Check Input Resolution block checks if the modulus is smaller than a tolerance of 0.01. If it is, the block asserts `true` (1). Because the **Output assertion signal** parameter of the Check Input Resolution Block is selected, the block outputs the assertion value. Run the simulation to observe the model output, or use the **Step Forward** button to step through each step.

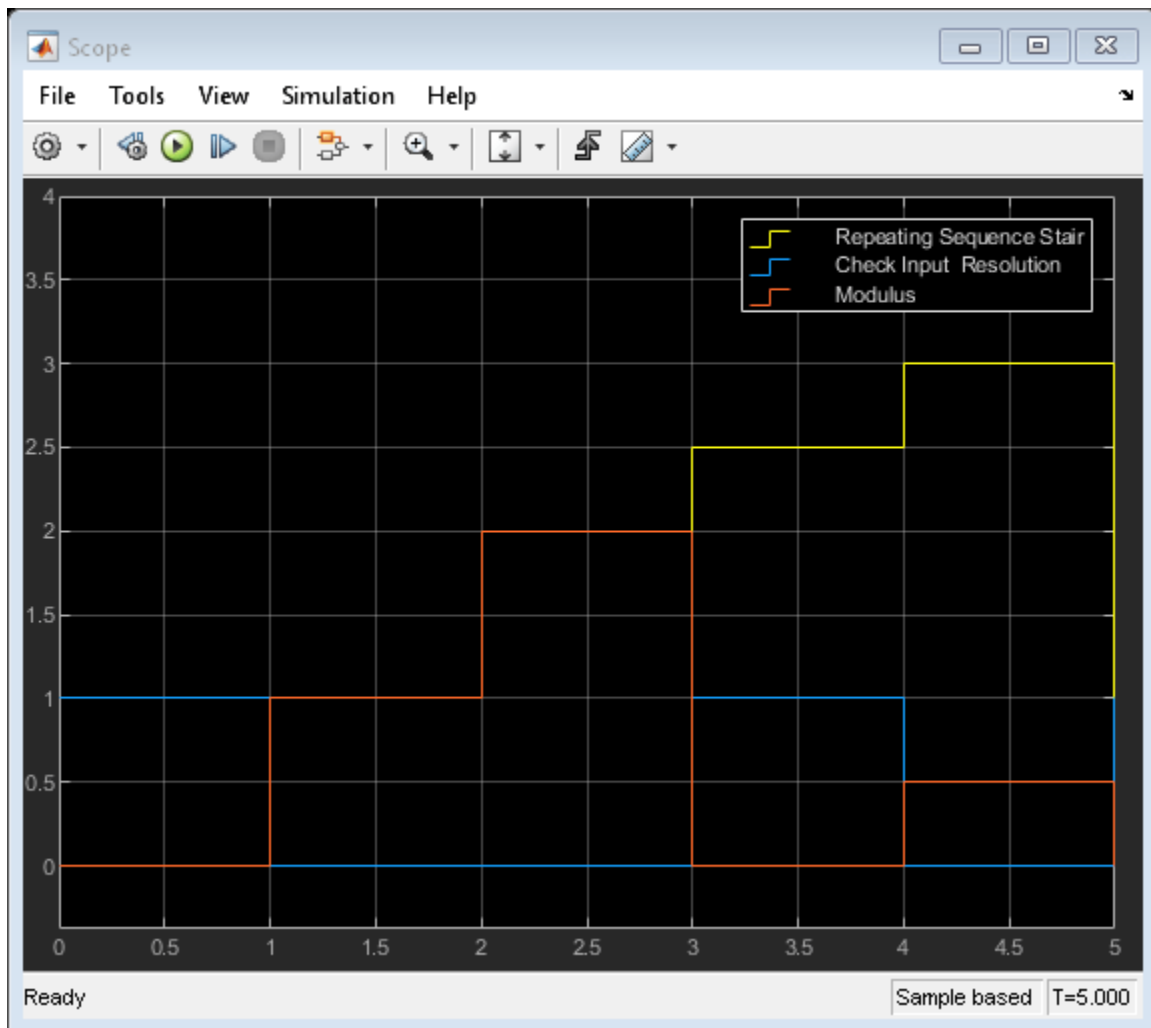

When you run the model, the Scope block plots the Repeating Sequence Stair block output, the Modulus block output, and the Check Input Resolution block output. If you use the **Step Forward** button, the data populates the three Display blocks at each time step.

- 1 Initially, the modulus of the Repeating Sequence Stair block over the resolution is 0, so the Check Input Resolution block outputs 1.
- 2 When the simulation time reaches 1, the Repeating Sequence Stair block outputs 1. The modulus rises to 1, which is larger than the tolerance, causing the Check Input Resolution block to output 0.
- 3 The assertion stays at 0 until the time is 3, when the Repeating Sequence Stair block outputs 2.5. The modulus drops to 0, and the assertion returns to 1.
- 4 Finally, the Repeating Sequence Stair block outputs 3 when the time is 4, which causes the assertion to be 1.

The model repeats this pattern until the simulation end time.

See Also

Assertion | Check Input Resolution | Display

Simulink Featured Examples

- “Simulation of a Bouncing Ball” on page 13-5
- “Single Hydraulic Cylinder Simulation” on page 13-11
- “Thermal Model of a House” on page 13-21
- “Approximating Nonlinear Relationships: Type S Thermocouple” on page 13-26
- “Digital Waveform Generation: Approximating a Sine Wave” on page 13-35
- “Accurate Zero-Crossing Detection” on page 13-45
- “Spiral Galaxy Formation Simulation Using MATLAB Function Blocks” on page 13-46
- “Counters Using Conditionally Executed Subsystems” on page 13-50
- “Friction Model with Hard Stops” on page 13-52
- “State Events” on page 13-54
- “Bang-Bang Control Using Temporal Logic” on page 13-55
- “Inverted Pendulum with Animation” on page 13-56
- “Double Spring Mass System” on page 13-58
- “Tank Fill and Empty with Animation” on page 13-60
- “Simulating Systems with Variable Transport Delay Phenomena” on page 13-63
- “Modeling a Foucault Pendulum” on page 13-67
- “Foucault Pendulum Model with VRML Visualization” on page 13-75
- “Exploring Variable-Step Solvers Using a Stiff Model” on page 13-78
- “Exploring the Solver Jacobian Structure of a Model” on page 13-84
- “Double Bouncing Ball: Use of Adaptive Zero-Crossing Location” on page 13-93
- “Four Hydraulic Cylinder Simulation” on page 13-100
- “Two Cylinder Model with Load Constraints” on page 13-106
- “Modeling a Fault-Tolerant Fuel Control System” on page 13-112
- “Using a Data Dictionary to Manage the Data for a Fuel Control System” on page 13-127
- “Modeling Engine Timing Using Triggered Subsystems” on page 13-130
- “Engine Timing Model with Closed Loop Control” on page 13-140
- “Building a Clutch Lock-Up Model” on page 13-144
- “Modeling Clutch Lock-Up Using If Blocks” on page 13-155
- “Modeling an Anti-Lock Braking System” on page 13-160
- “Automotive Suspension” on page 13-166
- “Modeling an Automatic Transmission Controller” on page 13-172
- “Vehicle Electrical System” on page 13-183
- “Simulating Automatic Climate Control Systems” on page 13-185
- “Vehicle Electrical and Climate Control Systems” on page 13-190
- “Power Window Control Project” on page 13-196

- “Developing the Apollo Lunar Module Digital Autopilot” on page 13-203
- “Designing a High Angle of Attack Pitch Mode Control” on page 13-208
- “Six Degrees of Freedom (6-DoF) Motion Platform” on page 13-221
- “Aircraft Longitudinal Flight Control” on page 13-224
- “Simulink Model Discretizer” on page 13-226
- “Radar Tracking Using MATLAB Function Block” on page 13-227
- “Optical Sensor Image Generation” on page 13-229
- “Air Traffic Control Radar Design” on page 13-238
- “Designing a Guidance System in MATLAB and Simulink” on page 13-244
- “Airframe Trim and Linearize” on page 13-260
- “Anti-Windup Control Using a PID Controller” on page 13-265
- “Bumpless Control Transfer Between Manual and PID Control” on page 13-280
- “Two Degree-of-Freedom PID Control for Setpoint Tracking” on page 13-289
- “Data Typing in Simulink” on page 13-295
- “Data Typing Filter” on page 13-299
- “Explore Simulink Bus Capabilities” on page 13-301
- “Model Arrays of Buses” on page 13-309
- “Matrix Signals” on page 13-311
- “Variable-Size Signal Basic Operations” on page 13-312
- “Variable-Size Signal Length Adaptation” on page 13-314
- “Multimode Variable-Size Signal” on page 13-315
- “Parallel Channel Power Allocation” on page 13-316
- “Merging Signals” on page 13-318
- “Share Data Store Between Instances of a Reusable Algorithm” on page 13-331
- “Attaching Input Data to External Inputs via Custom Input Mappings” on page 13-336
- “Using Mapping Modes with Custom-Mapped External Inputs” on page 13-340
- “Converting Harness-Driven Models to Use Harness-Free External Inputs” on page 13-344
- “Logging States in Structure Format” on page 13-349
- “Saving and Restoring Simulation Operating Point” on page 13-352
- “Logging Intervals” on page 13-356
- “Working with Big Data” on page 13-359
- “Simulink Subsystem Semantics” on page 13-363
- “If-Then-Else Blocks” on page 13-364
- “Triggered Subsystems” on page 13-366
- “Enabled Subsystems” on page 13-368
- “Advanced Enabled Subsystems” on page 13-370
- “Resettable Subsystems” on page 13-373
- “Discrete and Continuous Resettable Subsystems” on page 13-375
- “Block Priority” on page 13-378

- “Monitoring Ink Status on a Shared Printer Using Simulink Functions” on page 13-379
- “Modeling Reusable Components Using Multiply Instanced Simulink Functions” on page 13-381
- “Dynamic Priority Scheduling of Functions” on page 13-383
- “Component-Based Modeling with Model Reference” on page 13-384
- “Viewing Signals in Model Reference Instances” on page 13-388
- “Visualize Model Reference Hierarchies” on page 13-396
- “Introduction to Managing Data with Model Reference” on page 13-401
- “Detailed Workflow for Managing Data with Model Reference” on page 13-412
- “Interface Specification Using Bus Objects” on page 13-429
- “Convert Subsystem to Referenced Model” on page 13-436
- “Using Data Stores Across Multiple Models” on page 13-438
- “Model Reference Function-Call” on page 13-444
- “Explore Protected Model Capabilities” on page 13-446
- “Model Reference Variants” on page 13-451
- “Assigning Tasks to Cores for Multicore Programming” on page 13-455
- “Implement an FFT on a Multicore Processor and an FPGA” on page 13-458
- “Multicore Programming of a Field-Oriented Control on Zynq” on page 13-462
- “Multicore Deployment of a Plant Model” on page 13-468
- “Modeling Objects with Identical Dynamics Using For Each Subsystem” on page 13-472
- “Vectorizing a Scalar Algorithm with a For Each Subsystem” on page 13-477
- “Tiled Processing of 2D Signals with For Each Subsystem” on page 13-479
- “Neighborhood Processing Using For Each Subsystems” on page 13-480
- “Using a Project with SVN” on page 13-483
- “Using a Project with Git” on page 13-488
- “Using a Project” on page 13-493
- “Perform Impact Analysis with a Project” on page 13-497
- “Referencing Projects from Another Project” on page 13-504
- “Automate Label Management in a Project” on page 13-505
- “Run Custom Tasks with a Project” on page 13-508
- “Upgrade Simulink Models Using a Project” on page 13-511
- “Export a Subset of a Project Using an Export Profile” on page 13-513
- “Create and Reference a Project Programmatically” on page 13-515
- “Compare and Merge Simulink Models” on page 13-519
- “Compare and Merge Simulink Models Containing Stateflow” on page 13-521
- “Resolve Conflicts with Simulink Three-Way Merge” on page 13-524
- “Call C Functions Using C Caller Block” on page 13-528
- “Bring Custom Image Filter Algorithms as Reusable Blocks in Simulink” on page 13-532
- “Custom Code and Hand Coded Blocks using the S-function API” on page 13-534
- “Inputs Passed by Value or Address to Legacy Functions” on page 13-535

- “Output Passed by Return Argument from Legacy Functions” on page 13-538
- “Fixed Point Signals in Legacy Functions” on page 13-540
- “Fixed Point Parameters in Legacy Functions” on page 13-543
- “Lookup Tables Implemented in Legacy Functions” on page 13-546
- “Start and Terminate Actions Within Legacy Functions” on page 13-549
- “Using Buses with Legacy Functions Having Structure Arguments” on page 13-553
- “Inherited Signal Dimensions for Legacy Function Arguments” on page 13-556
- “C++ Object Methods as Legacy Functions” on page 13-559
- “Persistent Memory Within Legacy Functions” on page 13-562
- “Multi-Dimensional Signals in Legacy Functions” on page 13-565
- “Complex Signals in Legacy Function” on page 13-567
- “Specified or Inherited Sample Time with Legacy Functions” on page 13-569
- “Illustration of Law of Large Numbers” on page 13-572
- “Using Buses with MATLAB System Blocks” on page 13-574
- “Run Quality Checks on S-Functions” on page 13-576
- “Using the Prelookup and Interpolation Blocks” on page 13-578
- “Saving Memory in Prelookup and Interpolation Blocks by Using Smaller Data” on page 13-583
- “Model Advisor” on page 13-584
- “Introduction to Profiling Models” on page 13-585
- “Introduction to Accelerating Models” on page 13-588
- “Determine Why Simulink Accelerator Is Regenerating Code” on page 13-590
- “Parallel Simulations Using Parsim: Test-Case Sweep” on page 13-595
- “Parallel Simulations Using Parsim: Parameter Sweep in Normal Mode” on page 13-599
- “Parallel Simulations Using Parsim: Parameter Sweep in Rapid Accelerator Mode” on page 13-603
- “Rapid Accelerator Simulations Using Parsim” on page 13-607
- “Multiple Simulations Workflow Tips” on page 13-611
- “Streamline Simulink Blockset Authoring Process with Blockset Designer” on page 13-615
- “Importing a Co-Simulation FMU into Simulink” on page 13-616
- “Importing a Model Exchange FMU into Simulink” on page 13-617
- “Simplify Interface for Structured Data with FMU Import Block” on page 13-618
- “Co-Simulation Signal Compensation” on page 13-620
- “Multithread Co-Simulation” on page 13-622
- “Pulse Width Modulation Using MATLAB System Block” on page 13-624
- “Modeling Cyber-Physical Systems” on page 13-625
- “Schedule an Export-Function Model Using the Schedule Editor” on page 13-630
- “Promote Block Parameters on a Mask” on page 13-634
- “Graph-Based Multithread Simulation” on page 13-635
- “Find Shortest Control Path in Simulink Model” on page 13-637

Simulation of a Bouncing Ball

This example shows how to use two different approaches to modeling a bouncing ball using Simulink®.

Overview

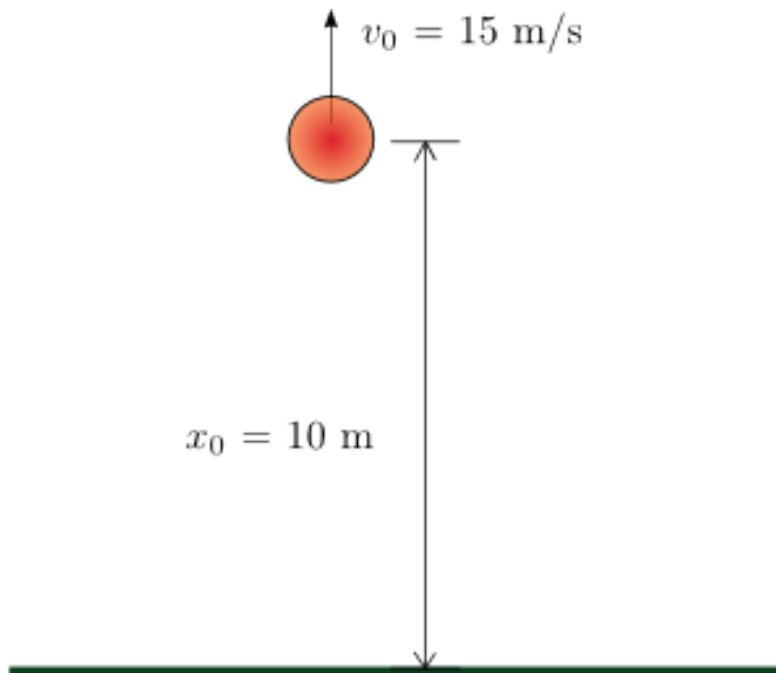

Figure 1: A ball is thrown up with a velocity of 15 m/s from a height of 10 m.

A bouncing ball model is a classic example of a **hybrid dynamic system**. A hybrid dynamic system is a system that involves both continuous dynamics, as well as, discrete transitions where the system dynamics can change and the state values can jump. The continuous dynamics of a bouncing ball is simply given by:

$$\frac{dv}{dt} = -g,$$

$$\frac{dx}{dt} = v,$$

where g is the acceleration due to gravity, $x(t)$ is the position of the ball and $v(t)$ is the velocity. Therefore, the system has two continuous states: position x and velocity v .

The hybrid system aspect of the model originates from the modeling of a collision of the ball with the ground. If one assumes a partially elastic collision with the ground, then the velocity before the collision, v^- , and velocity after the collision, v^+ , can be related by the coefficient of restitution of the ball, κ , as follows:

$$v^+ = -\kappa v^-, \quad x = 0$$

The bouncing ball therefore displays a jump in a continuous state (velocity) at the transition condition, $x = 0$.

A bouncing ball is one of the simplest models that shows the **Zeno phenomenon**. Zeno behavior is informally characterized by an infinite number of events occurring in a finite time interval for certain hybrid systems. As the ball loses energy in the bouncing ball model, a large number of collisions with the ground start occurring in successively smaller intervals of time. Hence the model experiences Zeno behavior. Models with **Zeno behavior** are inherently difficult to simulate on a computer, but are encountered in many common and important engineering applications.

Using Two Integrator Blocks to Model a Bouncing Ball

Open this model

You can use two Integrator blocks to model a bouncing ball. The Integrator on the left is the velocity integrator modeling the first equation and the Integrator on the right is the position integrator. Navigate to the position integrator block dialog and observe that it has a lower limit of zero. This condition represents the constraint that the ball cannot go below the ground.

The state port of the position integrator and the corresponding comparison result is used to detect when the ball hits the ground and to reset both integrators. The state port of the velocity integrator is used for the calculation of v^+ .



Bouncing Ball Model

Two separate Integrators are less efficient than a single Second-Order Integrator for simulating a bouncing ball. [Click here to see sldemo_bounce for the recommended modeling approach.](#)

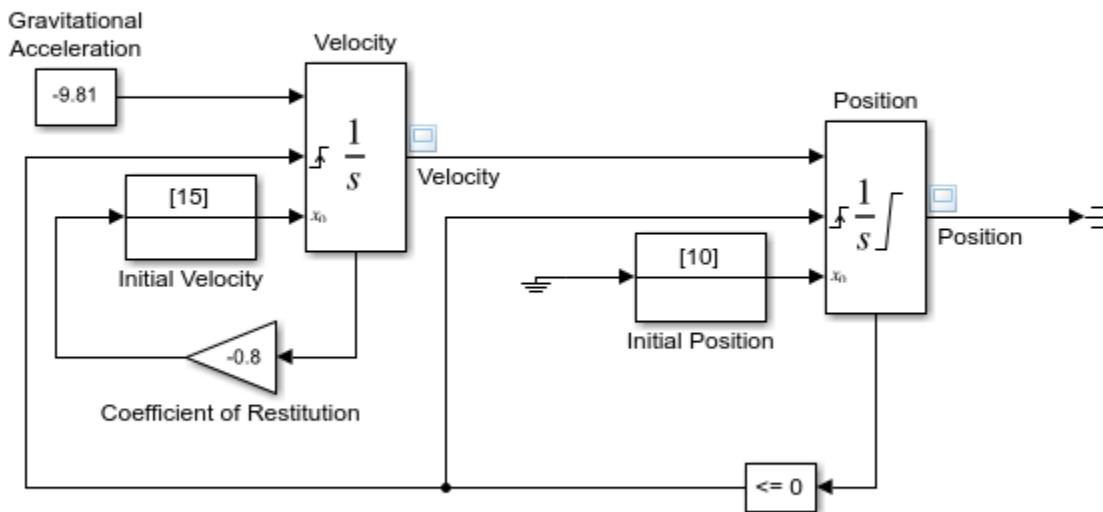

Copyright 1990-2013 The MathWorks, Inc.

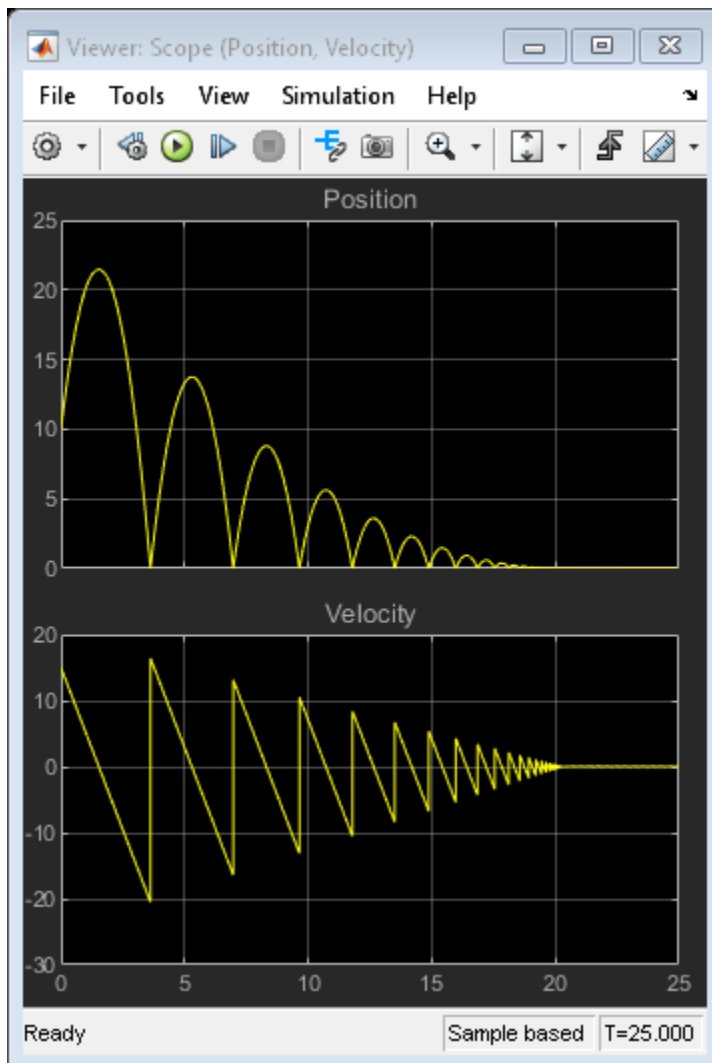

To observe the Zeno behavior of the system, navigate to the Solver pane of the Configuration Parameters dialog box. In the 'Zero-crossing options' section, confirm that 'Algorithm' is set to 'Nonadaptive' and that the simulation 'Stop time' is set to 25 seconds. Run the simulation.

Observe that the simulation errors out as the ball hits the ground more and more frequently and loses energy. Consequently, the simulation exceeds the default limit of 1000 for the 'Number of consecutive zero crossings' allowed. Now navigate to the Configuration Parameters dialog box. In the 'Zero-crossing options' section, set the 'Algorithm' to 'Adaptive'. This algorithm introduces a sophisticated treatment of such chattering behavior. Therefore, you can now simulate the system beyond 20 seconds. Note, however, the chatter of the states between 21 seconds and 25 seconds and warning from Simulink about the strong chattering in the model around 20 seconds.

Using a Second-Order Integrator Block to Model a Bouncing Ball

Open this model

You can use a single Second-Order Integrator block to model this system. The second equation $dx/dt = v$ is internal to the Second-Order Integrator block in this case. Navigate to the Second-Order

Integrator block dialog and notice that, as earlier, x has a lower limit of zero. Navigate to the Attributes tab on the block dialog and note that the option 'Reinitialize dx/dt when x reaches saturation' is checked. This parameter allows us to reinitialize dx/dt (v in the bouncing ball model) to a new value at the instant x reaches its saturation limit. For the bouncing ball model, this option therefore implies that when the ball hits the ground, its velocity can be set to a different value, i.e., to the velocity after the impact. Notice the loop for calculating the velocity after a collision with the ground. To capture the velocity v^- of the ball just before the collision, the dx/dt output port of the Second-Order Integrator block and a Memory block are used. v^- is then used to calculate the rebound velocity v^+ .

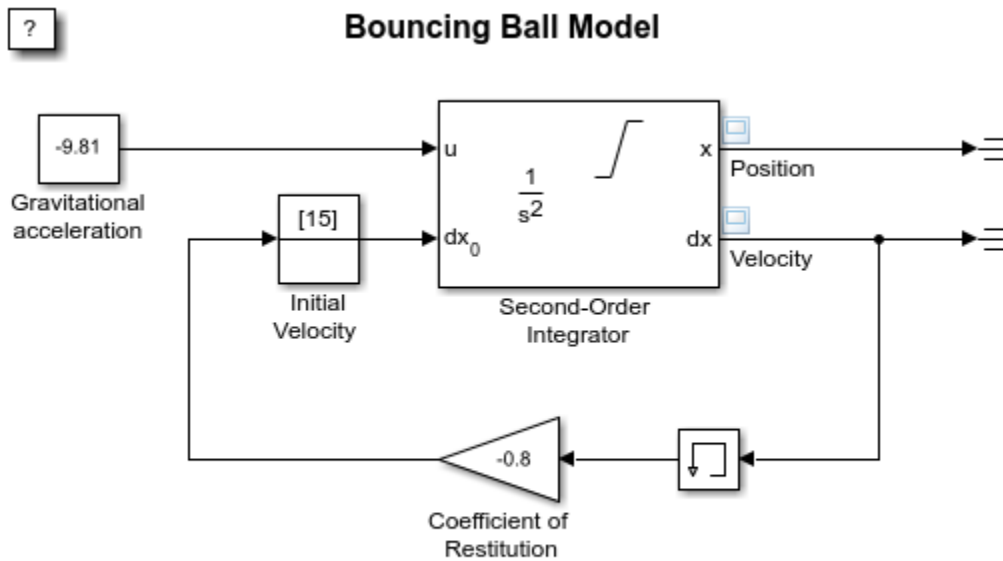

Copyright 2004-2013 The MathWorks, Inc.

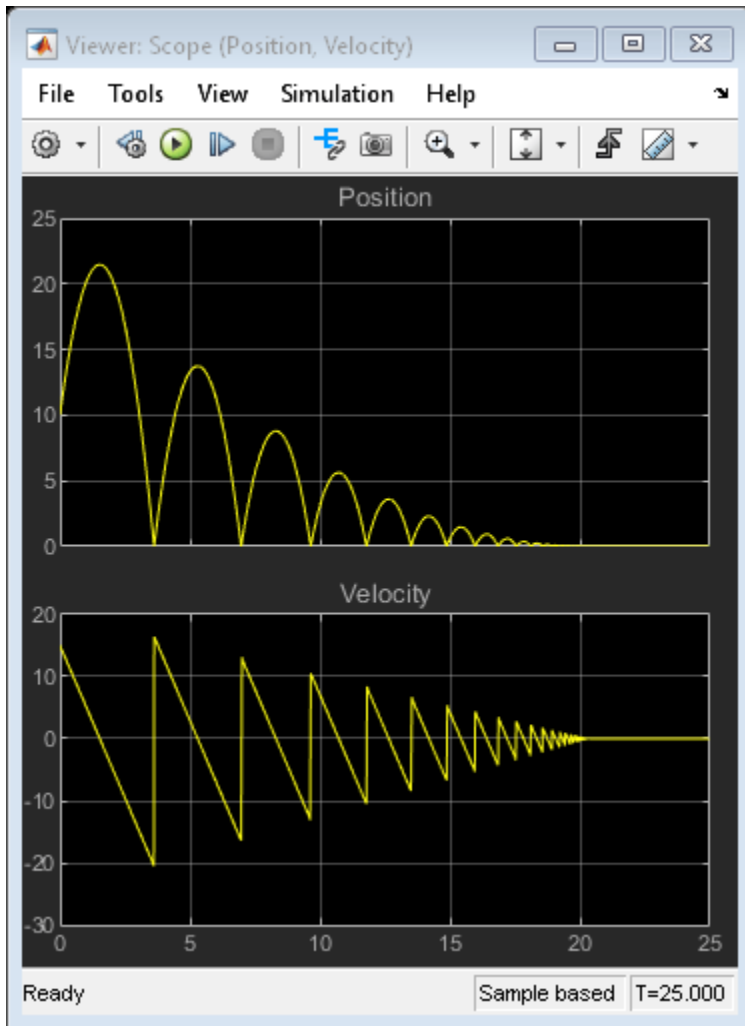

Navigate to the Solver pane of the Configuration Parameters dialog box. Confirm that 'Algorithm' is set to 'Nonadaptive' in the 'Zero-crossing options' section and the simulation 'Stop Time' is set to 25 seconds. Simulate the model. Note that the simulation encountered no problems. You were able to simulate the model without experiencing excessive chatter after $t = 20$ seconds and without setting the 'Algorithm' to 'Adaptive'.

Second-Order Integrator Model Is the Preferable Approach to Modeling Bouncing Ball

One can analytically calculate the exact time t^* when the ball settles down to the ground with zero velocity by summing the time required for each bounce. This time is the sum of an infinite geometric series given by:

$$t^* = \frac{1}{g} \left(v_0 + v_1 \left(\frac{1 + \kappa}{1 - \kappa} \right) \right), \quad v_1 = \sqrt{v_0^2 + 2gx_0}.$$

Here x_0 and v_0 are initial conditions for position and velocity respectively. The velocity and the position of the ball must be identically zero for $t > t^*$. In the figure below, results from both simulations are plotted near t^* . The vertical red line in the plot is t^* for the given model parameters. For $t < t^*$ and far away from t^* , both models produce accurate and identical results. Hence, only a

magenta line from the second model is visible in the plot. However, the simulation results from the first model are inexact after t^* ; it continues to display excessive chattering behavior for $t > t^*$. In contrast, the second model using the Second-Order Integrator block settles to exactly zero for $t > t^*$.

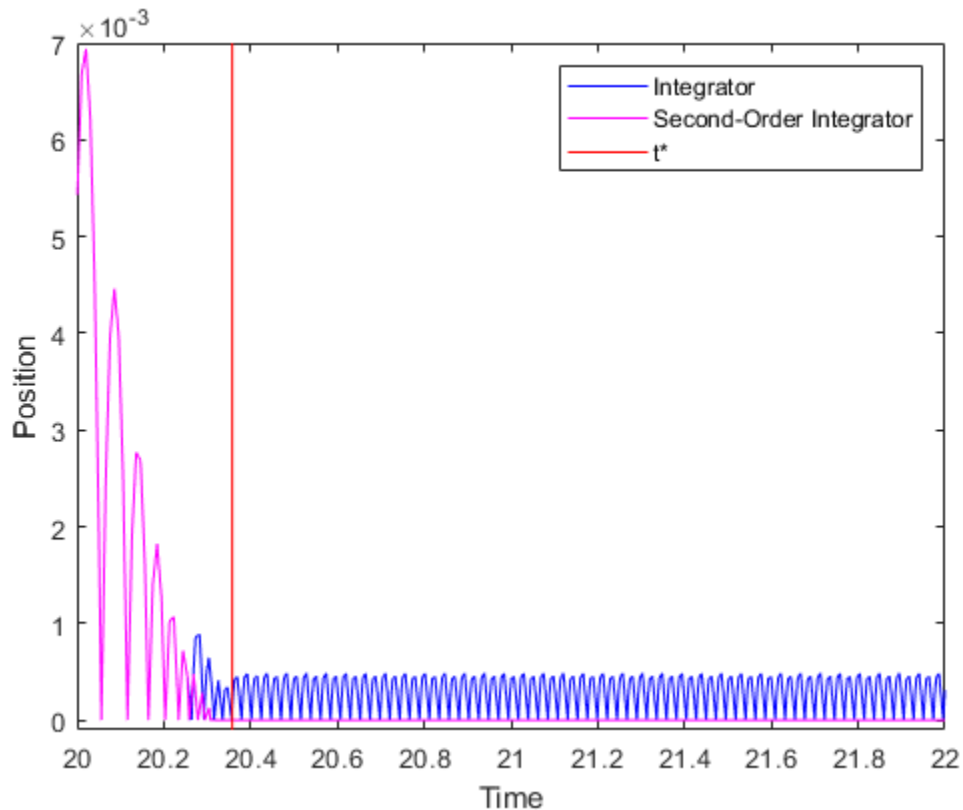

Figure 2: Comparison of simulation results from the two approaches.

Figure 2 conclusively shows that the second model has superior numerical characteristics as compared to the first model. The reason for the higher accuracy associated with the Second-Order Integrator model is as follows. The second differential equation $dx/dt = v$ is internal to the Second-Order Integrator block. Therefore, the block algorithms can leverage this known relationship between the two states and deploy heuristics to clamp down the undesirable chattering behavior for certain conditions. These heuristics become active when the two states are no longer mutually consistent with each other due to integration errors and chattering behavior. You can thus use physical knowledge of the system to alleviate the problem of simulation getting stuck in a Zeno state for certain classes of Zeno models.

Single Hydraulic Cylinder Simulation

This example shows how to use Simulink® to model a hydraulic cylinder. You can apply these concepts to applications where you need to model hydraulic behavior. See two related examples that use the same basic components: four cylinder model and two cylinder model with load constraints.

- Note: This is a basic hydraulics example. You can more easily build hydraulic and automotive models using Simscape™ Driveline™ and Simscape Fluids™.
- **Simscape Fluids** provides component libraries for modeling and simulating fluid systems. It includes models of pumps, valves, actuators, pipelines, and heat exchangers. You can use these components to develop fluid power systems such as front-loader, power steering, and landing gear actuation systems. Engine cooling and fuel supply systems can also be developed with Simscape Fluids. You can integrate mechanical, electrical, thermal, and other systems using components available in the Simscape product family.
- **Simscape Driveline** provides component libraries for modeling and simulating one-dimensional mechanical systems. It includes models of rotational and translational components, such as worm gears, planetary gears, lead screws, and clutches. You can use these components to model the transmission of mechanical power in helicopter drivetrains, industrial machinery, vehicle powertrains, and other applications. Automotive components, such as engines, tires, transmissions, and torque converters, are also included.

Analysis and Physics of the Model

Figure 1 shows a schematic diagram of the basic model. The model directs the pump flow, Q , to supply pressure, p_1 , from which laminar flow, q_{1ex} , leaks to exhaust. The control valve for the piston/cylinder assembly is modeled as turbulent flow through a variable-area orifice. Its flow, q_{12} , leads to intermediate pressure, p_2 , which undergoes a subsequent pressure drop in the line connecting it to the actuator cylinder. The cylinder pressure, p_3 , moves the piston against a spring load, resulting in position x .

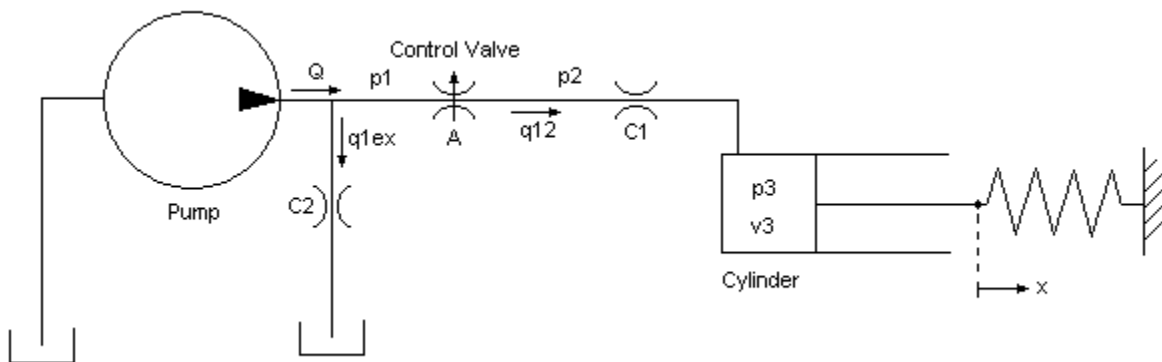

Figure 1: Schematic diagram of the basic hydraulic system

At the pump output, the flow is split between leakage and flow to the control valve. We model the leakage, q_{1ex} , as laminar flow (see Equation Block 1).

Equation Block 1

$$Q = q_{12} + q_{1ex}$$

$$q_{1ex} = C_2 \cdot p_1$$

$$p_1 = \frac{(Q - q_{12})}{C_2}$$

$$Q = \text{pump flow}$$

$$q_{12} = \text{control valve flow}$$

$$q_{1ex} = \text{leakage}$$

$$C_2 = \text{flow coefficient}$$

$$p_1 = \text{pump pressure}$$

We modeled turbulent flow through the control valve with the orifice equation. The sign and absolute value functions accommodate flow in either direction (see Equation Block 2).

Equation Block 2

$$q_{12} = C_d \cdot A \cdot \text{sgn}(p_1 - p_2) \cdot \sqrt{\frac{2}{\rho} |p_1 - p_2|}$$

$$C_d = \text{orifice discharge coefficient}$$

$$A = \text{orifice area}$$

$$p_2 = \text{pressure downstream of control valve}$$

$$\rho = \text{fluid density}$$

The fluid within the cylinder pressurizes due to this flow, $q_{12} = q_{23}$, minus the compliance of the piston motion. We also modeled fluid compressibility in this case (see Equation Block 3).

Equation Block 3

$$\frac{dp_3}{dt} = \frac{\beta}{V_3} \left(q_{12} - A_c \frac{dx}{dt} \right)$$

$$V_3 = V_{30} + A_c \cdot x$$

$$p_3 = \text{piston pressure}$$

$$\beta = \text{fluid bulk modulus}$$

$$V_3 = \text{fluid volume at } p_3$$

$$V_{30} = \text{fluid volume in the piston for } x = 0$$

$$A_c = \text{cylinder cross-sectional area}$$

We neglected the piston and spring masses because of the large hydraulic forces. We completed the system of equations by differentiating this relationship and incorporating the pressure drop between p_2 and p_3 . Equation Block 3 models laminar flow in the line from the valve to the actuator. Equation block 4 gives the force balance at the piston.

Equation Block 4

$$x = p_3 \frac{A_c}{K}$$

$$\frac{dx}{dt} = \frac{dp_3}{dt} \frac{A_c}{K}$$

$$q_{23} = q_{12} = C_1 (p_2 - p_3)$$

$$p_2 = p_3 + \frac{q_{12}}{C_1}$$

K = spring constant

C_1 = laminar flow coefficient

Modeling

Figure 2 shows the top level diagram of the model. The pump flow and the control valve orifice area are simulation inputs. The model is organized as two subsystems: the 'Pump' and the 'Valve/Cylinder/Piston/Spring Assembly'.

Opening the Model and Running the Simulation

To open this model, type `sldemo_hydcyl` at MATLAB® terminal (click on the hyperlink if you are using MATLAB Help). Press the "Play" button on the model toolbar to run the simulation.

The model logs relevant data to MATLAB workspace, into the Simulink.SimulationOutput object `out`. The signal logging data is stored in the `out` object, in a structure called `sldemo_hydcyl_output`. Logged signals have a blue indicator (see the model). For more information, see "View and Access Signal Logging Data".



Single Hydraulic Cylinder Simulation

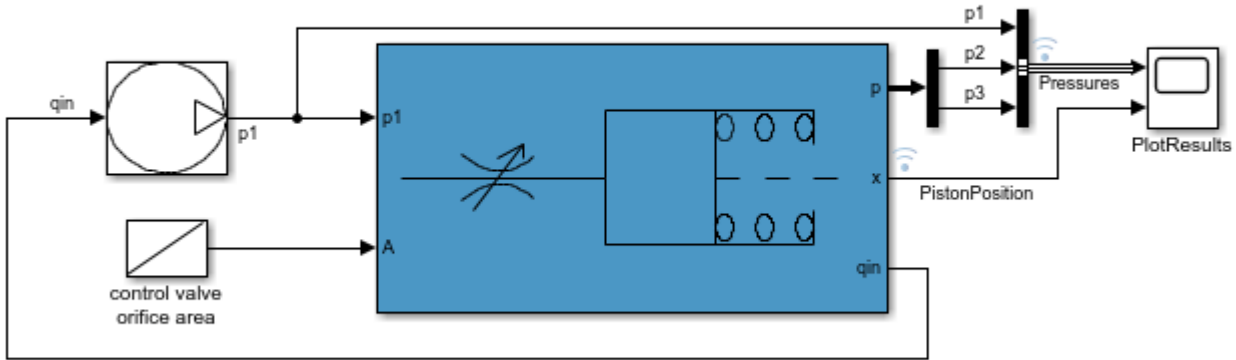

Copyright 1990-2012 The MathWorks, Inc.

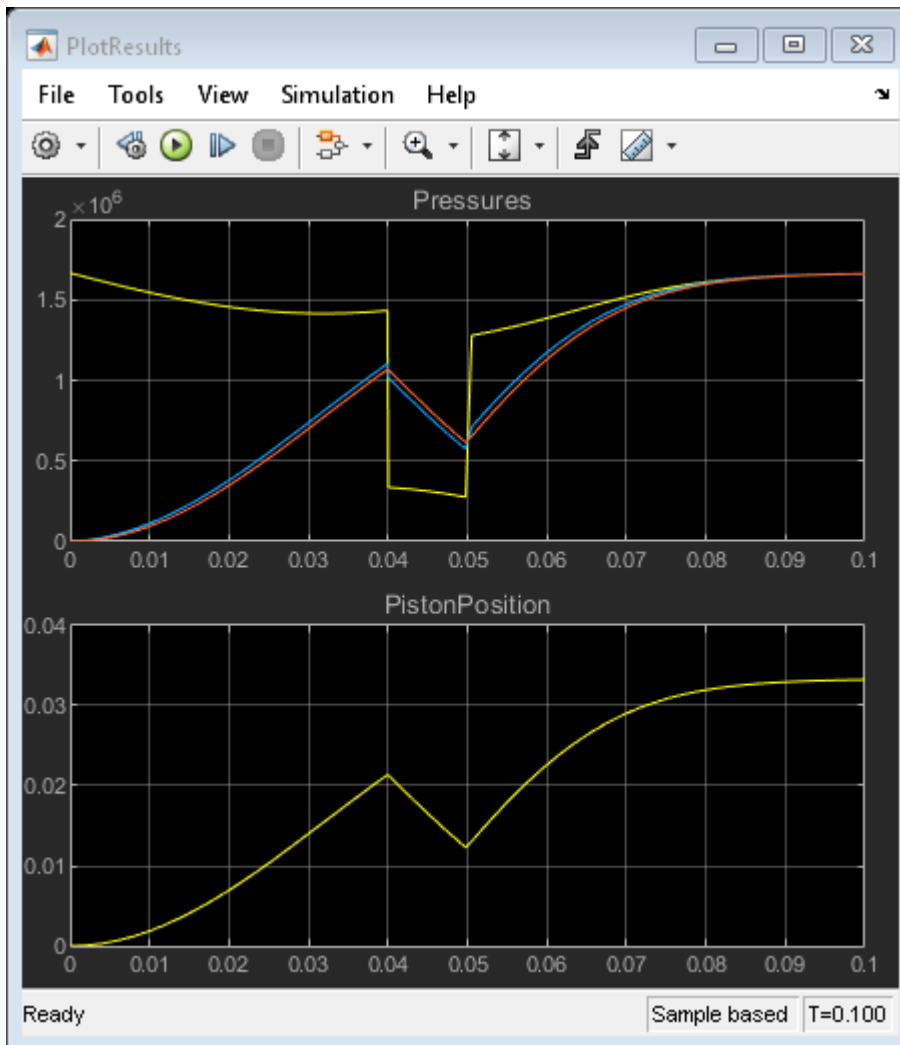
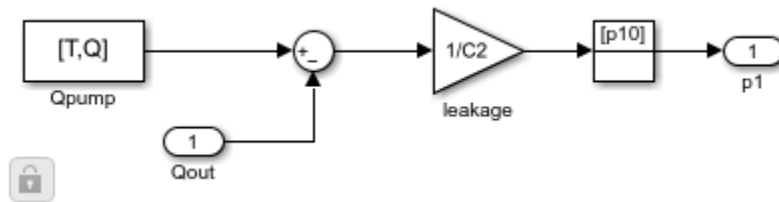

Figure 2: Single cylinder model and simulation results**'Pump' Subsystem**

Right-click the Pump masked subsystem and select **Mask > Look Under Mask**. The pump model computes the supply pressure as a function of the pump flow and the load (output) flow (Figure 3). Q_{pump} is the pump flow data (saved in the model workspace). A matrix with column vectors of time points and the corresponding flow rates $[T, Q]$ specifies the flow data. The model calculates pressure p_1 as indicated in Equation Block 1. Because $Q_{\text{out}} = q_{12}$ is a direct function of p_1 (via the control valve), an algebraic loop is formed. An estimate of the initial value, p_{10} , enables a more efficient solution.

**Figure 3:** The pump subsystem

We masked the 'Pump' subsystem in Simulink to allow the user to easily access the parameters (see Figure 4). The parameters to be specified are T , Q , p_{10} , and C_2 . We then assigned the masked block the icon shown in Figure 2, and saved it in a Simulink library.

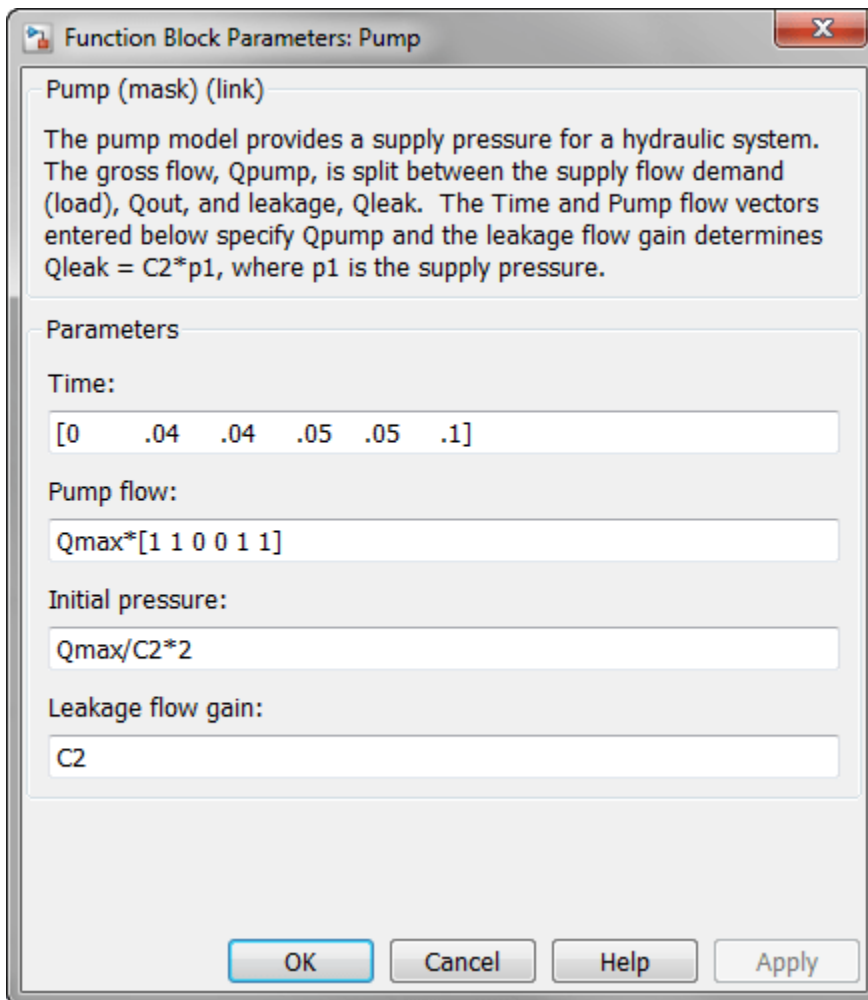

Figure 4: Entering pump parameters

'Valve/Cylinder/Piston/Spring Assembly' Subsystem

Right-click the 'Valve/Cylinder/Piston/Spring Assembly' subsystem and select **Mask > Look Under Mask** to see the Actuator subsystem (see Figure 5). A system of differential-algebraic equations models the cylinder pressurization with the pressure p_3 , which appears as a derivative in Equation Block 3 and is used as the state (integrator). If we neglect piston mass, the spring force and piston position are direct multiples of p_3 and the velocity is a direct multiple of p_3 's time derivative. This latter relationship forms an algebraic loop around the 'Beta' Gain block. The intermediate pressure p_2 is the sum of p_3 and the pressure drop due to the flow from the valve to the cylinder (Equation Block 4). This relationship also imposes an algebraic constraint through the control valve and the $1/C_1$ gain.

The control valve subsystem computes the orifice (Equation Block2). It uses as inputs the upstream and downstream pressures and the variable orifice area. The 'Control Valve Flow' Subsystem computes the signed square root:

$$y = \text{sgn}(u)\sqrt{|u|}$$

Three nonlinear functions are used, two of which are discontinuous. In combination, however, y is a continuous function of u .

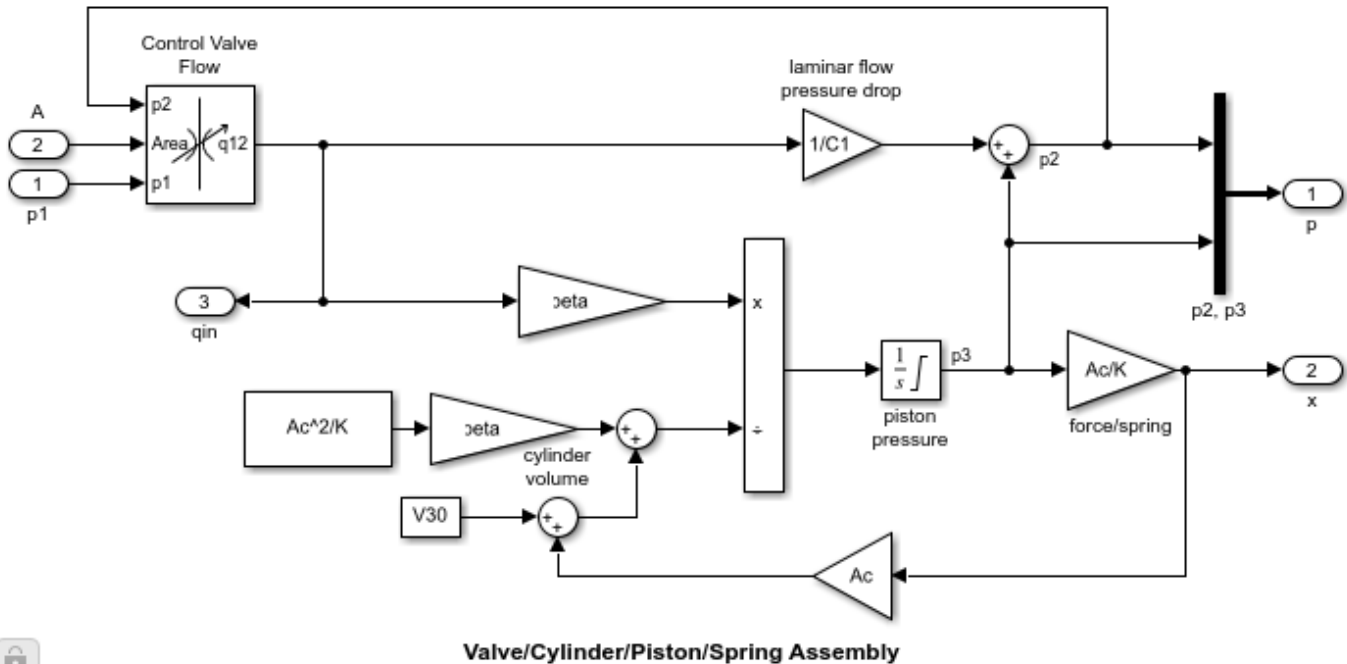

Figure 5: The valve/cylinder/piston/spring subsystem

Results

Simulation Parameters

We simulated the model using the following data. The information is loaded from a MAT-file - `sldemo_hydcyl_data.mat`, which is also used for the other two hydraulic cylinder models. The users can enter data via the Pump and Cylinder Masks shown in Figures 4 and 6.

$$C_d = 0.61$$

$$\rho = 800 \text{ kg/m}^3$$

$$C_1 = 2e - 8 \text{ m}^3/\text{sec}/\text{Pa}$$

$$C_2 = 3e - 9 \text{ m}^3/\text{sec}/\text{Pa}$$

$$\beta = 7e8 \text{ Pa}$$

$$A_c = 1e - 3 \text{ m}^2$$

$$K = 5e4 \text{ N/m}$$

$$V_{30} = 2.5e - 5 \text{ m}^3$$

$$T = [0 \ 0.04 \ 0.04 \ 0.05 \ 0.05 \ 0.1] \text{ sec}$$

$$Q = [0.005 \ 0.005 \ 0 \ 0 \ 0.005 \ 0.005] \text{ m}^3/\text{sec}$$

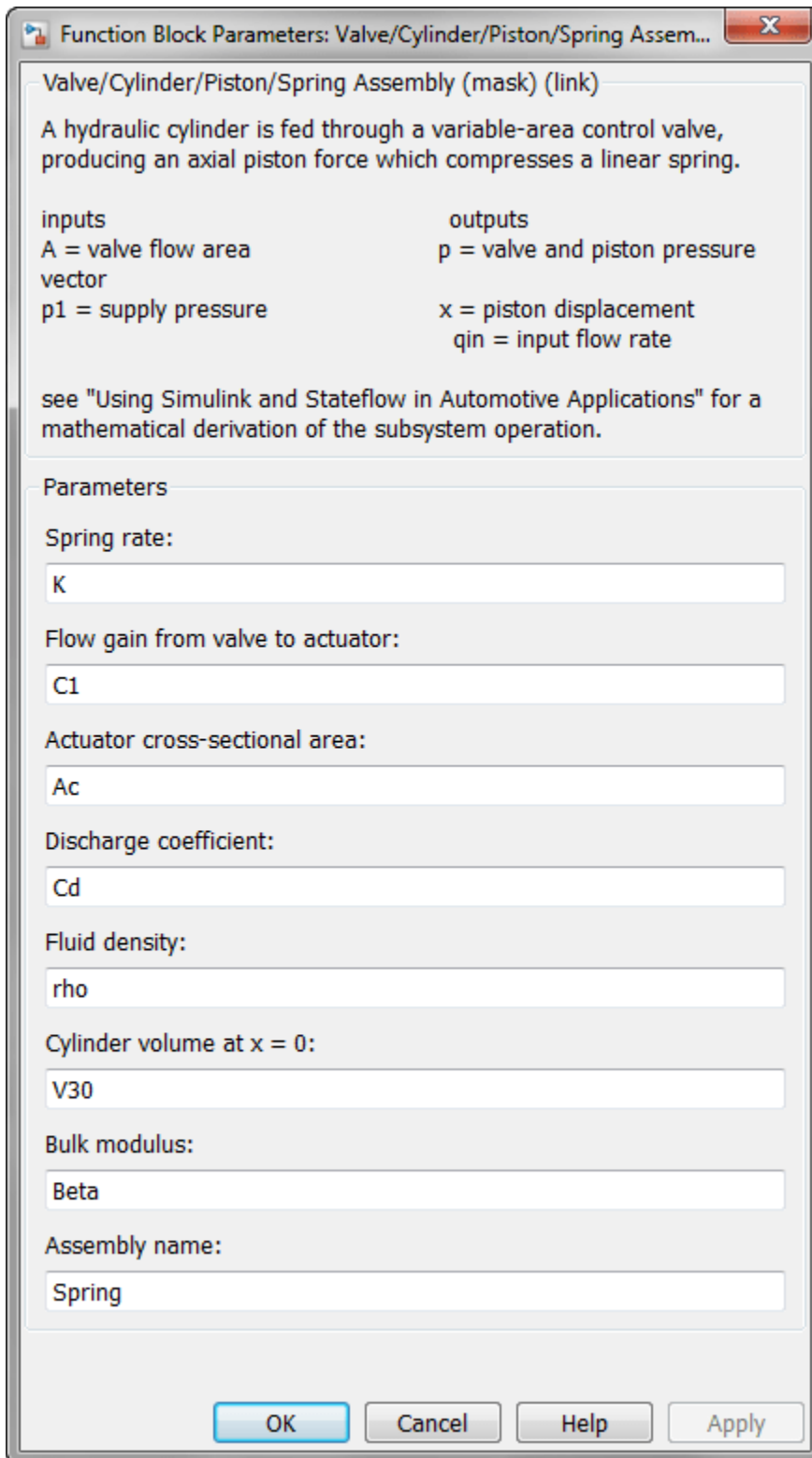

Function Block Parameters: Valve/Cylinder/Piston/Spring Assem... X

Valve/Cylinder/Piston/Spring Assembly (mask) (link)

A hydraulic cylinder is fed through a variable-area control valve, producing an axial piston force which compresses a linear spring.

| inputs | outputs |
|----------------------------|-------------------------------|
| A = valve flow area vector | p = valve and piston pressure |
| p1 = supply pressure | x = piston displacement |
| | qin = input flow rate |

see "Using Simulink and Stateflow in Automotive Applications" for a mathematical derivation of the subsystem operation.

Parameters

Spring rate:

Flow gain from valve to actuator:

Actuator cross-sectional area:

Discharge coefficient:

Fluid density:

Cylinder volume at x = 0:

Bulk modulus:

Assembly name:

Figure 6: Entering valve/cylinder/piston/spring assembly parameters**Plotting Simulation Results**

The system initially steps to a pump flow of $0.005 \text{ m}^3/\text{sec}=300 \text{ l/min}$, abruptly steps to zero at $t=0.04 \text{ sec}$, then resumes its initial flow rate at $t=0.05 \text{ sec}$.

The control valve starts with zero orifice area and ramps to $1e-4 \text{ sq.m.}$ during the 0.1 sec simulation time. With the valve closed, all of the pump flow goes to leakage so the initial pump pressure increases to $p_{10} = Q/C2 = 1667 \text{ kPa}$.

As the valve opens, pressures p_2 and p_3 build up while p_1 decreases in response to the load increase as shown in Figure 7. When the pump flow cuts off, the spring and piston act like an accumulator and p_3 decreases continuously. Then the flow reverses direction, so p_2 , though relatively close to p_3 , falls abruptly. At the pump itself, all of the back-flow leaks and p_1 drops radically. The behavior reverses as the flow is restored.

The piston position is directly proportional to p_3 , where the hydraulic and spring forces balance. Discontinuities in the velocity at 0.04 sec and 0.05 sec indicate negligible mass. The model reaches a steady state when all of the pump flow again goes to leakage, now due to zero pressure drop across the control valve (which means $p_3 = p_2 = p_1 = p_{10}$).

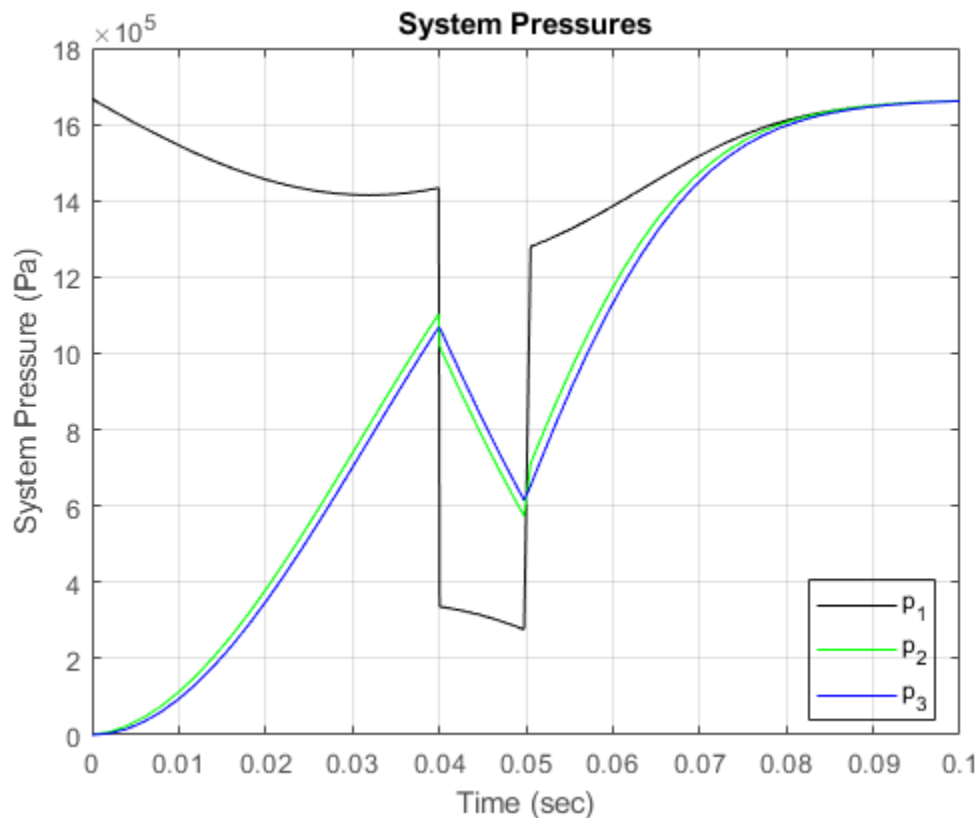
**Figure 7:** Simulation Results: System Pressures

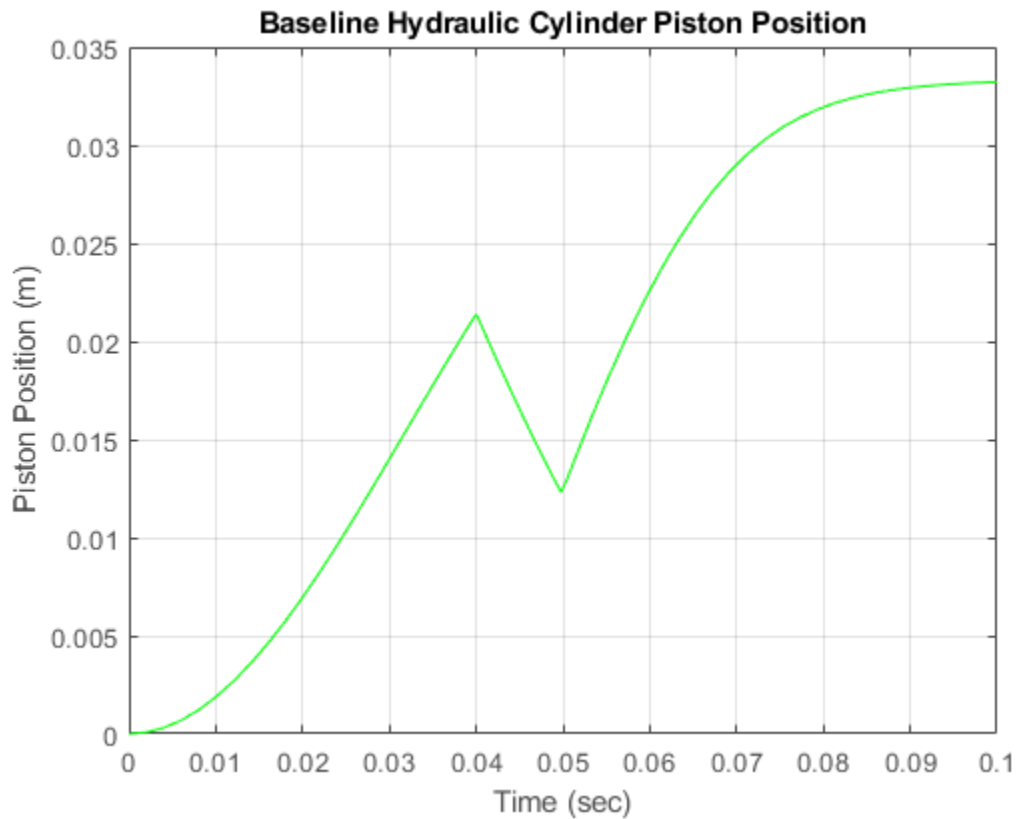

Figure 8: Simulation Results: Hydraulic Cylinder Piston Position

Closing the Model

Close the model and clear generated data.

See Also

Related Examples

- “Four Hydraulic Cylinder Simulation” on page 13-100
- “Two Cylinder Model with Load Constraints” on page 13-106

More About

- “Decide How to Visualize Simulation Data”

Model Components

Set Point

The Set Point is a constant block. It specifies the temperature that must be maintained indoors. By default, it is 70 °F. Temperatures are given in °F. The model converts the temperature to °C.

Thermostat

The Thermostat subsystem contains a Relay block. The thermostat allows fluctuations of 5 °F above or below the desired room temperature. If air temperature drops below 65 °F, the thermostat turns on the heater.

Open the Thermostat subsystem.

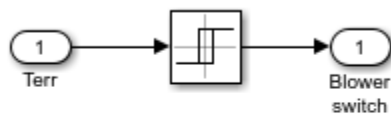

Thermostat Subsystem

Heater

The Heater subsystem models a constant air flow rate, $Mdot$, which is specified in the `sldemo_househeat_data.m` file. The thermostat signal turns the heater on or off. When the heater is on, it blows hot air at temperature T_{heater} (50 °C = 122 °F by default) at a constant flow rate of $Mdot$ (1kg/sec = 3600kg/hr by default). Equation 1 expresses the heat flow into the room.

Equation 1

$$\frac{dQ}{dt} = (T_{heater} - T_{room}) \cdot Mdot \cdot c$$

$$\frac{dQ}{dt} = \text{heat flow from the heater into the room}$$

c = heat capacity of air at constant pressure

$Mdot$ = air mass flow rate through heater (kg/hr)

T_{heater} = temperature of hot air from heater

T_{room} = current room air temperature

Open the Heater subsystem.

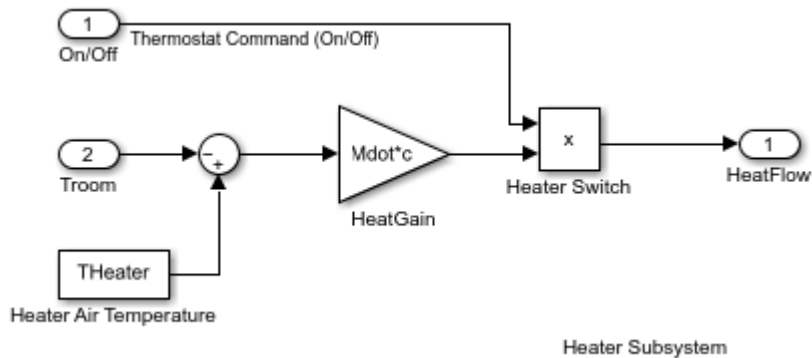

Cost Calculator

The Cost Calculator is a Gain block. Cost Calculator integrates the heat flow over time and multiplies it by the energy cost. The model plots the heating cost in the PlotResults scope.

House

The House is a subsystem that calculates room temperature variations. It takes into consideration the heat flow from the heater and heat losses to the environment. Heat losses and the temperature time derivative are expressed by Equation 2.

Equation 2

$$\left(\frac{dQ}{dt}\right)_{\text{losses}} = \frac{T_{\text{room}} - T_{\text{out}}}{R_{\text{eq}}}$$

$$\frac{dT_{\text{room}}}{dt} = \frac{1}{M_{\text{air}} \cdot c} \cdot \left(\frac{dQ_{\text{heater}}}{dt} - \frac{dQ_{\text{losses}}}{dt}\right)$$

M_{air} = mass of air inside the house

R_{eq} = equivalent thermal resistance of the house

Open the House subsystem.

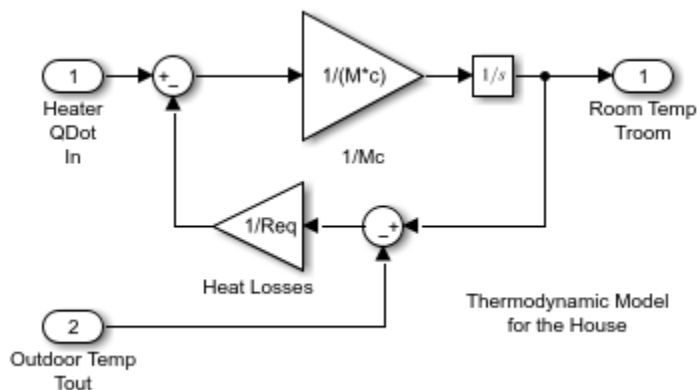

Model the Environment

To simulate the environment, the model uses a heat sink with infinite heat capacity and time varying temperature, T_{out} . The constant block Avg Outdoor Temp specifies the average air temperature outdoors. The Daily Temp Variation Sine Wave block generates daily outdoor temperature fluctuations. You can vary these parameters and to see how they affect the heating costs.

Run Simulation and Visualize Results

Run the simulation. Use the PlotResults scope to visualize the results. The scope plots the heat cost and indoor versus outdoor temperatures. The temperature outdoor varies sinusoidally. The indoors temperature remains within 5 °C of the Set Point. The Time axis is in hours.

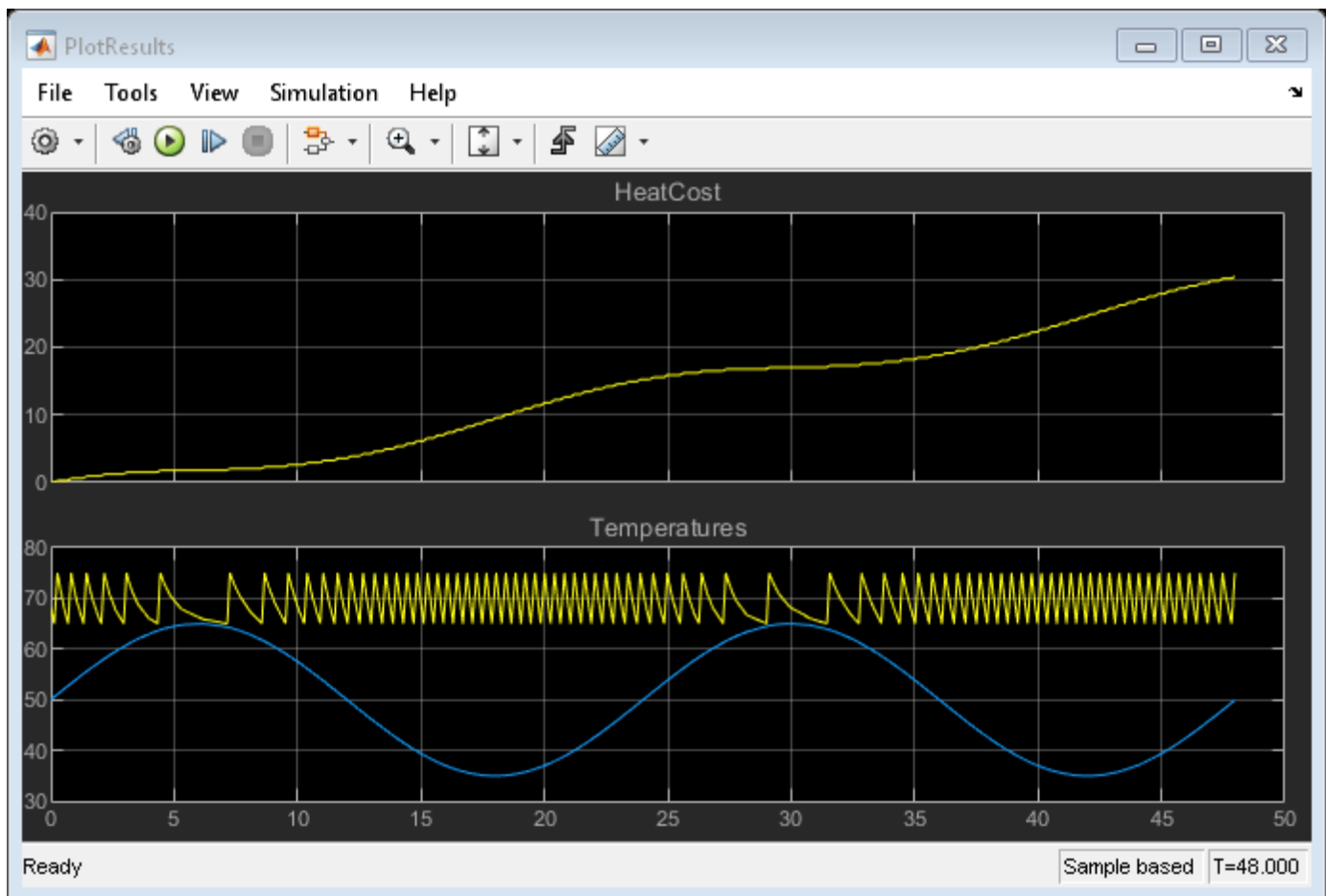

According to this model, it would cost about \$30 to heat the house for two days. Try varying the parameters and observe the system response.

Next Steps

This model calculates the heating costs only. If the temperature of the outside air is higher than the room temperature, the room temperature will exceed the desired Set Point.

You can modify this model to include an air conditioner. You can implement the air conditioner as a modified heater. To do this, add parameters like the following to `sldemo_househeat_data.m`.

- Cold air output
- Temperature of the stream from the air conditioner
- Air conditioner efficiency

To control both the air conditioner and the heater, modify the thermostat.

See Also

Sine Wave | Sine Wave Function

More About

- “Run Parallel Simulations for a Thermal Model of a House Using parsim”

Approximating Nonlinear Relationships: Type S Thermocouple

This example shows how to approximate nonlinear relationships of a type S thermocouple.

Thermocouple Modeling and Signal Conversion

The thermocouple is one of the popular analog transducers today, along with other devices such as position sensors, strain gages, pressure transducers, and resistance temperature devices (RTDs). Operating under the principle of the Seebeck effect (a.k.a. thermoelectric effect), thermocouples have an empirically determined nonlinear behavior that is well known over each junction type's useful operating range. If you run the model, you will be able to see the cumulative effect of each component on dynamic measurement accuracy. This example will focus on models for each of these components in a dynamic temperature measurement system for a Type S (Platinum-10% Rhodium(+)) versus Platinum(-) : a thermocouple device and probe assembly, a signal conditioning method, an analog to digital converter (ADC), and a software specification for converting the ADC output into a temperature value. An additional section shows how to obtain and use standard NIST ITS-90 thermocouple data with Simulink® models. Look-up tables and a polynomial block are used in this design to capture the nonlinear behavior of the thermocouple. Note that the polynomial block is a viable alternative to look-up tables for some applications, minimizing ROM usage at the cost of some additional computation for the full polynomial representation.

```
open_system('sldemo_tc')
```

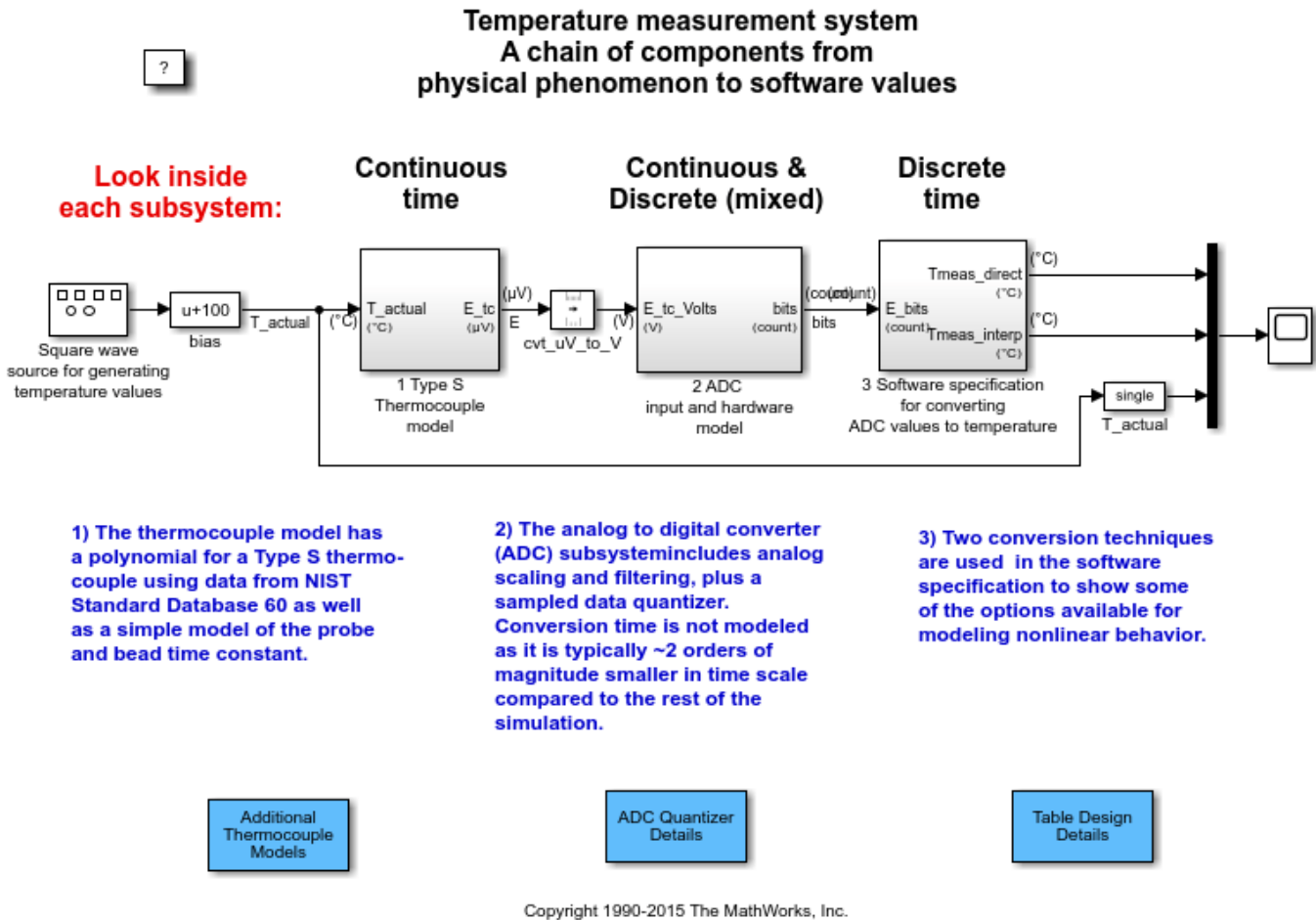

Figure 1: Temperature measurement system: a chain of components from physical phenomenon to software values

Simulating the Thermocouple Signal

The two main features of the thermocouple model are the probe and bead dynamics and the thermocouple's conversion of temperature into a millivolt signal. The probe+bead dynamics are modeled as a 30 msec first order system, and the nonlinear thermocouple behavior is modeled using the segment 1 polynomial data from NIST Standard Database 60 for a Type S thermocouple from -50 to 1063 degC. For numerical stability, the coefficients were scaled to return microvolts from the polynomial block. The output of the 1 Type S Thermocouple model subsystem is then converted to volts with a Unit Conversion block. Note that units are specified on the subsystem input and output ports and displayed on the subsystem icons. To learn more about units, see "Unit Specification in Simulink Models".

An alternative implementation to using the polynomial is an interpolated look-up table. Table data could be used in a look-up table block in place of the polynomial block. Sample data was constructed from NIST Standard Database 60 for a Type S thermocouple in file `sldemo_create_tc_tabledata.m`. Access to this database is described below in the section titled "Thermocouple Reference Data Download and Import Procedure".

Anti-Aliasing Filter and Analog to Digital Converter (ADC) Models

The ADC in this model expects a 0 to 5 volt signal, so the raw thermocouple sense voltage is biased and amplified corresponding to a range of -0.235 mV to 18.661 mV (-50 degC to 1765 degC). A third order Butterworth anti-aliasing filter was designed for $W_n = 15$ Hz using the Signal Processing Toolbox™:

```
[num,den] = butter(3, 15*2*pi, 'low', 's')
```

The output of the anti-aliasing filter feeds a sample-and-hold device that drives the quantization model. Since the sample period is 20 msec in this example, the conversion time is ignored as it is typically 2 orders of magnitude smaller for devices currently available. (Note: if the conversion time were an appreciable fraction of the sample period, it could not be ignored as it would significantly affect the system's dynamics.)

The quantization algorithm in the model takes in a 0 to 5 volt signal and outputs a 12-bit digital word in a 16-bit signed integer. A value of 0 corresponds to 0 Volts and a value of 4096 would correspond to 5 Volts. A change in the least significant bit (LSB) is about 1.2 mV. As 12 bits can only reach the value of 4095, the highest voltage that can be read by this device is approximately 4.9988 Volts. In order to have no more than 1/2 LSB error within the operating range, the quantizer changes values midway between each voltage point, resulting in a 1/2-width interval at 0 Volts and a 3/2-width interval just below 5 Volts. The last interval has 1 full LSB due to its 3/2-width size.

Understanding Data Converters

The `sldemo_adc_quantize` model allows you to explore the A/D converter component in more detail:

```
open_system('sldemo_adc_quantize')
```

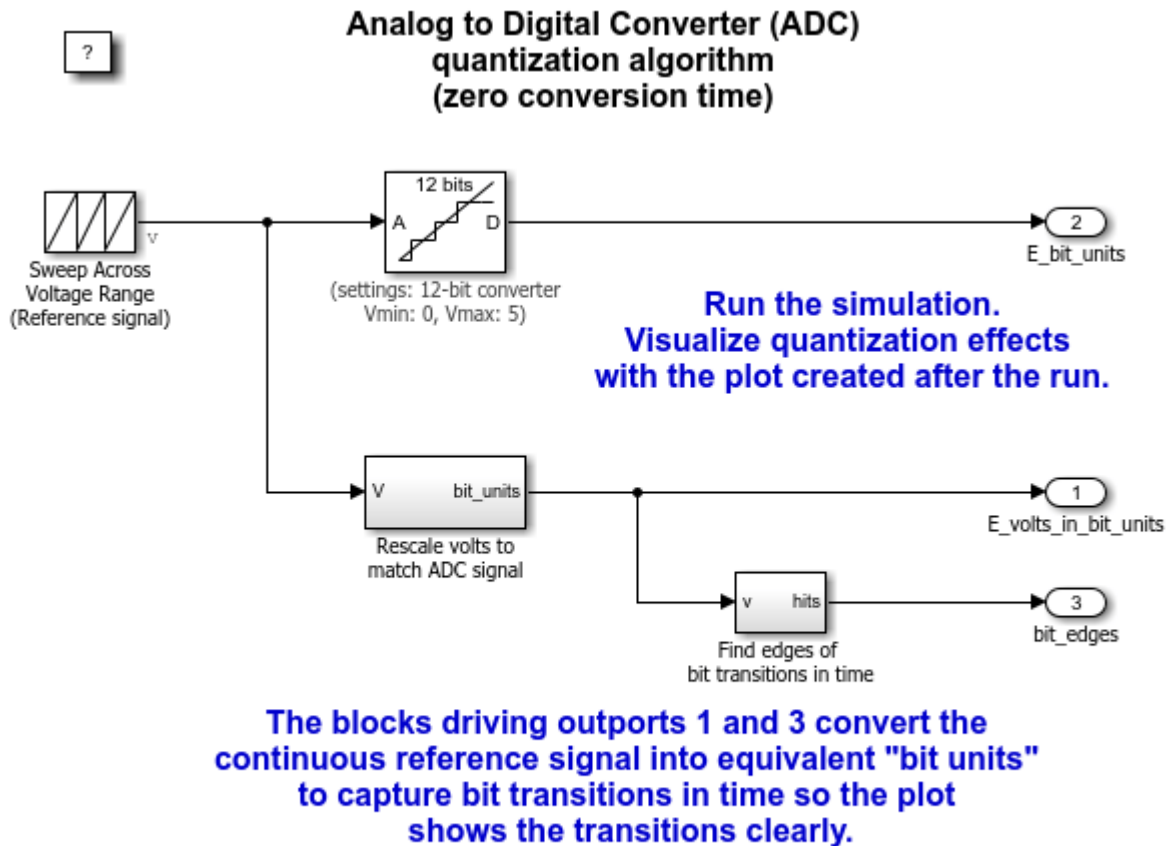

Copyright 1990-2013 The MathWorks, Inc.

Figure 2: Details of ADC quantization modeling (zero conversion time)

```
sim('sldemo_adc_quantize')
set(gcf, 'Color', [1, 1, 1]);
```

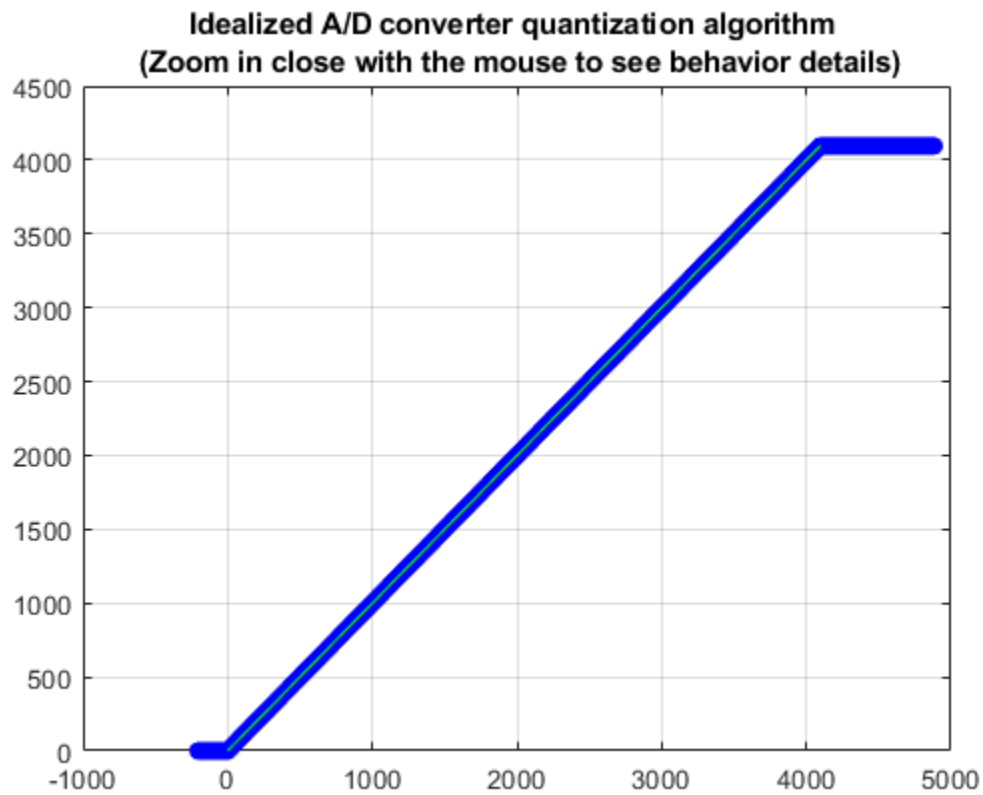

Figure 3: Quantization characteristic of ADC

```
ax = get(gcf, 'Children');  
set(ax(1), 'xlim', [4085, 4100]);
```

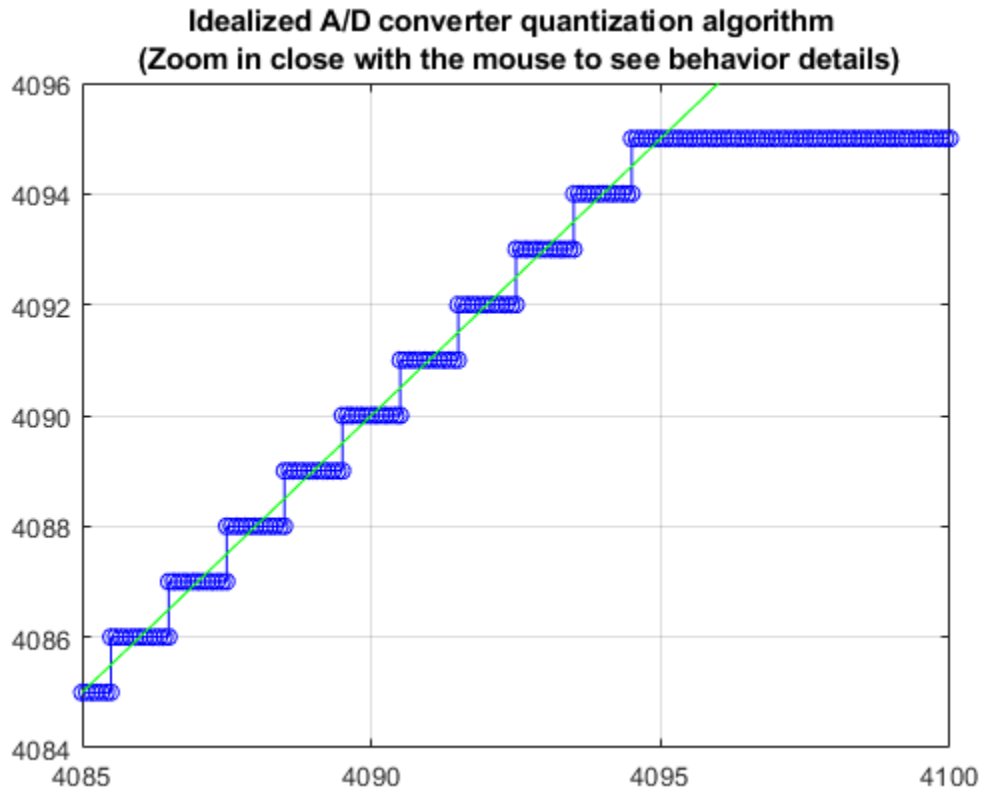

Figure 4: Quantization characteristic of ADC: zoomed in to top of range to reveal 1 LSB error behavior at high end (rest of range only has 1/2 LSB max error)

Software Specification for Converting ADC Output to Temperature Values

The input conversion subsystem requires a 16 bit unsigned integer input from the ADC whose full scale range is 0 to 4095 counts, corresponding to -0.235 mV and 18.6564 mV thermocouple loop voltage. The best accuracy and fastest algorithm for input conversion is a direct look-up table. Since the input is an integer from 0 to 4095, a table can be constructed that gives the thermocouple temperature corresponding to each possible input value, so the conversion process can be reduced to indexing into a table. This however, requires one number per ADC output value and for a 12-bit ADC, this can be a burden in memory constrained environments. For double precision data, this is a 16 kB ROM requirement. See file `sldemo_create_tc_tabledata.m` for the method used to construct the direct look-up table from the Type S thermocouple reference data. The error associated with this approach is entirely isolated to the table construction process as there is an output value associated with every possible input value - the run-time look-up process introduces no additional error.

An interpolated table was also put into the model, using only 664 bytes. This is a big reduction in ROM required compared to the direct table look-up, but it takes a bit longer to compute than an indirect memory access and introduces error into the measurement, which goes down as the number of points in the table increases.

```
open_system(sprintf('sldemo_tc/3 Software specification\nfor converting\nADC values to temperatur
```

Input: 0 to 4095 integer "counts" , where
0 counts corresponds to 0 input volts and -0.236 thermocouple millivolts
4096 counts corresponds to 5 input volts and 18.661 thermocouple millivolts

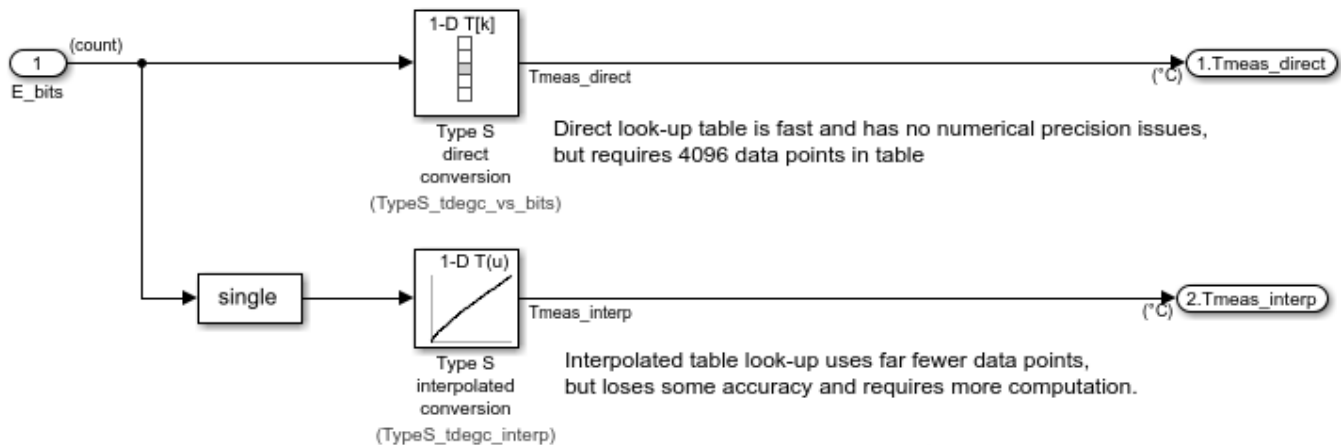

Tables derived from ITS-90 thermocouple reference data from NIST Standard Database 60 related to NIST Monograph 175 (ITS-90).

Thermocouple Reference Data Download and Import Procedure

Using the NIST ITS-90 Thermocouple Database (Standard Reference Database 60 from NIST Monograph 175), you can access the standard reference data describing the behavior for the eight standard thermocouple types. This database relates thermocouple output to the International Temperature Scale of 1990. Follow these steps to acquire and read in the data needed to fully exercise the support files included with this example:

1. Visit the NIST Standard database 60 site on the Internet and download the file all.tab to a local directory. This file is the one under the All Thermocouple Types hyperlink. After the download is complete, return to this page.
2. cd to the directory where you downloaded the all.tab thermocouple database
3. Parse the database and convert it to a MATLAB structure array using the conversion tool readstdtcdata.m:

```
tcddata = readstdtcdata('all.tab');
save thermocouple_its90.mat tcddata;
```

(tip: highlight the above MATLAB code and use right mouse menuitem "Evaluate Selection" to execute it)

You now have a complete set of temperature (T, degC) vs. voltage (E, mV) data, approximating polynomial coefficients, and inverse polynomial coefficients for the standard thermocouple types B, E, J, K, N, R, S, and T in the tcddata variable of file thermocouple_its90.mat. The MATLAB script in sldemo_create_tc_tabledata.m uses this data to prepare lookup table block parameters used in the example model.

Conditioning Reference Data for Use in a Look-Up Table

If you review the thermocouple data tables in the `tcdata` structure or in `all.tab`, you will probably notice a few things:

- Repeated 0 degC temperature points in the data
- Repeated voltage points in the data due to the 3-digit output format
- Non-monotonic behavior with two temperatures having the same output, e.g., for the Type B thermocouple, $T(E)$ won't work but $E(T)$ does work

The `readstdtcdata()` routine will remove the repeated 0 degC temperature points from the data, but the repeated voltages due to the data format and non-monotonic behavior of some of the curve ends must be dealt with on an individual basis. A reference model named `sldemo_tc_blocks` was constructed using `sldemo_tc_blocks_data.mat`. It contains look-up tables with data populated from the interpolating polynomials for the eight standard thermocouples in `all.tab`:

```
open_system('sldemo_tc_blocks')
```



Full-Range 2 degrees Celsius Interpolated Thermocouple Tables created from ITS-90 Interpolating Polynomials

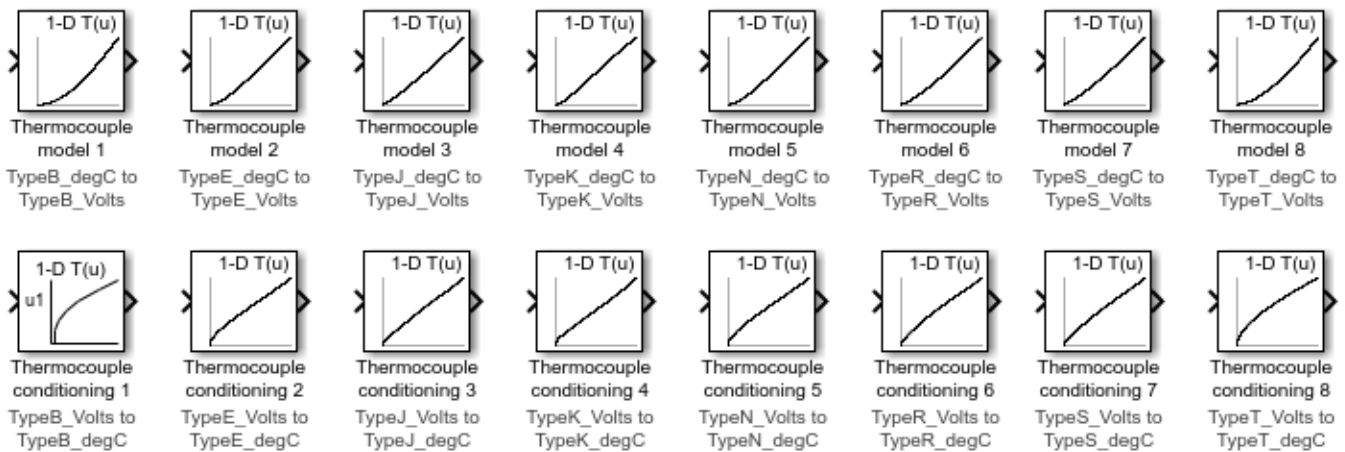

Note: this model has data in its Model Workspace. Browse/Edit the model workspace from the View / Model Explorer menu item.

**To use these blocks, load data into the model workspace or base workspace:
>> load sldemo_tc_blocks_data.mat**

Copyright 1990-2013 The MathWorks, Inc.

Figure 5: Full-Range 2 degrees Celsius Interpolated Thermocouple Tables created from ITS-90 Interpolating Polynomials

References

1. NIST ITS-90 Thermocouple Database

2. "Temperature-Electromotive Force Reference Functions and Tables for the Letter-Designated Thermocouple Types Based on the ITS-90". National Institute of Standards and Technology Monograph 175; 1993. 630 p.

3. The International Temperature Scale of 1990 (ITS-90), Consultative Committee for Thermometry (CCT) of the International Committee for Weights and Measures (CIPM)

4. Thermoelectric Effects in Metals: Thermocouples, S. O. Kasap 1997

NOTE: for determining empirical relationships of complex systems such as engines and for fitting models to measured data, MathWorks® offers the Model Based Calibration Toolbox which employs the Design of Experiments methodology for optimized table database creation, plus value extraction and automated table filling components.

Digital Waveform Generation: Approximating a Sine Wave

This example shows some of the main steps needed to design and evaluate a sine wave data table for use in digital waveform synthesis applications in embedded systems and arbitrary waveform generation instruments.

Real-Time direct digital synthesis of analog waveforms using embedded processors and digital signal processors (DSPs) connected to digital-to-analog converters (DACs) is becoming pervasive even in the smallest systems. Developing waveforms for use in embedded systems or laboratory instruments can be streamlined using the tight integration of MATLAB® and Simulink®. You can develop and analyze the waveform generation algorithm and its associated data at your desktop before implementing it with Simulink® Coder™ on target hardware.

When feasible, the most accurate way to digitally synthesize a sine wave is to compute the full precision $\sin()$ function directly for each time step, folding ωt into the interval 0 to 2π . In real-time systems, the computational burden is typically too large to permit this approach. One popular way around this obstacle is to use a table of values to approximate the behavior of the $\sin()$ function, either from 0 to 2π , or even half wave or quarter wave data to leverage symmetry.

Tradeoffs to consider include algorithm efficiency, data ROM size required, and accuracy/spectral purity of the implementation. Similar analysis is needed when performing your own waveform designs. The table data and look-up algorithm alone do not determine performance in the field. Additional considerations such as the accuracy and stability of the real-time clock, and digital to analog converter are also needed in order to assess overall performance. The Signal Processing Toolbox™ and the DSP System Toolbox™ complement the capabilities of MATLAB and Simulink for work in this area.

Another popular way to approximate the behavior of the sine wave is to use the CORDIC approximation method. CORDIC is an acronym for COordinate Rotation DIGital Computer. The Givens rotation-based CORDIC algorithm is one of the most hardware-efficient algorithms because it requires only shift-add iterative operations.

If you have a Fixed-Point Designer license, then you can see “Compute Sine and Cosine Using CORDIC Rotation Kernel” (Fixed-Point Designer) for an example on CORDIC approximation.

The distortion analysis in this example is based on principles presented in "Digital Sine-Wave Synthesis Using the DSP56001/DSP56002", by Andreas Chrysafis, Motorola® Inc. 1988

Create a Table in Double Precision Floating Point

The following commands make a 256 point sine wave and measure its total harmonic distortion when sampled first on the points and then by jumping with a delta of 2.5 points per step using linear interpolation. Similar computations are done by replacing the sine values with CORDIC sine approximation. For frequency-based applications, spectral purity can be more important than absolute error in the table.

The file `ssinthd.m` is the core function in this example. It is used for calculating total harmonic distortion (THD) for digital sine wave generation with or without interpolation. This THD algorithm proceeds over an integral number of waves to achieve accurate results. The number of wave cycles used is A . Since the step size 'delta' is A/B and traversing A waves will hit all points in the table at least one time, which is needed to accurately find the average THD across a full cycle.

The relationship used to calculate THD is:

$$\text{THD} = (\text{ET} - \text{EF}) / \text{ET}$$

where ET = total energy, and EF = fundamental energy

The energy difference between ET and EF is spurious energy.

```
N      = 256;
angle = 2*pi * (0:(N-1))/N;

s      = sin( angle )';
thd_ref_1 = ssinthd( s, 1, N, 1, 'direct' )
thd_ref_2p5 = ssinthd( s, 5/2, 2*N, 5, 'linear' )

cs     = cordicsin( angle, 50 )';
thd_ref_1c = ssinthd(cs, 1, N, 1, 'direct' )
thd_ref_2p5c = ssinthd(cs, 5/2, 2*N, 5, 'linear' )
```

```
thd_ref_1 =
    4.8049e-32
```

```
thd_ref_2p5 =
    1.4176e-09
```

```
thd_ref_1c =
    1.2577e-30
```

```
thd_ref_2p5c =
    1.4176e-09
```

Put the Sine Wave Approximations in a Model

You can put the sine wave designed above into a Simulink model and see how it works as a direct lookup, with linear interpolation, and with CORDIC approximation. This model compares the output of the floating point tables to the `sin()` function. As expected from the THD calculations, the linear interpolation has a lower error than the direct table lookup in comparison to the `sin()` function. The CORDIC approximation shows a lower error margin when compared to the linear interpolation method. This margin depends on the number of iterations when computing the CORDIC sin approximation. You can typically achieve greater accuracy by increasing the number of iterations (corresponding to a longer computation time). The CORDIC approximation eliminates the need for explicit multipliers. It is used when multipliers are less efficient or non-existent in hardware.

Open the `sldemo_tonegen` model

```
open_system('sldemo_tonegen');
set_param('sldemo_tonegen', 'StopFcn', '');
out = sim('sldemo_tonegen');
currentFig = figure('Color',[1,1,1]);
subplot(3,1,1), plot(out.tonegenOut.time, out.tonegenOut.signals(1).values); grid
title({'Difference between direct look-up', 'and reference signal'});
```

```
subplot(3,1,2), plot(out.tonegenOut.time, out.tonegenOut.signals(2).values); grid
title({'Difference between interpolated look-up', 'and reference signal'});
subplot(3,1,3), plot(out.tonegenOut.time, out.tonegenOut.signals(3).values); grid
title({'Difference between CORDIC sine', 'and reference signal'});
```

Comparison in approximate sine wave accuracy between direct look-up, linear interpolation and CORDIC approximation vs. reference signal

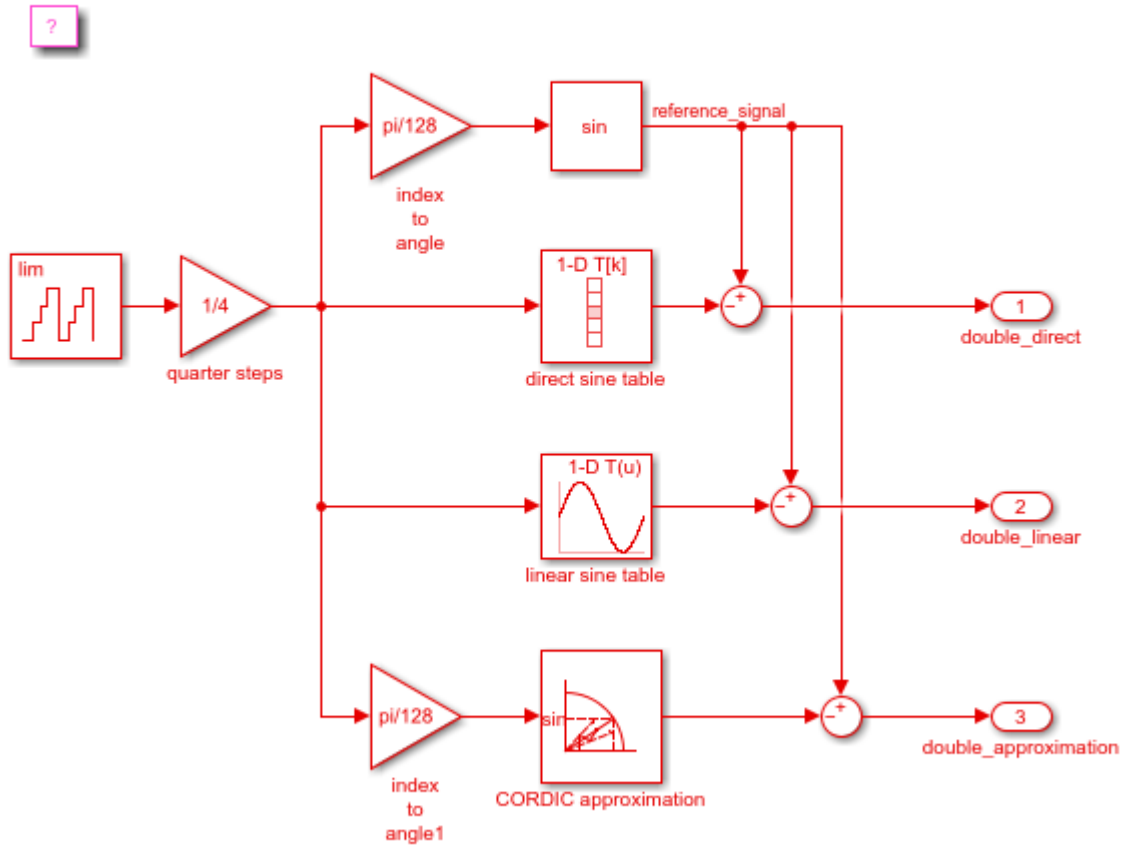

Copyright 1990-2013 The MathWorks, Inc.

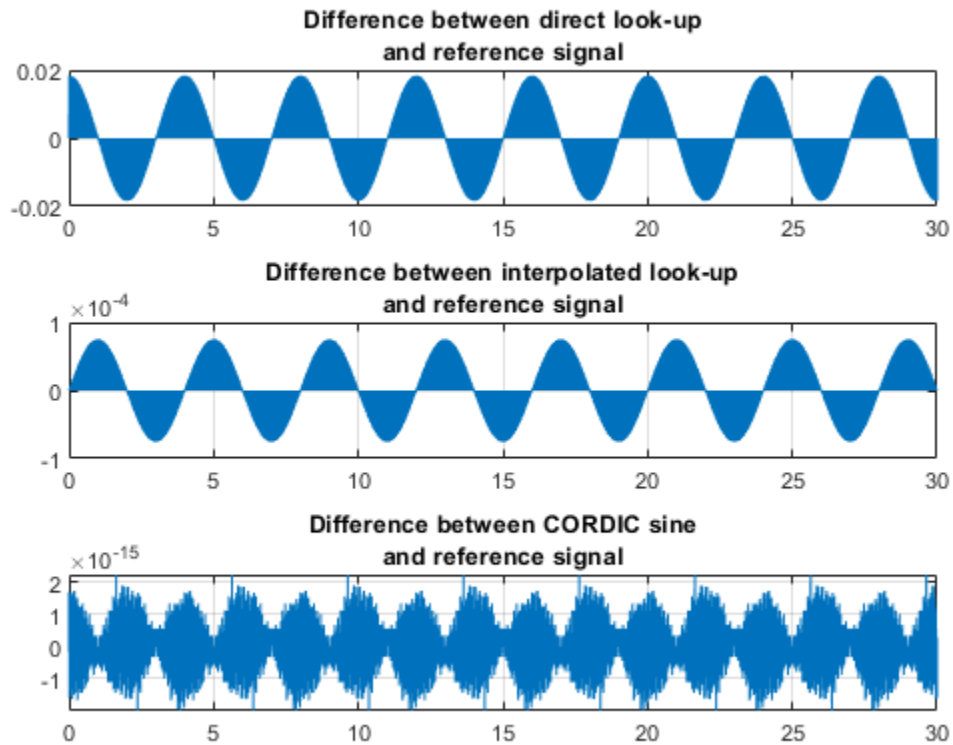

Taking a Closer Look at Waveform Accuracy

Zooming in on the signals between 4.8 and 5.2 seconds of simulation time (for example), you can see a different characteristic due to the different algorithms used:

```
ax = get(currentFig, 'Children');  
set(ax(3), 'xlim', [4.8, 5.2])  
set(ax(2), 'xlim', [4.8, 5.2])  
set(ax(1), 'xlim', [4.8, 5.2])
```

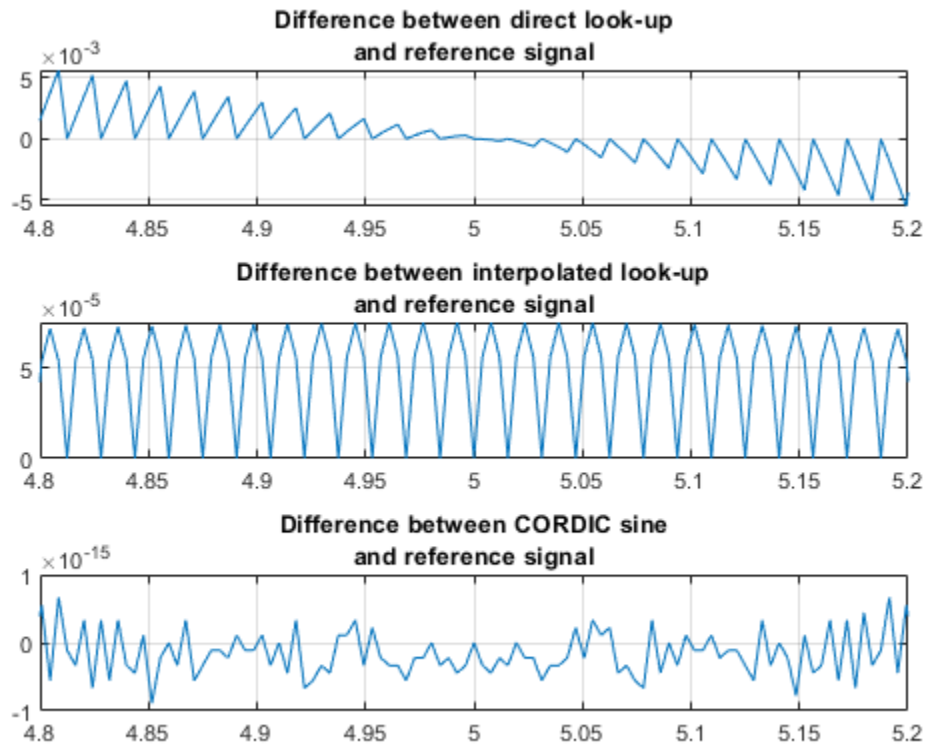

The Same Table, Implemented in Fixed Point

Now convert the floating point table into a 24 bit fractional number using 'nearest' rounding. The new table is tested for total harmonic distortion in direct lookup mode at 1, 2, and 3 points per step, then with fixed point linear interpolation.

```
bits = 24;
is = num2fixpt( s, sfrac(bits), [], 'Nearest', 'on');

thd_direct1 = ssinthd(is, 1, N, 1, 'direct')
thd_direct2 = ssinthd(is, 2, N, 2, 'direct')
thd_direct3 = ssinthd(is, 3, N, 3, 'direct')

thd_linterp_2p5 = ssinthd(is, 5/2, 2*N, 5, 'fixptlinear')

thd_direct1 =
    2.6423e-15

thd_direct2 =
    2.8660e-15

thd_direct3 =
```

```
2.6423e-15

thd_linterp_2p5 =
1.4175e-09
```

Compare Results for Different Tables and Methods

Choosing a table step rate of 8.25 points per step (33/4), jump through the double precision and fixed point tables in both direct and linear modes and compare distortion results:

```
thd_double_direct = ssinthd( s, 33/4, 4*N, 33, 'direct')
thd_sfrac24_direct = ssinthd(is, 33/4, 4*N, 33, 'direct')

thd_double_linear = ssinthd( s, 33/4, 4*N, 33, 'linear')
thd_sfrac24_linear = ssinthd(is, 33/4, 4*N, 33, 'fixptlinear')
```

```
thd_double_direct =
4.7061e-05
```

```
thd_sfrac24_direct =
4.7061e-05
```

```
thd_double_linear =
7.9741e-10
```

```
thd_sfrac24_linear =
8.1751e-10
```

Using Preconfigured Sine Wave Blocks

Simulink also includes a Sine Wave source block with continuous and discrete modes, plus fixed point Sin and Cosine function blocks that implement the function approximation with a linearly interpolated lookup table that exploits the quarter wave symmetry of sine and cosine. Example `sldemo_tonegen_fixpt` uses a sampled sine wave source as the reference signal and compares it with a lookup table with or without interpolation, and with CORDIC sine approximation in fixed point data types.

Open the `sldemo_tonegen_fixpt` model

```
open_system('sldemo_tonegen_fixpt');
set_param('sldemo_tonegen_fixpt', 'StopFcn', '');
out = sim('sldemo_tonegen_fixpt');
figure('Color', [1,1,1]);
subplot(3,1,1), plot(out.tonegenOut.time, out.tonegenOut.signals(1).values); grid
title({'Difference between direct look-up', 'and reference signal'});
subplot(3,1,2), plot(out.tonegenOut.time, out.tonegenOut.signals(2).values); grid
```



```

title({'Difference between interpolated look-up', 'and reference signal'});
subplot(3,1,3), plot(out.tonegenOut.time, out.tonegenOut.signals(3).values); grid
title({'Difference between CORDIC sine', 'and reference signal'});
    
```

Additional blocks to calculate sine and approximate sine using various algorithms.

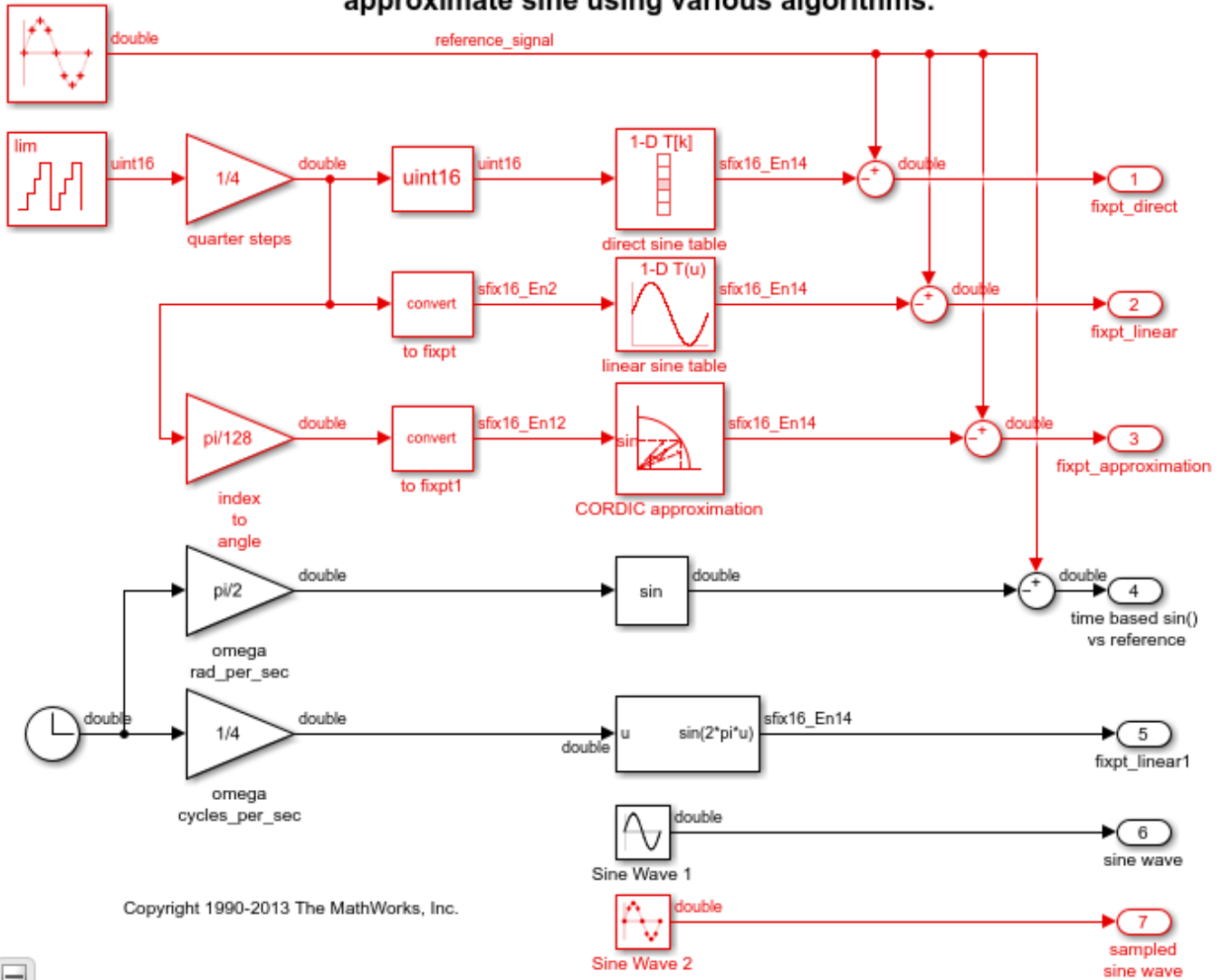

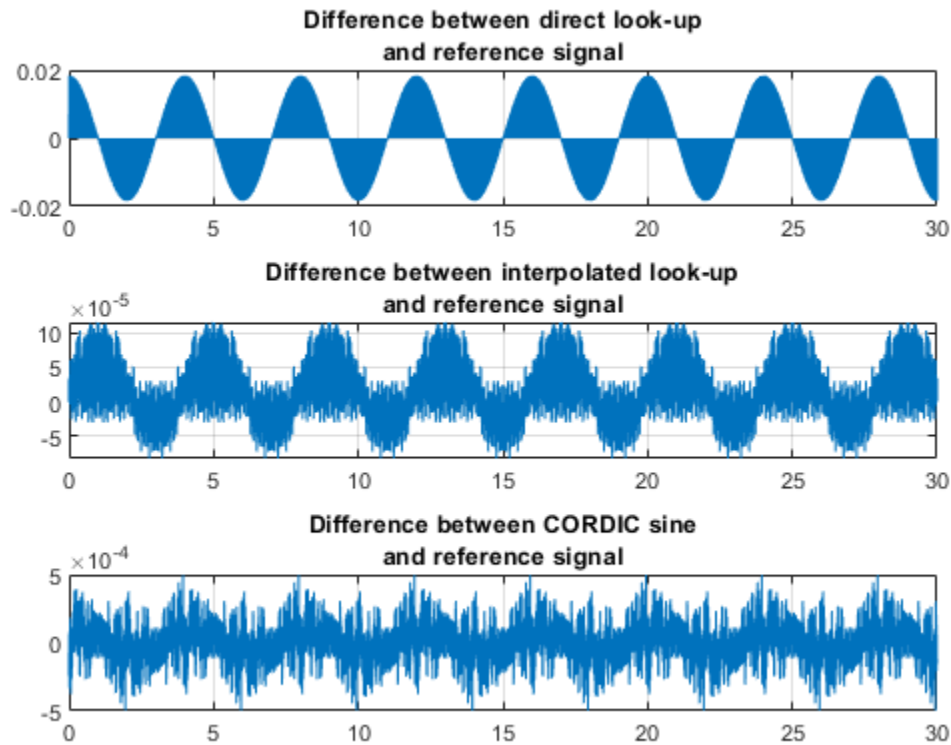

Use of Sine Function with a Clock Input

The model also compares the sine wave source reference with the `sin()` function whose input angle in radians is time based (computed using a clock). This section tests the assumption that the clock input would return repeatable results from the `sin()` function for period 2π . The following plot shows that the `sin()` function accumulates error when its input is time based. This also shows that a sampled sine wave source is more accurate to use as a waveform generator.

```
subplot(1,1,1), plot(out.tonegenOut.time, out.tonegenOut.signals(4).values); grid
title({'Difference between time based sin()', 'and reference signal'});
```

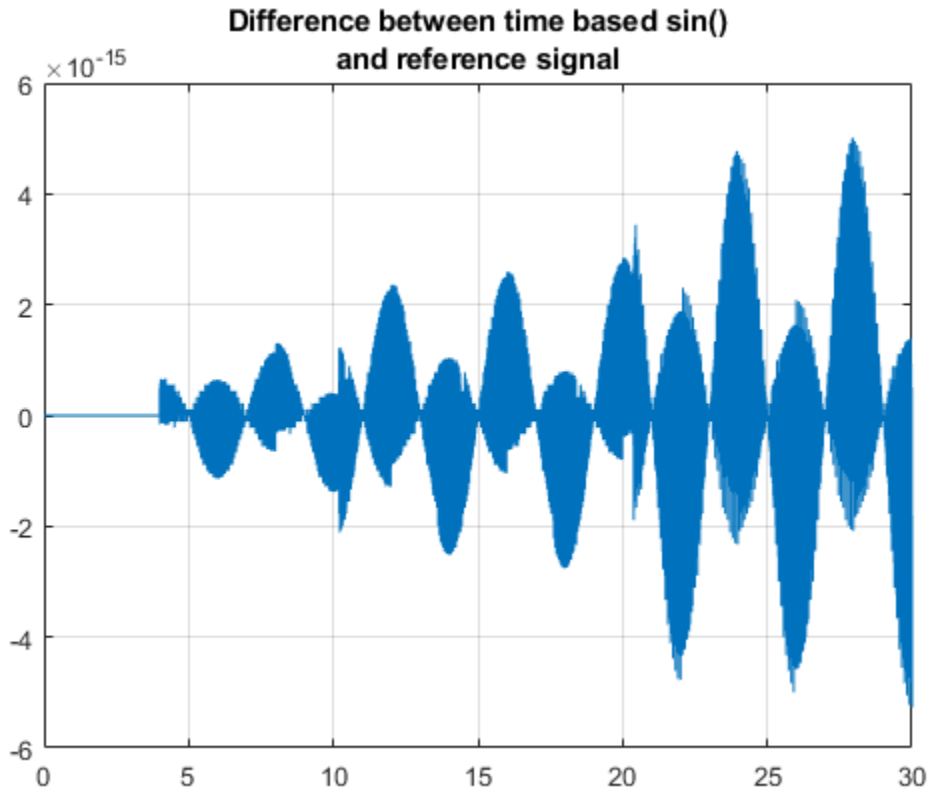

Survey of Behavior for Direct Lookup and Linear Interpolation

The file `sldemo_sweeptable_thd.m` performs a full frequency sweep of the fixed point tables and will let us more thoroughly understand the behavior of this design. Total harmonic distortion of the 24-bit fractional fixed point table is measured at each step size, moving through it D points at a time, where D is a number from 1 to $N/2$, incrementing by 0.25 points. N is 256 points in this example; the 1, 2, 2.5, and 3 cases were done above. Frequency is discrete and therefore a function of the sample rate.

Notice the modes of the distortion behavior in the plot. They match with common sense: when retrieving from the table precisely at a point, the error is smallest; linear interpolation has a smaller error than direct lookup in between points. What is not intuitive is that the error is relatively constant for each of the modes up to the Nyquist frequency.

```
figure('Color',[1,1,1])
tic, sldemo_sweeptable_thd(24, 256), toc
```

Elapsed time is 0.916413 seconds.

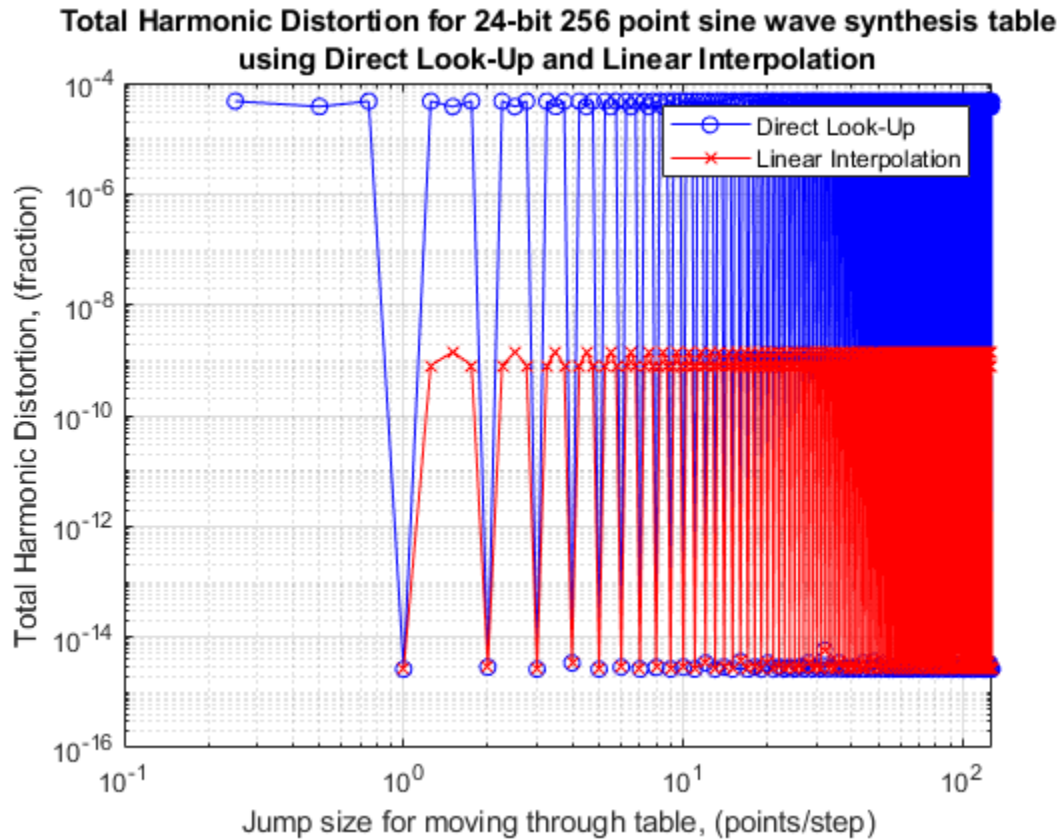

Next Steps

To take this example further, try different table precision and element counts to see the effect of each. Using CORDIC approximation, try different numbers of iterations to see the effects on accuracy and computation time. You can investigate different implementation options for waveform synthesis algorithms using automatic code generation available from the Simulink Coder and production code generation using Embedded Coder™. Embedded Target products offer direct connections to a variety of real-time processors and DSPs, including connection back to the Simulink diagram while the target is running in real-time. The Signal Processing Toolbox and DSP System Toolbox offer prepackaged capabilities for designing and implementing a wide variety of sample-based and frame-based signal processing systems with MATLAB and Simulink.

```
bdclose('sldemo_tonegen');
bdclose('sldemo_tonegen_fixpt')
```

Accurate Zero-Crossing Detection

This example shows how zero crossings work in Simulink®. In this model, three shifted sine waves are fed into an absolute value block and saturation block. At exactly $t = 5$, the output of the switch block changes from the absolute value to the saturation block. Zero crossings in Simulink will automatically detect exactly when the switch block changes its output, and the solver will step to the exact time that the event happens. This can be seen by examining the output in the scope.

? Zero-Crossing Detection Demonstration

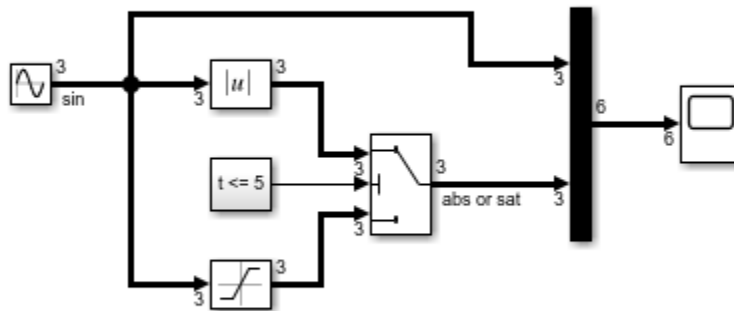

Copyright 1990-2013 The MathWorks, Inc.

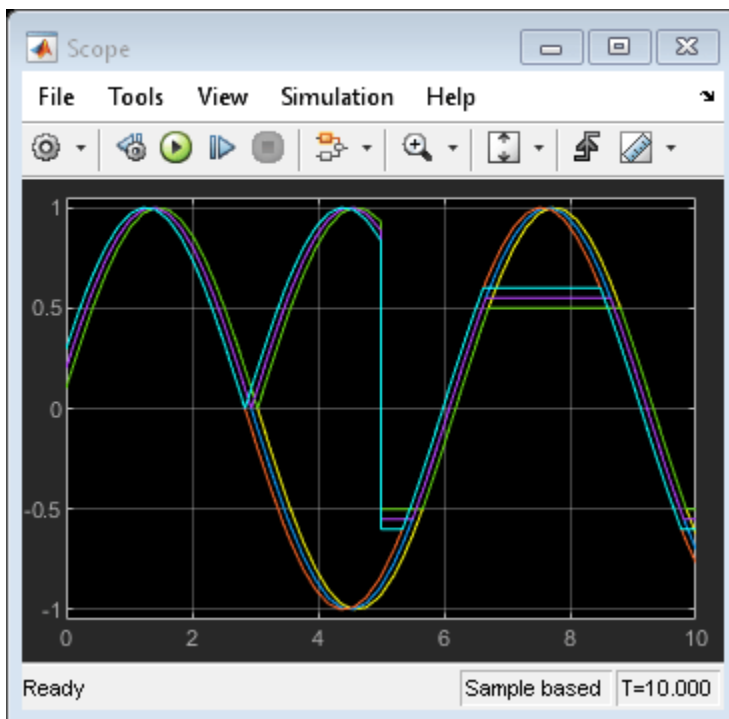

Spiral Galaxy Formation Simulation Using MATLAB Function Blocks

This model was inspired by the classic paper "Galactic Bridges and Tails" (Toomre & Toomre 1972). The original paper explained how disc shaped galaxies could develop spiral arms. Two disc shape galaxies originally are far apart. They then fly by each other and almost collide. Once the galaxies are close enough, mutual gravitational forces cause spiral arms to form.

Except for the "PlotAll" visualization block's use of plotting routines, all MATLAB® function blocks in this model support code generation with Simulink® Coder™ and Embedded Coder™.

- Requirements:** For this example, Simulink® generates code for the simulation in a Simulink project directory created in the current working directory (pwd). If you do not want to affect the current directory (or if you cannot generate files in this directory), you should change your working directory.

Opening the Model and Running the Simulation

Open the model and run the simulation by executing the code below. If you are using MATLAB® Help, select the code you want to execute and press F9 (or select code, right click on selection and select "Evaluate Selection"). The Simulink model will load, compile, and run.

```
model = 'sldemo_eml_galaxy';
open_system(model);
sim(model);
```

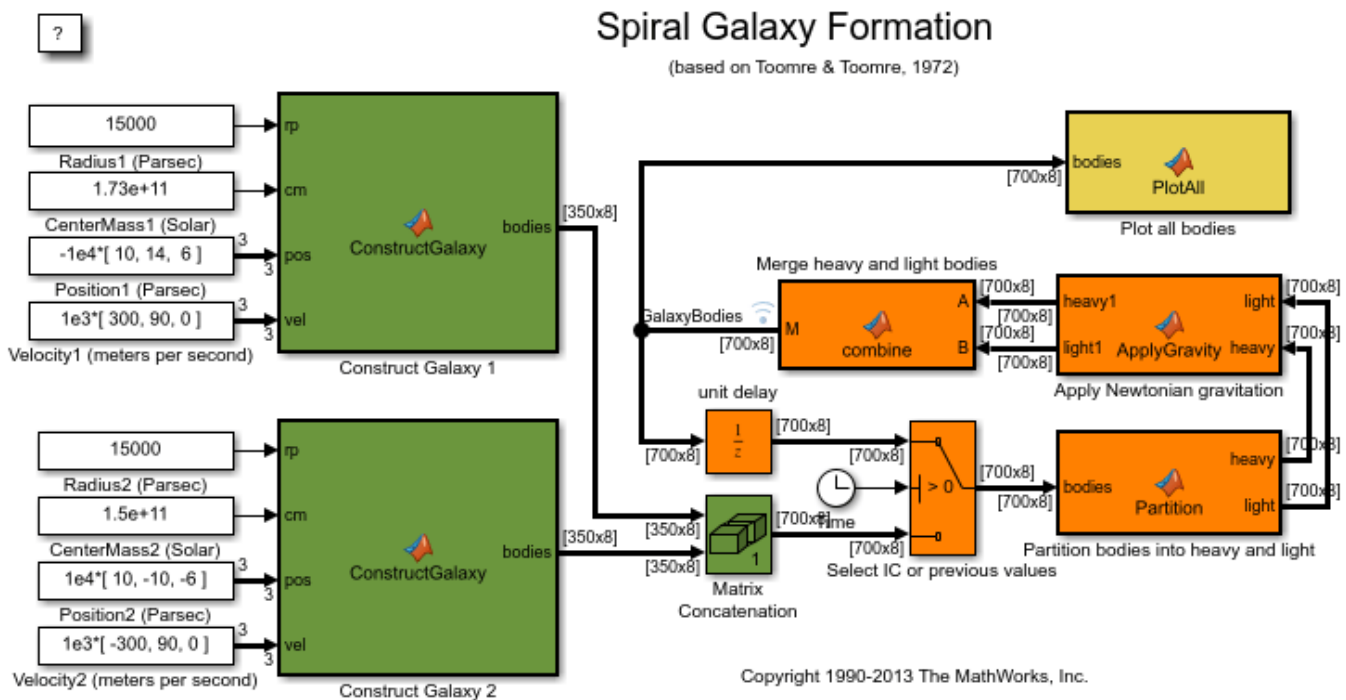



Model Description

This section describes the model in detail and explains the role of each block in the model. The green blocks initialize the simulation, the orange blocks are the core of the simulation, and the yellow block makes the galaxy animation view.

Initial Conditions

The model requires initial conditions for each galaxy. The initial conditions are: galaxy radius in parsecs (r_p), galaxy mass in solar mass units (m), galaxy position in parsecs (pos), and galaxy velocity in m/s (vel).

In the model, constant blocks specify the initial conditions. The initial conditions have been chosen such that the galaxies will nearly collide at some point in time.

"ConstructGalaxy" Blocks

The initial conditions are passed to the MATLAB function blocks Construct Galaxy 1 and Construct Galaxy 2. These MATLAB function blocks contain MATLAB code that builds the galaxy models.

In a typical galaxy, most of the mass is concentrated in its center as a super-massive black hole and/or star agglomeration. We model the galaxy as a disc with radius r with most of its mass concentrated in the inner circle of radius $r/3$. In addition to this super-massive nucleus, the "ConstructGalaxy" MATLAB function block creates 349 random stars with masses ranging from 4 to 24 solar masses. These stars are randomly positioned within distance $r/3$ and r from the center of the galaxy. The stars initially move in circular orbits around the galaxy core. Every object (star or galaxy core) has mass, position (x, y, z), and velocity (V_x, V_y, V_z).

"Matrix Concatenation" Block

This block joins information about both galaxies. At this point the model has 700 objects: 1 core for each galaxy and 349 stars around each core. These 700 objects interact according to Newtonian mechanics.

"Partition" Block

This MATLAB function block separates all 700 objects into two groups: heavy bodies and light bodies. The heavy bodies are the galaxy cores. The light bodies are the stars. Because the galaxy cores are much heavier than individual stars, the model will consider only the heavy-heavy and heavy-light interactions. We can ignore the light-light body interactions. This will save a lot of time since 698 out of 700 bodies in the model are light.

"ApplyGravity" Block

This MATLAB function block uses Newtonian mechanics to compute the velocities and positions of the bodies at each step. The "combine" block is also a MATLAB function block. It merges the data about heavy and light objects together.

"PlotAll" Block

This MATLAB function block plots the bodies in a figure and updates the position of each star at every step in the simulation.

Closing the Model

Close the model without saving any changes. Clear data generated by simulation/example.

```
close_system(model,0);  
clear model sldemo_eml_galaxy_output;
```

Note:

- In this model, signal logging is turned on (observe that the 'GalaxyBodies' signal has a little blue signal logging antenna on it). The model saves output data in a `Dataset` object. Any other data is saved/modified in the model workspace to avoid cluttering the MATLAB workspace.
- To modify signal logging settings, right-click on the signal line and select "Signal Properties". In this example, the signal name is 'GalaxyBodies' and the "Log signal data" checkbox is checked.
- The logged data is saved to the MATLAB workspace as a `Dataset` object with the name 'sldemo_eml_galaxy_output'. Information on the 'GalaxyBodies' signal can be retrieved from this object by typing `sldemo_eml_galaxy_output.get('GalaxyBodies')` which returns a `Simulink.SimulationData.Signal` object. See more about working with these objects in the "Simulink.SimulationData.Signal" documentation.

Comments About the Model

Despite its simplicity, this model provides insight into how our own galaxy evolved. This example allows the user to maximally simplify the model and run a fast simulation. The user can easily modify this example by adding more galaxies.

References

Toomre, Alar; Toomre, Juri; "Galactic Bridges and Tails"; Astrophysical Journal, Vol. 178, pp. 623-666 (1972); 12/1972;

Counters Using Conditionally Executed Subsystems

This model shows the contrast between enabled subsystems and triggered subsystems for the same control signal, through the use of counter circuits. After running the simulation, the scope shows three plots.

The first of these plots shows the control signal which is the output of the discrete pulse generator.

The second plot shows the output of the counter circuit in the enabled subsystem. The counter increments while the subsystem is enabled and then holds its output when the subsystem is disabled. The counter resets to zero when the subsystem is re-enabled because the enable port was configured to reset states when enabling.

The third plot shows the output of the counter circuit in the triggered subsystem. The counter increments every rising edge of the control signal.

The signals are shown in a Signal Viewer scope that does not require a scope block to be put into the block diagram. Instead, the "scope" icon notation on the ports show that a Signal Viewer is attached. Double click on the scope icon to make the Signal Viewer appear if it is hidden.

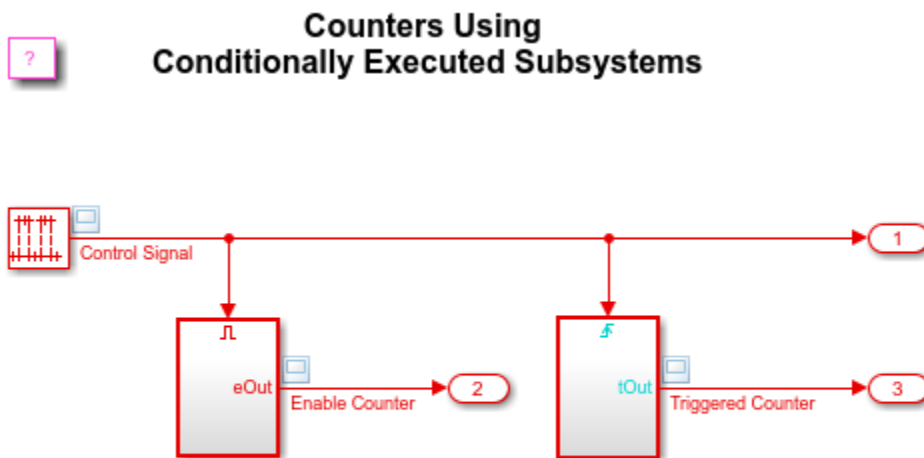

Copyright 1990-2014 The MathWorks, Inc.

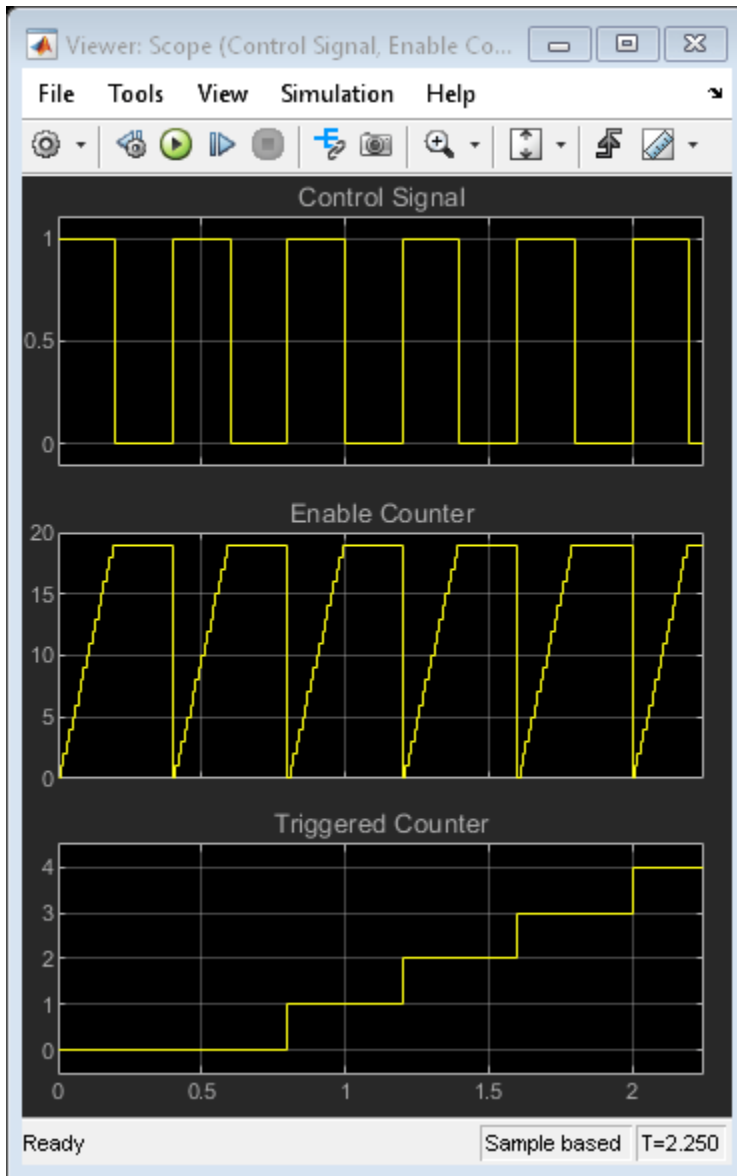

Friction Model with Hard Stops

This example shows how to model friction one way in Simulink®. The two integrators in the model calculate the velocity and position of the system, which is then used in the Friction Model to calculate the friction force.

Running the simulation shows the initial condition response on the Scope.

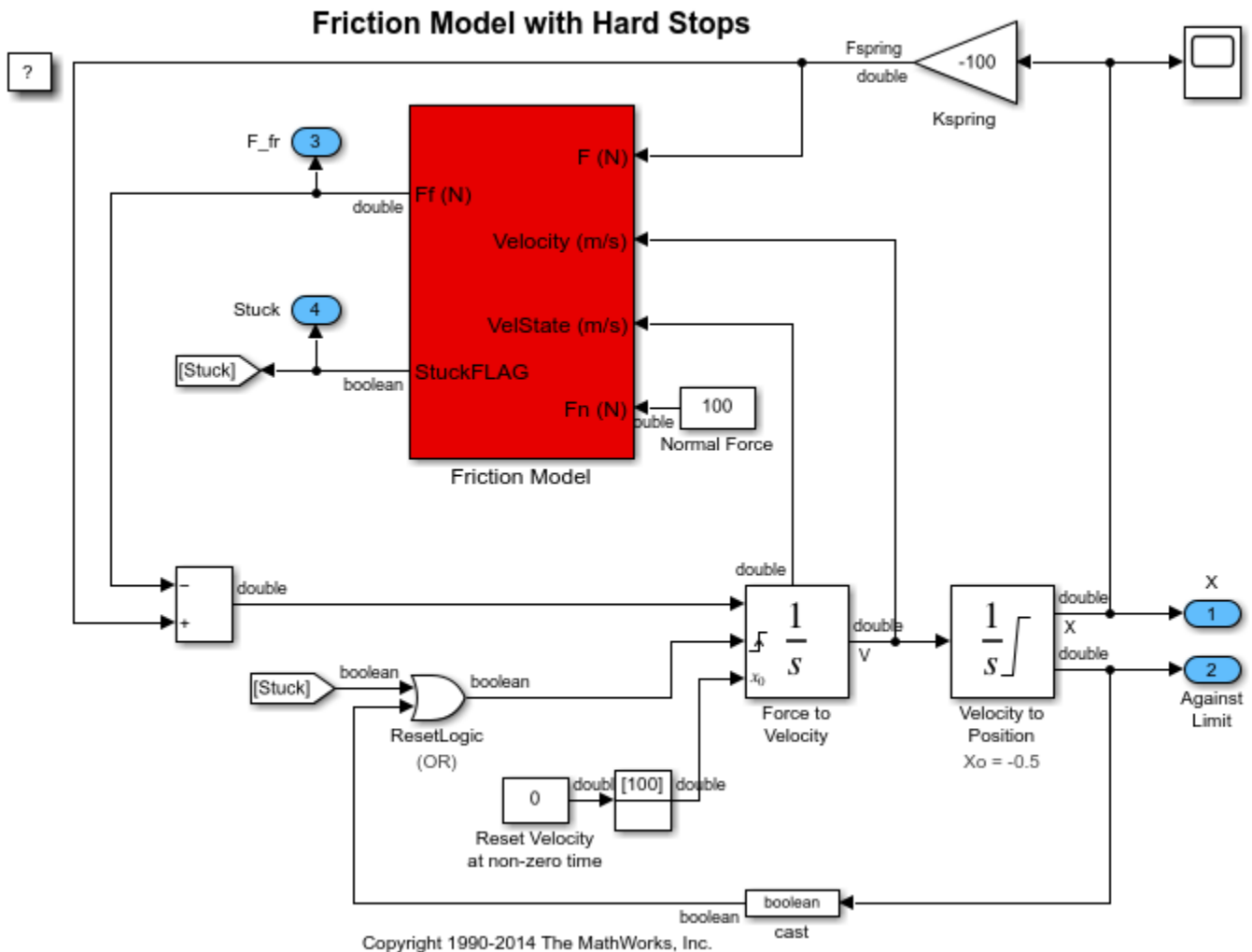

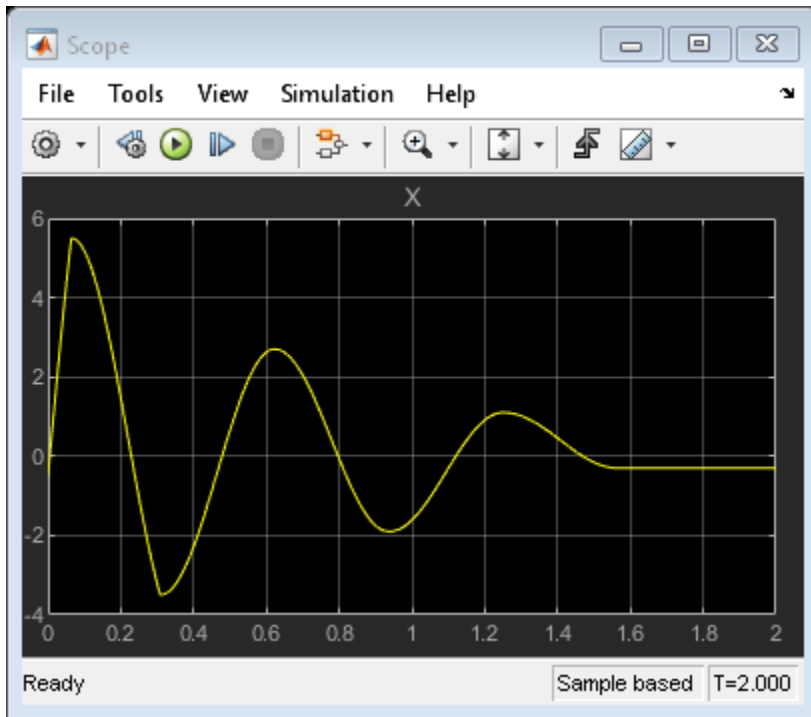

State Events

This example shows how to handle state events. Run the simulation and see the phase plane plot, where the state x_1 is along the X-axis and the state x_2 is along the Y-axis.



State-Event Handling

(For more information, double click on the "?" or open the Model Explorer)

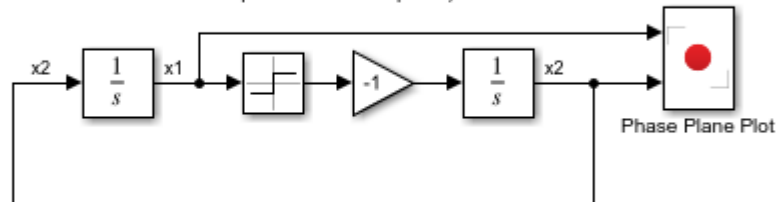

Example courtesy of James H. Taylor,
Dept. of Elec Engr., UNB

Copyright 1990-2019 The MathWorks, Inc.

Bang-Bang Control Using Temporal Logic

This example shows how to use Stateflow® to model a bang-bang temperature control system for a boiler. The boiler dynamics are modeled in Simulink®.

The Bang-Bang Controller Stateflow chart shows how to use functions and Subcharts within Stateflow.

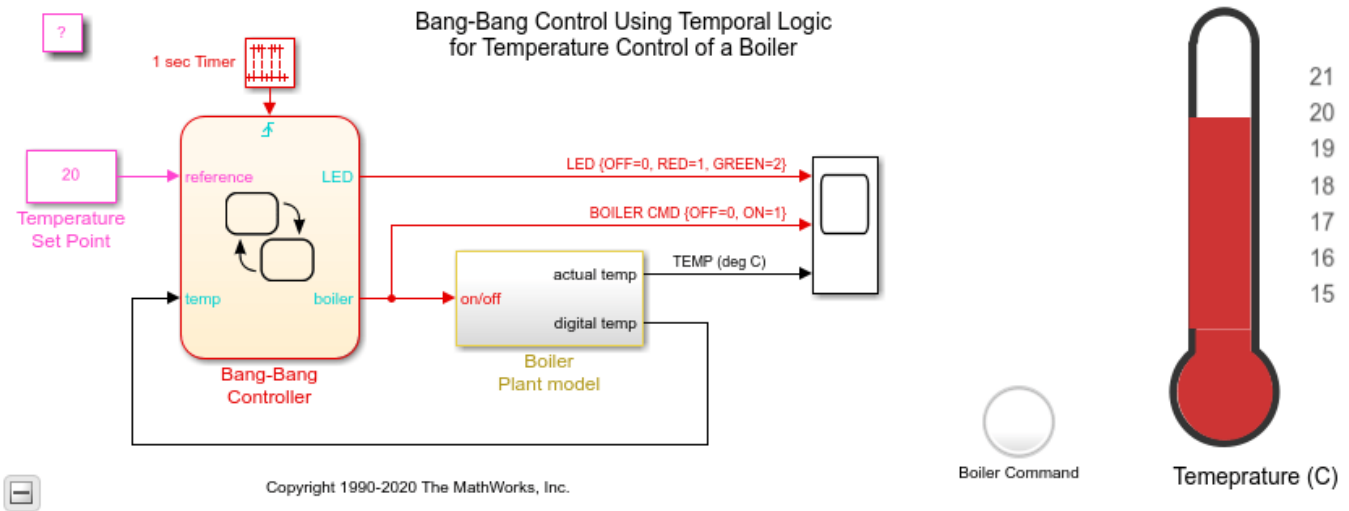

See Also

Lamp | Vertical Gauge

More About

- “Decide How to Visualize Simulation Data”
- “Tune and Visualize Your Model with Dashboard Blocks”

Inverted Pendulum with Animation

This example shows how to model an inverted pendulum. The animation is created using MATLAB® Handle Graphics®. The animation block is a masked S-function. For more information, use the context menu to look under the Animation block's mask and open the S-function for editing.

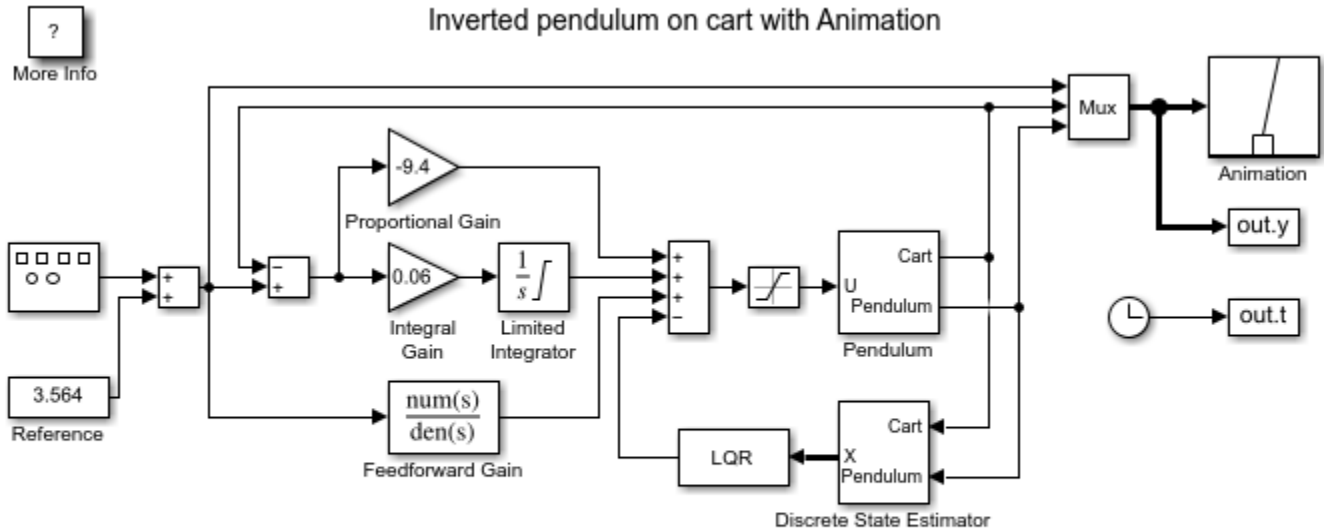

Copyright 1990-2015 The MathWorks, Inc.

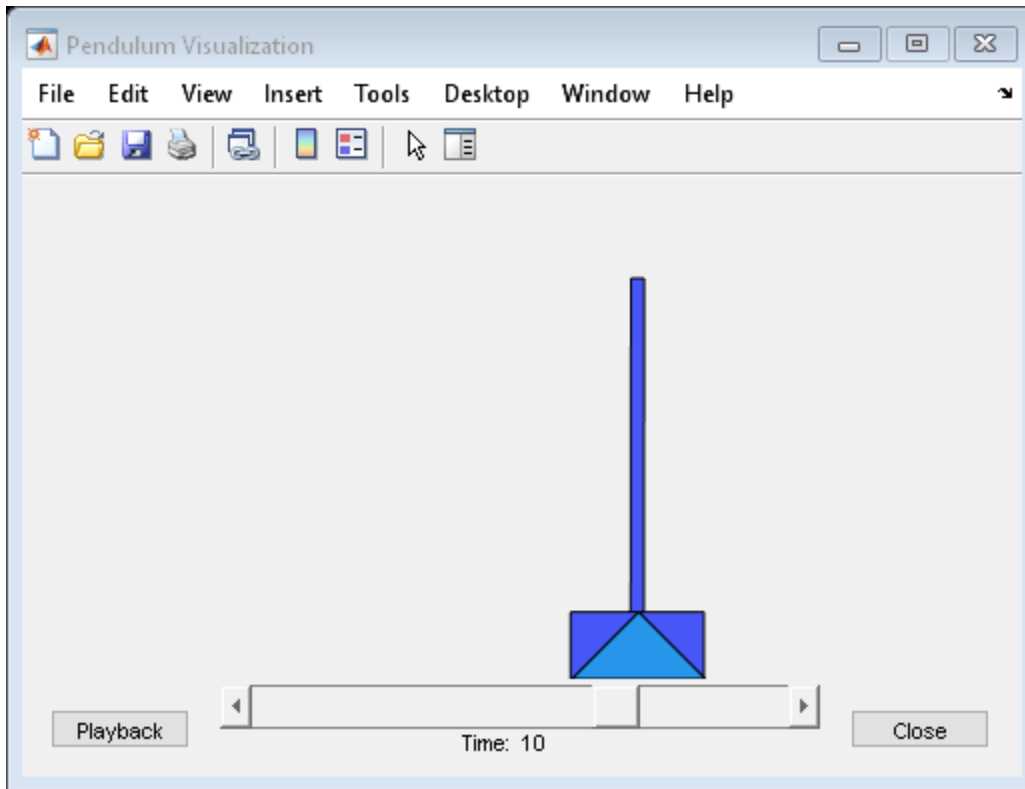

Double Spring Mass System

This example shows how to model a double spring-mass-damper system with a periodically varying forcing function. Associated with the example is an animation function that will automatically open a figure window and display to it. In this system, the only sensor is attached to the mass on the left, and the actuator is attached to the mass on the left. State estimation and LQR control are used.

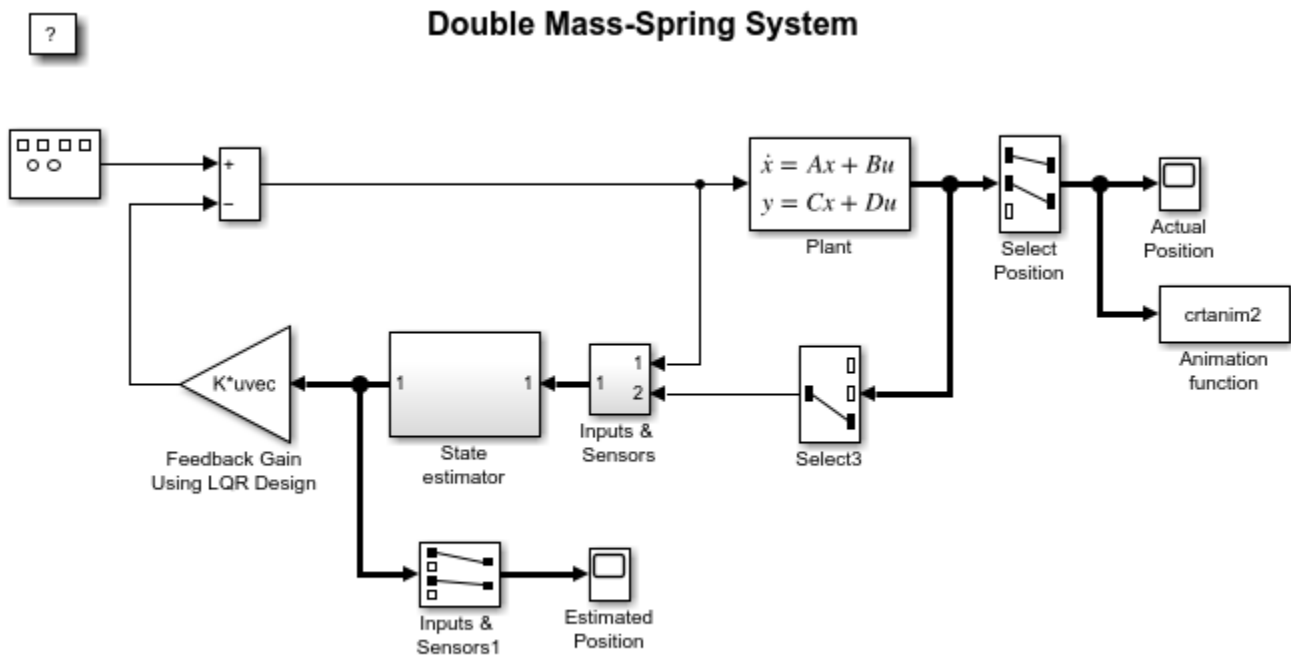

Copyright 1990-2013 The MathWorks, Inc.

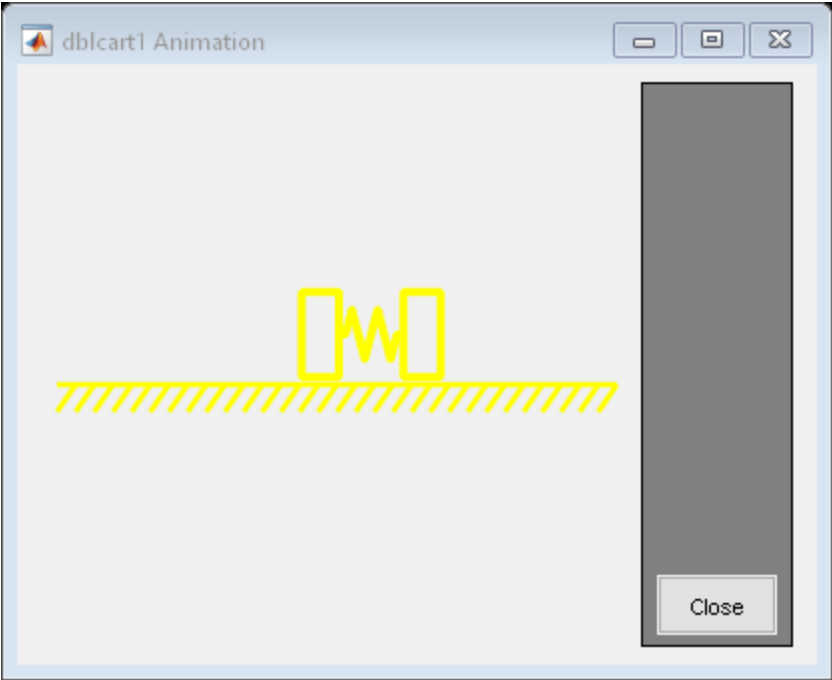

Tank Fill and Empty with Animation

This example shows how to model the dynamics of liquid in a tank. The associated animation provides a graphical display of the tank as it empties and refills, based on user-defined tank parameters. The tank empties at the start of the simulation and again part way through the simulation. When the simulation is stopped, a plot is generated showing the liquid height and the states of the two valves.



Tank Fill and Empty Example / Animation

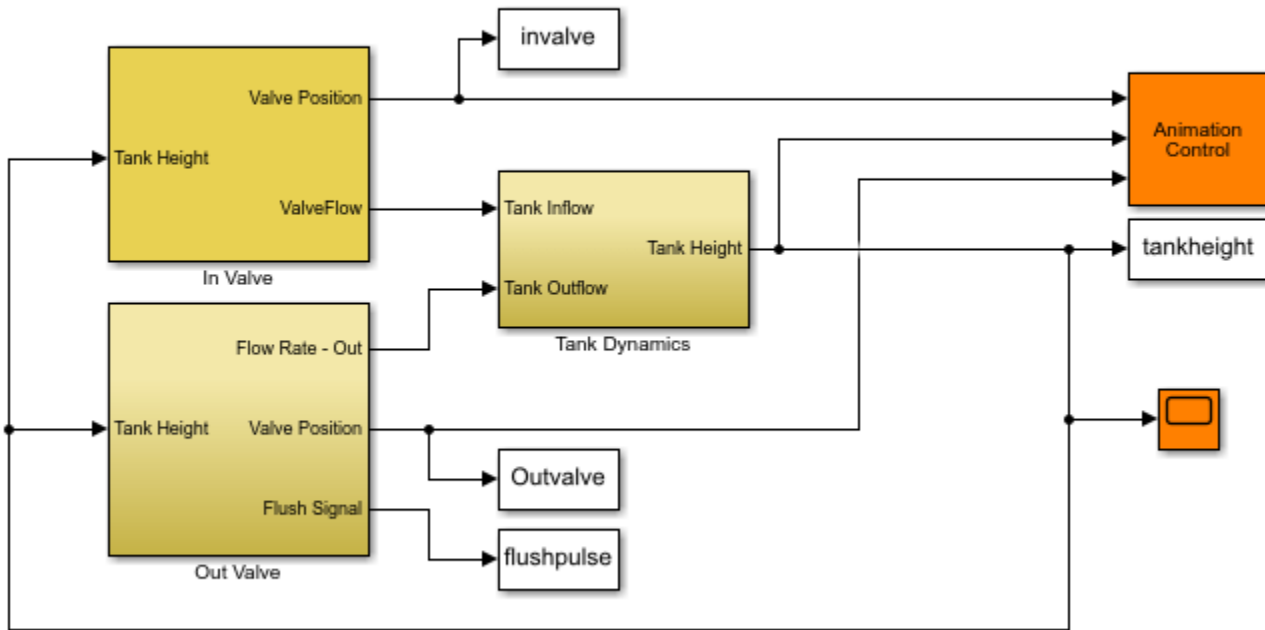

Copyright 1990-2013 The MathWorks, Inc.

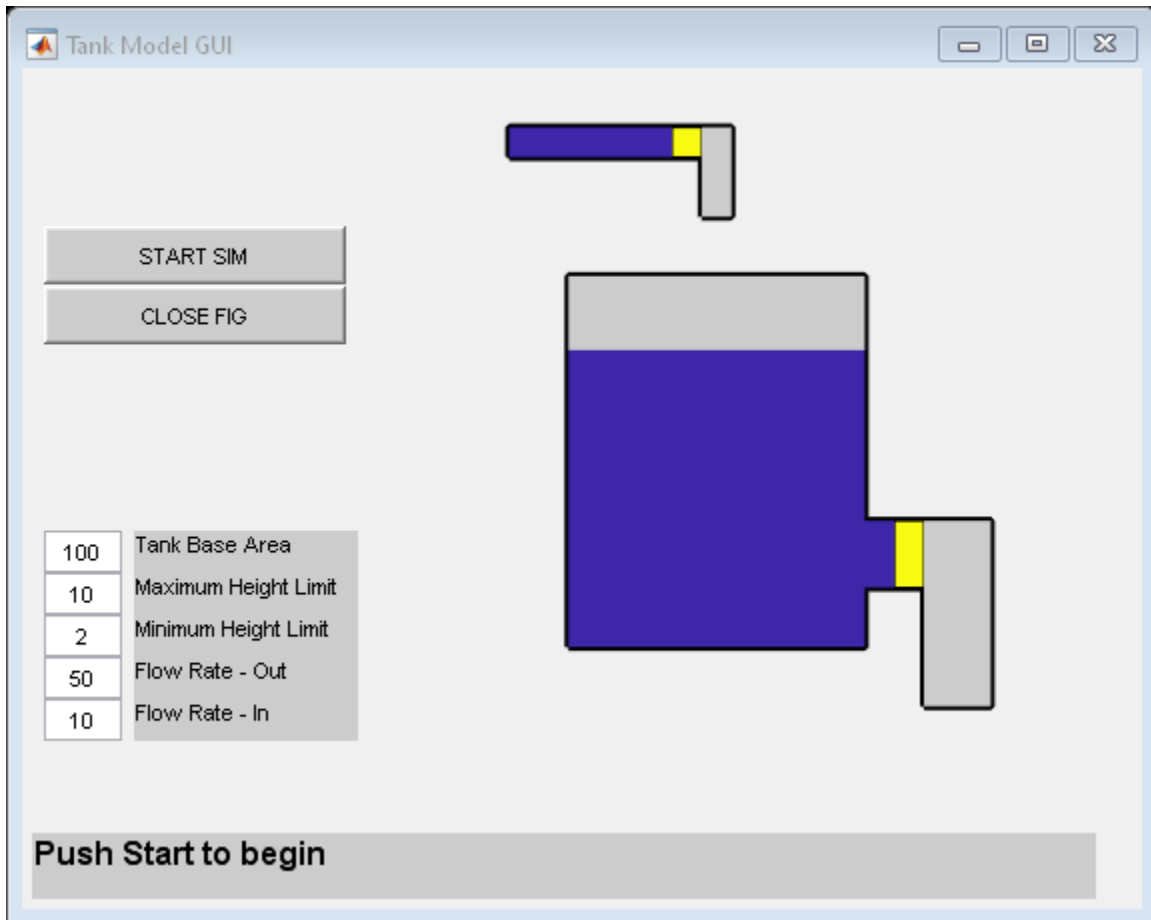

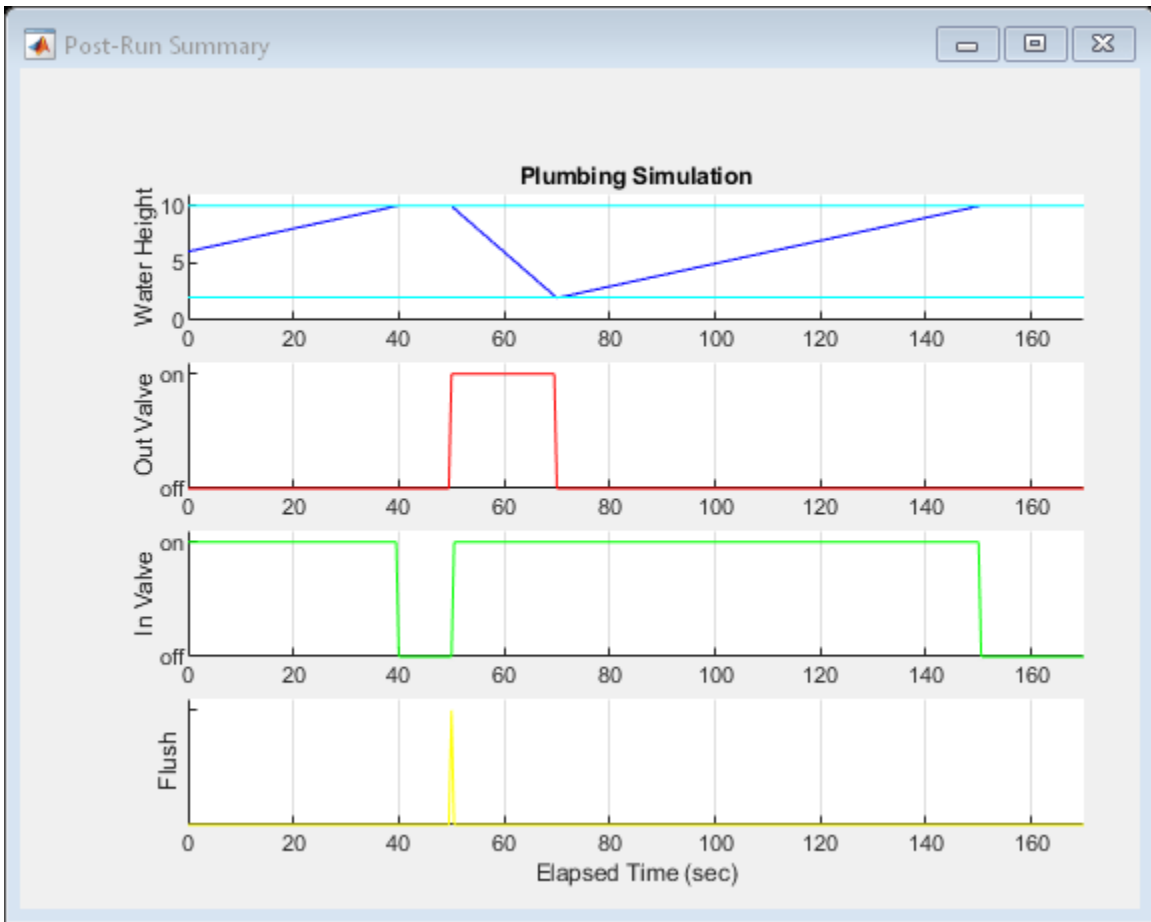

Simulating Systems with Variable Transport Delay Phenomena

This example shows two cases where you can use Simulink® to model variable transport delay phenomena.

Vertical Wheel Displacement on a One-Dimensional Car

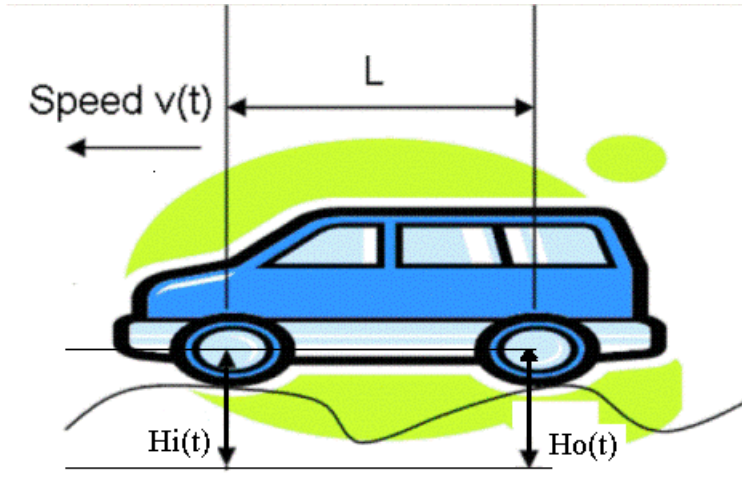
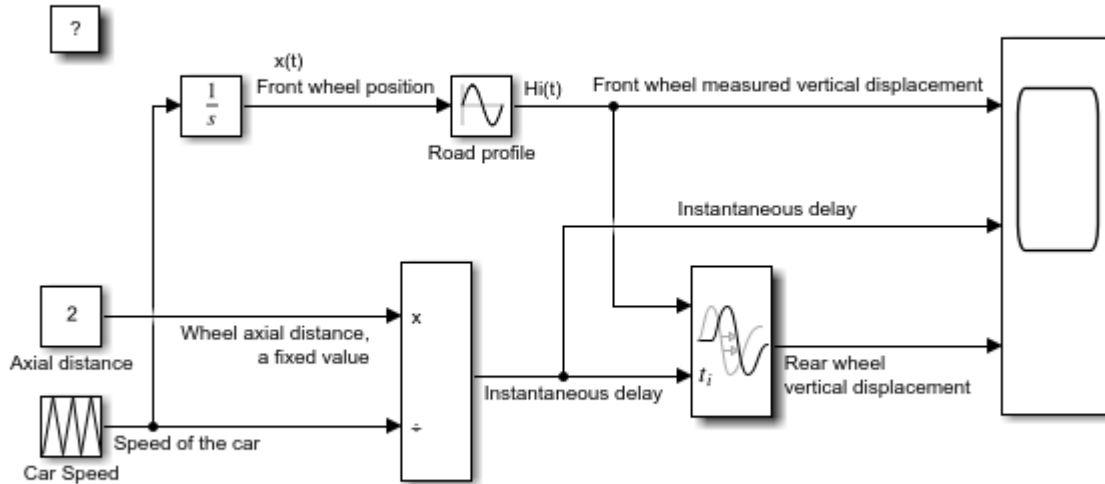

Figure 1: Illustration of a car with speed $v(t)$.

A car is running along a road with speed $v(t)$. A sensor is installed at the front wheel to measure the vertical displacement $H_i(t)$ of the front wheel caused by the road profile. If the wheels and road never lose contact, then the vertical displacement of the rear wheel, $H_o(t)$, can be seen as a variable transport delay of $H_i(t)$, which is determined by the length L between the two wheels and the speed $v(t)$.

Vertical displacement of the wheels of a one dimensional car



Copyright 1990-2013 The MathWorks, Inc.

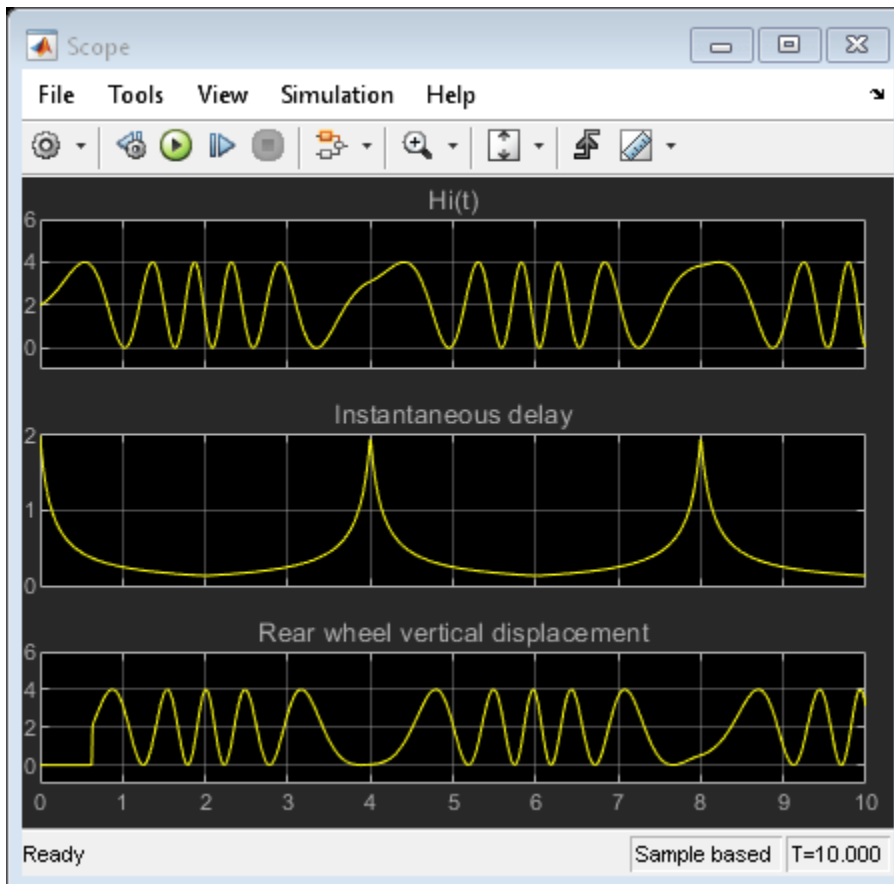

Figure 2: Vertical displacement of the wheels.

Incompressible Flow Through a Fixed Length Pipe

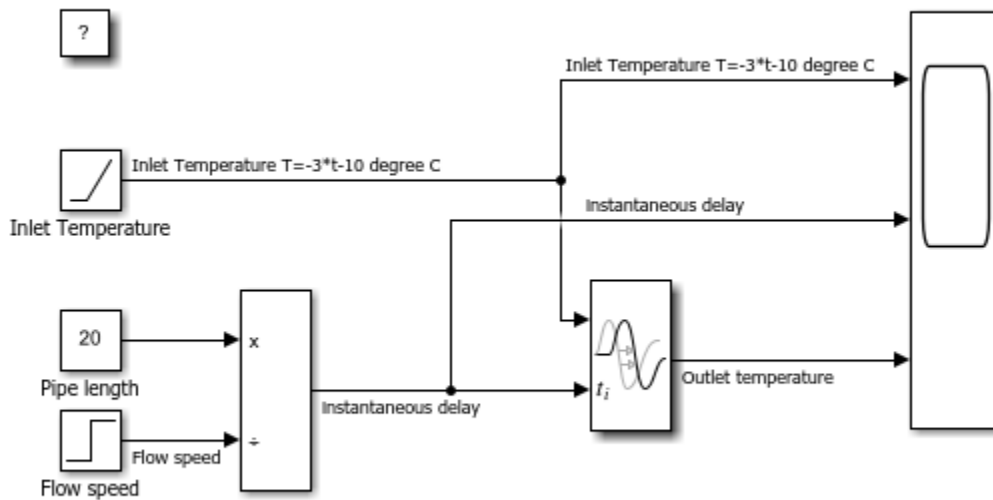

Figure 3: Illustration of a fixed-length pipe.

An incompressible flow goes through a pipe of length L with speed $v(t)$. At the inlet, the flow temperature is T_i . We can model the temperature at the outlet T_o as a variable transport delay of T_i . At time $t=0$, the pipe is empty and until $t=2$, there is no flow at the outlet. Thus, the output temperature before $t=2$ is the initial output temperature.

Open this model:

Incompressible flow through a fixed length pipe



Copyright 1990-2013 The MathWorks, Inc.

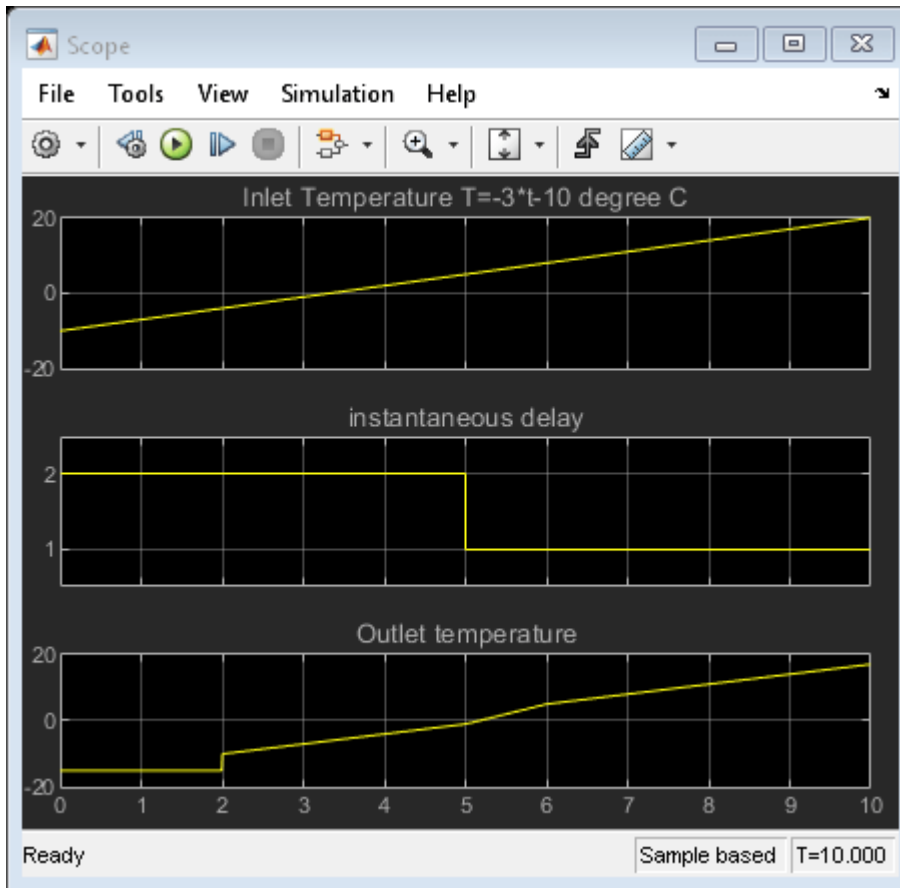

Figure 4: Incompressible flow through a fixed-length pipe.

Modeling a Foucault Pendulum

This example shows how to model a Foucault pendulum. The Foucault pendulum was the brainchild of the French physicist Leon Foucault. It was intended to prove that Earth rotates around its axis. The oscillation plane of a Foucault pendulum rotates throughout the day as a result of axial rotation of the Earth. The plane of oscillation completes a whole circle in a time interval T , which depends on the geographical latitude.

Foucault's most famous pendulum was installed inside the Paris Pantheon. This was a 28kg metallic sphere attached to a 67 meter long wire. This example simulates a 67 meter long pendulum at the geographic latitude of Paris.

Simulink® Model

The simplest way to solve the Foucault pendulum problem in Simulink® is to build a model that solves the coupled differential equations for the system. This model is shown in Figure 1. The equations that describe the Foucault pendulum are given below. For details on the physics of the model and the derivation of these equations, see Analysis and Physics.

$$\ddot{x} = 2\Omega \sin \lambda \dot{y} - \frac{g}{L}x$$

$$\ddot{y} = -2\Omega \sin \lambda \dot{x} - \frac{g}{L}y$$

x, y = pendulum bob coordinates as seen by an observer on Earth

Ω = Earth's angular speed of revolution about its axis (*rad/sec*)

g = acceleration of gravity (*m/sec²*)

L = length of the pendulum string (*m*)

λ = geographic latitude (*rad*)

Opening the Model

Type `sldemo_foucault` in MATLAB® Command Window to open this model. This model logs simulation data to the variable `sldemo_foucault_output`. Logged signals have a blue indicator. For more information, see "Configure a Signal for Logging".

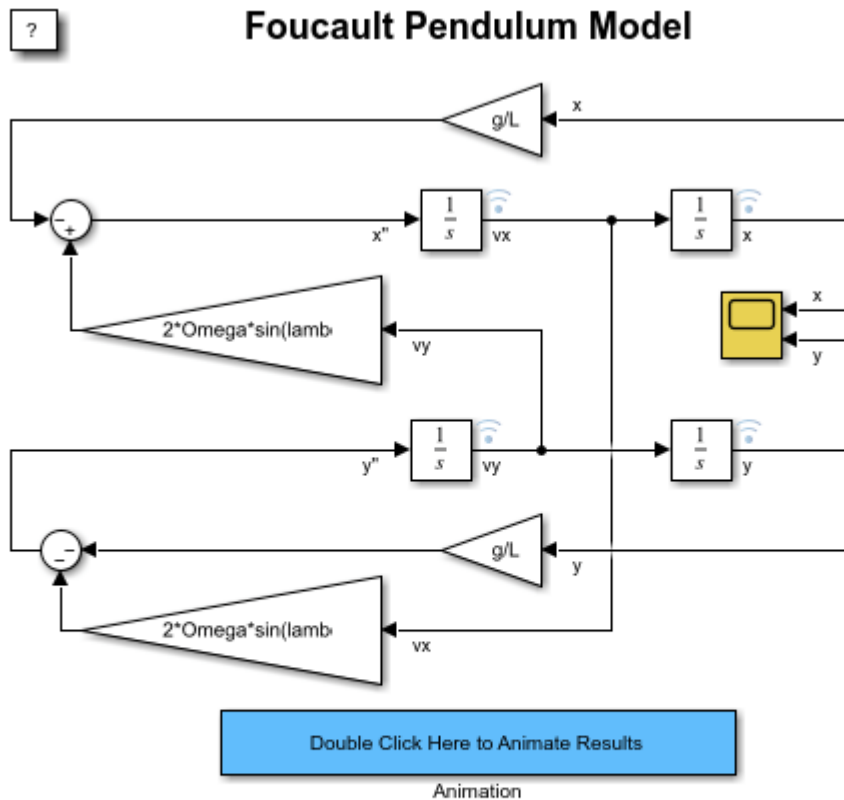

This model solves the differential equations for the Foucault Pendulum problem and plots the position of the pendulum bob in the XY plane. You can access or modify the parameters (g , Ω , λ , L and initial conditions) in MATLAB workspace.

Copyright 1990-2015 The MathWorks, Inc.

Figure 1: The Foucault pendulum model

Initial Conditions

This model loads the constants and initial conditions from the `sldemo_foucault_data.m` file. The contents of this file are shown in Table 1 below. You can modify simulation parameters directly in MATLAB workspace. The initial amplitude of the pendulum must be small compared to pendulum length, because the differential equations are valid only for small oscillations.

Table 1: Initial conditions

```

g = 9.83;           % acceleration of gravity (m/sec^2)
L = 67;            % pendulum length (m)
initial_x = L/100; % initial x coordinate (m)
initial_y = 0;     % initial y coordinate (m)
initial_xdot = 0;  % initial x velocity (m/sec)
initial_ydot = 0;  % initial y velocity (m/sec)
Omega=2*pi/86400;  % Earth's angular velocity of rotation about its axis (rad/sec)
lambda=49/180*pi;  % latitude in (rad)

```

Running the Simulation

Press the "Play" button on the toolbar in the model window to run the simulation. The simulation will use a variable step stiff solver, ode23t. It will simulate a Foucault pendulum for 3600 seconds (you can change the simulation time). The model uses a default relative tolerance $RelTol = 1e-6$.

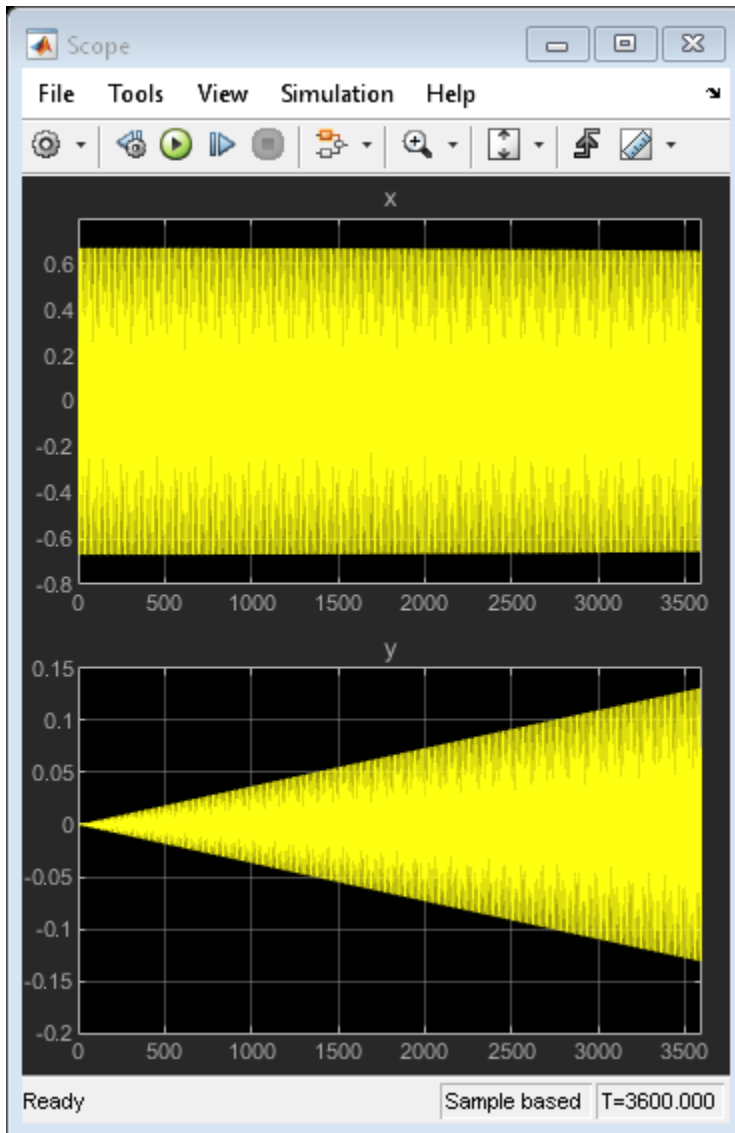

Figure 2: Foucault pendulum simulation results (simulation time of 3600 sec)

Results

The simulation results are shown in Figure 2 above. The simulation calculates the pendulum x and y coordinates, and the x and y velocity components of the pendulum.

The pendulum oscillation plane completes a 360 degree sweep in more than 24 hours. The sweep period is a function of geographic latitude λ (see derivation in Analysis and Physics).

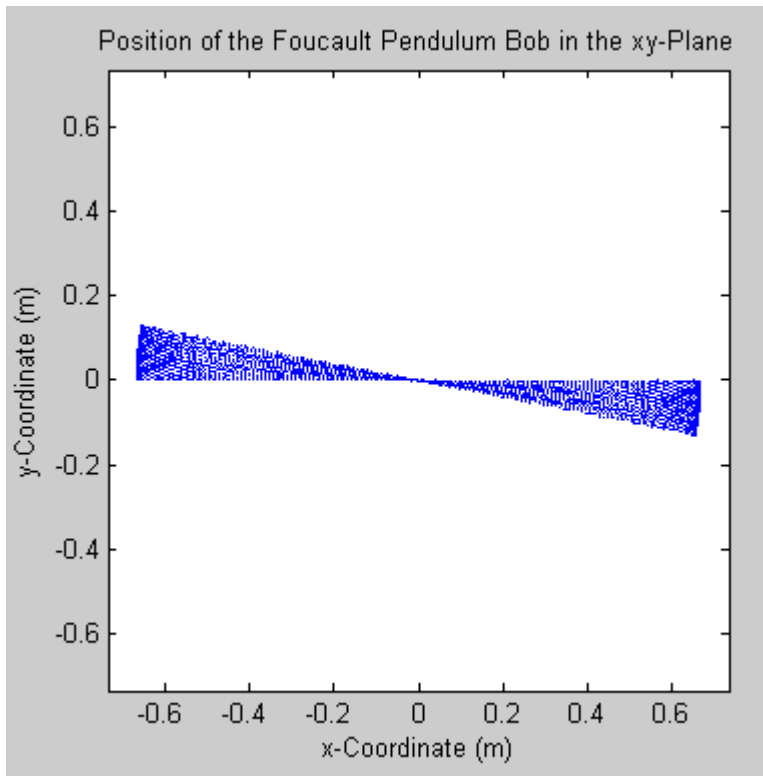

Figure 3: The Animation block shows how much the pendulum oscillation plane rotates in an hour

After you run the simulation, double click the animation block to animate the results.

- Note: The "Animate Results" portion of the example requires Signal Processing Toolbox™. Double-clicking on the animation block will cause an error if it is not installed. All other parts of the example will function correctly without the Signal Processing Toolbox.

The `sldemo_foucault_animate.m` file plots the position of the pendulum bob at different points in time. You can clearly see how the pendulum oscillation plane rotates.

- Note: If you are running the simulation at a large relative tolerance, the result will be numerically unstable over a long period of time. Make sure that you are using a stiff variable-step solver. Read more about numerical instability of stiff problems and solver performance in the "Exploring Variable-Step Solvers Using a Stiff Model" example.

Closing the Model

Close the model. Clear generated data.

Analysis and Physics

This section analyzes the Foucault pendulum and describes the physics behind it. The pendulum can be modeled as a point mass suspended on a wire of length L . The pendulum is located at the geographical latitude λ . It is convenient to use the reference frames shown in Figure 4: the inertial frame I (relative to the center of the Earth), and the non-inertial frame N (relative to an observer on Earth's surface). The non-inertial frame accelerates as a result of rotation.

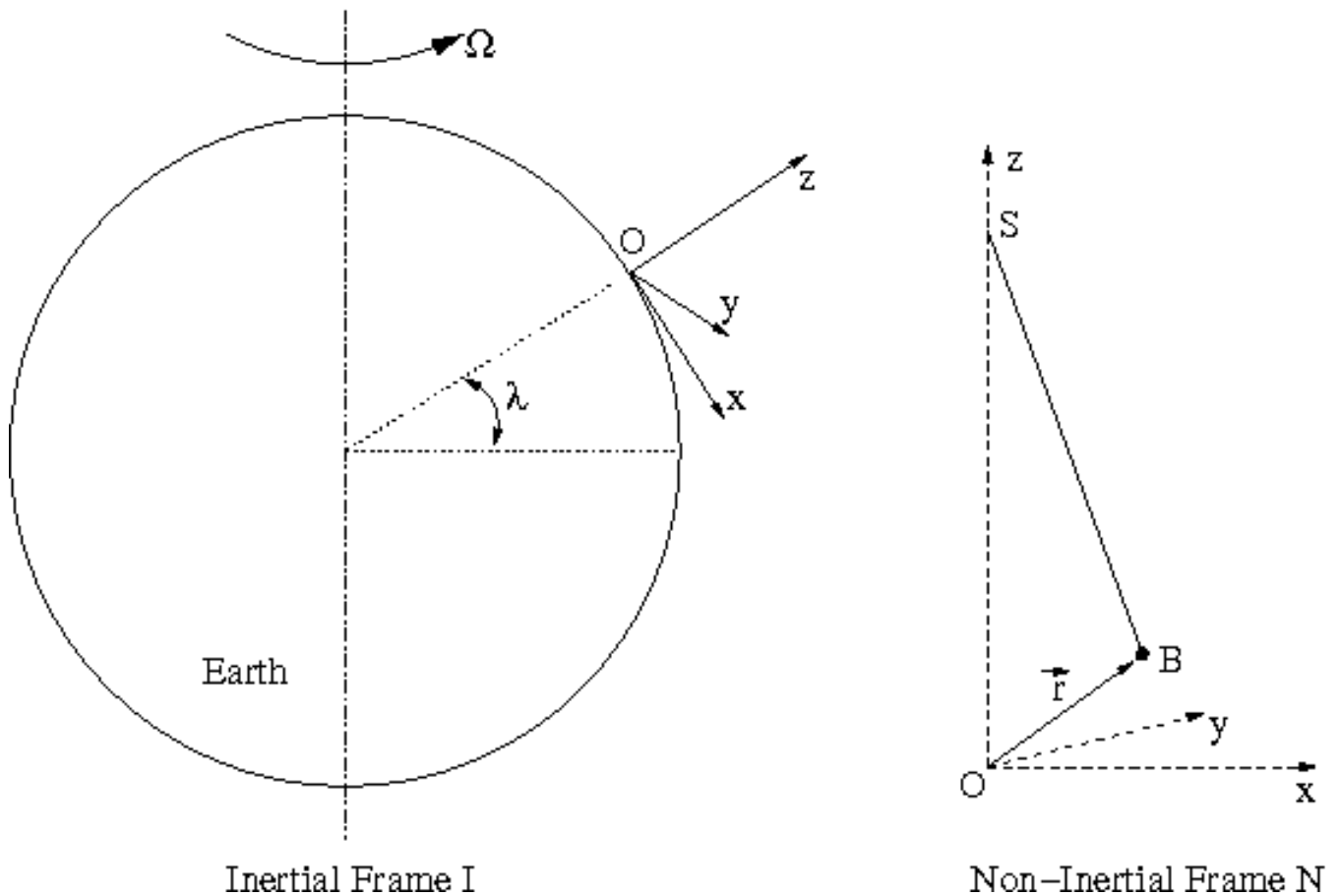

Figure 4: The Inertial and Non-Inertial Frames for the Problem

Point O is the origin of the non-inertial frame N. It is the point on the surface of the earth beneath the point of suspension of the pendulum. The non inertial frame is chosen such that the z-axis points away from the center of the Earth and is perpendicular to Earth's surface. The x-axis points south and the y-axis points west.

As mentioned in the introduction, the oscillation plane of a Foucault pendulum rotates. The oscillation plane completes a full rotation in time T_{rot} given by the following formula, where T_{day} is the duration of one day (i.e. the time it takes the Earth to revolve around its axis once).

$$T_{rot} = T_{day} \cdot \sin \lambda$$

The sine factor requires further discussion. It is often incorrectly assumed that the oscillation plane of the pendulum is fixed in the inertial frame relative to the center of the Earth. This is only true at the north and south poles. To eliminate this confusion, think about the point S (see Figure 4), where the pendulum is suspended. In the inertial frame I, point S moves on a circle. The pendulum bob is suspended on a wire of constant length. For simplicity ignore the air friction. In the inertial frame I, there are only two forces that act on the bob - the wire tension T and the gravitational force F_g .

The vector r gives the position of the pendulum bob, B (see Figure 4). Newton's second law states that the sum of all forces acting on a body equals the mass times the acceleration of the body.

$$m \vec{r} = \vec{T} + \vec{F}_g$$

Throughout this proof, the dots denote time derivatives, arrows denote vectors, caps denote unitary vectors (i, j, and k along x, y, and z axes). A dot above the vector arrow indicated the time derivative of the vector. An arrow above the dot indicated the vector of the time derivative. See the difference between total acceleration and radial acceleration below.

Total Acceleration:

$$\ddot{\vec{r}} = \frac{d^2 \vec{r}}{dt^2} = \frac{d^2}{dt^2} (x\hat{i} + y\hat{j} + z\hat{k})$$

Radial Acceleration:

$$\vec{r} = \left(\frac{d^2 r}{dt^2} \right) = \ddot{x}\hat{i} + \ddot{y}\hat{j} + \ddot{z}\hat{k}$$

The acceleration of gravity points towards the center of the earth (negative z-direction).

$$g = 9.83m/sec^2$$

$$\vec{g} = -g\hat{k}$$

$$m\ddot{\vec{r}} = \vec{T} - mg\hat{k}$$

Decompose the acceleration term:

$$\vec{r} = r_x\hat{i} + r_y\hat{j} + r_z\hat{k}$$

$$\dot{\vec{r}} = (\dot{r}_x\hat{i} + \dot{r}_y\hat{j} + \dot{r}_z\hat{k}) + r_x\dot{\hat{i}} + r_y\dot{\hat{j}} + r_z\dot{\hat{k}}$$

The time derivatives of unit vectors appear because the non-inertial reference frame N is rotating in space. This means that the unitary vectors i, j, and k rotate in space. Their time derivatives are given below. Omega is Earth's angular velocity of revolution around its axis. The scalar Omega is the value of the angular velocity. The vectorial Omega is the vector angular velocity. Its direction is determined by the right hand rule.

$$\dot{\hat{i}} = \vec{\Omega} \times \hat{i}$$

$$\dot{\hat{j}} = \vec{\Omega} \times \hat{j}$$

$$\dot{\hat{k}} = \vec{\Omega} \times \hat{k}$$

Rewrite the time derivative of the vector r relative to Omega.

$$\dot{\vec{r}} = (\dot{r}_x\hat{i} + \dot{r}_y\hat{j} + \dot{r}_z\hat{k}) + \vec{\Omega} \times \vec{r} = \vec{\dot{r}} + \vec{\Omega} \times \vec{r}$$

Similarly, express the second time derivative of the vector r.

$$\ddot{\vec{r}} = \vec{\ddot{r}} + 2\vec{\Omega} \times \vec{\dot{r}} + \vec{\Omega} \times (\vec{\Omega} \times \vec{r})$$

\vec{r} = acceleration in the non-inertial frame N (x, y, z components)

$2\vec{\Omega} \times \vec{r}$ = Coriolis acceleration

$\vec{\Omega} \times (\vec{\Omega} \times \vec{r})$ = additional term due to rotation of non-inertial frame N

To simplify this equation, assume that Omega for Earth is very small. This allows us to ignore the third term in the equation above. In fact, the second term (which is already much smaller than the first term) is four orders of magnitude greater than the third term. This reduces the equation to the following form:

$$\ddot{\vec{r}} \simeq \vec{r} + 2\vec{\Omega} \times \dot{\vec{r}}$$

Newton's Second Law can be written and decomposed into x,y, and z components as follows:

$$m\ddot{\vec{r}} = \vec{T} - mg\hat{k} - 2m\vec{\Omega} \times \dot{\vec{r}}$$

$$m\ddot{x} = T_x + 2m\Omega\dot{y}\sin\lambda$$

$$m\ddot{y} = T_y - 2m\Omega(\dot{x}\sin\lambda + \dot{z}\cos\lambda)$$

$$m\ddot{z} = T_z - mg + 2m\Omega\dot{y}\cos\lambda$$

The angular amplitude of oscillations is small. Therefore, we can ignore the vertical velocity and vertical acceleration (z-dot and z-double-dot). The string tension components can be expressed using small angle approximations, which also considerably simplify the problem, making it two-dimensional (see below).

$$T_z = mg - 2m\Omega\dot{y}\cos\lambda \simeq mg$$

$$T_x = -T\frac{x}{L}$$

$$T_y = -T\frac{y}{L}$$

$$T_z = T\frac{L-z}{L} \simeq T$$

Characteristic Differential Equations

Finally the physics of the problem can be described by the system of coupled equations given below. The x and y coordinates specify the position of the pendulum bob as seen by an observer on Earth.

$$\ddot{x} - 2\Omega\sin\lambda\dot{y} + \frac{g}{L}x = 0$$

$$\ddot{y} + 2\Omega\sin\lambda\dot{x} + \frac{g}{L}y = 0$$

Analytic Solution (Approximate)

The following is an analytic solution to the Foucault pendulum problem. Unfortunately, it is not exact. If you try to substitute the analytic solution into the differential equations, uncanceled terms of the

order Omega squared will remain. However, because Omega is very small, we can ignore the uncanceled terms for practical purposes.

$$\eta = x + i \cdot y \text{ (complex number)}$$

$$\ddot{\eta} + (2i\Omega \sin \lambda)\dot{\eta} + \frac{g}{L}\eta = 0$$

$$\eta = \left(C_1 e^{i\sqrt{g/L}t} + C_2 e^{-i\sqrt{g/L}t} \right) e^{-i\Omega t \sin \lambda}$$

C_1, C_2 are complex integration constants

Actual Differential Equation System Is Asymmetric

During the derivation, terms involving Omega squared were ignored. This resulted in xy symmetry in the differential equations. If the Omega squared terms are taken into consideration, the differential equation system becomes asymmetric (see below).

$$\ddot{x} - 2\Omega \sin \lambda \dot{y} + \left(\frac{g}{L} - \Omega^2 \sin^2 \lambda \right) x = 0$$

$$\ddot{y} + 2\Omega \sin \lambda \dot{x} + \left(\frac{g}{L} - \Omega^2 \right) y = 0$$

You can easily modify the current Foucault pendulum model to account for asymmetric differential equations. Simply edit the corresponding Gain blocks that contain g/L and add the necessary expression. This change will introduce a very small overall correction to the numerical result.

Foucault Pendulum Model with VRML Visualization

This example shows how to solve the differential equations for the Foucault Pendulum problem and displays the pendulum bob movement in the VRML scene. You can modify the Pendulum location by changing the Latitude / Longitude constant values in the model and other parameters (g , Ω , L and initial conditions) in MATLAB® workspace.

There are two VRML scenes associated with this model. The first scene shows the Foucault pendulum itself, the second shows geographical position of the pendulum on the Earth. During the simulation, two arrow markers indicate the current and the initial position of the pendulum in the Earth coordinate system.

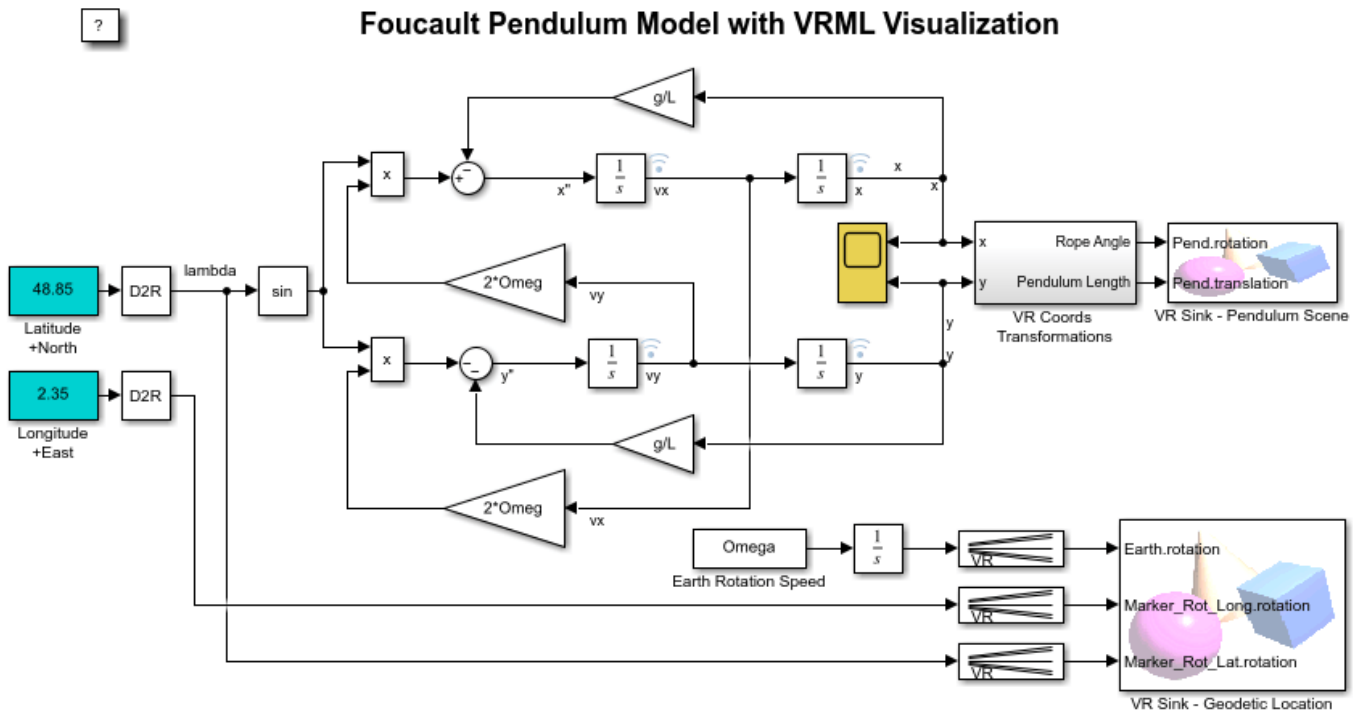

This model solves the differential equations for the Foucault Pendulum problem and displays the pendulum bob movement in the VRML scene. You can modify the Pendulum location by changing the Latitude / Longitude constant values in the model and other parameters (g , Ω , L and initial conditions) in MATLAB(R) workspace.

Copyright 1998-2012 The MathWorks, Inc.



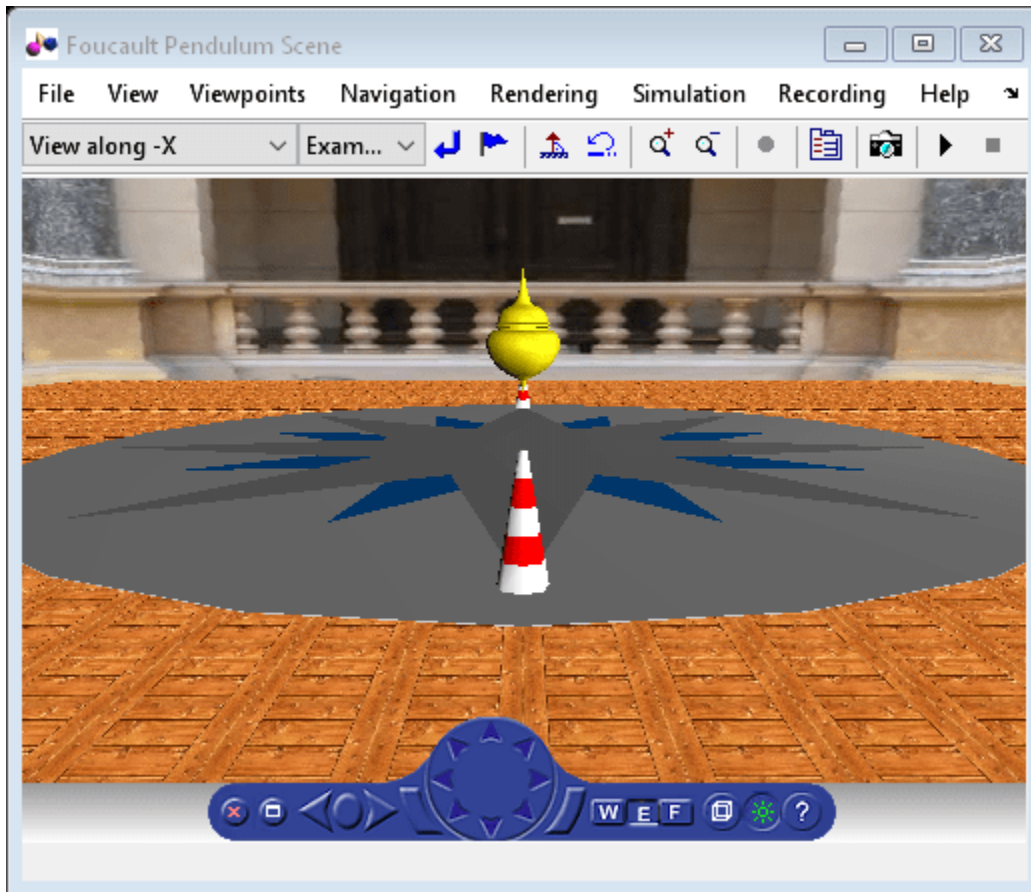

Exploring Variable-Step Solvers Using a Stiff Model

This example shows the behaviour of variable-step solvers in a Foucault pendulum model. Simulink® solvers ode45, ode15s, ode23, and ode23t are used as test cases. Stiff differential equations are used to solve this problem. There is no exact definition of stiffness for equations. Some numerical methods are unstable when used to solve stiff equations and very small step-sizes are required to obtain a numerically stable solution to a stiff problem. A stiff problem may have a fast changing component and a slow changing component.

Foucault pendulum is an example of a stiff problem. The pendulum completes an oscillation in a few seconds (fast changing component) whereas the Earth completes a rotation about its axis in a day (slow changing component). The oscillation plane of the pendulum slowly rotates because of Earth's axial rotation. Read more about the physics of a Foucault pendulum in *Modelling a Foucault Pendulum*.

The simulation calculates the position of the pendulum bob in the x-y plane as viewed by an observer on the surface of Earth. The total energy of the pendulum is then calculated and used to assess the performance of various Simulink solvers.

Foucault Pendulum Model

The Foucault pendulum is described by the system of coupled differential equations given below. Friction and air drag are not taken into consideration (this greatly simplifies the equations). A full derivation of these equations is given in the *Foucault Pendulum* example.

$$\ddot{x} = 2\Omega \sin \lambda \dot{y} - \frac{g}{L}x$$

$$\ddot{y} = -2\Omega \sin \lambda \dot{x} - \frac{g}{L}y$$

Ω = Earth's angular velocity of rotation around its axis

λ = geographic latitude

g = acceleration of gravity

x and y = coordinates of the pendulum bob

The model shown in Figure 1 is used to solve the differential equations describing a Foucault pendulum. Type `sldemo_solvers` in MATLAB® Command Window to open the model. The example simulates a Foucault pendulum for 86400 seconds. The constants and initial conditions are saved the model workspace.

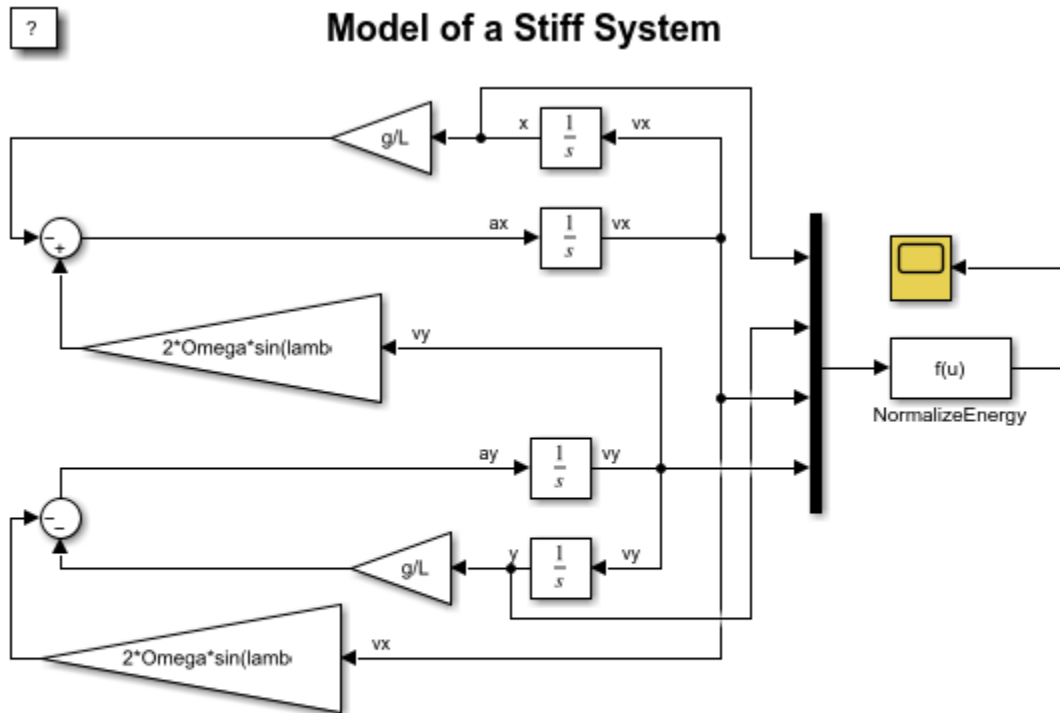

This model simulates a Foucault pendulum (a stiff system).
The model calculates the normalized pendulum energy, E .

Copyright 1990-2013 The MathWorks, Inc.

Figure 1: Foucault pendulum model used to assess solver performance

Variable Step Solvers

This example investigates the performance of `ode45`, `ode15s`, `ode23`, and `ode23t` variable-step solvers. To read more about a particular solver, for example `ode45`, type `help ode45` in MATLAB Command Window.

| Solver | Problem Type | Order of Accuracy | When to Use |
|----------------------|------------------|-------------------|---|
| <code>ode45</code> | Nonstiff | Medium | Most of the time. This should be the first solver you try. |
| <code>ode23</code> | Nonstiff | Low | For problems with crude error tolerances or for solving moderately stiff problems. |
| <code>ode113</code> | Nonstiff | Low to high | For problems with stringent error tolerances or for solving computationally intensive problems. |
| <code>ode15s</code> | Stiff | Low to medium | If <code>ode45</code> is slow because the problem is stiff. |
| <code>ode23s</code> | Stiff | Low | If using crude error tolerances to solve stiff systems and the mass matrix is constant. |
| <code>ode23t</code> | Moderately Stiff | Low | For moderately stiff problems if you need a solution without numerical damping. |
| <code>ode23tb</code> | Stiff | Low | If using crude error tolerances to solve stiff systems. |

Figure 2: List of variable-step solvers available in Simulink

Assessing Solver Performance

There are different ways to assess the performance of a solver. If a problem has a closed form solution, you could compare the solver results with the expected theoretical result. You could also monitor the time it takes to simulate a model using a particular solver.

Unfortunately there is no exact theoretical solution for the Foucault Pendulum problem. There is an approximate closed form solution, however it cannot be used to assess solver performance (see the Foucault pendulum example).

Total Energy Conservation

This example assesses solver performance by verifying the energy conservation law. In a frictionless environment, the total energy of the pendulum must remain constant. The calculated energy of the pendulum, however, will not remain constant as a result of limited numeric accuracy.

This example calculates the normalized total energy of the pendulum at every time-step. The relative error in energy equals the change in total energy over the course of the simulation. Ideally, the relative error in energy must be zero because energy is conserved. Total energy is the sum of potential and kinetic energy. "NormalizeEnergy" block calculates normalized pendulum energy using the expressions given below.

$$E = \frac{v_x^2 + v_y^2}{2} + g(L - \sqrt{L^2 - x^2 - y^2})$$

$$E_{normalized}(t) = \frac{E(t)}{E(0)}$$

$$E(0) = \text{initial total energy}$$

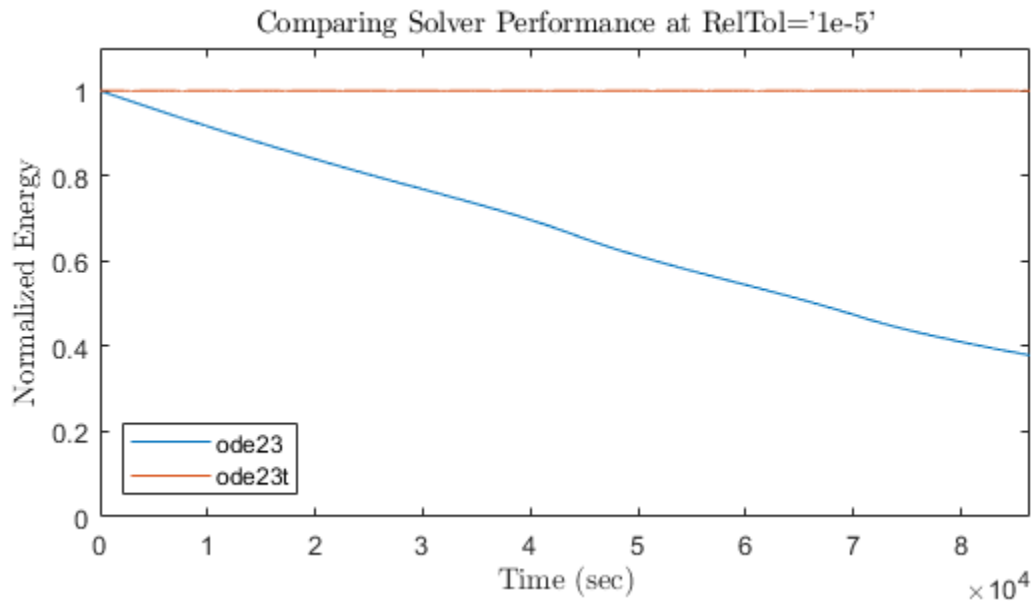

Figure 3: Normalized energy versus time

Figure 3 shows a plot of normalized energy versus time as calculated using ode23 and ode23t. It is clear that in this particular problem ode23t is much more accurate than ode23. In the simulation

that used `ode23`, the normalized pendulum energy decreased by more than 60%. A pendulum with lower energy has a lower oscillation amplitude. You can see this effect in Figure 4, where the amplitude of the pendulum calculated by `ode23` decreases as the oscillation plane rotates.

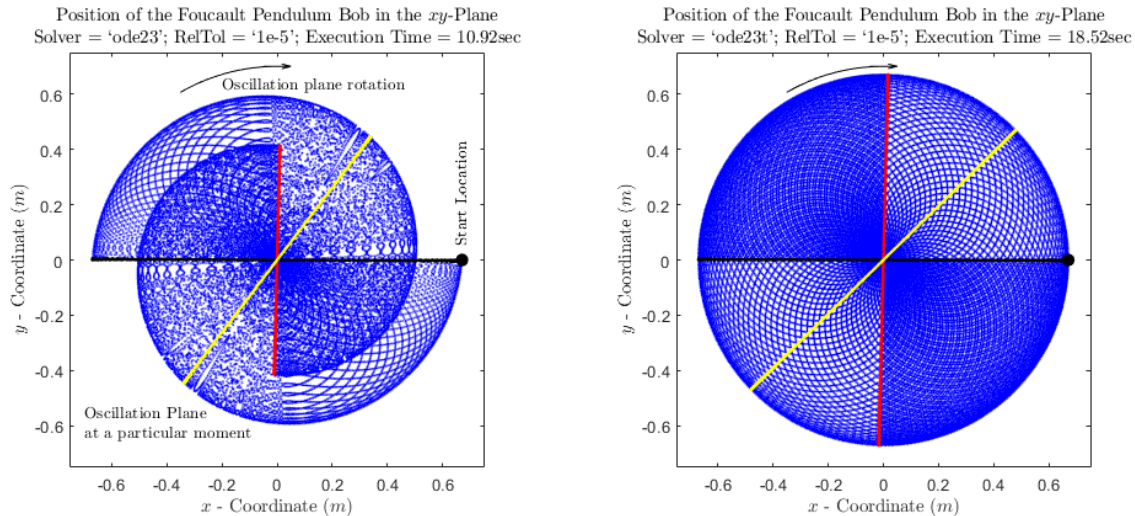

Figure 4: Pendulum position as calculated using `ode23` and `ode23t`

Figure 4 illustrates the difference between a stiff and a non-stiff solver. Each plot shows the position of the pendulum bob throughout a day (every 15th data point is plotted as a blue point). The black dot marks the initial position of the pendulum bob and the black line marks the initial pendulum oscillation plane. The red line indicates the oscillation plane after a day. The yellow line shows the oscillation plane at some intermediate point in time. Note that the oscillation plane of the pendulum does not complete a full rotation within a day. How fast the oscillation plane rotates depends on the geographical latitude (see details in the Foucault pendulum example). Observe that the pendulum amplitude in the left plot decreases whereas the amplitude in the right plot remains constant. For the same relative tolerance, `RelTol=1e-5`, the stiff solver gives a more accurate result, but requires more execution time.

Figure 5 shows a more detailed performance study of Simulink solvers. Four solvers were chosen to illustrate how relative error and simulation execution time vary as a function of relative tolerance. You can use the `sldemo_solvers_mcode.m` script for more extensive solver tests. This script generates C code from the model to speed up the simulations. Note that the script can take several minutes to execute.

```
Building RSim executable for model..
Time taken: 33.232303 seconds.
```

```
Running generated RSim executable..
Time taken: 87.208177 seconds.
```

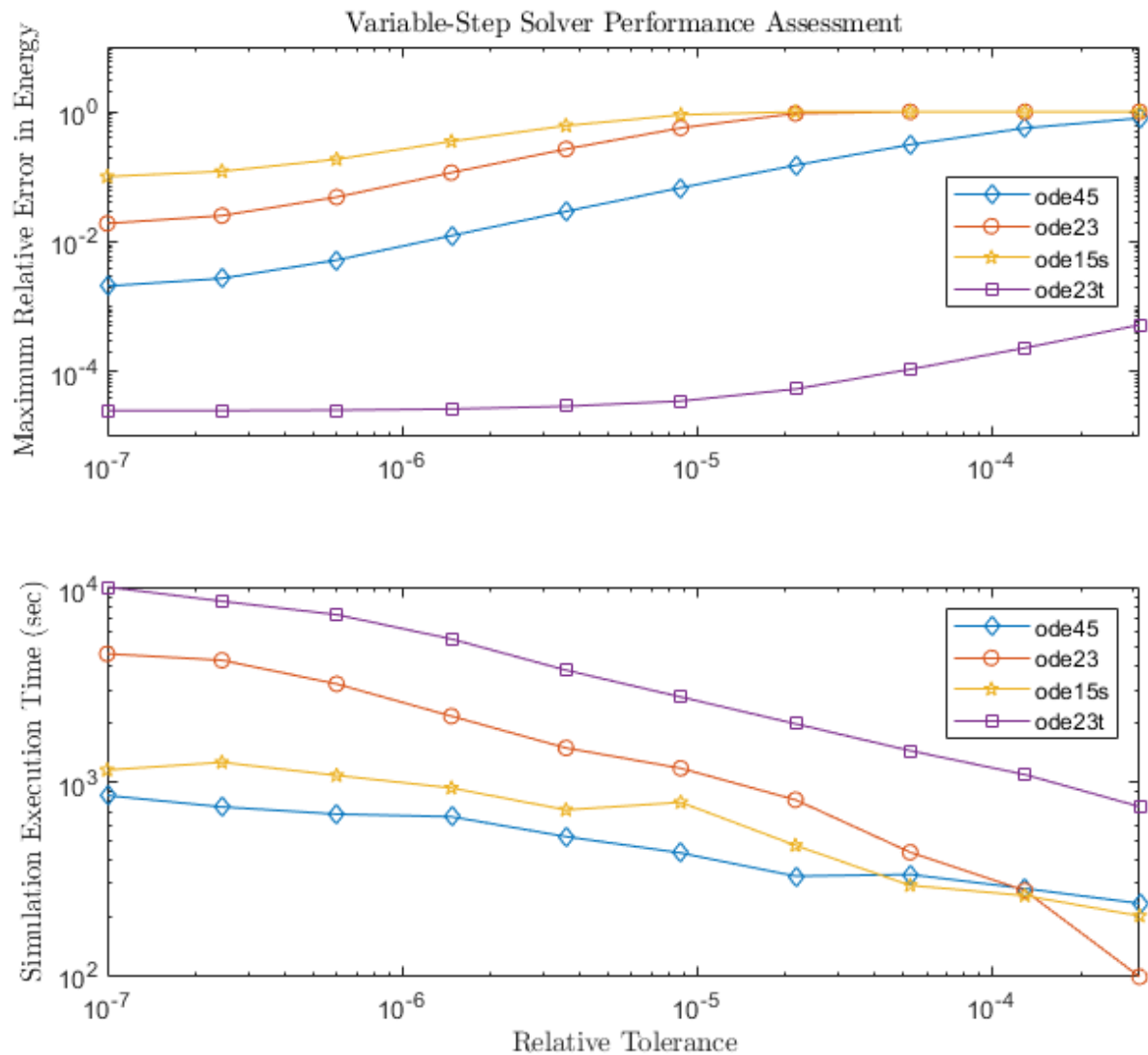

Figure 5: Relative error and execution time for various solver settings. `AbsTol = '1e-7'` for all simulations.

Observe that in this example relative error does not decrease very significantly for relative tolerances below $1e-6$. This is a numeric solver limitation that depends on the particular model. Reducing the solver relative tolerance does not necessarily improve accuracy. You need to estimate the minimal accuracy that is required for your problem and choose the solver accordingly to minimize simulation costs. For example you may want to know the position of the Foucault pendulum bob within a few centimeters. It is unnecessary to calculate the position of a pendulum within a few microns because you cannot measure the position that accurately.

Conclusions

The numeric results of a simulation can behave differently depending on solver settings. This is crucial in the case of stiff problems. When working with stiff models, choose a solver that will give an

accurate result at a minimal price. The relative tolerance (variable-step solvers) or step size (fixed-step solvers) have to be small enough that the result is numerically stable. Although some solvers are more efficient than others, stiff solvers are better suited for solving stiff problems. Variable step solvers are more robust than fixed-step solvers.

Exploring the Solver Jacobian Structure of a Model

The example shows how to use Simulink® to explore the solver Jacobian sparsity pattern, and the connection between the solver Jacobian sparsity pattern and the dependency between components of a physical system. A Simulink model that models the synchronization of three metronomes placed on a free moving base are used.

The Solver Jacobian Pattern

In general, the continuous part of a Simulink model can be written as:

$$\begin{cases} \dot{x} = f(x, u) \\ y = g(x, u) \end{cases}$$

where x are the continuous states and u are the inputs. y are the outputs.

The matrix:

$$J_x = \frac{\partial f}{\partial x}$$

is called the system solver Jacobian matrix. When an implicit ODE solver is used to solve the system equations, J_x needs to be computed when needed. For example, the Jacobian matrix of a set of first order ODEs

$$\begin{cases} \dot{x}_1 = x_1 x_2 \\ \dot{x}_2 = x_2 \end{cases}$$

is

$$J_x = \begin{bmatrix} \frac{\partial f_1}{\partial x_1} & \frac{\partial f_1}{\partial x_2} \\ \frac{\partial f_2}{\partial x_1} & \frac{\partial f_2}{\partial x_2} \end{bmatrix} = \begin{bmatrix} x_2 & x_1 \\ 0 & 1 \end{bmatrix}$$

You can convert the solver Jacobian matrix to a Boolean sparse matrix by representing each non-zero element as 1, and each element that is always zero (hard zero) as 0. For example, the Boolean matrix corresponding to above Jacobian J_x is:

$$J_{xp} = \begin{bmatrix} 1 & 1 \\ 0 & 1 \end{bmatrix},$$

where J_{xp} is called the solver Jacobian pattern matrix.

The solver Jacobian pattern matrix can be generated directly from the original system equations by using the following rule:

$$J_{xp}(i, j) = \begin{cases} 1 & \text{if } x_j \text{ is explicitly used to compute } \dot{x}_i \\ 0 & \text{otherwise} \end{cases}$$

As you can see, the solver Jacobian pattern matrix actually represents the dependency between the state variables and their derivatives. If computing of \dot{x}_i needs the value of x_j , then there exists a

dependency $\dot{x}_i \leftarrow x_j$ and $J_{xp}(i, j) = 1$. These dependencies are determined by the physical nature of the system, and thus by studying the solver Jacobian matrix, you can explore the physical structure of the physical system represented by the model. Simulink provides APIs for the user to get the solver Jacobian pattern matrix. The following shows how to access the solver Jacobian pattern and to use it to study the model.

The Pattern and Dependency: Synchronization of Metronomes

Synchronization is defined as an adjustment of rhythms of oscillating objects due to their weak interaction [1]. One of the first scientifically documented observations of synchronization was reported by the Dutch scientist Christiaan Huygens, the inventor of pendulum clock [2]. Huygens discovered that two pendulums attached to the same beam supported by chairs would swing in exact opposite direction after some time. A similar set up used in this example is shown in Figure 1.

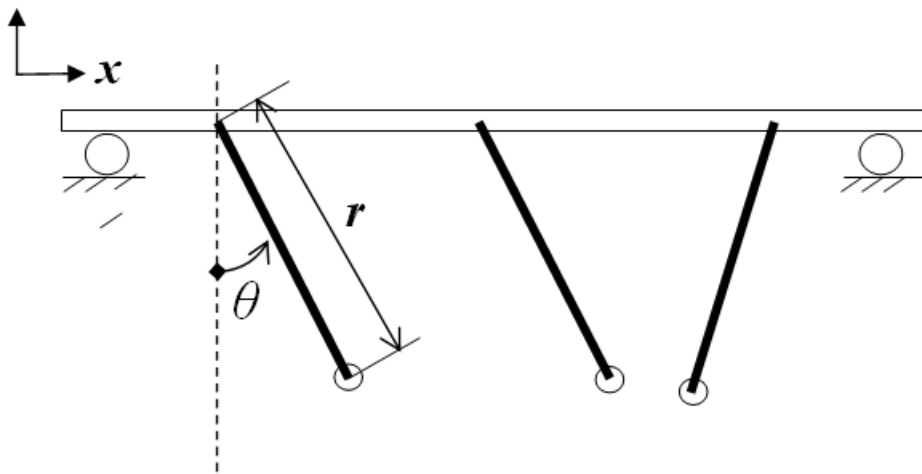

Moving base with mass M
Pendulum with mass m , rotational inertia J , length r

Figure 1: Set up used in this example: three metronomes on a moving base

Modeling the System

The model of this physical system can be divided into two parts:

- The metronomes mechanism
- The moving base

The metronomes mechanism

Referring to Figure 1, the dynamic equations of a single metronome on a moving base can be derived as[3]:

$$\underbrace{\ddot{\theta}}_{\text{Angular acceleration}} + \underbrace{\frac{mrg}{J} \sin \theta}_{\text{Gravitational term}} + \underbrace{\frac{b}{J} \left[\left(\frac{\theta}{\theta_r} \right)^2 - 1 \right] \dot{\theta}}_{\text{Escapement and damping term}} + \underbrace{\left(\frac{rm \cos \theta}{J} \right) \ddot{x}}_{\text{Coupled inertial force term}} = 0 \quad (\text{eq.1})$$

The first two terms describe a simple pendulum without friction. The third term is used to approximate the escapement* and any damping of the metronome. This term increases the angular velocity for $\theta < \theta_0$ and decreases it for $\theta > \theta_0$ [3]. The last term is the coupled effect from the moving base, in terms of an inertial force.

The moving base

Assuming the motion of the base is frictionless, then the center of mass of the system will not change and you can derive the following:

$$x = -\frac{m}{M + 3m} r(\sin \theta_1 + \sin \theta_2 + \sin \theta_3),$$

where M is the mass of the base and m is the mass of the pendulum.

Then eq.1 can be changed to:

$$\ddot{x} = -\frac{m}{M + 3m} r \left[\ddot{\theta}_1 \cos \theta_1 - \sin \theta_1 (\dot{\theta}_1)^2 + \ddot{\theta}_2 \cos \theta_2 - \sin \theta_2 (\dot{\theta}_2)^2 + \ddot{\theta}_3 \cos \theta_3 - \sin \theta_3 (\dot{\theta}_3)^2 \right] \quad (eq.2)$$

The following shows the above system implemented using Simulink. The model contains three metronome subsystems and the moving base.

?

Exploring the Solver Jacobian Structure of a Model

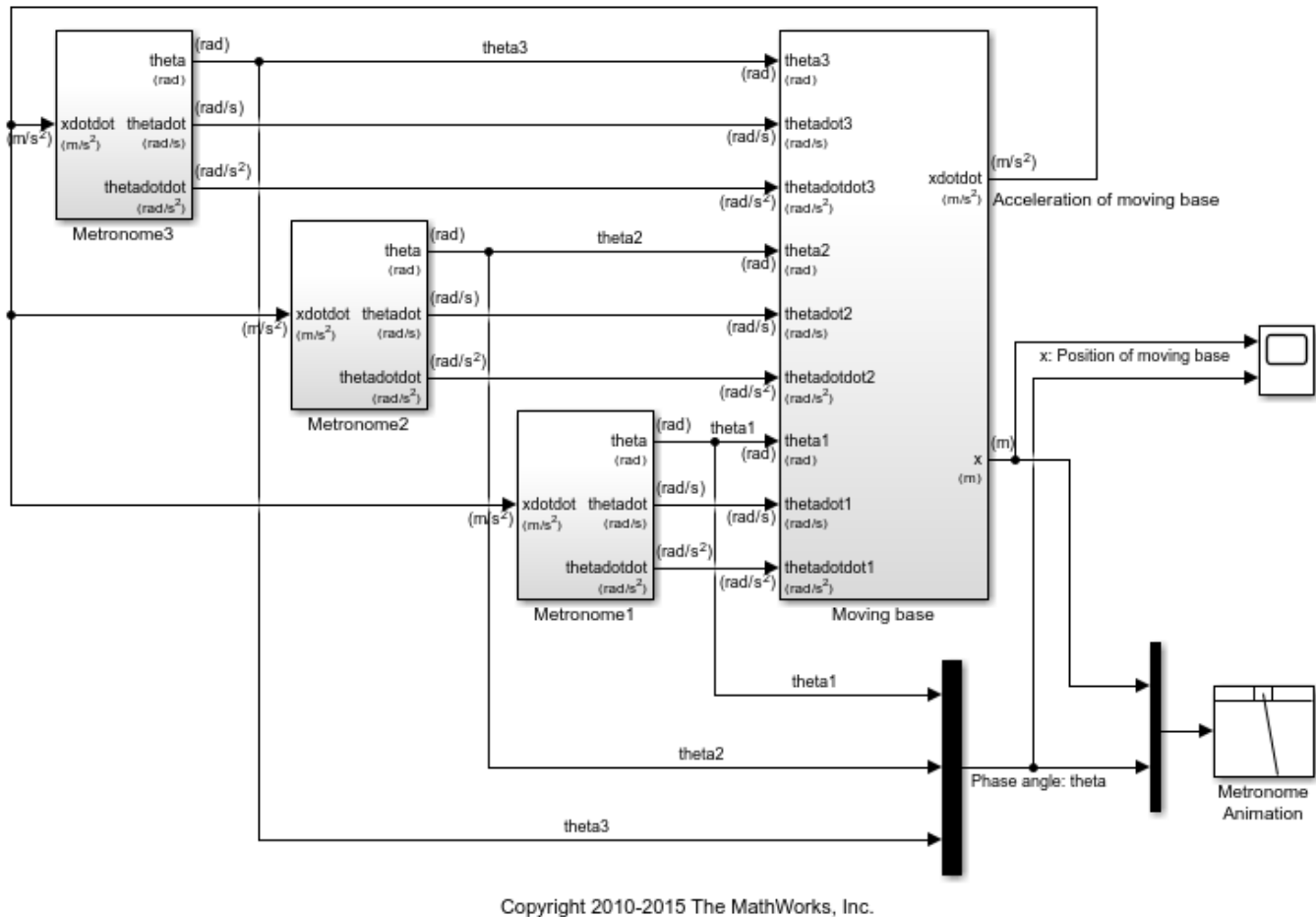
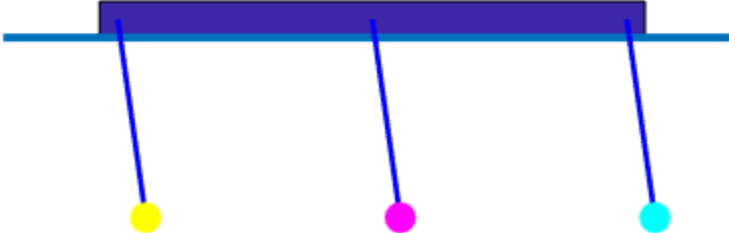

Figure 2: The Simulink model of the metronomes system

Simulation of this system shows an interesting phenomenon: Synchronization. It shows that all three metronomes with different initial phase angle eventually become synchronized with each other. Figure 3 shows the simulation results. The main cause for synchronization is the moving base that links all these metronomes together. This physical connection can be observed from the dynamic equation of each metronome.

Also, this physical connection can also be observed from the solver Jacobian pattern of this model. The following MATLAB® code shows how to get the solver Jacobian pattern.



Time: 40

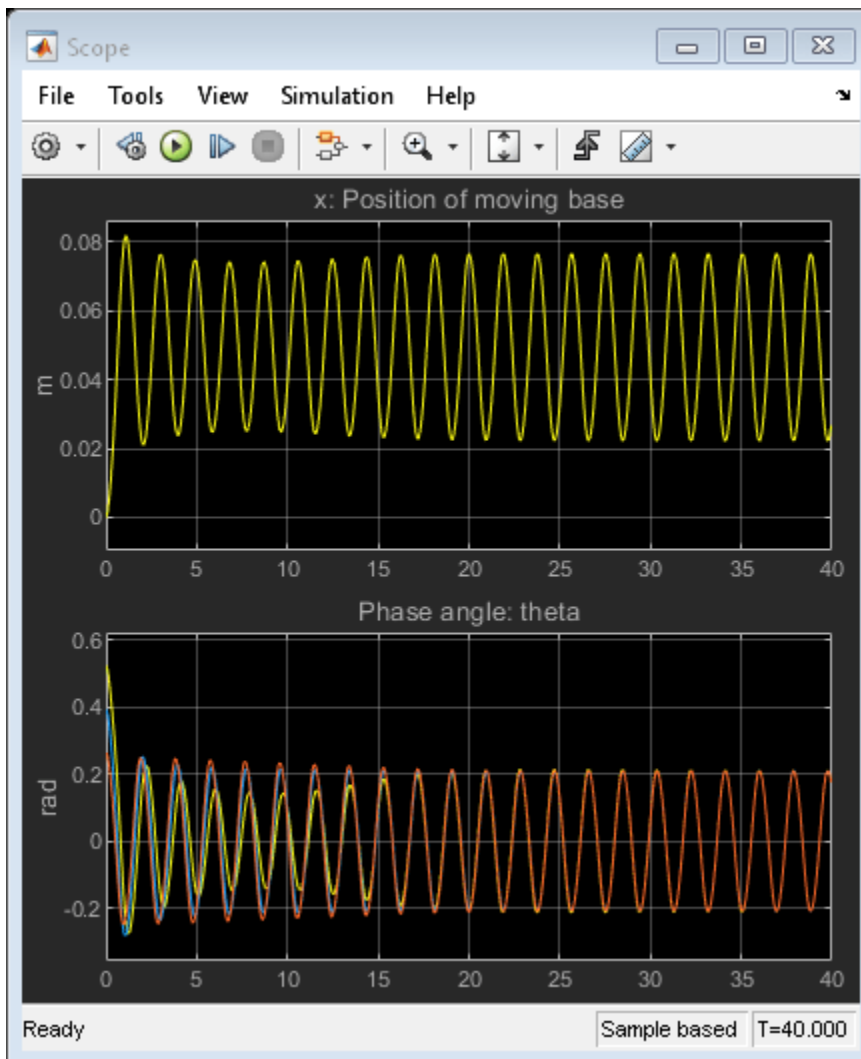

Figure 3: The synchronized metronomes

Steps to Get the Solver Jacobian Pattern

% 1. Set the solver to be any implicit solver

```
set_param mdl, 'Solver', 'ode15s');
```

% 2. Set the solver Jacobian method to be Sparse perturbation *

```
set_param mdl, 'SolverJacobianMethodControl', 'SparsePerturbation');
```

% 3. Get the solver Jacobian object.

```
J = Simulink.Solver.getSlvrJacobianPattern(mdl);
disp('J = ');
disp(J);
```

% 4. Show the pattern in a figure. use the method J.show

```
J.show;
```

% 5. Explore the pattern with the given state name and other information

```
stateNames = J.stateNames;
disp('stateNames = ');
disp(stateNames);
```

The results you will see are:

```
J =
SlvrJacobianPattern with properties:

    Jpattern: [8x8 double]
  numColGroup: 6
    colGroup: [8x1 double]
  stateNames: {8x1 cell}
  blockHandles: [8x1 double]

stateNames =
{'sldemo_metro/Moving base/Integrator1'           }
{'(sldemo_metro/Metronome1/Integrator2).(Theta1)' }
{'(sldemo_metro/Metronome2/Integrator2).(Theta2)' }
{'(sldemo_metro/Metronome3/Integrator2).(Theta3)' }
{'(sldemo_metro/Metronome3/Integrator1).(Thetadot_3)'}
{'(sldemo_metro/Metronome2/Integrator1).(Thetadot_2)'}
{'(sldemo_metro/Metronome1/Integrator1).(Thetadot_1)'}
{'sldemo_metro/Moving base/Integrator'           }
```

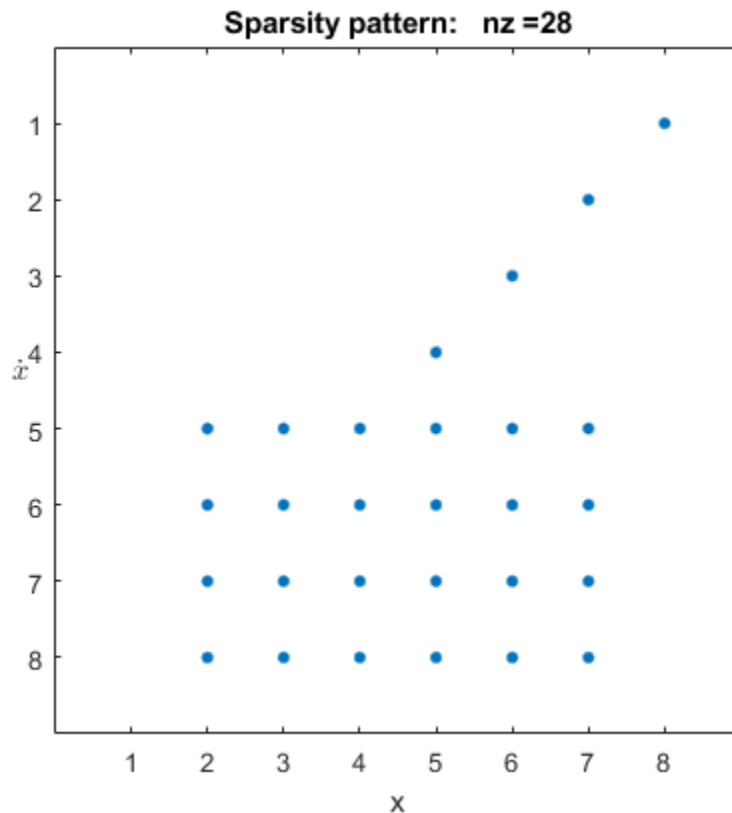

Figure 4: The solver Jacobian pattern

Properties of the Solver Jacobian Pattern Object

The solver Jacobian pattern J is an object. It contains the following properties:

`Jpattern`: A sparse mxArray which is the Jacobian pattern.

`numColGroup`: Number of column groups.

`colgroup`: A column partition of the sparse pattern matrix.

`stateNames`: A cell array containing the state name of each state.

`blockHandles`: Block handles of the owner of each state.

Study of the Solver Jacobian Pattern

Referring to Figure 4. First, the solver Jacobian of this model is sparse and the number of non-zero element is 28. Secondly, the number of column groups is 6; is less than the number of states 8.

The row 1-4 indicates the following dependencies:

$$\begin{aligned}\dot{x}_1 &\leftarrow x_8(\text{baseposition} \leftarrow \text{baseseed}) \\ \dot{x}_2 &\leftarrow x_7(\dot{\text{Theta}}1 \leftarrow \text{Thetadot1}) \\ \dot{x}_3 &\leftarrow x_6(\dot{\text{Theta}}2 \leftarrow \text{Thetadot2}) \\ \dot{x}_4 &\leftarrow x_5(\dot{\text{Theta}}3 \leftarrow \text{Thetadot3})\end{aligned}$$

These relations are clear since speed is the derivative of position. Row 5-8 shows the following relations:

$$\begin{aligned}\dot{x}_5 &\leftarrow x_{2-7} \\ \dot{x}_6 &\leftarrow x_{2-7} \\ \dot{x}_7 &\leftarrow x_{2-7} \\ \dot{x}_8 &\leftarrow x_{2-7}\end{aligned}$$

These relations show that to compute the angular acceleration of the metronomes or acceleration of the moving base, the angular position and angular speed of the metronomes are needed, but not the position and speed of the base. These relations can be found by studying eq.(1) and eq.(2) directly.

Conclusion

The Solver Jacobian pattern is a tool to study the data dependency relations between the derivatives of the state variables and the state variables. These relations usually reflect certain physical couplings in the physical system. By using the tools provided, you can discover these relations associated with a Simulink model, even without the original dynamic equations of the physical model.

References

- [1] Arkady Pikovsky, Michael Rosenblum, and Jurgen Kurths. Synchronization. Cambridge University Press, 2001.
- [2] Ward T. Oud, Design and experimental results of synchronizing metronomes, inspired by Christiaan Huygens, Master Thesis, Eindhoven University of Technology, 2006.
- [3] Pantaleone, James, American Journal of Physics, Volume 70, Issue 10, pp. 992-1000, 2002.

- Escapement is a set of mechanism that drives the metronome. See [2] for for more details.

Double Bouncing Ball: Use of Adaptive Zero-Crossing Location

This example shows how to choose the correct zero-crossing location algorithm, based on the system dynamics. For Zeno dynamic systems, or systems with strong chattering, you can select the adaptive zero-crossing detection algorithm through the Configure pane:

```
--> Solver
    --> Zero-crossing options
        --> Algorithm: [Nonadaptive, Adaptive]
```

The Double Bouncing Ball System

The Simulink® model in this example is used to simulate two bouncing balls. They start from the ground with different initial speeds, and their ground levels will change at different times.

Open the model

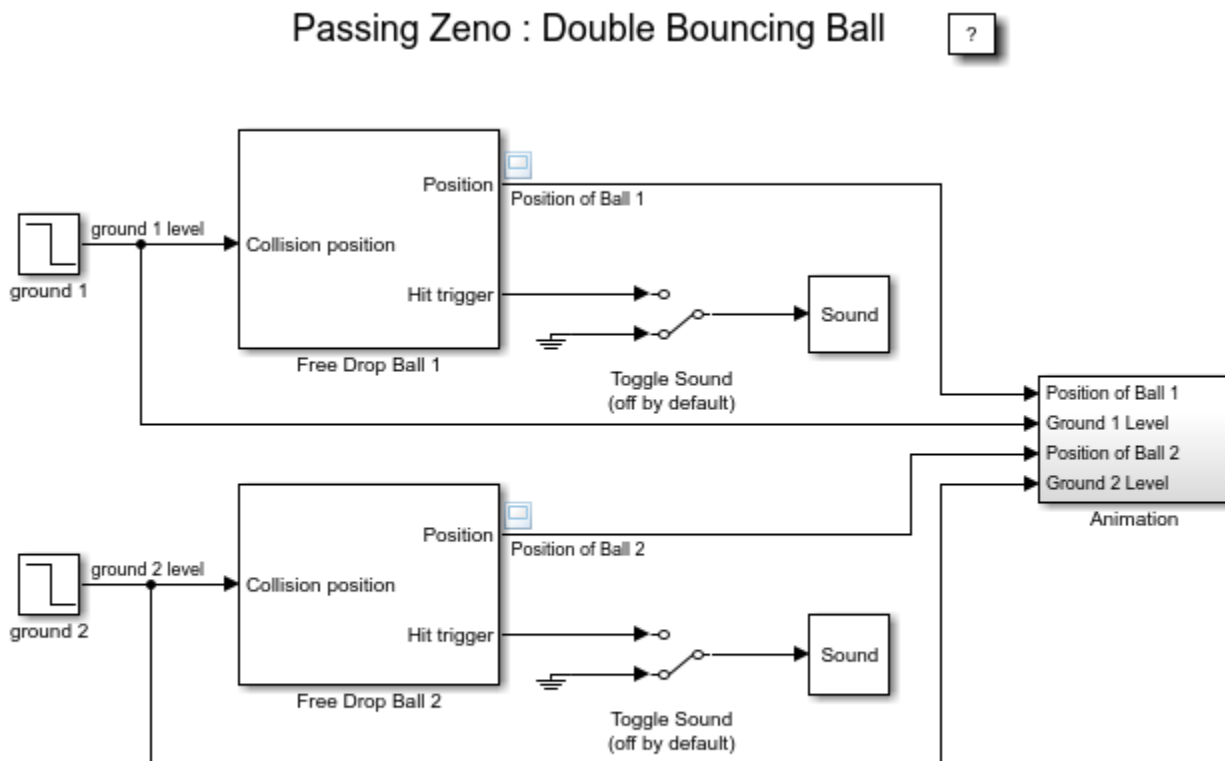

Copyright 1990-2013 The MathWorks, Inc.

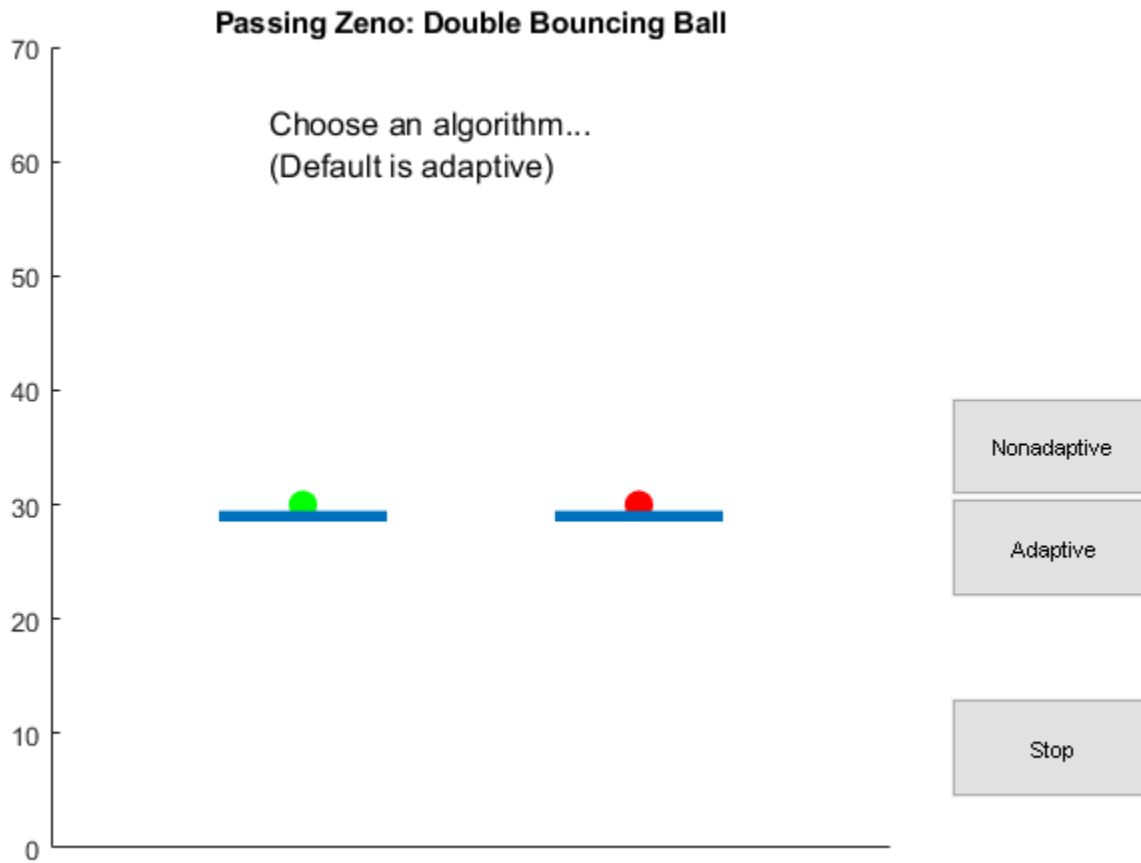
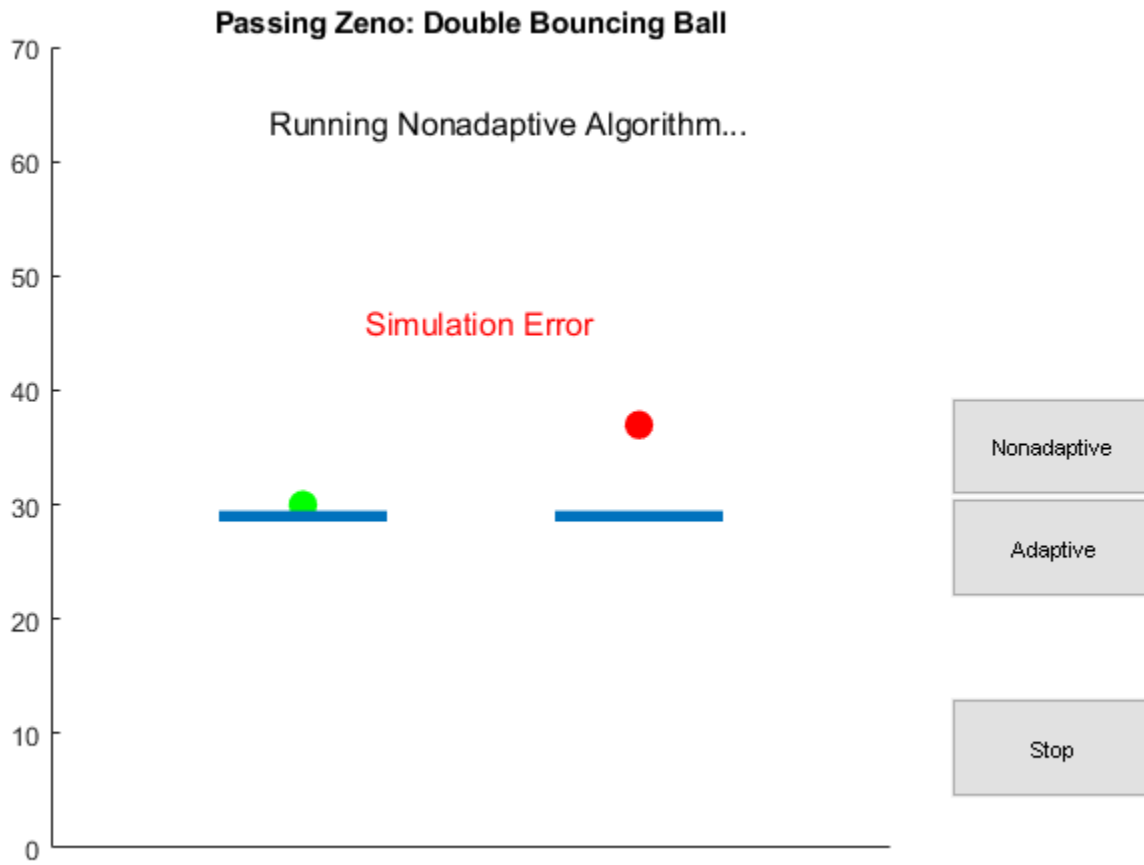
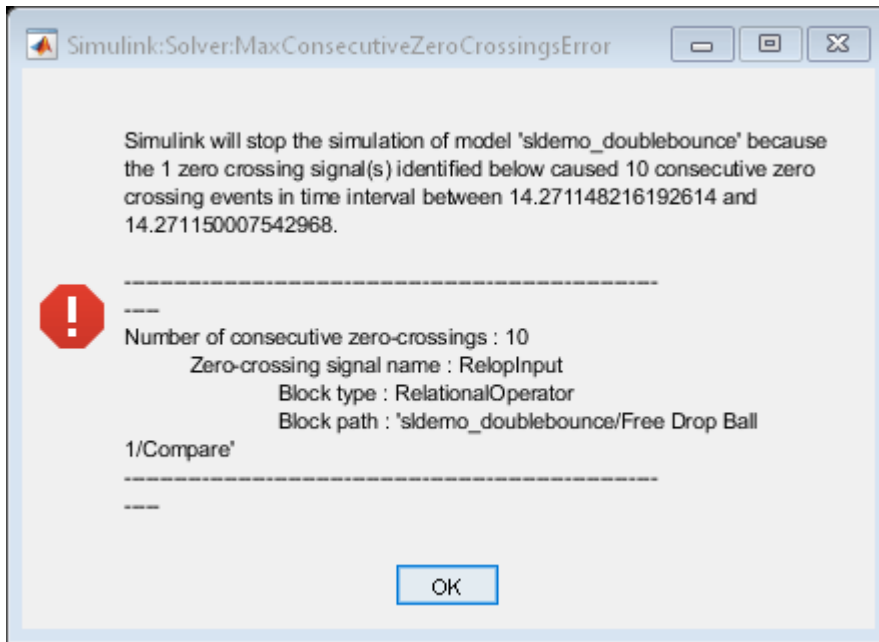

Figure 1: The double bouncing ball model and animation

Double Bouncing Balls With Non-adaptive Zero-Crossing Location Algorithm

If the Non-adaptive zero-crossing location algorithm is used, the consecutive zero-crossing error causes the simulation to stop. This system is actually a 'Zeno dynamic system'. When either ball is very close to the ground, Simulink will hang because too many zero crossings are detected in a very short period.





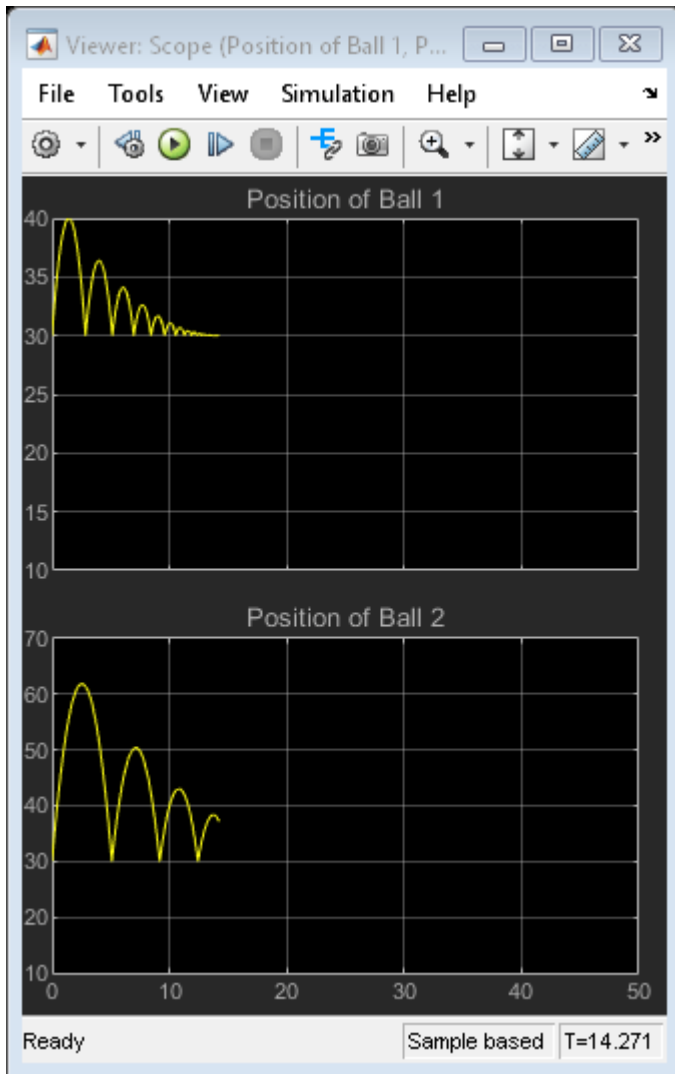

Figure 2: Vertical displacement of both balls with Non-adaptive zero-crossing location algorithm.

The simulation does not complete and an error message is shown. The ground level changing events cannot be observed.

Double Bouncing Balls With Adaptive Zero-Crossing Location Algorithm

If the adaptive algorithm is selected, Simulink will adaptively turn on/off the process to precisely locate the zero-crossing time. The conditions to turn on/off the location are:

1) Zero-crossing signal value is below a threshold value. You can control the threshold value through the Configure pane:

```
--> Solver
    --> Zero-crossing options
        --> Algorithm: [Adaptive]
        --> Signal threshold
```

2) Consecutive zero-crossing diagnostic is hit. You can define consecutive zero crossing through the Configure pane:

```
--> Solver
--> Solver diagnostic controls
--> Time tolerance and
--> Number of consecutive zero crossings.
```

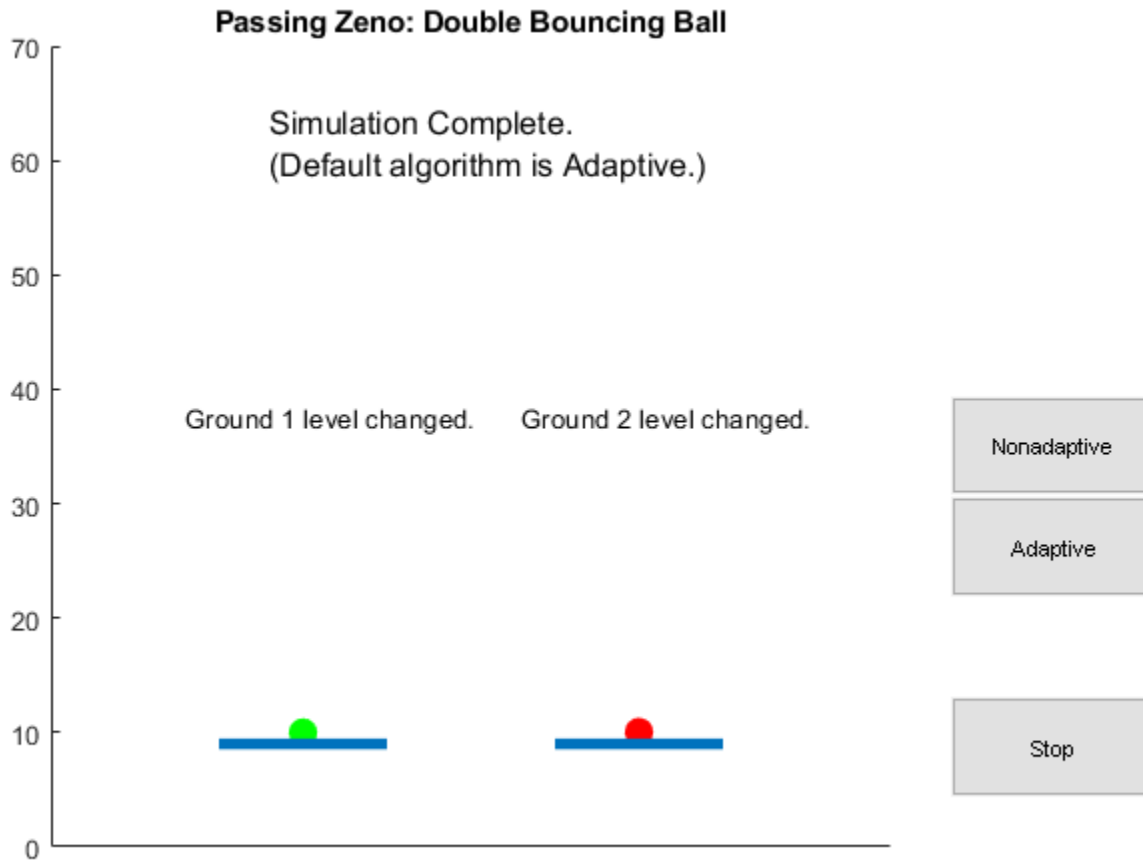

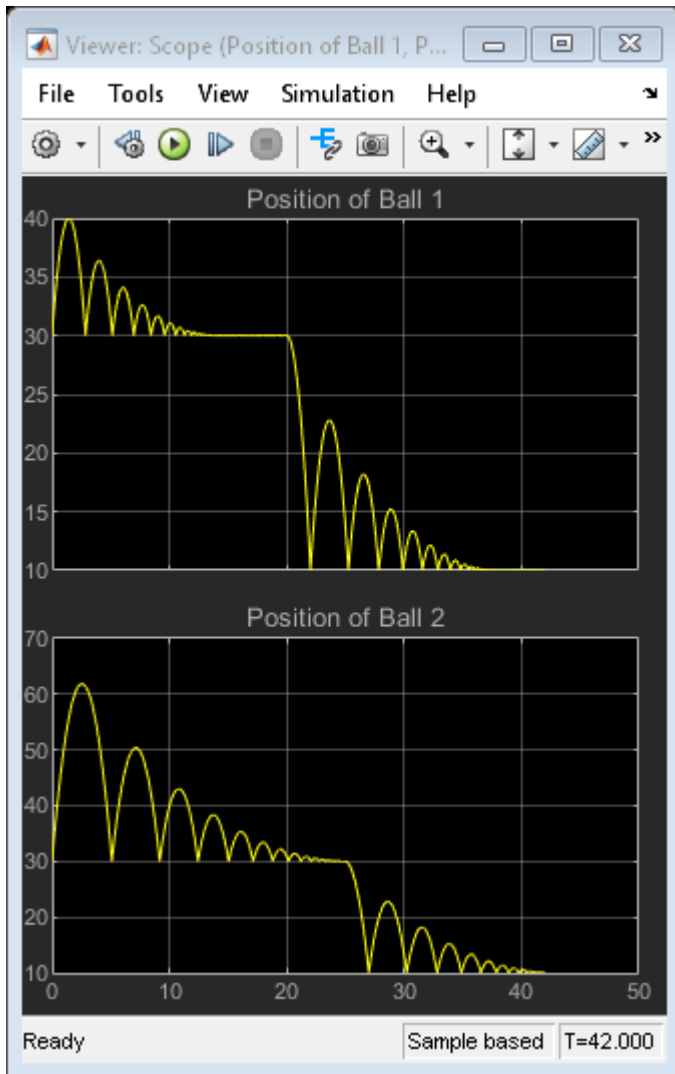

Figure 3: Vertical displacement of both balls with adaptive zero crossing location algorithm.

The simulation has completed. The ground level changing events can be observed. A warning is shown to inform you when searching for events is turned off.

Four Hydraulic Cylinder Simulation

This example shows how to use Simulink® to create a model with four hydraulic cylinders. See two related examples that use the same basic components: single cylinder model and model with two cylinders and load constraints.

- Note: This is a basic hydraulics example. You can more easily build hydraulic and automotive models using Simscape™ Driveline™ and Simscape Fluids™.
- **Simscape Fluids** provides component libraries for modeling and simulating fluid systems. It includes models of pumps, valves, actuators, pipelines, and heat exchangers. You can use these components to develop fluid power systems such as front-loader, power steering, and landing gear actuation systems. Engine cooling and fuel supply systems can also be developed with Simscape Fluids. You can integrate mechanical, electrical, thermal, and other systems using components available within the Simscape product family.
- **Simscape Driveline** provides component libraries for modeling and simulating one-dimensional mechanical systems. It includes models of rotational and translational components, such as worm gears, planetary gears, lead screws, and clutches. You can use these components to model the transmission of mechanical power in helicopter drivetrains, industrial machinery, vehicle powertrains, and other applications. Automotive components, such as engines, tires, transmissions, and torque converters, are also included.

Modeling

Figure 1 shows the top level diagram of the model. This model has a single pump and four actuators. The same pump pressure (p_1) drives each cylinder assembly and the sum of their flows loads the pump. Although each of the four control valves could be controlled independently, as in an active suspension system, in this case all four receive the same commands, a linear ramp in orifice area from zero to 0.002 sq.m. .

Opening the Model and Running the Simulation

To open this model, type `sldemo_hydcyl4` at MATLAB® terminal (click on the hyperlink if you are using MATLAB Help). Press the "Play" button on the model toolbar to run the simulation.

The model logs relevant data to MATLAB workspace, into the Simulink.SimulationOutput object `out`. The signal logging data is stored within `out`, in a structure called `sldemo_hydcyl4_output`. Logged signals have a blue indicator (see the model). For more information, see "View and Access Signal Logging Data".

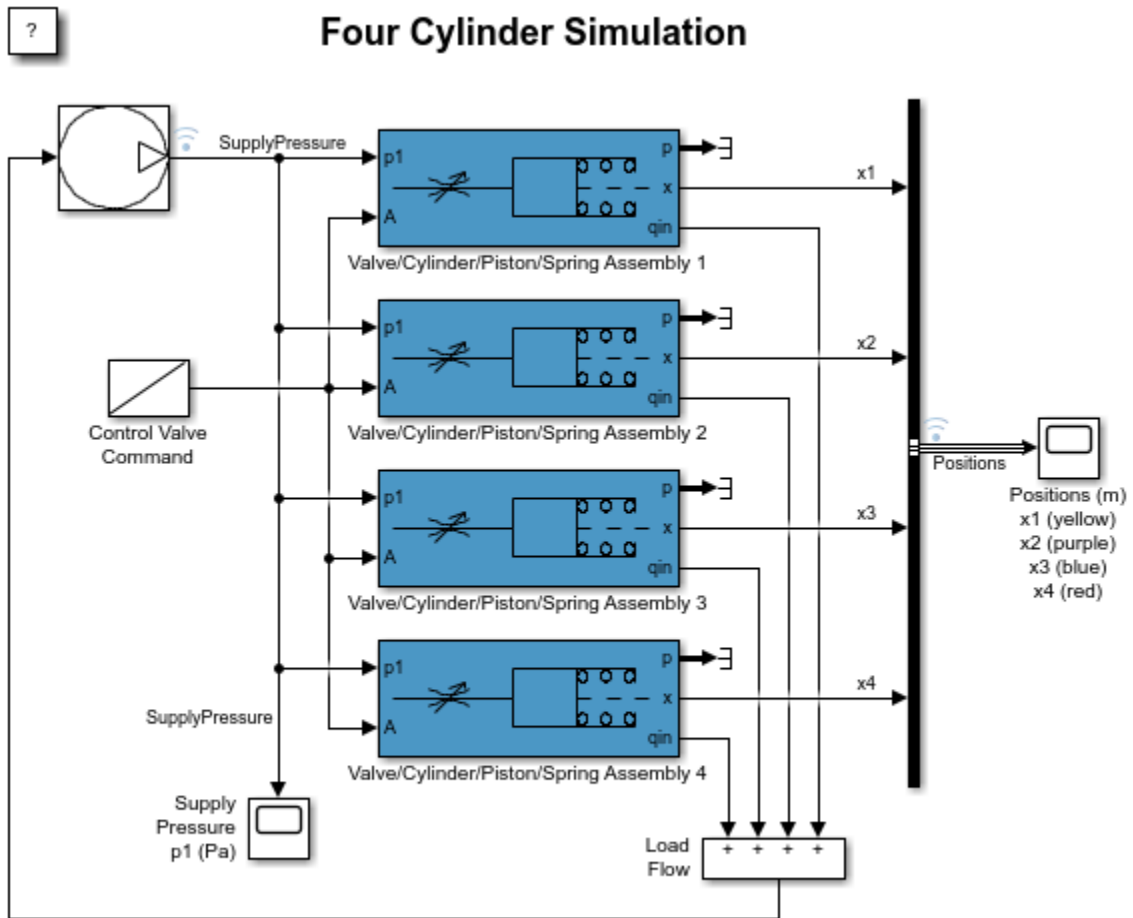

Copyright 1990-2012 The MathWorks, Inc.

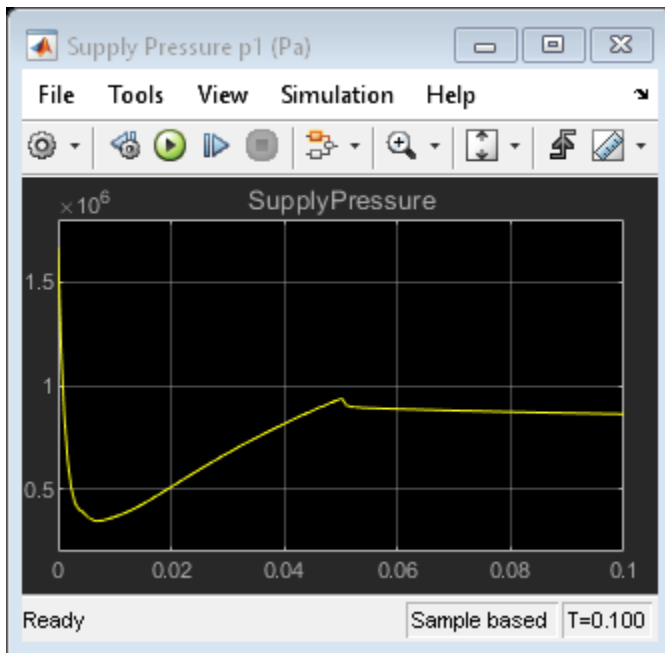
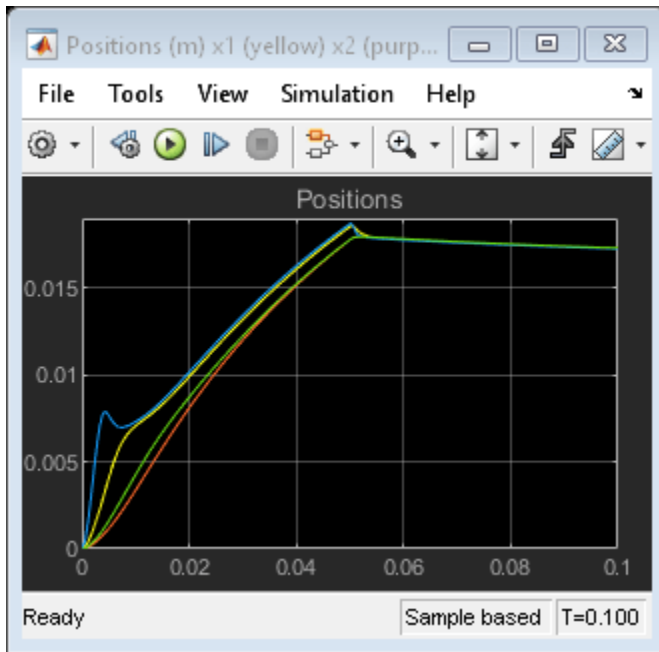

Figure 1: Four cylinder model and simulation results

Model Description

The pump flow begins at $0.005 \text{ m}^3/\text{sec}$ (just like in the single cylinder model), then it drops to $0.0025 \text{ m}^3/\text{sec}$ at $t=0.05 \text{ sec}$. The parameters $C1$, $C2$, Cd , ρ , and $V30$ are identical to those in the single cylinder model. However, by assuming individual values for K , A , and β , each one of the four cylinders exhibit distinctive transient responses. The table below gives the characteristics of the four actuators.

| Parameter | Actuator1 | Actuator2 | Actuator3 | Actuator4 |
|-----------------|-----------|-----------|-----------|-----------|
| Spring Constant | K | K/4 | 4K | K |
| Piston Area | Ac | Ac/4 | 4Ac | Ac |
| Bulk Modulus | Beta | Beta | Beta | Beta/1000 |

Beta = 7e8 Pa [fluid bulk modulus]
 K = 5e4 N/m [spring constant]
 Ac = 1e-3 m² [cylinder cross-sectional area]

The ratio of area and spring constant is the same for all pistons, so they should have the same steady state output. The dominant time constant for each actuator subsystem is proportional to

$$\frac{A_c^2}{K}$$

(result obtained from dimensional analysis), so we can expect the piston assembly 2 to be somewhat faster than assembly 1. The piston assembly 3 is expected to be slower than 1 or 2. The piston assembly 4 has a significantly lower bulk modulus beta (as would be the case with air), thus we expect piston 4 to respond more sluggishly than piston 1.

Results

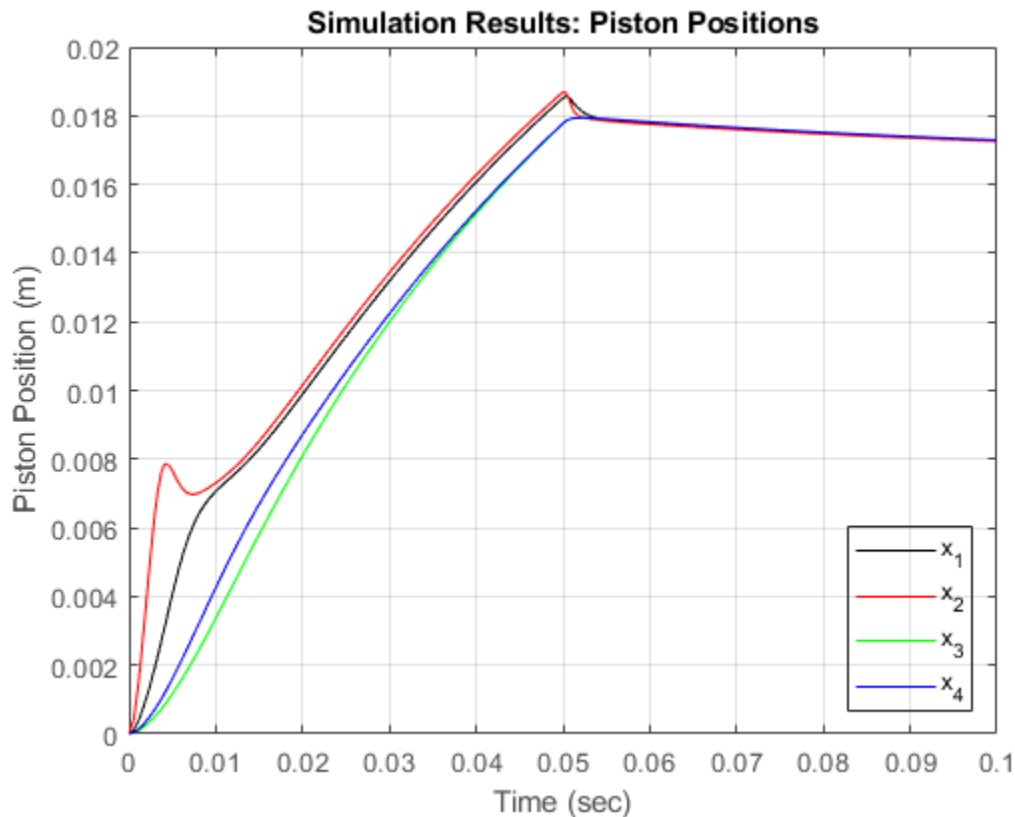

Figure 2: Piston positions in four cylinder example

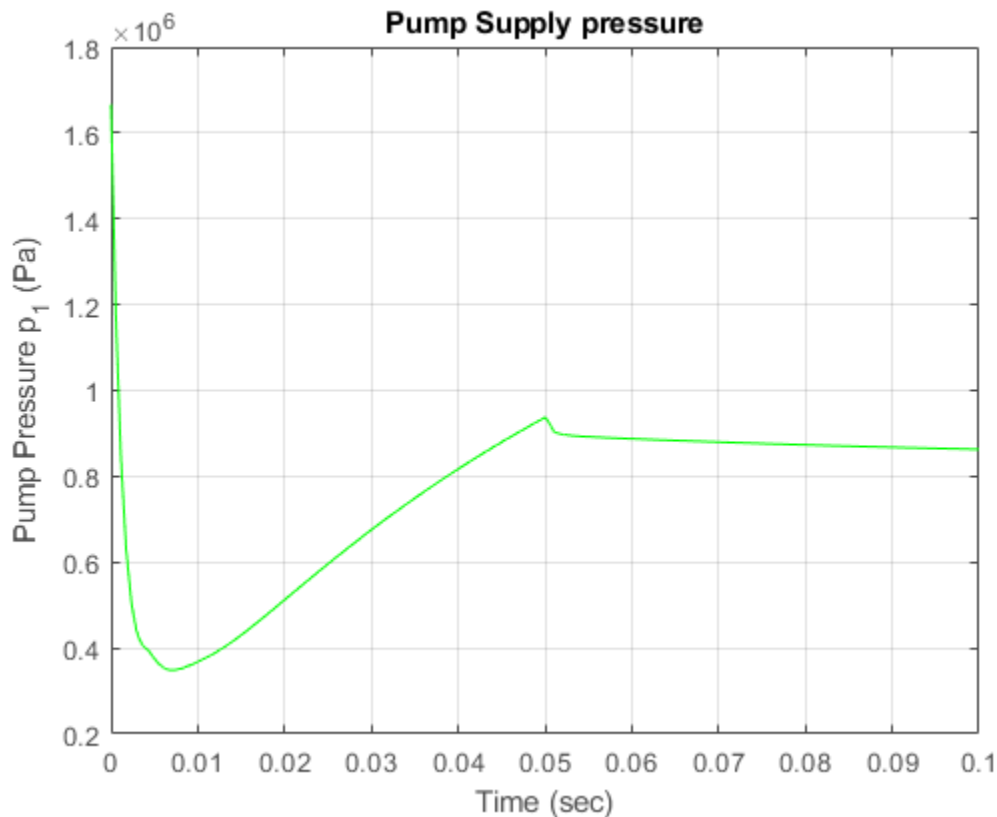

Figure 3: Pump Supply Pressure, p_1

The initial jolt of flow at $t=0$ is seen by the four actuators as a pressure impulse. The pump pressure (p_1), which is initially high, drops rapidly because there is a high flow demand from the four loads. During the initial transient (about 4 msec), distinct responses identify the individual dynamic characteristics of each assembly unit.

As predicted by the parameter values, actuator 2 responds much faster than actuator 1. The third and fourth pistons are much slower because they require more working fluid to move the same distance. In case 3, the piston displaces more volume due to its larger cross-sectional area. In case 4, although the displaced volume is the same as in case 1, the device requires more fluid because it is subsequently compressed.

As the pump pressure falls to the level within the cylinders, the distinctions in behavior are blurred. The individual responses blend into an overall system response which maintains the flow balance between the components. At $t=0.05$ sec, the pump flow drops to a level that is close to the equilibrium and the actuator flows are nearly zero. The individual steady state piston positions are equal, as predicted by the design.

Closing the Model

Close the model. Clear generated data.

See Also

Circular Gauge | Linear Gauge

Related Examples

- “Single Hydraulic Cylinder Simulation” on page 13-11
- “Two Cylinder Model with Load Constraints” on page 13-106

More About

- “Decide How to Visualize Simulation Data”

Two Cylinder Model with Load Constraints

This example shows how to model a rigid rod supporting a large mass interconnecting two hydraulic actuators. The model eliminates the springs as it applies the piston forces directly to the load. These forces balance the gravitational force and result in both linear and rotational displacement.

See two related examples that use the same basic components: four cylinder model and single cylinder model.

- Note: This is a basic hydraulics example. You can more easily build hydraulic and automotive models using Simscape™ Driveline™ and Simscape Fluids™.
- **Simscape Fluids** provides component libraries for modeling and simulating fluid systems. It includes models of pumps, valves, actuators, pipelines, and heat exchangers. You can use these components to develop fluid power systems such as front-loader, power steering, and landing gear actuation systems. Engine cooling and fuel supply systems can also be developed with Simscape Fluids. You can integrate mechanical, electrical, thermal, and other systems using components available within the Simscape product family.
- **Simscape Driveline** provides component libraries for modeling and simulating one-dimensional mechanical systems. It includes models of rotational and translational components, such as worm gears, planetary gears, lead screws, and clutches. You can use these components to model the transmission of mechanical power in helicopter drivetrains, industrial machinery, vehicle powertrains, and other applications. Automotive components, such as engines, tires, transmissions, and torque converters, are also included.

Analysis and Physics of the Model

We assume the rotation angle of the rod is small. The equations of motion for the rod are given below in Equation Block 1. The equations describing the cylinder and pump behavior are the same as in the single cylinder example.

Equation Block 1:

$$M \frac{d^2 z}{dt^2} = F_b + F_a + F_{ext}$$

$$I \frac{d^2 \theta}{dt^2} = \frac{L}{2} F_b - \frac{L}{2} F_a$$

z – displacement at the center

M – total mass

F_a – piston A force

F_b – piston B force

F_{ext} – external force at center

θ – clockwise angular displacement

I – moment of inertia of the rod

L – rod length

The positions and velocities of the individual pistons follow directly from the geometry. See the corresponding equations below in Equation Block 2.

Equation Block 2:

$$z_a = z - \theta \frac{L}{2}$$

$$z_b = z + \theta \frac{L}{2}$$

$$\frac{dz_a}{dt} = \frac{dz}{dt} - \frac{d\theta}{dt} \frac{L}{2}$$

$$\frac{dz_b}{dt} = \frac{dz}{dt} + \frac{d\theta}{dt} \frac{L}{2}$$

z_a – piston A displacement

z_b – piston B displacement

Opening the Model and Running the Simulation

To open this model, type `sldemo_hydrod` into the MATLAB® Command Window (click the hyperlink if you are using MATLAB Help). To run the simulation, on the Simulation tab, press **Run**. The model:

- Logs signal data to the MATLAB workspace in the `Simulink.SimulationOutput` object `out`. The signal logging data is stored in `out`, in a `Simulink.SimulationData.Dataset` object called `sldemo_hydrod_output`.
- Logs continuous states data to MATLAB workspace. The states data is also contained in the `out` workspace variable, as a structure called `xout`. Each state is assigned a name in the model to facilitate working with logged data. The names of the states are available in the `stateName` field of `xout.signals`. For more information, see “Data Format for Logged Simulation Data”.
- Uses the customizable Circular Gauge and Vertical Gauge blocks to visualize the fluid flow, pressure, and linear displacement in the cylinders.

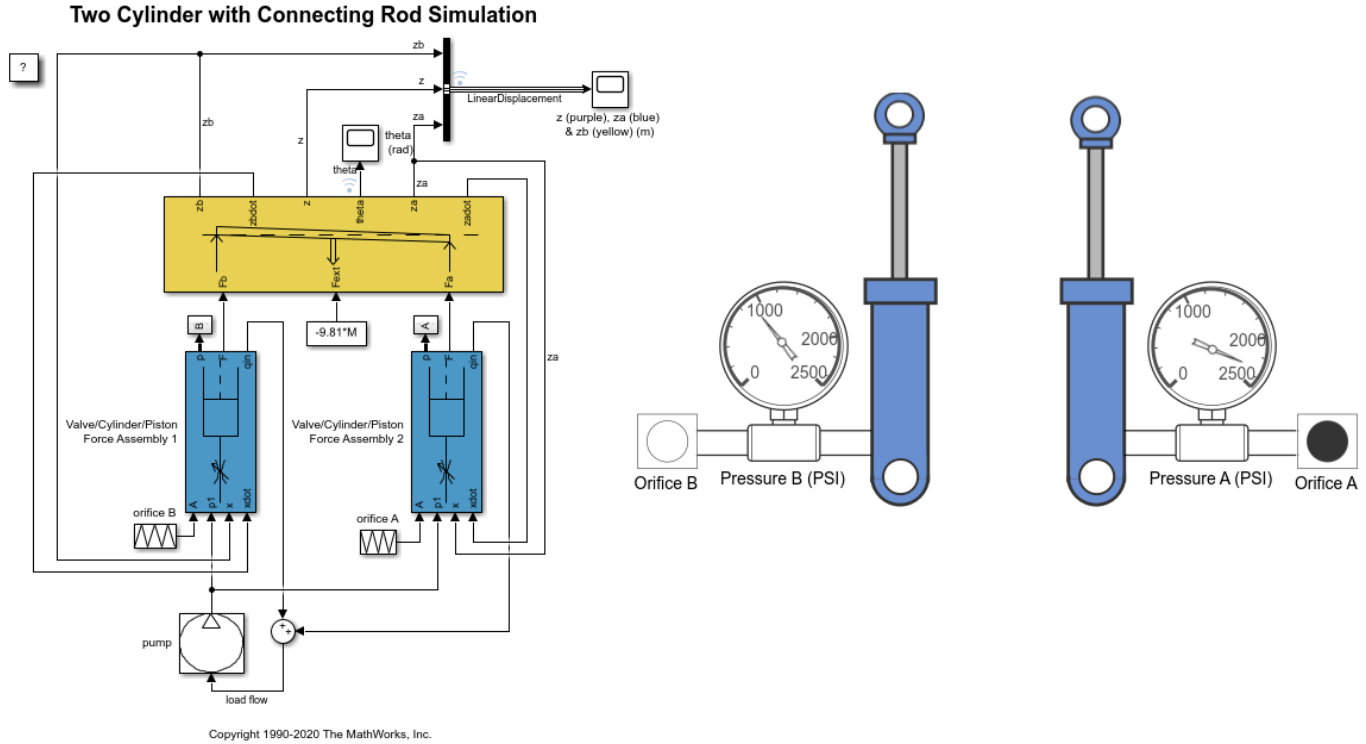

Figure 1: Two cylinder model and simulation results

'Mechanical Load' Subsystem

This subsystem is shown in Figure 2. It solves the equations of motion, which we compute directly using standard Simulink blocks. It is assumed that the rotation angle is small. Look under the mask of the 'Mechanical Load' subsystem to see its structure (right-click on the subsystem and select **Mask > Look Under Mask**).

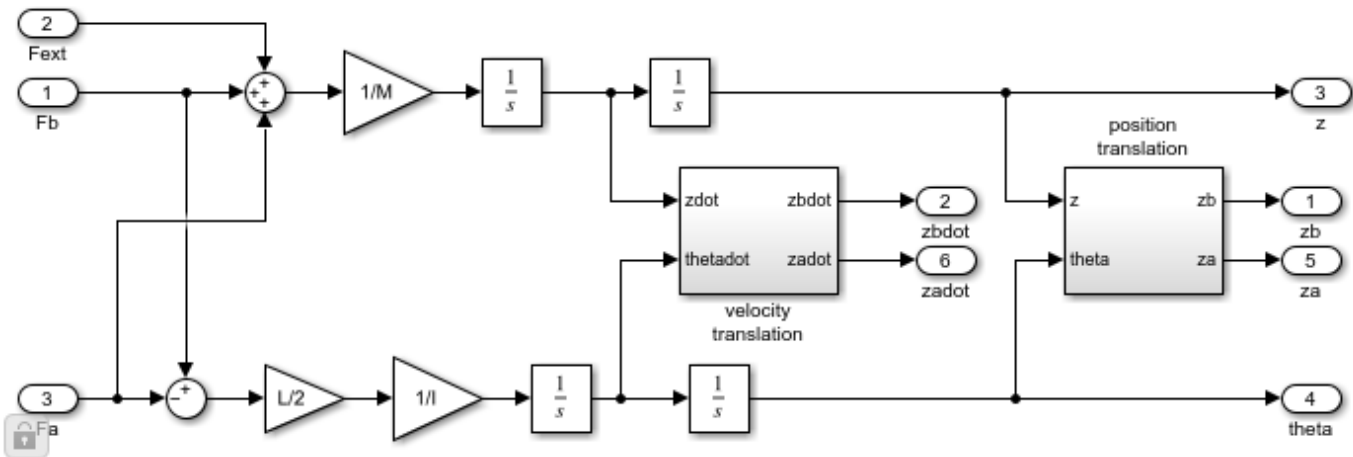

Figure 2: 'Mechanical Load' subsystem

Simulation Parameters

The parameters used in this simulation are identical to the parameters used in the single cylinder model, except for the following:

$L = 1.5 \text{ m}$
 $M = 2500 \text{ kg}$
 $I = 100 \text{ kg/m}^2$
 $Q_{\max} = 0.005 \text{ m}^3/\text{sec}$ (constant)
 $C_2 = 3e-9 \text{ m}^3/\text{sec}/\text{Pa}$
 $F_{\text{ext}} = -9.81 * M \text{ Newtons}$

Although the pump flow is constant, the model controls the valves independently. Initially, at $t = 0$, the cross-section of valve B is zero. It grows linearly to $1.2e-5 \text{ m}^2$ at $t = 0.01 \text{ sec}$, and then linearly decreases to zero at $t = 0.02 \text{ sec}$. The cross-section of valve A is $1.2e-5 \text{ sq.m.}$ at $t = 0$ and it linearly decreases to zero at $t = 0.01 \text{ sec}$, then it linearly increases to $1.2e-5 \text{ sq.m.}$ at $t = 0.02 \text{ sec}$. Then the behavior of the valves A and B repeats periodically with the same pattern. In other words the valves A and B are 180 degrees out of phase.

Results

Figures 3 and 4 show the linear and angular displacements of the rod. The linear displacement response is typical of a type-one integrating system. The relative positions and the angular movement of the rod illustrate the response of the two pistons to the out-of-phase control signals (the cross-section of the valves A and B).

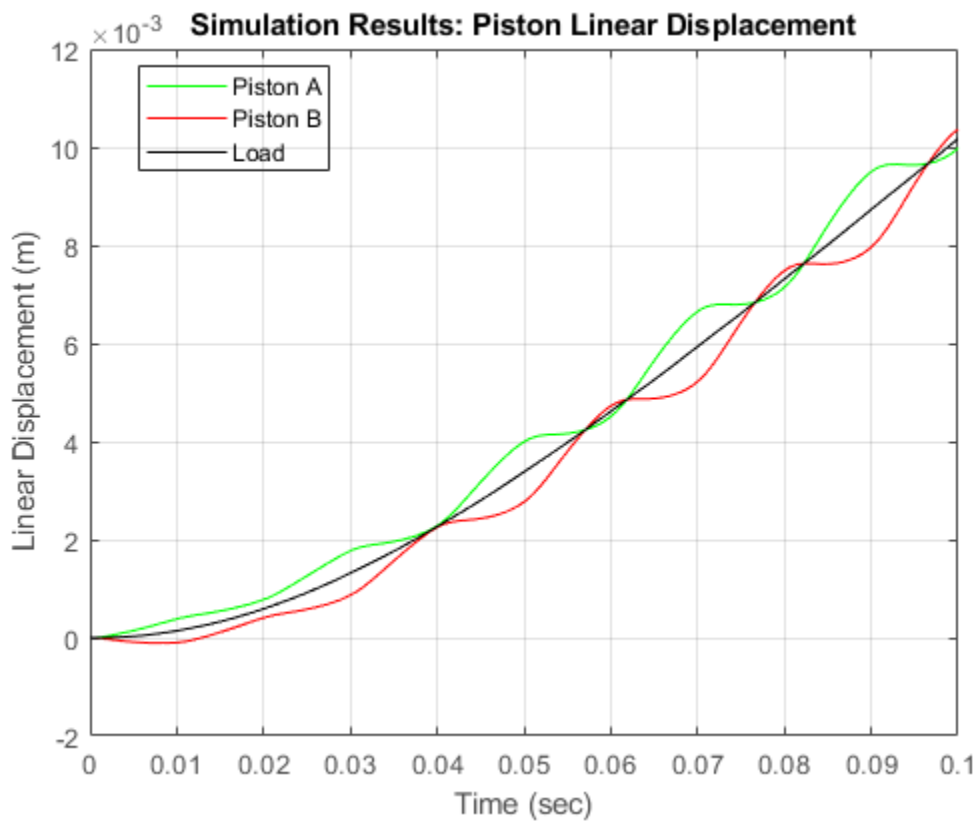

Figure 3: Linear displacement of the pistons and the load (load is in the middle of the rod)

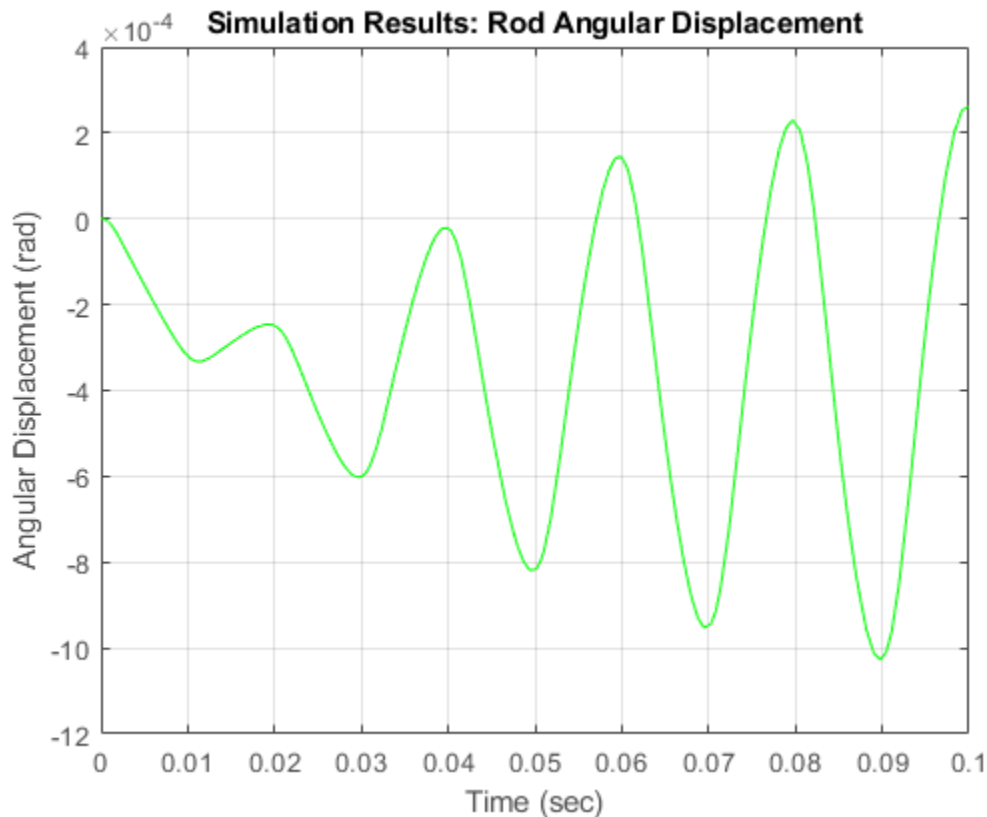

Figure 4: Angular displacement of the rod

Close Model

Close the model and clear all generated data.

Conclusions

Simulink provides a productive environment for simulating hydraulic systems, offering enhancements that provide enormous productivity in modeling and flexibility in numerical methods. The use of masked subsystems and model libraries facilitates structured modeling with automatic component updates. As users modify library elements, the models that use the elements automatically incorporate the new versions. Simulink can use differential-algebraic equations (DAEs) to model some fluid elements as incompressible and others as compliant, allowing efficient solutions for complex systems of interdependent circuits.

Models such as this one can ultimately be used as part of overall plant or vehicle systems. The hierarchical nature of Simulink allows independently developed hydraulic actuators to be placed, as appropriate, in larger system models (for example adding controls in the form of sensors or valves). In cases such as these, tools from the Control System Toolbox™ can analyze and tune the overall closed-loop system. The MATLAB/Simulink environment can thus support the entire design, analysis, and modeling cycle.

See Also

Circular Gauge | Linear Gauge

Related Examples

- “Single Hydraulic Cylinder Simulation” on page 13-11
- “Four Hydraulic Cylinder Simulation” on page 13-100

More About

- “Decide How to Visualize Simulation Data”
- “Tune and Visualize Your Model with Dashboard Blocks”

Modeling a Fault-Tolerant Fuel Control System

This example shows how to combine Stateflow® with Simulink® to efficiently model hybrid systems. This type of modeling is particularly useful for systems that have numerous possible operational modes based on discrete events. Traditional signal flow is handled in Simulink while changes in control configuration are implemented in Stateflow. The model described below represents a fuel control system for a gasoline engine. The system is highly robust in that individual sensor failures are detected and the control system is dynamically reconfigured for uninterrupted operation.

Analysis and Physics

Physical and empirical relationships form the basis for the throttle and intake manifold dynamics of this model. The air-fuel ratio is computed by dividing the air mass flow rate (pumped from the intake manifold) by the fuel mass flow rate (injected at the valves). The ideal (i.e. stoichiometric) mixture ratio provides a good compromise between power, fuel economy, and emissions. The target air-fuel ratio for this system is 14.6. Typically, a sensor determines the amount of residual oxygen present in the exhaust gas (EGO). This gives a good indication of the mixture ratio and provides a feedback measurement for closed-loop control. If the sensor indicates a high oxygen level, the control law increases the fuel rate. When the sensor detects a fuel-rich mixture, corresponding to a very low level of residual oxygen, the controller decreases the fuel rate.

Modeling

Figure 1 shows the top level of the Simulink model. To open the model, click **Open Model**. Press the Play button in the model window toolbar to run the simulation. The model loads necessary data into the model workspace from `sldemo_fuelsys_data.m`. The model logs relevant data to MATLAB workspace in a data structure called `sldemo_fuelsys_output` and streams the data to the Simulation Data Inspector. Logged signals are marked with a blue indicator while streaming signals are marked with the light blue badge (see Figure 1).

Note that loading initial conditions into the model workspace keeps simulation data isolated from data in other open models that you may have open. This also helps avoid MATLAB workspace cluttering. To view the contents of the model workspace select Modeling > Model Explorer, and click on Model Workspace from the Model Hierarchy list.

Notice that units are visible on the model and subsystem icons and signal lines. Units are specified on the ports and on the bus object.

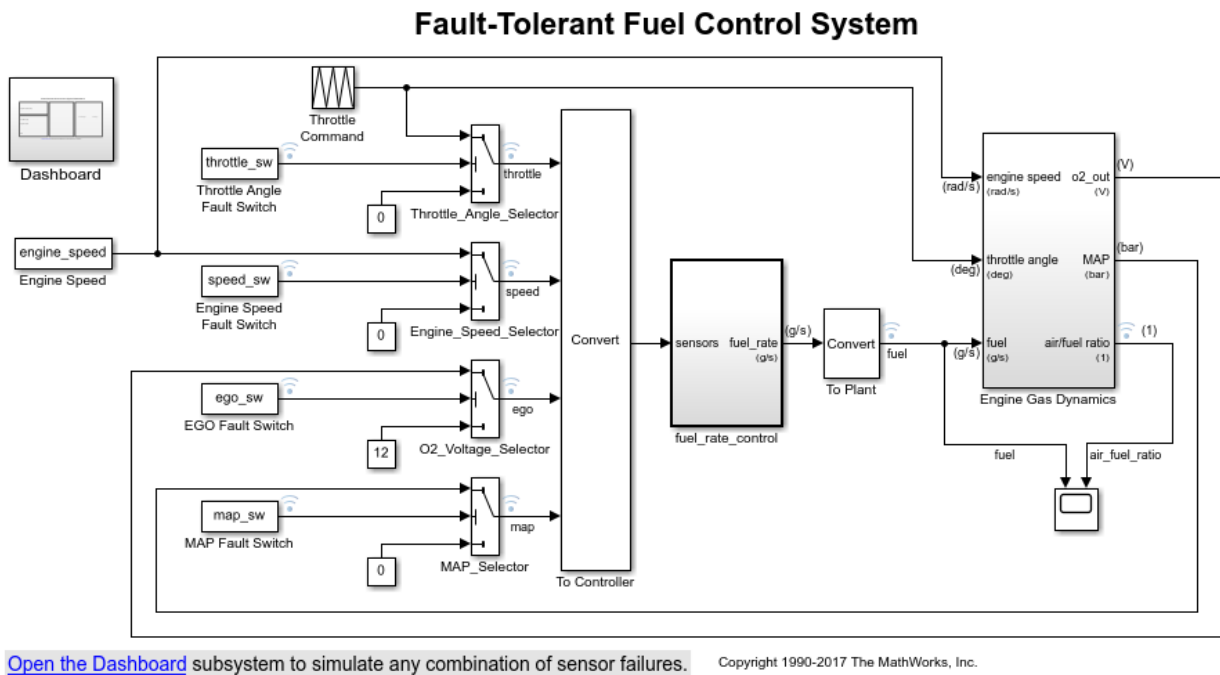
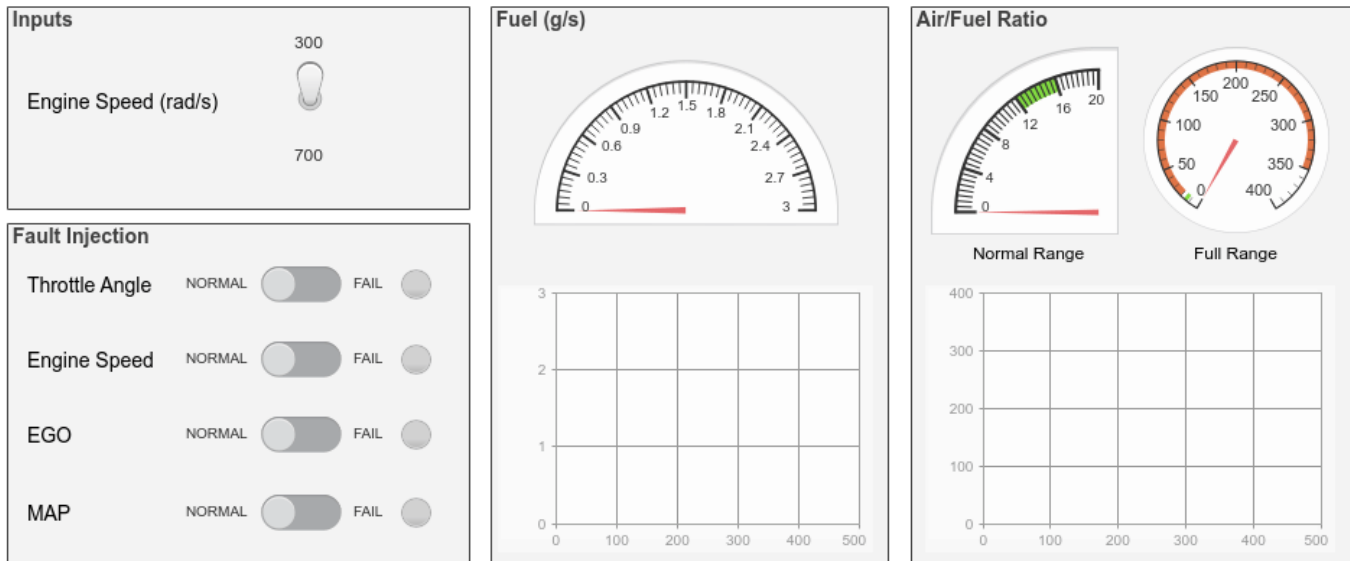

Figure 1: Top-level diagram for the fuel control system model

The Dashboard subsystem (shown in Figure 2) allows you to interact with the model during simulation. The Fault Injection switches can be moved from the Normal to Fail position to simulate sensor failures, while the Engine Speed selector switch can be toggled to change the engine speed. The fuel and air/fuel ratio signals are visualized using the dashboard gauges and scopes to provide visual feedback during a simulation run.

Fault-Tolerant Fuel Control System Dashboard



[Update Diagram](#) (Ctrl+D) to bind switches to model workspace variables.

Figure 2: Dashboard subsystem for the fuel control system model

The `fuel_rate_control` uses signals from the system's sensors to determine the fuel rate which gives a stoichiometric mixture. The fuel rate combines with the actual air flow in the engine gas dynamics model to determine the resulting mixture ratio as sensed at the exhaust.

You can selectively disable each of the four sensors (throttle angle, speed, EGO and manifold absolute pressure [MAP]) by using the slider switches in the dashboard subsystem, to simulate failures. Simulink accomplishes this by binding slider switches to the value parameter of the constant block. Double-click on the dashboard subsystem to open the control dashboard to change the position of the switch. Similarly, you can induce the failure condition of a high engine speed by toggling the engine speed switch on the dashboard subsystem. A Repeating Table block provides the throttle angle input and periodically repeats the sequence of data specified in the mask.

The `fuel_rate_control` block, shown in Figure 3, uses the sensor input and feedback signals to adjust the fuel rate to give a stoichiometric ratio. The model uses three subsystems to implement this strategy: control logic, airflow calculation, and fuel calculation. Under normal operation, the model estimates the airflow rate and multiplies the estimate by the reciprocal of the desired ratio to give the fuel rate. Feedback from the oxygen sensor provides a closed-loop adjustment of the rate estimation in order to maintain the ideal mixture ratio.

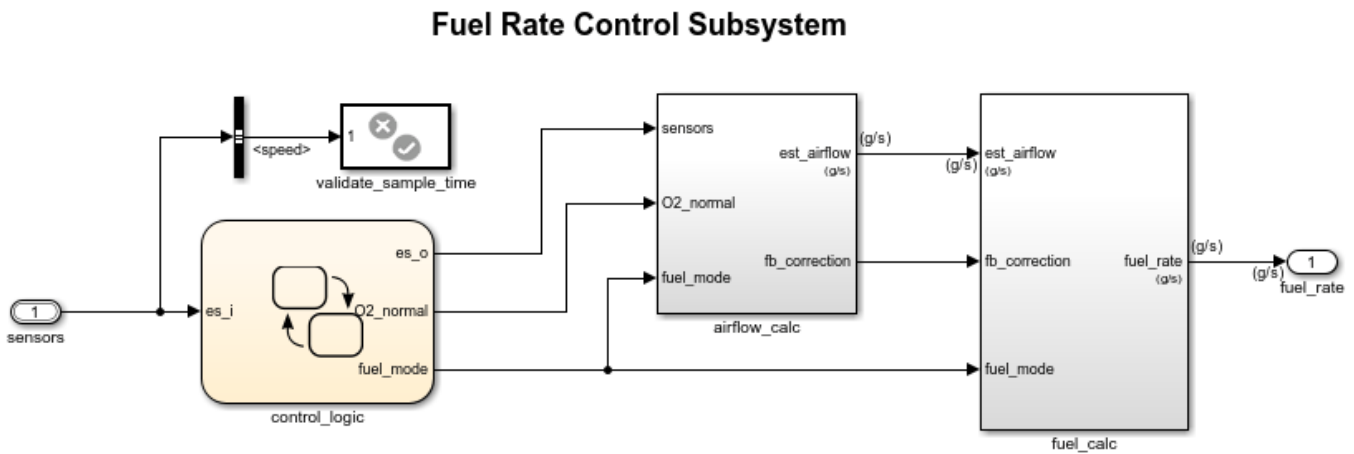

Figure 3: Fuel rate controller subsystem

Control Logic

A single Stateflow chart, consisting of a set of six parallel states, implements the control logic in its entirety. The four parallel states shown at the top of Figure 4 correspond to the four individual sensors. The remaining two parallel states at the bottom consider the status of the four sensors simultaneously and determine the overall system operating mode. The model synchronously calls the entire Stateflow diagram at a regular sample time interval of 0.01 sec. This permits the conditions for transitions to the correct mode to be tested on a timely basis.

To open the `control_logic` Stateflow chart, double-click on it in the `fuel_rate_control` subsystem.

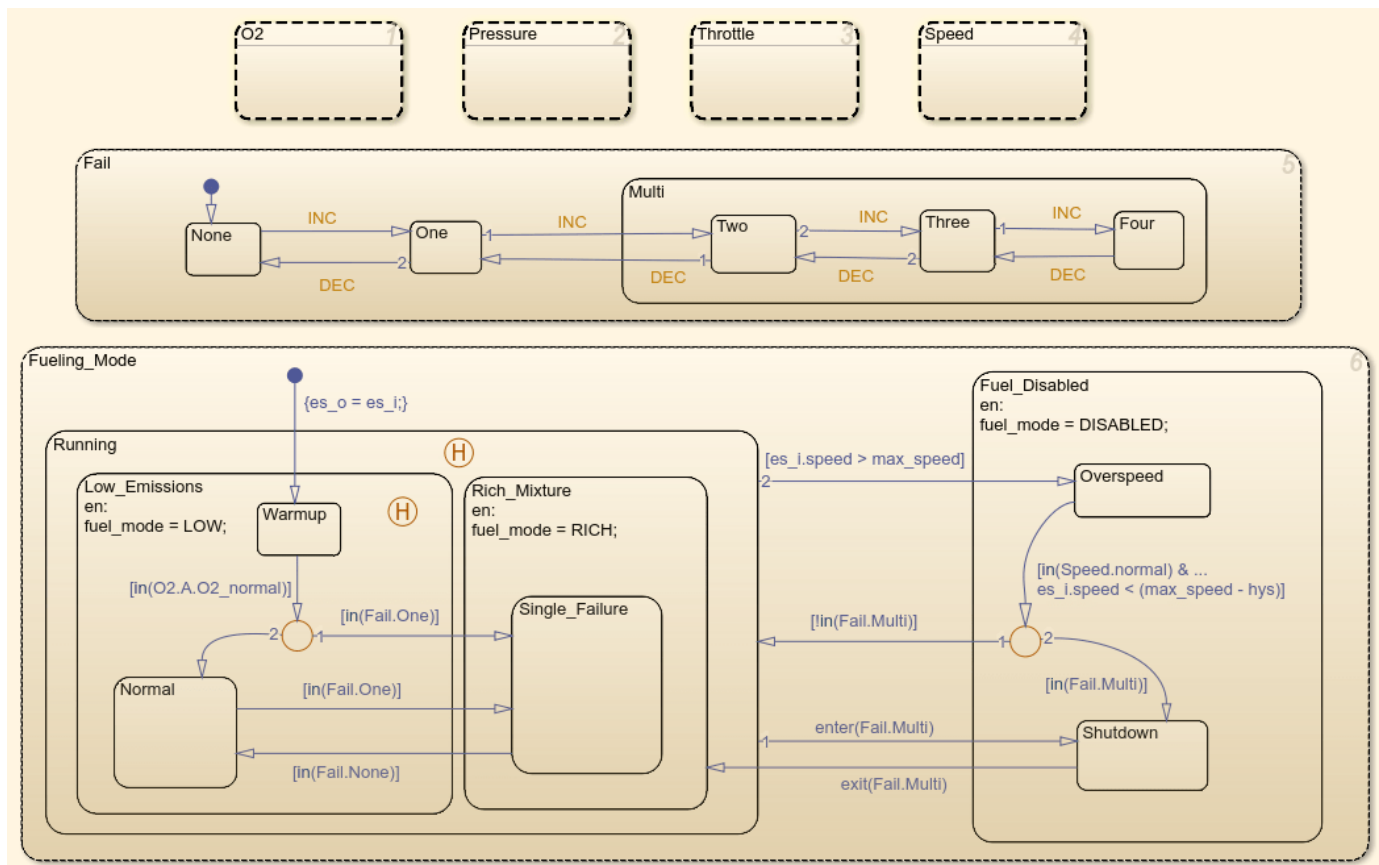

Figure 4: The control logic chart

When execution begins, all of the states start in their **normal** mode with the exception of the oxygen sensor (EGO). The `O2_warmup` state is entered initially until the warmup period is complete. The system detects throttle and pressure sensor failures when their measured values fall outside their nominal ranges. A manifold vacuum in the absence of a speed signal indicates a speed sensor failure. The oxygen sensor also has a nominal range for failure conditions but, because zero is both the minimum signal level and the bottom of the range, failure can be detected only when it exceeds the upper limit.

Regardless of which sensor fails, the model always generates the directed event broadcast `Fail.INC`. In this way the triggering of the universal sensor failure logic is independent of the sensor. The model also uses a corresponding sensor recovery event, `Fail.DEC`. The `Fail` state keeps track of the number of failed sensors. The counter increments on each `Fail.INC` event and decrements on each `Fail.DEC` event. The model uses a superstate, `Multi`, to group all cases where more than one sensor has failed.

The bottom parallel state represents the fueling mode of the engine. If a single sensor fails, operation continues but the air/fuel mixture is richer to allow smoother running at the cost of higher emissions. If more than one sensor has failed, the engine shuts down as a safety measure, since the air/fuel ratio cannot be controlled reliably.

During the oxygen sensor warm-up, the model maintains the mixture at normal levels. If this is unsatisfactory, you can change the design by moving the warm-up state to within the `Rich_Mixture`

superstate. If a sensor failure occurs during the warm-up period, the `Single_Failure` state is entered after the warm-up time elapses. Otherwise, the `Normal` state is activated at this time.

A protective overspeed feature has been added to the model by creating a new state in the `Fuel_Disabled` superstate. Through the use of history junctions, we assured that the chart returns to the appropriate state when the model exits the overspeed state. As the safety requirements for the engine become better specified, we can add additional shutdown states to the `Fuel_Disabled` superstate.

Sensor Correction

When a sensor fails, the model computes an estimate of the sensor. For example, open the pressure sensor calculation. Under normal sensor operation, the model uses the value of the pressure sensor. Otherwise, the model estimates the value.

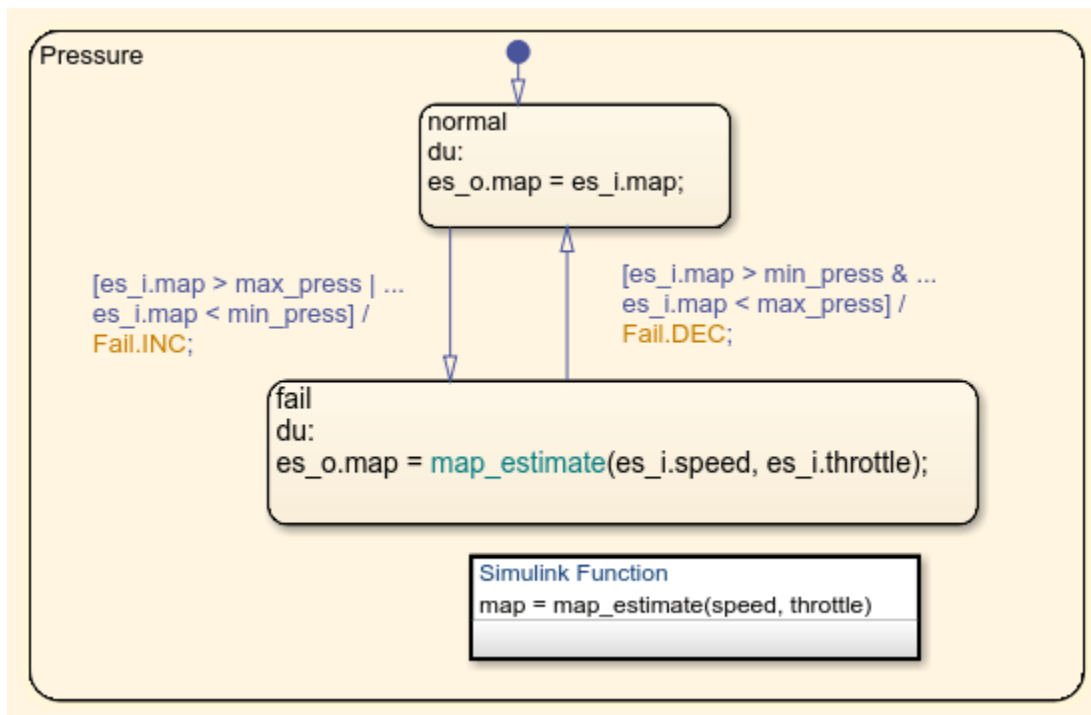

The model computes an estimate of manifold pressure as a function of the engine speed and throttle position. To compute the value, the model uses a Simulink function inside Stateflow.

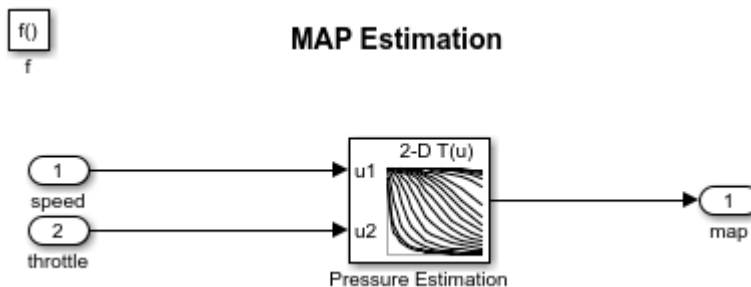

Airflow Calculation

The Airflow Calculation block (shown in Figure 6) is the location for the central control laws. This block is found inside the fuel_rate_control subsystem (open this block). The block estimates the intake air flow to determine the fuel rate which gives the appropriate air/fuel ratio. Closed-loop control adjusts the estimation according to the residual oxygen feedback in order to maintain the mixture ratio precisely. Even when a sensor failure mandates open-loop operation, the most recent closed-loop adjustment is retained to best meet the control objectives.

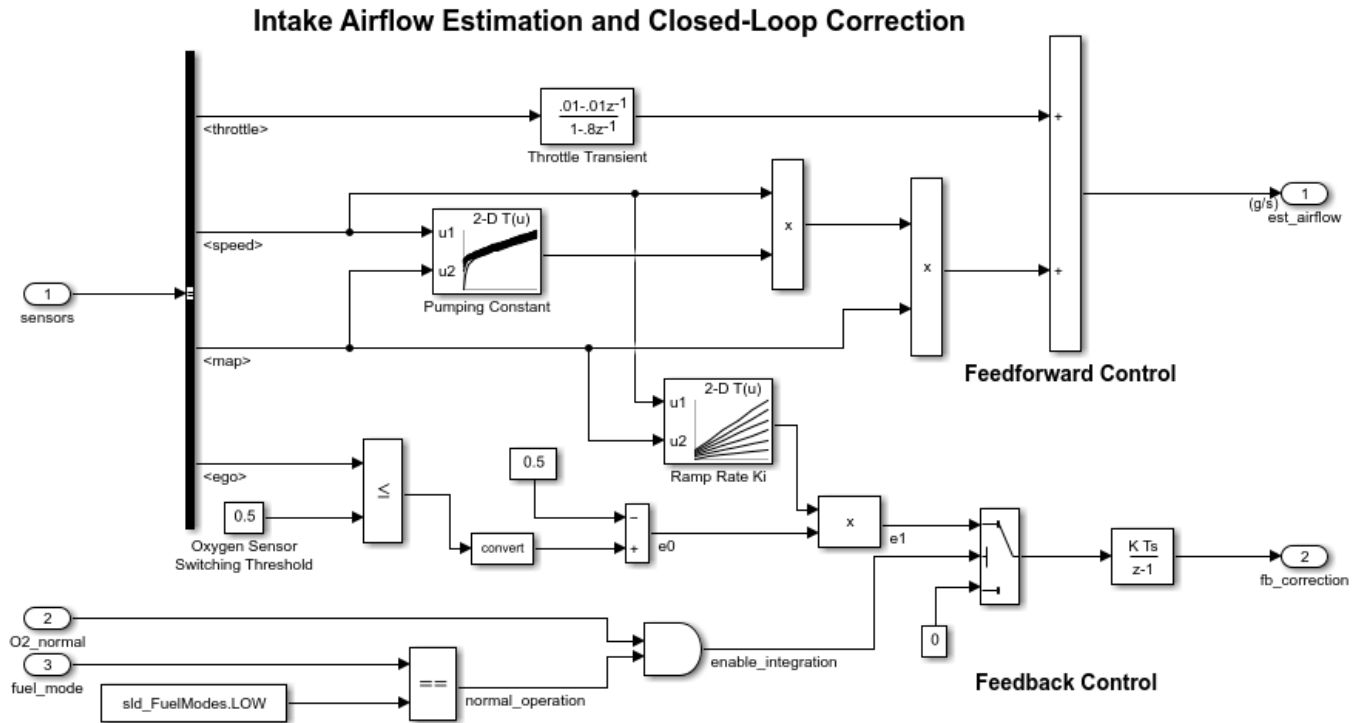

Figure 6: Airflow estimation and correction

Equation 1

The engine's intake air flow can be formulated as the product of the engine speed, the manifold pressure and a time-varying scale factor.

$$q = \frac{N}{4\pi} V_{cd} \nu \frac{P_m}{RT} = C_{pump}(N, P_m) N P_m = \text{intake mass flow}$$

N = engine angular speed (Rad/sec)

V_{cd} = engine cylinder displacement volume

ν = volumetric efficiency

P_m = manifold pressure

R, T = specific gas constant, gas temperature

C_{pump} is computed by a lookup table and multiplied by the speed and pressure to form the initial flow estimate. During transients, the throttle rate, with the derivative approximated by a high-pass filter, corrects the air flow for filling dynamics. The control algorithm provides additional correction according to Equation 2.

Equation 2

$$e_0 = 0.5 \text{ for } EGO \leq 0.5$$

$$e_0 = -0.5 \text{ for } EGO > 0.5$$

$$e_1 = K_i(N, P_m)e_0 \text{ for } EGO \leq 0.5$$

$$\dot{e}_2 = e_1 \text{ for LOW mode with valid EGO signal}$$

$$\dot{e}_2 = 0 \text{ for RICH, DISABLE or EGO warmup}$$

$$e_0, e_1, e_2 = \text{intermediate error signals}$$

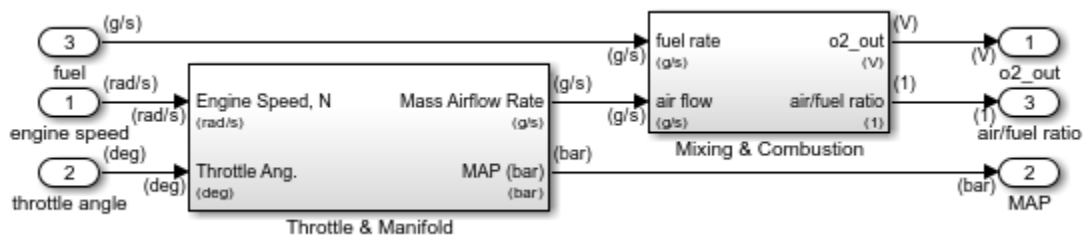

Figure 7: Engine Gas Dynamics subsystem

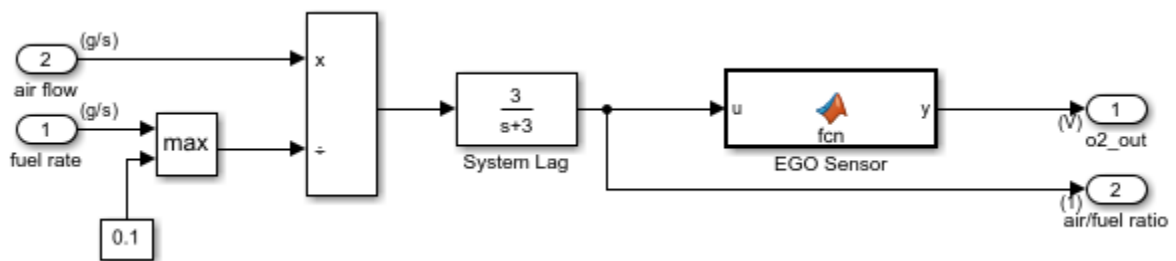

Figure 8: Mixing & Combustion block within the Engine Gas Dynamics subsystem

The nonlinear oxygen sensor (EGO Sensor block) is found inside the Mixing & Combustion block (see Figure 8) within the Engine Gas Dynamics subsystem (see Figure 7). EGO Sensor is modeled as a hyperbolic tangent function, and it provides a meaningful signal when in the vicinity of 0.5 volt. The raw error in the feedback loop is thus detected with a switching threshold, as indicated in Equation 2. If the air-fuel ratio is low (the mixture is lean), the original air estimate is too small and needs to be increased. Conversely, when the oxygen sensor output is high, the air estimate is too large and needs to be decreased. Integral control is utilized so that the correction term achieves a level that brings about zero steady-state error in the mixture ratio.

The normal closed-loop operation mode, LOW, adjusts the integrator dynamically to minimize the error. The integration is performed in discrete time, with updates every 10 milliseconds. When

operating open-loop however, in the RICH or O2 failure modes, the feedback error is ignored and the integrator is held. This gives the best correction based on the most recent valid feedback.

Fuel Calculation

The fuel_calc subsystem (within the fuel_rate_control subsystem, see Figure 9) sets the injector signal to match the given airflow calculation and fault status. The first input is the computed airflow estimation. This is multiplied with the target fuel/air ratio to get the commanded fuel rate. Normally the target is stoichiometric, i.e. equals the optimal air to fuel ratio of 14.6. When a sensor fault occurs, the Stateflow control logic sets the mode input to a value of 2 or 3 (RICH or DISABLED) so that the mixture is either slightly rich of stoichiometric or is shut down completely.

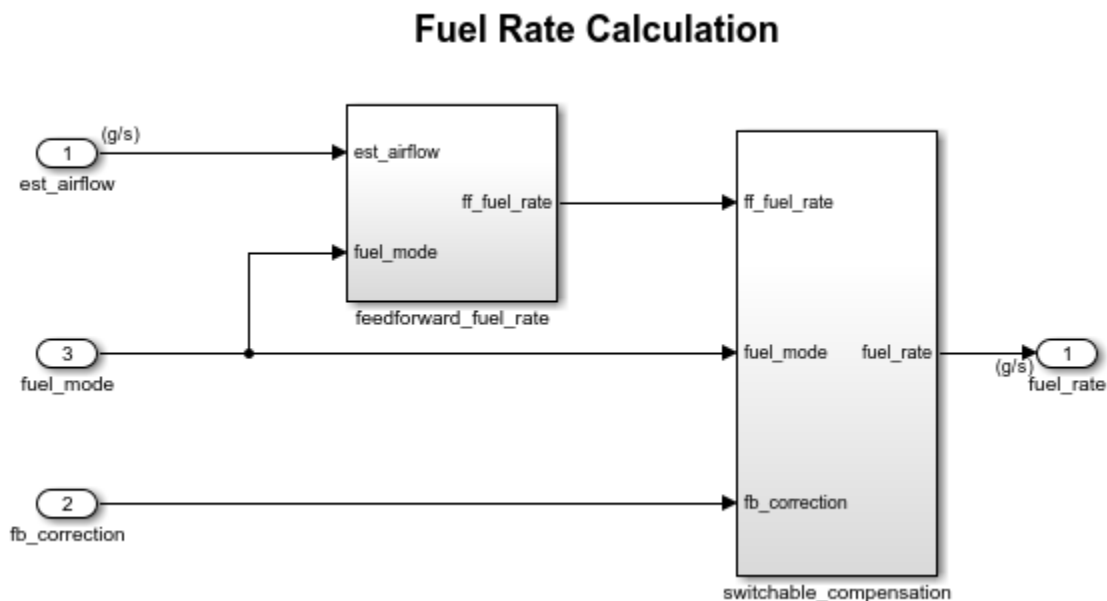

Figure 9: fuel_calc subsystem

The fuel_calc subsystem (Figure 9) employs adjustable compensation (Figure 10) in order to achieve different purposes in different modes. In normal operation, phase lead compensation of the feedback correction signal adds to the closed-loop stability margin. In RICH mode and during EGO sensor failure (open loop), however, the composite fuel signal is low-pass filtered to attenuate noise introduced in the estimation process. The end result is a signal representing the fuel flow rate which, in an actual system, would be translated to injector pulse times.

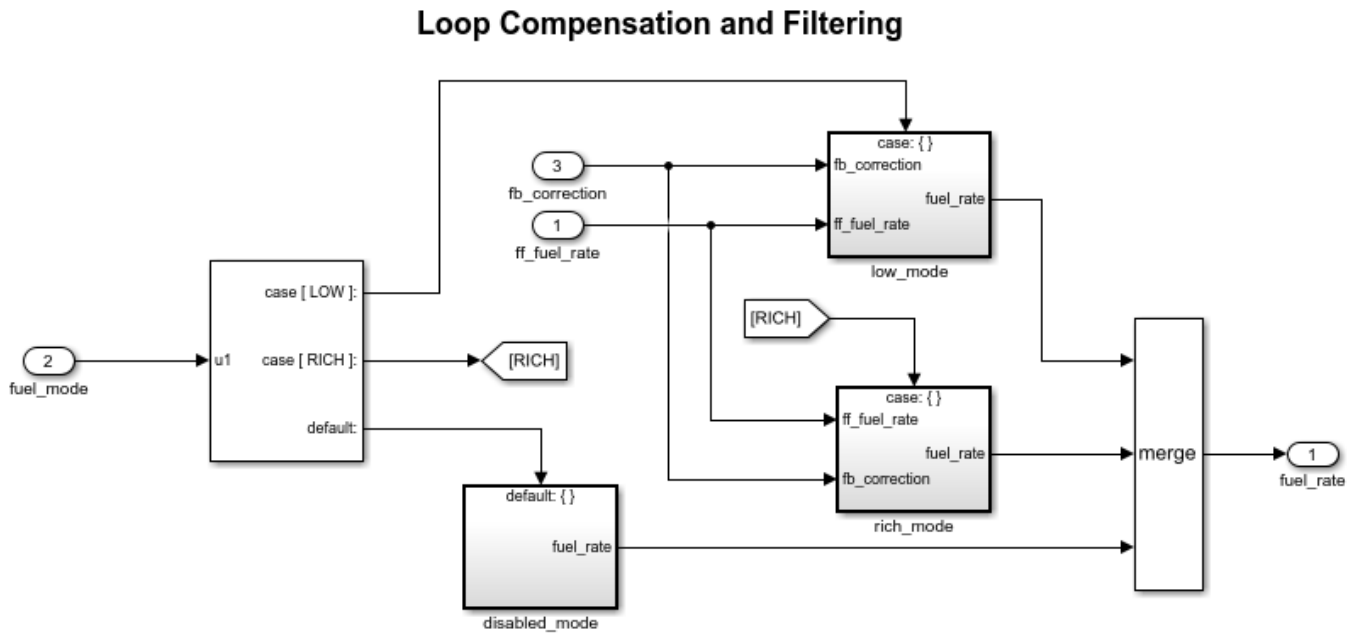
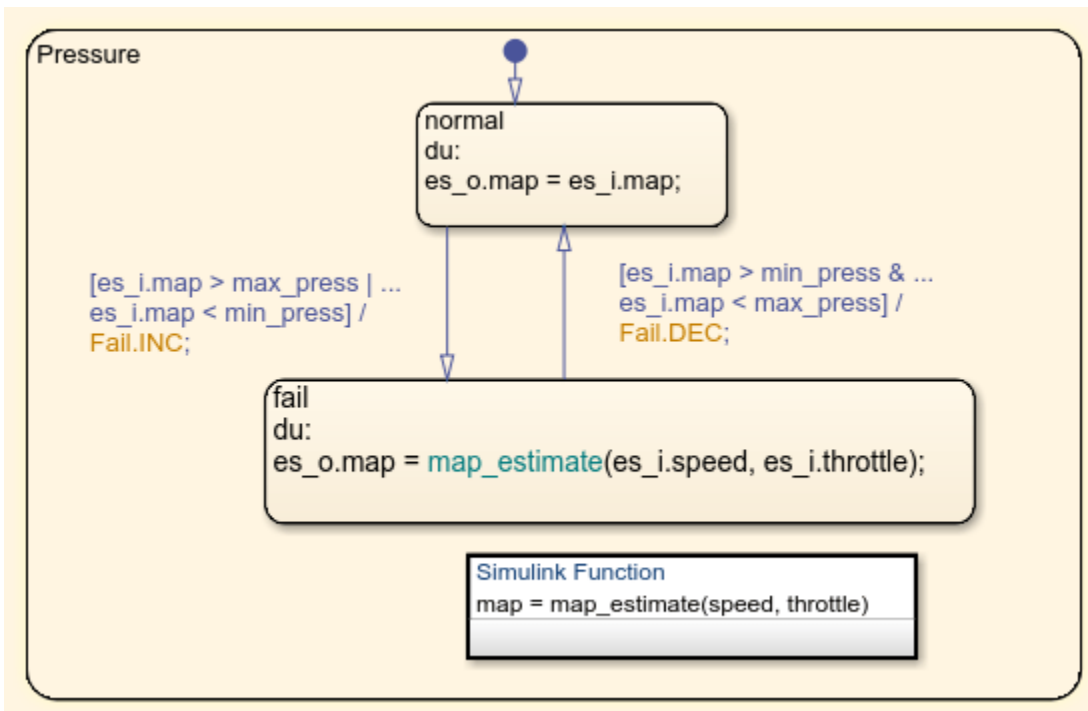

Figure 10: Switchable compensation subsystem



Results and Conclusions

Simulation results are shown in Figure 11 and Figure 12. The simulation is run with a throttle input that ramps from 10 to 20 degrees over a period of two seconds, then goes back to 10 degrees over the next two seconds. This cycle repeats continuously while the engine is held at a constant speed so

that the user can experiment with different fault conditions and failure modes. Click on a sensor fault switch in the dashboard subsystem to simulate the failure of the associated sensor. Repeat this operation to slide the switch back for normal operation.

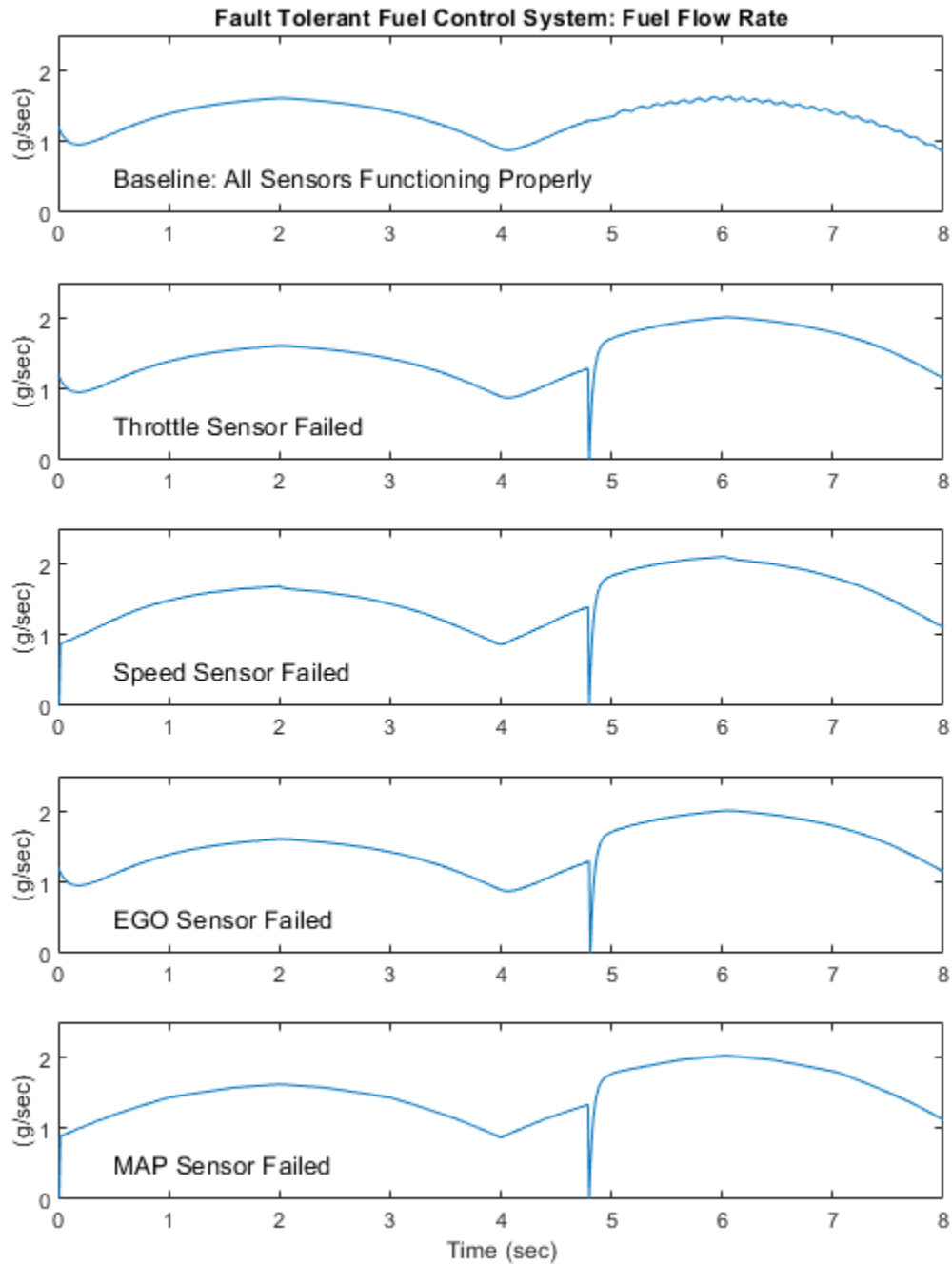

Figure 11: Comparing the fuel flow rate for different sensor failures

Figure 11 compares the fuel flow rate under fault-free conditions (baseline) with the rate applied in the presence of a single failure in each sensor individually. In each case note the nonlinear relationship between fuel flow and the triangular throttle command (shown in Figure 13). In the baseline case, the fuel rate is regulated tightly, exhibiting a small ripple due to the switching nature of the EGO sensor's input circuitry. In the other four cases the system operates open loop. The control strategy is proven effective in maintaining the correct fuel profile in the single-failure mode. In each of the fault conditions, the fuel rate is essentially 125% of the baseline flow, fulfilling the design objective of 80% rich.

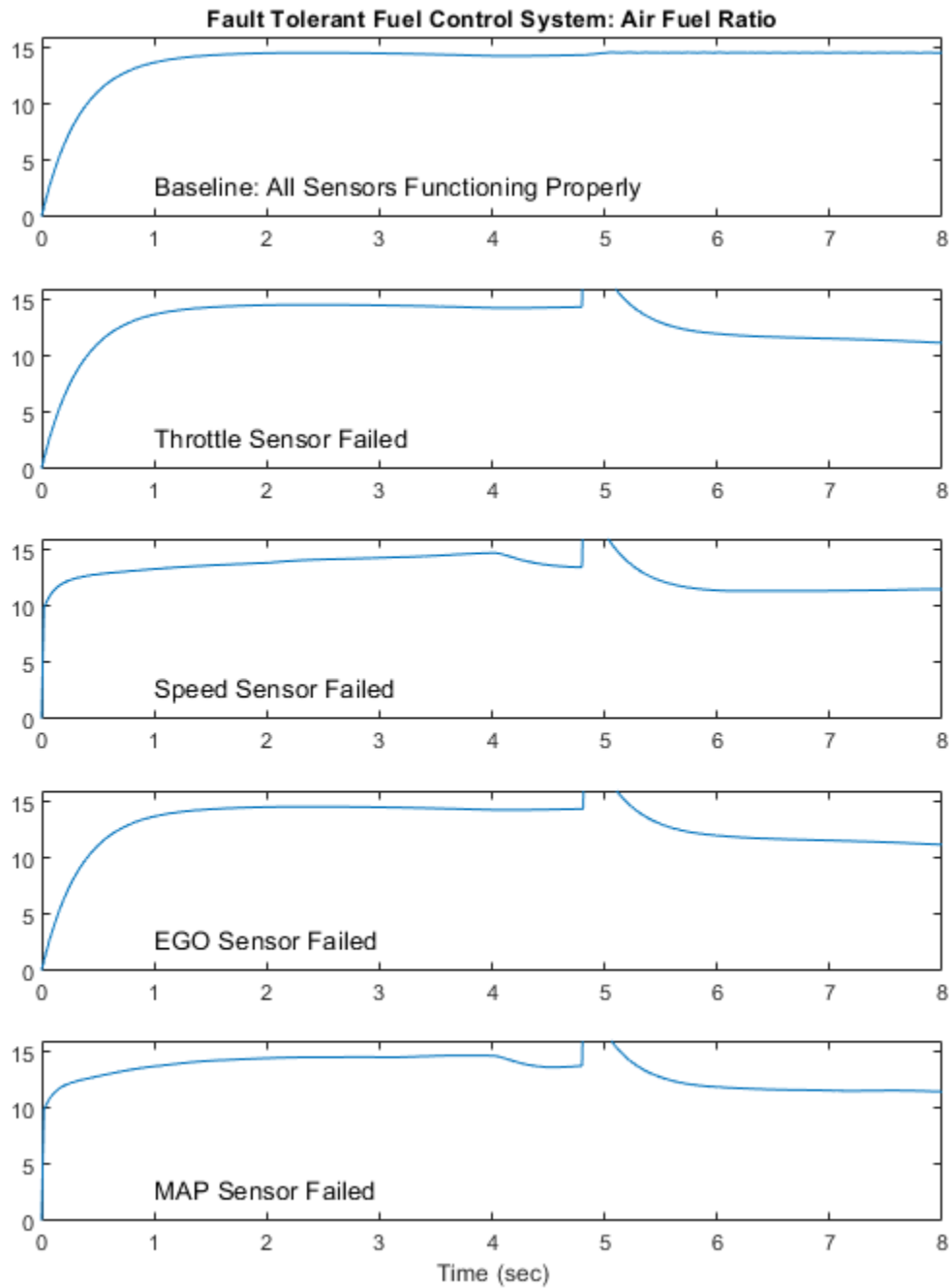

Figure 12: Comparing the air-fuel ratio for different sensor failures

Figure 12 plots the corresponding air/fuel ratio for each case. The baseline plot shows the effects of closed-loop operation. The mixture ratio is regulated very tightly to the stoichiometric objective of

14.6. The rich mixture ratio is shown in the bottom four plots of Figure 12. Although they are not tightly regulated, as in the closed-loop case, they approximate the objective of air/fuel ($0.8 \times 14.6 = 11.7$).

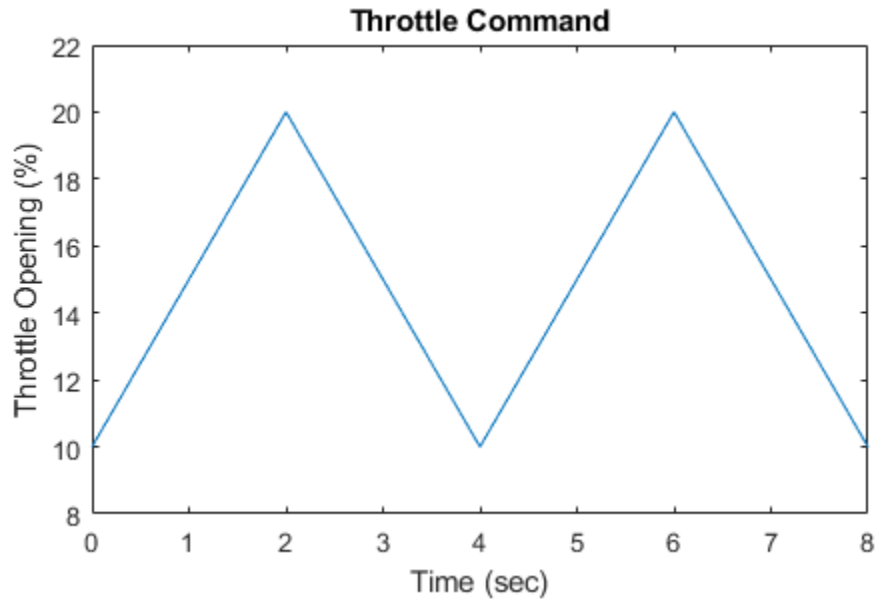

Figure 13: Throttle command

The transient behavior of the system is shown in Figure 14. With a constant 12 degree throttle angle and the system in steady-state, a throttle failure is introduced at $t = 2$ and corrected at $t = 5$. At the onset of the failure, the fuel rate increases immediately. The effects are seen at the exhaust as the rich ratio propagates through the system. The steady-state condition is then quickly recovered when closed-loop operation is restored.

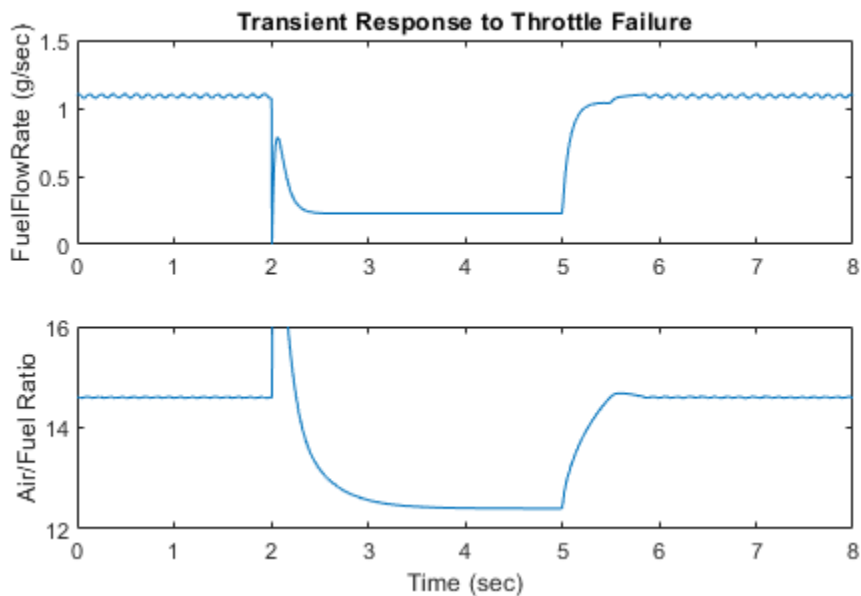

Figure 14: Transient response to fault detection

Remarks

If you enable animation in the Stateflow debugger, the state transitions are highlighted in the Stateflow diagram (see Figure 4) as the various states are activated. The sequence of activation is indicated by changing colors. This closely coupled synergy between Stateflow and Simulink fosters the modeling and development of complete control systems.

See Also**Related Examples**

- “Fixed-Point Fuel Rate Control System” (Fixed-Point Designer)
- “Air-Fuel Ratio Control System with Fixed-Point Data” (Embedded Coder)
- “Air-Fuel Ratio Control System with Stateflow Charts” (Embedded Coder)

Using a Data Dictionary to Manage the Data for a Fuel Control System

This example shows how to use data dictionaries to manage the data for a fuel rate control system designed using Simulink® and Stateflow®.

Familiarize Yourself with the Model

The `sldemo_fuelsys_dd` model is a closed-loop system containing a "plant" and "controller". The plant is used to validate the design of the controller. In this example, the plant and controller are represented by separate models that are referenced from the test harness model. Let's take a look at these models.

Open and Compile the Test Harness Model

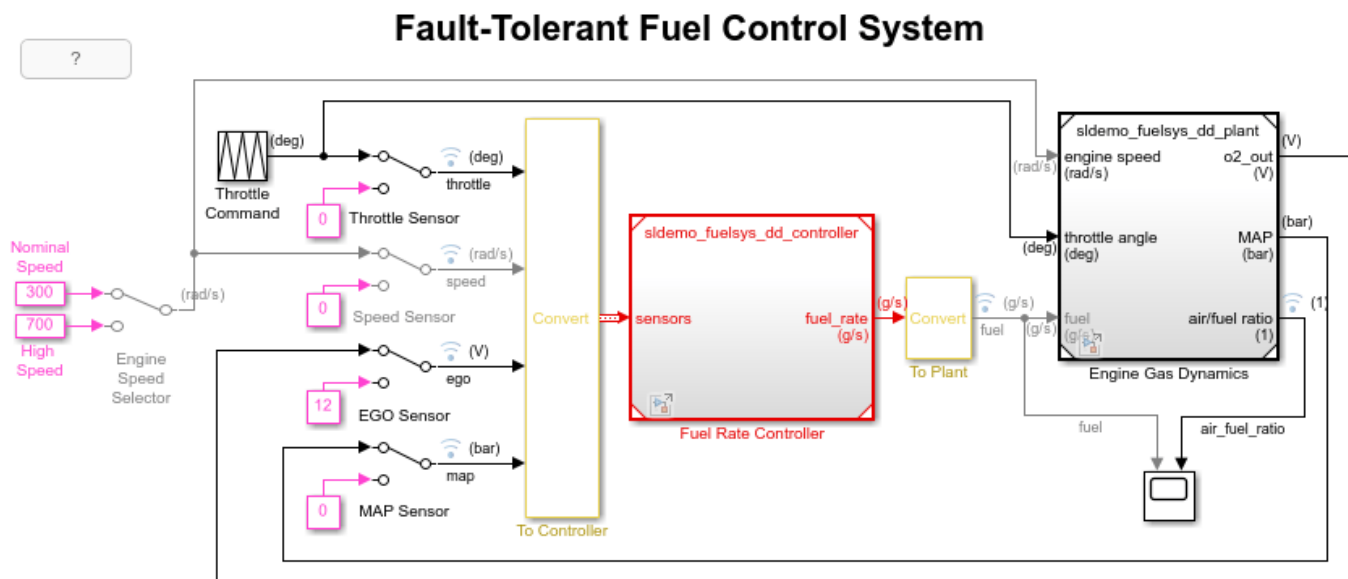

The sensor switches simulate any combination of sensor failures.
The Engine Speed Selector switch simulates different engine speeds (rad/s).

Copyright 1990-2017 The MathWorks, Inc.

View the Engine Gas Dynamics System (Plant)

Double-click on the Engine Gas Dynamics block to open the plant model.

Engine Gas Dynamics

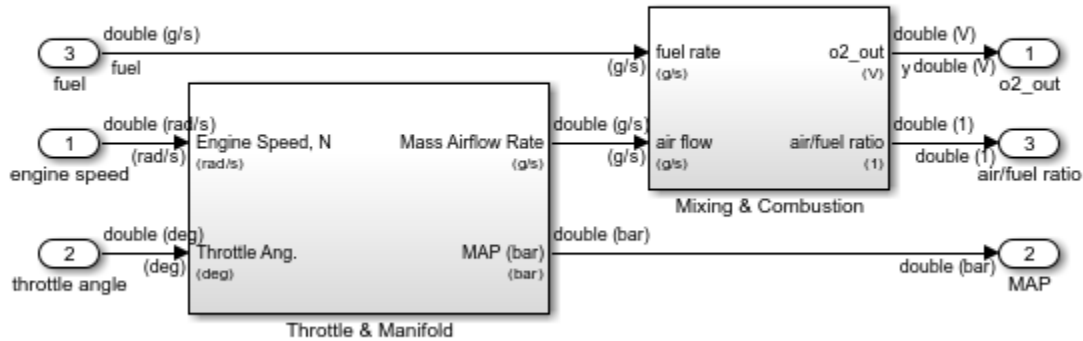

Copyright 1990-2015 The MathWorks, Inc.

View the Fuel Rate Control System (Controller)

Double-click on the Fuel Rate Controller block to open the controller model.

Fuel Rate Controller

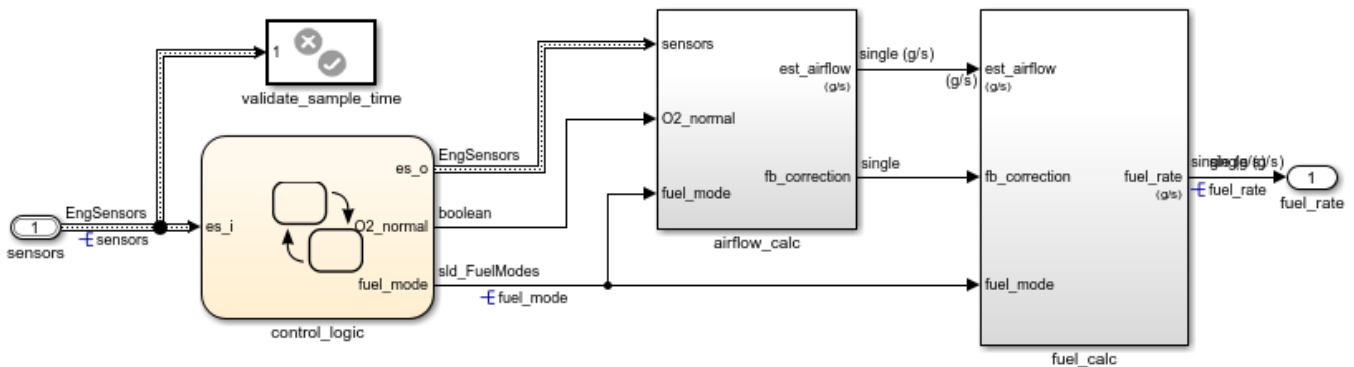

Copyright 1990-2017 The MathWorks, Inc.

Investigate the Data Used by the Controller

The global design data for the controller model is defined in a data dictionary. Using data dictionaries has many advantages over defining data in the base workspace.

The controller model is explicitly linked to a data dictionary. This link is set up on the Data tab of the Model Properties dialog.

The icon in the lower-left corner of the model window shows that this model is linked to a data dictionary. You can open the data dictionary in the Model Explorer by clicking on this icon.

This data dictionary contains parameter and signal objects that are used to configure the controller algorithm for simulation and code generation. It also contains a reference to another data dictionary that defines the data type objects used by this model.

Initially, this data dictionary is configured for a float-point controller, as is seen by the data type display on the signal lines in the controller model. You can easily switch between floating-point and fixed-point controllers by changing the types dictionary (`sldemo_fuelsys_dd_types.sldd`) to reference the appropriate dictionary:

- Floating-point types: `sldemo_fuelsys_dd_float.sldd`
- Fixed-point types: `sldemo_fuelsys_dd_fixpt.sldd`

Investigate the Units Used by the Components

Notice that units are visible on the model and subsystem icons and signal lines. Units are specified on the ports and on the bus, signal and parameter objects in the data dictionary.

Simulate the Test Harness Model

The test harness model is also linked to a data dictionary (`sldemo_fuelsys_dd.sldd`). This data dictionary contains references to the data dictionaries for the plant and controller models but it does not contain any additional data.

Simulate the test harness model to validate the behavior of the controller in either the floating-point or fixed-point configuration.

Close the Example

Close the models and data dictionaries from this example.

See Also

Related Examples

- “Modeling a Fault-Tolerant Fuel Control System” on page 13-112
- “Fixed-Point Fuel Rate Control System” (Fixed-Point Designer)
- “Air-Fuel Ratio Control System with Fixed-Point Data” (Embedded Coder)
- “Air-Fuel Ratio Control System with Stateflow Charts” (Embedded Coder)

More About

- “Units in Simulink”
- “What Is a Data Dictionary?”

Modeling Engine Timing Using Triggered Subsystems

This example shows how to model a four-cylinder spark ignition internal combustion engine from the throttle to the crankshaft output. We used well-defined physical principles supplemented, where appropriate, with empirical relationships that describe the system's dynamic behavior without introducing unnecessary complexity.

Analysis and Physics

This example describes the concepts and details surrounding the creation of engine models with emphasis on important Simulink® modeling techniques. The basic model uses the enhanced capabilities of Simulink to capture time-based events with high fidelity. Within this simulation, a triggered subsystem models the transfer of the air-fuel mixture from the intake manifold to the cylinders via discrete valve events. This takes place concurrently with the continuous-time processes of intake flow, torque generation and acceleration. A second model adds an additional triggered subsystem that provides closed-loop engine speed control via a throttle actuator. These models can be used as standalone engine simulations. Or, they can be used within a larger system model, such as an integrated vehicle and powertrain simulation, in the development of a traction control system.

This model is based on published results by Crossley and Cook (1991). It describes the simulation of a four-cylinder spark ignition internal combustion engine. The Crossley and Cook work also shows how a simulation based on this model was validated against dynamometer test data. The ensuing sections (listed below) analyze the key elements of the engine model that were identified by Crossley and Cook:

- 1 Throttle
 - 2 Intake manifold
 - 3 Mass flow rate
 - 4 Compression stroke
 - 5 Torque generation and acceleration
- Note: Additional components can be added to the model to provide greater accuracy in simulation and to more closely replicate the behavior of the system.

Throttle

The first element of the model is the throttle body. The control input is the angle of the throttle plate. The rate at which the model introduces air into the intake manifold can be expressed as the product of two functions:

- 1 an empirical function of the throttle plate angle only
- 2 a function of the atmospheric and manifold pressures

In cases of lower manifold pressure (greater vacuum), the flow rate through the throttle body is sonic and is only a function of the throttle angle. This model accounts for this low pressure behavior with a switching condition in the compressibility equations shown in Equation 1.

Equation 1

$$\dot{m}_{ai} = f(\theta) \cdot g(P_m) = \text{mass flow rate into manifold (g/s)}$$

$$f(\theta) = 2.821 - 0.05231 \cdot \theta + 0.10299 \cdot \theta^2 - 0.00063 \cdot \theta^3$$

$$g(P_m) = 1; \text{ if } P_m \leq P_{amb}/2$$

$$g(P_m) = \frac{2}{P_{amb}} \sqrt{P_m P_{amb} - P_m^2}; \text{ if } P_{amb}/2 \leq P_m \leq P_{amb}$$

$$g(P_m) = -\frac{2}{P_m} \sqrt{P_m P_{amb} - P_{amb}^2}; \text{ if } P_{amb} \leq P_m \leq 2P_{amb}$$

$$g(P_m) = -1; \text{ if } P_m \geq 2P_{amb}$$

\dot{m}_{ai} → mass flow rate into manifold (g/s);

θ → throttle angle (deg);

P_m → manifold pressure (bar);

P_{amb} → ambient (atmospheric) pressure (bar);

Intake Manifold

The simulation models the intake manifold as a differential equation for the manifold pressure. The difference in the incoming and outgoing mass flow rates represents the net rate of change of air mass with respect to time. This quantity, according to the ideal gas law, is proportional to the time derivative of the manifold pressure (see Equation 2). Note that, unlike the model of Crossley and Cook (see also references 3 through 5), this model doesn't incorporate exhaust gas recirculation (EGR), although this can easily be added.

Equation 2

$$\dot{P}_m = \frac{RT}{V_m} (\dot{m}_{ai} - \dot{m}_{ao})$$

R → specific gas constant;

T → temperature (K);

V_m → manifold volume (m^3);

\dot{m}_{ao} → mass flow rate of air out of the manifold (g/s);

\dot{P}_m → rate of change of manifold pressure (bar/s);

Intake Mass Flow Rate

The mass flow rate of air that the model pumps into the cylinders from the manifold is described in Equation 3 by an empirically derived equation. This mass rate is a function of the manifold pressure and the engine speed.

Equation 3

$$\dot{m}_{ao} = -0.366 + 0.08979 \cdot N \cdot P_m - 0.0337 \cdot N \cdot P_m^2 + 0.0001 \cdot N^2 \cdot P_m$$

$N \rightarrow$ engine angular speed (rad/s);

$P_m \rightarrow$ manifold pressure (bar);

To determine the total air charge pumped into the cylinders, the simulation integrates the mass flow rate from the intake manifold and samples it at the end of each intake stroke event. This determines the total air mass that is present in each cylinder after the intake stroke and before compression.

Compression Stroke

In an inline four-cylinder four-stroke engine, 180 degrees of crankshaft revolution separate the ignition of each successive cylinder. This results in each cylinder firing on every other crank revolution. In this model, the intake, compression, combustion, and exhaust strokes occur simultaneously (at any given time, one cylinder is in each phase). To account for compression, the combustion of each intake charge is delayed by 180 degrees of crank rotation from the end of the intake stroke.

Torque Generation and Acceleration

The final element of the simulation describes the torque developed by the engine. An empirical relationship dependent upon the mass of the air charge, the air/fuel mixture ratio, the spark advance, and the engine speed is used for the torque computation (see Equation 4).

Equation 4

$$\begin{aligned} Torque_{eng} = & -181.3 + 379.36 \cdot m_a + 21.91 \cdot \left(\frac{A}{F}\right) - 0.85 \cdot \left(\frac{A}{F}\right)^2 + 0.26 \cdot \sigma - 0.0028 \cdot \sigma^2 + \\ & + 0.027 \cdot N - 0.000107 \cdot N^2 + 0.00048 \cdot N \cdot \sigma + 2.55 \cdot \sigma \cdot m_a - 0.05 \cdot \sigma^2 \cdot m_a \end{aligned}$$

$m_a \rightarrow$ mass of air in cylinder for combustion (g);

$\left(\frac{A}{F}\right) \rightarrow$ air to fuel ratio;

$\sigma \rightarrow$ spark advance (degrees before top - dead - center);

$Torque_{eng} \rightarrow$ torque produced by the engine (Nm);

Calculate the engine angular acceleration using Equation 5

Equation 5

$$J\dot{N} = Torque_{eng} - Torque_{load}$$

$J \rightarrow$ engine rotational moment of inertia ($kg \cdot m^2$);

$\dot{N} \rightarrow$ engine angular acceleration (rad/s^2);

Open-Loop Model

We incorporated the model elements described above into an engine model using Simulink. The following sections describe the decisions we made for this implementation and the key Simulink

elements used. This section shows how to implement a complex nonlinear engine model easily and quickly in Simulink environment. We developed this model in conjunction with Ken Butts, Ford Motor Company® (2).

Figure 1 shows the top level of the model. Note that, in general, the major blocks correspond to the high-level list of functions given in the model description in the preceding summary. Taking advantage of Simulink's hierarchical modeling capabilities, most of the blocks in Figure 1 are made up of smaller blocks. The following paragraphs describe these smaller blocks.

Running the Simulation

Press the "Play" button on the model toolbar to run the simulation.

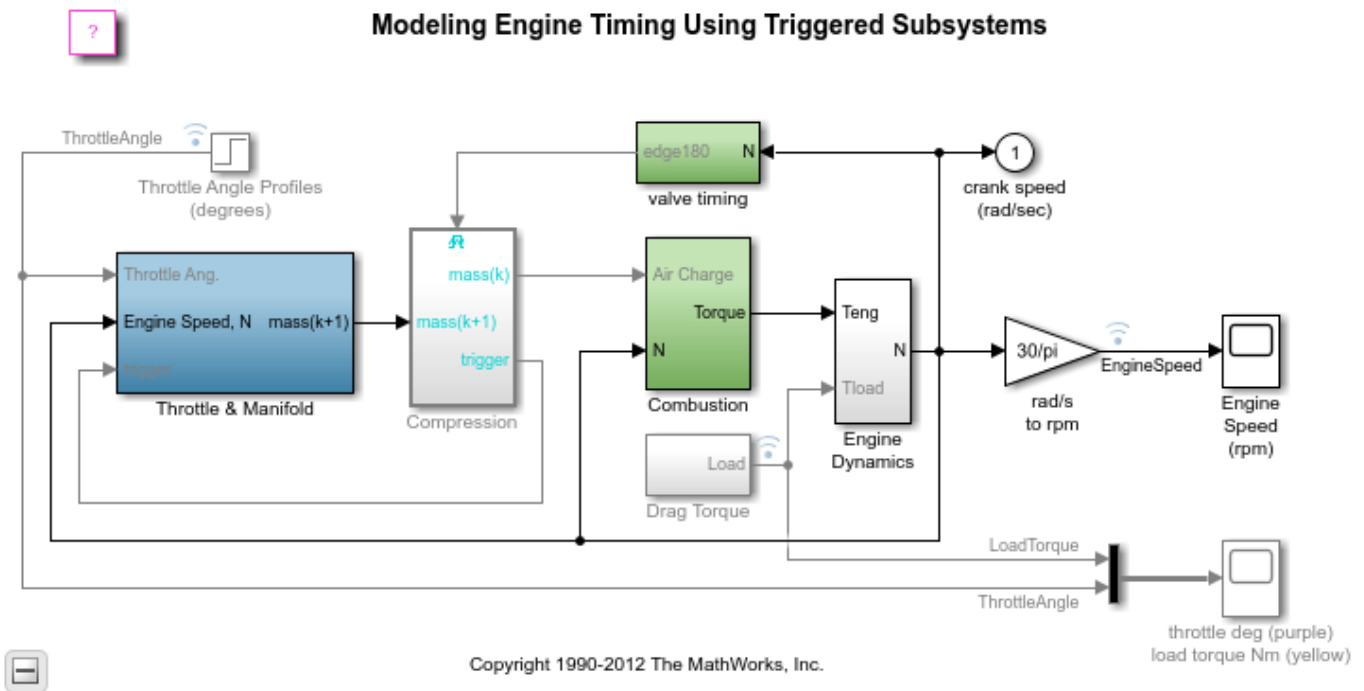

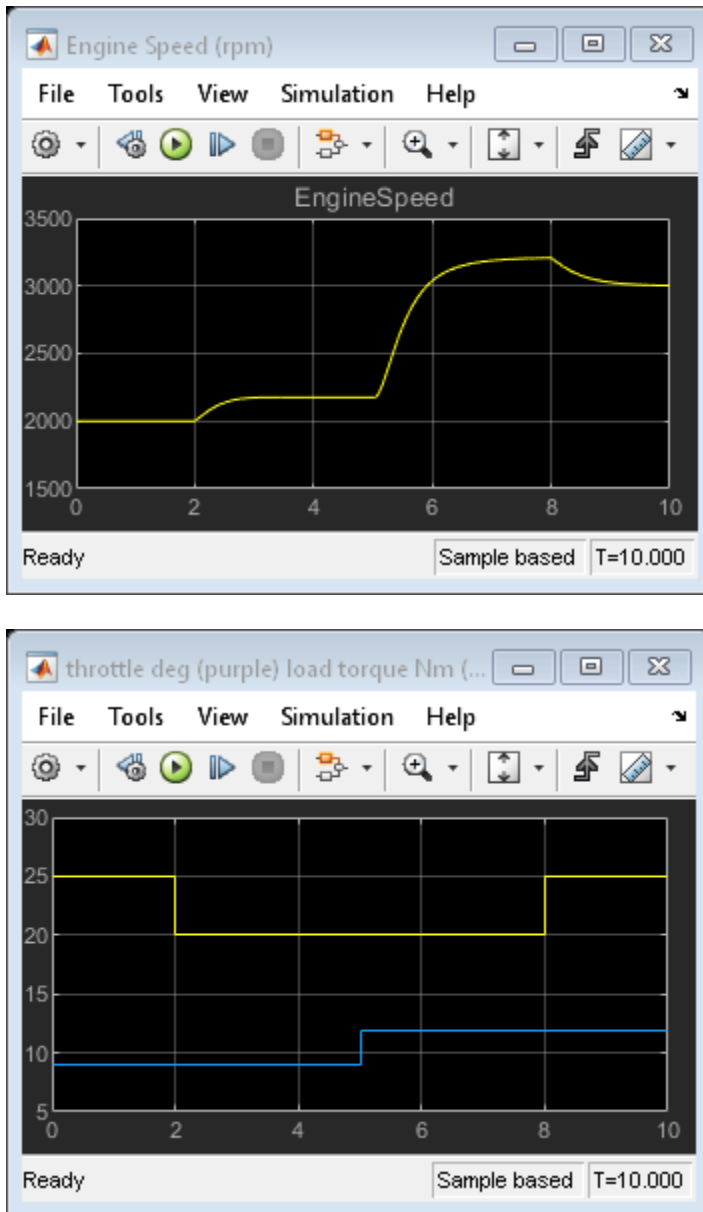
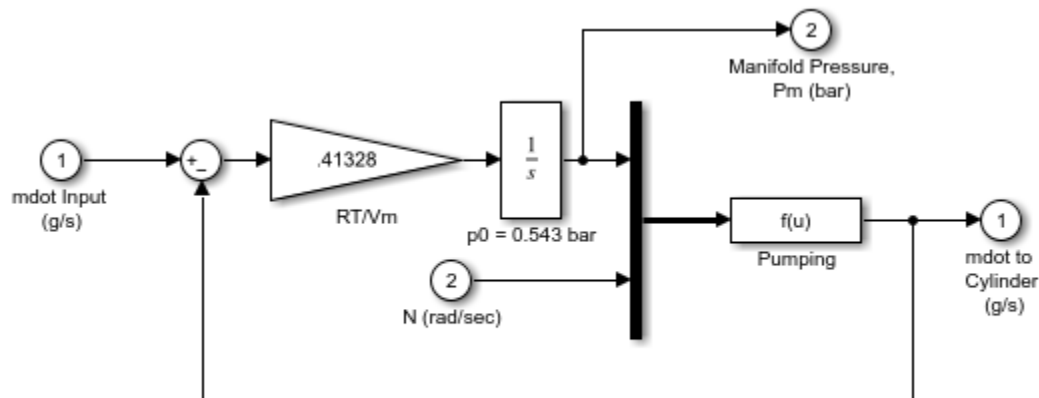

Figure 1: The top level of the engine model and simulation results

- Note: The model logs relevant data to MATLAB workspace in a structure called `sldemo_engine_output`. Logged signals have a blue indicator. Read more about Signal Logging in Simulink documentation.

Throttle/Manifold

In the model, double click on the 'Throttle & Intake Manifold' subsystem to open it. It contains two other subsystems - the 'Throttle' and the 'Intake Manifold' subsystems. Open the 'Throttle' and 'Intake Manifold' to see their components.



Intake Manifold Vacuum

Figure 2: The 'Throttle' and 'Intake Manifold' subsystems

Simulink models for the throttle and intake manifold subsystems are shown in Figure 2. The throttle valve behaves in a nonlinear manner and is modeled as a subsystem with three inputs. Simulink implements the individual equations, given in Equation 1, as function blocks. These provide a convenient way to describe a nonlinear equation of several variables. A 'Switch' block determines whether the flow is sonic by comparing the pressure ratio to its switch threshold, which is set at one half (Equation 1). In the sonic regime, the flow rate is a function of the throttle position only. The direction of flow is from the higher to lower pressure, as determined by the Sign block. With this in mind, the 'Min' block ensures that the pressure ratio is always unity or less.

The differential equation from Equation 2 models the intake manifold pressure. A Simulink function block computes the mass flow rate into the cylinder, a function of manifold pressure and engine speed (see Equation 3).

Intake and Compression

An integrator accumulates the cylinder mass air flow in the 'Intake' block (located inside the 'Throttle & Manifold' subsystem). The 'Valve Timing' block issues pulses that correspond to specific rotational positions in order to manage the intake and compression timing. Valve events occur each cam rotation, or every 180 degrees of crankshaft rotation. Each event triggers a single execution of the 'Compression' subsystem. The output of the trigger block within the 'Compression' subsystem then feeds back to reset the Intake integrator. In this way, although both triggers conceptually occur at the same instant in time, the integrator output is processed by the 'Compression' block immediately prior to being reset. Functionally, the 'Compression' subsystem uses a 'Unit Delay' block to insert 180 degrees (one event period) of delay between the intake and combustion of each air charge.

Consider a complete four-stroke cycle for one cylinder. During the intake stroke, the 'Intake' block integrates the mass flow rate from the manifold. After 180 degrees of crank rotation, the intake valve closes and the 'Unit Delay' block in the 'Compression' subsystem samples the integrator state. This value, the accumulated mass charge, is available at the output of the 'Compression' subsystem 180 degrees later for use in combustion. During the combustion stroke, the crank accelerates due to the generated torque. The final 180 degrees, the exhaust stroke, ends with a reset of the Intake integrator, prepared for the next complete 720 degrees cycle of this particular cylinder.

For four cylinders, we could use four 'Intake' blocks, four 'Compression' subsystems, etc., but each would be idle 75% of the time. We've made the implementation more efficient by performing the tasks of all four cylinders with one set of blocks. This is possible because, at the level of detail we've modeled, each function applies to only one cylinder at a time.

Combustion

Engine torque is a function of four variables. The model uses a 'Mux' block to combine these variables into a vector that provides input to the 'Torque Gen' block. A function block computes the engine torque (described empirically in Equation 4). The torque which loads the engine, computed by step functions in the Drag Torque block, is subtracted in the Engine Dynamics subsystem. The difference divided by the inertia yields the acceleration, which is integrated to arrive at the engine crankshaft speed.

Plotting Simulation Results

We used the following default inputs for the simulation:

$$\textit{Throttle} = 8.97 \text{ (deg) if } t < 5$$

$$\textit{Throttle} = 11.93 \text{ (deg) if } t \geq 5$$

$$\textit{Load} = 25 \text{ (Nm) if } t \leq 2 \text{ or } t \geq 8$$

$$\textit{Load} = 20 \text{ (Nm) if } 2 < t \leq 8$$

Try adjusting the throttle to compensate for the load torque. Figure 3 shows the simulated engine speed, the throttle commands which drive the simulation, and the load torque which disturbs it.

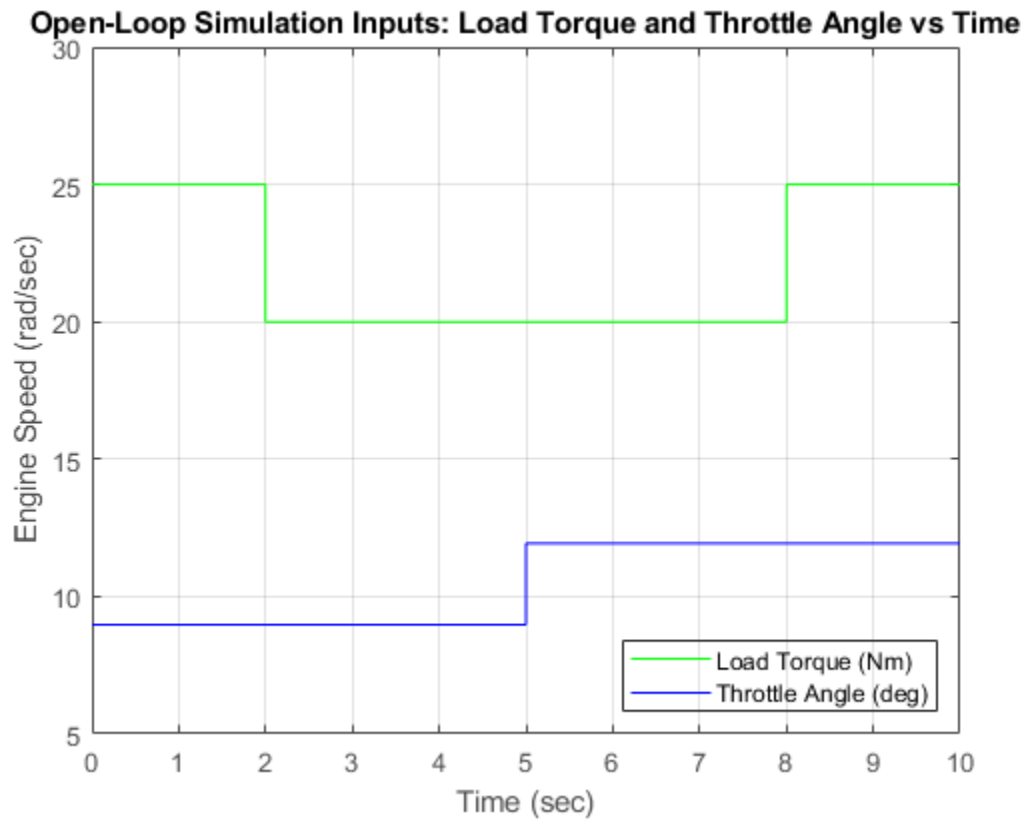

Figure 3a: Open-loop simulation inputs

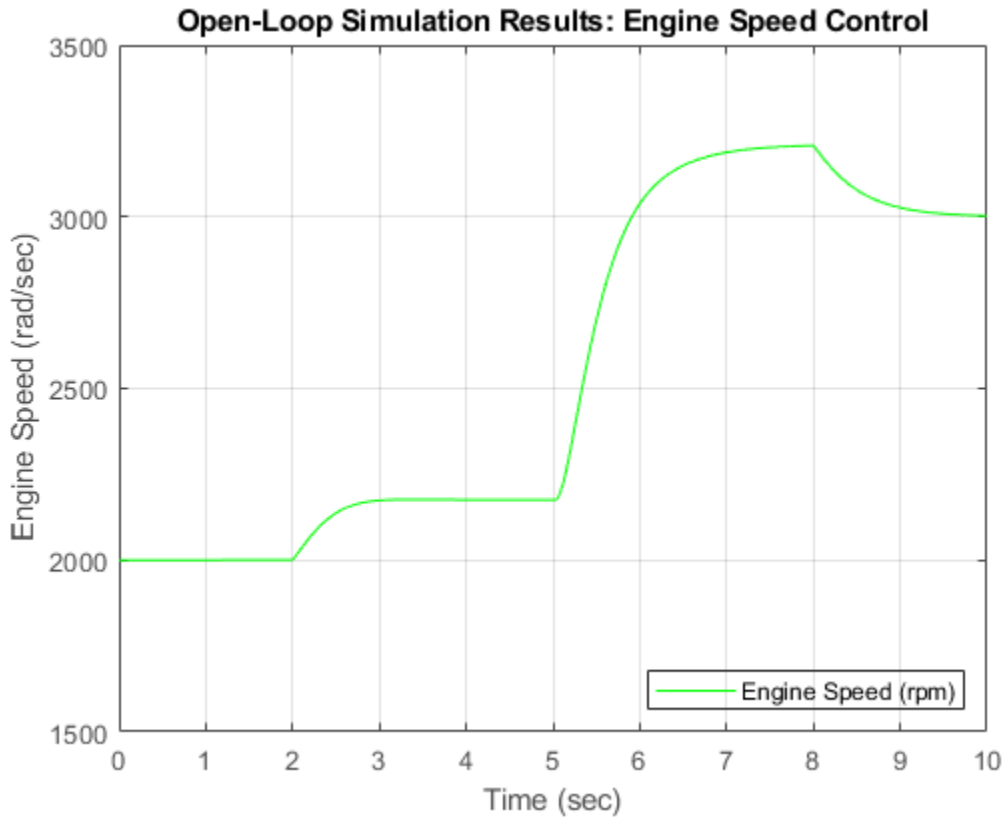

Figure 3b: Open-loops simulation results

Closing Model

Close the model. Clear generated data.

Conclusions

The ability to model nonlinear, complex systems, such as the engine model described here, is one of Simulink's key features. The power of the simulation is evident in the presentation of the models above. Simulink retains model fidelity, including precisely timed cylinder intake events, which is critical in creating a model of this type. The basic engine model shows the flexibility of Simulink.

References

- [1] P.R. Crossley and J.A. Cook, IEEE® International Conference 'Control 91', Conference Publication 332, vol. 2, pp. 921-925, 25-28 March, 1991, Edinburgh, U.K.
- [2] The Simulink Model. Developed by Ken Butts, Ford Motor Company. Modified by Paul Barnard, Ted Liefeld and Stan Quinn, MathWorks®, 1994-7.
- [3] J. J. Moskwa and J. K. Hedrick, "Automotive Engine Modeling for Real Time Control Application," Proc.1987 ACC, pp. 341-346.
- [4] B. K. Powell and J. A. Cook, "Nonlinear Low Frequency Phenomenological Engine Modeling and Analysis," Proc. 1987 ACC, pp. 332-340.

[5] R. W. Weeks and J. J. Moskwa, "Automotive Engine Modeling for Real-Time Control Using Matlab/Simulink," 1995 SAE Intl. Cong. paper 950417.

See Also

More About

- "Enable Signal Logging for a Model"
- "Engine Timing Model with Closed Loop Control" on page 13-140
- "Powertrain Blockset"

Engine Timing Model with Closed Loop Control

This example shows how to enhance a version of the open-loop engine model described in “Modeling Engine Timing Using Triggered Subsystems” on page 13-130. This model, `sldemo_enginewc`, contains a closed-loop and shows the flexibility and extensibility of Simulink® models. In this enhanced model, the objective of the controller is to regulate engine speed with a fast throttle actuator, such that changes in load torque have minimal effect. This is easily accomplished in Simulink by adding a discrete-time PI controller to the engine model.

Closed-Loop Model

We chose a control law which uses proportional plus integral (PI) control. The integrator is needed to adjust the steady-state throttle as the operating point changes, and the proportional term compensates for phase lag introduced by the integrator.

Equation 1

$$\theta = K_p(N_{set} - N) + K_I \int (N_{set} - N)dt$$

N_{set} = speed set point (rpm)

K_p = proportional gain

K_I = integral gain

Running the Simulation

Press the "Play" button on the model toolbar to run the simulation.

- Note: The model logs relevant data to MATLAB workspace in a structure called `sldemo_enginewc_output`. Logged signals have a blue indicator. Read more about Signal Logging in Simulink Help.

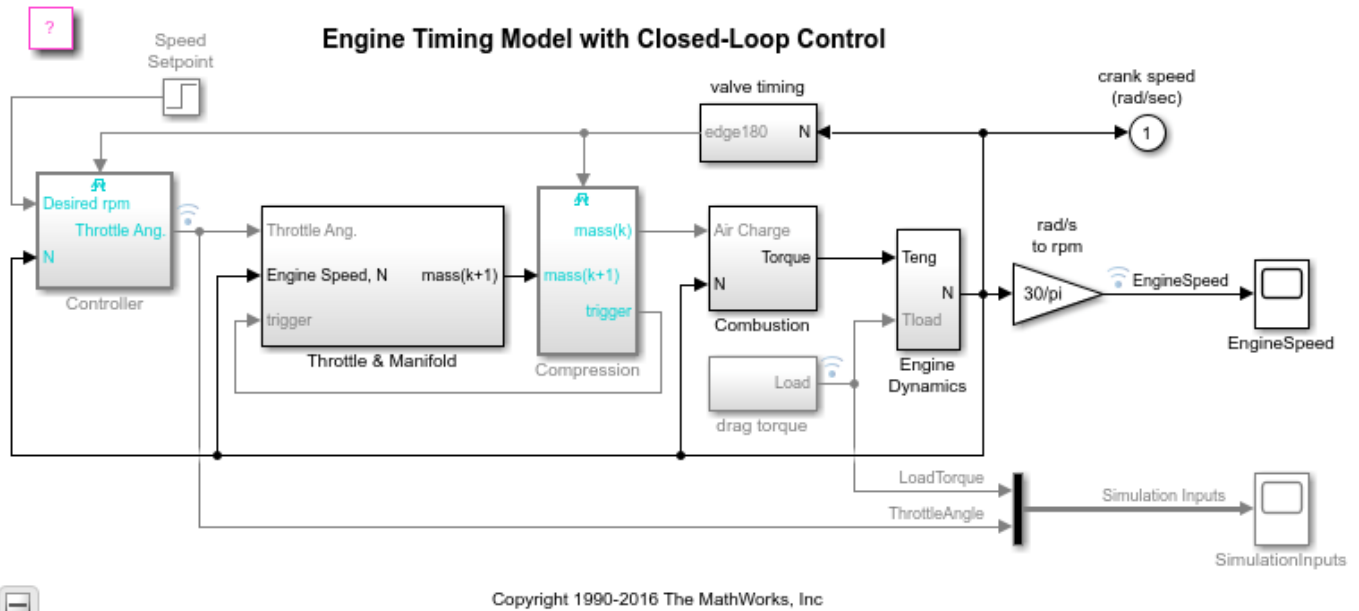

Figure 1: Closed-loop engine model and simulation results

In this model we employ a discrete-time controller, which is suitable for microprocessor implementation. The integral term in Equation 1 must thus be realized with a discrete-time approximation. As is typical in the industry, the controller execution is synchronized with the engine's crankshaft rotation. The controller is embedded in a triggered subsystem that is triggered by the valve timing signal described above.

The detailed construction of the 'Controller' subsystem is illustrated in Figure 2. Of note is the use of the 'PID Controller' block. This block implements a proportional-integral control system in discrete time. Note the setting for sample time set (internally) at -1. This indicates that the block inherits its sample time, in this case executing each time the subsystem is triggered. The key component that makes this a triggered subsystem is the 'Trigger' block shown at the bottom of Figure 2. Any subsystem can be converted to a triggered subsystem by dragging a copy of this block into the subsystem diagram from the Simulink Connections library.

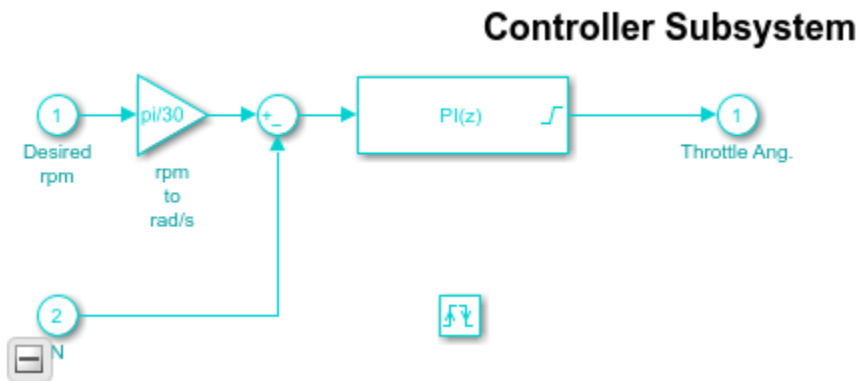

Figure 2: Speed controller subsystem

Results

Typical simulation results are shown in Figure 3. The speed set point steps from 2000 rpm to 3000 rpm at $t = 5$ sec. The torque disturbances are identical to those used in `sldemo_engine`, the open-loop model. Note the quick transient response, with zero steady-state error. Several alternative controller tunings (K_i and K_p) are shown. These can be adjusted by the user at MATLAB command line. This allows the engineer to understand the relative effects of parameter variations.

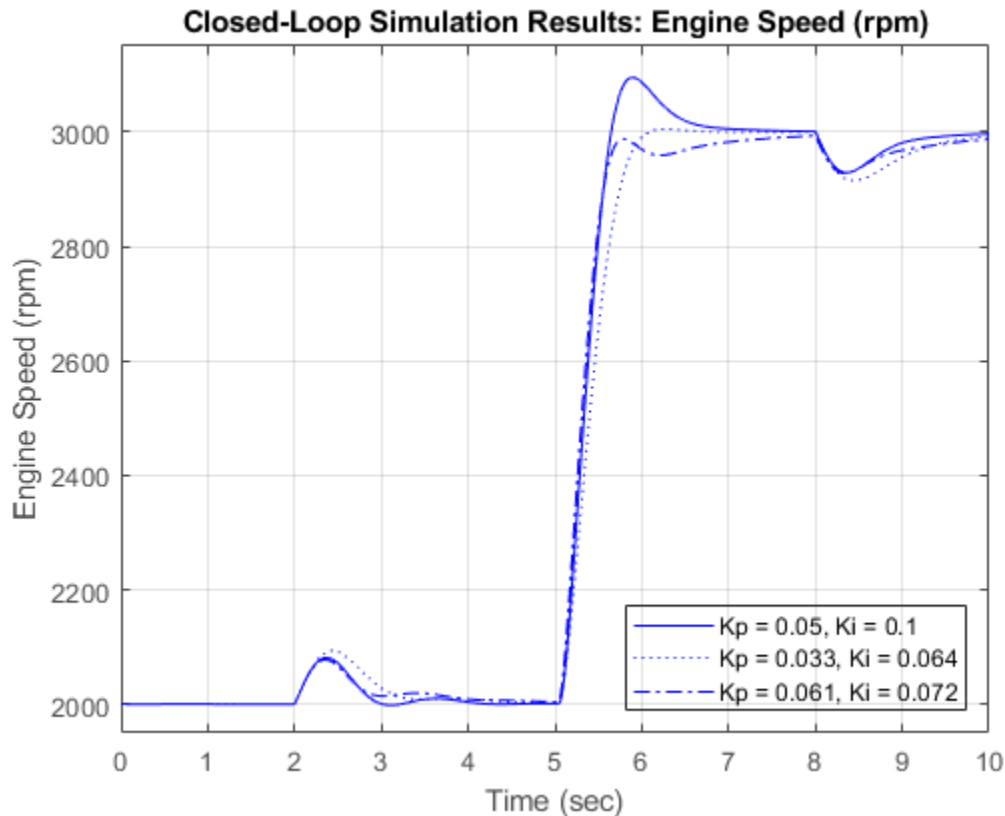

Figure 3: Typical simulation results

Closing Model

Close the model. Clear logged data.

Conclusions

The ability to model nonlinear, complex systems, such as the engine model described here, is one of Simulink's key features. The power of the simulation is evident in the presentation of the models above. Simulink retains model fidelity, including precisely timed cylinder intake events, which is critical in creating a model of this type. The complete speed control system shows the flexibility of Simulink. In particular, the Simulink modeling approaches allow rapid prototyping of an interrupt-driven engine speed controller.

References

[1] P.R. Crossley and J.A. Cook, IEEE® International Conference 'Control 91', Conference Publication 332, vol. 2, pp. 921-925, 25-28 March, 1991, Edinburgh, U.K.

[2] The Simulink Model. Developed by Ken Butts, Ford Motor Company®. Modified by Paul Barnard, Ted Liefeld and Stan Quinn, MathWorks®, 1994-7.

[3] J. J. Moskwa and J. K. Hedrick, "Automotive Engine Modeling for Real Time Control Application," Proc.1987 ACC, pp. 341-346.

[4] B. K. Powell and J. A. Cook, "Nonlinear Low Frequency Phenomenological Engine Modeling and Analysis," Proc. 1987 ACC, pp. 332-340.

[5] R. W. Weeks and J. J. Moskwa, "Automotive Engine Modeling for Real-Time Control Using Matlab/Simulink," 1995 SAE Intl. Cong. paper 950417.

See Also

More About

- "Enable Signal Logging for a Model"
- "Modeling Engine Timing Using Triggered Subsystems" on page 13-130
- "Powertrain Blockset"

Building a Clutch Lock-Up Model

This example shows how to use Simulink® to model and simulate a rotating clutch system. Although modeling a clutch system is difficult because of topological changes in the system dynamics during lockup, this example shows how Simulink's enabled subsystems easily handle such problems. We illustrate how to employ important Simulink modeling concepts in the creation of the clutch simulation. Designers can apply these concepts to many models with strong discontinuities and constraints that may change dynamically.

In the example, you use enabled subsystems to build the clutch model. Two enabled subsystems model the clutch dynamics in either the locked or unlocked position. After running the simulation, a GUI opens. Checking any of the boxes on the GUI produces a plot of any of the selected variables (versus time).

Analysis and Physics

The clutch system in this example consists of two plates that transmit torque between the engine and transmission (see Figure 1). There are two distinct modes of operation:

- 1) slipping - the two plates have differing angular velocities
- 2) lockup - the two plates rotate together.

Handling the transition between these two modes presents a modeling challenge. As the system loses a degree of freedom upon lockup, the transmitted torque goes through a step discontinuity. The magnitude of the torque drops from the maximum value supported by the friction capacity to a value that is necessary to keep the two halves of the system spinning at the same rate. The reverse transition, break-apart, is likewise challenging, as the torque transmitted by the clutch plates exceeds the friction capacity.

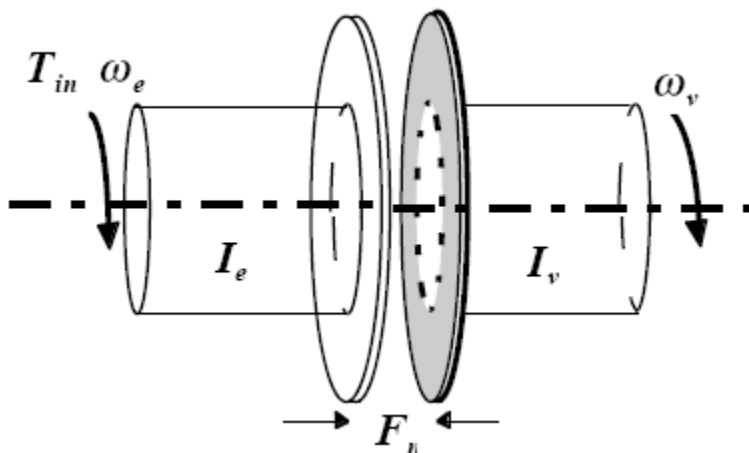

Figure 1: The clutch system, analyzed using a lumped-parameter model

Variables Used

The following variables are used in the analysis and modeling.

$$T_{in} = \text{input (engine) torque;}$$

F_n = normal force between friction plates;

I_e, I_v = moments of inertia for the engine and for the transmission/vehicle;

b_e, b_v = damping rates at the engine and transmission/vehicle sides of the clutch;

μ_k, μ_s = kinetic and static coefficients of friction;

ω_e, ω_v = angular speeds of the engine and transmission/vehicle input shafts;

r_1, r_2 = inner and outer radii of the clutch plate friction surfaces;

R = equivalent net radius;

T_{cl} = torque transmitted through the clutch;

T_l = friction torque required of the clutch to maintain lockup;

Equation 1

The state equations for the coupled system are derived as follows:

$$I_e \dot{\omega}_e = T_{in} - b_e \omega_e - T_{cl}$$

$$I_v \dot{\omega}_v = T_{cl} - b_v \omega_v$$

Equation 2

The torque capacity of the clutch is a function of its size, friction characteristics, and the normal force that is applied.

$$(T_f)_{\max} = \int \int_A \frac{r \times F_f}{A} da = \frac{F_n \mu}{\pi(r_2^2 - r_1^2)} \int_{r_1}^{r_2} \int_0^{2\pi} r^2 dr d\theta = \frac{2}{3} R F_n \mu$$

$$R = \frac{r_2^3 - r_1^3}{r_2^2 - r_1^2}$$

Equation 3

When the clutch is slipping, the model uses the kinetic coefficient of friction and the full capacity is available, in the direction that opposes slip.

$$T_{fmaxk} = \frac{2}{3} R F_n \mu_k$$

$$T_{cl} = \text{sgn}(\omega_e - \omega_v) T_{fmaxk}$$

where sgn denotes the sign function.

Equation 4

When the clutch is locked, the angular velocities of the engine and transmission input shafts are the same, and the system torque acts on the combined inertia as a single unit. So, we combine the differential equations (Equation 1) into a single equation for the locked state.

$$\omega_e = \omega_v = \omega$$

$$(I_e + I_v)\dot{\omega} = T_{in} - (b_e + b_v)\omega$$

Equation 5

Solving Equation 1 and Equation 4, the torque transmitted by the clutch while locked is:

$$T_{cl} = T_f = \frac{I_v T_{in} - (I_v b_e - I_e b_v)\omega}{I_v + I_e}$$

Equation 6

The clutch thus remains locked unless the magnitude of T_f exceeds the static friction capacity, T_{fmaxs} .

$$T_{fmaxs} = \frac{2}{3}RF_n\mu_s$$

The state diagram in Figure 2 describes the overall behavior of the clutch.

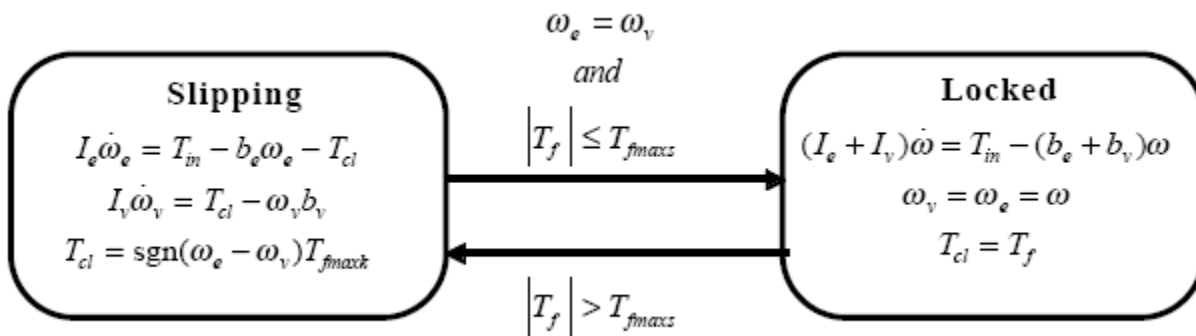

Figure 2: A state diagram describing the friction mode transitions

Modeling

There are two methods for solving this type of problem:

- 1) Compute the clutch torque transmitted at all times, and employ this value directly in the model.
- 2) Use two different dynamic models and switch between them at the appropriate times.

Because of its overall capabilities, Simulink can model either method. In this example, we describe a simulation for the second method. In the second method, switching between two dynamic models must be performed with care to ensure that the initialized states of the new model match the state values immediately prior to the switch. But, in either approach, Simulink facilitates accurate

simulation due to its ability to recognize the precise moments at which transitions between lockup and slipping occur.

The simulation model for the clutch system uses enabled subsystems, a particularly useful feature in Simulink. The simulation can use one subsystem while the clutch is slipping and the other when it is locked. A diagram of the Simulink model appears in Figure 3.

Opening the Model and Running the Simulation

When the model is open, to run the simulation, click **Run**.

- Note: If you are using MATLAB Help, you can execute code from the example page by selecting the code and pressing F9. You can also Select Code > Right Click > Select "Evaluate Selection".

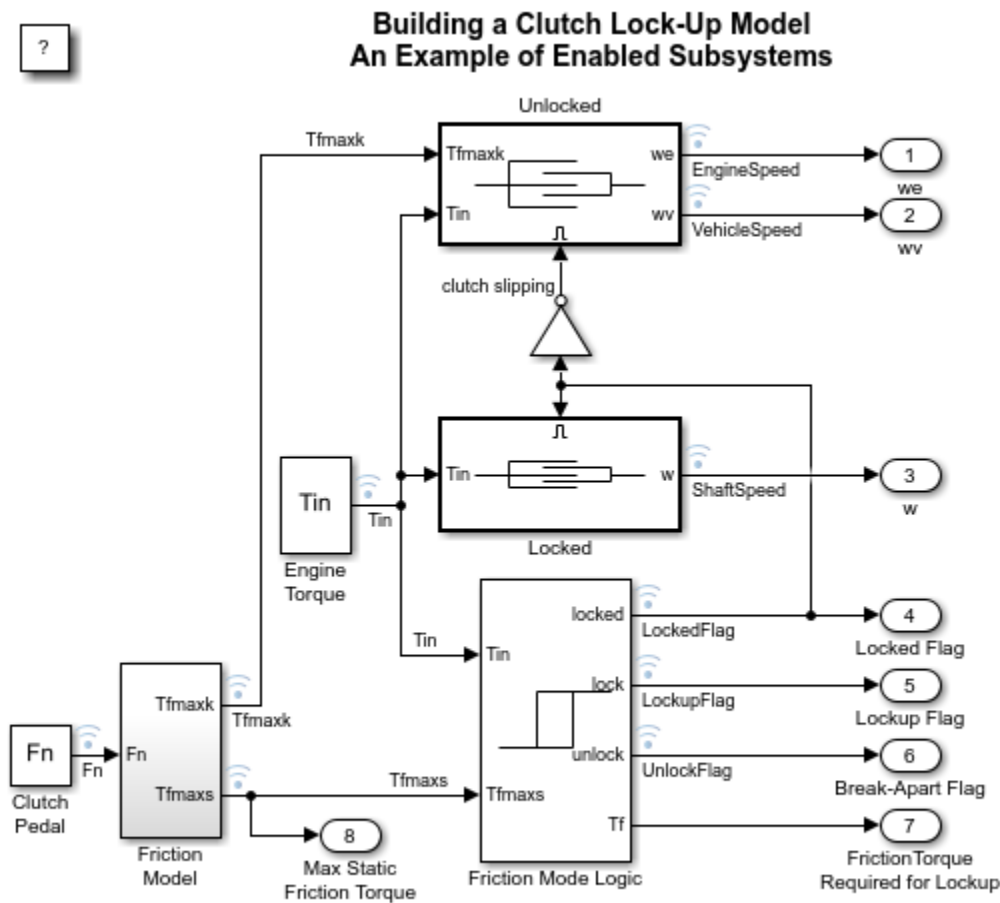

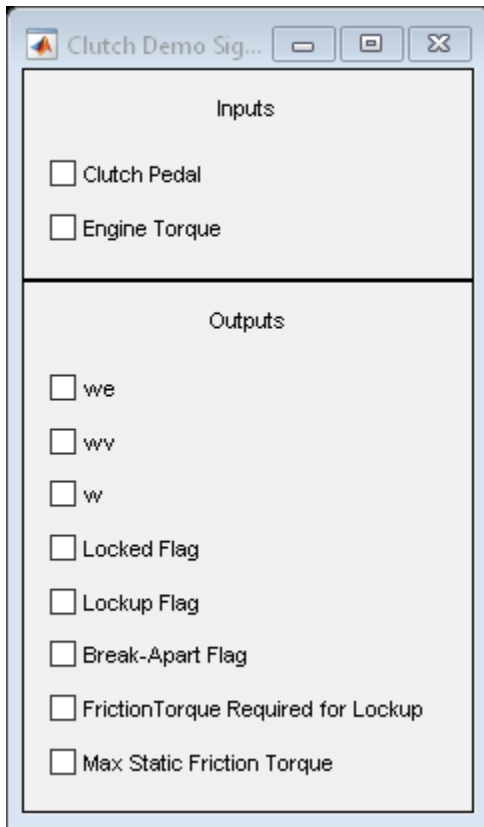

Figure 3: Top level diagram for the clutch model

- Note: The model logs relevant data to MATLAB workspace in a structure called `sldemo_clutch_output`. For information about signal logging, see "Configure a Signal for Logging".

The 'Unlocked' Subsystem

Double click on the 'Unlocked' subsystem in the model window to open it. This subsystem models both sides of the clutch, coupled by the friction torque. It is constructed around the integrator blocks which calculate engine and vehicle speeds (see Figure 4). The model uses gain, multiplication, and summation blocks to compute the speed derivatives (acceleration) from the states and the subsystem inputs of engine torque, T_{in} , and clutch capacity, T_{fmaxk} .

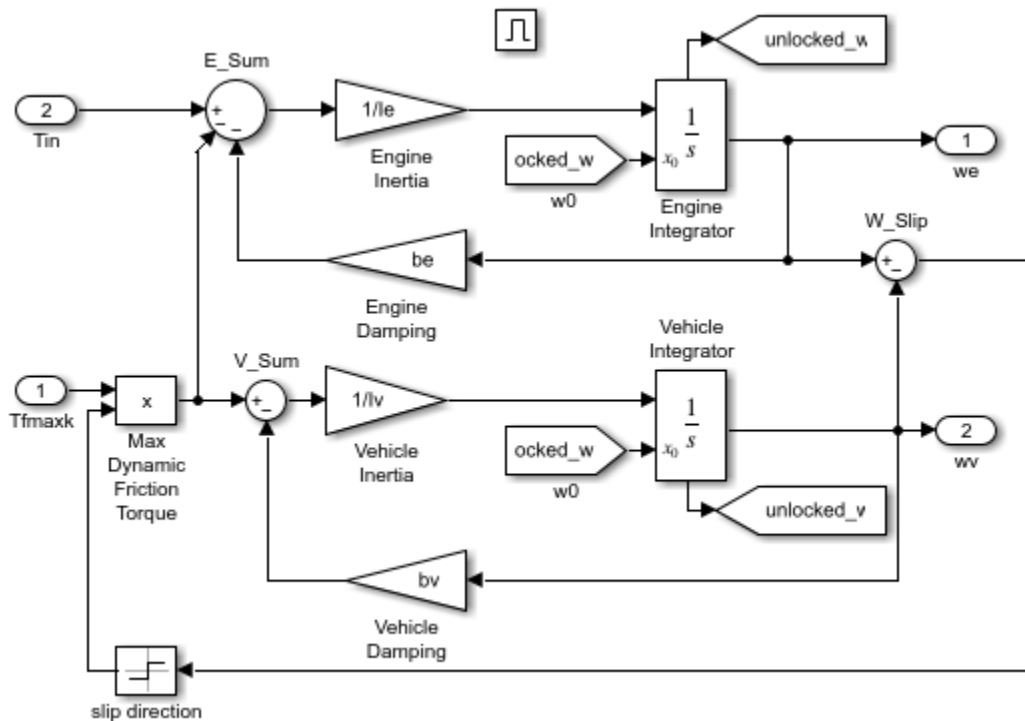

Figure 4: The 'Unlocked' subsystem

Enabled subsystems, such as 'Unlocked', feature several other noteworthy characteristics. The 'Enable' block at the top of the diagram in Figure 4, defines the model as an enabled subsystem. To create an enabled subsystem, we group the blocks together like any other subsystem. We then insert an 'Enable' block from the Simulink Connections library. This means that:

- An enable input appears on the subsystem block, identified by the pulse-shaped symbol used on the 'Enable' block itself.
- The subsystem executes only when the signal at the enable input is greater than zero.

In this example, the 'Unlocked' subsystem executes only when the supervising system logic determines that it should be enabled.

There is another important consideration when using systems that can be enabled or disabled. When the system is enabled, the simulation must reinitialize the integrators to begin simulating from the correct point. In this case, both sides of the clutch are moving at the same velocity the moment it unlocks. The 'Unlocked' subsystem, which had been dormant, needs to initialize both integrators at that speed in order to keep the system speeds continuous.

The simulation uses 'From' blocks to communicate the state of the locked speed to the initial condition inputs of the two integrators. Each 'From' block represents an invisible connection between itself and a 'Goto' block somewhere else in the system. The 'Goto' blocks connect to the state ports of the integrators so that the model can use these states elsewhere in the system without explicitly drawing in the connecting lines.

The 'Locked' Subsystem

Open the 'Locked' subsystem by double clicking on it in the model window. This is another enabled subsystem in the clutch model (see Figure 5). It uses a single state to represent the engine and vehicle speeds. It computes acceleration as a function of the speed and input torque. As in the 'Unlocked' case, a 'From' block provides the integrator initial conditions and a 'Goto' block broadcasts the state for use elsewhere in the model. While simulating, either the 'Locked' or the 'Unlocked' subsystem is active at all times. Whenever the control changes, the states are neatly handed off between the two.

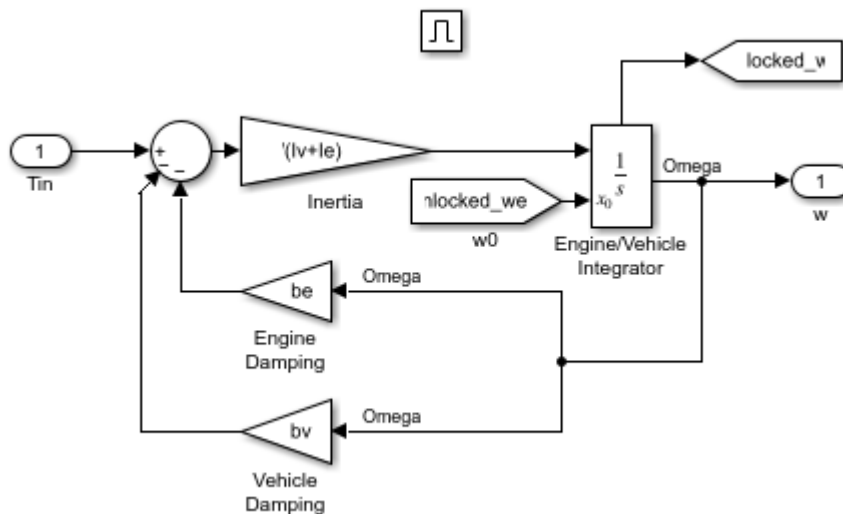

Figure 5: The 'Locked' Subsystem

- The 'Friction Mode Logic' Subsystem

The 'Friction Mode Logic' subsystem (shown in Figure 6) computes the static and kinetic friction (with the appropriate friction coefficient) according to the following formula:

$$T_{fmax} = \frac{2}{3}RF_n\mu$$

Open the 'Friction Mode Logic' subsystem by double clicking on it in the model window.

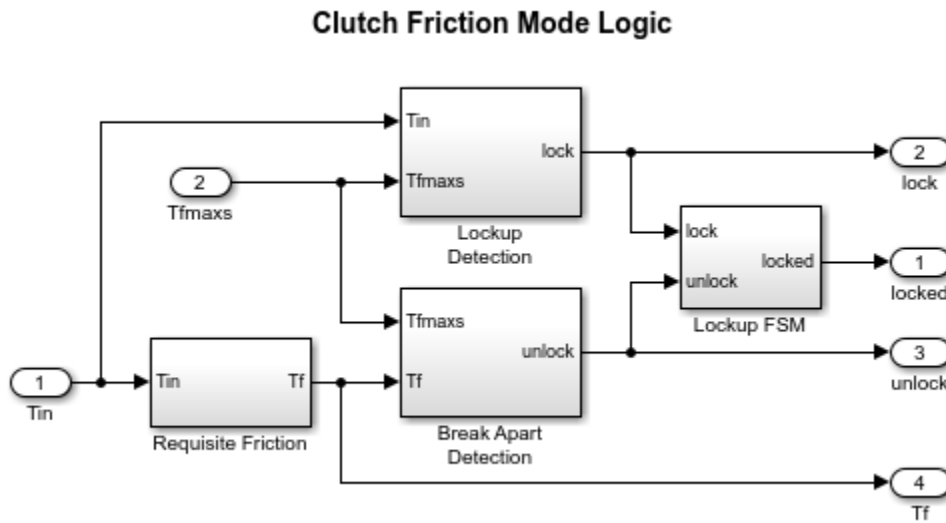

Figure 6: The 'Friction Mode Logic' Subsystem

- Other Components

The remaining blocks calculate the torque required for lockup (Equation 5), and implement the logic described in Figure 2. One key element is located in the 'Lockup Detection' subsystem within the 'Friction Mode Logic' subsystem. This is the 'Simulink Hit Crossing' block which precisely locates the instant at which the clutch slip reaches zero. This places the mode transition at exactly the right moment.

- System Inputs

The system inputs are normal force, F_n , and engine torque, T_{in} . Each of these is represented by a matrix table in the model workspace. The inputs are plotted in Figure 7. You can visualize various signals by checking the corresponding boxes on the 'Clutch Demo Signals' GUI.

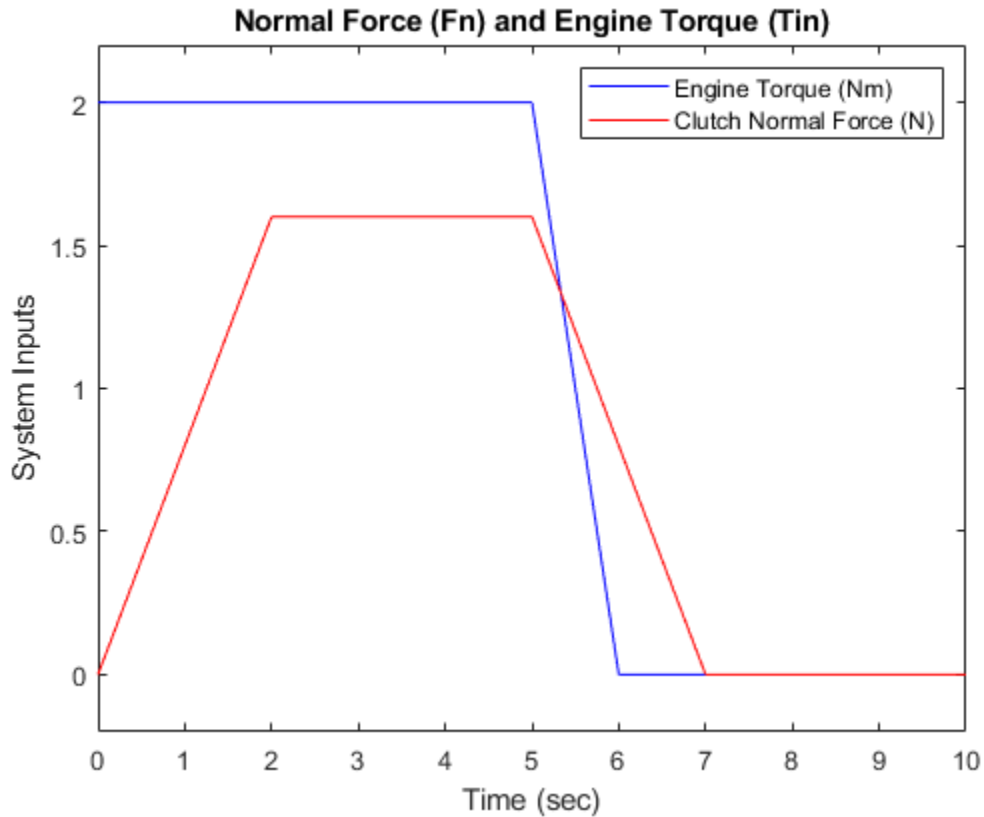

Figure 7: System inputs: normal force and engine torque

Results

The following parameter values are used to show the simulation. These are not meant to represent the physical quantities corresponding to an actual system, but rather to facilitate a meaningful baseline example.

$$I_e = 1 \text{ kg} \cdot \text{m}^2$$

$$I_v = 5 \text{ kg} \cdot \text{m}^2$$

$$b_e = 2 \text{ Nm/rad/sec}$$

$$b_v = 1 \text{ Nm/rad/sec}$$

$$\mu_k = 1$$

$$\mu_s = 1.5$$

$$R = 1 \text{ m}$$

For the inputs shown above, the system velocities behave as shown in Figure 8 below. The simulation begins in the Unlocked mode, with an initial engine speed flare as the vehicle side accelerates its larger inertia. At about $t = 4$ sec, the velocities come together and remain locked, indicating that

the clutch capacity is sufficient to transmit the torque. At $t = 5$ sec, the engine torque begins to decrease, as does the normal force on the friction plates. Consequently, the onset of slip occurs at about $t = 6.25$ sec as indicated by the separation of the engine and vehicle speeds.

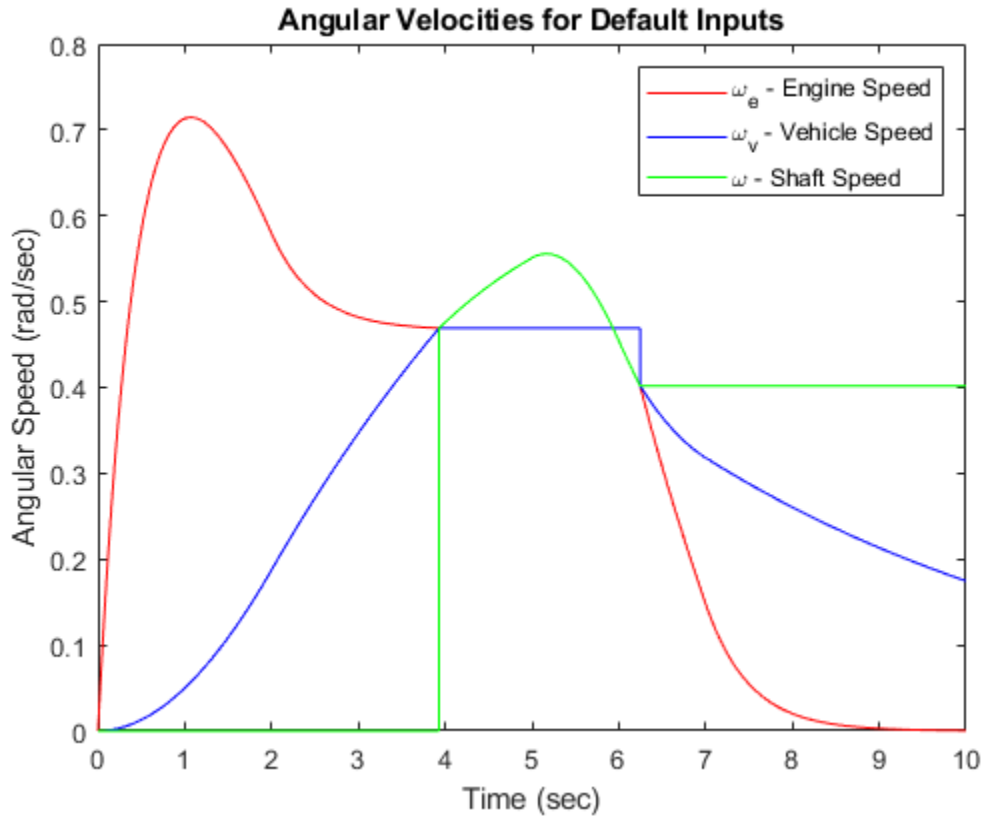

Figure 8: Angular velocities of the engine, vehicle and shaft for default inputs

Notice that the various states remain constant while they are disabled. At the time instants at which transitions take place, the state hand-off is both continuous and smooth. This is a result of supplying each integrator with the appropriate initial conditions to use when the state is enabled.

Closing Model

Close the model. Clear generated data.

Conclusions

This example shows how to use Simulink and its standard block library to model, simulate, and analyze a system with topological discontinuities. This is a powerful example of the 'Hit Crossing' block and how it can be used to capture specific events during a simulation. The Simulink model of

this clutch system can serve as a guide when creating models with similar characteristics. You can apply the principles used in this example to any system with topological discontinuities.

See Also

More About

- “Enable Signal Logging for a Model”
- “Modeling Clutch Lock-Up Using If Blocks” on page 13-155
- “Powertrain Blockset”
- “Vehicle Dynamics Blockset”

Modeling Clutch Lock-Up Using If Blocks

This example shows how to use If/Else subsystems to build a clutch model. An 'If' subsystem models the clutch dynamics in the locked position while an 'Else' subsystem models the unlocked position. One or the other is enabled using the 'If' block. The dot-dashed lines from the 'If' block denote control signals, which are used to enable If/Else (or other conditional) subsystems. Checking any of the boxes on the GUI produces a plot of any of the selected variables (versus time).

Analysis and Physics

The clutch system in this example consists of two plates that transmit torque between the engine and transmission. There are two distinct modes of operation:

- 1) slipping - the two plates have differing angular velocities
- 2) lockup - the two plates rotate together.

Handling the transition between these two modes presents a modeling challenge. As the system loses a degree of freedom upon lockup, the transmitted torque goes through a step discontinuity. The magnitude of the torque drops from the maximum value supported by the friction capacity to a value that is necessary to keep the two halves of the system spinning at the same rate. The reverse transition, break-apart, is likewise challenging, as the torque transmitted by the clutch plates exceeds the friction capacity.

- Note: You can find a detailed analysis of this system, including equations and diagrams, in the example for the clutch model with enabled subsystems.

Modeling

You can use the following two methods for solving this problem:

- 1) Compute the clutch torque transmitted at all times, and employ this value directly in the model.
- 2) Use two different dynamic models and switch between them at the appropriate times.

Simulink® can model either method. In this example, we describe a simulation for the second method. Switching between two dynamic models must be performed with care to ensure that the initialized states of the new model match the state values immediately prior to the switch. In either approach, Simulink facilitates accurate simulation due to its ability to recognize the precise moments at which transitions between lockup and slipping occur.

Running the Simulation

When the model is open, to run the simulation, click **Run**.

?

Clutch Simulation An Example of the If Block

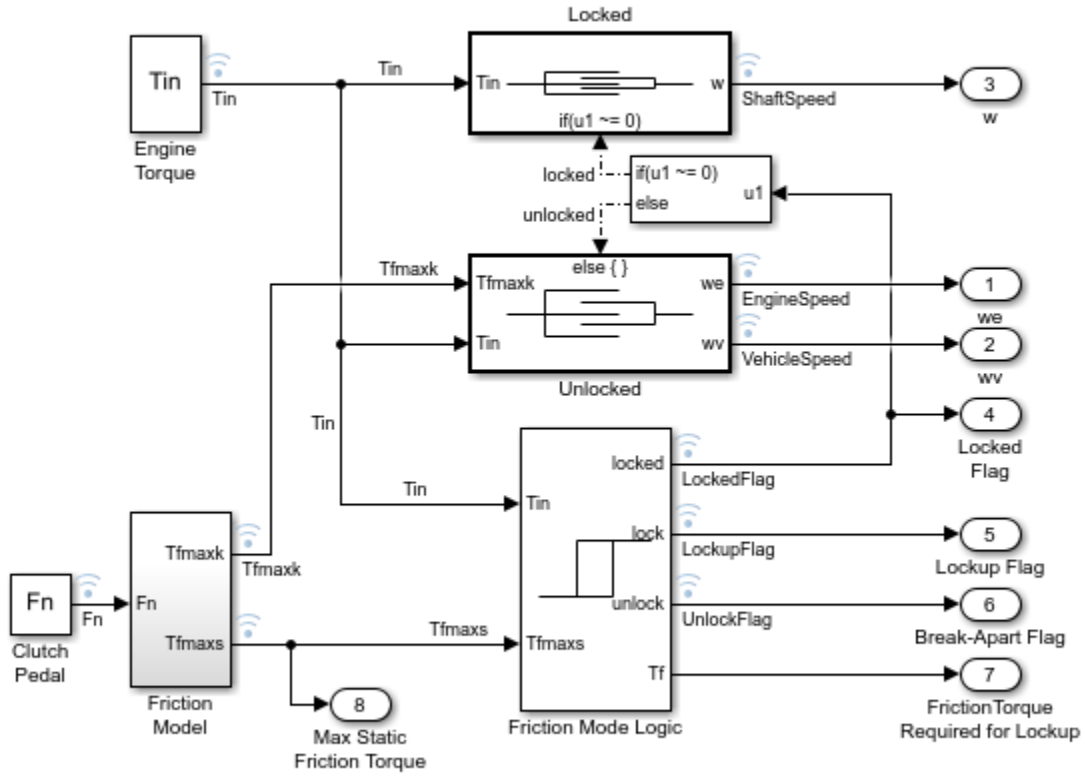

Copyright 1990-2012 The MathWorks, Inc.

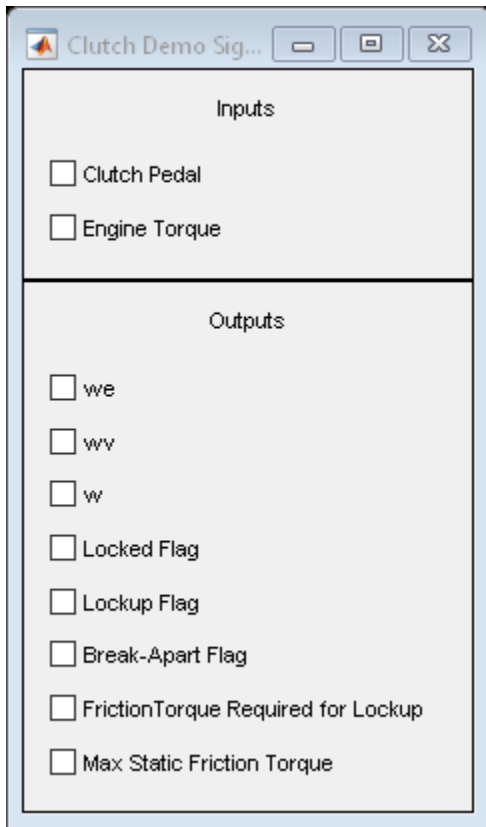

Figure 1: Top level diagram for the clutch model

- Note: The model logs relevant data to MATLAB workspace in a structure called `sldemo_clutch_if_output`. Logged signals have a blue indicator. For information about signal logging, see "Configure a Signal for Logging".

The 'If' Block

The 'If' block uses the `LockedFlag` signal to switch between the 'Locked' and 'Unlocked' subsystems. Double click on the 'If' block in the model to set its parameters (see Figure 2). `LockedFlag` represents the status of the clutch. `LockedFlag = 1` if the clutch is locked and `LockedFlag = 0` if the clutch is unlocked.

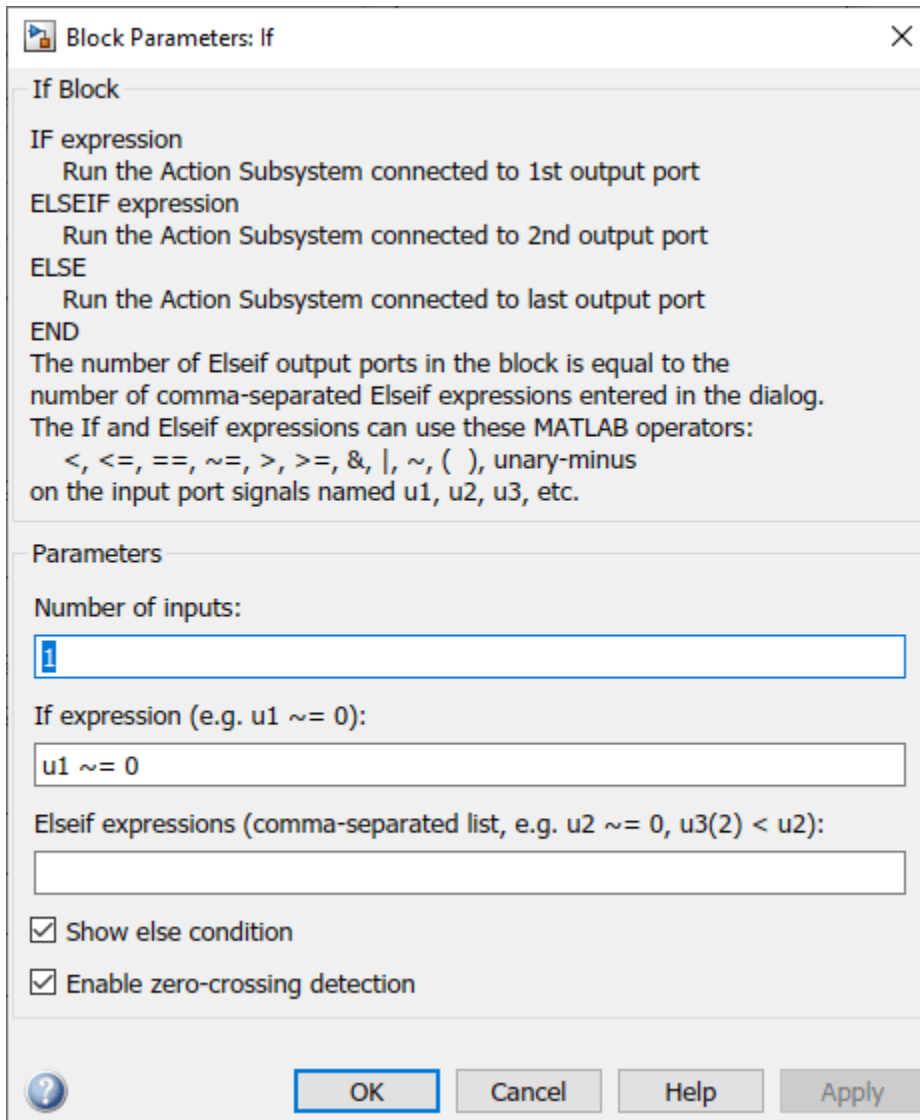

Figure 2: Setting 'If' block parameters

Results

The inputs for this model are the same as for the model that uses enabled subsystems (sldemo_clutch). System velocities behave as shown in Figure 3 below. As expected, the results obtained from sldemo_clutch and sldemo_clutch_if are identical.

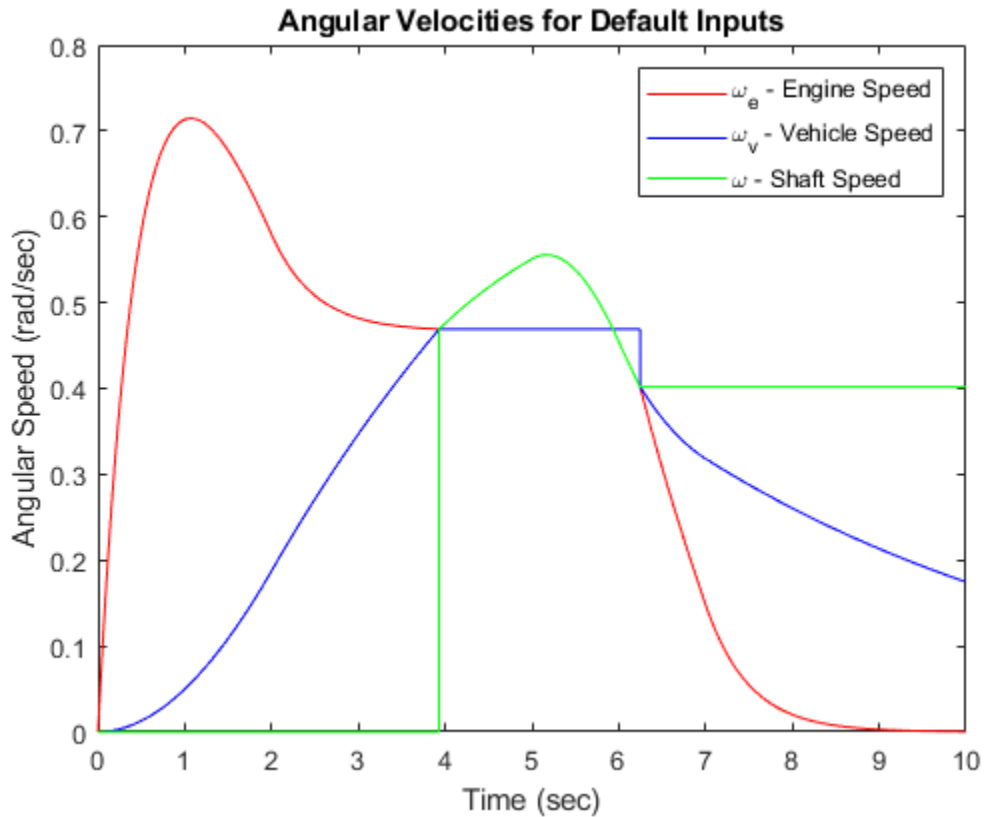

Figure 3: Angular velocities of the engine, vehicle and shaft for default inputs

Closing Model

Close the model. Clear generated data.

Conclusions

This example shows how to use 'If' blocks in Simulink to model a system with topological discontinuities. This is an alternative to using enabled subsystems.

See Also

If

More About

- “Building a Clutch Lock-Up Model” on page 13-144
- “Enable Signal Logging for a Model”
- “Powertrain Blockset”
- “Vehicle Dynamics Blockset”

Modeling an Anti-Lock Braking System

This example shows how to model a simple model for an Anti-Lock Braking System (ABS). It simulates the dynamic behavior of a vehicle under hard braking conditions. The model represents a single wheel, which may be replicated a number of times to create a model for a multi-wheel vehicle.

This model uses the signal logging feature in Simulink®. The model logs signals to the MATLAB® workspace where you can analyze and view them. You can view the code in `ModelingAnAntiLockBrakingSystemExample.m` to see how this is done.

In this model, the wheel speed is calculated in a separate model named `sldemo_wheel_speed_absbrake`. This component is then referenced using a 'Model' block. Note that both the top model and the referenced model use a variable step solver, so Simulink will track zero-crossings in the referenced model.

Analysis and Physics

The wheel rotates with an initial angular speed that corresponds to the vehicle speed before the brakes are applied. We used separate integrators to compute wheel angular speed and vehicle speed. We use two speeds to calculate slip, which is determined by Equation 1. Note that we introduce vehicle speed expressed as an angular velocity (see below).

$$\omega_v = \frac{V}{R} \text{ (equals the wheel angular speed if there is no slip)}$$

Equation 1

$$\omega_v = \frac{V_v}{R_r}$$

$$slip = 1 - \frac{\omega_w}{\omega_v}$$

ω_v = vehicle speed divided by wheel radius

V_v = vehicle linear velocity

R_r = wheel radius

ω_w = wheel angular velocity

From these expressions, we see that slip is zero when wheel speed and vehicle speed are equal, and slip equals one when the wheel is locked. A desirable slip value is 0.2, which means that the number of wheel revolutions equals 0.8 times the number of revolutions under non-braking conditions with the same vehicle velocity. This maximizes the adhesion between the tire and road and minimizes the stopping distance with the available friction.

Modeling

The friction coefficient between the tire and the road surface, μ , is an empirical function of slip, known as the mu-slip curve. We created mu-slip curves by passing MATLAB variables into the block diagram using a Simulink lookup table. The model multiplies the friction coefficient, μ , by the weight on the wheel, W , to yield the frictional force, F_f , acting on the circumference of the tire. F_f is

divided by the vehicle mass to produce the vehicle deceleration, which the model integrates to obtain vehicle velocity.

In this model, we used an ideal anti-lock braking controller, that uses 'bang-bang' control based upon the error between actual slip and desired slip. We set the desired slip to the value of slip at which the mu-slip curve reaches a peak value, this being the optimum value for minimum braking distance (see note below.).

- Note: In an actual vehicle, the slip cannot be measured directly, so this control algorithm is not practical. It is used in this example to illustrate the conceptual construction of such a simulation model. The real engineering value of a simulation like this is to show the potential of the control concept prior to addressing the specific issues of implementation.

Opening the Model

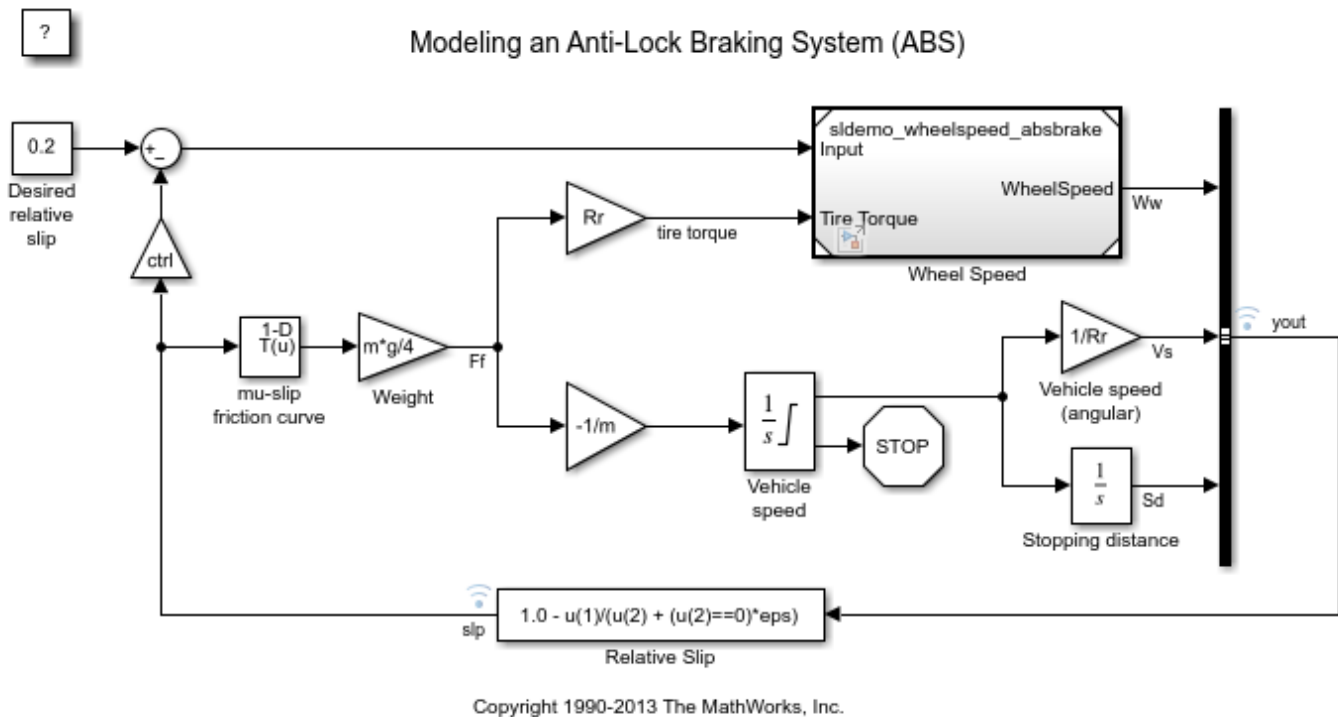

Double click on the Wheel Speed subsystem in the model window to open it. Given the wheel slip, the desired wheel slip, and the tire torque, this subsystem calculates the wheel angular speed.

?

Calculate the Wheel Speed for the Anti-Lock Braking System (ABS) Simulation

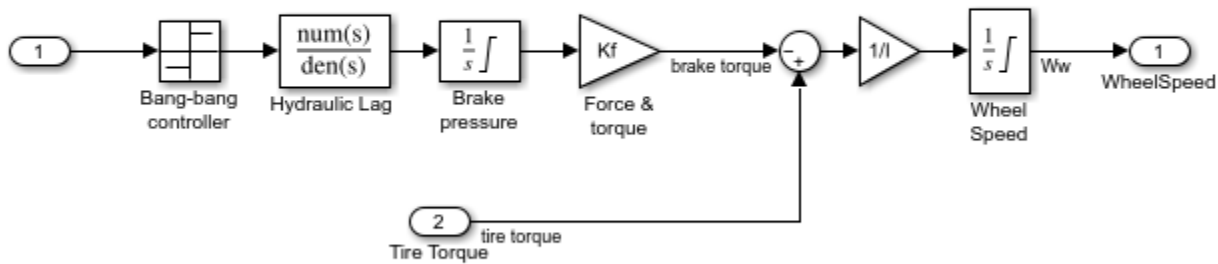

Copyright 1990-2013 The MathWorks, Inc.

To control the rate of change of brake pressure, the model subtracts actual slip from the desired slip and feeds this signal into a bang-bang control (+1 or -1, depending on the sign of the error). This on/off rate passes through a first-order lag that represents the delay associated with the hydraulic lines of the brake system. The model then integrates the filtered rate to yield the actual brake pressure. The resulting signal, multiplied by the piston area and radius with respect to the wheel (Kf), is the brake torque applied to the wheel.

The model multiplies the frictional force on the wheel by the wheel radius (Rr) to give the accelerating torque of the road surface on the wheel. The brake torque is subtracted to give the net torque on the wheel. Dividing the net torque by the wheel rotational inertia, I, yields the wheel acceleration, which is then integrated to provide wheel velocity. In order to keep the wheel speed and vehicle speed positive, limited integrators are used in this model.

Running the Simulation in ABS Mode

On the Simulation tab, click **Run** to run the simulation. You can also run the simulation by executing the `sim('sldemo_absbrake')` command in MATLAB. ABS is turned on during this simulation.

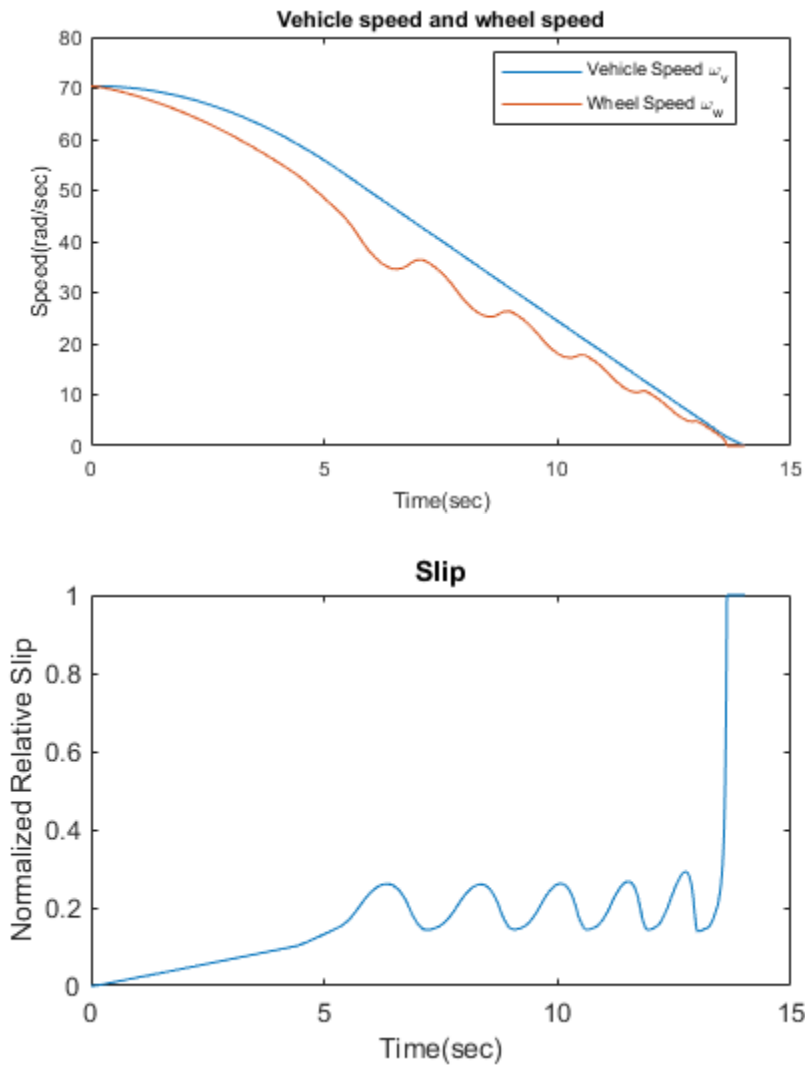

- Note: The model logs relevant data to MATLAB workspace in a structure called `sldemo_absbrake_output`. Logged signals have a blue indicator. In this case `yout` and `slp` are logged. Read more about Signal Logging in Simulink Help.

The plots above show the ABS simulation results (for default parameters). The first plot shows the wheel angular velocity and corresponding vehicle angular velocity. This plot shows that the wheel speed stays below vehicle speed without locking up, with vehicle speed going to zero in less than 15 seconds.

Running the Simulation Without ABS

For more meaningful results, consider the vehicle behavior without ABS. At the MATLAB command line, set the model variable `ctrl = 0`. This disconnects the slip feedback from the controller, resulting in maximum braking.

```
ctrl = 0;
```

Now run the simulation again. This will model braking without ABS.

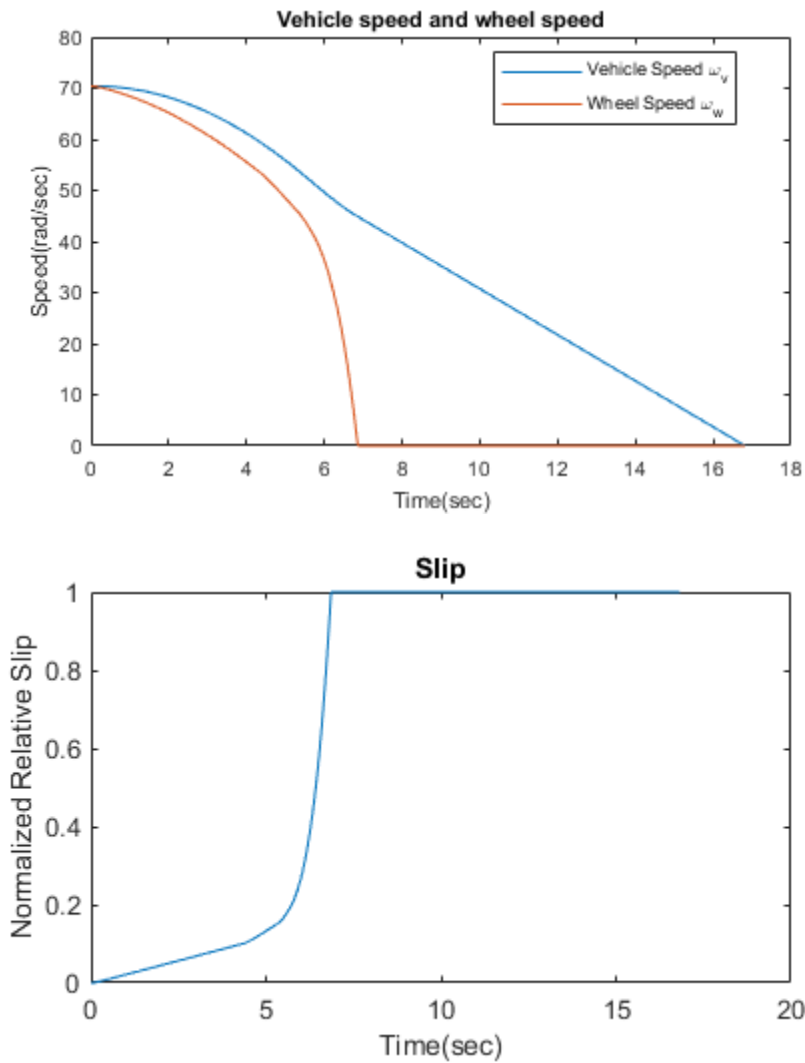

Braking With ABS Versus Braking Without ABS

In the plot showing vehicle speed and wheel speed, observe that the wheel locks up in about seven seconds. The braking, from that point on, is applied in a less-than-optimal part of the slip curve. That is, when $\text{slip} = 1$, as the slip plot shows, the tire is skidding so much on the pavement that the friction force has dropped off.

This is, perhaps, more meaningful in terms of the comparison shown below. The distance traveled by the vehicle is plotted for the two cases. Without ABS, the vehicle skids about an extra 100 feet, taking about three seconds longer to come to a stop.

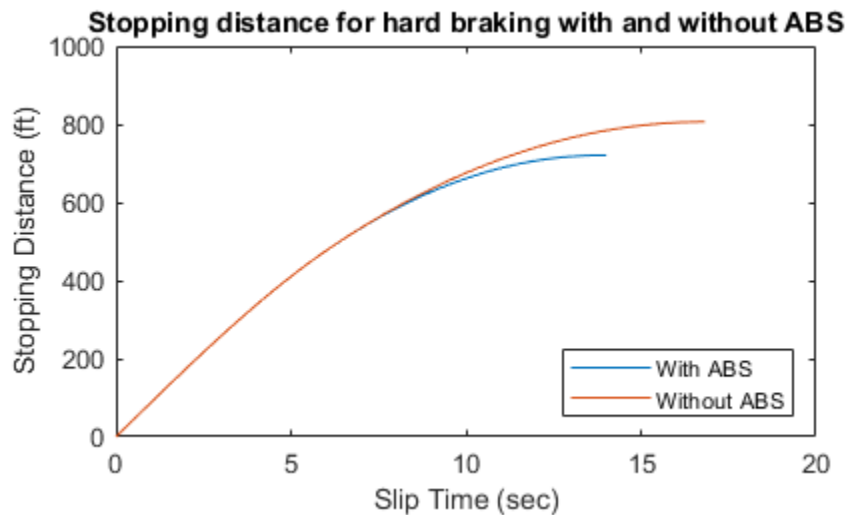

Closing the Model

Close the model. Close the 'Wheel Speed' subsystem. Clear logged data.

Conclusions

This model shows how you can use Simulink to simulate a braking system under the action of an ABS controller. The controller in this example is idealized, but you can use any proposed control algorithm in its place to evaluate the system's performance. You can also use the Simulink® Coder™ with Simulink as a valuable tool for rapid prototyping of the proposed algorithm. C code is generated and compiled for the controller hardware to test the concept in a vehicle. This significantly reduces the time needed to prove new ideas by enabling actual testing early in the development cycle.

For a hardware-in-the-loop braking system simulation, you can remove the 'bang-bang' controller and run the equations of motion on real-time hardware to emulate the wheel and vehicle dynamics. You can do this by generating real-time C code for this model using the Simulink Coder. You can then test an actual ABS controller by interfacing it to the real-time hardware, which runs the generated code. In this scenario, the real-time model would send the wheel speed to the controller, and the controller would send brake action to the model.

See Also

More About

- “Enable Signal Logging for a Model”
- “Powertrain Blockset”
- “Vehicle Dynamics Blockset”

Automotive Suspension

This example shows how to model a simplified half-car model that includes an independent front and rear vertical suspension. The model also includes body pitch and bounce degrees of freedom. The example provides a description of the model to show how simulation can be used to investigate ride characteristics. You can use this model in conjunction with a powertrain simulation to investigate longitudinal shuffle resulting from changes in throttle setting.

Analysis and Physics

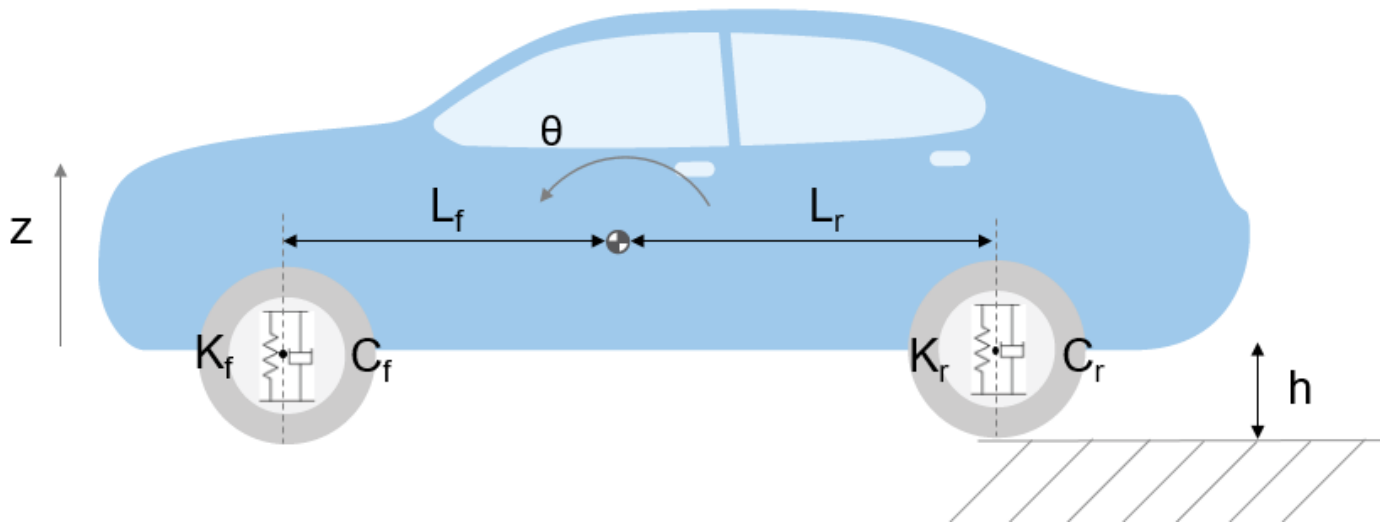

Free-body diagram of the half-car model

The illustration shows the modeled characteristics of the half-car. The front and rear suspension are modeled as spring/damper systems. A more detailed model would include a tire model, and damper nonlinearities such as velocity-dependent damping (with greater damping during rebound than compression). The vehicle body has pitch and bounce degrees of freedom. They are represented in the model by four states: vertical displacement, vertical velocity, pitch angular displacement, and pitch angular velocity. A full model with six degrees of freedom can be implemented using vector algebra blocks to perform axis transformations and force/displacement/velocity calculations.

Equation 1 describes the influence of the front suspension on the bounce (i.e. vertical degree of freedom):

$$F_f = 2K_f(L_f\theta - (z + h)) + 2C_f(L_f\dot{\theta} - \dot{z})$$

where:

F_f, F_r = upward force on body from front/rear suspension

K_f, K_r = front and rear suspension spring constant

C_f, C_r = front and rear suspension damping rate

L_f, L_r = horizontal distance from gravity center to front/rear suspension

$\theta, \dot{\theta}$ = pitch (rotational) angle and its rate of change

z, \dot{z} = bounce (vertical) distance and its rate of change

h = road height

Equations 2 describe pitch moments due to the suspension.

$$M_f = -L_f F_f$$

$$F_r = -2K_r(L_r\theta + (z + h)) - 2C_r(L_r\dot{\theta} + \dot{z})$$

$$M_r = L_r F_r$$

where:

M_f, M_r = Pitch moment due to front/rear suspension

Equations 3 resolves the forces and moments result in body motion, according to Newton's Second Law:

$$m_b \ddot{z} = F_f + F_r - m_b g$$

$$I_{yy} \ddot{\theta} = M_f + M_r + M_y$$

where:

m_b = body mass

M_y = pitch moment induced by vehicle acceleration

I_{yy} = body moment of inertia about gravity center

Model

To open the model, type `sldemo_suspn` in the MATLAB® command window.

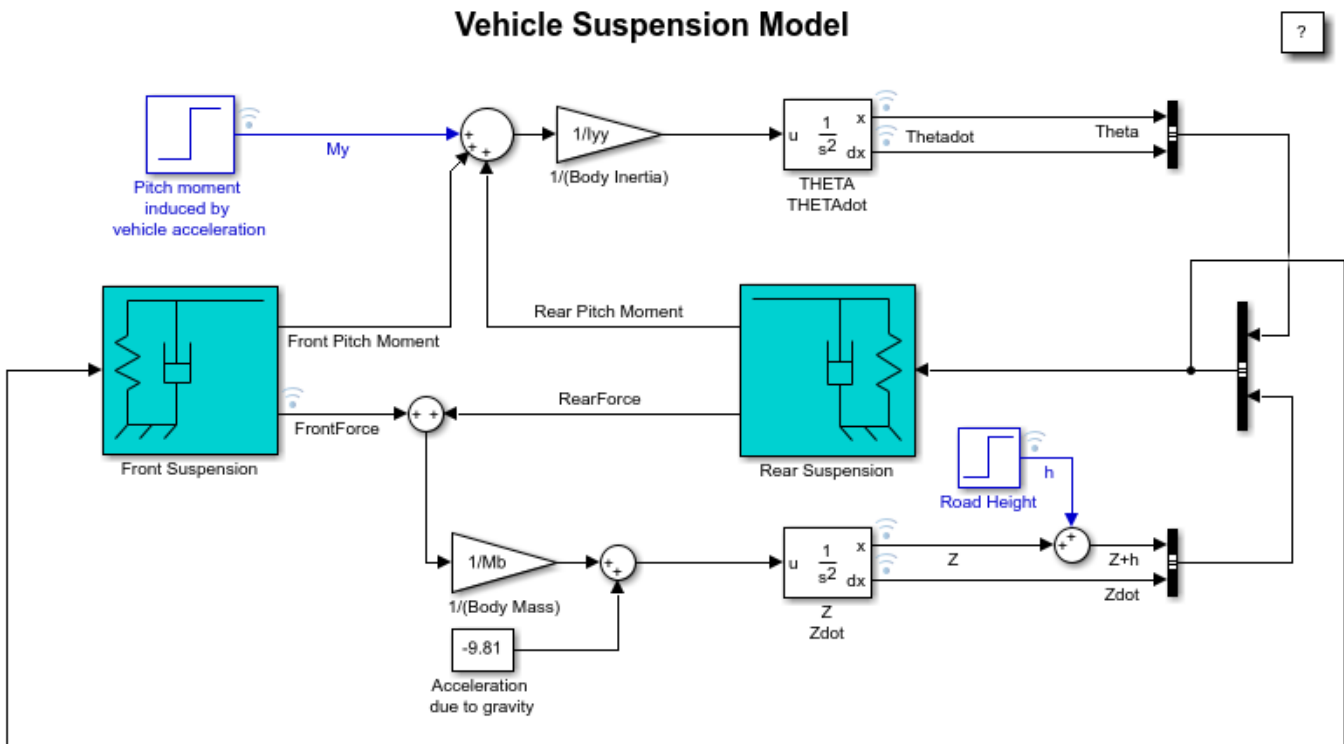

Copyright 1990-2021 The MathWorks, Inc.

Top-level diagram of the suspension model

The suspension model has two inputs, and both input blocks are blue on the model diagram. The first input is the road height. A step input here corresponds to the vehicle driving over a road surface with a step change in height. The second input is a horizontal force acting through the center of the wheels that results from braking or acceleration maneuvers. This input appears only as a moment about the pitch axis because the longitudinal body motion is not modeled.

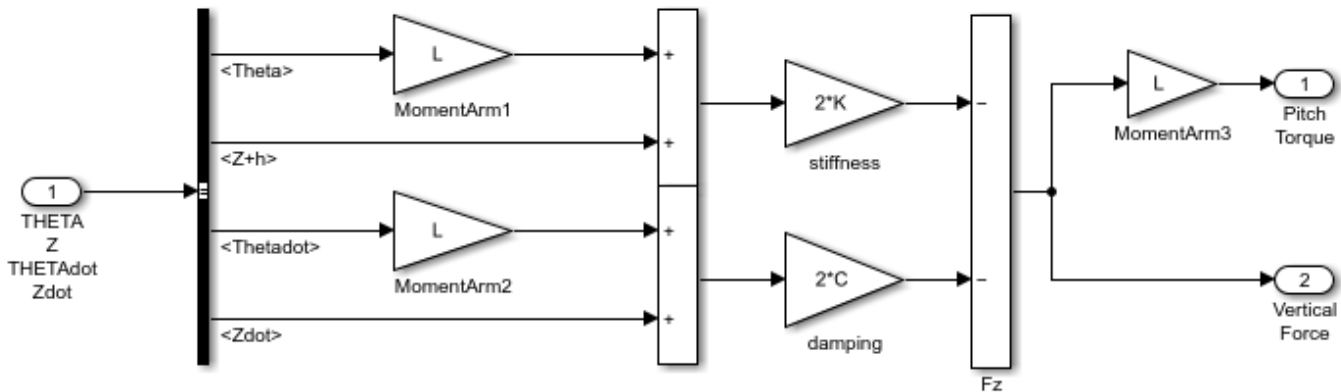

Two DOF Spring/Damper Model

The Spring/Damper model used in FrontSuspension and RearSuspension subsystems

The spring/damper subsystem that models the front and rear suspensions is shown above. Right click on the Front/Rear Suspension block and select **Mask > Look Under Mask** to see the front/rear suspension subsystem. The suspension subsystems are used to model Equations 1-3. The equations are implemented directly in the Simulink® diagram through the straightforward use of Gain and Summation blocks.

The differences between front and rear are accounted for as follows. Because the subsystem is a masked block, a different data set (L, K and C) can be entered for each instance. Furthermore, L is thought of as the Cartesian coordinate x , being negative or positive with respect to the origin, or center of gravity. Thus, K_f , C_f , and $-L_f$ are used for the front suspension block whereas K_r , C_r , and L_r are used for the rear suspension block.

Run the Simulation

To run this model, on the **Simulation** tab, click **Run**. Initial conditions are loaded into the model workspace from the `sldemo_suspdta.m` file. To see the contents of the model workspace, in the Simulink Editor, on the **Modeling** tab, under **Design**, select **Model Explorer**. In the Model Explorer, look under the contents of the `sldemo_suspn` model and select "Model Workspace". Loading initial conditions in the model workspace prevents any accidental modifications of parameters and keeps MATLAB workspace clean.

Note that the model logs relevant data to MATLAB workspace in a data structure called `sldemo_suspn_output`. Type the name of the structure to see what data it contains.

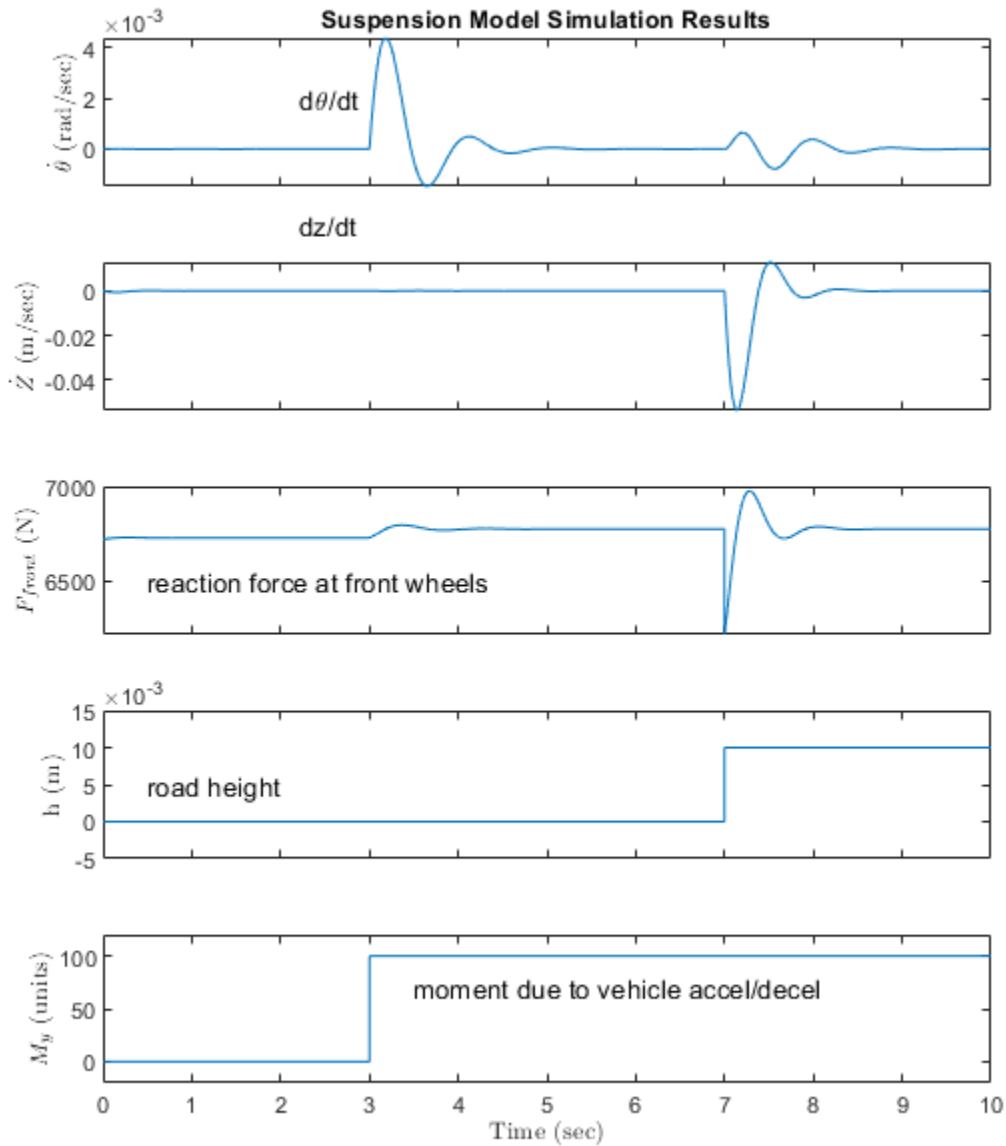

Simulation results

Simulation results are displayed above. The results are plotted by the `sldemo_suspgraph.m` file. The default initial conditions are given in Table 1.

Table 1: Default initial conditions

```
Lf = 0.9;    % front hub displacement from body gravity center (m)
Lr = 1.2;    % rear hub displacement from body gravity center (m)
Mb = 1200;   % body mass (kg)
Iyy = 2100;  % body moment of inertia about y-axis in (kg m^2)
```

```
kf = 28000; % front suspension stiffness in (N/m)
kr = 21000; % rear suspension stiffness in (N/m)
cf = 2500; % front suspension damping in (N sec/m)
cr = 2000; % rear suspension damping in (N sec/m)
```

Close the Model

Close the model and delete generated data from MATLAB workspace.

Conclusions

This model allows you to simulate the effects of changing the suspension damping and stiffness, thereby investigating the tradeoff between comfort and performance. In general, racing cars have very stiff springs with a high damping factor, whereas passenger vehicles have softer springs and a more oscillatory response.

See Also

More About

- “Powertrain Blockset”
- “Vehicle Dynamics Blockset”

Modeling an Automatic Transmission Controller

This example shows how to model an automotive drivetrain with Simulink®. Stateflow® enhances the Simulink model with its representation of the transmission control logic. Simulink provides a powerful environment for the modeling and simulation of dynamic systems and processes. In many systems, though, supervisory functions like changing modes or invoking new gain schedules must respond to events that may occur and conditions that develop over time. As a result, the environment requires a language capable of managing these multiple modes and developing conditions. In the following example, Stateflow shows its strength in this capacity by performing the function of gear selection in an automatic transmission. This function is combined with the drivetrain dynamics in a natural and intuitive manner by incorporating a Stateflow block in the Simulink block diagram.

Analysis and Physics

The figure below shows the power flow in a typical automotive drivetrain. Nonlinear ordinary differential equations model the engine, four-speed automatic transmission, and vehicle. The model discussed in this example directly implements the blocks from this figure as modular Simulink subsystems. On the other hand, the logic and decisions made in the Transmission Control Unit (TCU) do not lend themselves to well-formulated equations. TCU is better suited for a Stateflow representation. Stateflow monitors the events which correspond to important relationships within the system and takes the appropriate action as they occur.

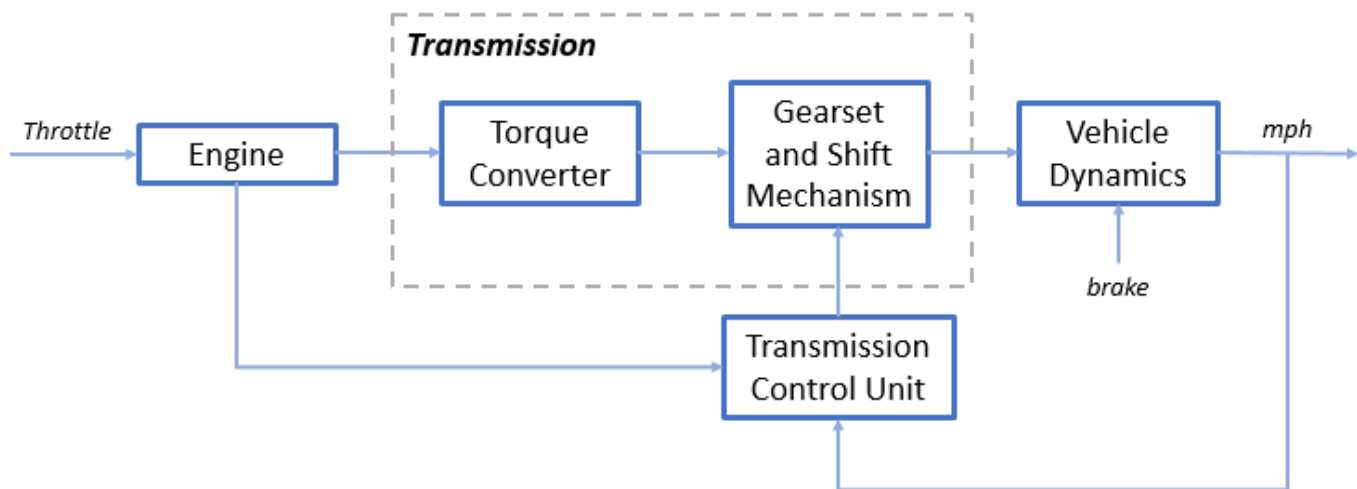

The throttle opening is one of the inputs to the engine. The engine is connected to the impeller of the torque converter which couples it to the transmission (see Equation 1).

Equation 1

$$I_{ei} \dot{N}_e = T_e - T_i$$

N_e = engine speed (RPM)

I_{ei} = moment of inertia of the engine and the impeller

T_e, T_i = engine and impeller torque

The input-output characteristics of the torque converter can be expressed as functions of the engine speed and the turbine speed. In this example, the direction of power flow is always assumed to be from the impeller to the turbine (see Equation 2).

Equation 2

$$T_i = \frac{N_e^2}{K^2}$$

$$K = f_2 \frac{N_{in}}{N_e} = \text{K-factor (capacity)}$$

$$N_{in} = \text{speed of turbine (torque converter output) = transmission input speed (RPM)}$$

$$R_{TQ} = f_3 \frac{N_{in}}{N_e} = \text{torque ratio}$$

The transmission model is implemented via static gear ratios, assuming small shift times (see Equation 3).

Equation 3

$$R_{TR} = f_4(\text{gear}) = \text{transmission ratio}$$

$$T_{out} = R_{TR} T_{in}$$

$$N_{in} = R_{TR} N_{out}$$

$$T_{in}, T_{out} = \text{transmission input and output torques}$$

$$N_{in}, N_{out} = \text{transmission input and output speed (RPM)}$$

The final drive, inertia, and a dynamically varying load constitute the vehicle dynamics (see Equation 4).

Equation 4

$$I_v \dot{N}_w = R_{fd}(T_{out} - T_{load})$$

$$I_v = \text{vehicle inertia}$$

$$N_w = \text{wheel speed (RPM)}$$

$$R_{fd} = \text{final drive ratio}$$

$$T_{load} = f_5(N_w) = \text{load torque}$$

The load torque includes both the road load and brake torque. The road load is the sum of frictional and aerodynamic losses (see Equation 5).

Equation 5

$$T_{load} = \text{sgn}(mph)(R_{load0} + R_{load2}mph^2 + T_{brake})$$

R_{load0}, R_{load2} = friction and aerodynamic drag coefficients

T_{load}, T_{brake} = load and brake torques

mph = vehicle linear velocity

The model programs the shift points for the transmission according to the schedule shown in the figure below. For a given throttle in a given gear, there is a unique vehicle speed at which an upshift takes place. The simulation operates similarly for a downshift.

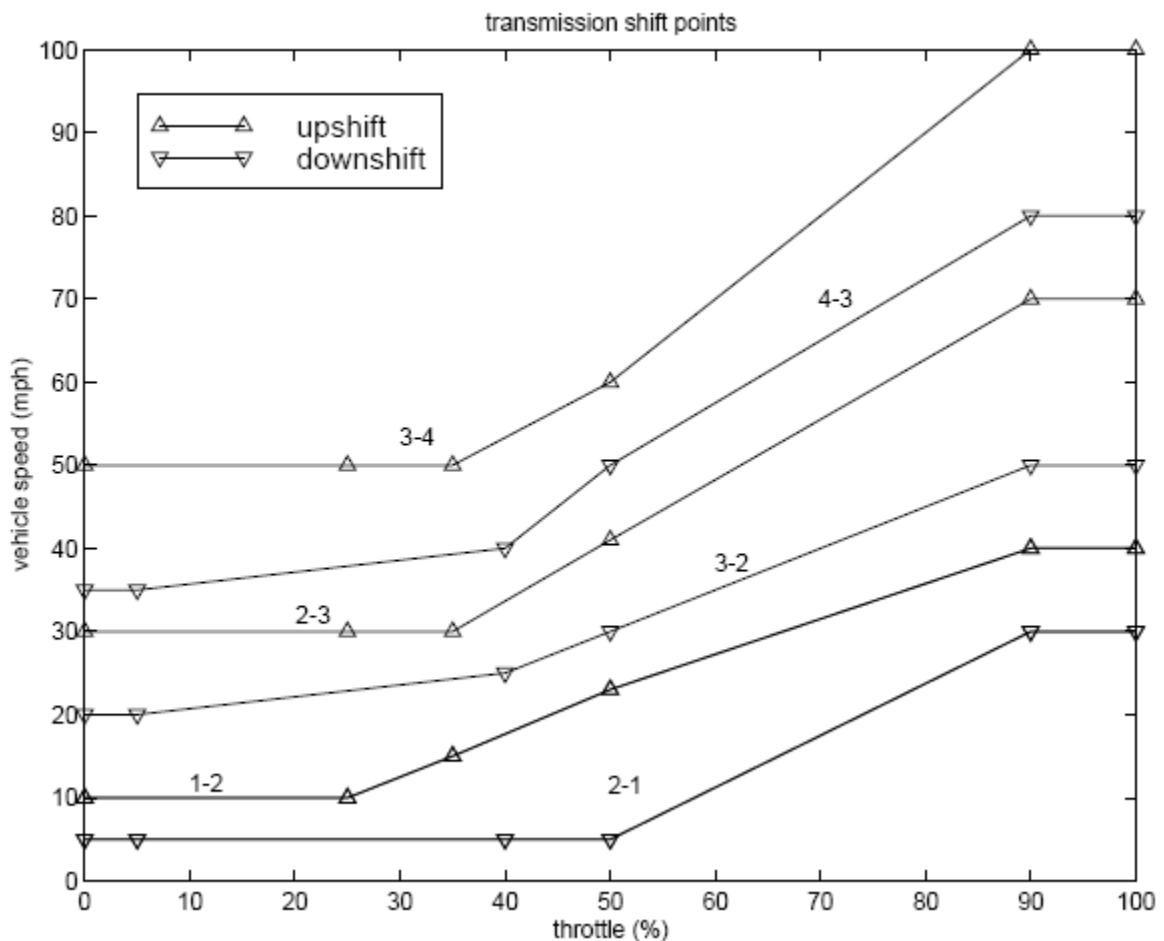

Modeling

When you open the model, the Initial conditions are set in the Model Workspace.

The top-level diagram of the model is shown in the figure below. To run the simulation, on the Simulation tab, click **Run**. Note that the model logs relevant data to MATLAB Workspace in a data structure called `sldemo_autotrans_output`. Logged signals have a blue indicator. After you run the simulation, you can view the components of the data structure by typing `sldemo_autotrans_output` in MATLAB Command Window. Also note that the units appear on the subsystem icons and signal lines.

Modeling an Automatic Transmission Controller

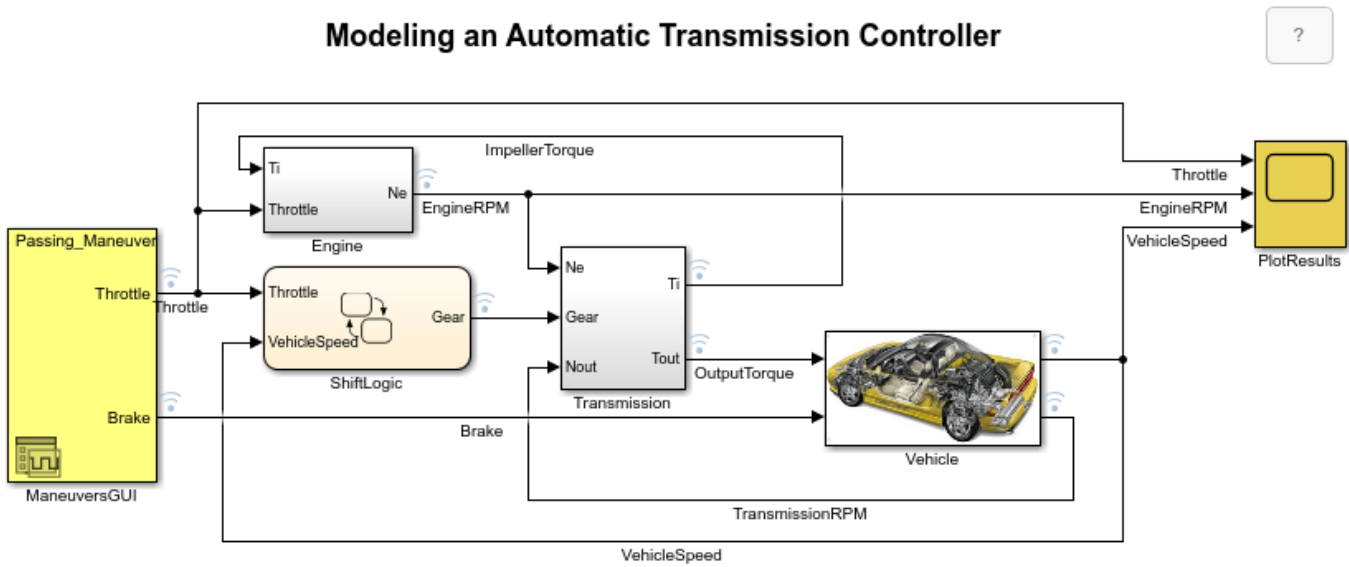

Copyright 1990-2021 The MathWorks, Inc.

Modeling

The Simulink model shown above is composed of modules which represent the engine, transmission, and the vehicle, with an additional shift logic block to control the transmission ratio. User inputs to the model are in the form of throttle (given in percent) and brake torque (given in ft-lb). The user inputs throttle and brake torques using the ManeuversGUI interface.

The Engine subsystem consists of a two-dimensional table that interpolates engine torque versus throttle and engine speed. The figure below shows the composite Engine subsystem. Double click on this subsystem in the model to view its structure.

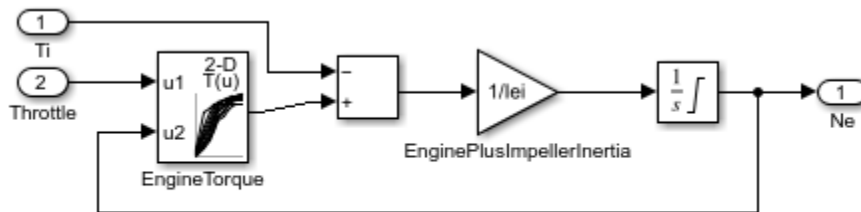

Engine

The TorqueConverter and the TransmissionRatio blocks make up the Transmission subsystem, as shown in the figure below. Double click on the Transmission subsystem in the model window to view its components.

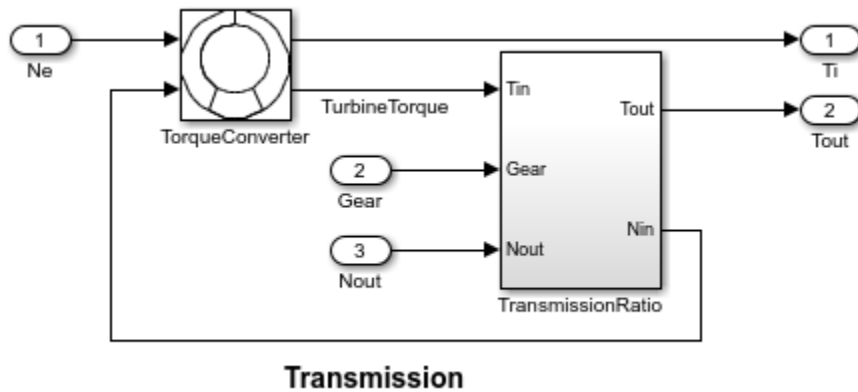

The TorqueConverter is a masked subsystem, which implements Equation 2. To open this subsystem, right click on it and select **Mask > Look Under Mask** from the drop-down menu. The mask requires a vector of speed ratios (N_{in}/N_e) and vectors of K-factor (f2) and torque ratio (f3). This figure shows the implementation of the TorqueConverter subsystem.

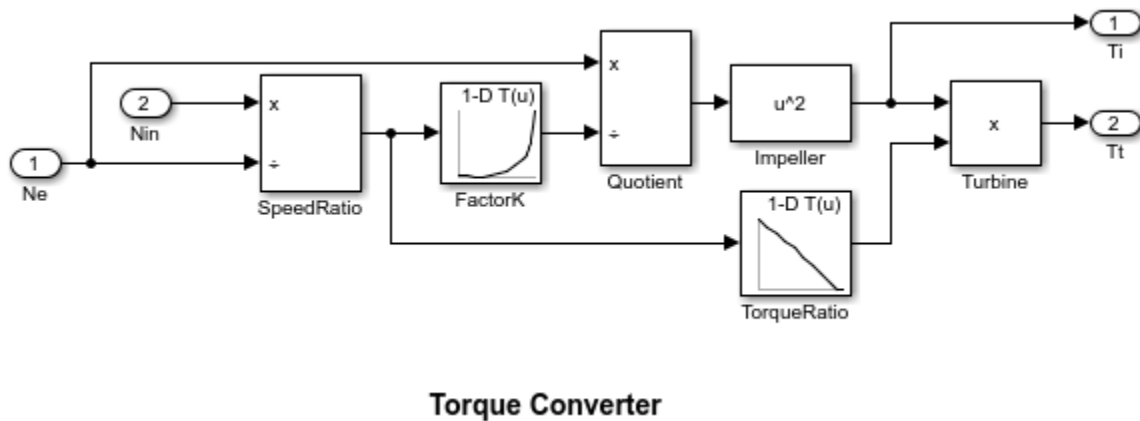

The transmission ratio block determines the ratio shown in Table 1 and computes the transmission output torque and input speed, as indicated in Equation 3. The figure that follows shows the block diagram for the subsystem that realizes this ratio in torque and speed.

Table 1: Transmission gear ratios

| gear | Rtr = N_{in}/N_e |
|------|--------------------|
| 1 | 2.393 |
| 2 | 1.450 |
| 3 | 1.000 |
| 4 | 0.677 |

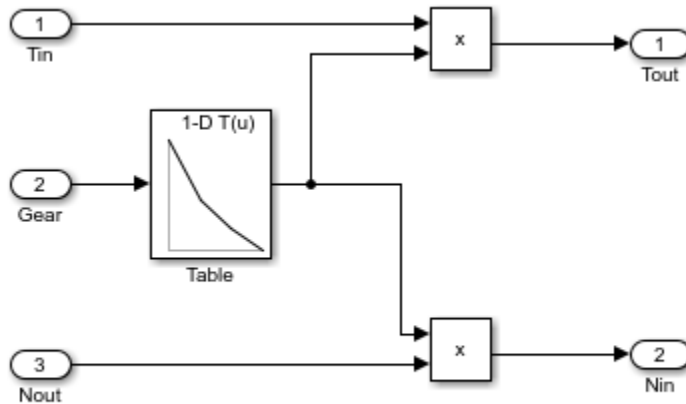

Transmission Gear Ratio

The Stateflow block labeled ShiftLogic implements gear selection for the transmission. Double click on ShiftLogic in the model window to open the Stateflow diagram. The Model Explorer is utilized to define the inputs as throttle and vehicle speed and the output as the desired gear number. Two dashed AND states keep track of the gear state and the state of the gear selection process. The overall chart is executed as a discrete-time system, sampled every 40 milliseconds. The Stateflow diagram shown below illustrates the functionality of the block.

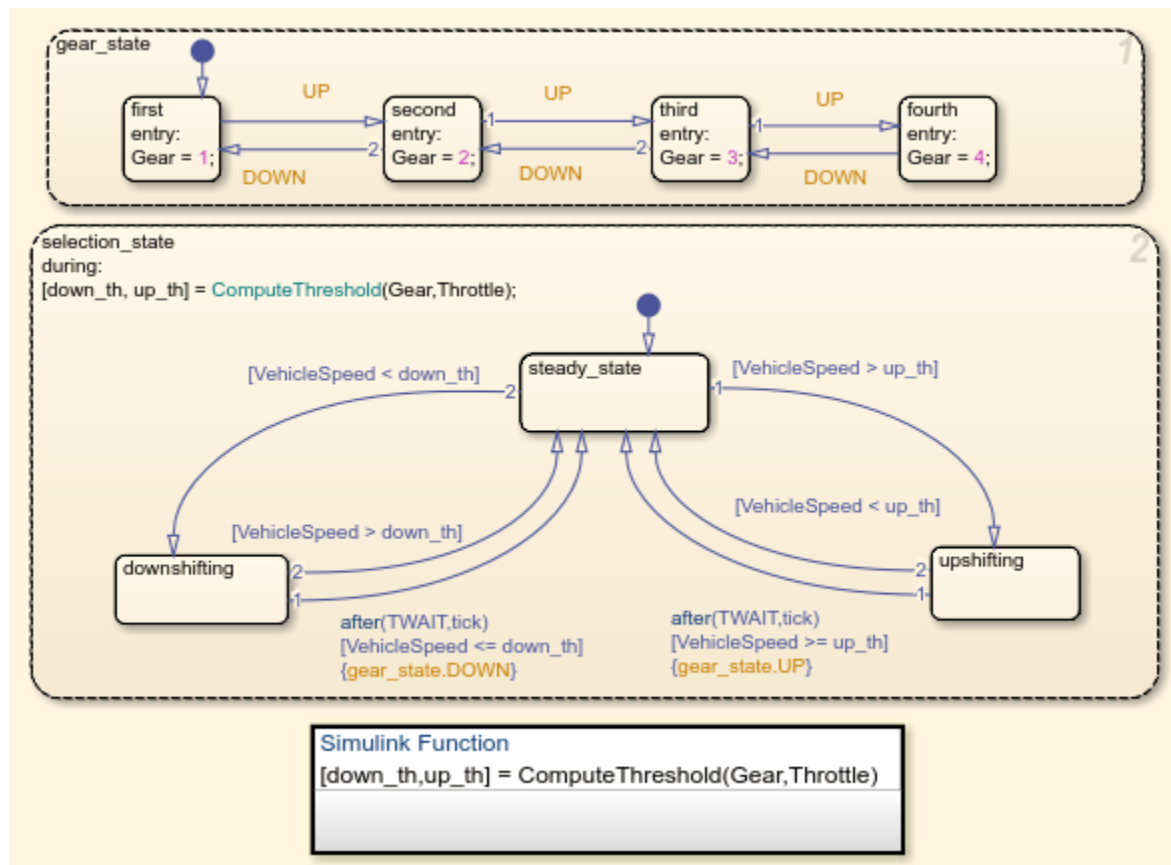

The shift logic behavior can be observed during simulation by enabling animation in the Stateflow debugger. The `selection_state` (always active) begins by performing the computations indicated in its `during` function. The model computes the upshift and downshift speed thresholds as a function of the instantaneous values of gear and throttle. While in `steady_state`, the model compares these values to the present vehicle speed to determine if a shift is required. If so, it enters one of the confirm states (`upshifting` or `downshifting`), which records the time of entry.

If the vehicle speed no longer satisfies the shift condition, while in the confirm state, the model ignores the shift and it transitions back to `steady_state`. This prevents extraneous shifts due to noise conditions. If the shift condition remains valid for a duration of `TWAIT` ticks, the model transitions through the lower junction and, depending on the current gear, it broadcasts one of the shift events. Subsequently, the model again activates `steady_state` after a transition through one of the central junctions. The shift event, which is broadcast to the `gear_selection` state, activates a transition to the appropriate new gear.

For example, if the vehicle is moving along in second gear with 25% throttle, the state `second` is active within `gear_state`, and `steady_state` is active in the `selection_state`. The `during` function of the latter, finds that an upshift should take place when the vehicle exceeds 30 mph. At the moment this becomes true, the model enters the `upshifting` state. While in this state, if the vehicle speed remains above 30 mph for `TWAIT` ticks, the model satisfies the transition condition leading down to the lower right junction. This also satisfies the condition `[gear == 2]` on the transition leading from here to `steady_state`, so the model now takes the overall transition from `upshifting` to `steady_state` and broadcasts the event `UP` as a transition action. Consequently, the transition from second to third is taken in `gear_state` which completes the shift logic.

The Vehicle subsystem uses the net torque to compute the acceleration and integrate it to compute the vehicle speed, per Equation 4 and Equation 5. The Vehicle subsystem is masked. To see the structure of the Vehicle block, right click on it and select **Mask > Look Under Mask** from the drop-down menu. The parameters entered in the mask menu are the final drive ratio, the polynomial coefficients for drag friction and aerodynamic drag, the wheel radius, vehicle inertia, and initial transmission output speed.

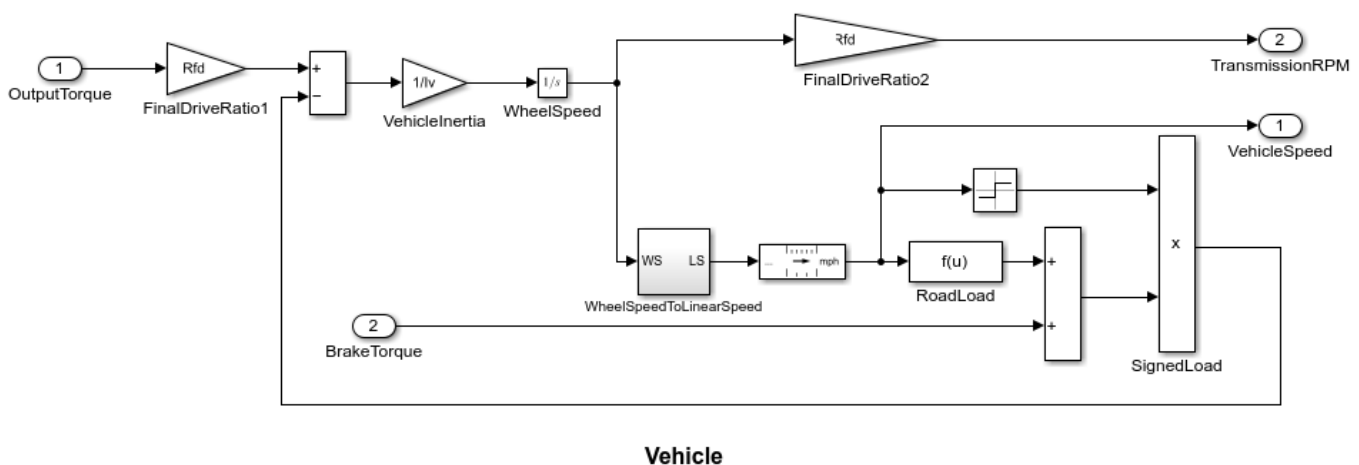

Results

The engine torque map, and torque converter characteristics used in the simulations are shown below.

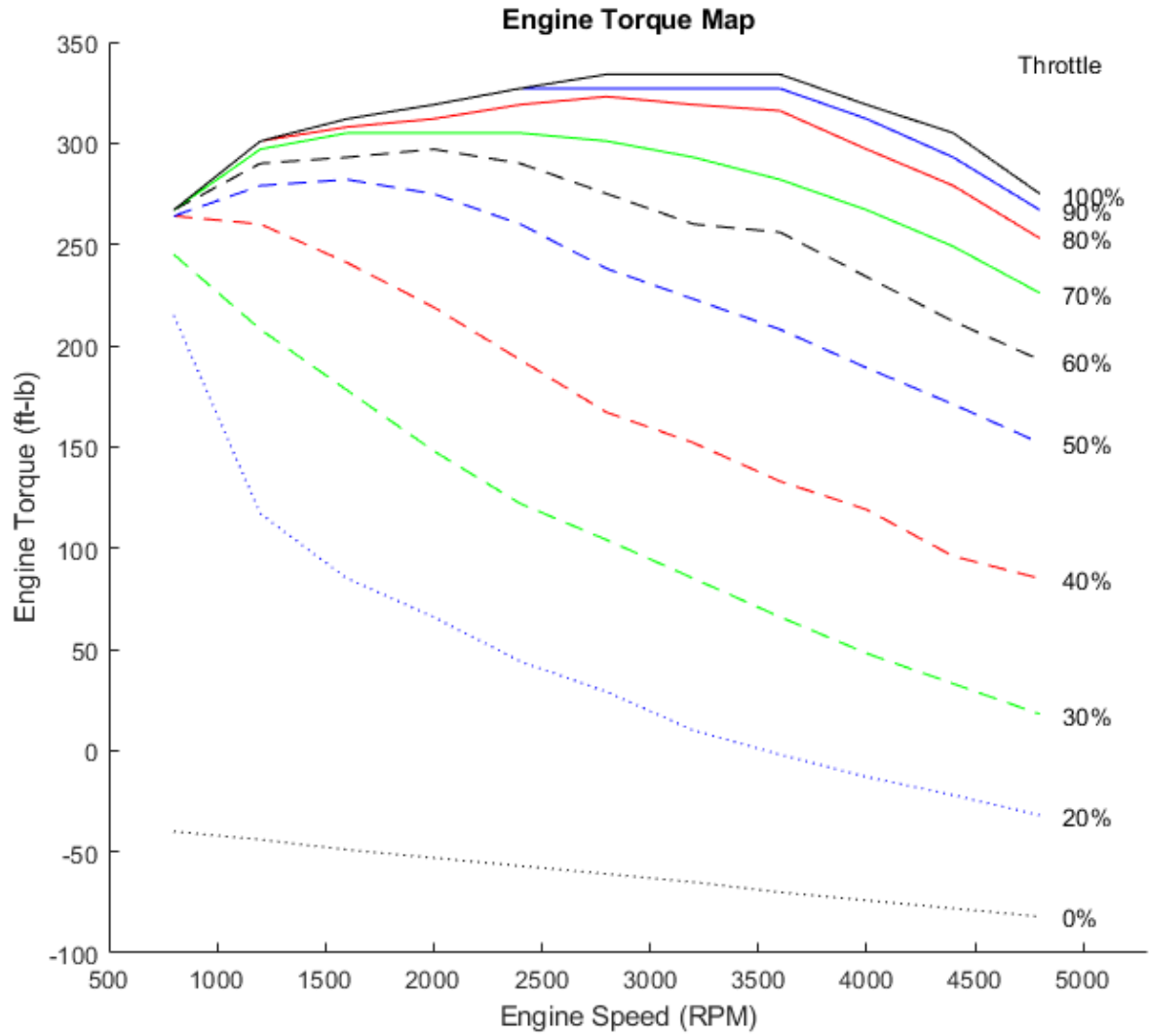

Get the FactorK (second row) and the TorqueRatio (third row) vs SpeedRatio(first row)

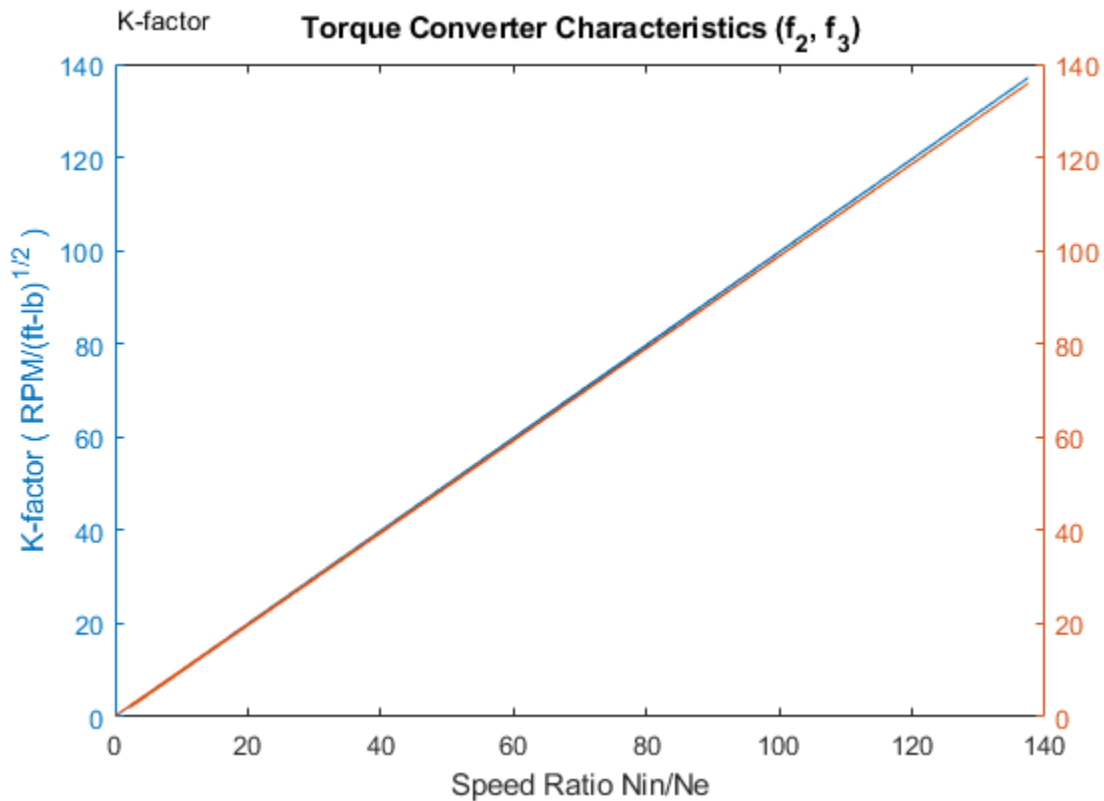

The first simulation (passing maneuver) uses the throttle schedule given in Table 2 (this data is interpolated linearly).

Table 2: Throttle schedule for first simulation (passing maneuver)

| Time (sec) | Throttle (%) |
|------------|--------------|
| 0 | 60 |
| 14.9 | 40 |
| 15 | 100 |
| 100 | 0 |
| 200 | 0 |

The first column corresponds to time; the second column corresponds to throttle opening in percent. In this case no brake is applied (brake torque is zero). The vehicle speed starts at zero and the engine at 1000 RPM. The following figure shows the plot for the baseline results, using the default parameters. As the driver steps to 60% throttle at $t=0$, the engine immediately responds by more than doubling its speed. This brings about a low speed ratio across the torque converter and, hence, a large torque ratio. The vehicle accelerates quickly (no tire slip is modeled) and both the engine and the vehicle gain speed until about $t = 2$ sec, at which time a 1-2 upshift occurs. The engine speed characteristically drops abruptly, then resumes its acceleration. The 2-3 and 3-4 upshifts take place at about four and eight seconds, respectively. Notice that the vehicle speed remains much smoother due to its large inertia.

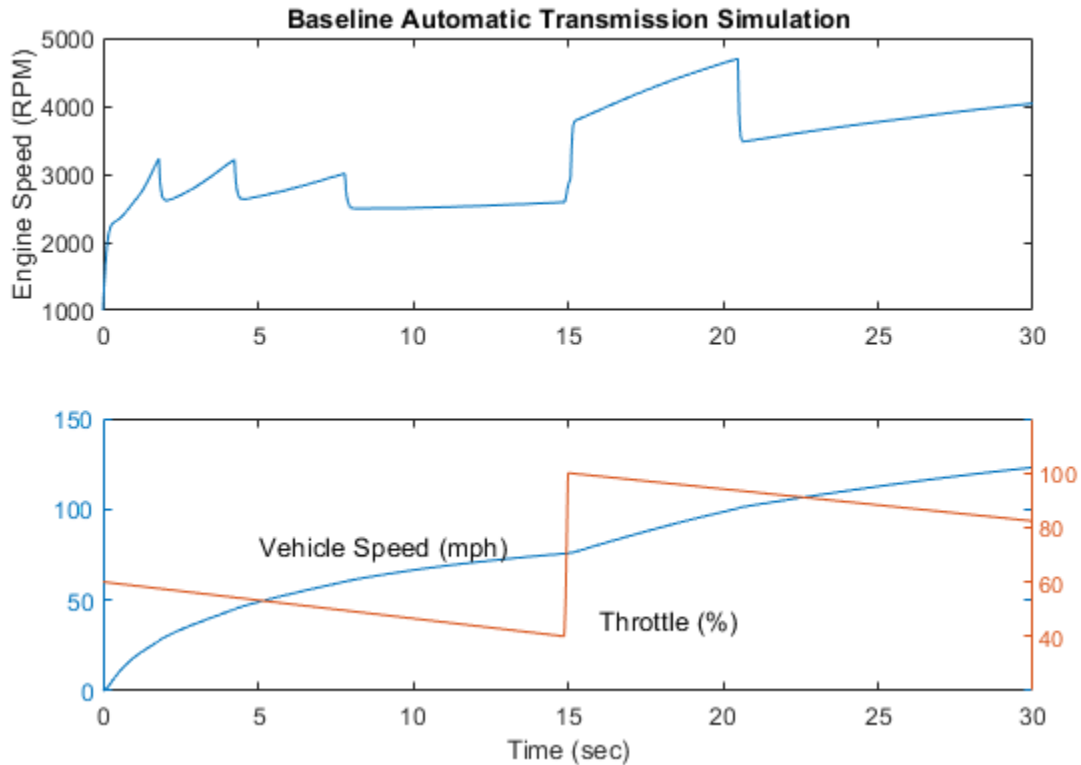

At $t=15\text{sec}$, the driver steps the throttle to 100% as might be typical of a passing maneuver. The transmission downshifts to third gear and the engine jumps from about 2600 RPM to about 3700 RPM. The engine torque thus increases somewhat, as well as the mechanical advantage of the transmission. With continued heavy throttle, the vehicle accelerates to about 100 mph and then shifts into overdrive at about $t = 21 \text{ sec}$. The vehicle cruises along in fourth gear for the remainder of the simulation. Double click on the ManeuversGUI block and use the graphical interface to vary the throttle and brake history.

Closing the Model

Close the model, clear generated data.

Conclusions

You can enhance this basic system in a modular manner, for example, by replacing the engine or transmission with a more complex model. You can build large systems within this structure via step-wise refinement. The seamless integration of Stateflow control logic with Simulink signal processing enables the construction of a model that is efficient and visually intuitive.

See Also

Signal Editor

More About

- "Create and Edit Signal Data"

- “Unit Specification in Simulink Models”
- “Powertrain Blockset”

Vehicle Electrical System

This example shows how to simulate the electrical system of a vehicle using Simulink® and Simscape Electrical™.

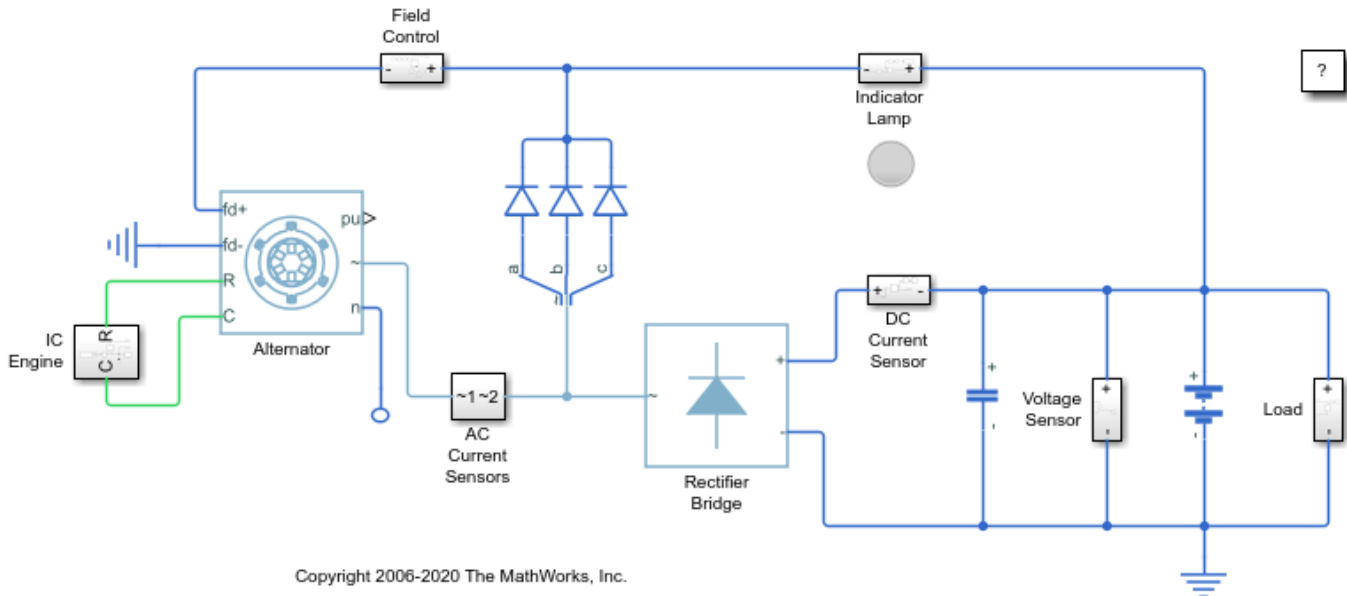

System Components

The system simulated consists of a few components. The main power source is the internal combustion (IC) engine that drives the shaft of the alternator. The alternator produces the AC power. The diode trio rectifies the AC current generated from the alternator to DC current that is applied to the alternator field. The indicator lamp lights when the system is turned on and the alternator is not producing power. The rectifier bridge converts the AC power into DC power. The smoothing capacitor, voltage sensor, battery, and vehicle loads are connected to the DC bus.

The alternator is a three-phase synchronous machine with its field current regulated to give control over the DC bus voltage. This is simulated by using the Synchronous Machine Round Rotor block.

The three-phase AC output of the alternator is fed into the 6-pulse rectifier bridge to give the DC voltage required to charge the car battery and to supply the balance of the electrical system of the car.

Operation of the System

When the IC engine is off, the battery supplies the current to the alternator field winding. The indicator lamp is turned on.

When the IC engine runs, the alternator will start to produce voltage and the diode trio will conduct and let the current flow to the alternator field winding. The indicator lamp is then turned off.

When the DC bus voltage reaches the upper voltage limit (which is 14.5 V in the model), the current flowing to the alternator field is bypassed. As a result, the DC bus voltage decreases. If it reaches the lower voltage limit (which is 13.5 V in the model), the diode trio is reconnected to the field winding.

See Also

More About

- “Electrical Models” (Simscape)
- “Vehicle Electrical and Climate Control Systems” on page 13-190

Simulating Automatic Climate Control Systems

This example shows how to simulate an automatic climate control system in a car using Simulink® and Stateflow®.

- In the User Setpoint in Celsius block, enter a value for the desired air temperature in the car.
- In the External Temperature in Celsius block, enter a value for the external air temperature.
- The Thermometer Display block indicates the reading of a temperature sensor placed behind the driver's head. This is the temperature that the driver feels.

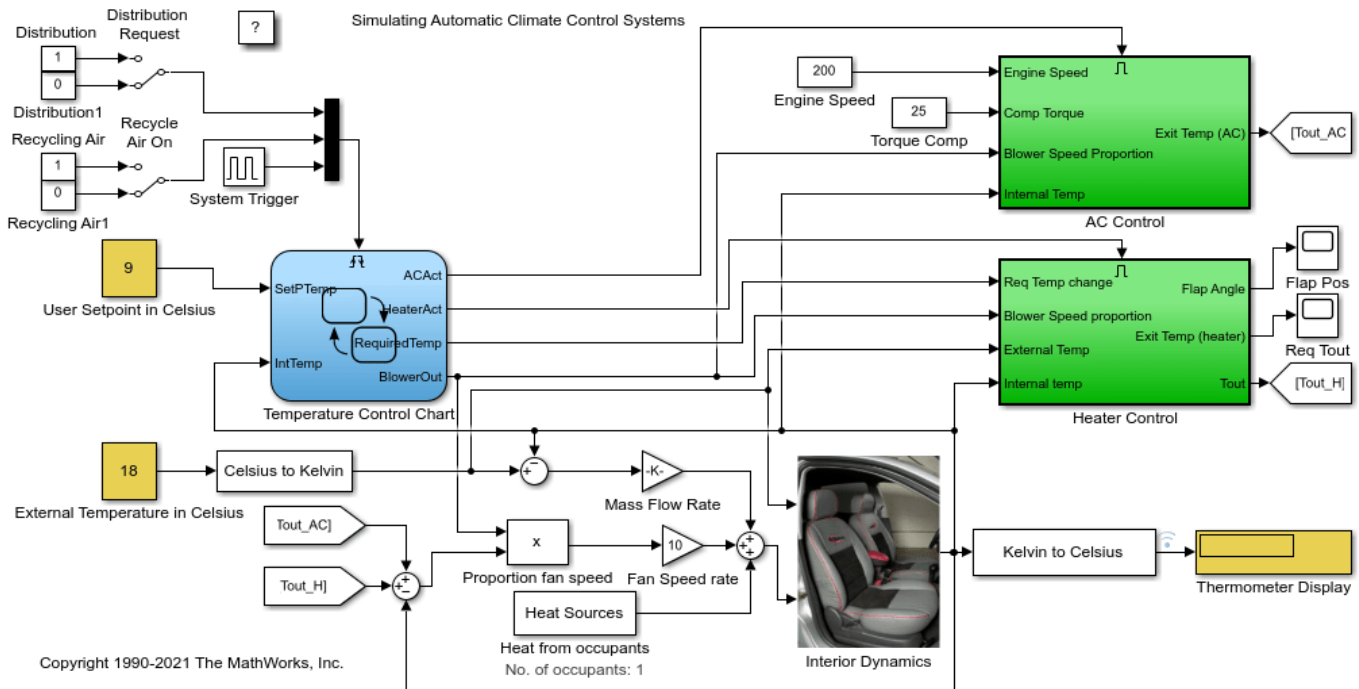

Figure 1: The automatic climate control system

Stateflow® Controller

Stateflow implements the supervisory controller. To see the control logic, open the chart.

The **Heater_AC** state shows that entering a setpoint temperature that is greater than the current car temperature by at least 0.5 deg C switches the heater system on. The heater remains active until the current temperature in the car is within 0.5 deg of the setpoint temperature. Similarly, when you enter a setpoint that is 0.5 deg C or less than the current car temperature, the air conditioner turns on. It stays active until the air temperature in the car is within 0.5 deg C of the setpoint temperature. To avoid continuously switching on and off the heater, the logic implements a dead band of 0.5 deg

In the **Blower** state, the greater the difference between the setpoint temperature and the current temperature, the harder the fan blows. This ensures that the temperature reaches the required value in a reasonable amount of time, despite the temperature difference. When the air temperature in the car is within 0.5 deg C of the setpoint temperature, the system switches off.

Two switches trigger the Stateflow charts that control the Air Distribution(**AirDist**) and Recycling Air (**Recyc_Air**) states. To facilitate effective window defrosting, the controller implements an

internal transition within these two states. When the defrost state is active, the controller turns off the recycling air.

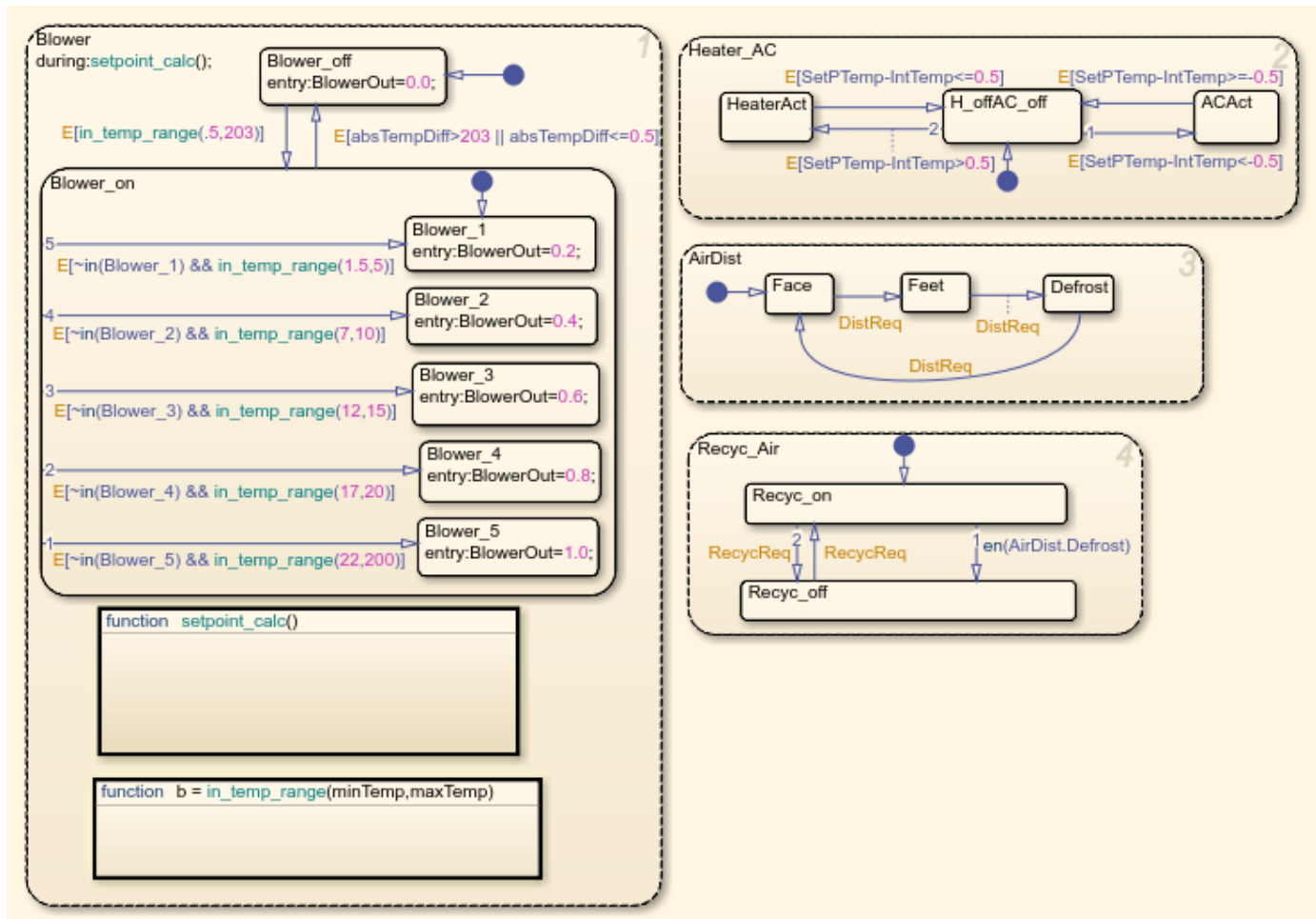

Figure 2: The supervisory control logic in Stateflow

Heater and Air Conditioner Models

The heater model implements this heat exchange equation:

$$T_{out} = T_s - (T_s - T_{in})e^{[-\pi \cdot D \cdot L \cdot h_c] / (m_{dot} \cdot C_p)}$$

Where:

- T_s = constant (radiator wall temperature)
- $D = 0.004\text{m}$ (channel diameter)
- $L = 0.05\text{m}$ (radiator thickness)
- $N = 30000$ (Number of channels)
- $k = 0.026 \text{ W/mK}$ = constant (thermal conductivity of air)
- $C_p = 1007 \text{ J/kgK}$ = constant (specific heat of air)
- Laminar flow ($h_c = 3.66(k/D) = 23.8 \text{ W/m}^2\text{K}$)

The models account for the heater flap. Similar to the blower operation, the greater the temperature difference between the required setpoint temperature and the current interior temperature, the greater the heating effect.

The air conditioner model implements this equation:

$$y \cdot (w \cdot T_{comp}) = \dot{m} \cdot (h_4 - h_1)$$

Where:

- y = efficiency
- \dot{m} = mass flow rate
- w = speed of the engine
- T_{comp} = compressor torque
- h_4, h_1 = enthalpy

The bang-bang control of the A/C system uses the engine speed and compressor torque to determine the temperature of the air that exits the A/C.

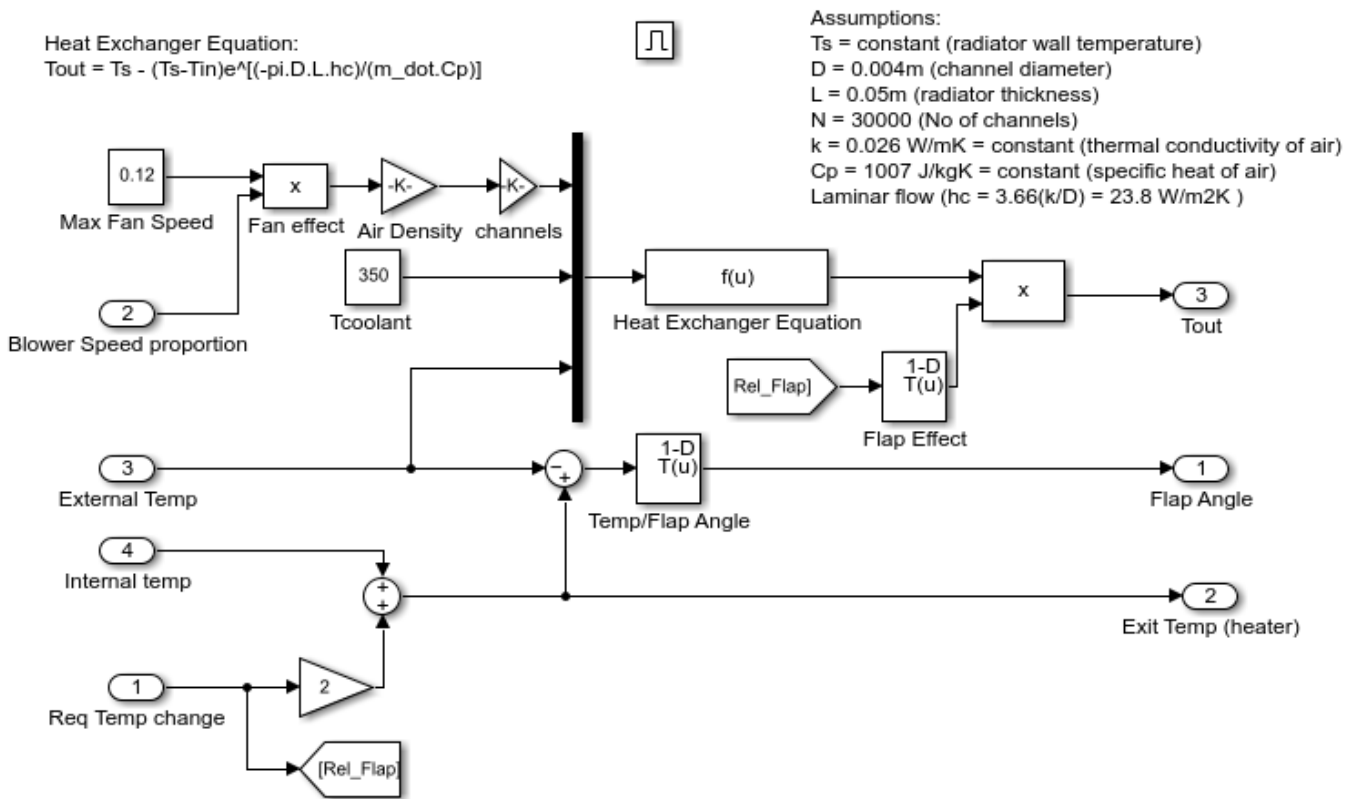

Figure 3: Heater control subsystem

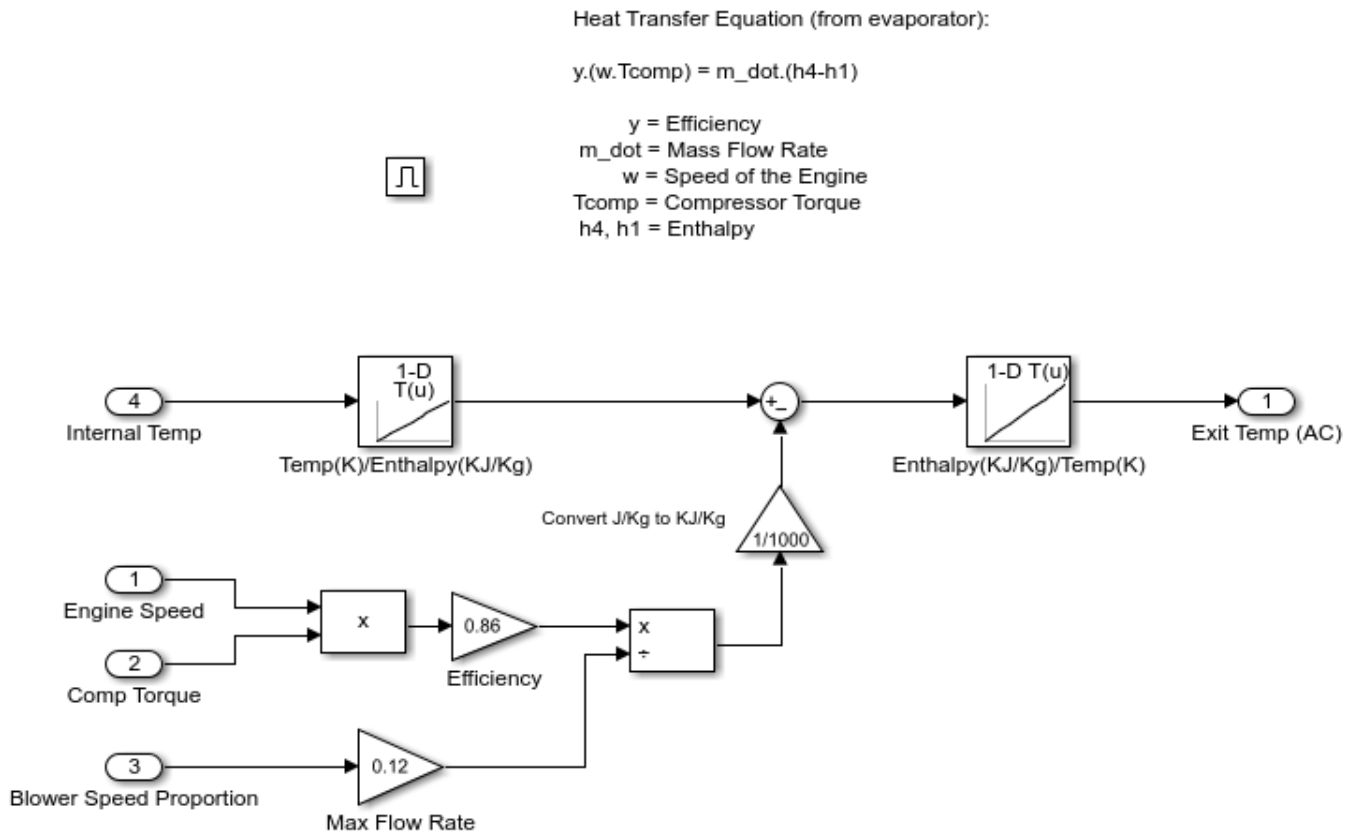

Figure 4: A/C control subsystem

Cabin Heat Transfer

These factors affect the temperature of the air felt by the driver:

- Temperature of the air exiting the vents
- Temperature of the outside air
- Number of people in the car

The factors are inputs into the thermodynamic model of the cabin interior. To account for the temperature of the air exiting the vents, the model calculates the difference between the vent air and the current car temperature and multiplies it by the fan speed proportion (mass flow rate). The model adds 100 W of energy is per person in the car. To account for air radiating into the car from the outside, the model multiplies the difference between the outside and interior air temperature by a smaller mass flow rate.

The Thermometer Display block displays the Interior Dynamics model output. It is a reading of a temperature sensor placed behind the driver's head. If you run the simulation with the default settings, the temperature reading starts at the external temperature of 18 °C and then cools to the user setpoint of 9 °C.

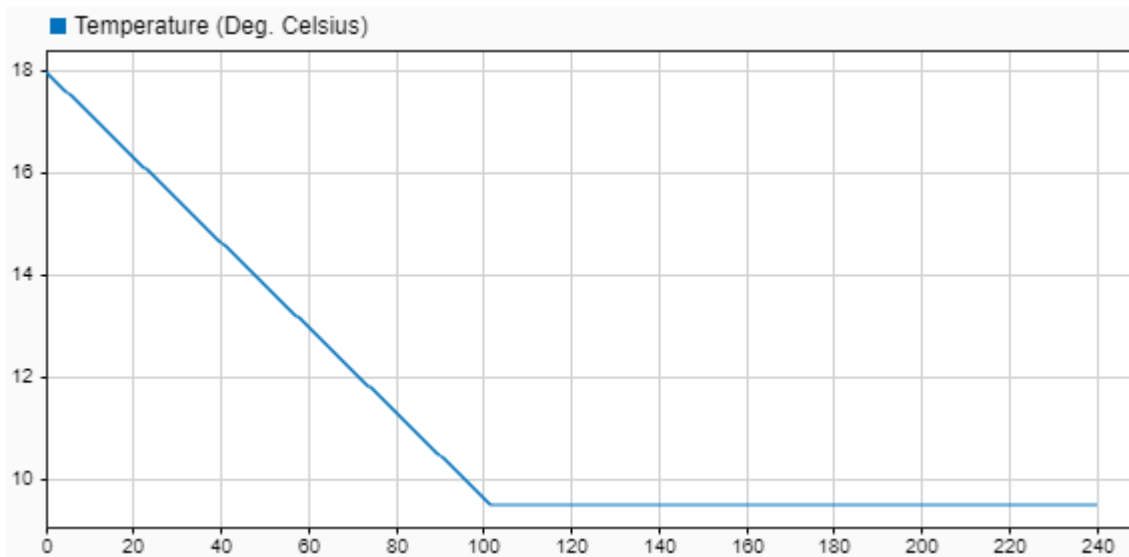

Figure 5: Thermometer display versus time

See Also

More About

- “Create Subsystems”
- “Powertrain Blockset”

Vehicle Electrical and Climate Control Systems

This example shows how to interface the vehicle climate control system with a model of the electrical system to examine the loading effects of the climate control system on the entire electrical system of the car.

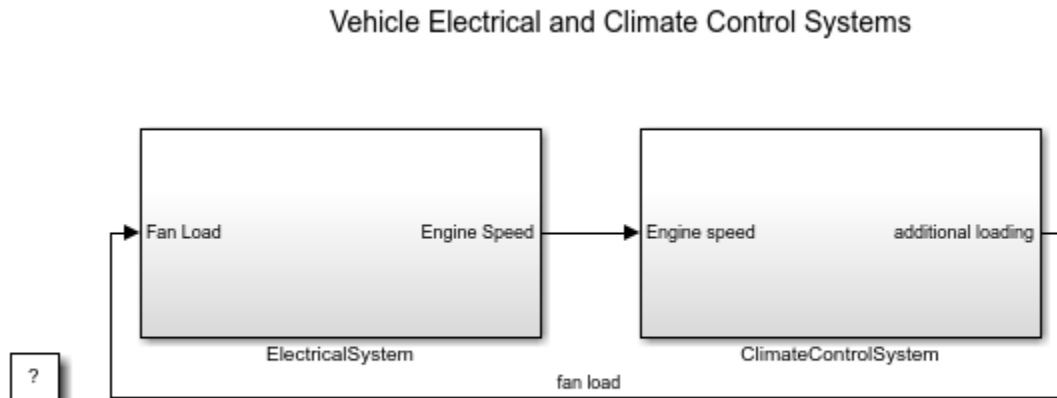

Copyright 2017-2019 The MathWorks, Inc.

Figure 1: Vehicle Electrical and Climate Control System

The Climate Control System

Double clicking on the ClimateControlSystem subsystem will open the model of the climate control system. Here the user can enter the temperature value they would like the air in the car to reach by double clicking on the USER SETPOINT IN CELSIUS Block and entering the value into the dialog box. The EXTERNAL TEMPERATURE IN CELSIUS can also be set by the user in a similar way. The numerical display on the right hand side of the model shows the reading of a temperature sensor placed behind the driver's head. This is the temperature that the driver should be feeling. When the model is run and the climate control is active, it is this display box whose value changes showing the change of temperature in the car.

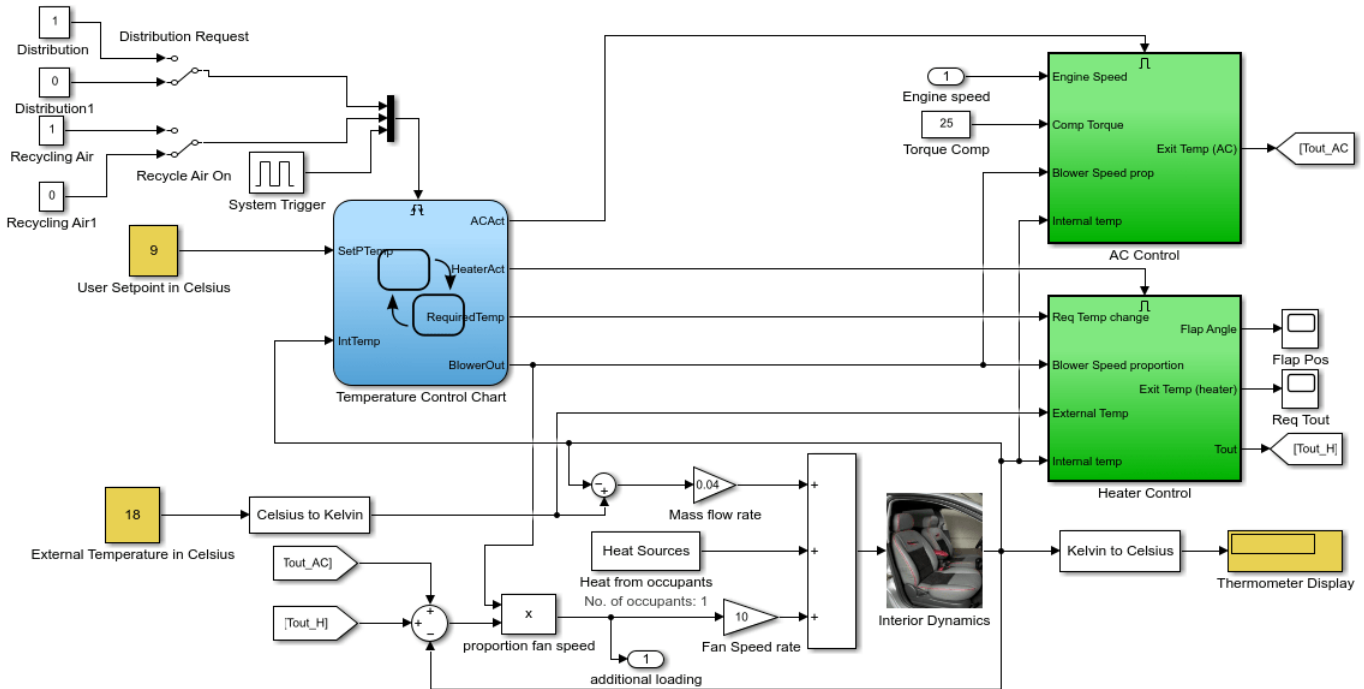

Figure 2: The automatic climate control system.

The Stateflow® Controller

The control of the system is implemented in Stateflow®. Double clicking on the Stateflow chart will show how this supervisory control logic has been formulated.

The **Heater_AC** state shows that when the user enters a setpoint temperature which is greater than the current temperature in the car by at least 0.5 deg C, the heater system will be switched on. The heater will remain active until the current temperature in the car reaches to within 0.5 deg of the setpoint temperature. Similarly, when the user enters a setpoint which is 0.5 deg C (or more) lower than the current car temperature, the Air Conditioner is turned on and stays active until the temperature of the air in the car reaches to within 0.5 deg C of the setpoint temperature. After which, the system will switch off. The dead band of 0.5 deg has been implemented to avoid the problem of continuous switching.

In the **Blower** State, the larger the difference between the setpoint temperature and the current temperature, the harder the fan blows. This ensures that the temperature will reach the required value in a reasonable amount of time, despite the temperature difference. Once again, when the temperature of the air in the car reaches to within 0.5 deg C of the setpoint temperature, the system will switch off.

The Air Distribution (**AirDist**) and Recycling Air States (**Recyc_Air**) are controlled by the two switches that trigger the Stateflow chart. An internal transition has been implemented within these two states to facilitate effective defrosting of the windows when required. When the defrost state is activated, the recycling air is turned off.

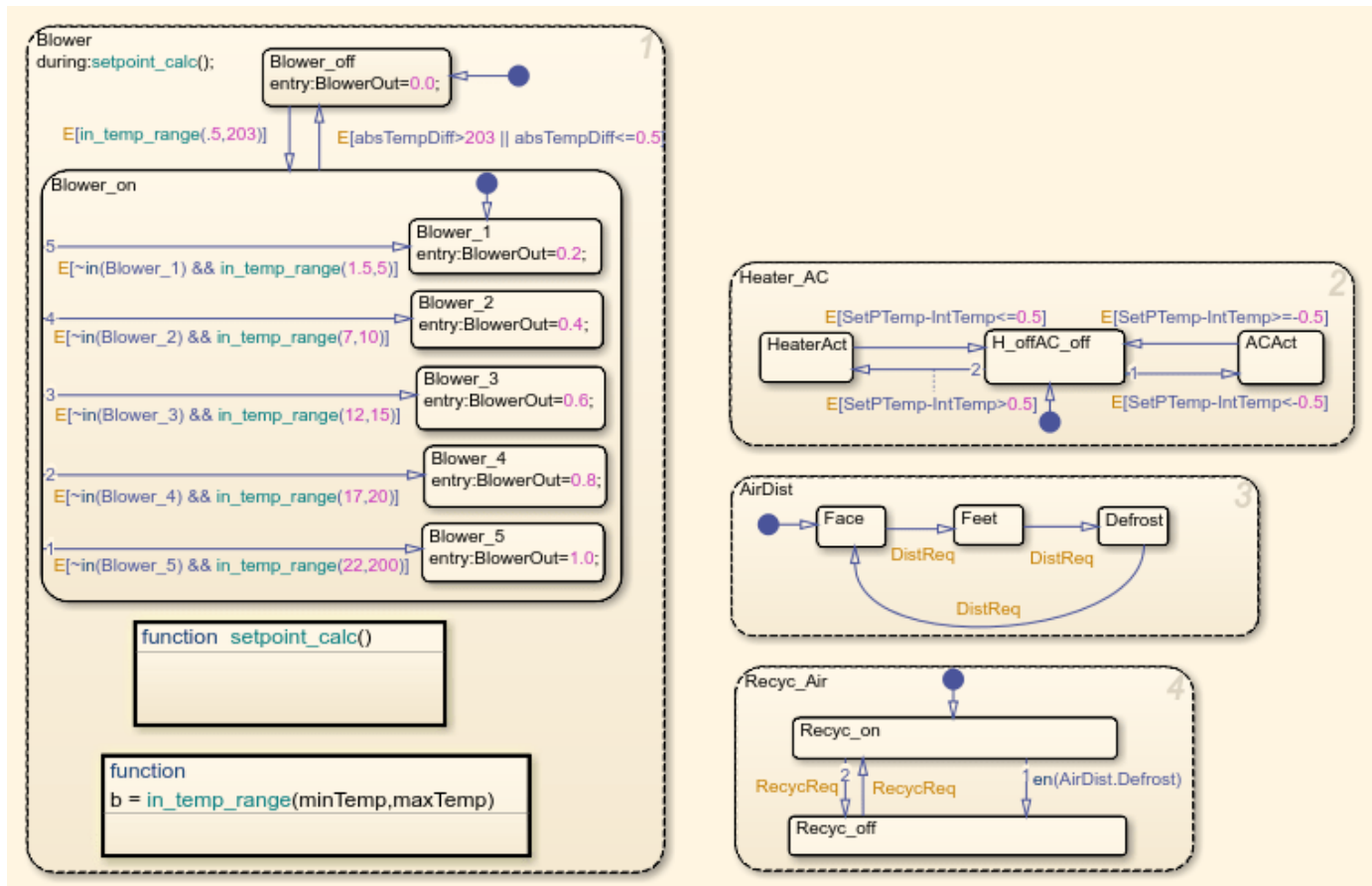

Figure 3: The supervisory control logic in Stateflow.

Heater and Air Conditioner Models

The heater model was built from the equation for a heat exchanger shown below:

$$T_{out} = T_s - (T_s - T_{in})e^{[-\pi \cdot D \cdot L \cdot hc] / (m_{dot} \cdot C_p)}$$

Where:

- T_s = constant (radiator wall temperature)
- D = 0.004m (channel diameter)
- L = 0.05m (radiator thickness)
- N = 30000 (Number of channels)
- k = 0.026 W/mK = constant (thermal conductivity of air)
- C_p = 1007 J/kgK = constant (specific heat of air)
- Laminar flow ($hc = 3.66(k/D) = 23.8 \text{ W/m}^2\text{K}$)

In addition, the effect of the heater flap is taken into account. Similar to the operation of the blower, the greater the temperature difference between the required setpoint temperature and the current temperature in the car, the more the heater flap is opened and the greater the heating effect.

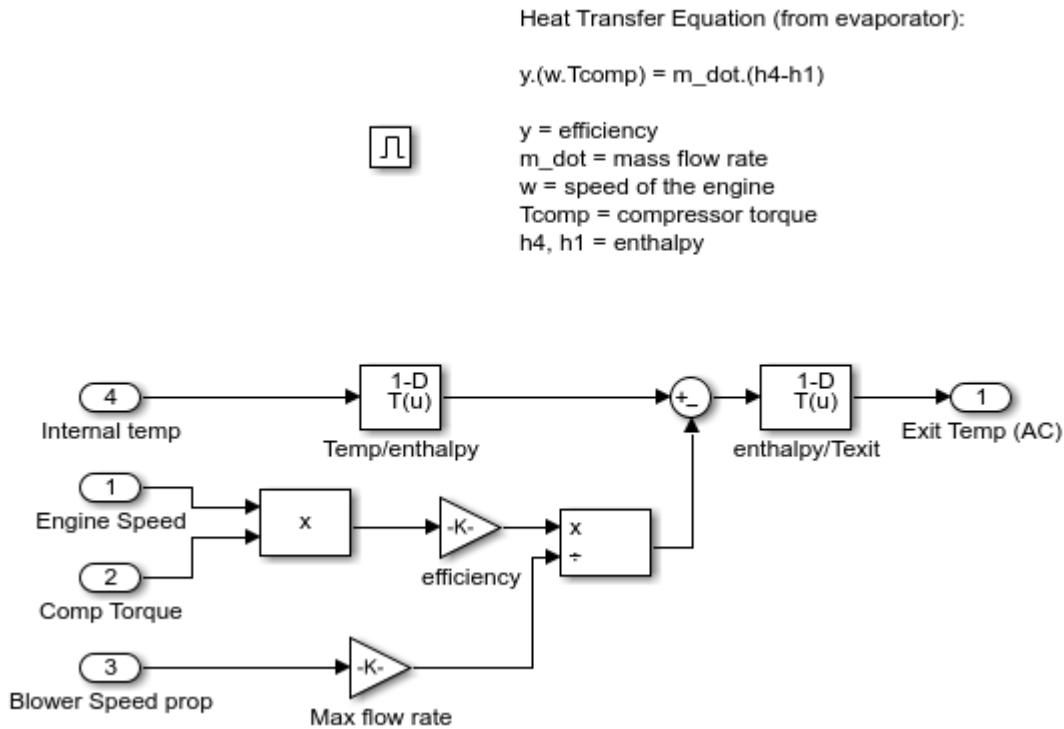

Figure 5: A/C control subsystem.

Heat Transfer in the Cabin

The temperature of the air felt by the driver is affected by all of these factors:

- The temperature of the air exiting the vents
- The temperature of the outside air
- The number of people in the car

These factors are inputs into the thermodynamic model of the interior of the cabin. We take into account the temperature of the air exiting the vents by calculating the difference between the vent air temperature and the current temperature inside the car and multiplying it by the fan speed proportion (mass flow rate). Then 100W of energy is added per person in the car. Lastly, the difference between the temperature of the outside air and the interior air temperature is multiplied by a lesser mass flow rate to account for the air radiating into the car from the outside.

The output of the interior dynamics model is fed to the display block as a measure of the temperature read by a sensor placed behind the driver's head.

The Electrical System

This electrical system models the car at idle speed. The PID controllers ensure that the car's alternator (modeled by a synchronous machine which has its field current regulated to control the output voltage) is also operating at the required speed. The alternator output is then fed through a 3-phase 6-pulse rectifier bridge to supply the voltage needed to charge the battery which supplies the voltage for the car's DC bus.

The fan used in the climate control system is fed off this DC bus as are the windscreen wipers, radio etc. As the difference between the setpoint temperature and the current temperature in the car drops, so does the fan speed and therefore so does the loading on the DC bus. The inclusion of feedback in the electrical system regulates the DC bus voltage.

The additional model of the car's electrical system allows for the changing of the engine speed. Changing the engine speed shows the effect on the DC bus voltage.

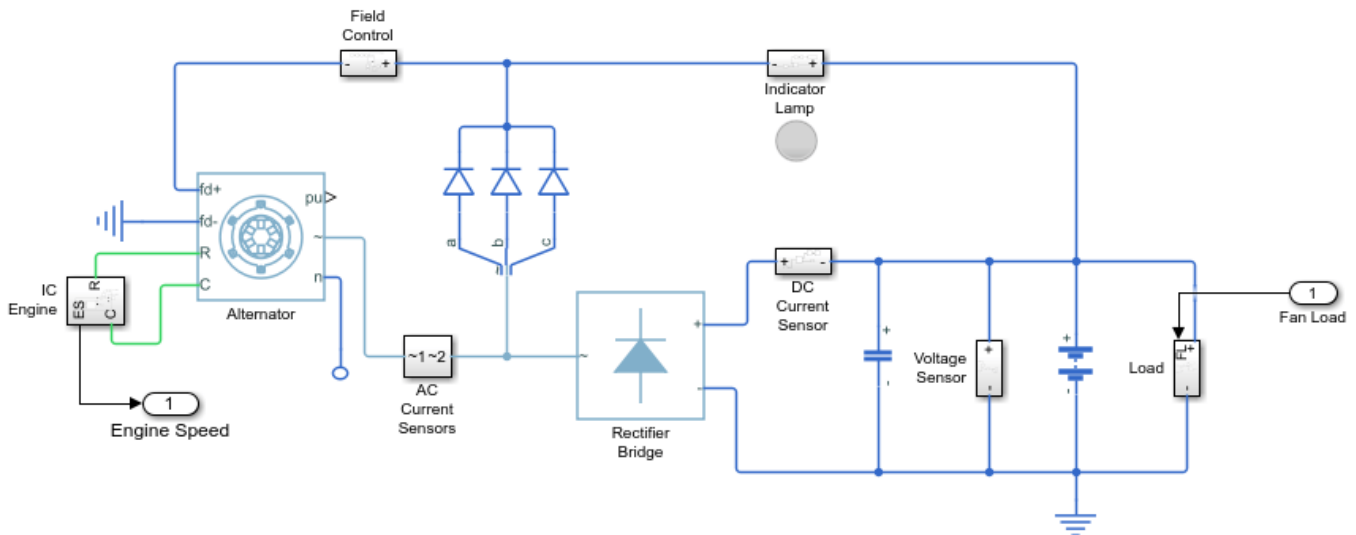

Figure 6: The electrical system

See Also

More About

- "Vehicle Electrical System" on page 13-183
- "Powertrain Blockset"
- "Vehicle Dynamics Blockset"

Power Window Control Project

This example shows how you can use MathWorks® software and the Model-Based Development process to go from concept to implementation for a power window system for an automobile. This example uses Simulink®, Simulink® Coverage™, DSP System Toolbox™, Simscape™ Multibody™, Fixed-Point Designer™, Simscape™ Electrical™, Simscape™, and Simulink® Real-Time™.

Overview of Design Requirements

In this example, consider the passenger-side power window system of an automobile. Note a critical aspect of this system is that it can never exert a force of more than 100 N on an object when closing the window, for example:

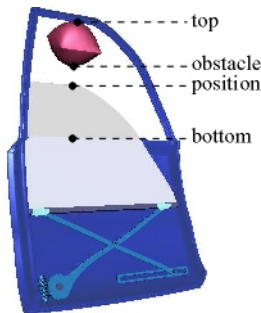

When the model detects such an object, it must lower the window by about 10 centimeters.

For more information on the design requirements, see “Power Window”.

Using Model-Based Development and Large Scale Modeling

This example uses Model-Based Design and large scale modeling techniques such as,

- **Model Blocks** to separate the hierarchy into separate models.
- **Variant Subsystems Blocks** to model and switch between different design choices.
- **Libraries** to capture algorithms for reuse in variant subsystems.
- **Projects** to manage the files required for the system development.

Opening Power Window Control Project

Run the following command to create and open a working copy of the project files for this example.

```
slxPowerWindowStart
```

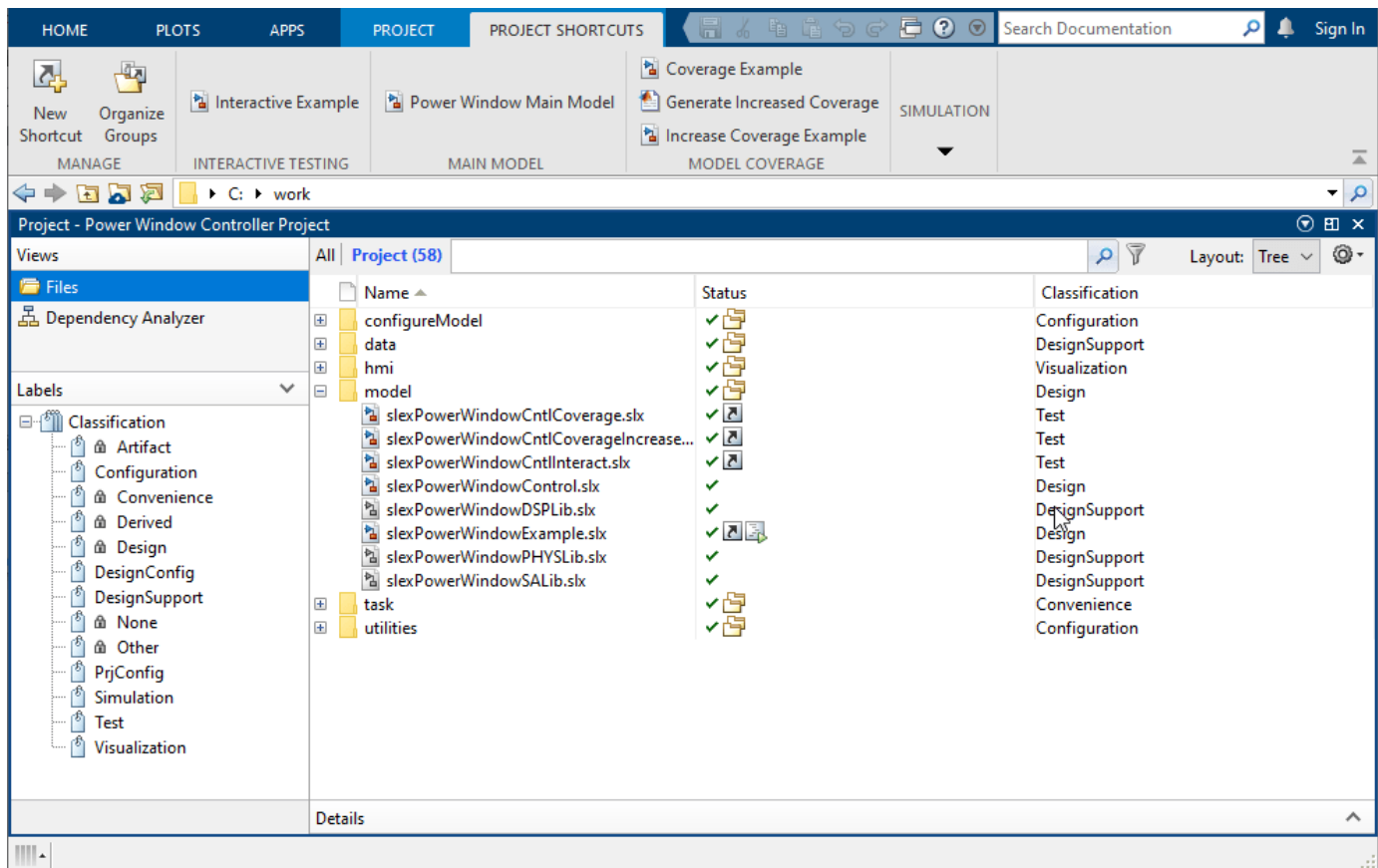

Exploring the Project

Upon visual inspection of the project, you can see features used to organize the example. These features are:

- Folders
- File Classification
- Shortcuts

Folders

The project is organized into the following folders:

- **configureModel** - MATLAB® files controlling the main system model variant configuration
- **data** - Images required by the project
- **hmi** - Files that animate the power window response
- **model** - Main system model, controller model, models for testing the controller, and libraries which support these models
- **task** - MATLAB files that simulate the model for the different model configurations and generate coverage reports for the controller
- **utilities** - MATLAB files to initialize the model, to generate spreadsheet input, to add data to the generated spreadsheet and to manage the project environment at startup and shutdown

File Classification

Files in Projects have different classifications visible in Labels pane. Each label describes the specific role a file contributes to the body of the project. In this project, new classifications were added, including:

- **Configuration** - Files that configure the project or model.
- **PrjConfig** - Files that configure the project by adding its files to the path at startup and removing them at shutdown
- **DesignConfig** - Files that determine which model configuration is active at a given time
- **Design** - Main system model and its referenced control model
- **DesignSupport** - Files such as libraries, data, and model simulation
- **Simulation** - Files that simulate the model for a specific configuration
- **Test** - Control coverage, the control interaction, and the test harness models
- **Visualization** - Files that animate the motion of the power window

Shortcuts

Project shortcuts are used to obtain quick access to project files that are used most often. Some shortcuts contain general tasks such as adding the project to the path at startup and removing it at shutdown. In addition, project shortcut groups help organize the shortcuts. The new shortcut groups are

- **Interactive Testing** - Files used for interactive testing of the controller
- **Main Model** - File for top level Simulink model
- **Model Coverage** - Files used for model coverage of the controller
- **Simulation** - Files used for simulation of model variant configurations

Exploring Simulink Models in Project

The Simulink models for this project are located in the model folder. The models of interest are:

- Main System Model
- Models for Testing

Main System Model

In this example under the model folder, the main system model is `slexPowerWindowExample`. This model consists of the driver and passenger switch blocks, which generate the inputs to the system. The inputs then go through the control system model, which validates the states of the passenger and driver inputs. The control system block also determines if there is an obstacle blocking the window's path. The referenced controller produces the window motion command signals sent to the active variant of the window system. The window system output is the feedback to the control system block.

To visualize the results of simulation, Simulation Data Inspector (SDI) logs the output data and Simulink 3D Animation™ animates the window's motion.

Model Variants

The main system model in this project uses the `Variant Subsystem` block to allow for multiple implementations of within a subsystem. The active implementation can be programmatically changed

prior to simulation. In the main model, there are four Variant Subsystem blocks each with variant choices that can be programmatically modified. Those four variant subsystems are:

- `slexPowerWindowExample/driver_switch`
- `slexPowerWindowExample/passenger_switch`
- `slexPowerWindowExample/window_system`
- `slexPowerWindowExample/power_window_control_system/detect_obstacle_endstop`

Each variant choice is associated with a variant control. The variant choice is active when its variant control evaluates to `true`.

Since there are four programmatically modifiable Variant Subsystem blocks in the main model, there are MATLAB files to control the combinations of variant choices to create model variant configurations which are found under the `DesignConfig` classification. Available model variant configurations are

- Power Window Controller Hybrid System Model
- Power Window Controller and Detailed Plant Model
- Power Window Controller With Data Acquisition Effects
- Power Window Controller With Controller Area Network (CAN) Communication

Power Window Controller Hybrid System Model

This model variant uses Stateflow® and Simulink to model both discrete event reactive behavior and continuous time behavior. It uses a low order plant model to validate the roll-up and roll-down behavior. You can simulate this variant configuration using the `SimHybridPlantLowOrder` shortcut. This shortcut activates only the variant subsystem corresponding to this model configuration. Since this model does not take into account power effects, the only output logged is position. Simulation Data Inspector (SDI) displays the logged position data.

Power Window Controller and Detailed Plant Model

This model variant shows a more detailed plant model that includes power effects in the electrical and mechanical domains is used to validate that the force exerted by the window on a trapped object never exceeds 100 N. This model variant requires Simscape™ Multibody™ and Simscape Power Systems™ products to be installed. You can simulate this variant configuration using the `SimHybridPlantPowerEffects` shortcut. Unlike the previous variant model, this variant configuration takes into account the power effects. SDI displays the logged data from armature current, position, and force exerted by the power window.

Power Window Controller With Data Acquisition Effects

This model variant shows additional effects due to implementation that affect the control. The phenomena included are signal conditioning to measure the armature current and quantization of the measurement. This model variant requires Simscape Multibody, Simscape Power Systems, DSP System Toolbox™, and Fixed-Point Designer™ products to be installed. You can simulate this variant configuration using the `SimHybridPlantPowerEffects+ControlDAQEffects` shortcut. Like the previous model, SDI displays the logged data from armature current, position, and force exerted by the power window.

Power Window Controller With CAN Communication

This model variant shows the use of a CAN to communicate the commands to control window movement. The switches that may be located in the center console of the vehicle and that produce the commands are included in this model variant. This model variant requires Simscape Multibody, Simscape Power Systems, DSP System Toolbox, and Fixed-Point Designer products to be installed. You can simulate this variant configuration on a machine running windows OS using the| SimCANCommunication| shortcut.

Models for Testing

To test the state machine that controls the power window, you can run the project shortcuts for testing. Available model shortcuts for testing the controller are

- InteractiveExample
- CoverageExample
- IncreaseCoverageExample

InteractiveExample

This model shortcut opens the model, slxPowerWindowCntlInteract. This model contains the power window controller which is a state machine. This model also contains inputs to the controller which are selected with manual switch blocks.

The power window controller has four external inputs:

- Passenger Input
- Driver Input
- Window Frame Endstops
- Obstacle Present

Passenger Input

This input consists of a vector with three elements:

- `neutral`: the passenger control switch is not depressed
- `up`: the passenger control switch generates the up signal
- `down`: the passenger control switch generates the down signal

Driver Input

This input consists of a vector with three elements:

- `neutral`: the driver control switch is not depressed
- `up`: the driver control switch generates the up signal
- `down`: the driver control switch generates the down signal

Window Frame Endstops

This input consists of a vector with two elements:

- `0`: window moves freely between top or bottom
- `1`: window is stuck at the top or bottom because of physical limitations

Obstacle Present

This input consists of a vector with two elements:

- 0: window moves freely between top or bottom
- 1: window has obstacle within its frame

You can interactively test the controller by simulating the model and selecting the desired combination of inputs via the manual switch blocks. After making the selection of inputs, you can verify the internal controller state and controller output against the desired result for this specific set of inputs.

CoverageExample

This model shortcut opens the model, `slexPowerWindowCntlCoverage`. This model contains the power window controller which is a state machine. This model also contains inputs to the controller which are repeating sequence blocks.

You can use the Simulink Coverage (TM) Model Coverage tool to validate the discrete event control of the window. The Model Coverage tool helps determine the extent to which a model test case exercises the conditional branches of the controller. It also helps evaluate whether all transitions in the discrete event control are taken given the test case we run. It also evaluates whether all clauses in a condition that enables a particular transition have become true. One transition may be enabled by multiple clauses, e.g., the transition from emergency back to neutral occurs when either 100 ticks have occurred or when the endstop is reached.

IncreaseCoverageExample

This model shortcut opens the model, `slexPowerWindowCntlCoverageIncrease`. This model contains the power window controller that is a state machine. This model also contains a From Spreadsheet block that provides multiple sets of inputs to the controller. These input sets combine with the one from the `CoverageExample` model to exercise more of the logic in the power window controller.

These input sets are:

- `Logged`: Logged from the `CoverageExample`.
- `LoggedObstacleOffEndStopOn`: Logged from the `CoverageExample` with ability to hit endstop.
- `LoggedObstacleOnEndStopOff`: Logged from the `CoverageExample` with obstacle in window.
- `LoggedObstacleOnEndStopOn`: Logged from the `CoverageExample` with obstacle in window and ability to hit endstop.
- `DriverLoggedPassengerNeutral`: Logged from the `CoverageExample` for only the driver. Passenger takes no action.
- `DriverDownPassengerNeutral`: Driver lowering window. Passenger takes no action.
- `DriverUpPassengerNeutral`: Driver raising window. Passenger takes no action.
- `DriverAutoDownPassengerNeutral`: Driver lowering window for 1 second (auto-down). Passenger takes no action.
- `DriverAutoUpPassengerNeutral`: Driver raising window for 1 second (auto-up). Passenger takes no action.
- `PassengerAutoDownDriverNeutral`: Passenger lowering window for 1 second (auto-down). Driver takes no action.
- `PassengerAutoUpDriverNeutral`: Passenger raising window for 1 second (auto-up). Driver takes no action.

The model coverage shortcut, `GenerateIncreasedCoverage`, uses the multiple input sets with the Simulink Coverage Model Coverage tool to validate the discrete event control of the window and generate a coverage report for the multiple input sets. The Model Coverage tool helps determine the extent to which a model test case exercises the conditional branches of the controller. It also helps evaluate if all transitions in the discrete event control have been taken into account given the input sets we run.

See Also

More About

- “Power Window”
- “Project Management”

Developing the Apollo Lunar Module Digital Autopilot

"Working on the design of the Lunar Module digital autopilot was the highlight of my career as an engineer. When Neil Armstrong stepped off the LM (Lunar Module) onto the moon's surface, every engineer who contributed to the Apollo program felt a sense of pride and accomplishment. We had succeeded in our goal. We had developed technology that never existed before, and through hard work and meticulous attention to detail, we had created a system that worked flawlessly." -Richard J. Gran, *The Apollo 11 Moon Landing: Spacecraft Design Then and Now*

This example shows how Richard and the other engineers who worked on the Apollo Lunar Module digital autopilot design team could have done it using Simulink® and Aerospace Blockset™ if they had been available in 1961.

Model Description

Developing the autopilot in Simulink takes a fraction of the time it took for the original design of the Apollo Lunar Module autopilot.

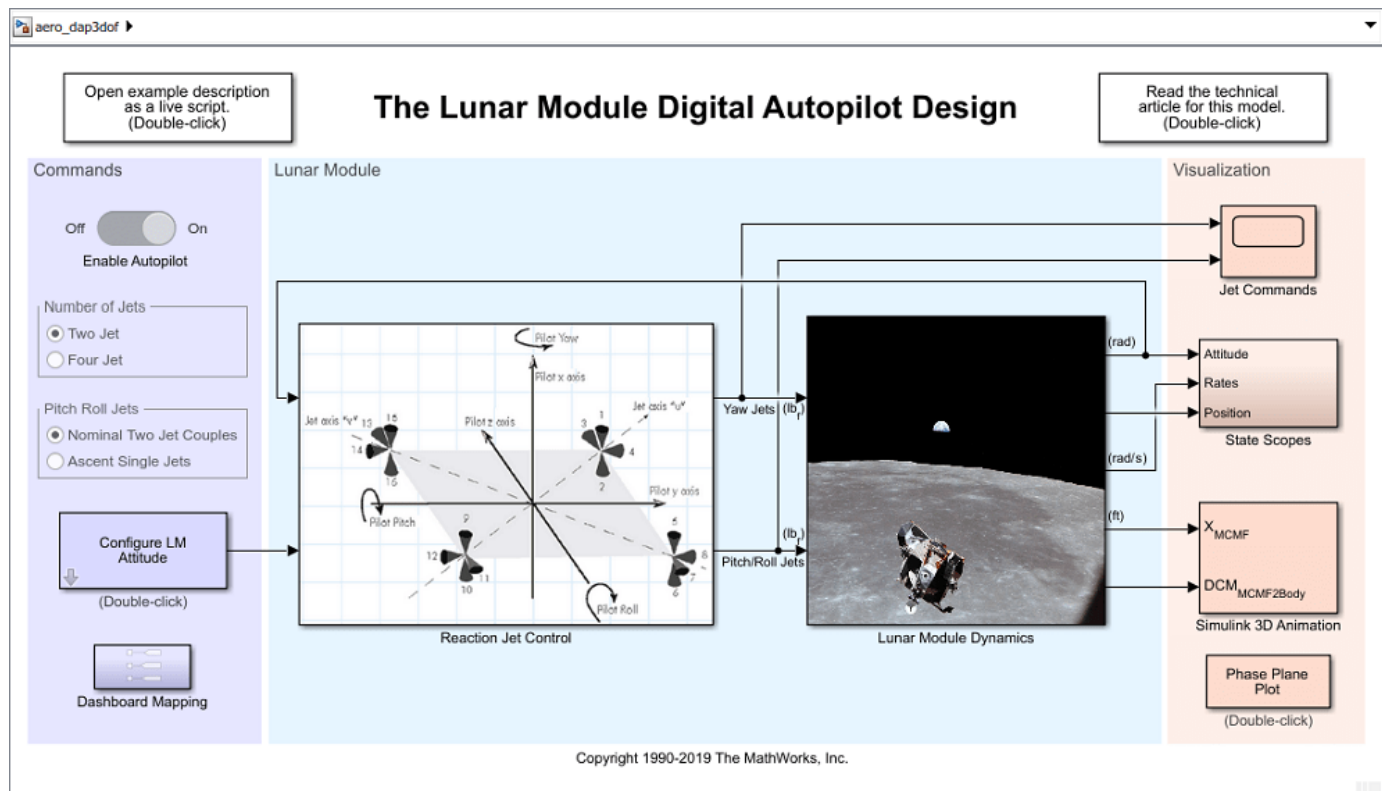

The Reaction Jet Control subsystem models the digital autopilot design proposed (and implemented) by MIT Instrumentation Laboratories (MIT IL), now called Draper Labs. A Stateflow® diagram in the model specifies the logic that implements the phase-plane control algorithm described in the technical article *The Apollo 11 Moon Landing: Spacecraft Design Then and Now*. Depending on which region of the diagram the Lunar Module is executing, the Stateflow diagram is in either a `Fire_region` or a `Coast_region`. Note, the transitions between these different regions depend on certain parameters. The Stateflow diagram determines whether to transition to another state and then computes which reaction jets to fire.

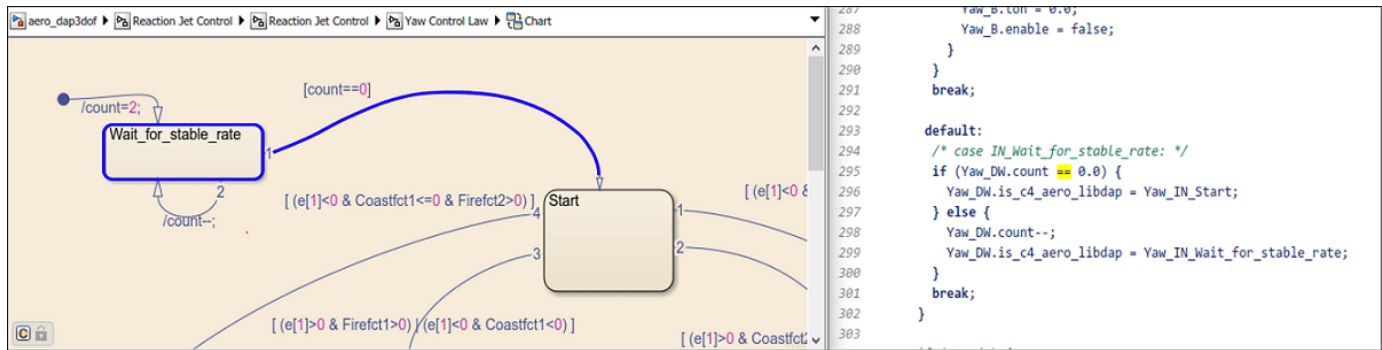

Translational and rotational dynamics of the Lunar Module are approximated in the Lunar Module Dynamics subsystem. Access various visualization methods of the Lunar Module states and autopilot performance in the Visualization area of the model, including Simulink scopes, animation with Simulink 3D Animation, and a phase plane plot.

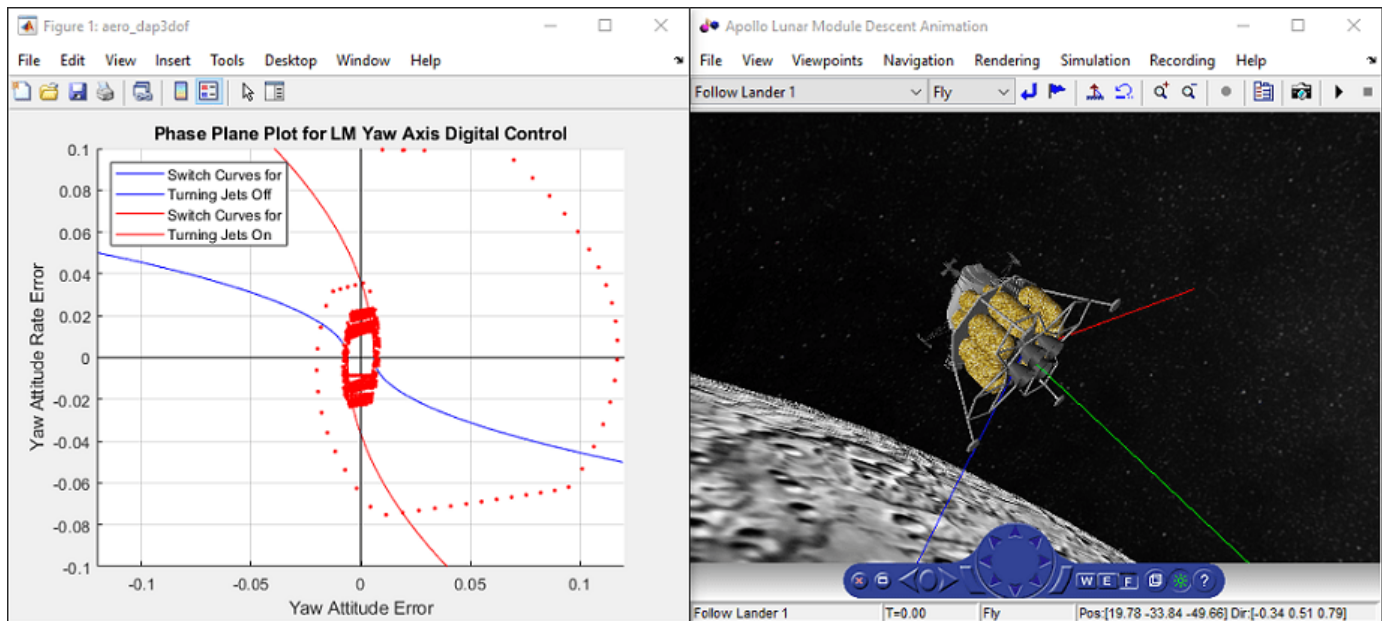

Interactive Controls

To interact with the Lunar Module model, vary autopilot settings and Lunar Module initial states in the Commands area. For example, to observe how the digital autopilot design handles increased initial body rates, use the slider components in the Configure LM Attitude subsystem.

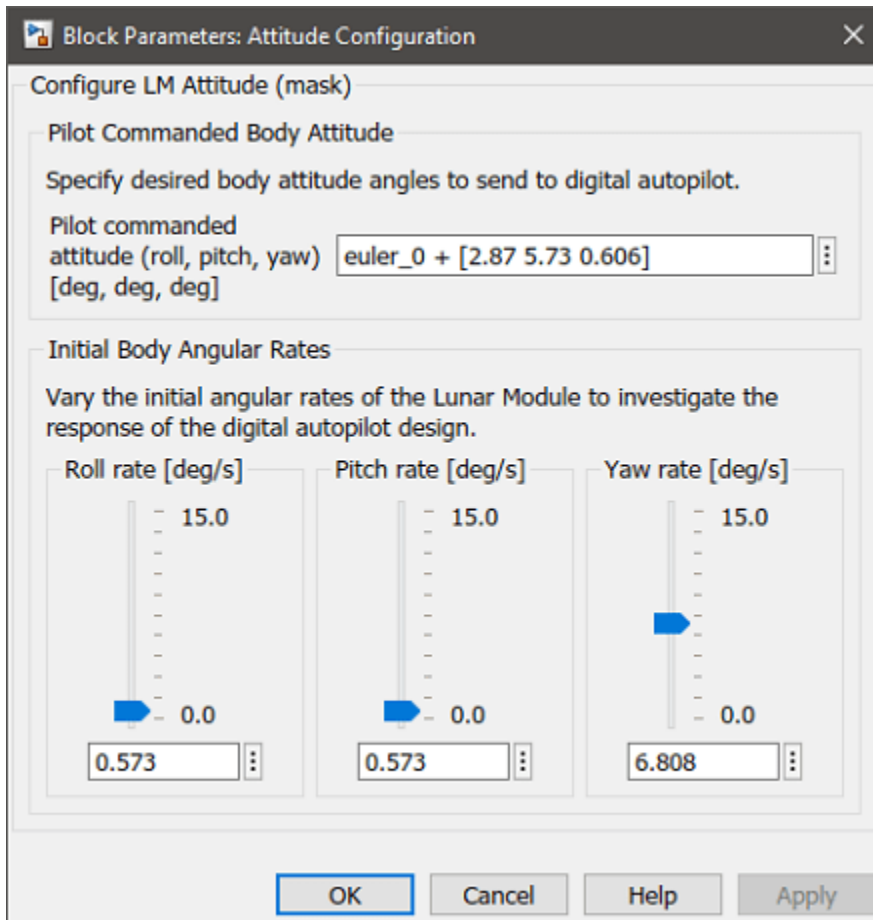

Mission Description

The LM digital autopilot has 3 degrees of freedom. This means that by design, the reaction jet thrusters are configured and commanded to rotate the vehicle without impacting the vehicle's orbital trajectory. Therefore, the translational dynamics in this model are approximated solely via orbit propagation using the Moon Zonal Harmonic Gravity Model from Aerospace Blockset. To demonstrate the digital autopilot design behavior, the "Descent Orbit Insertion" mission segment, just prior to the initiation of the powered descent, was selected from the Apollo 11 Mission Report.

NASA-S-69-3709

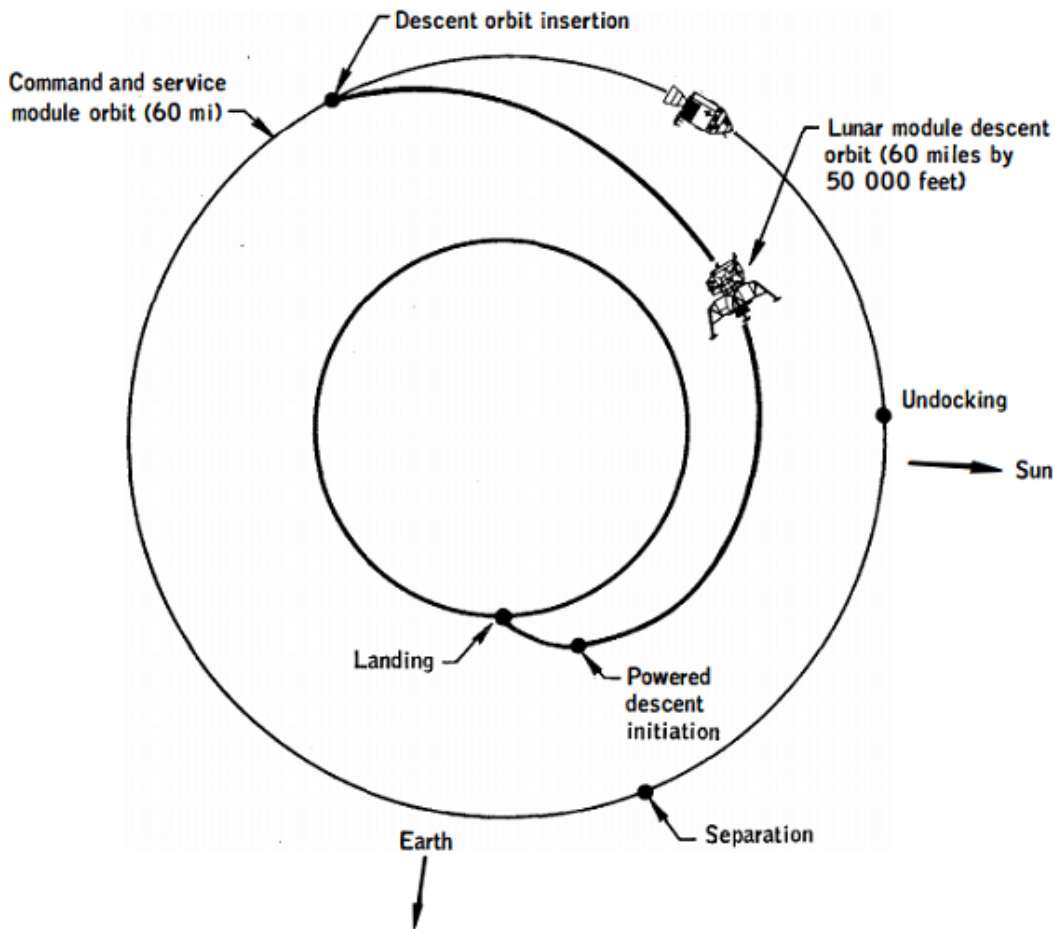

Figure 5-1 . - Lunar descent orbital events .

5-19

The Descent Orbit Insertion burn began 101 hours, 36 minutes, and 14 seconds after lift-off and lasted 30 seconds. The burn set the Lunar module on a trajectory to lower its orbit from approximately 60 nautical miles to 50,000 ft over about an hour. At 50,000 ft, the Module initiated its powered descent.

Initialize the model `aero_dap3dof` with the approximate trajectory of the Lunar Module immediately after the descent orbit insertion burn.

| MissionTime_GMT | MissionPhase |
|----------------------|---|
| 16-Jul-1969 13:32:00 | {'Range Zero (lift-off)' } |
| 20-Jul-1969 19:08:14 | {'Descent Orbit Insertion (Engine ignition)'} } |
| 20-Jul-1969 19:08:44 | {'Descent Orbit Insertion (Engine cutoff)' } |
| 20-Jul-1969 20:05:05 | {'Powered Descent (Engine ignition)' } |

The trajectory of the module at Descent orbit insertion (Engine cutoff) and Powered descent initiation (Engine ignition) is provided in the *Apollo 11 Mission Report* (Table 7-II.- Trajectory Parameters).

| Var1 | Latitude_deg | Longitude_deg | Altitude_mi |
|---|---------------|------------------|-------------|
| {'Descent Orbit Insertion (Engine cutoff)'} {'Powered Descent (Engine ignition)' } | -1.16 1.02 | -141.88 39.39 | 57.8 6.4 |

The Simulink model `aero_dap3dof` is initialized to align with the beginning of the mission phase "Descent Orbit Insertion trajectory (Engine cutoff)". Open the `aero_dap3dof` model and run the simulation.

Closing Remarks

Building a digital autopilot was a daunting task in 1961 because there was very little industrial infrastructure for it - everything about it was in the process of being invented. Here is an excerpt from the technical article *The Apollo 11 Moon Landing: Spacecraft Design Then and Now*:

"One reason why the [autopilot's machine code] was so complex is that the number of jets that could be used to control the rotations about the pilot axes was large. A decision was made to change the axes that the autopilot was controlling to the "jet axes" shown in `aero_dap3dof`. This change dramatically reduced the number of lines of code and made it much easier to program the autopilot in the existing computer. Without this improvement, it would have been impossible to have the autopilot use only 2000 words of storage. The lesson of this change is that when engineers are given the opportunity to code the computer with the system they are designing, they can often modify the design to greatly improve the code."

References

[1] National Aeronautics and Space Administration Manned Spacecraft Center, Mission Evaluation Team. (November 1969). *Apollo 11 Mission Report MSC-00171*. Retrieved from <https://www.nasa.gov/specials/apollo50th/pdf/A11_MissionReport.pdf>

[2] Richard J. Gran, MathWorks. (2019). *The Apollo 11 Moon Landing: Spacecraft Design Then and Now*. Retrieved from <<https://www.mathworks.com/company/newsletters/articles/the-apollo-11-moon-landing-spacecraft-design-then-and-now.html>>

See Also

More About

- "Aerospace Blockset"
- "Create Aerospace Models" (Aerospace Blockset)

Designing a High Angle of Attack Pitch Mode Control

Control Design Using Simulink®

This example shows how to use the Control System Toolbox™ and Simulink® Control Design™ to interact with Simulink to design a digital pitch control for the aircraft. In this example, we will design the controller to permit the aircraft to operate at a high angle of attack with minimal pilot workload.

Our example takes you through the first pass at designing a digital autopilot for a high angle of attack controller. To run everything in this example you must have the Control System Toolbox, Simulink Control Design, Simulink, and Simulink® Coder™. If you don't have all of these products, you can still run portions of the example using cell execution mode of the MATLAB® editor.

Below is a Simulink model of the aircraft. The control systems in the Controllers block can be switched in the model to allow you to see the analog response and then to switch to a design created using the Control System Toolbox's Linear Time Invariant (LTI) objects. A controller is also included that is a discrete implementation of the analog design that is similar to the algorithm that would go into an on-board flight computer. Take a few moments to explore the model.

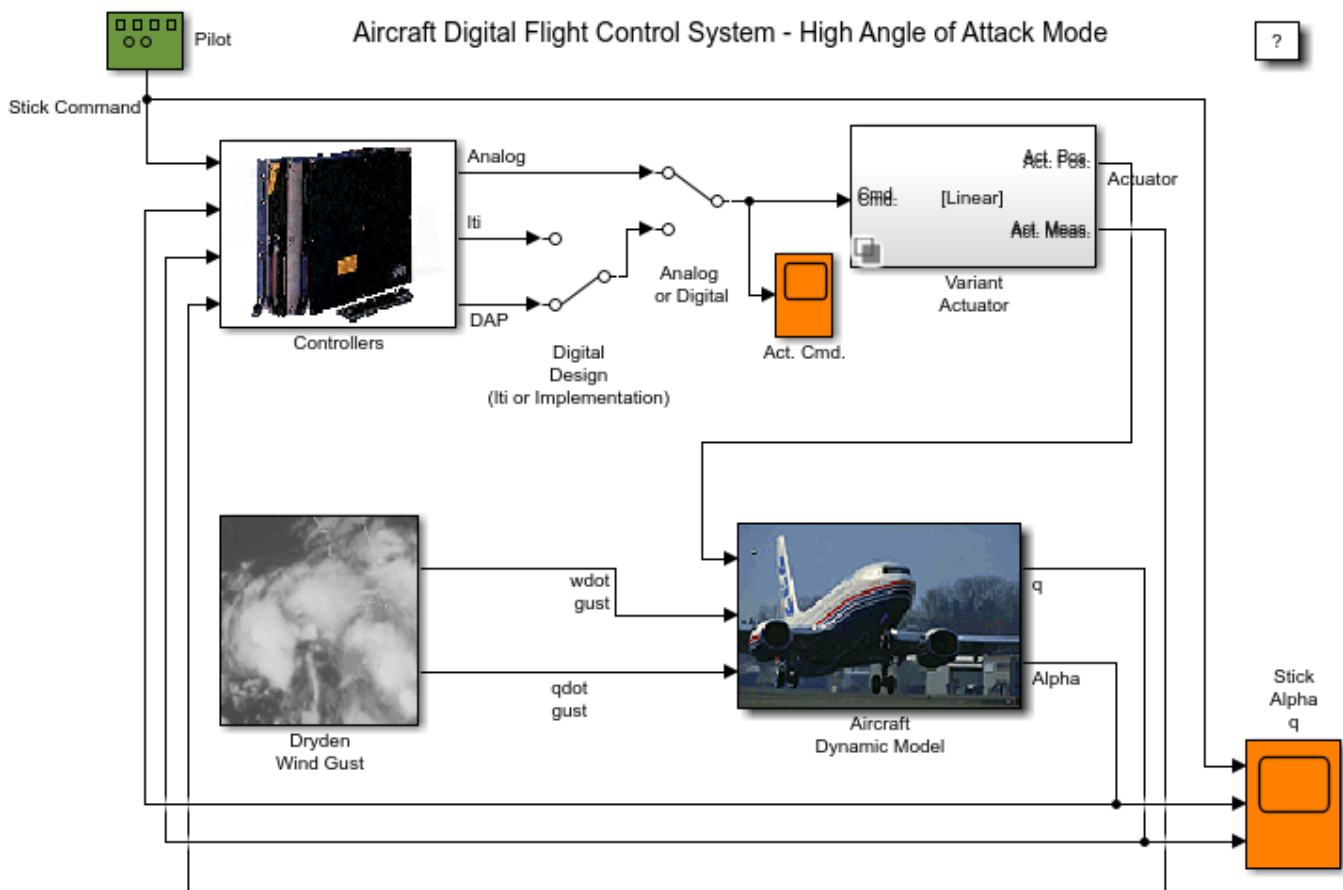

Copyright 2013 -2014 The MathWorks, Inc.

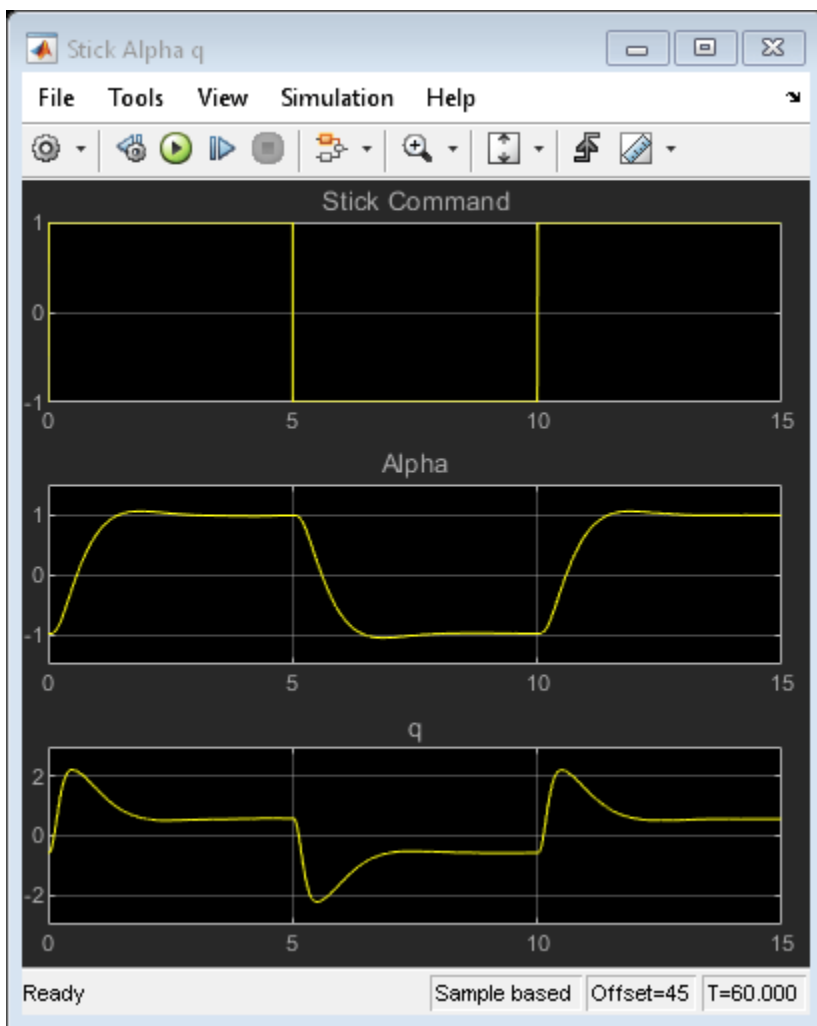
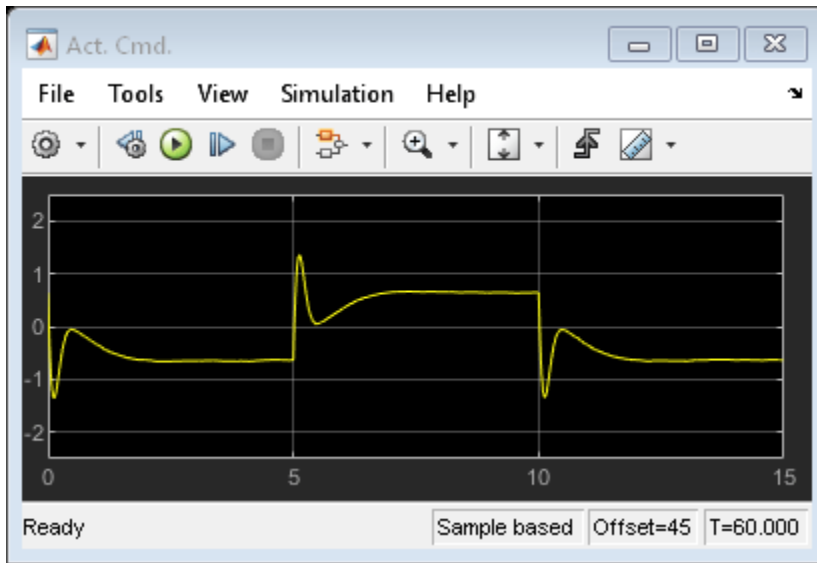

Figure 1: Simulink model of the aircraft flight control system.

Trimming and Linearization

You can linearize the model using Simulink Control Design software. To interactively linearize the model, use the **Model Linearizer** app. To open the app, in the Simulink Editor, on the **Apps** tab, under **Control Systems**, click **Model Linearizer**. You can also programmatically linearize the model using the `linearize` function.

Open the `slexAircraftPitchControlAutopilot` model.

To view the linearized model parameters:

```
apmdl = 'slexAircraftPitchControlAutopilot';
open_system(apmdl);
op = operpoint(apmdl);
io = getlinio(apmdl);
contap = linearize(apmdl,op,io)
```

contap =

```
A =
      Alpha-sensor  Pitch Rate L  Proportional  Stick Prefil
Alpha-sensor      -2.526           0           0           0
Pitch Rate L       0           -4.144           0           0
Proportional       -1.71          0.9567           0          10
Stick Prefil       0           0           0           0          -10
```

```
B =
      Alpha Sensed      Stick      q Sensed
Alpha-sensor           1           0           0
Pitch Rate L           0           0           1
Proportional           0           0          -0.8156
Stick Prefil           0           1           0
```

```
C =
      Alpha-sensor  Pitch Rate L  Proportional  Stick Prefil
Sum                2.986          -1.67          -3.864          -17.46
```

```
D =
      Alpha Sensed      Stick      q Sensed
Sum                   0           0           1.424
```

Continuous-time state-space model.

The Original Analog Autopilot for the High Angle of Attack Mode

?

This autopilot configuration uses a traditional design.
The parameters T_s , T_{al} , W_1 , W_2 , K_a , K_q , K_f , and K_i need to be optimized.

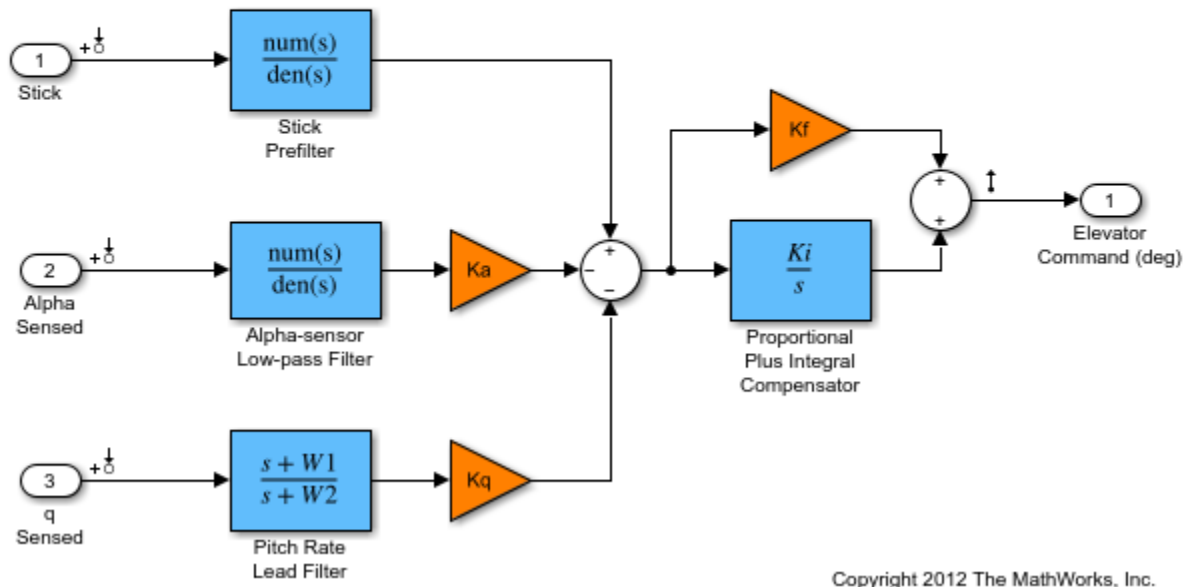

Figure 2: Original analog autopilot.

Linear Time-Invariant (LTI) Systems

There are three types of LTI objects you can use to develop a linear model:

State Space (SS), Transfer Function (TF), and Zero-Pole-Gain (ZPG) objects.

The variable `contap` is a State Space object. You can then get one of the other types with the other commands. When you create the object in MATLAB, you can manipulate it using operations such as `*`, `+`, `-`, etc. This is called "overloading" the MATLAB operators. Try creating an object of your own and see what happens when adding, multiplying, etc. with the `contap` object.

To see exactly what is stored in the LTI object, type `get(contap)` or `contap.InputName` for example.

To view Zero/Pole/Gain transfer functions:

```
contap = tf(contap);
contap = zpk(contap)
```

```
contap =
```

```
From input "Alpha Sensed" to output "Sum":
2.9857 (s+2.213)
-----
s (s+2.526)
```

```

From input "Stick" to output "Sum":
-17.46 (s+2.213)
-----
      s (s+10)

From input "q Sensed" to output "Sum":
1.424 (s+2.971) (s+2.213)
-----
      s (s+4.144)

```

Continuous-time zero/pole/gain model.

Discretized Controller Using Zero-Order Hold

Now the LTI object will be used to design the digital autopilot that will replace the analog autopilot. The analog system is coded into the LTI object called `contap` (CONTinuous AutoPilot).

The first attempt at creating a digital autopilot will use a zero-order hold with a sample time of 0.1 seconds. Note that the discrete object maintains the type (ss, tf, or zpk).

It is clear from Bode plot below that the systems do not match in phase from 3 rad/sec to the half sample frequency (the vertical black line) for the pilot stick input and the angle of attack sensor. This design has poorer response than the analog system. Go to the Simulink model and start the simulation (make sure you can see the scope windows). While the simulation is running, double-click the manual switch labeled Analog or Digital.

Does the simulation verify the conclusion reached by interpreting the Bode diagram?

```

discap = c2d(contap, 0.1, 'zoh');
get(discap)
bode(contap,discap)

      Z: {[0.8016] [0.8039] [2x1 double]}
      P: {[2x1 double] [2x1 double] [2x1 double]}
      K: [0.2943 -1.2458 1.4240]
DisplayFormat: 'roots'
Variable: 'z'
IODElay: [0 0 0]
InputDelay: [3x1 double]
OutputDelay: 0
Ts: 0.1000
TimeUnit: 'seconds'
InputName: {3x1 cell}
InputUnit: {3x1 cell}
InputGroup: [1x1 struct]
OutputName: {'Sum'}
OutputUnit: {''}
OutputGroup: [1x1 struct]
Notes: [0x1 string]
UserData: []
Name: ''
SamplingGrid: [1x1 struct]

```

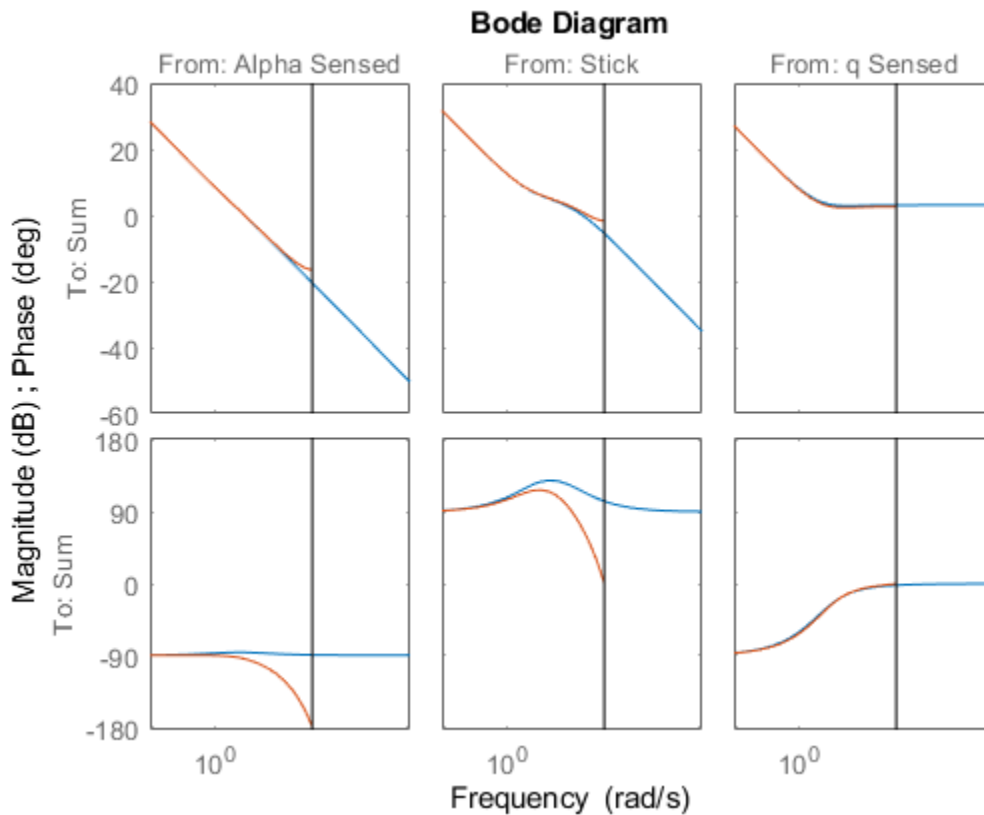

Figure 3: Bode diagram comparing analog and ZOH controllers.

Tustin (Bilinear) Discretization

Now try different conversion techniques. You can use the Tustin transformation. In the command window type the commands above.

It should be clear that the systems still do not match in phase from 3 rad/sec to the half sample frequency, the Tustin transformation does better. The simulation uses the LTI object as it is designed. To see how the object is used look in the Controllers subsystem by using the browser or by double clicking the icon. The LTI block picks up an LTI object from the workspace. You can change the object name used in the block to any LTI object in the workspace.

Try using "discap1", the Tustin discretization of the analog design:

```
discap1 = c2d(contap,0.1,'tustin');
bode(contap,discap,discap1)
```

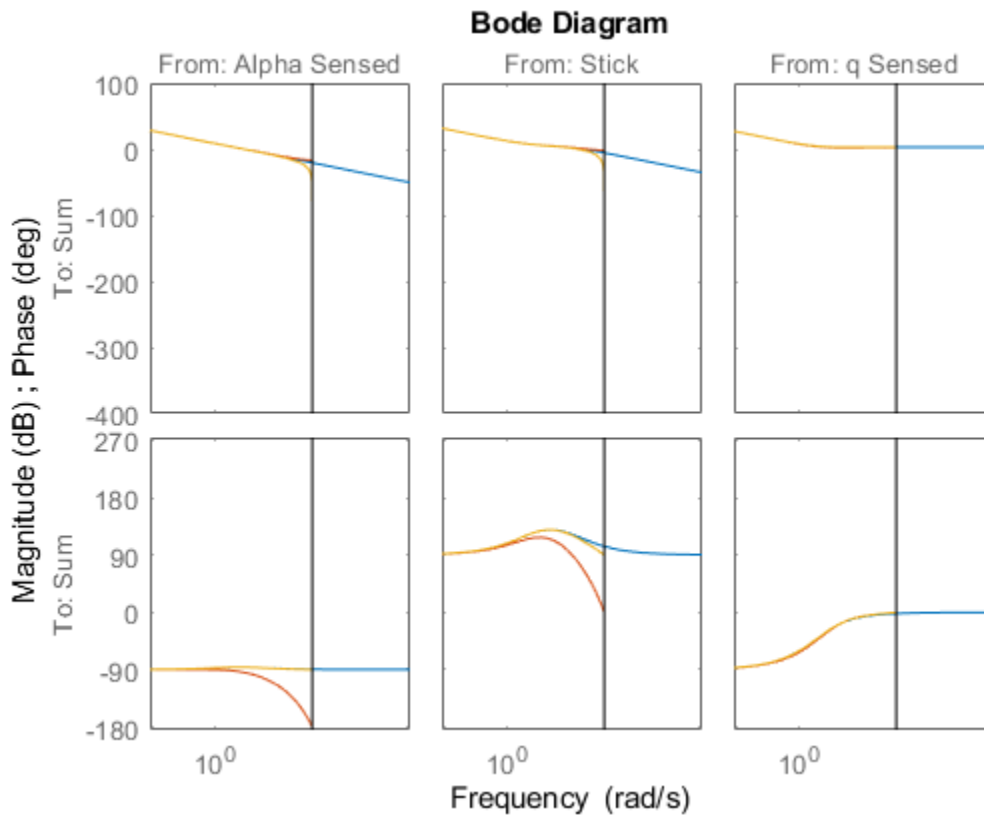

Figure 4: Bode diagram comparing analog and 0.1 sec Tustin controllers.

Selecting a Sample Time

The Tustin transform performs better than the zero-order hold from the analysis so far. The sample time of 0.1 second appears to be too slow for the discrete system to track the performance of the analog system at half the sample frequency.

Now transform the analog design using the Tustin transform with a 0.05 second sample period:

```
discap = c2d(contap,0.05,'tustin')
bode(contap,discap)
```

```
discap =
```

```
From input "Alpha Sensed" to output "Sum":
0.074094 (z-0.8951) (z+1)
-----
(z-1) (z-0.8812)
```

```
From input "Stick" to output "Sum":
-0.36852 (z-0.8951) (z+1)
-----
(z-1) (z-0.6)
```

```
From input "q Sensed" to output "Sum":
```

$$\frac{1.4629 (z-0.8617) (z-0.8951)}{(z-1) (z-0.8123)}$$

Sample time: 0.05 seconds
Discrete-time zero/pole/gain model.

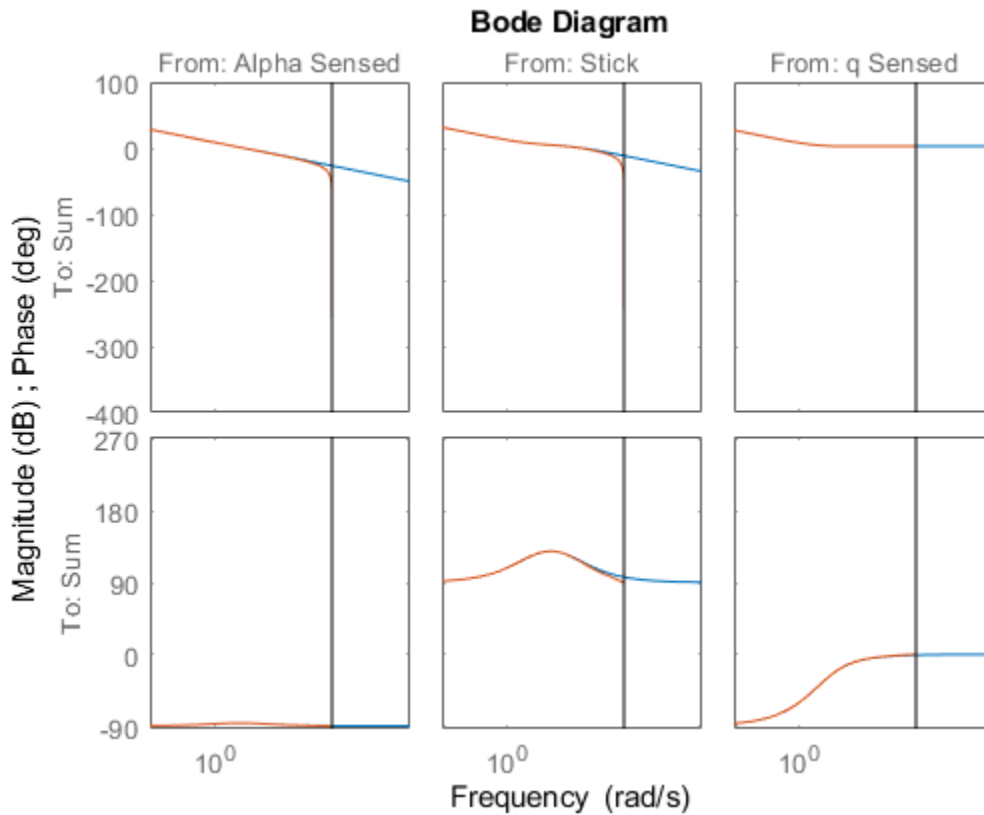

Figure 5: Bode diagram comparing analog and 0.05 sec Tustin controllers.

Real-World Considerations

Now that we have what appears to be a workable design, we need to implement it in a form that will include some of the necessary elements that were ignored in the linear analysis. For example, if you look at the analog autopilot that is in the Controllers subsystem, you will see some logic that stops the integrator from winding up when the actuator saturates:

Open the AnalogControl subsystem.

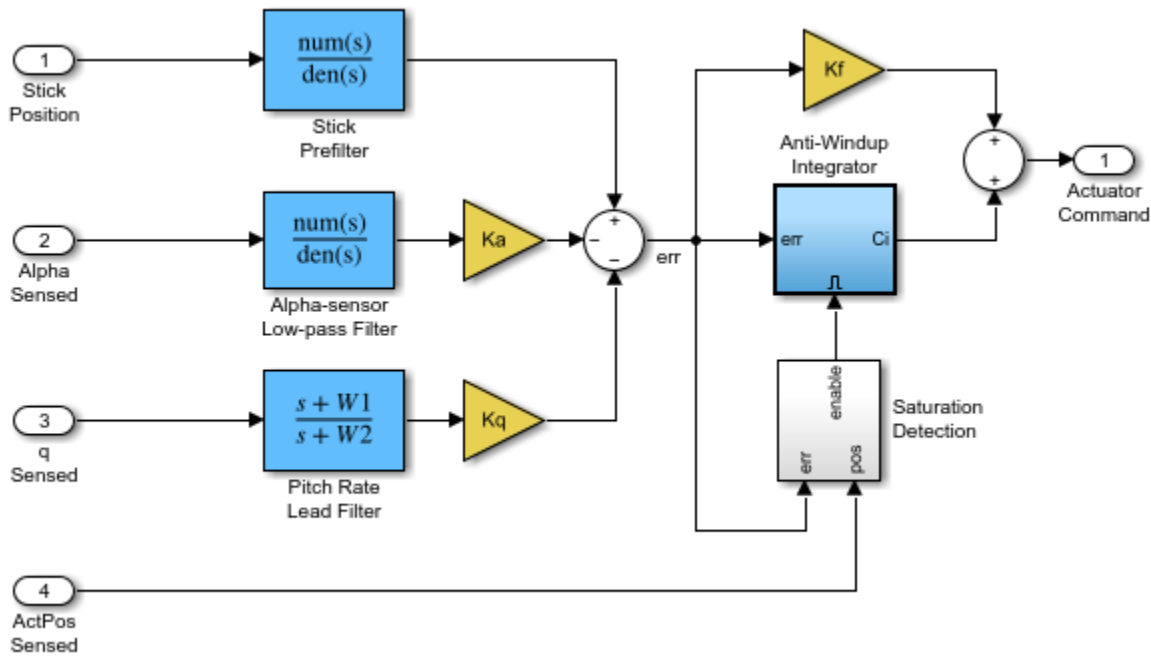

Figure 6: AnalogControl subsystem.

Implementation of the Full Design

The integrator wind-up is only one of the practical issues that needs to be addressed. Another is the need to eliminate aliased high frequency signals that could enter at measurement points. These aliased signals can be prevented by specifying analog filters in front of the sample and hold (ZOH) blocks that model the analog-to-digital converter (ADC) devices typically used for measuring signals in an embedded application. Additionally, the filters in the digital section of the autopilot operate at a higher sampling rate than the compensator to provide a conditioned signal to the compensator. The analog filters are necessary because once a signal is aliased, there is no way to separate the valid in-band frequency content from aliased content.

This new controller is called Digital Control. The filters have a sample time of deltat1 (set to be $1/10$ of deltat). The zero-order hold blocks specify these sample times for various downstream blocks through sample time inheritance.

The switches in the `slexAircraftPitchControlExample` model are set up so you can switch between the analog autopilot, the digital LTI object, and the digital autopilot that could be implemented using software.

Try simulating the system again and switch among the three autopilot designs. You should see that the designs are not significantly affected by which autopilot is active. You can also increase the amplitude of the wind gust and verify that the anti-aliasing filters are working satisfactorily. To increase the gust amplitude, open the Dryden Wind Gust subsystem and change (by double clicking the icon) the noise variance of the White Noise that drives the gust simulation.

Open the DigitalControl subsystem.

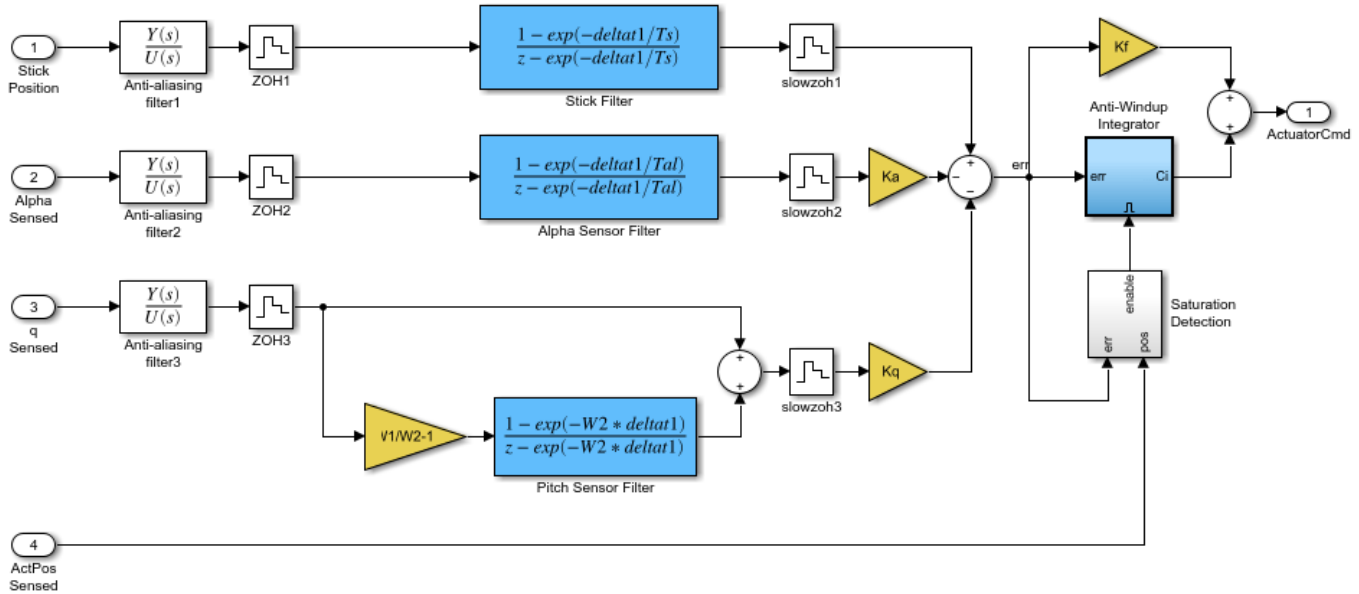

Figure 7: DigitalControl subsystem.

Variant Systems for Design Variants

The actuators in the Simulink model use the Variant Subsystems block to represent multiple actuator implementations, where only one implementation is active during simulation. You can double-click the Variant Actuator Subsystem block to view the different actuator implementations.

To make the simulation change, use the nonlinear actuator instead of the linear one. You can do this by using the Variant Subsystem block **Variant > Override using** context menu.

Note that Simulink must be stopped in order to reconfigure the actuator selection. You should also note that the nonlinear actuator has saturations on position and rate.

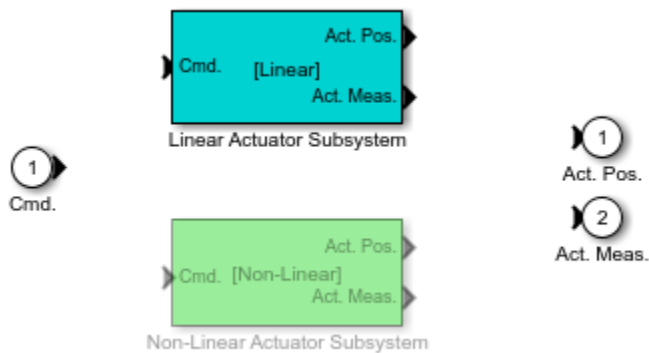

Figure 8: Variant Subsystem for Actuators

Code Generation

The autopilot design can be transformed into embeddable code using Simulink Coder. A separate model of the digital autopilot, slxAircraftPitchControlDAP, is open below; it was coded into a host-

based standalone program using Simulink Coder and the compiler specified using the `mex -setup` configuration. The simulation results can be used as a validation baseline for the functional correctness of the generated code.

The executable file resulting from code generation and compilation is `slexAircraftPitchControlDAP.exe`. If you create it, it can be run from the OS shell (DOS) command line directly or from MATLAB by typing:

```
>> !slexAircraftPitchControlDAP.exe
```

The executable program creates a file called `slexAircraftPitchControlDAP.mat` that you can load by typing `load slexAircraftPitchControlDAP`.

Two variables called `rt_tout` and `rt_yout` will be in the workspace and their variance against the simulation baseline can be plotted. Note that the variance is effectively zero for this model on this host. Some small numeric variance is to be expected in more complex calculations due to differing compiler optimizations and use of intermediate register variables having higher precision than the 64-bit storage format of a double. Significant variances should be examined as they could indicate a numerical stability problem in your model's algorithms, a compiler or run-time library bug, or other problems.

Open the `slexAircraftPitchControlDAP` model.

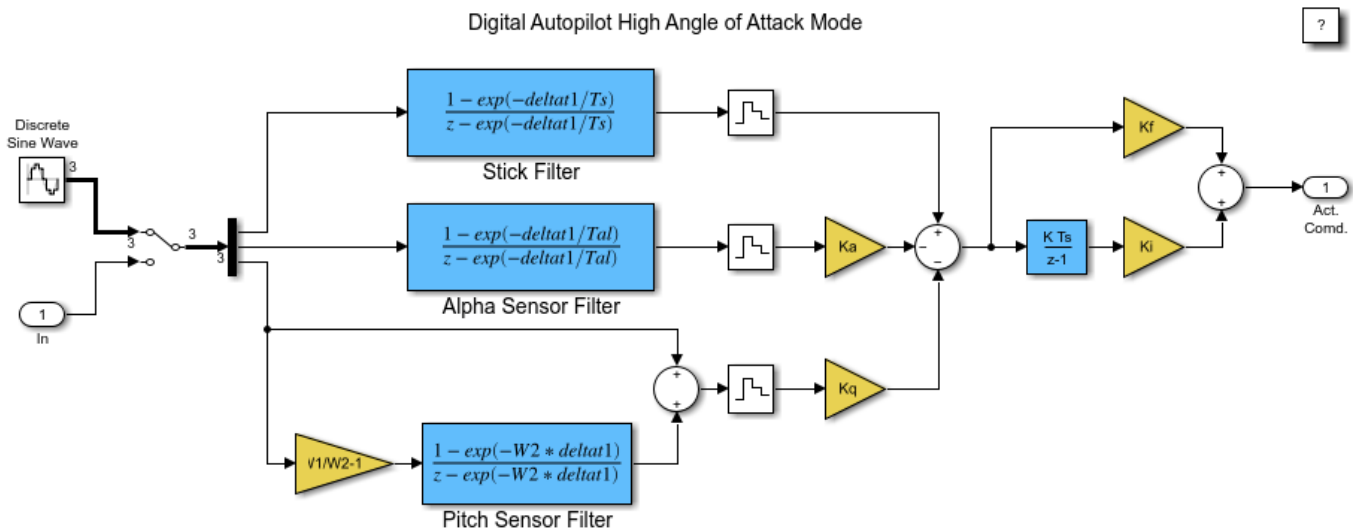

Copyright 2012 The MathWorks, Inc.

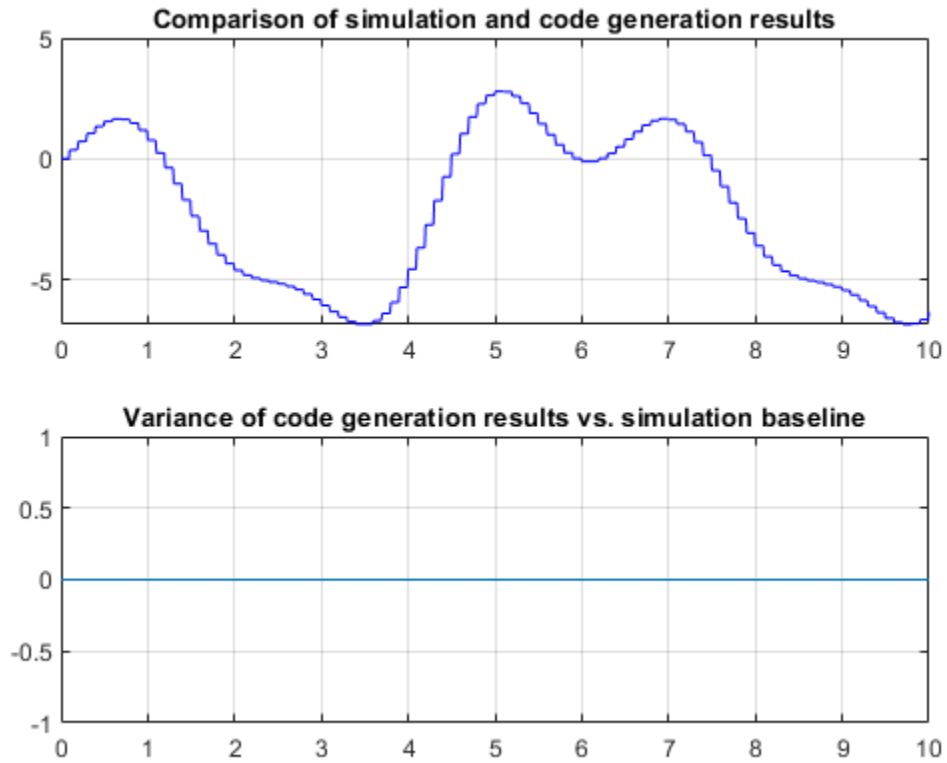

Figure 9: Comparison of simulation and code generation results.

Behavior of the First Pass Design

Here is the time response of the high angle of attack mode digital pitch controller design:

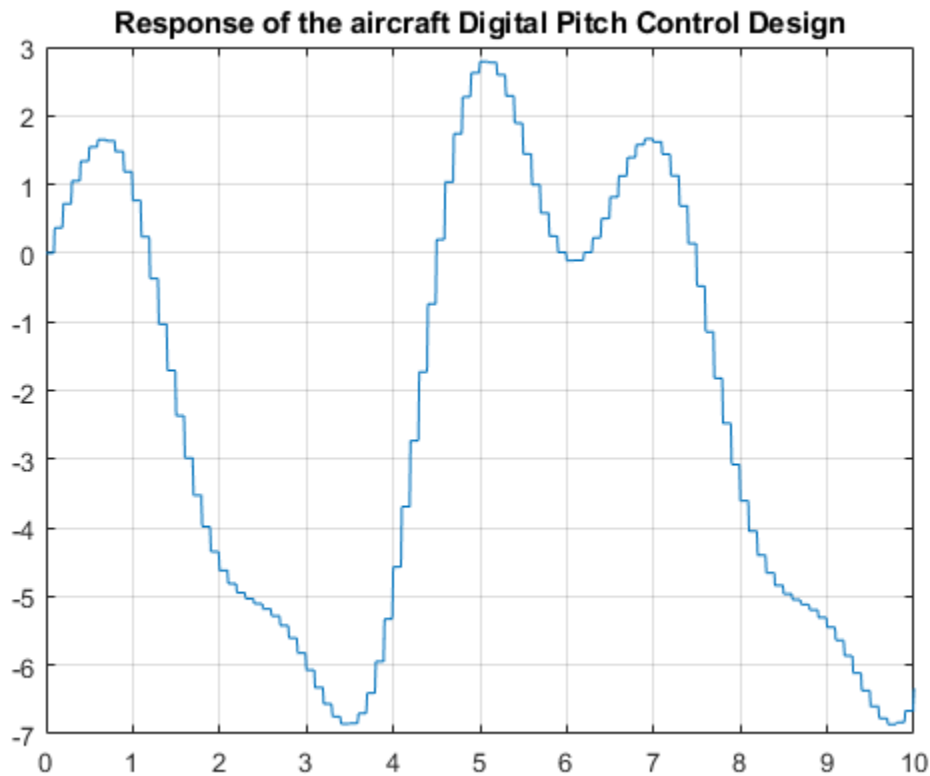

Figure 10: Response of the aircraft Digital Pitch Control Design.

Summary

Further work on this design might include incorporating and analyzing more of the real-world effects on the compensator such as the effect of the anti-aliasing filter dynamics and computational delay of the embedded digital computer on the overall "plant" seen by the digital computations. The combination of the real plant, the computational delay, the anti-aliasing filters, and the sample-and-hold delay are just a few of the additional items that might affect the design of the digital compensator parameters.

See Also

`linearize` | `Model Linearizer`

More About

- "Aerospace Blockset"
- "Create Aerospace Models" (Aerospace Blockset)

Six Degrees of Freedom (6-DoF) Motion Platform

This example shows how to model six degrees of freedom motion in Simulink®. You can switch between using Euler Angles and Quaternions to model the equations of motion, using the Variant Subsystem block's "Variant > Override using" context menu.

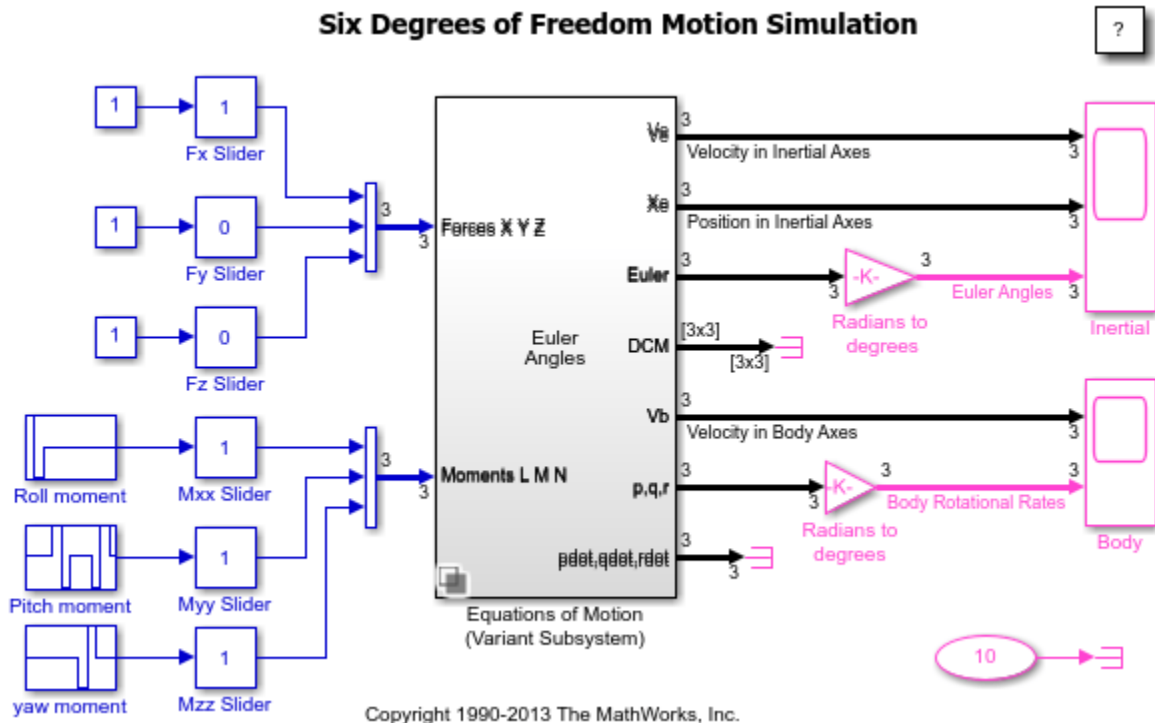

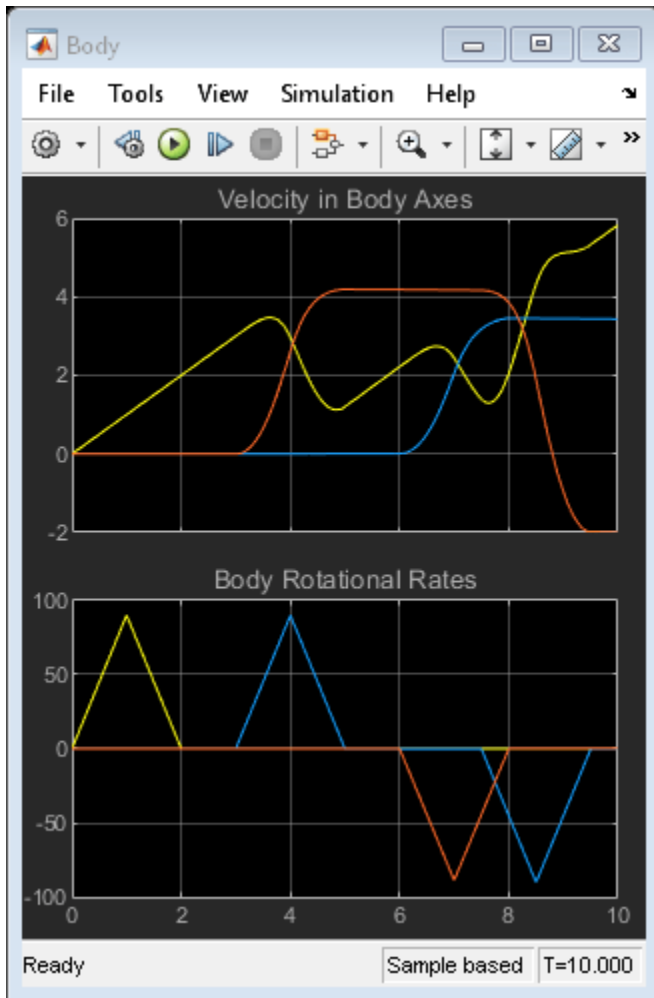

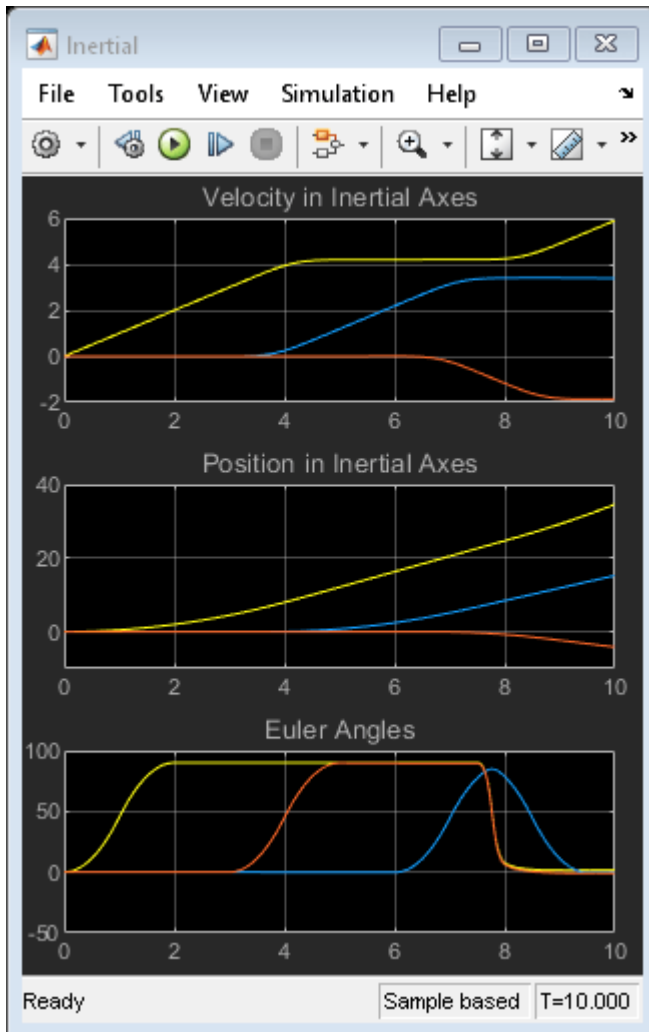

See Also

More About

- "Aerospace Blockset"
- "Create Aerospace Models" (Aerospace Blockset)

Aircraft Longitudinal Flight Control

This example shows how to model flight control for the longitudinal motion of an aircraft. First order linear approximations of the aircraft and actuator behavior are connected to an analog flight control design that uses the pilot's stick pitch command as the set point for the aircraft's pitch attitude and uses aircraft pitch angle and pitch rate to determine commands. A simplified Dryden wind gust model is incorporated to perturb the system.

The Viewers and Generators Manager was used in this model to create the model scope for viewing signals, Scope1. Found on **Simulation > Prepare > Viewers Manager**, the Viewers and Generators Manager allows you to instrument your model without having to add blocks to the model. If you close a model scope, such as for batch simulations, you can later reopen it by double-clicking the "scope" icon on the signal of interest.

Parameters for the model are stored in a file named `slexAircraftData.m`. This file is loaded by the model into the model workspace. You can view and edit data in the model workspace directly by using the Model Explorer, which is launched using the **Modeling > Design > Model Explorer** menu item.

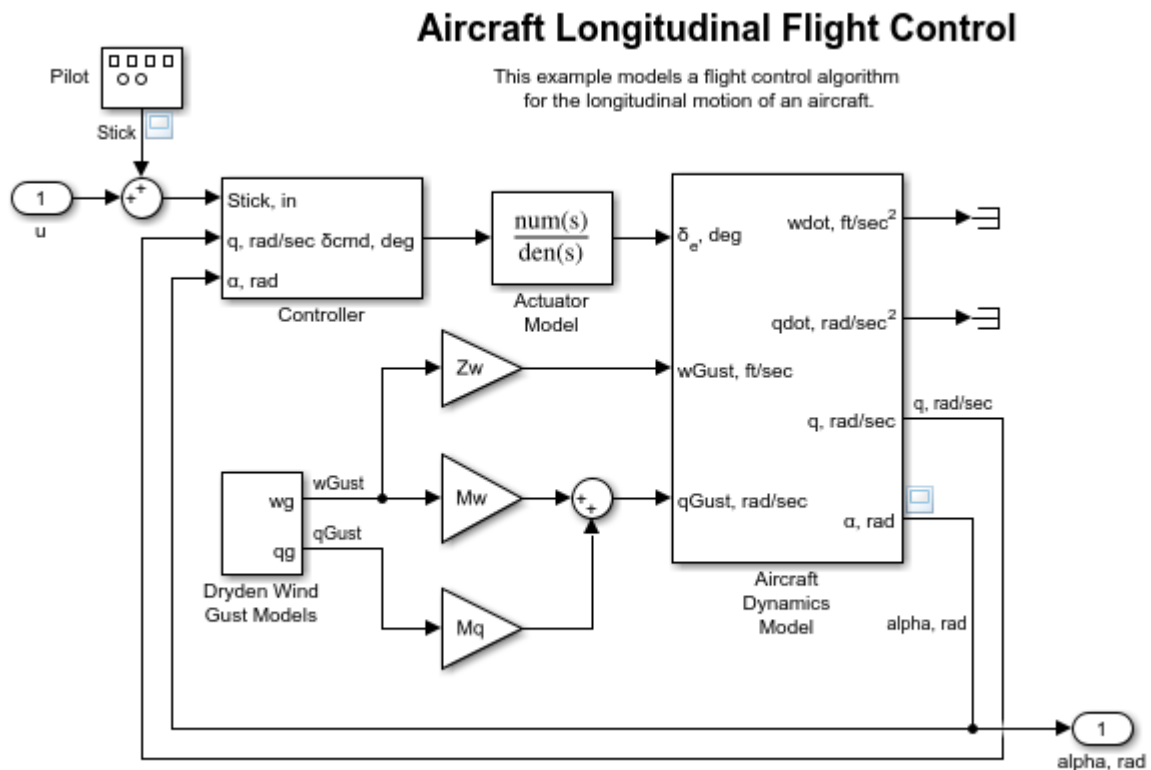

See Also

More About

- “Aerospace Blockset”

- “Create Aerospace Models” (Aerospace Blockset)
- “Simulink Model Discretizer” on page 13-226

Simulink Model Discretizer

This interactive example discretizes the Actuator Model in the `slexAircraftExample` model. If you haven't already, click **Open Model** to open the model.

Open the Model Discretizer

To open the Model Discretizer, in the Simulink Editor, on the **Apps** tab, under **Apps**, under **Control Systems**, click **Model Discretizer**. This opens the Model Discretizer.

The Simulink model window and the Model Discretizer GUI are laid out in the screen for easy navigation.

- The model tree is shown in the left panel of the Model Discretizer GUI.
- Discretization parameters are set through the right panel of the Model Discretizer GUI.
- Discretization status is shown in the lower part of the right panel.
- By default, only continuous blocks are shown in the Model Discretizer GUI.
- In the Simulink model window, blocks in red color are continuous blocks.

You can browse through the continuous blocks one by one using the model tree view. In the Simulink Model Discretizer, select the **View > Next continuous block**. This highlights the Actuator Model.

Before discretizing the Actuator Model block, set the discretization parameters: transform method, sample time, critical frequency. Critical frequency has to be specified if the transform method 'tustin with prewarping' is selected.

After setting the discretization parameters, select **Discretize > Discretize current block** in the Model Discretizer. Or you can just click the s->z button icon in the tool bar. The discretized Actuator Model is highlighted in blue color in the model.

By default, the Actuator Model was replaced by a discrete block beneath a continuous block dialog, allowing you to continue entering the Actuator Model parameters in the s-domain. In the model window, double-click the Actuator model. Two new fields 'Sample time' and 'Method' were added to the block dialog window. These parameters are used to automatically convert the continuous parameters to equivalent discrete parameters.

See Also

Related Examples

- "Aircraft Longitudinal Flight Control" on page 13-224

Radar Tracking Using MATLAB Function Block

This example shows how to use an extended Kalman filter with the MATLAB® Function block in Simulink® to estimate an aircraft's position from radar measurements. The filter implementation is found in the MATLAB Function block, the contents of which are stored in the Simulink model itself.

At the end of the simulation, three figures display the following information: the actual trajectory compared to the estimated trajectory; the estimation residual for range; and the actual, measured, and estimated positions.

Radar Tracking Using MATLAB Function Block

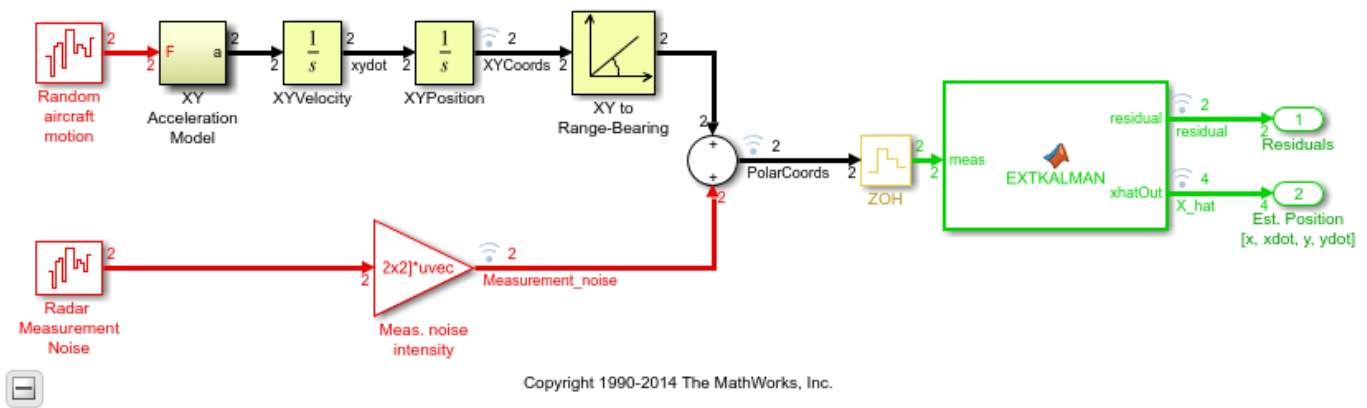

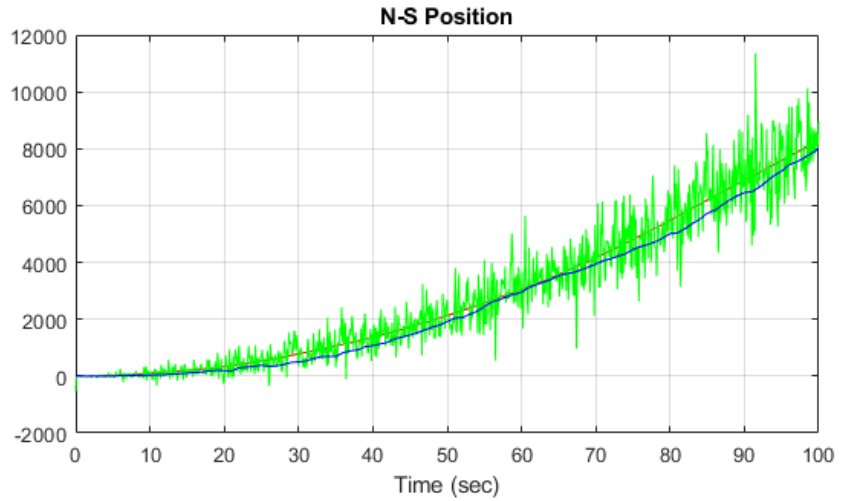
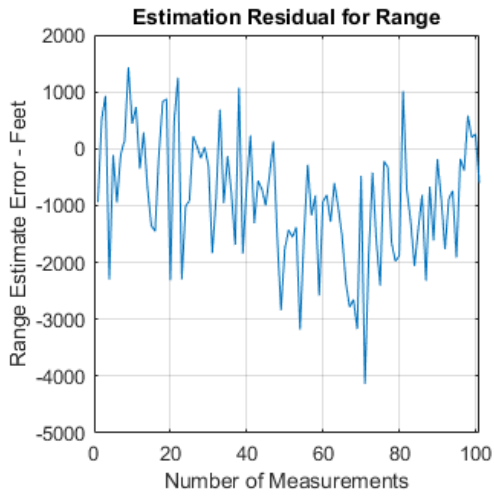
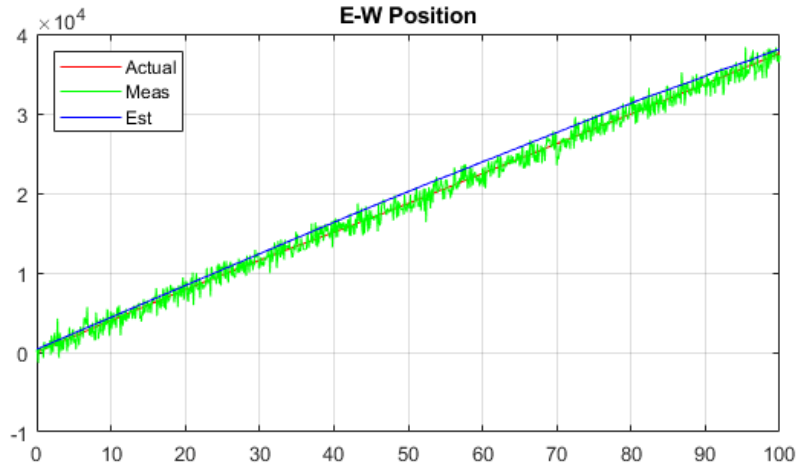
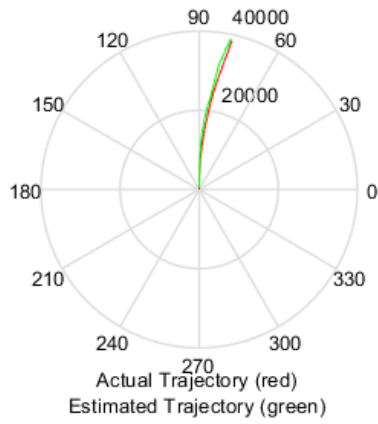

See Also

More About

- “Aerospace Blockset”
- “Create Aerospace Models” (Aerospace Blockset)

Optical Sensor Image Generation

Generating an Optical Sensor Image From Simulated Movement Data

This example shows how to generate a movie with 64 frames and a frame size of 64 by 64 pixels (at 10 frames per second). The movie contains a simulation of a moving target that is moving through a structured background that is itself moving. A jitter motion caused by random vibration is also generated (in a Simulink® model called "aero_vibrati") and the jitter motion is added into the overall sensor motion. Finally, the image is blurred through a Gaussian optical point spread function.

Note: Changing `delt` here also requires a change in the parameters set-up dialog box in the Simulink model "vibration".

```
delt = 0.1;          % Sample time of the generated sequence
num_frames= 64;    % Number of frames to generate
framesize = 64;    % Square frame size in pixels

out = zeros(framesize,framesize,num_frames); % Initialize movie storage as a 3D Array
```

Generate a Target and Define Its Motion

The first stage is to define the shape and motion of the target object. The shape chosen is a large plus sign, and the image is defined by a matrix representing the image intensity at each pixel position. The Target is defined to be traveling from center to bottom right of the image.

```
target = [zeros(3,11)
          zeros(1,5) 6 zeros(1,5)
          zeros(1,5) 6 zeros(1,5)
          zeros(1,3) 6 6 6 6 6 zeros(1,3) % Target is a plus sign 5 by 5 pixels across
          zeros(1,5) 6 zeros(1,5)         % with an intensity of 6 (S/N ratio is ~4).
          zeros(1,5) 6 zeros(1,5)         % The total target image is made on an 11x11 grid to
          zeros(3,11)];                   % allow the image to be interpolated without error.

target_velx = 1; % target velocity in x direction in pixels per second
target_vely = 1; % target velocity in y direction in pixels per second
target_x_initially = framesize/2; % the target is initially in the center of the frame in x
target_y_initially = framesize/2; % and in y

figure(1);
colormap('gray');
image(target*32);
title('Target Image')
```

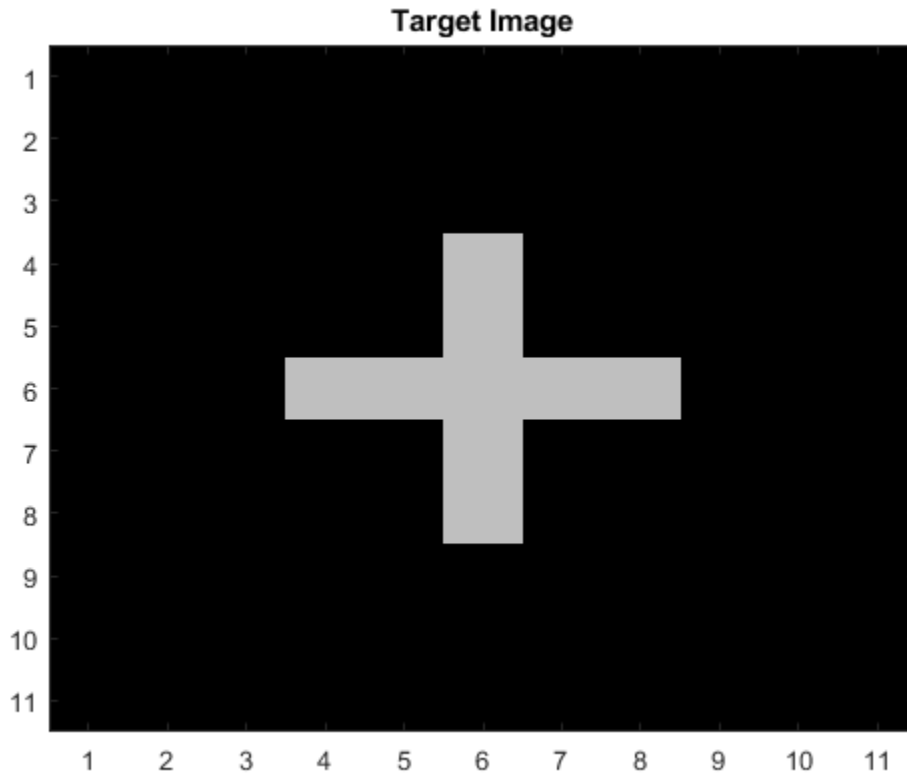

Build Background and Target Composite Image

Generate a sinusoidally correlated background and give it a drift motion. Then, overlay the target onto the background image.

```

backsize = framesize+36; % Make the background bigger than the frame so when it
                        % drifts there are new pixels available to drift into.
xygrid = (1:backsize)/backsize;
B=2*sin(2*pi*xygrid).^2*cos(2*pi*xygrid).^2;

psd = fft2(B);
psd = real(psd.*conj(psd));

background = B + 0.5*randn(backsize); % Add a specular Gaussian white
                                     % sequence to the structure with
                                     % variance of 0.25 (sigma of 0.5).

xoff = 10;
yoff = 10; % Sensor location is offset from the 0,0 of the background
driftx = 1;
drifty = 1; % drift rate of the background in a and y directions pix/sec.

minout = min(min(min(background)));
maxout = max(max(max(background)));
colormap('gray');
image((background-minout)*64/(maxout-minout))
title('Background image with additive white specular noise')

```

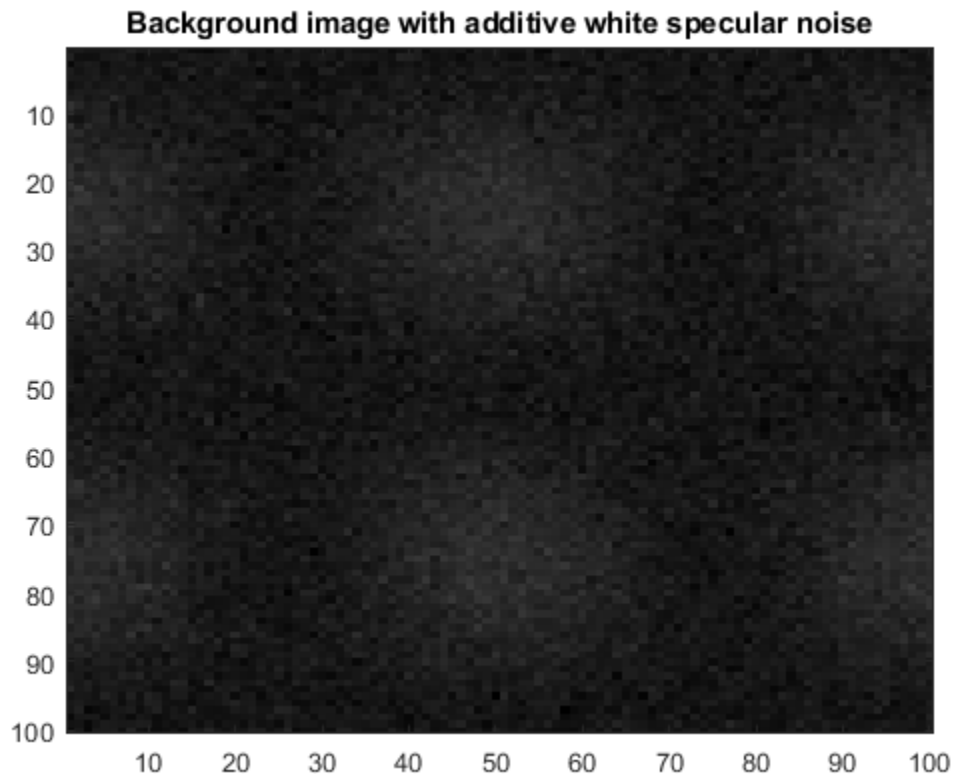

Simulate the Tracker's Rotational Vibration

Rotational vibration of the tracker is simulated using model `aero_vibrati`. The data required to simulate the vibration of the tracker is generated by running the Simulink model "aero_vibrati".

Run Simulink vibration model using `sim` command (Note -- if the `delt` is changed from 0.1 seconds, the Simulink model must be changed also to ensure that the sample time for the vibration match the sample time in this tracker image model).

The resulting random rotations are shown in Figure 1.

```
omega = 2*pi*5;           % The structural frequencies are 5, 10 and 15 Hz in the model.
zeta   = 0.01;           % Damping ratio for all modes

open_system('aero_vibrati')
simout = sim('aero_vibrati', 'SrcWorkspace', 'current');

vibdat = simout.get('vibdat');           % The Simulink model "aero_vibrati"
                                         % generates the vibration data at
                                         % a sample time of 0.01 sec.
vibx   = vibdat(1:10:1000);             % The output of simulation is
                                         % returned as the variable simout
viby   = vibdat(1001:10:2000);          % The variable simout contains
                                         % the in array vibdat that contains
                                         % the vibration data

levarmx = 10; % Rotational lever arm for vibration noise in x
```

```

levarmy = 10; % and in y.

subplot(211);
plot(0.01*(1:10:1000),vibx);grid;
title('Time history of the random Tracker rotations')
xlabel('Time');ylabel('x direction')

subplot(212);
plot(0.01*(1:10:1000),viby);grid;
xlabel('Time');ylabel('y direction')
    
```

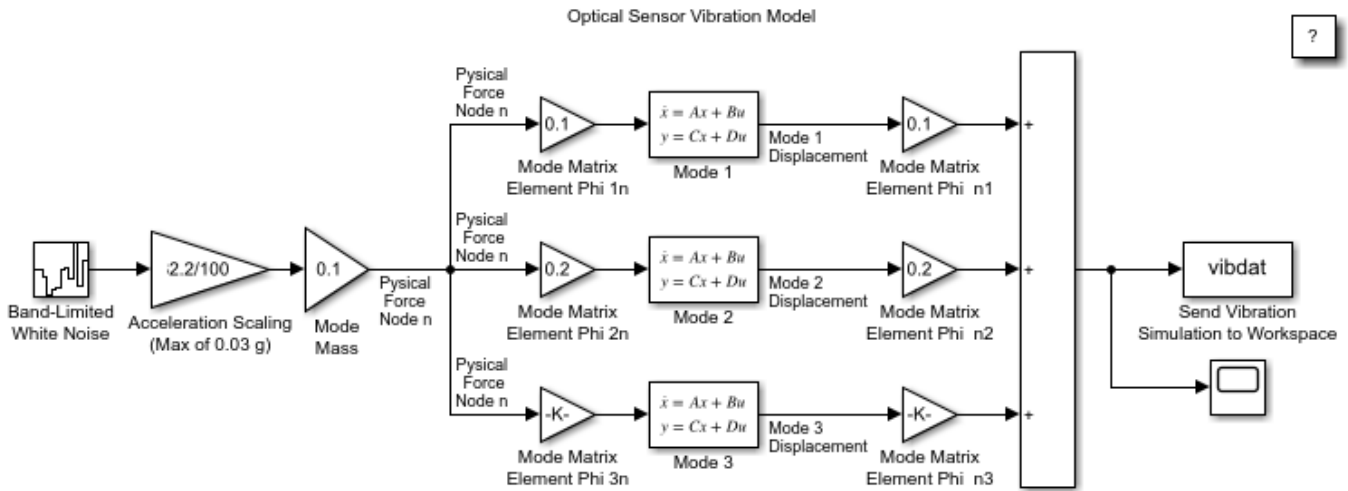

Copyright 1990-2013 The MathWorks, Inc.



Simulate the Motion Effects From the Background, Target, and Jitter

The frames that will make up the movie are now created and stored in a multidimensional array (out). Each frame has the background and target at differing positions due to the target motion, background drift, and tracker vibration. The first frame of the movie will be shown in Figure 1.

```
clf; drawnow;
```

```
for t = 1:num_frames
```

```
    % Drift the Background at the rate driftx and drifty
    % (in pixels/second) and add in the vibration:
    xshift = driftx*delt*t+levarmx*vibx(t,1);
    yshift = drifty*delt*t+levarmy*viby(t,1);
```

```
    % Interpolate the 2D image using the MATLAB(R) function interp2:
    [xgrid, ygrid] = meshgrid(1:backsize);
    [xindex, yindex] = meshgrid(xshift:1:xshift+backsize,yshift:1:yshift+backsize);
    outtemp = interp2(xgrid,ygrid,background,xindex,yindex);
```

```
    % Truncate the drifted image down from backsize to framesize:
    out(:, :, t) = outtemp(xoff:xoff+framesize-1,xoff:xoff+framesize-1);
```

```
    % Now let the target move also:
    tpixinx = floor(target_velx*delt*t);
    tpixiny = floor(target_vely*delt*t); % Before interpolating extract the number of pixels moved
    txi = target_velx*delt*t - tpixinx;
```

```

tyi = target_vely*delt*t - tpixiny; % Interpolate on sub-pixels around the origin only
[txgrid tygrid] = meshgrid(1:11); % meshgrid here generates a matrix of grid elements
[txi tyi] = meshgrid(txi+1:txi+11,tyi+1:tyi+11); % meshgrid generates 2 matrices with the x and y coordinates

% Interpolate the intensity values first using interp2 -- a built in MATLAB command
temp = interp2(txgrid,tygrid,target,txi,tyi);

% Insert the target at the location determined by the initial offset, and the number of whole pixels
tx = tpixinx + target_x_initially-1;
ty = tpixiny + target_y_initially-1;
out(tx:tx+6,ty:ty+6,t) = temp(9:-1:3,9:-1:3) + out(tx:tx+6,ty:ty+6,t);

end

minout = min(min(min(out)));
maxout = max(max(max(out)));
colormap('gray');
image((out(:,:,1)-minout) * 64/(maxout-minout));
title('First frame of combined target and background image.')
```

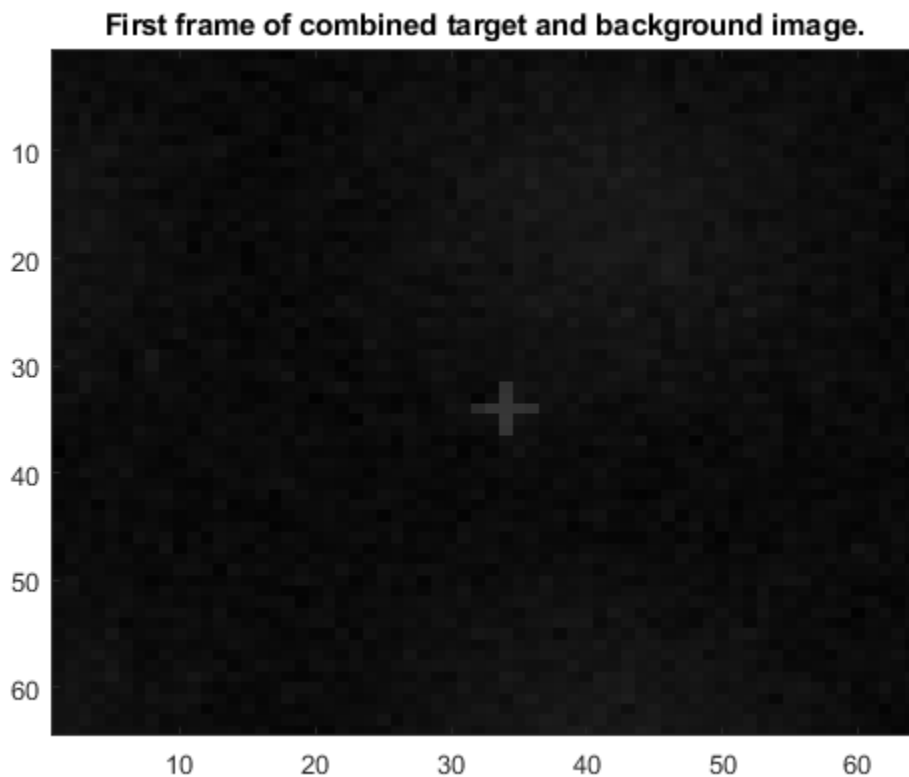

Pass the Images Through Optics -- Use a Gaussian "Aperture Function"

This code segment can use a measured aperture function just as easily - simply replace the next five lines by "load measured_aperture" where measured_aperture is the measured function stored in ASCII and the data stored in the file measured_aperture.mat is a MATLAB® .mat file that contains the matrix apfunction. (in MATLAB type "help load" for how to use load and look at the c and fortran code that shows how to read and write MATLAB .mat files).

(Note: When the Point Spread Function is Gaussian, then so is the Aperture function)

To simulate the effect of the tracker optics, each of the movie frames is now blurred using a 2-D FFT (Fast Fourier Transform). The first frame of the resulting image is shown in Figure 1.

```
x = 1:framesize;
y = 1:framesize;
sigma = 120;
apfunction = exp(-(x-framesize/2).^2/(2*sigma))' * exp(-(y-framesize/2).^2/(2*sigma));
apfunction = fftshift(apfunction); % Rotate so it conforms with FFT convention

for j = 1:num_frames
    out(:,:,j) = real(ifft2(apfunction.*fft2(out(:,:,j))));
end

minout = min(min(min(out)));
maxout = max(max(max(out)));
colormap('gray');
image((out(:,:,1)-minout)*64/(maxout-minout));
title('First frame of blurred image.')
```

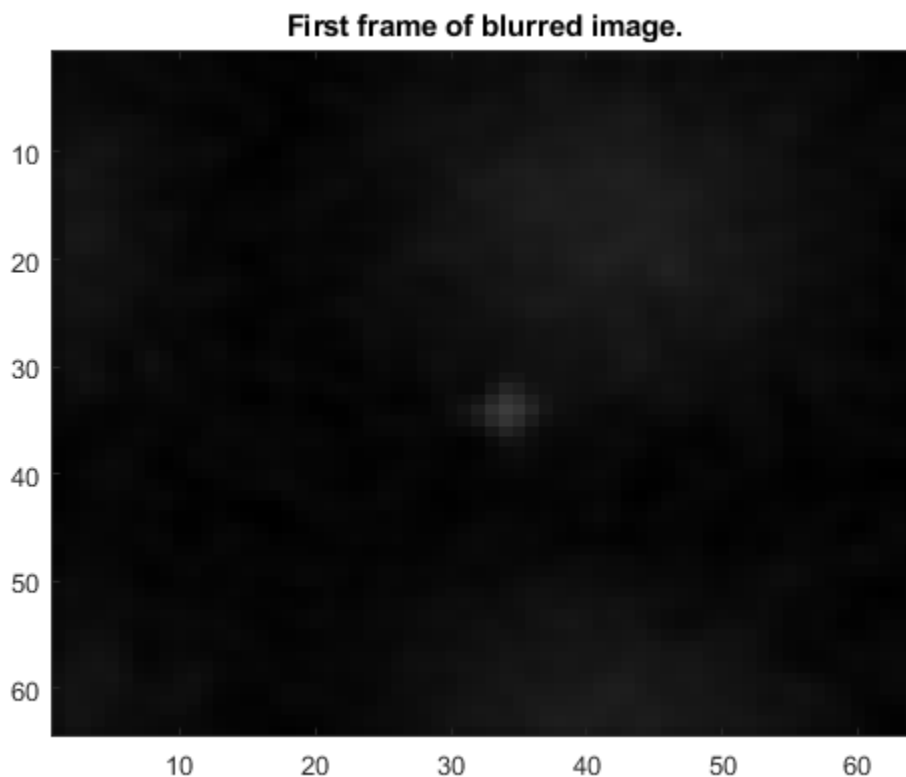

Generate the MATLAB® Movie and Play It Back

Scale the movie frame so that it has 64 intensity values from the min to the max and then show the result as an image. See MATLAB help for how the `moviein` and `getframe` work.

```
minout = min(min(min(out)));
maxout = max(max(max(out)));
```

```
M = moviein(num_frames);  
for j = 1:num_frames  
    image((out(:,:,j)-minout)*64/(maxout-minout))  
    drawnow  
    M(:,j) = getframe;  
end  
  
% colormap('gray')  
% movie(M);
```

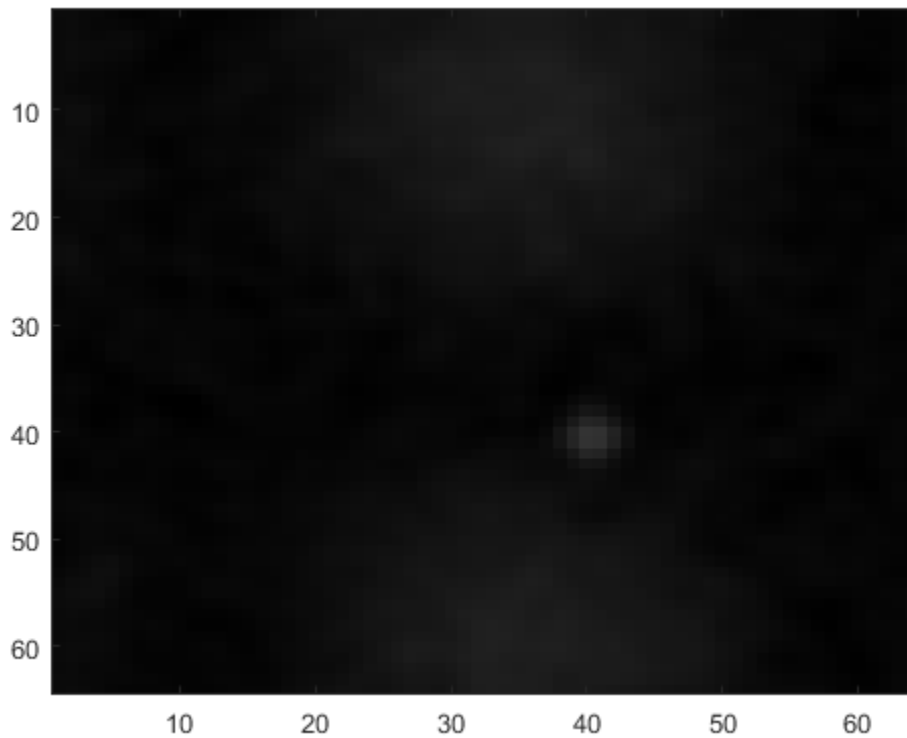

OPTIONAL: Save the Movie in a .mat File

You can optionally save the generated tracker movie in a mat file and also save the psd of the background for later use with the movie.

```
save trackerimage out  
save psdback psd  
save moviedat M
```

```
bdclose('aero_vibrati');
```

See Also

More About

- “Aerospace Blockset”
- “Create Aerospace Models” (Aerospace Blockset)

Air Traffic Control Radar Design

This example shows how to model a conceptual air traffic control (ATC) radar simulation based on the radar range equation.

Model Description

To make parameters for *Radar System Design* easier to change and easier to determine their values, the model has a GUI. Radar and weather parameters may be changed from this GUI. While simulating, the effects of these parameters can be seen on the scope display which shows the actual aircraft range in yellow and the estimated aircraft range from the radar in magenta. Another output that can be viewed is the calculated signal to noise ratio (SNR) is compared to the ideal SNR. Ideal SNR is also specified from the GUI. The result is shown in the display block and will be either 1 (SNR \geq ideal SNR) or 0 (SNR $<$ ideal SNR).

Simulink® and Stateflow® are used in the model, which is divided into three main subsystems, radar, aircraft, and weather.

Using subsystems is helpful in two ways: the model is organized and easier to understand and the work can be split between multiple engineers by subsystems. The Stateflow machine labeled "check SNR" performs the logic comparing calculated SNR to the ideal SNR and output data based on this comparison.

You can run the simulation to determine if the radar can pick up the aircraft by the output on the scope. Using the GUI, the radar and the weather parameters can be altered and will change the range where the aircraft can be "seen".

Open and simulate the `aero_atc` model.

```
open_system('aero_atc');  
sim('aero_atc');
```

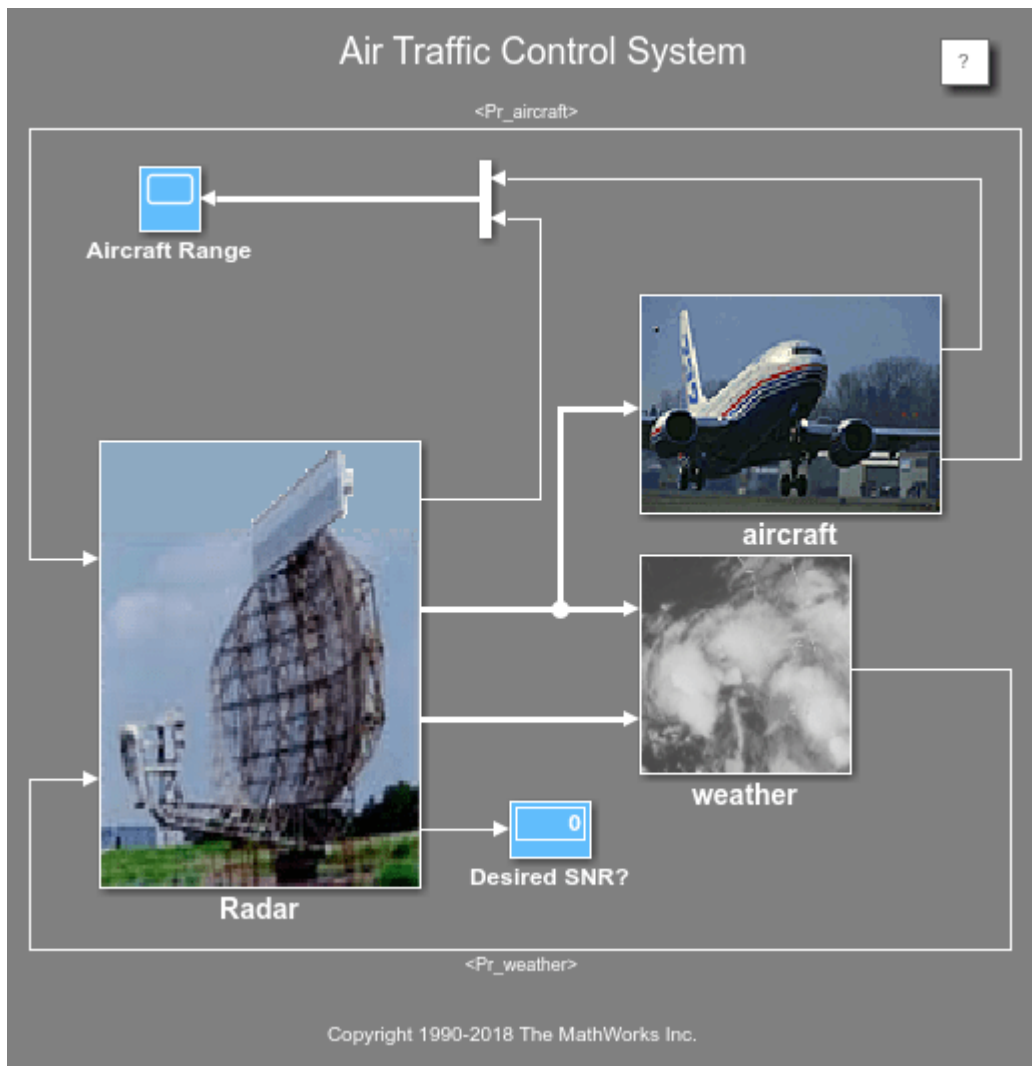

| | |
|--|--------|
| RADAR Band | L Band |
| Wavelength (m) | |
| 0.15 | 0.3 |
| 0.285 | |
| Transmitter Power (kW) | 50 |
| Losses (dB) | 5 |
| Noise Factor (dB) | 5 |
| Antenna Efficiency | 0.7 |
| RADAR Range (N. Mile) | 50 |
| Elev. Separation (N. Mile) | 2 |
| Lat. Separation (N. Mile) | 2 |
| Range Resolution (m) | 150 |
| Bandwidth (Hz) /Pulsewidth | |
| 1.2 | |
| Reliable Detection S/N (dB) | |
| 15 | |
| Working Temperature (deg F) | |
| 15 | |
| Weather Condition | |
| <input type="radio"/> No Precipitation | |
| <input type="radio"/> Drizzle | |
| <input checked="" type="radio"/> Light Precipitation | |
| <input type="radio"/> Moderate Precipitation | |
| <input type="radio"/> Heavy Precipitation | |

```
bdclose('aero_atc')
```

Design Issues

Radar systems are designed for a specific purpose and can very seldom be used for other applications effectively. Each new radar specification requires the computation of new parameter values. When designing a radar for an application, there are a number of parameters which shape the design. Some of these parameters are contained or derived logically from the customer specification. Others are selected arbitrarily using the design engineer's best judgment. This is the first approximate solution for the system design. From here, continual refinement of the design parameters takes place until an optimum design is reached. If any changes occur in the customer specification, it could cause a need to rework the design process over from the beginning. The parametric nature of this design strategy lends itself to automation.

```
aero_atcgui;
```

| | | |
|--|--------|---|
| RADAR Band | L Band | ▼ |
| Wavelength (m) | | |
| 0.15 | ◀ | ▶ |
| 0.285 | | |
| Transmitter Power (kW) | 50 | |
| Losses (dB) | 5 | |
| Noise Factor (dB) | 5 | |
| Antenna Efficiency | 0.7 | |
| RADAR Range (N. Mile) | 50 | |
| Elev. Separation (N. Mile) | 2 | |
| Lat. Separation (N. Mile) | 2 | |
| Range Resolution (m) | 150 | |
| Bandwidth (Hz) /Pulsewidth | | |
| 1.2 | | |
| Reliable Detection S/N (dB) | | |
| 15 | | |
| Working Temperature (deg F) | | |
| 15 | | |
| Weather Condition | | |
| <input type="radio"/> No Precipitation | | |
| <input type="radio"/> Drizzle | | |
| <input checked="" type="radio"/> Light Precipitation | | |
| <input type="radio"/> Moderate Precipitation | | |
| <input type="radio"/> Heavy Precipitation | | |

```
close('Air Traffic RADAR Design Parameters');
```

Design Specification

We're interested in performing conceptual design for a ground-based air traffic control (ATC) radar. Let's take a look at a potential customer specification.

- **Customer Requirements**

- Maximum Range = 50 Nautical Miles
- Lateral Resolution = 2 Nautical Miles
- Range Resolution = 150 meters

- **Logically Derived Parameters**

- Scan Time, Hits per Scan, Receiver Bandwidth, SNR, Antenna Gain, $\text{Power}_{\text{ave}} * \text{Antenna Aperture}$

- **Best-Judgement Parameters**

- Target Cross-Section, Detection Performance, Coverage, Pulse Repetition Frequency, Integration Efficiency, Transmitted Waveform, Receiver Noise Figure, Attenuation, System Losses

- **Additional Concerns**

- Weather

© 1999 The MathWorks, Inc.

This is an example of a customer specification upon which a design process would be based. The customer, possibly the FAA, provides some basic requirements for the radar design leaving a number of parameter selections up to the design engineer.

It should be noted that some of the logically derived parameters depend on assumptions made by the engineer and would need to be recalculated each time the best-judgment parameters are optimized. This problem lends itself well to simulation. By using Simulink and Stateflow, the design engineer has the analysis capability to have time-varying design cases for Monte Carlo test runs, i.e.: aircraft cross-sections and locations, weather cross-sections, and locations.

MathWorks® Products in the Design Process

Here's how MathWorks® products fit the job of conceptual radar design:

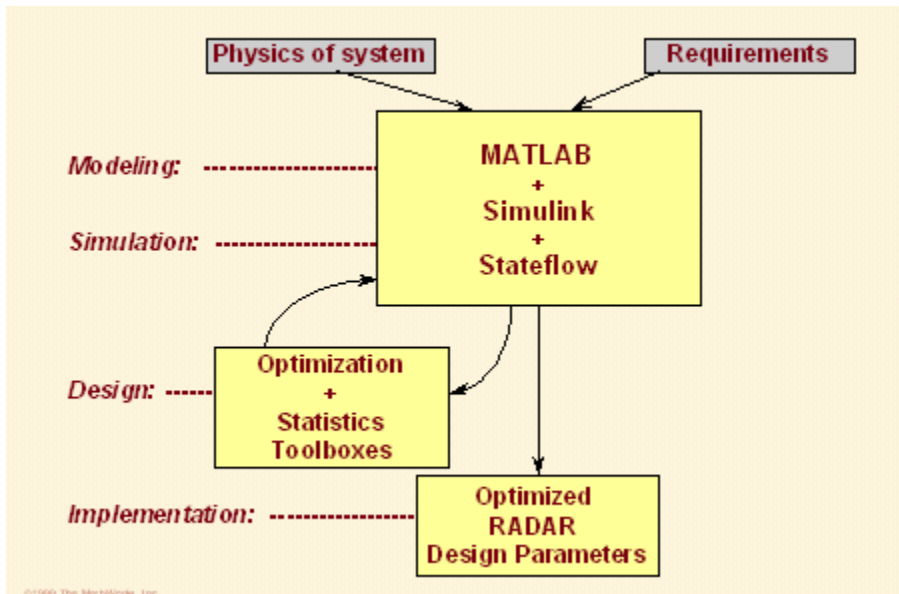

Using the customer specification and the radar range equations along with equations describing the physics of the system, a model is built in MATLAB®, Simulink, and Stateflow. Using the model with the `sim` command for batch runs, those best-judgment parameters can be optimized for various conditions, weather, aircraft, using a Monte Carlo simulation run to prove robustness. The result is a set of optimized radar parameters that can be used to build a detailed block diagram model of the full radar system for further system analysis in Simulink with the DSP System Toolbox™.

See Also

More About

- “Aerospace Blockset”
- “Create Aerospace Models” (Aerospace Blockset)

Designing a Guidance System in MATLAB and Simulink

This example shows how to use the model of the missile airframe presented in a number of published papers (References [1], [2] and [3]) on the use of advanced control methods applied to missile autopilot design. The model represents a tail controlled missile travelling between Mach 2 and Mach 4, at altitudes ranging between 10,000ft (3,050m) and 60,000ft (18,290m), and with typical angles of attack ranging between +/-20 degrees.

Model of the Airframe Dynamics

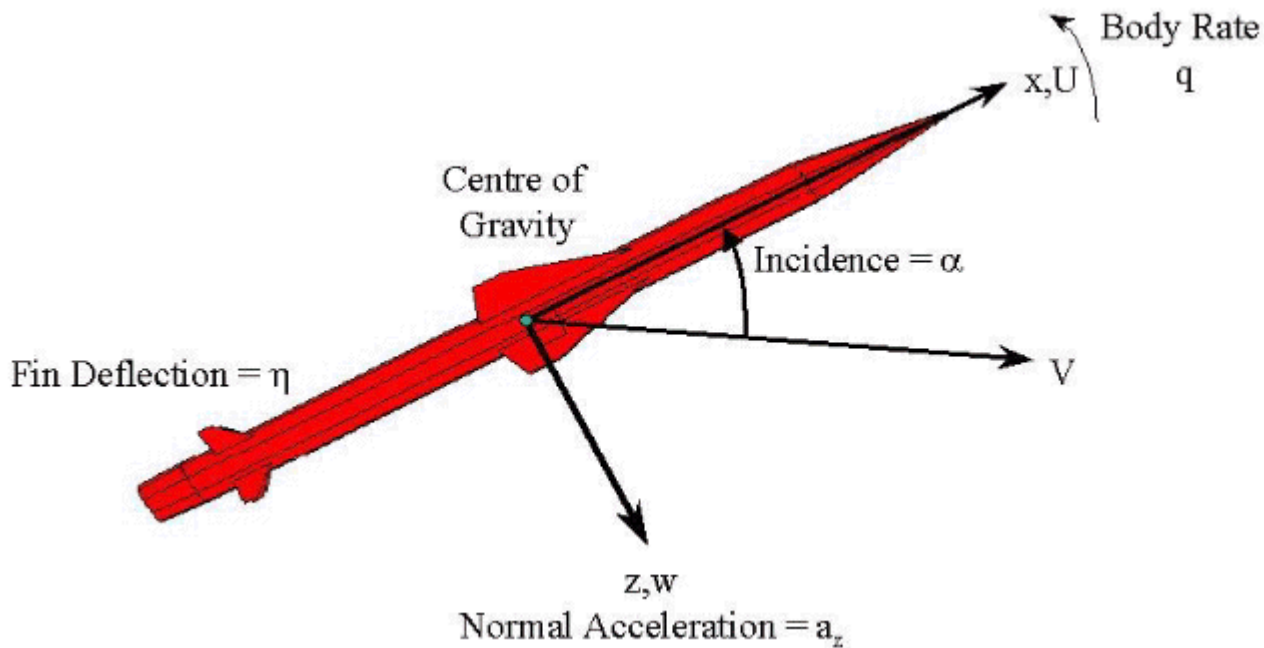

The core element of the model is a nonlinear representation of the rigid body dynamics of the airframe. The aerodynamic forces and moments acting on the missile body are generated from coefficients that are non-linear functions of both incidence and Mach number. The model can be created with Simulink® and the Aerospace Blockset™. The aim of this blockset is to provide reference components, such as atmosphere models, which will be common to all models irrespective of the airframe configuration. Simplified versions of the components available in the Aerospace Blockset are included with these examples to give you a sense of the potential for reuse available from standard block libraries.

Open the model.

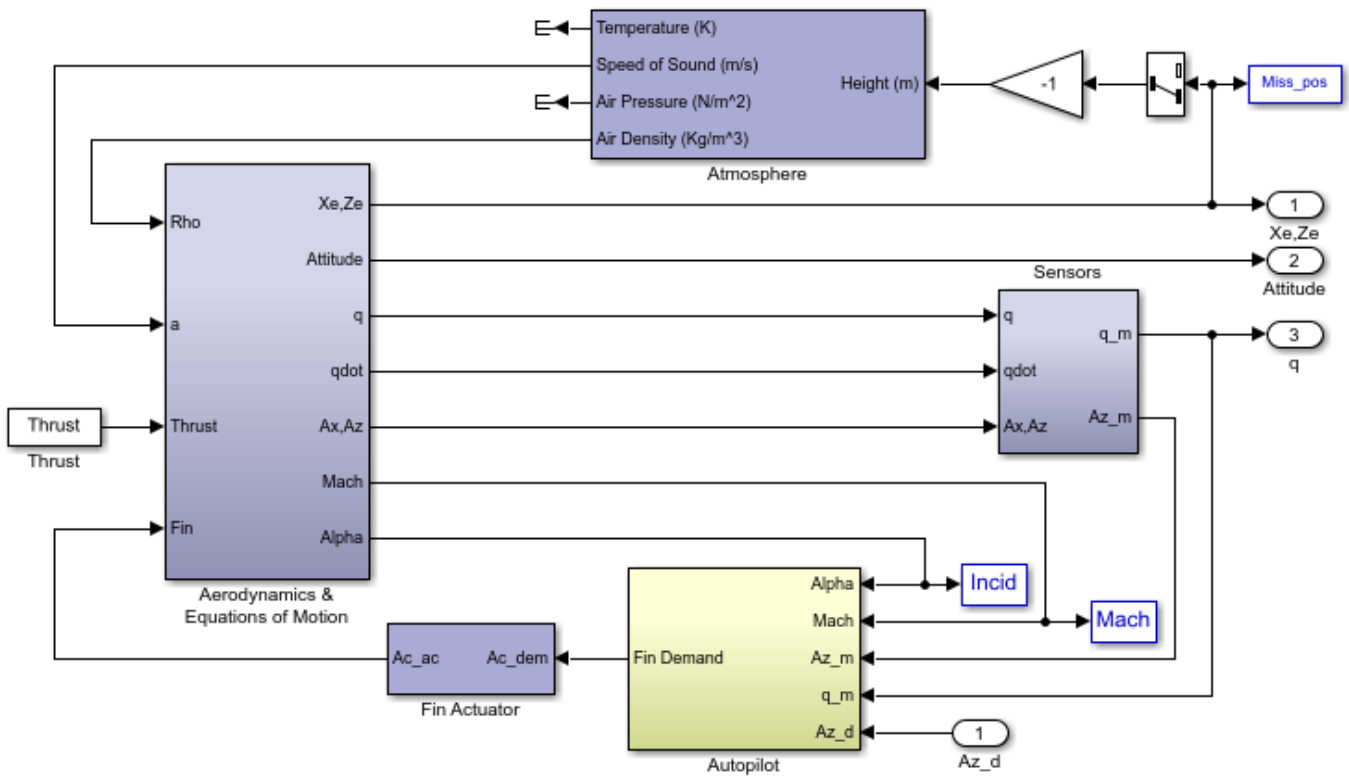

International Standard Atmosphere Model

$$\text{Troposphere Model} = \begin{cases} T = T_0 - Lh \\ \rho = \rho_0 \left(\frac{T}{T_0} \right)^{(g/LR)-1} \\ P = P_0 \left(\frac{T}{T_0} \right)^{(g/LR)} \\ a = \sqrt{\gamma RT} \end{cases}$$

T_0 = Absolute temperature at mean sea level [K]

ρ_0 = Air density at mean sea level [Kg/m³]

P_0 = Static pressure at mean sea level [N/m²]

h = Altitude [m]

T = Temperature at altitude h

ρ = Air density at altitude h

P = Static pressure at altitude h

a = Speed of sound at altitude h

L = Lapse rate [K/m]

R = Characteristic gas constant [J/Kg/K]

g = Acceleration due to gravity [m/s²]

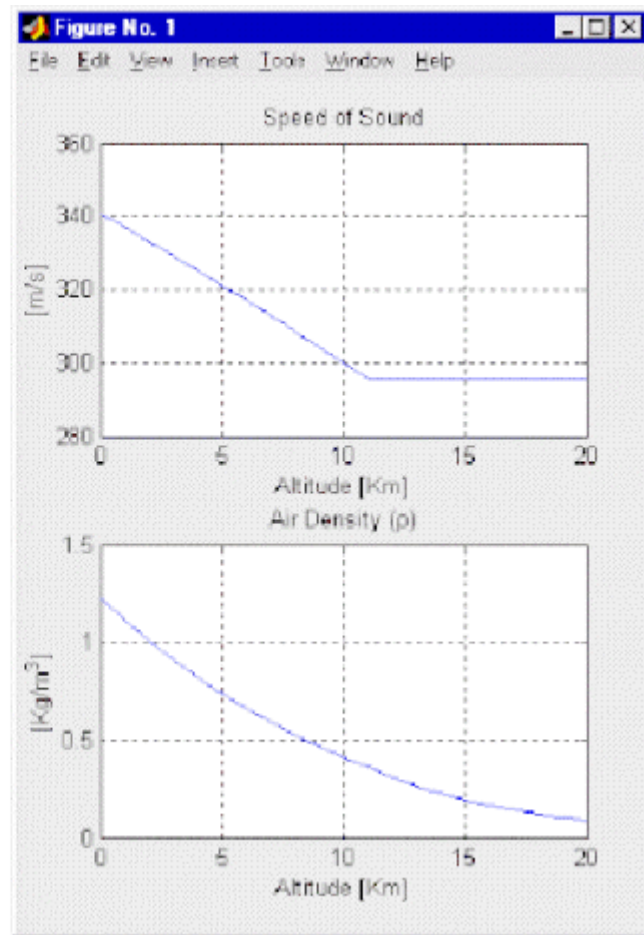

The Atmosphere Subsystem that is used is an approximation to the International Standard Atmosphere, and is split into two separate regions. The troposphere region lies between sea level and 11Km, and in this region there is assumed to be a linear temperature drop with changing altitude. Above the troposphere lies the lower stratosphere region ranging between 11Km and 20Km. In this region the temperature is assumed to remain constant.

Aerodynamic Coefficients for Constructing Forces and Moments

The Aerodynamics & Equations of Motion Subsystem generates the forces and moments applied to the missile in body axes, and integrates the equations of motion which define the linear and angular motion of the airframe.

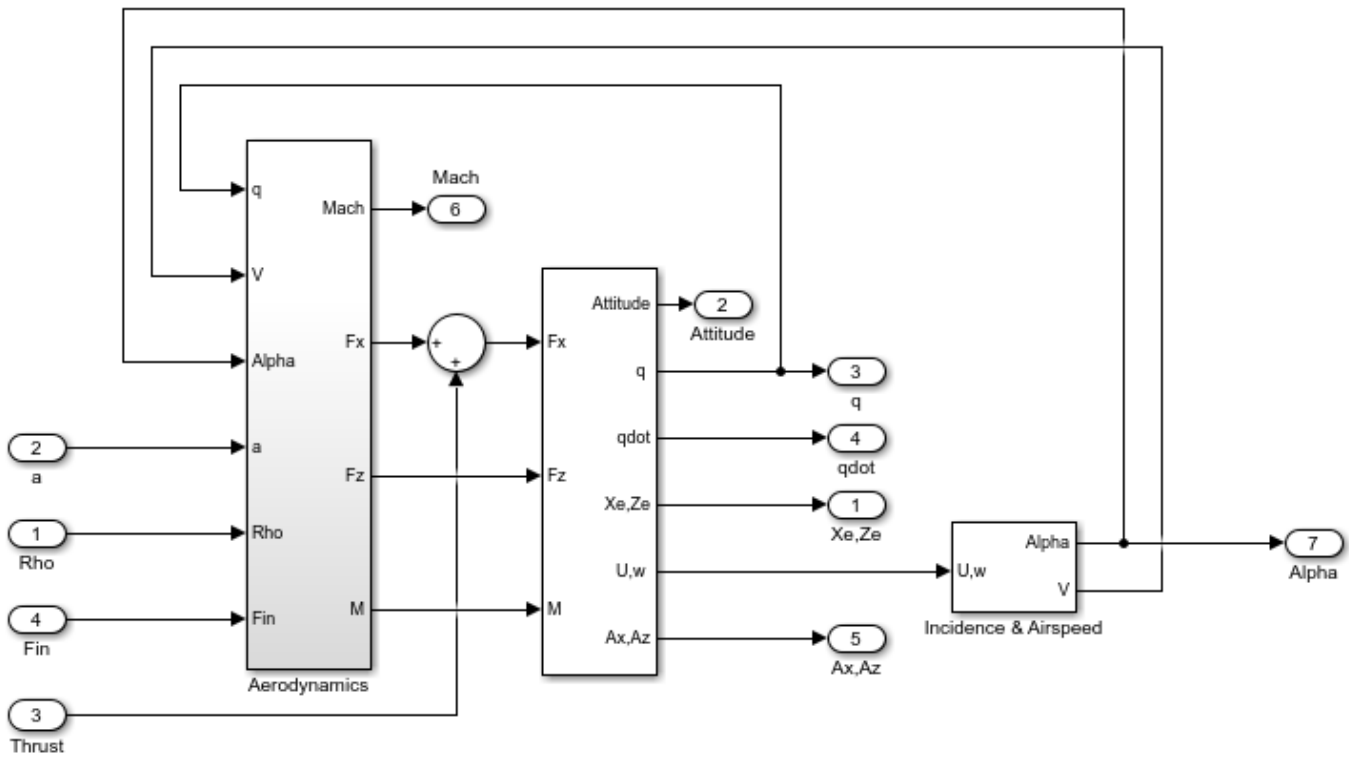

The aerodynamic coefficients are stored in datasets, and during the simulation the value at the current operating condition is determined by interpolation using 2-D lookup table blocks.

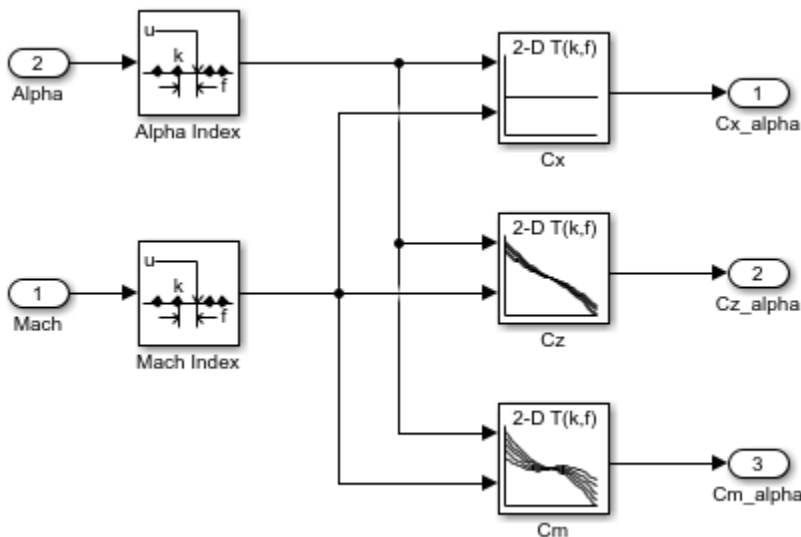

Classical Three Loop Autopilot Design

The aim of the missile autopilot is to control acceleration normal to the missile body. In this example the autopilot structure is a three loop design using measurements from an accelerometer placed

ahead of the center of gravity, and a rate gyro to provide additional damping. The controller gains are scheduled on incidence and Mach number, and are tuned for robust performance at an altitude of 10,000 ft.

To design the autopilot using classical design techniques requires that linear models of the airframe pitch dynamics be derived about a number of trimmed flight conditions. MATLAB® can determine the trim conditions, and derive linear state space models directly from the non-linear Simulink model, saving both time, and aiding in the validation of the model that has been created. The functions provided by the MATLAB Control System Toolbox™ and Simulink® Control Design™ allow the designer to visualize the behavior of the airframe open loop frequency (or time) responses. To see how to trim and linearize the airframe model you can run the companion example, "Airframe Trim and Linearize".

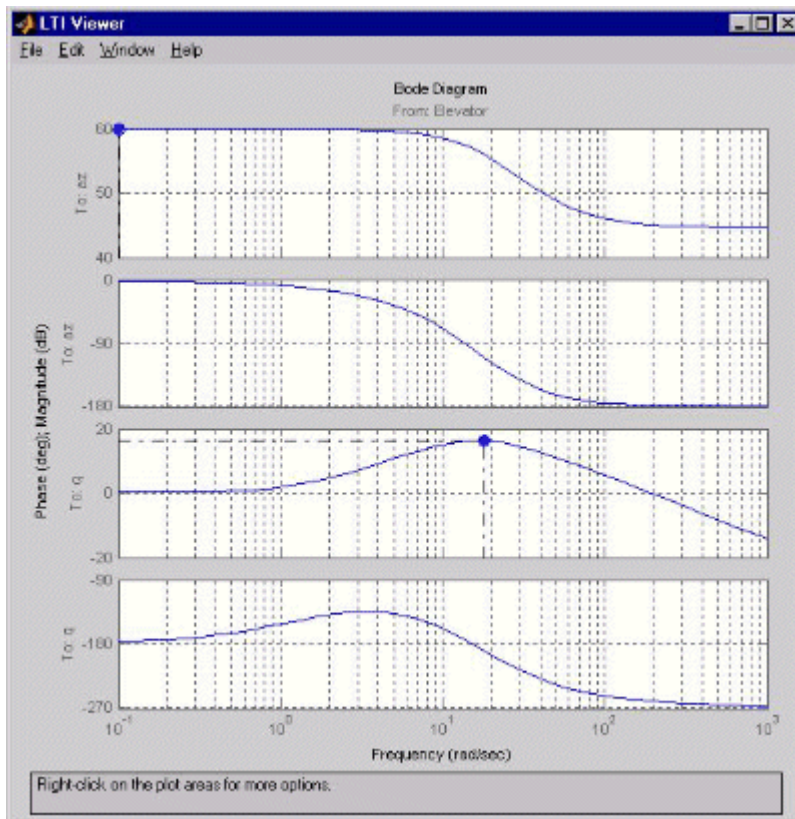

Airframe Frequency Response

Autopilot designs are carried out on a number of linear airframe models derived at varying flight conditions across the expected flight envelope. To implement the autopilot in the non-linear model involves storing the autopilot gains in 2 dimensional lookup tables, and incorporating an anti-windup gain to prevent integrator windup when the fin demands exceed the maximum limits. Testing the autopilot in the nonlinear Simulink model is then the best way to show satisfactory performance in the presence of non-linearities such as actuator fin and rate limits, and with the gains now dynamically varying with changing flight condition.

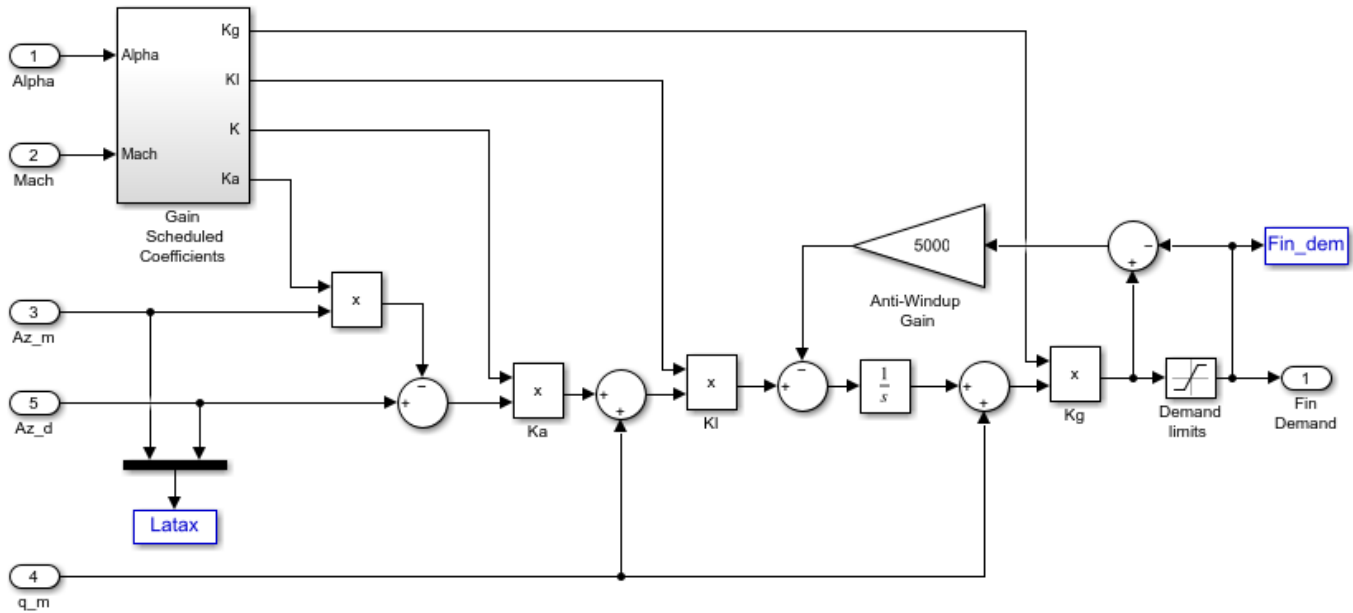
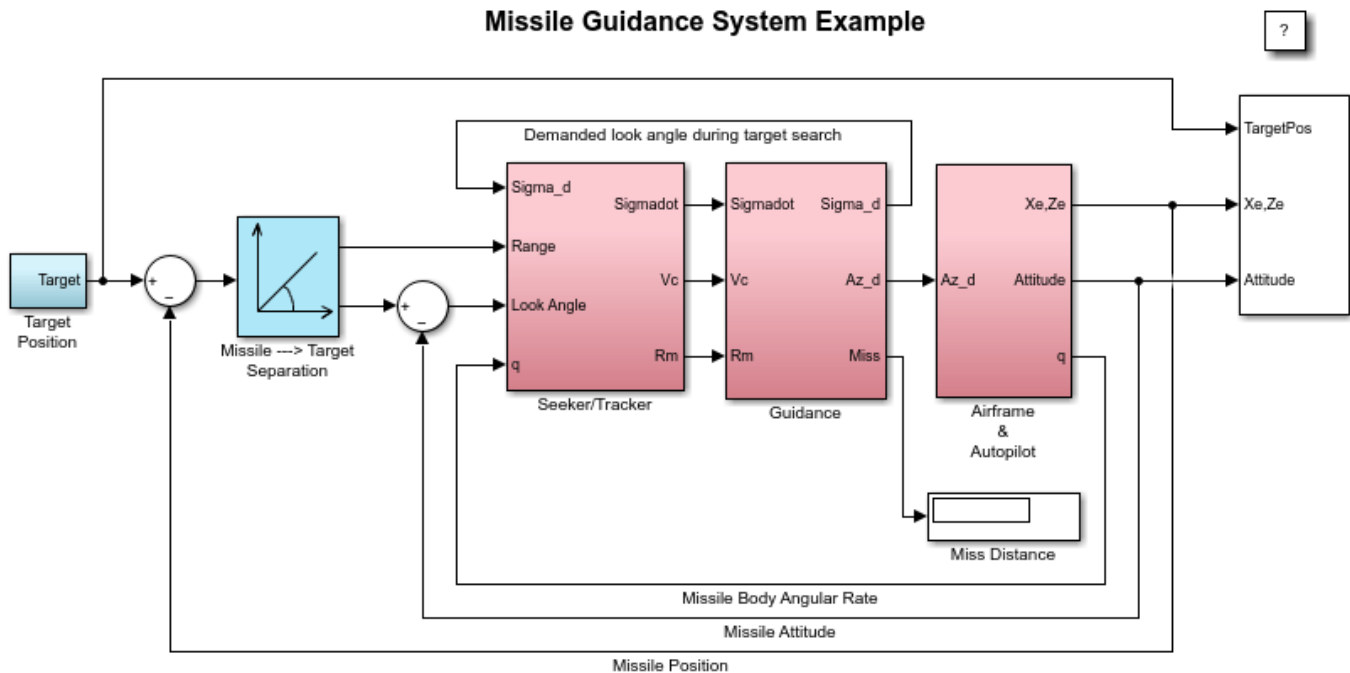

Figure: Simulink implementation of gain scheduled autopilot

Homing Guidance Loop

The complete Homing Guidance Loop consists of a Seeker/Tracker Subsystem which returns measurements of the relative motion between the missile and target, and the Guidance Subsystem which generates normal acceleration demands which are passed to the autopilot. The autopilot is now part of an inner loop within the overall homing guidance system. Reference [4] provides information on the differing forms of guidance that are currently in use, and provides background information on the analysis techniques that are used to quantify guidance loop performance.



Guidance Subsystem

The function of the Guidance subsystem is to not only generate demands during closed loop tracking, but also perform an initial search to locate the target position. A Stateflow® model is used to control the transfer between these differing modes of operation. Switching between modes is triggered by events generated either in Simulink, or internal to the Stateflow model. Controlling the way the Simulink model then behaves is achieved by changing the value of the variable **Mode** that is passed out to Simulink. This variable is used to switch between the differing control demands that can be generated. During target search the Stateflow model controls the tracker directly by sending demands to the seeker gimbals (**Sigma**). Target acquisition is flagged by the tracker once the target lies within the beamwidth of the seeker (**Acquire**), and after a short delay closed loop guidance starts. Stateflow is an ideal tool for rapidly defining all the operational modes, whether they are for normal operation, or unusual situations. For example, the actions to be taken should there be loss of lock on the target, or should a target not be acquired during target search are catered for in this Stateflow diagram.

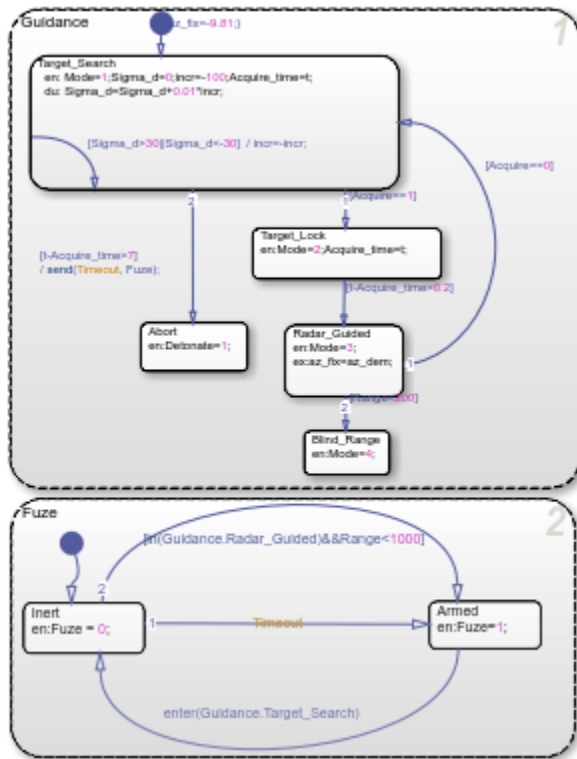

Proportional Navigation Guidance

Once the seeker has acquired the target a Proportional Navigation Guidance (PNG) law is used to guide the missile until impact. This form of guidance law has been used in guided missiles since the 1950s, and can be applied to radar, infrared or television guided missiles. The navigation law requires measurements of the closing velocity between the missile and target, which for a radar guided missile could be obtained using a Doppler tracking device, and an estimate for the rate of change of the inertial sightline angle.

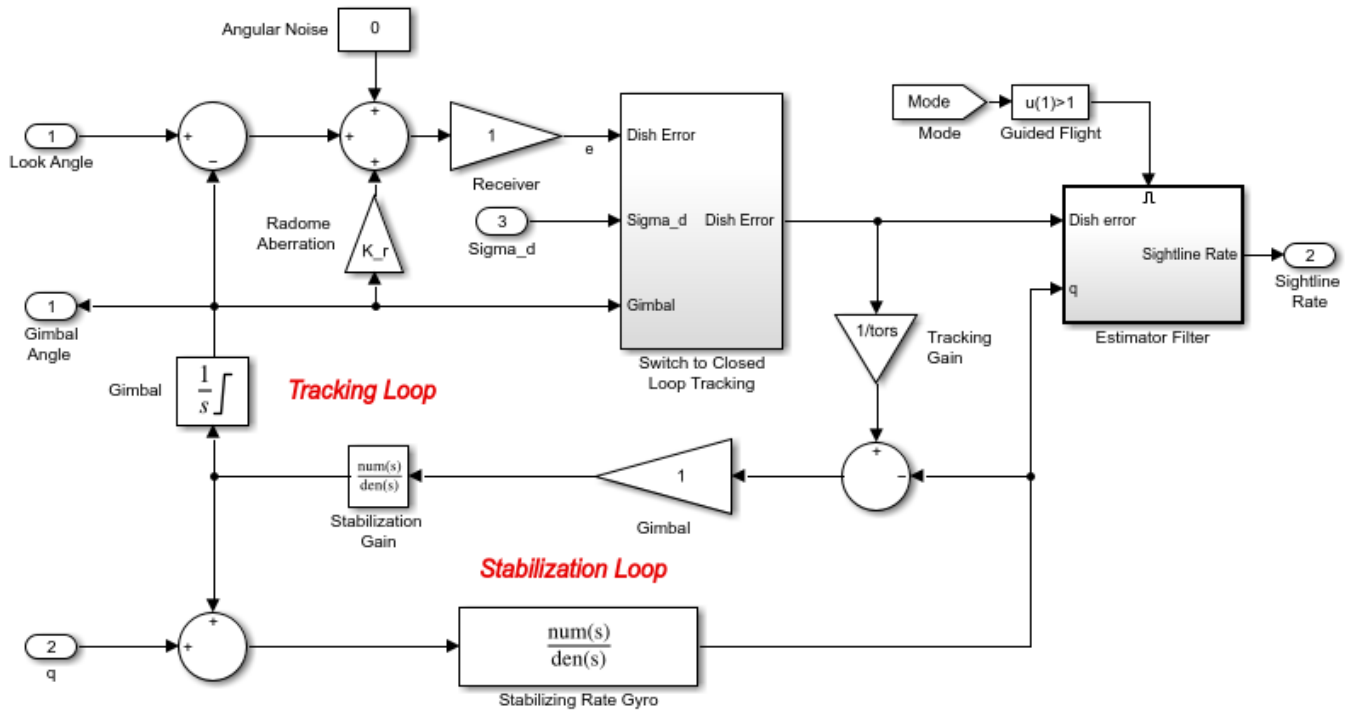

Radome Aberration

For radar guided missiles a parasitic feedback effect that is commonly modelled is that of radome aberration. It occurs because the shape of the protective covering over the seeker distorts the returning signal, and then gives a false reading of the look angle to the target. Generally the amount of distortion is a nonlinear function of the current gimbal angle, but a commonly used approximation is to assume a linear relationship between the gimbal angle and the magnitude of the distortion. In the above system, the radome aberration is accounted for in the gain block labeled "Radome Aberration". Other parasitic effects, such as sensitivity in the rate gyros to normal acceleration, are also often modelled to test the robustness of the target tracker and estimator filters.

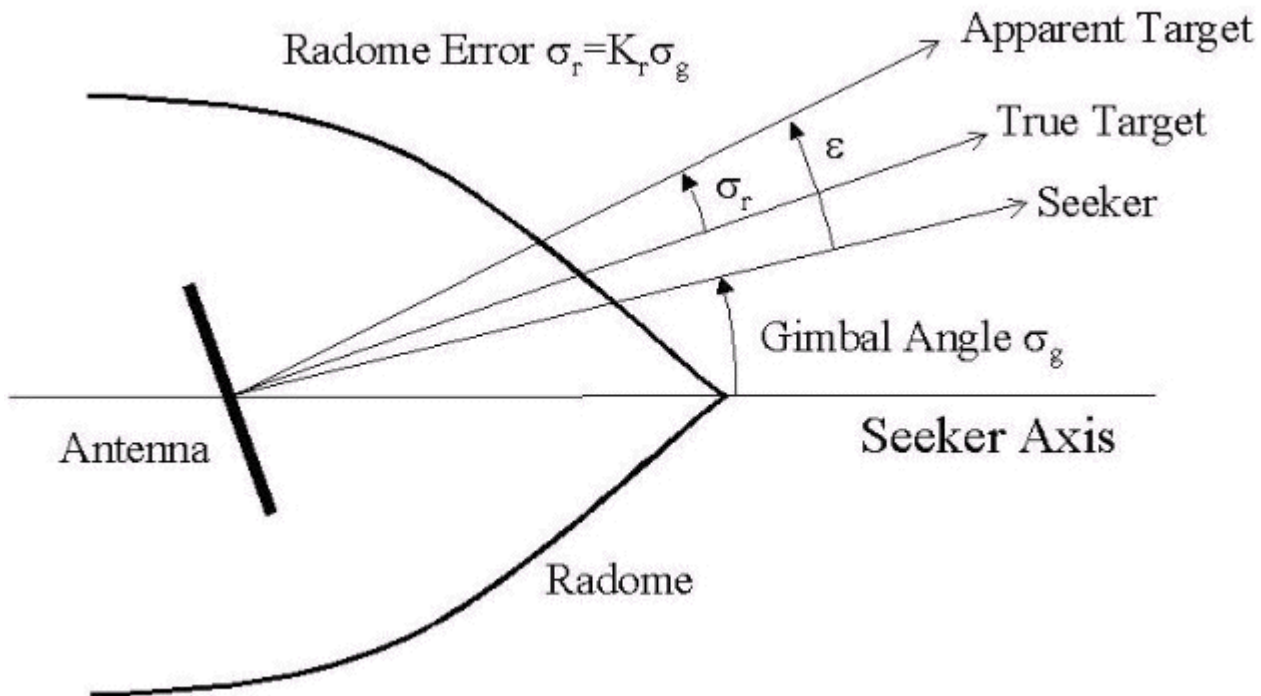

Figure: Radome aberration geometry

Running the Guidance Simulation

Now to show the performance of the overall system. In this case the target is defined to be travelling at a constant speed of 328m/s, on a reciprocal course to the initial missile heading, and 500m above the initial missile position. From the simulation results it can be determined that acquisition occurred 0.69 seconds into the engagement, with closed loop guidance starting after 0.89 seconds. Impact with the target occurred at 3.46 seconds, and the range to go at the point of closest approach was calculated to be 0.265m.

The `aero_guid_plot.m` script creates a performance analysis

Missile Guidance System Example

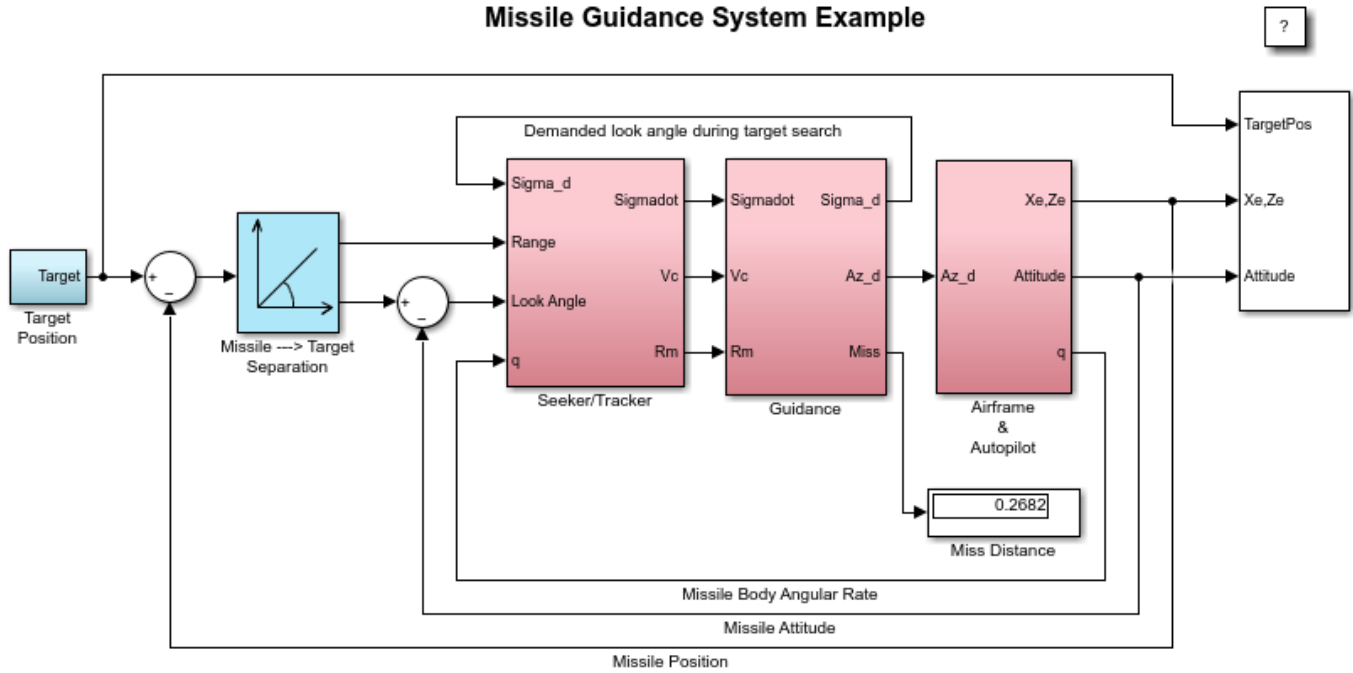

Copyright 1990-2014 The MathWorks, Inc.

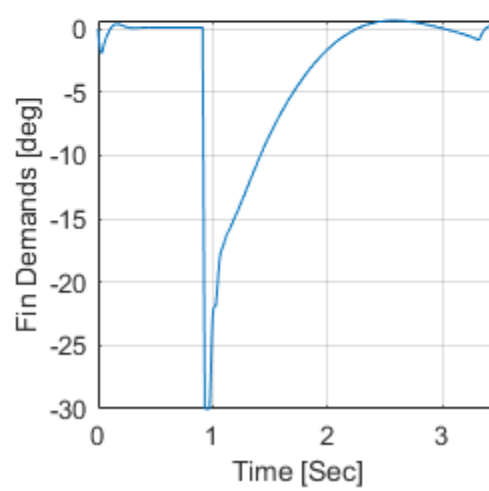
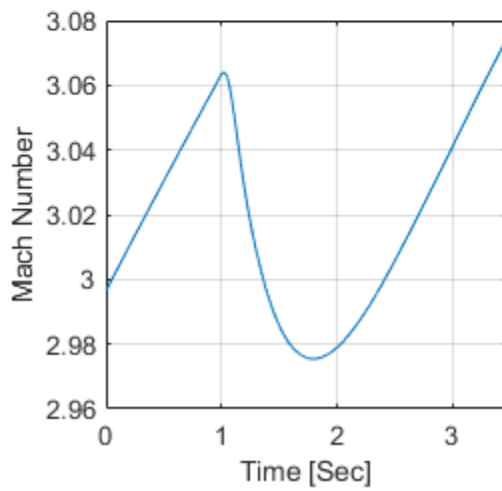
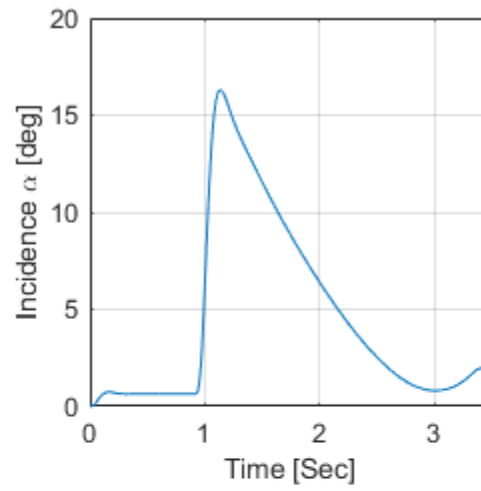
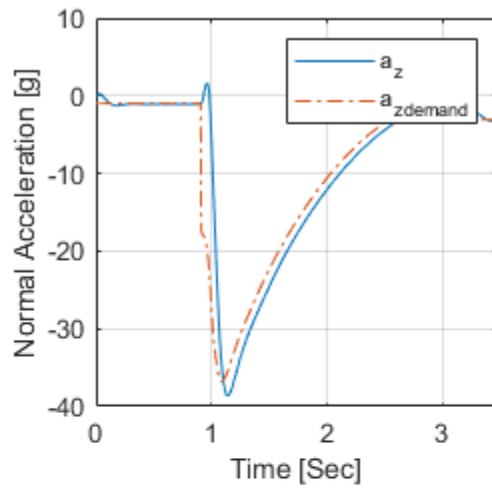

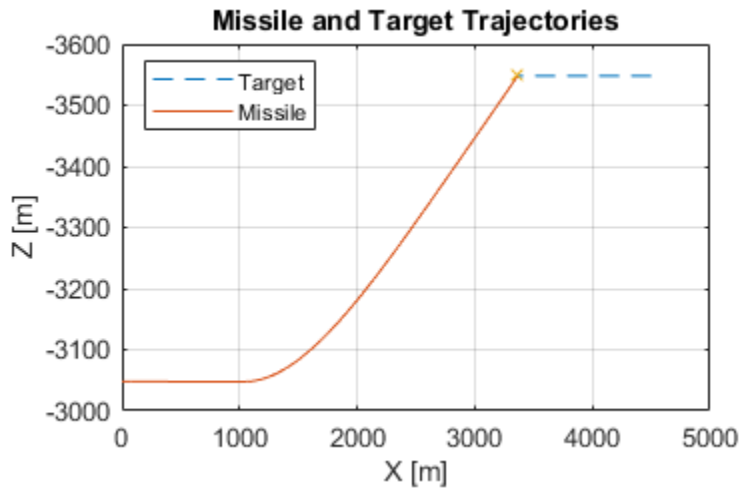
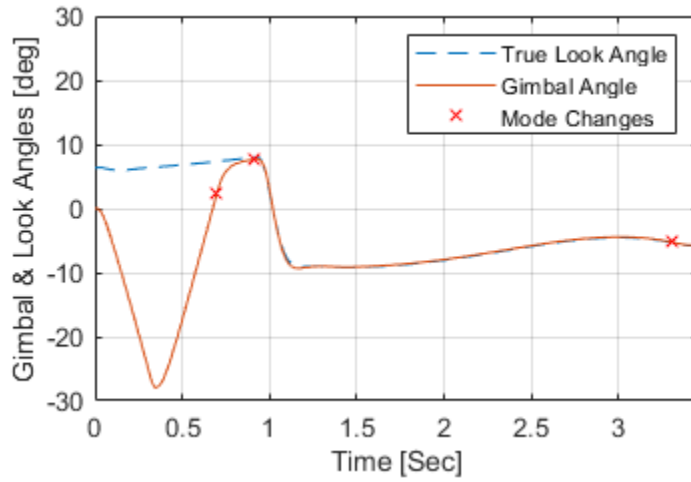

The animation block provides a visual reference for the simulation

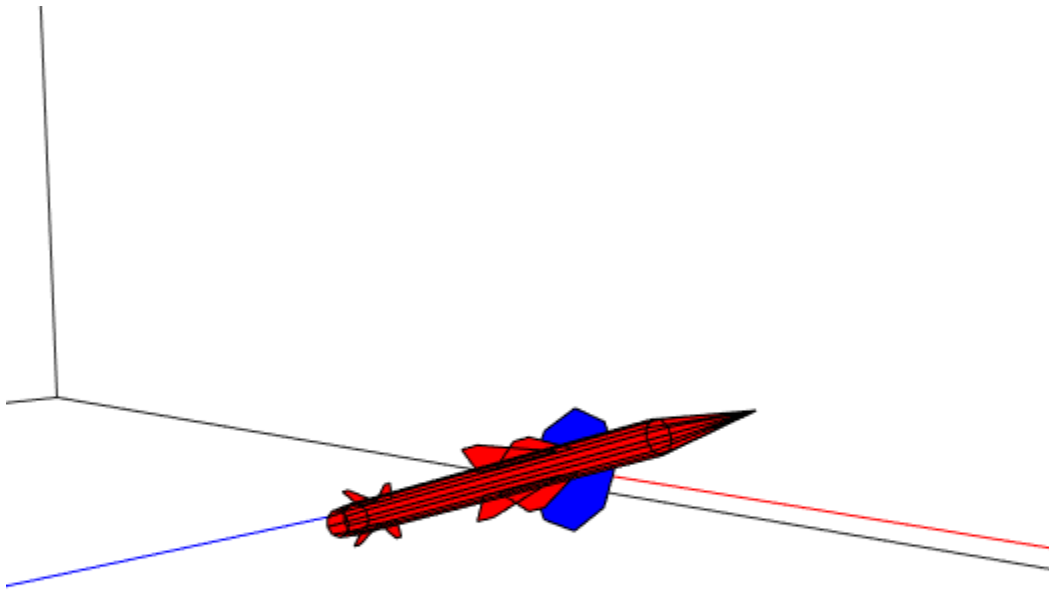

References

1. "Robust LPV control with bounded parameter rates", S.Bennani, D.M.C. Willemsen, C.W. Scherer, AIAA-97-3641, August 1997.
2. "Full Envelope Missile Longitudinal Autopilot Design using the State-Dependent Riccati Equation Method", C.P.Mracek and J.R. Cloutier, AIAA-97-3767, August 1997.
3. "Gain-Scheduled Missile Autopilot Design Using Linear Parameter Varying Transformations", J.S.Shamma, J.R. Cloutier, Journal of Guidance, Control and Dynamics, Vol. 16, No. 2, March-April 1993.
4. "Modern Navigation, Guidance, and Control Processing Volume 2", Ching-Fang Lin, ISBN 0-13-596230-7, Prentice Hall, 1991.

See Also

More About

- "Aerospace Blockset"
- "Create Aerospace Models" (Aerospace Blockset)

Airframe Trim and Linearize

This example shows how to trim and linearize an airframe using Simulink® Control Design™

Designing an autopilot using classical design techniques requires linear models of the airframe pitch dynamics for a number of trimmed flight conditions. MATLAB® can determine the trim conditions and derive linear state-space models directly from the nonlinear Simulink® and Aerospace Blockset™ model. This saves time and helps to validate the model. The functions provided by Simulink Control Design allow you to visualize the behavior of the airframe in terms of open-loop frequency (or time) responses.

Initialize Guidance Model

The first problem is to find the elevator deflection, and the resulting trimmed body rate (q), which will generate a given incidence value when the missile is travelling at a set speed. Once the trim condition is found, a linear model can be derived for the dynamics of the perturbations in the states around the trim condition.

```
open_system('aero_guidance_airframe');
```

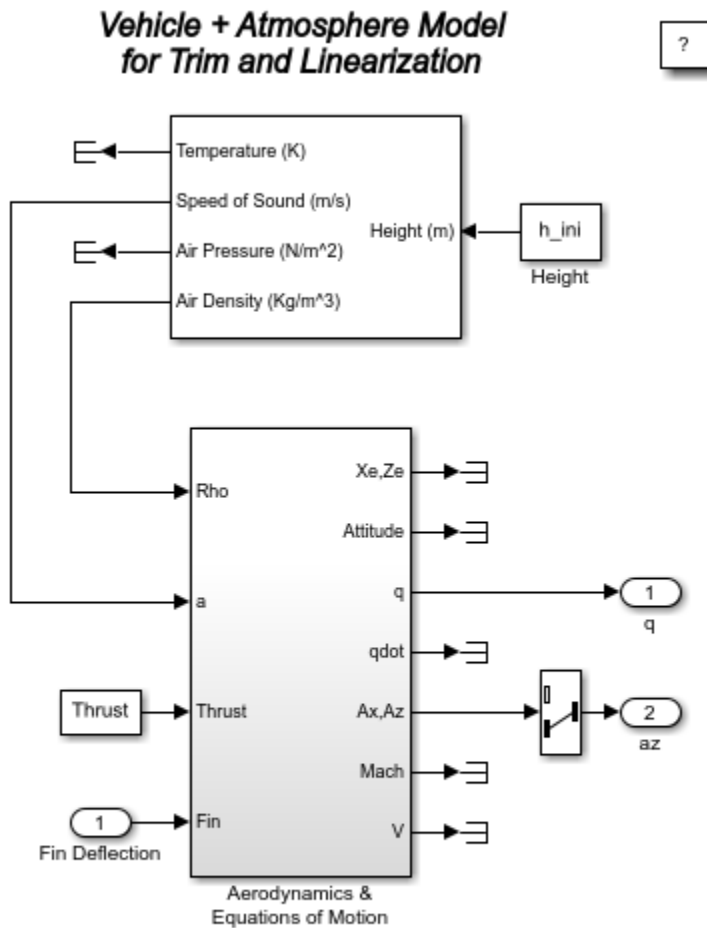

Define State Values

```

h_ini    = 10000/m2ft;      % Trim Height [m]
M_ini    = 3;               % Trim Mach Number
alpha_ini = -10*d2r;       % Trim Incidence [rad]
theta_ini = 0*d2r;         % Trim Flightpath Angle [rad]
v_ini    = M_ini*(340+(295-340)*h_ini/11000); % Total Velocity [m/s]

q_ini    = 0;               % Initial pitch Body Rate [rad/sec]

```

Set Operating Point and State Specifications

The first state specifications are Position states, the second state specification is Theta. Both are known, but not at steady state. The third state specifications are body axis angular rates of which the variable w is at steady state.

```

opspec = operspec('aero_guidance_airframe');
opspec.States(1).Known = [1;1];
opspec.States(1).SteadyState = [0;0];
opspec.States(2).Known = 1;

```

```
opspec.States(2).SteadyState = 0;
opspec.States(3).Known = [1 1];
opspec.States(3).SteadyState = [0 1];
```

Search for Operating Point, Set I/O, then Linearize

```
op = findop('aero_guidance_airframe',opspec);

io(1) = linio('aero_guidance_airframe/Fin Deflection',1,'input');
io(2) = linio('aero_guidance_airframe/Selector',1,'output');
io(3) = linio(sprintf(['aero_guidance_airframe/Aerodynamics &\n', ...
    'Equations of Motion']),3,'output');

sys = linearize('aero_guidance_airframe',op,io);
```

Operating point search report:

opreport =

Operating point search report for the Model aero_guidance_airframe.
(Time-Varying Components Evaluated at time t=0)

Operating point specifications were successfully met.

States:

| | Min | x | Max | | |
|--|---------|----------|---------|------|------------|
| | _____ | _____ | _____ | | _____ |
| (1.) aero_guidance_airframe/Aerodynamics & Equations of Motion/ Equations of Motion (Body Axes)/ | 0 | 0 | 0 | -Inf | 967.66 |
| | -3048 | -3048 | -3048 | -Inf | -170.63 |
| (2.) aero_guidance_airframe/Aerodynamics & Equations of Motion/ Equations of Motion (Body Axes)/ | 0 | 0 | 0 | -Inf | -0.21604 |
| | 967.66 | 967.66 | 967.66 | -Inf | -14.098 |
| | -170.63 | -170.63 | -170.63 | 0 | -7.439e-08 |
| (4.) aero_guidance_airframe/Aerodynamics & Equations of Motion/ Equations of Motion (Body Axes)/ | -Inf | -0.21604 | Inf | 0 | 3.3582e-08 |
| | | | | 0 | 0 |

Inputs:

| | Min | u | Max |
|--|------|---------|-----|
| | ___ | _____ | ___ |
| (1.) aero_guidance_airframe/Fin Deflection | -Inf | 0.13615 | Inf |

Outputs:

| | Min | y | Max |
|-------------------------------|------|----------|-----|
| | ___ | _____ | ___ |
| (1.) aero_guidance_airframe/q | -Inf | -0.21604 | Inf |

```
(2.) aero_guidance_airframe/az
    -Inf      199.25      Inf
```

Select Trimmed States, Create LTI Object, and Plot Bode Response

```
airframe = ss(sys.A(3:4,3:4),sys.B(3:4,:),sys.C(:,3:4),sys.D);

set(airframe,'inputname',{'Elevator'}, ...
     'outputname',[{ 'az' } { 'q' }]);

ltiview('bode',airframe);

bdclose('aero_guidance_airframe');
```

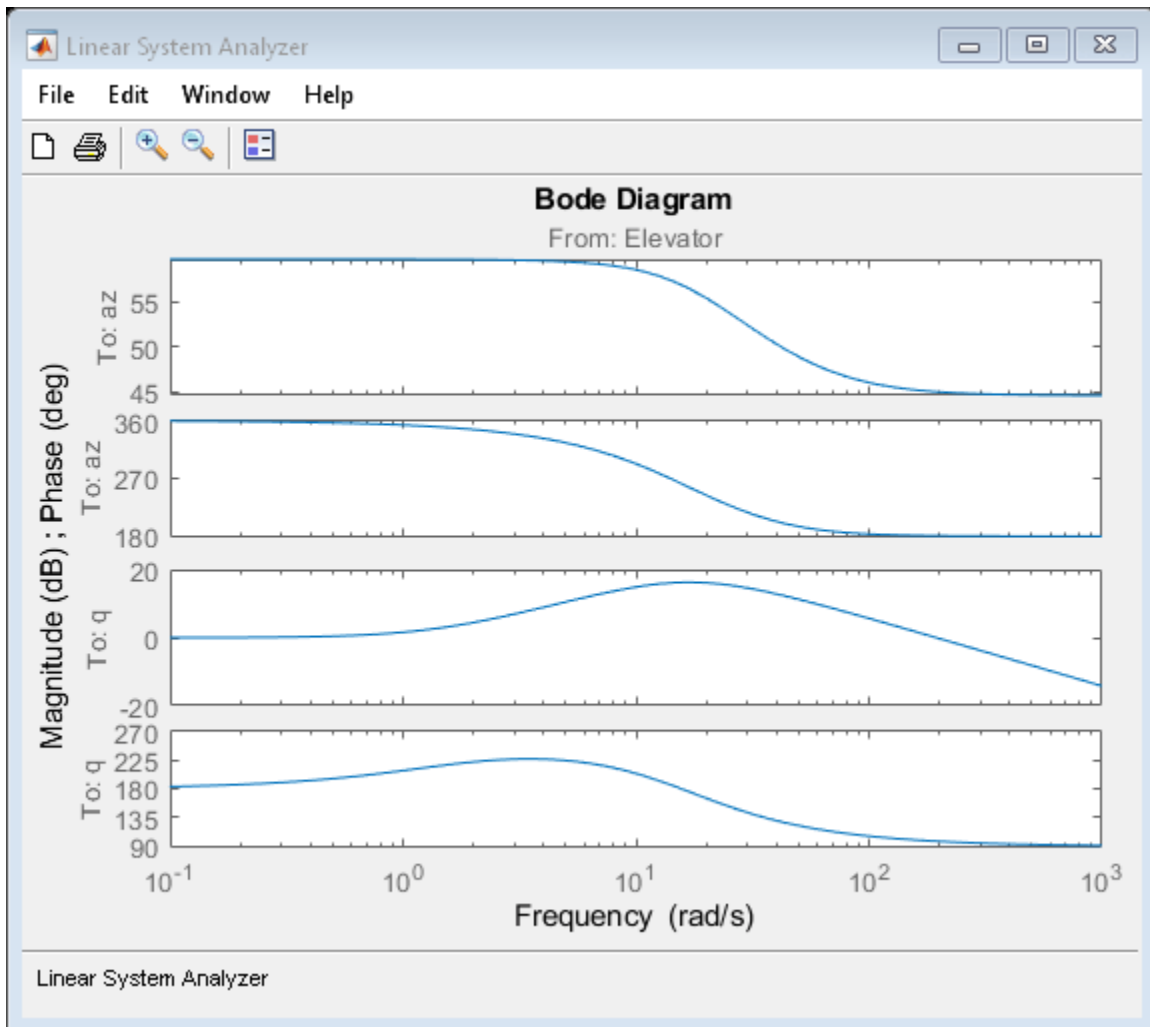

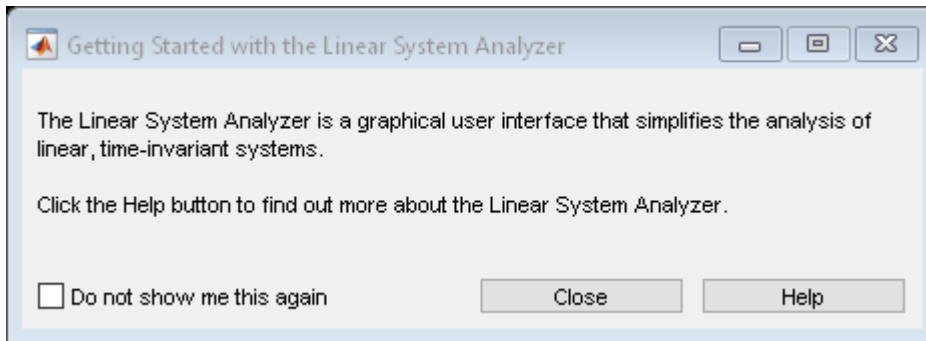

See Also

More About

- "Aerospace Blockset"
- "Create Aerospace Models" (Aerospace Blockset)

Anti-Windup Control Using a PID Controller

Model Description

This example shows how to use anti-windup schemes to prevent integration wind-up in PID controllers when the actuators are saturated. We use the PID Controller block in Simulink® which features two built-in anti-windup methods, back-calculation and clamping, as well as a tracking mode to handle more complex scenarios.

The plant to be controlled is a saturated first-order process with dead-time.

We start by opening the model.

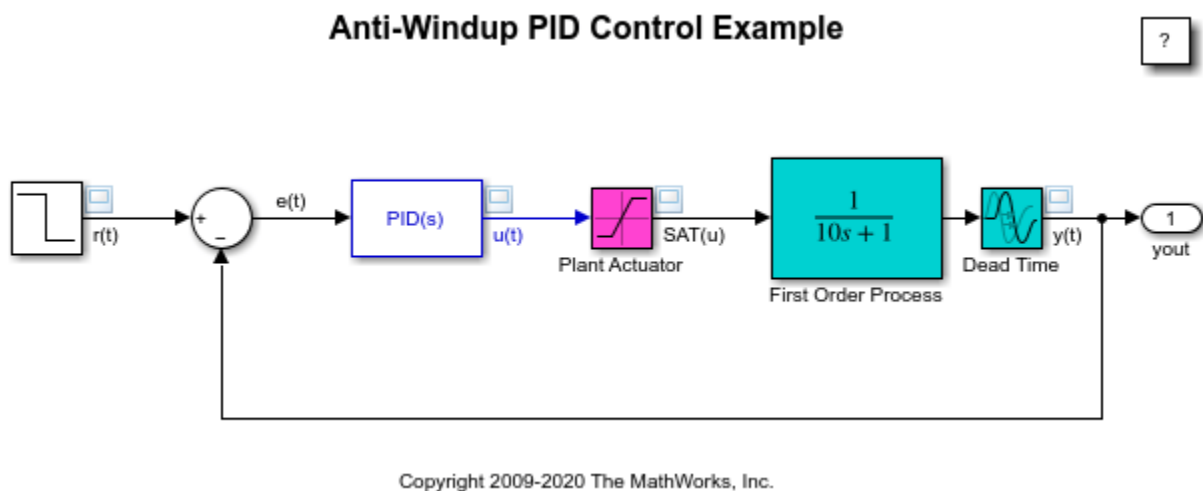

Figure 1: Simulink model of PID control of a plant with input saturation.

To open this model, type `sldemo_antiwindup` in a MATLAB® terminal.

The PID Controller has been tuned with saturation ignored using the PID tuner of Simulink® Control Design™.

The controlled plant is a first-order process with dead-time described by

$$P(s) = \frac{1}{10s + 1} e^{-2s}$$

The plant has known input saturation limits of $[-10, 10]$, which are accounted for in the Saturation block labeled Plant Actuator. The PID Controller block in Simulink features two built-in anti-windup methods that allow the PID Controller block to account for the available information about the plant input saturation.

Performance Without Using Anti-Windup

First, we examine the effect of saturation on the closed-loop when the saturation model is not considered by the PID Controller block. Simulating the model in Figure 1 generates the results shown below.

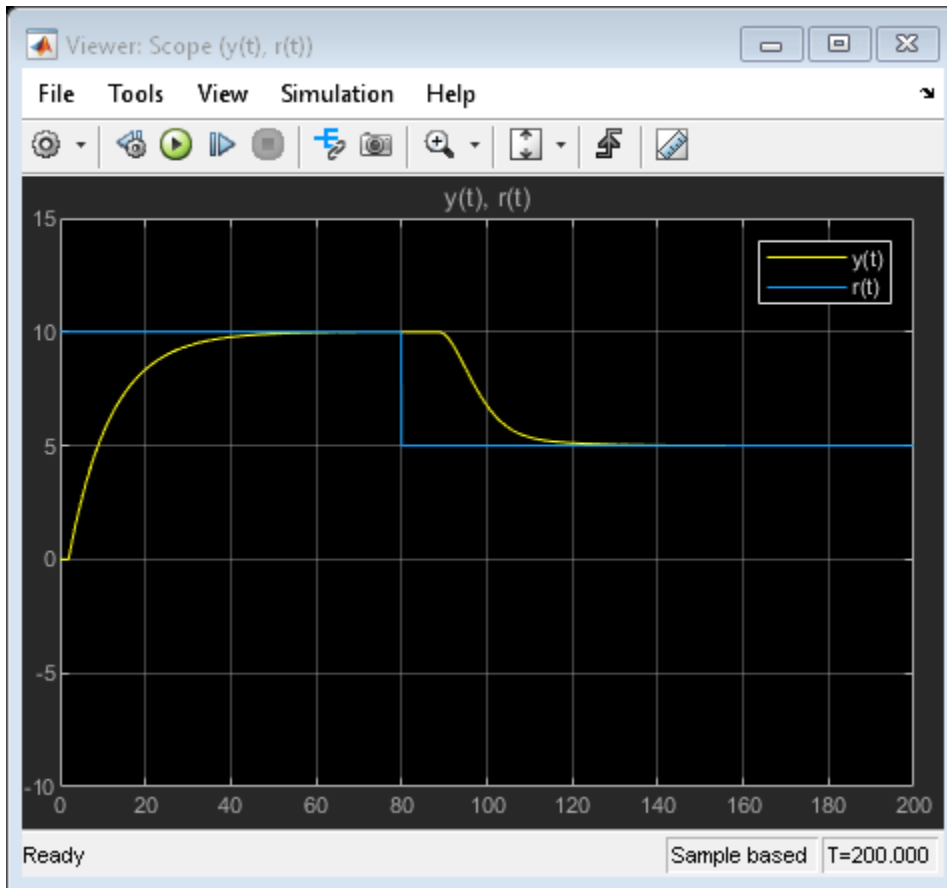

Figure 2: Setpoint vs. measured output with no anti-windup.

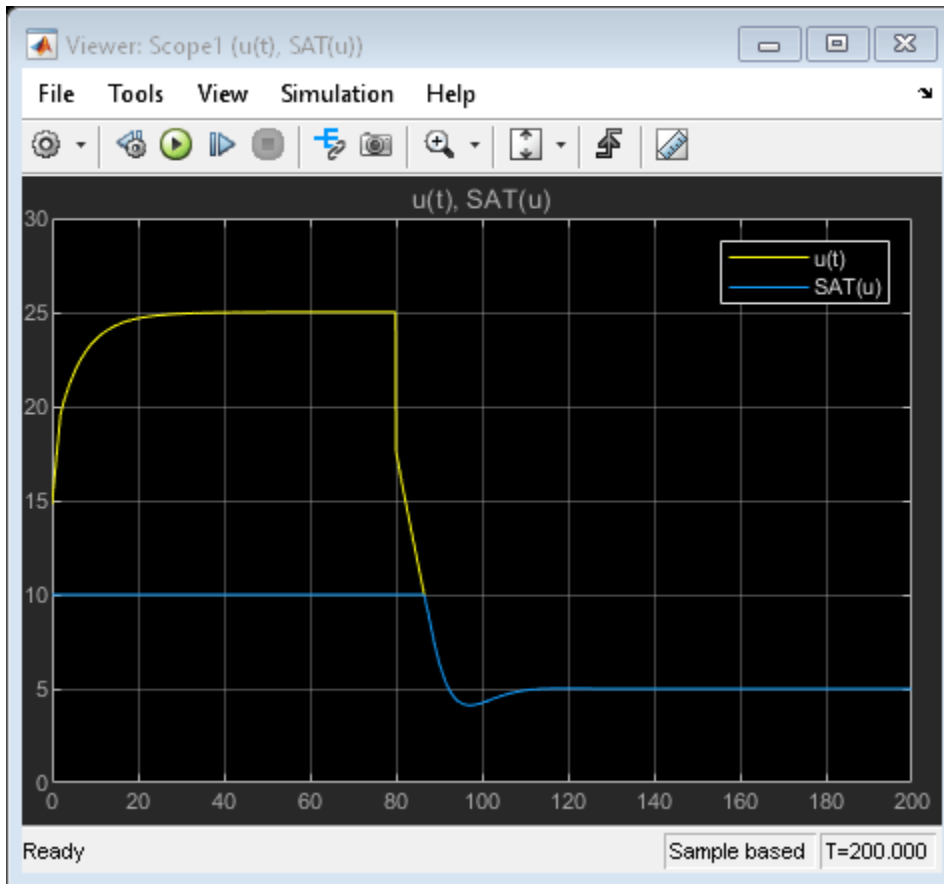

Figure 3: Controller output and saturated input with no anti-windup.

Figures 2 and 3 highlight two of the problems that arise when controlling a system with input saturation:

- 1 When the setpoint value is 10, the PID control signal reaches a steady-state at about 24, outside the range of the actuator. The controller is therefore operating in a nonlinear region where increasing the control signal has no effect on the system output, a condition known as *winding up*. Note that the dc-gain of the plant is unity, and therefore there is no reason for the controller output to have a steady-state value outside the actuator's range.
- 2 When the setpoint value becomes 5, there is a considerable delay before the PID controller output returns to within the actuator range.

Designing the PID controller to account for the effect of saturation will improve its performance by allowing it to operate in the linear region most of the time and recover quickly from nonlinearity. Anti-windup circuitry is one way to achieve this.

Configuring the Block for Anti-Windup Based on Back-Calculation

The back-calculation anti-windup method uses a feedback loop to discharge the PID Controller internal integrator when the controller hits specified saturation limits and enters nonlinear operation. To enable anti-windup, go to the **Output Saturation** tab in the block dialog; select **Limit output**; and enter the plant's saturation limits. Then, select **back-calculation** from the **Anti-windup method** menu and specify the **Back-calculation coefficient (K_b)**. The inverse of this gain is the

time constant of the anti-windup loop. In this example, the back-calculation gain is chosen to be 1. For more information on how to choose this value, see Reference [1].

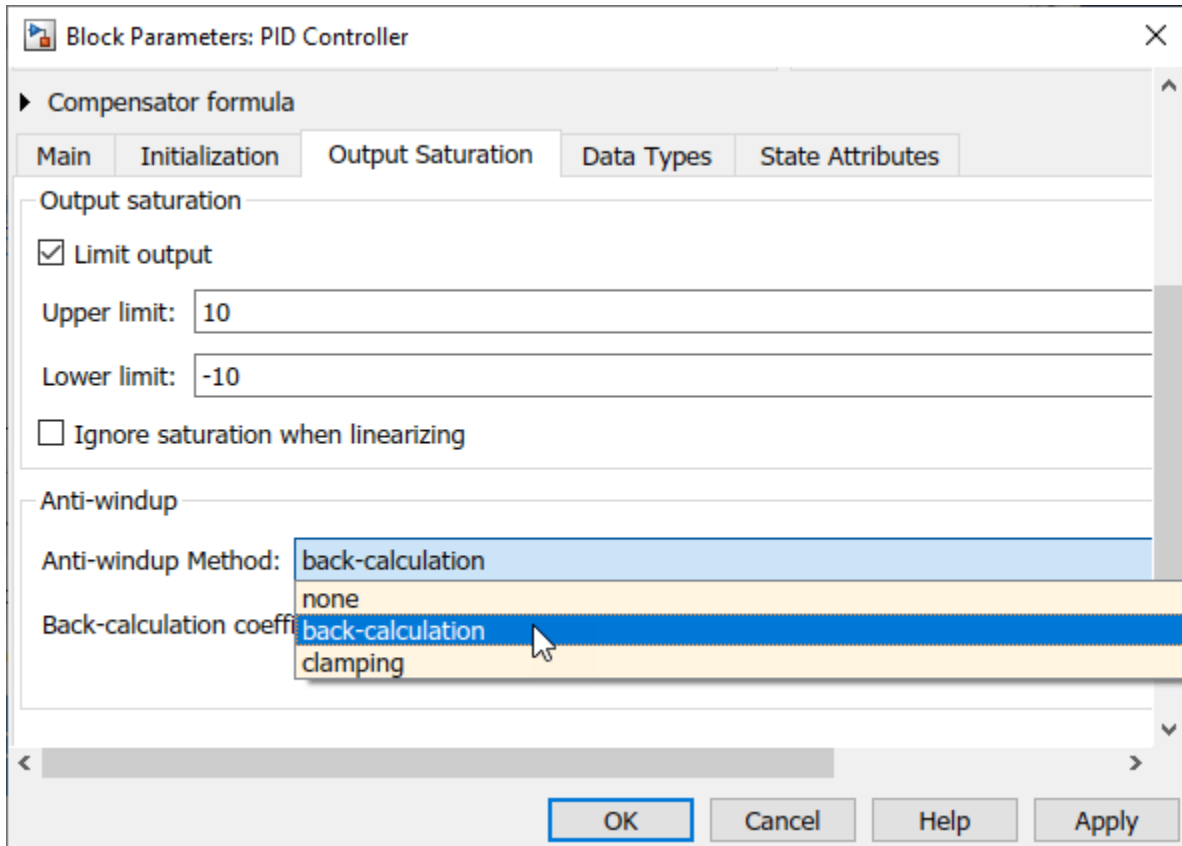

Figure 4: Enabling the back-calculation anti-windup method.

Once back-calculation is enabled, the block has an internal tracking loop that discharges the Integrator output.

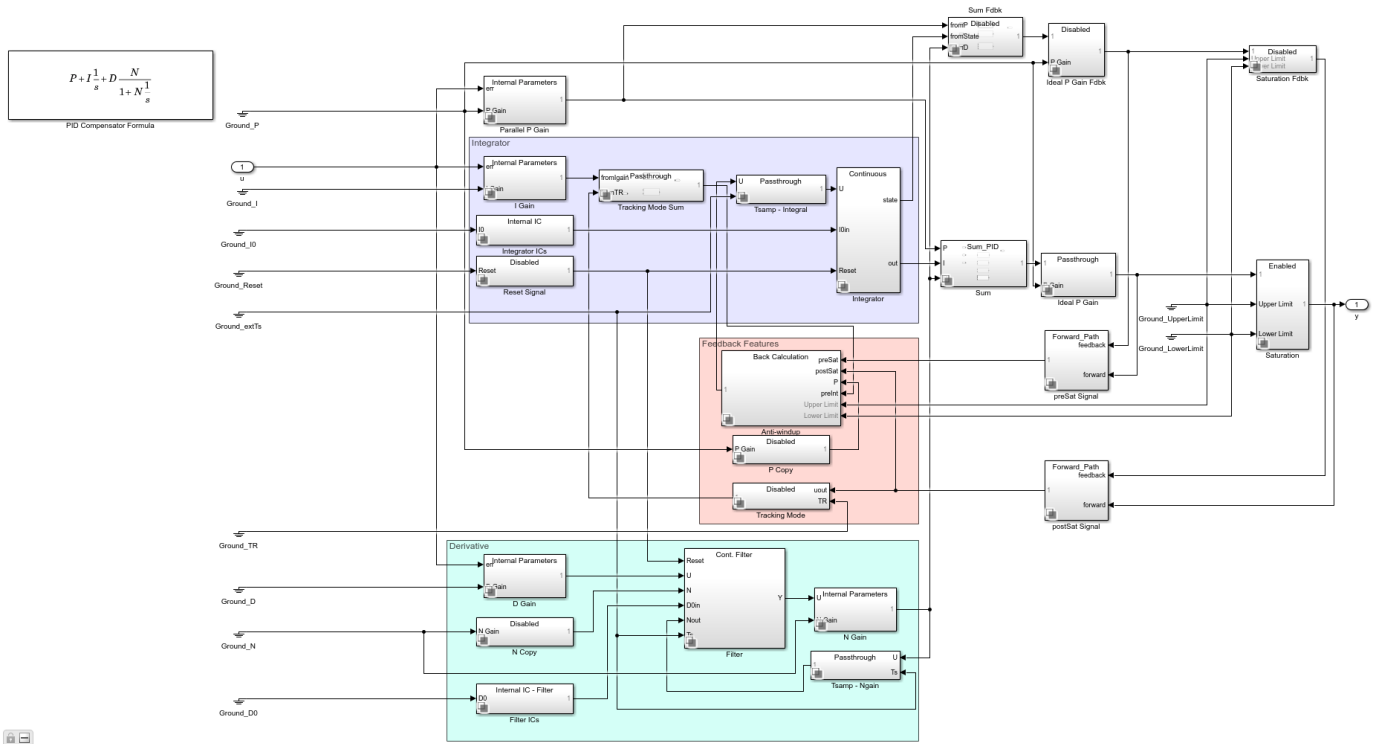
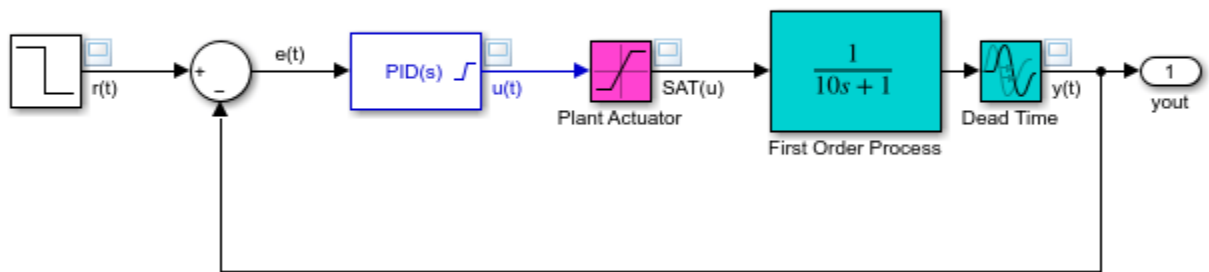

Figure 5: Under-mask view of the PID Controller block with back-calculation.

Figures 6 and 7 illustrate the result of simulating the model with anti-windup activated. Note how quickly the PID control signal returns to the linear region and how fast the loop recovers from saturation.

Anti-Windup PID Control Example



Copyright 2009-2020 The MathWorks, Inc.

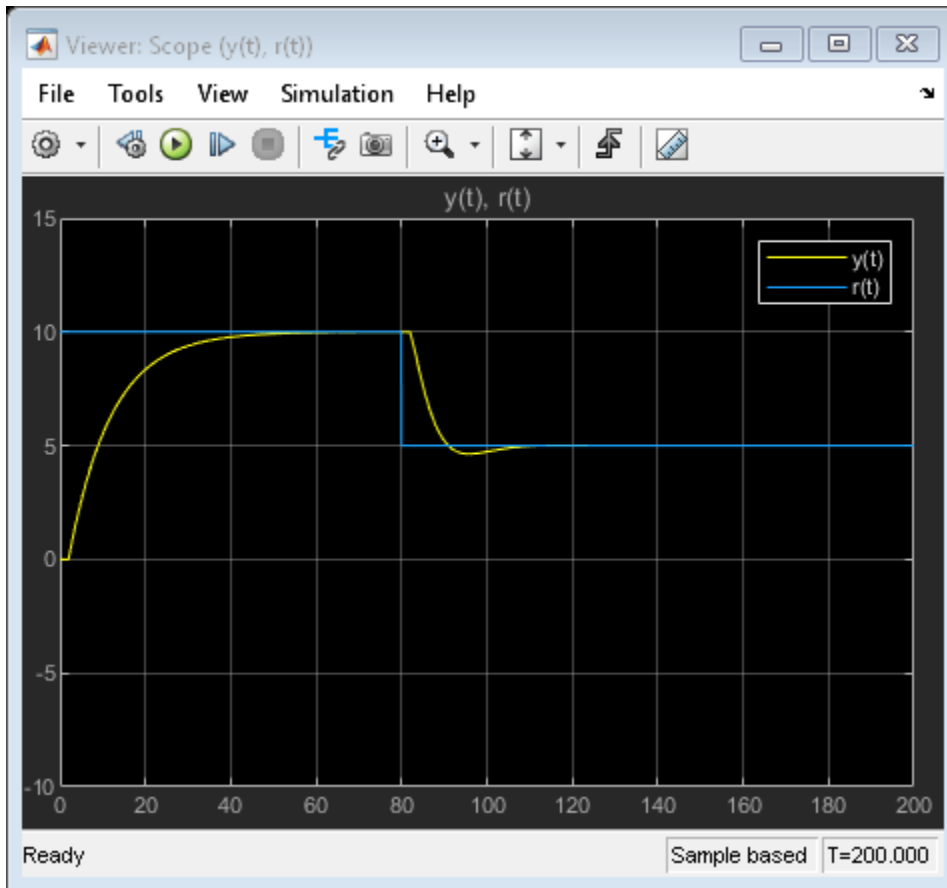

Figure 6: Setpoint vs. measured output with back-calculation.

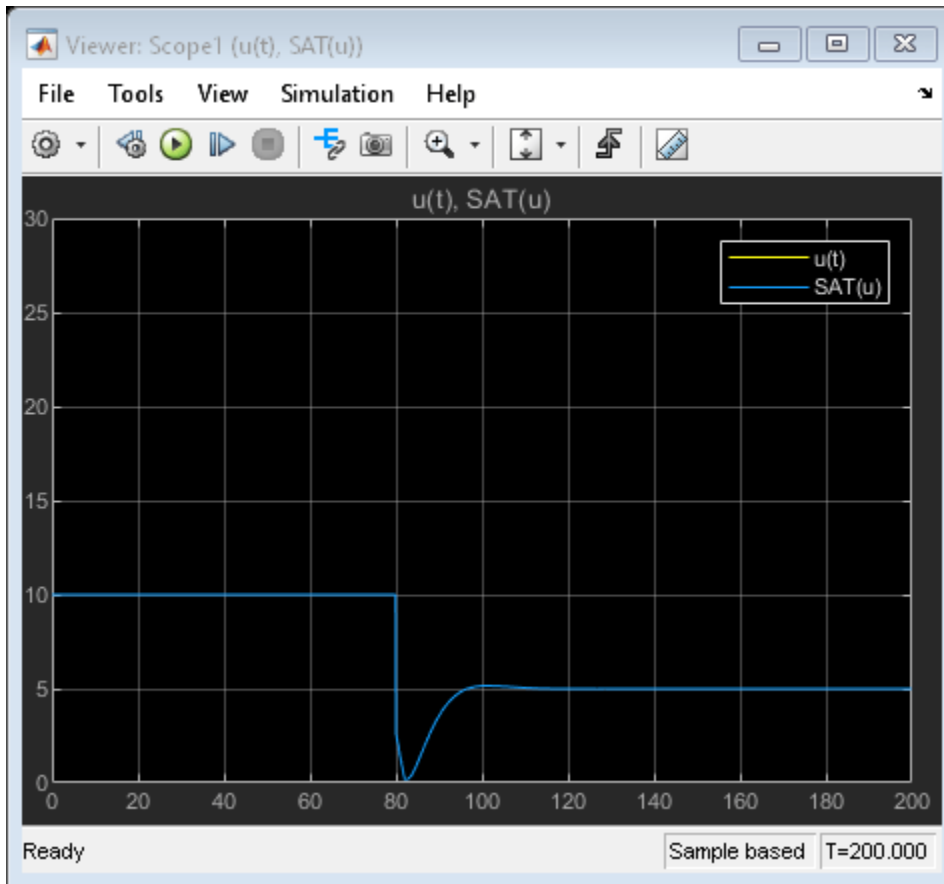

Figure 7: Controller output and saturated input with back-calculation.

Figure 7 shows that the controller output $u(t)$ and the saturated input $SAT(u)$ coincide with each other because **Limit output** is enabled.

To better visualize the effect of anti-windup, Figure 8 illustrates the plant measured output $y(t)$ with and without anti-windup.

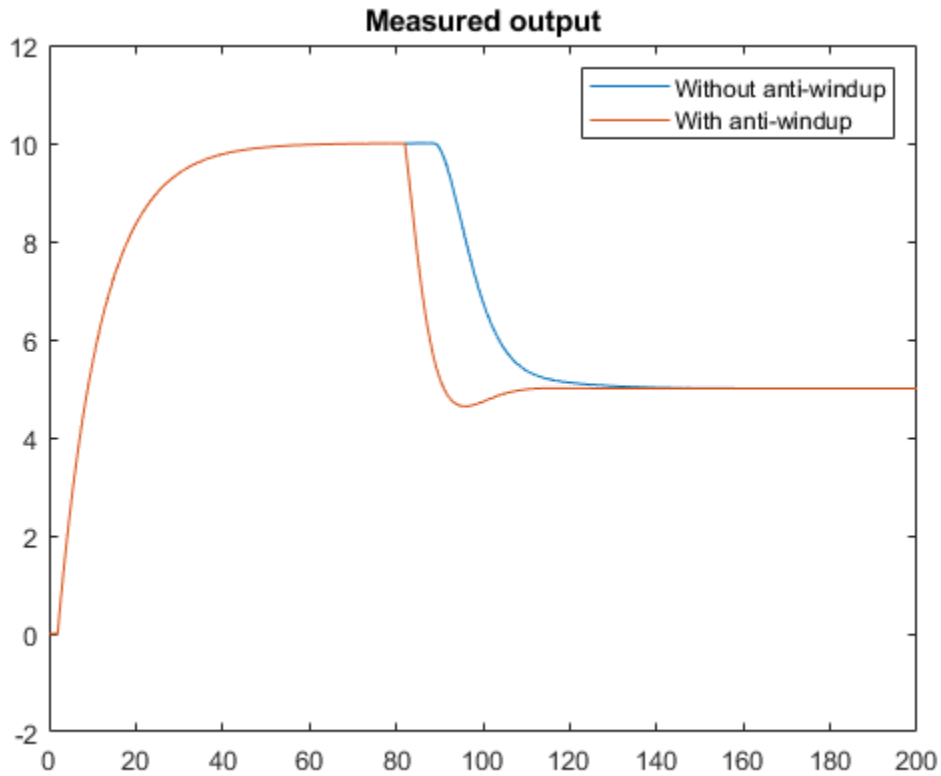

Figure 8: Measured output with and without anti-windup.

Configuring the Block for Anti-Windup Based on Integrator Clamping

Another commonly used anti-windup strategy is based on conditional integration. To enable anti-windup, go to the **PID Advanced** tab in the block's dialog; select **Limit output**; and enter the plant's saturation limits. Then, select **clamping** from the **Anti-windup method** menu.

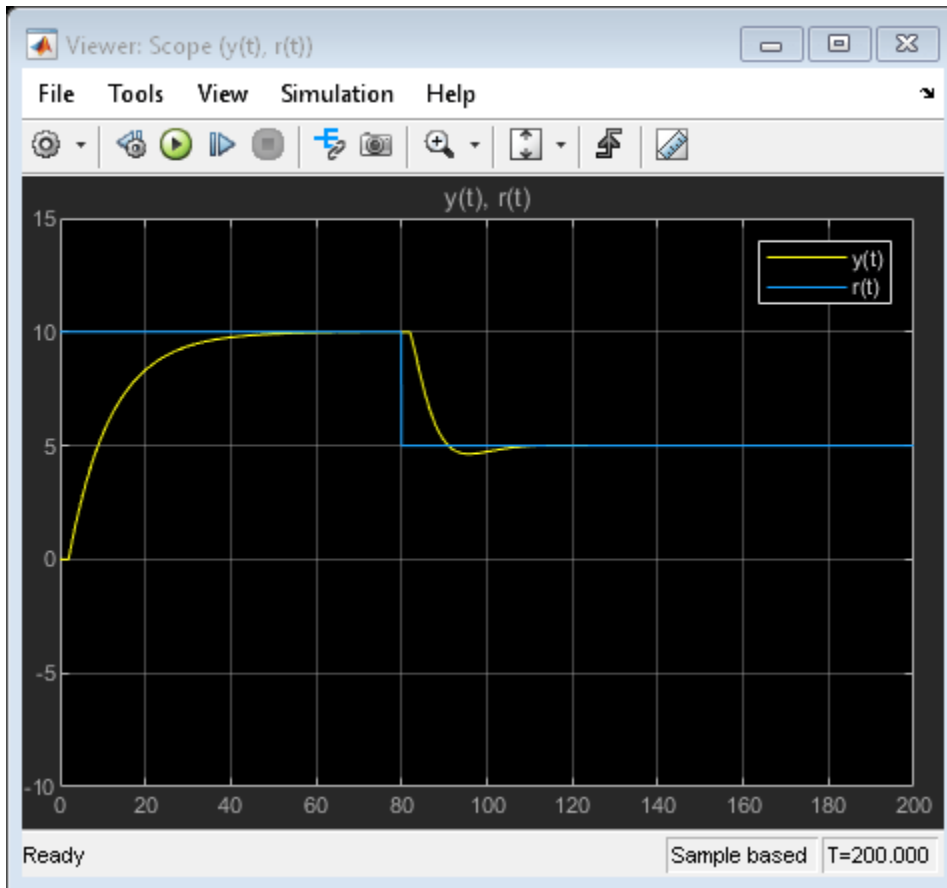

Figure 9: Setpoint vs. measured output with clamping.

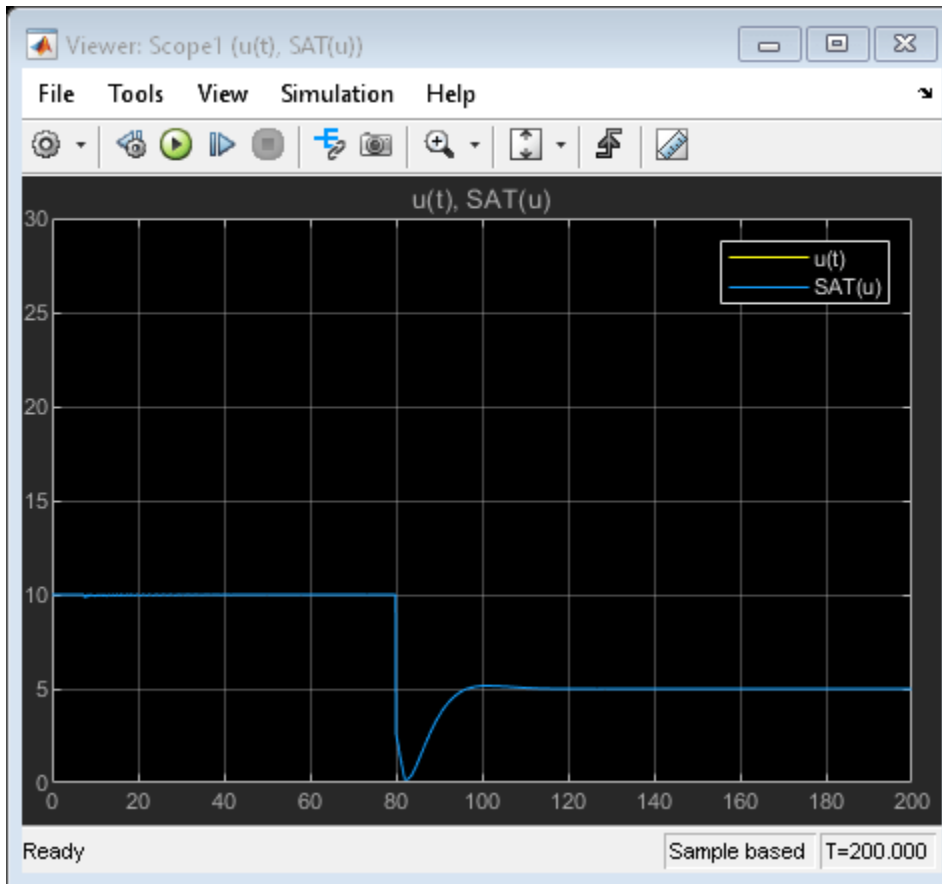

Figure 10: Controller output and saturated input with clamping.

Figure 10 shows that the controller output $u(t)$ and the saturated input $SAT(u)$ coincide with each other because **Limit output** is enabled.

For more information on when to use *clamping*, see Reference [1].

Using Tracking Mode to Handle Complex Anti-Windup Scenarios

The previously discussed anti-windup strategies relied on built-in methods to process the saturation information provided to the block via its dialog. For those built-in techniques to work as intended, two conditions must be met:

- 1 The plant's saturation limits are known and can be entered into the dialog of the block.
- 2 The PID Controller output signal is the only signal feeding the actuator.

These conditions may be restrictive when handling general anti-windup scenarios. The PID Controller block features a tracking mode that allows the user to set up a back-calculation anti-windup loop externally. The following two examples are considered to illustrate the use of tracking mode for anti-windup purposes:

- 1 Anti-windup for saturated actuators with cascaded dynamics
- 2 Anti-windup for PID control with Feedforward

Constructing Anti-Windup Circuitry for Saturated Actuators with Cascaded Dynamics

In the following model, the actuator has complex dynamics. This is common when an actuator has its own closed-loop dynamics. The PID controller is in an outer loop and sees the actuator dynamics as an inner loop, or simply a cascaded saturated dynamics as shown in Figure 1.

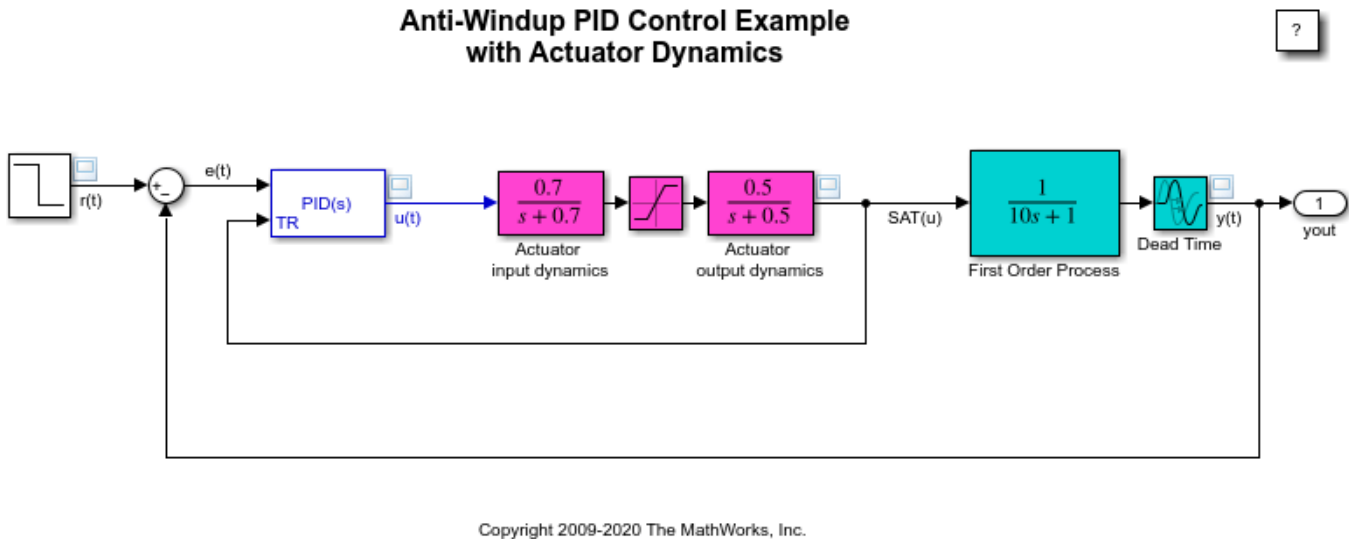

Figure 11: Simulink model of PID controller with cascaded actuator dynamics.

To open this model, type `sldemo_antiwindupactuator` in a MATLAB terminal.

In this case, a successful anti-windup strategy requires feeding back the actuator output to the tracking port of the PID Controller block as shown in Figure 11. To configure the tracking mode of the PID Controller block, go to the **PID Advanced** tab in the block's dialog; select **Enable tracking mode**; and specify the gain K_t . The inverse of this gain is the time constant of the tracking loop. For more information on how to choose this gain, see Reference [1].

Figures 12 and 13 show that the plant's measured output $y(t)$ and the controller output $u(t)$ are responding almost immediately to changes in the setpoint. Without the anti-windup circuit, these responses would be sluggish with long delays.

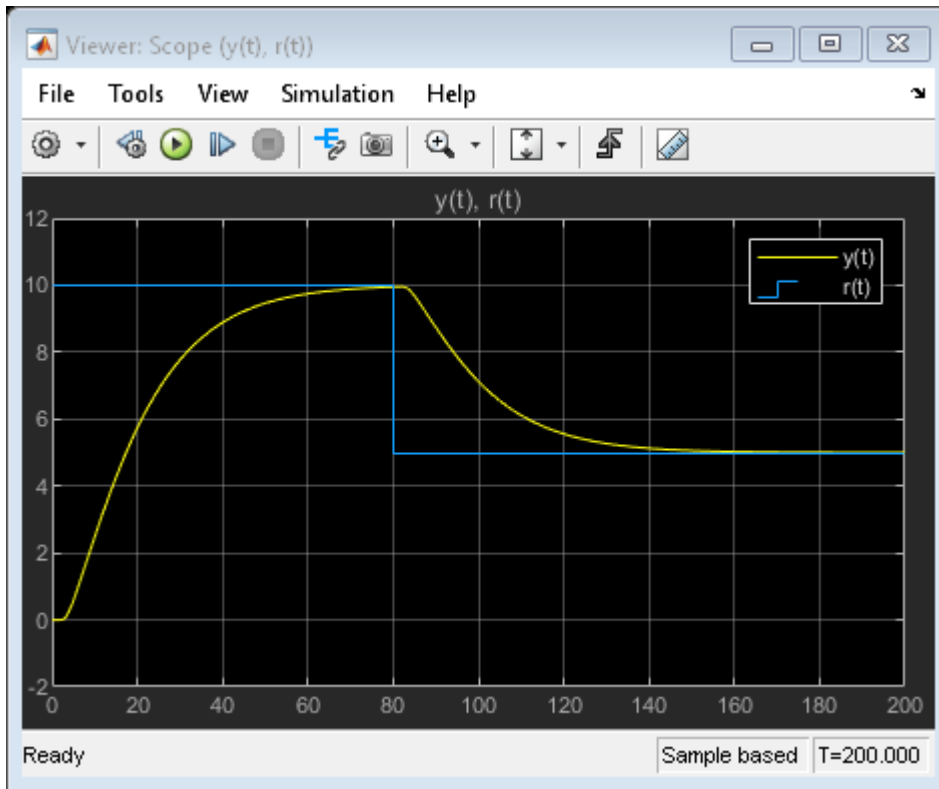

Figure 12: Setpoint vs. measured output.

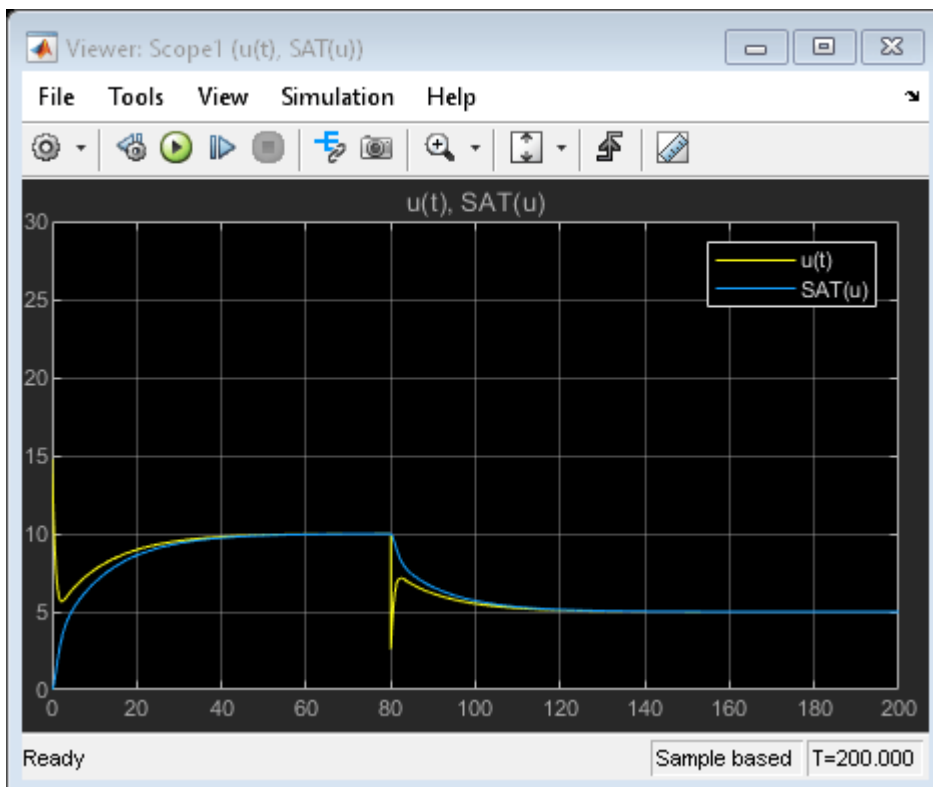

Figure 13: Controller output and effective saturated input.

Constructing Anti-Windup Circuitry for PID Control with Feedforward

In another common control configuration, the actuator receives a control signal that is a combination of a PID control signal and a feedforward control signal.

To accurately build a back-calculation anti-windup loop, the tracking signal should subtract the contribution of the feedforward signal. This allows the PID Controller block to know its share of the effective control signal applied to the actuator.

The following model includes a feedforward control.

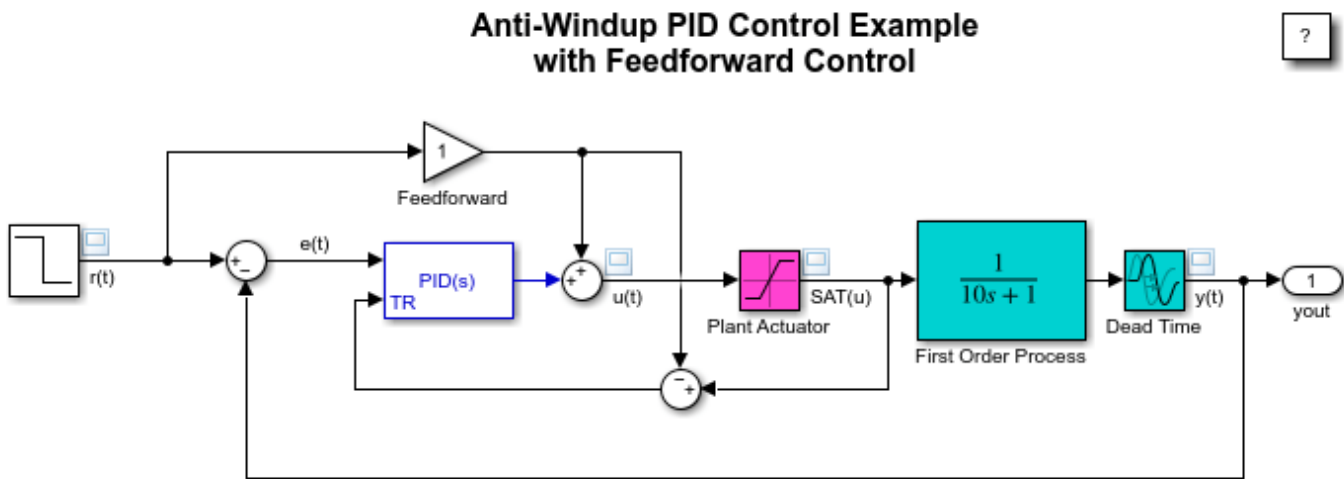

Copyright 2009-2020 The MathWorks, Inc.

Figure 14: Simulink model of PID controller with feedforward, and plant input saturation.

The feedforward gain is selected to be unity here because the plant has a dc-gain of 1.

To open this model, type `sldemo_antiwindupfeedforward` in a MATLAB terminal.

Figures 15 and 16 show that the plant's measured output $y(t)$ and the controller output $u(t)$ are responding almost immediately to changes in the setpoint. When the setpoint value is 10, note how in Figure 16 the controller output $u(t)$ reduces to be within the range of the actuator.

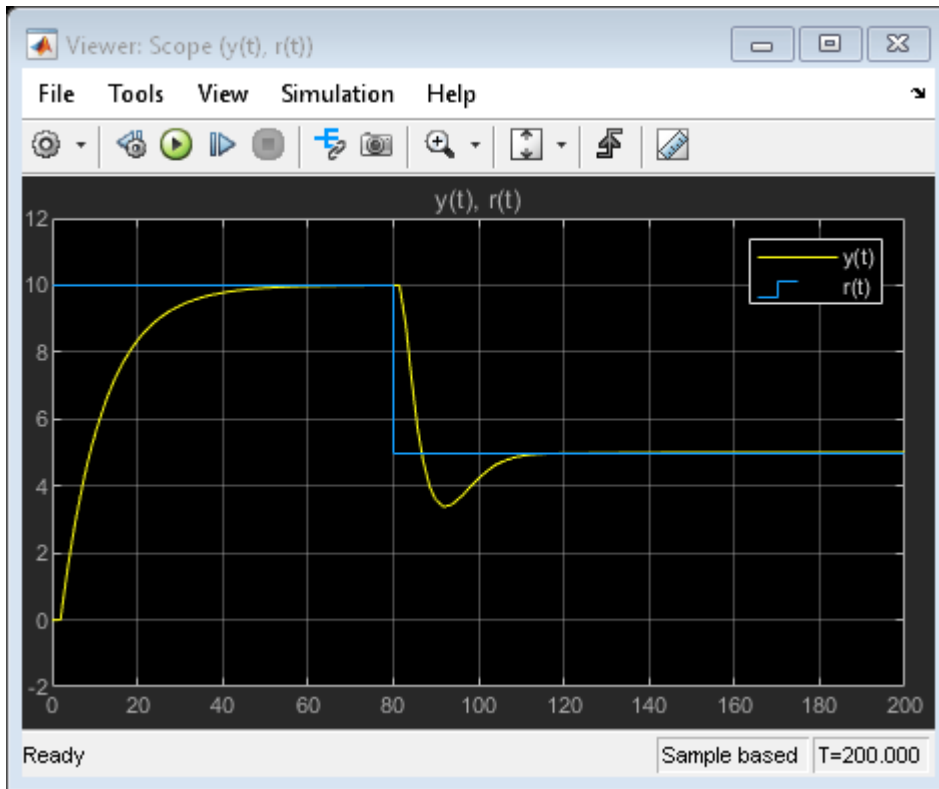

Figure 17: Setpoint vs. measured output without anti-windup.

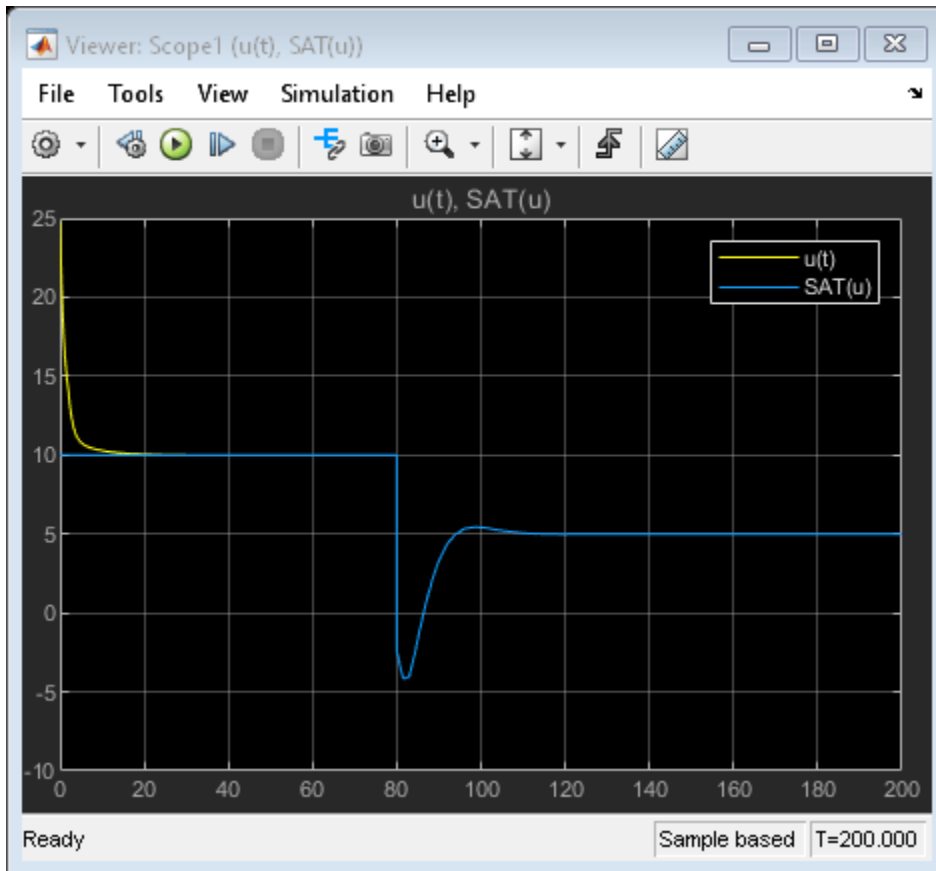

Figure 18: Controller output and saturated input with anti-windup.

Summary

The PID Controller block supports several features that allow it to handle controller windup issues under commonly encountered industrial scenarios.

References

- 1 K. Åström, T. Häggglund, *Advanced PID Control*, ISA, Research Triangle Park, NC, August 2005.

See Also

PID Controller

More About

- “Continuous”

Bumpless Control Transfer Between Manual and PID Control

Model Description

This example shows how to achieve bumpless control transfer when switching from manual control to PID control. We use the PID Controller block in Simulink® to control a first-order process with dead-time.

We start by opening the model.

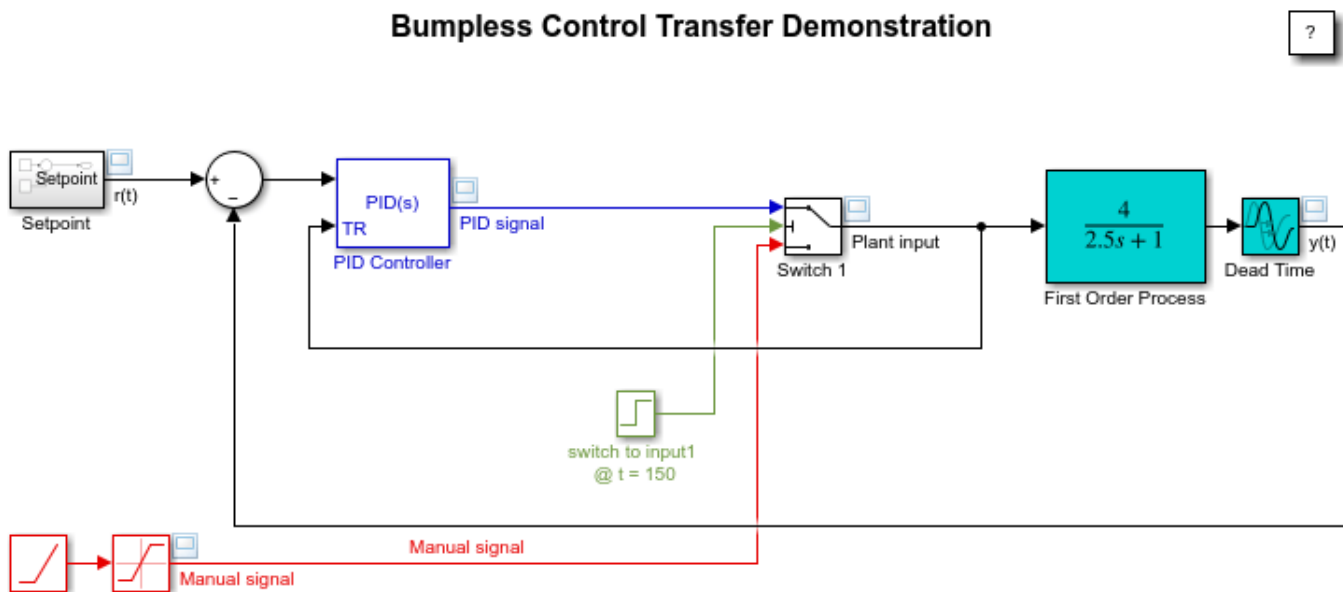

Copyright 2009-2018 The MathWorks, Inc.

Figure 1: Simulink model of PID control with bumpless transfer.

To open this model, type `sldemo_bumpless` in a MATLAB® terminal.

The PID Controller has been tuned with saturation ignored using the PID tuner of Simulink® Control Design™.

The controlled plant is a first-order process with dead-time described by

$$P(s) = \frac{4}{2.5s + 1} e^{-s}$$

For several operational reasons, the engineers decided to start the control process in an open-loop manner by feeding the plant input with a saturating ramp signal to drive the output of the plant slowly to a desired steady-state value of 40. A control transfer is scheduled to happen at $t = 150$. This transition between open-loop control and closed-loop control therefore involves two control phases of operation:

- 1 Manual: A saturated ramp signal feeds the plant input during start-up until $t = 150$.

- Automatic: A PID controller will engage the plant at $t = 150$, and must take over the process without introducing bumps at the plant input.

To support smooth control transition, the PID Controller block supports two modes of operation: a **tracking mode** and a **control mode**. In control mode, the PID Controller block operates as an ordinary PID controller. In tracking mode, however, the block has an extra input that allows the PID block to adjust its internal state by changing its integrator output so that the block output tracks a prescribed signal feeding this extra input port.

To achieve bumpless control transfer, the PID Controller block must be in tracking mode when the plant is in the manual control phase (open-loop control), and in control mode when the plant is in the automatic control phase (closed-loop control).

Configuring the Block for Tracking Mode

To activate signal tracking, go to the **Initialization** tab in the block dialog; select **Enable tracking mode**, and specify the gain Kt . The inverse of this gain is the time constant of the tracking loop. For more information on how to choose this gain, see Reference [1].

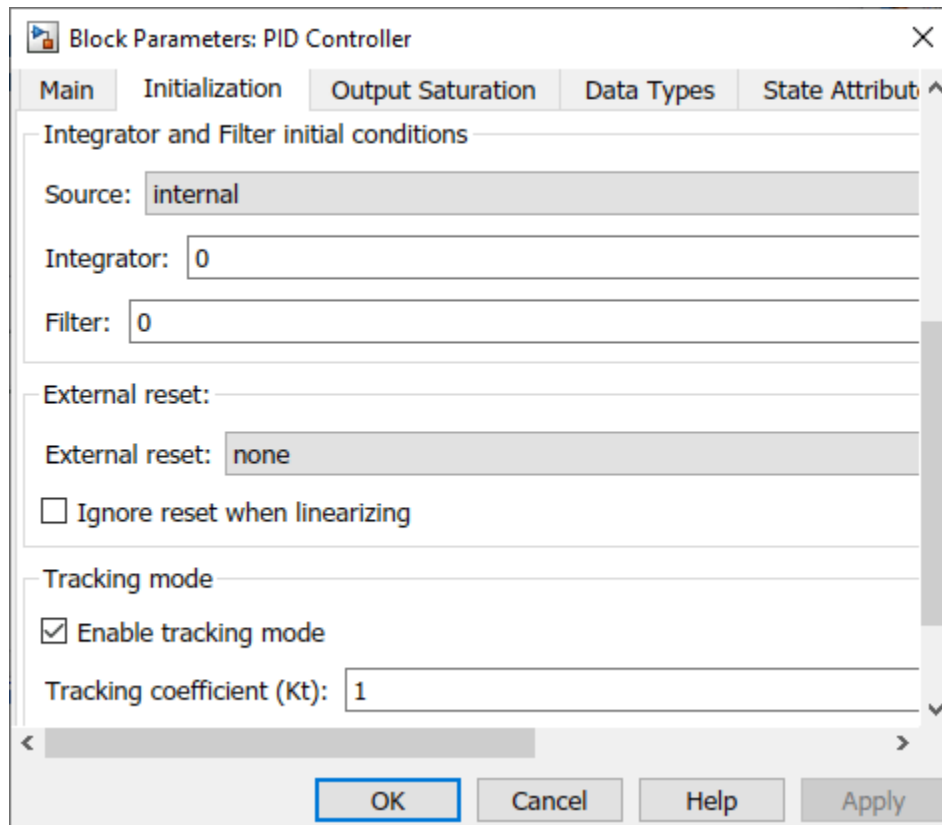

Figure 2: Enabling the tracking mode of the PID Controller block.

As shown in Figure 1, once tracking mode is enabled, the block has a second input port denoted by TR. Internally this new port is wired as shown under mask:

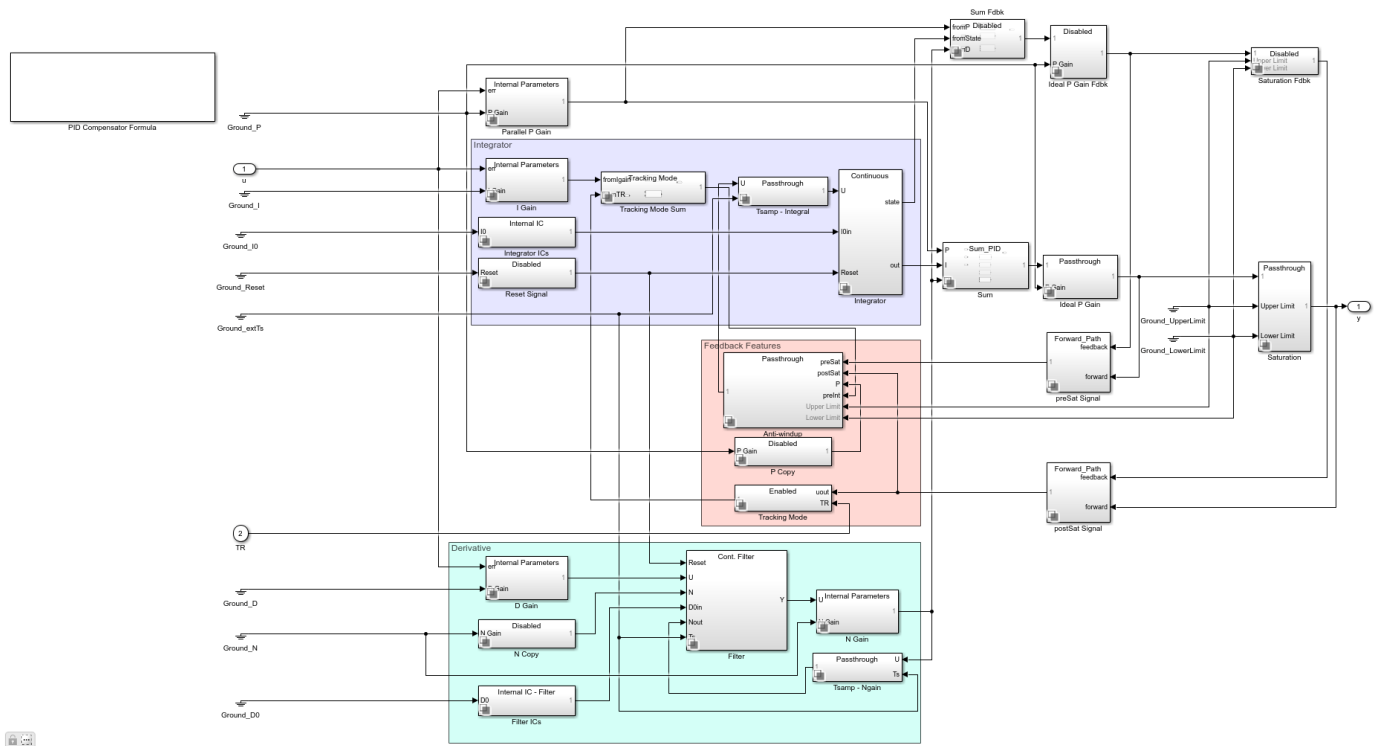

Figure 3: Under-mask view of the PID Controller block with tracking mode.

Setting Up the Switching Mechanism

In addition to enabling tracking mode for the PID Controller block, a switching mechanism is needed to achieve the control transfer. Switch 1 determines which signal feeds the plant input and feeds the tracking port of the PID Controller block.

At time $t = 0$, Switch 1 directs the manual control signal to the plant input and the tracking port of the PID Controller block. This allows the output of the PID Controller block to track the manual control signal during the manual phase by adjusting the PID Controller's internal integrator. When control transfer occurs, therefore, the PID Controller output will be approximately the same as the manual control signal.

At time $t = 150$, Switch 1 switches, directing the output of the PID Controller block to the plant input and the PID Controller block's tracking input. The PID Controller block now tracks its own output, which is equivalent to control mode.

Simulating the Bumpless Control Transfer

The setpoint signal and the closed-loop response of the model are shown in Figure 4.

Bumpless Control Transfer Demonstration

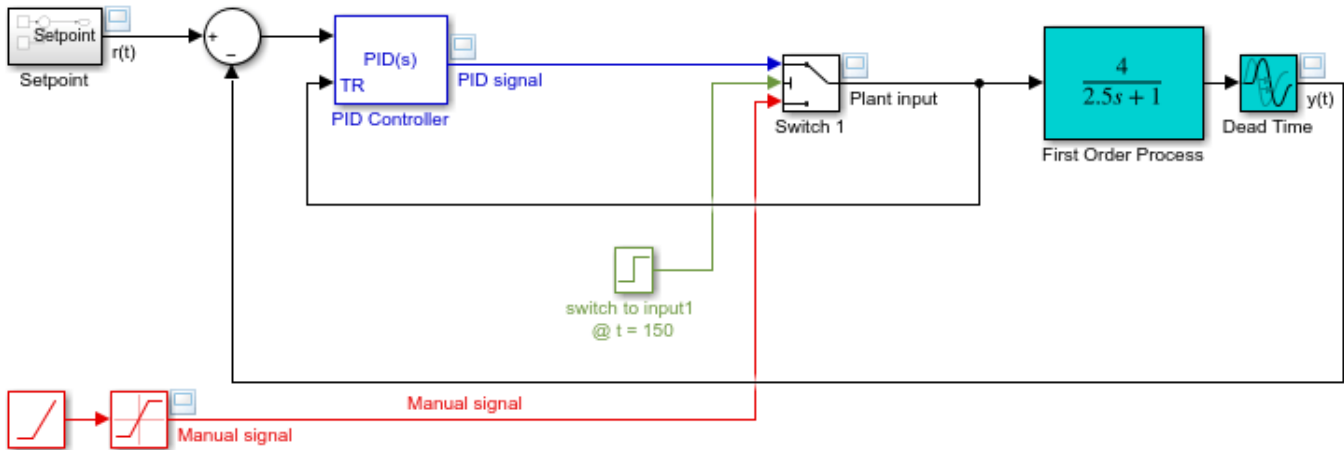

Copyright 2009-2018 The MathWorks, Inc.

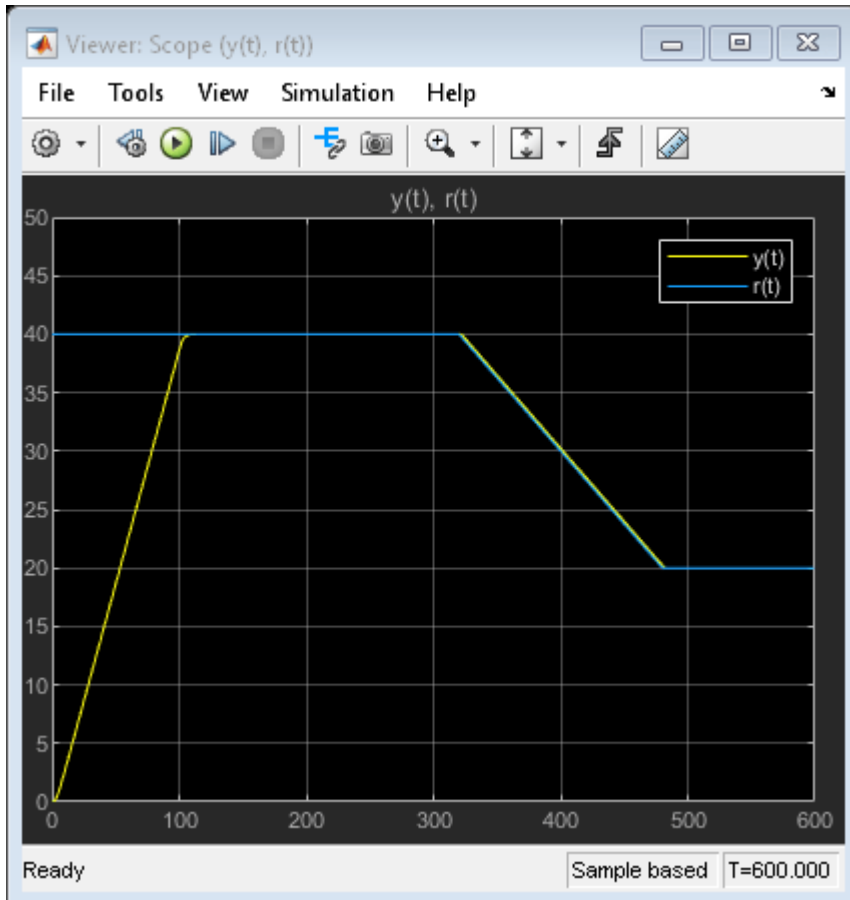
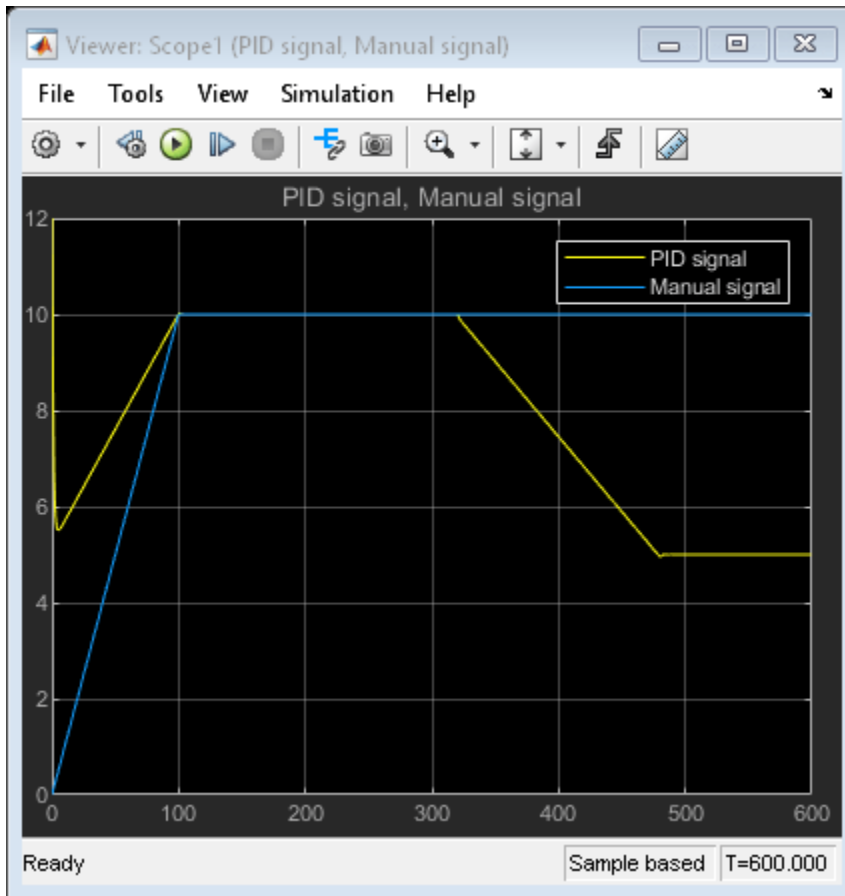

Figure 4: Setpoint vs. measured output.

Figure 4 clearly shows that the measured output tracks the Setpoint profile without any output bumps at the time of switching ($t = 150$). To investigate this further, the plant input, control signals are shown in Figure 5.

**Figure 5:** Control signal switching.

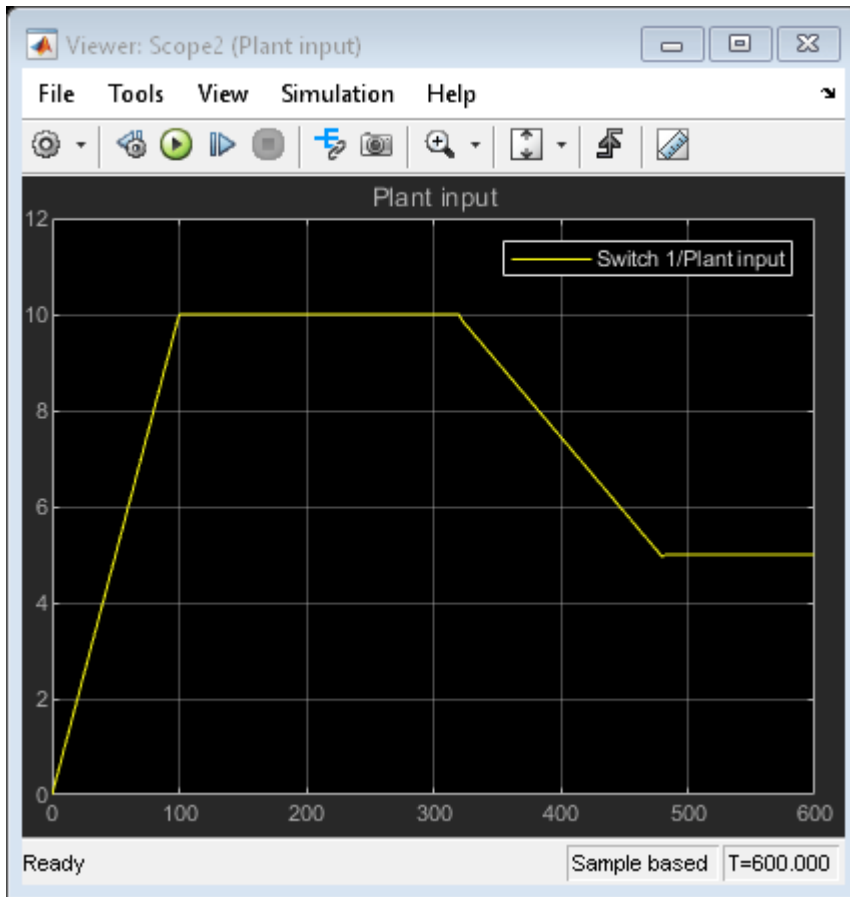
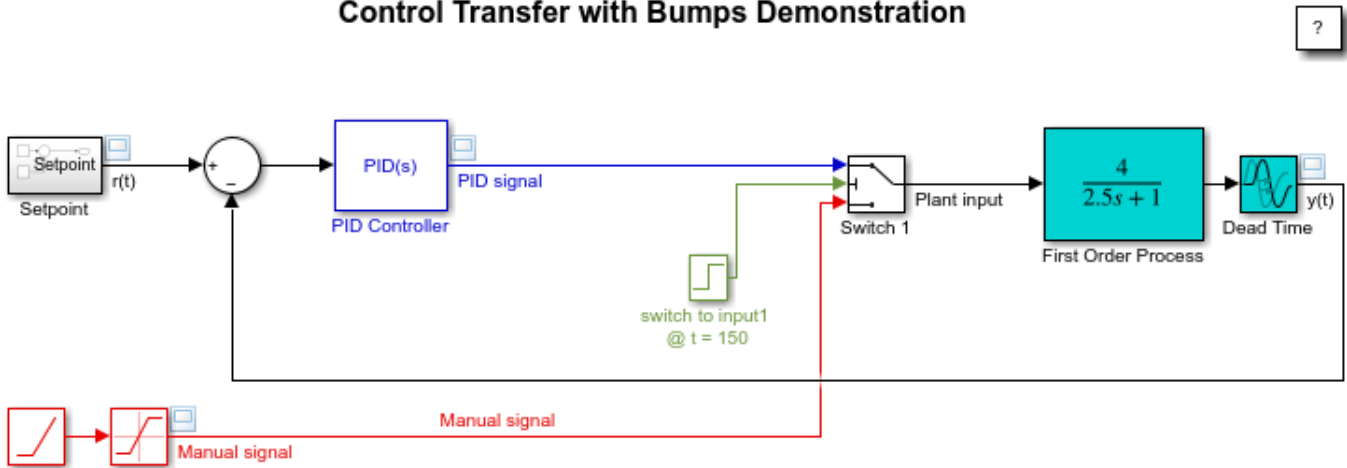

Figure 6: Plant input.

Figures 5 and 6 show that at the switching instance, the plant input has experienced no step changes (bumps), and therefore the control transfer happens in smooth bumpless fashion as intended.

To see the significance of the bumpless transfer setup, consider the case where tracking mode is not used. In this case, the following setup is obtained:

Control Transfer with Bumps Demonstration



Copyright 2009-2018 The MathWorks, Inc.

Figure 7: Simulink model of PID control with no bumpless transfer.

To open this model, type `sldemo_bumplessno` in a MATLAB terminal.

Figures 8 and 9 show the performance in the absence of an appropriate bumpless control transfer strategy.

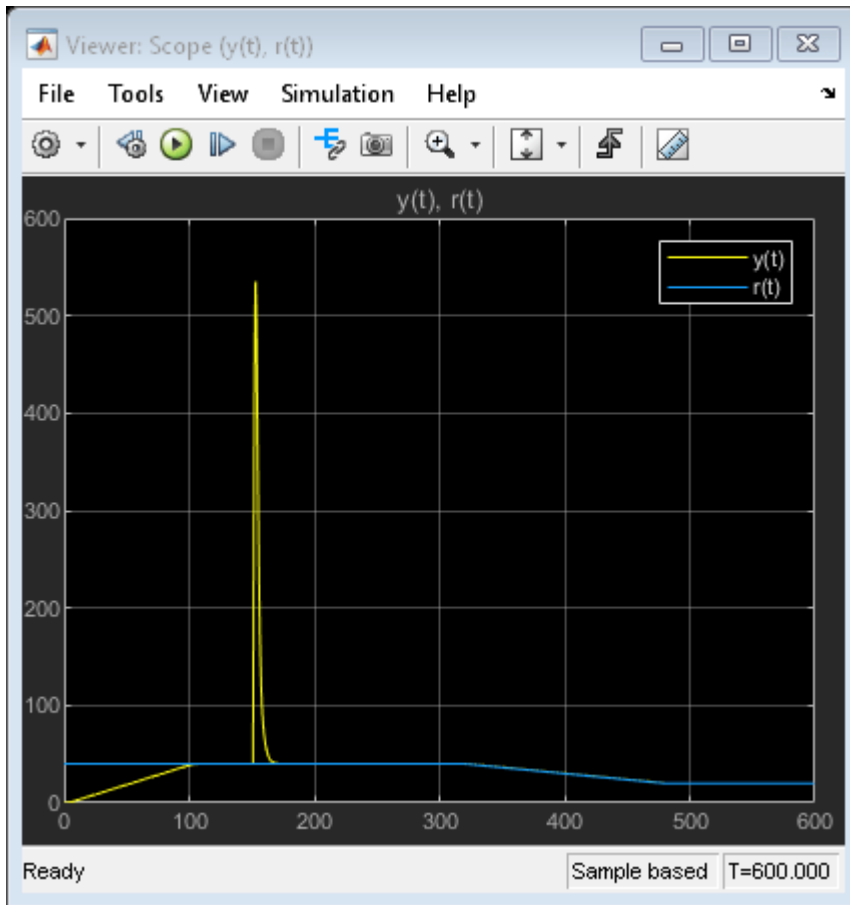

Figure 8: Setpoint vs. measured output.

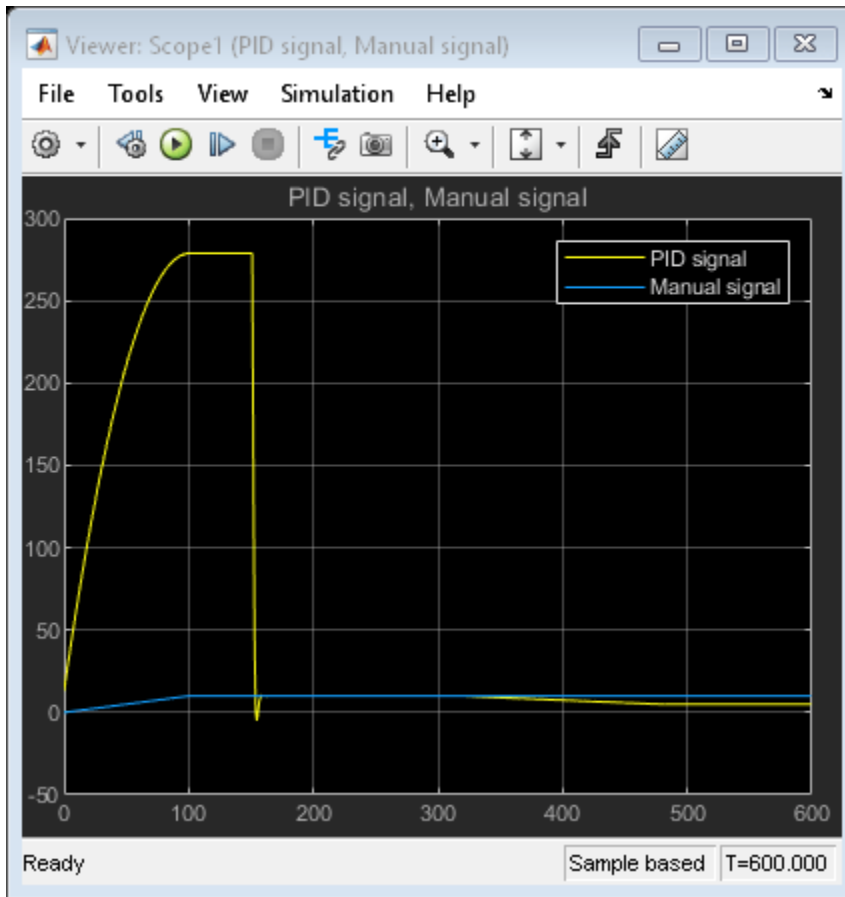

Figure 9: Control signal switching.

It is evident from Figures 8 and 9 that allowing the PID controller to float while the plant is under manual control can result in undesirable large transients upon switching.

Summary

As this example shows, the PID Controller block supports bumpless control transfer through the use of tracking mode.

References

- 1 K. Åström, T. Hägglund, *Advanced PID Control*, ISA, Research Triangle Park, NC, August 2005.

See Also

PID Controller

More About

- “Continuous”

Two Degree-of-Freedom PID Control for Setpoint Tracking

Model Description

This example shows how to regulate the speed of an electric motor using two degrees-of-freedom PID control with set-point weighting. We use the PID Controller (2DOF) block in Simulink® as shown below.

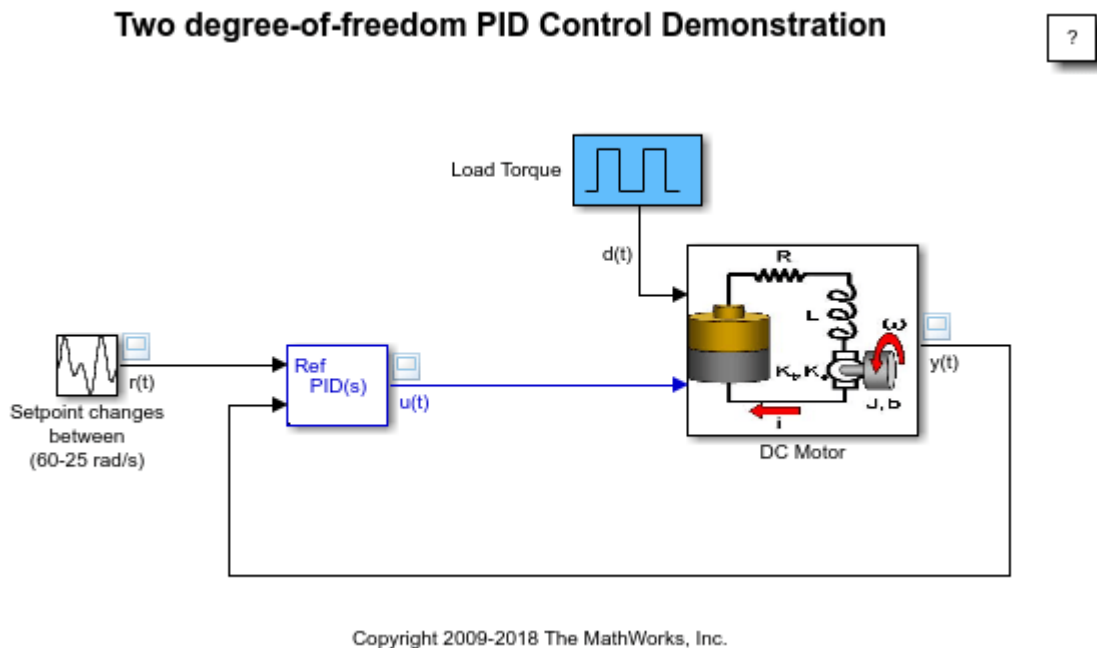

Figure 1: Simulink model with two degree-of-freedom PID control of a DC motor.

To open this model, type `sldemo_pid2dof` in a MATLAB® terminal.

The electric motor is an armature-controlled DC motor. Voltage input controls the shaft speed of the motor. The block diagram of the motor is shown in **Figure 2**. The motor experiences a load torque T_d (0-5 Nm).

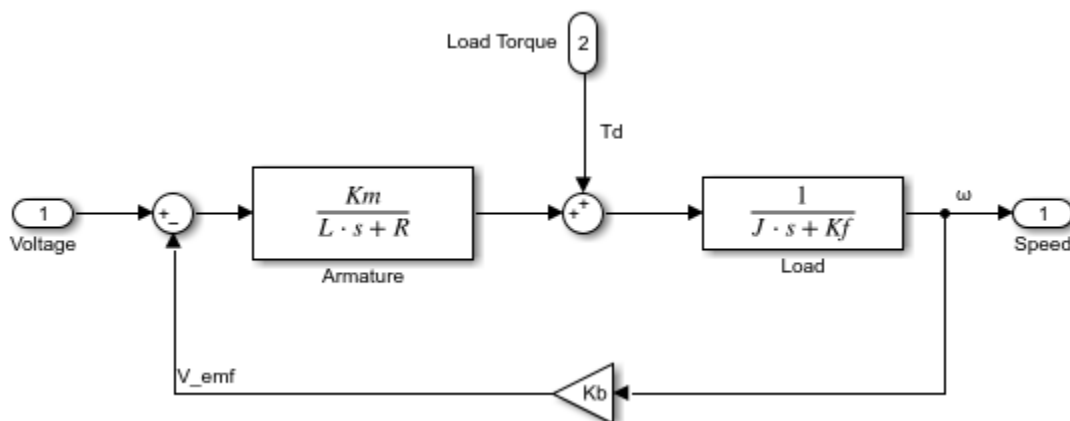
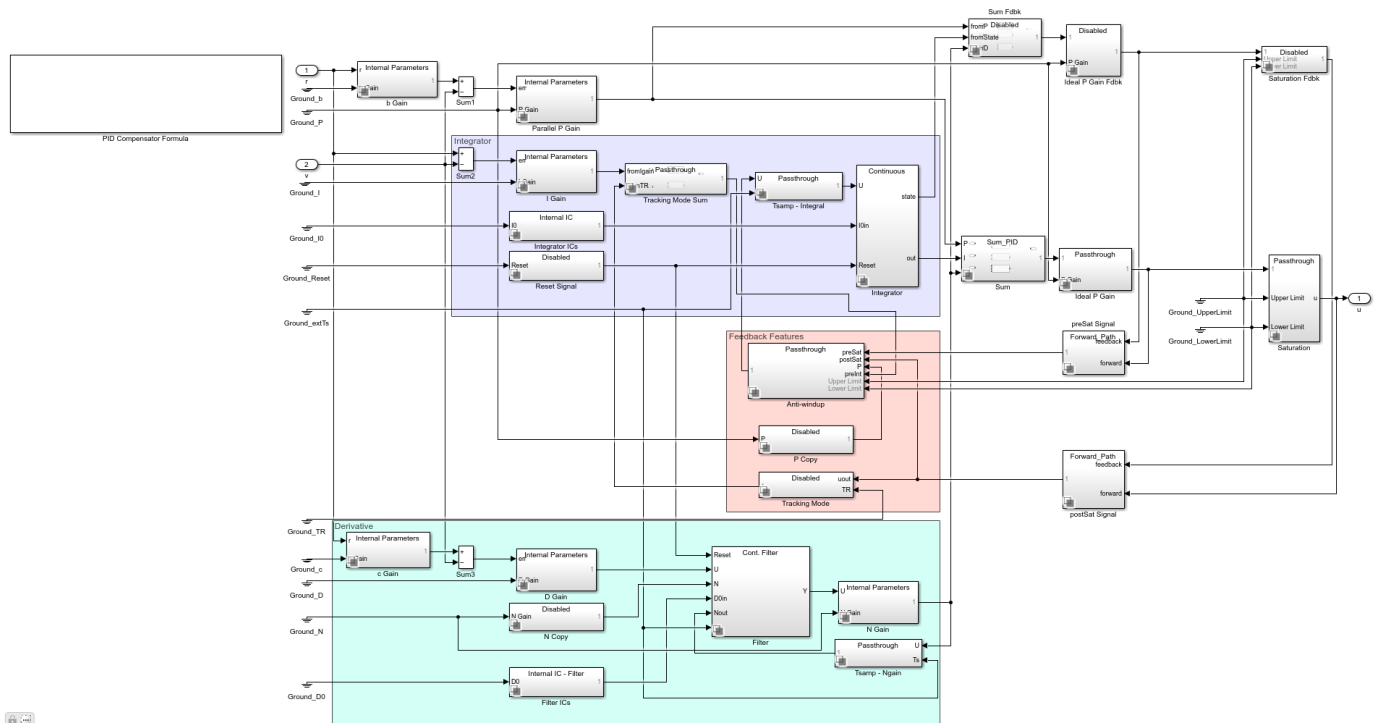

Figure 2: Block diagram of the motor.**Two Degree-of-Freedom PID Control**

In contrast to the PID Controller block, the PID Controller (2DOF) block provides an extra degree of freedom to allow users to weight the setpoint as it passes through the proportional action channel and the derivative action channel. See the PID Controller (2DOF) help page or type `doc('PID Controller 2DOF')` in a MATLAB terminal for more details. The schematic of the PID Controller (2DOF) appearing in the model is shown below.

**Figure 3:** Under-mask view of the PID Controller (2DOF).

As shown in Figure 3, the error signal seen by the proportional action is given by

$$b * r - y$$

The signal seen by the derivative action is

$$c * r - y$$

and the signal seen by the integral action is

$$r - y$$

In general, the setpoint weight c is chosen to be 0 to prevent undesirable transients upon a change in the setpoint, which is an effect known as *derivative kick*. The setpoint b affects the overshoot performance of the controller. Generally, a small b value reduces overshoot. However, smaller b values can also result in slower response to setpoint changes. For more details on picking the right setpoint values, see Reference [1].

When $b = 1$ and $c = 1$, the behavior of the two degree-of-freedom PID controller is identical to a classical PID controller.

Simulating with $b = 1$ and $c = 1$

When $b = 1$ and $c = 1$, the behavior of the two degree-of-freedom PID controller is identical to a classical PID controller. The control signal, setpoint signal, and closed-loop response of the model are shown in Figure 4.

Two degree-of-freedom PID Control Demonstration

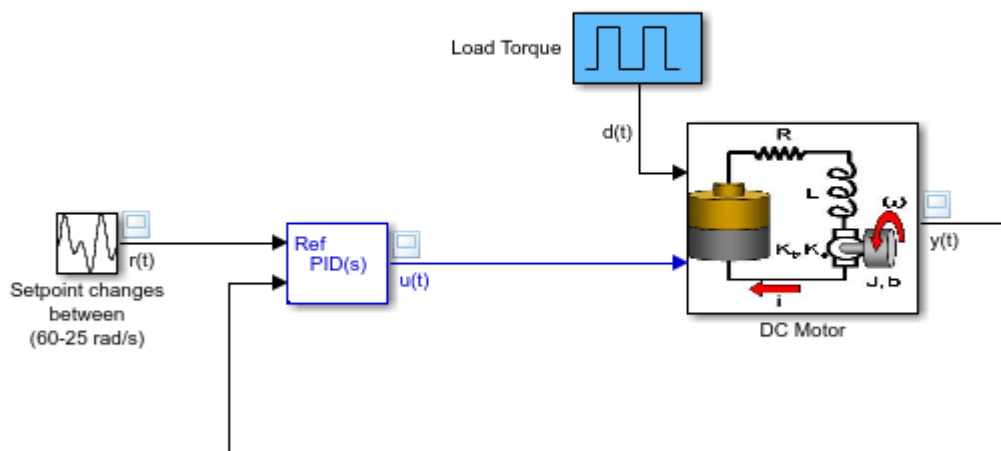

Copyright 2009-2018 The MathWorks, Inc.

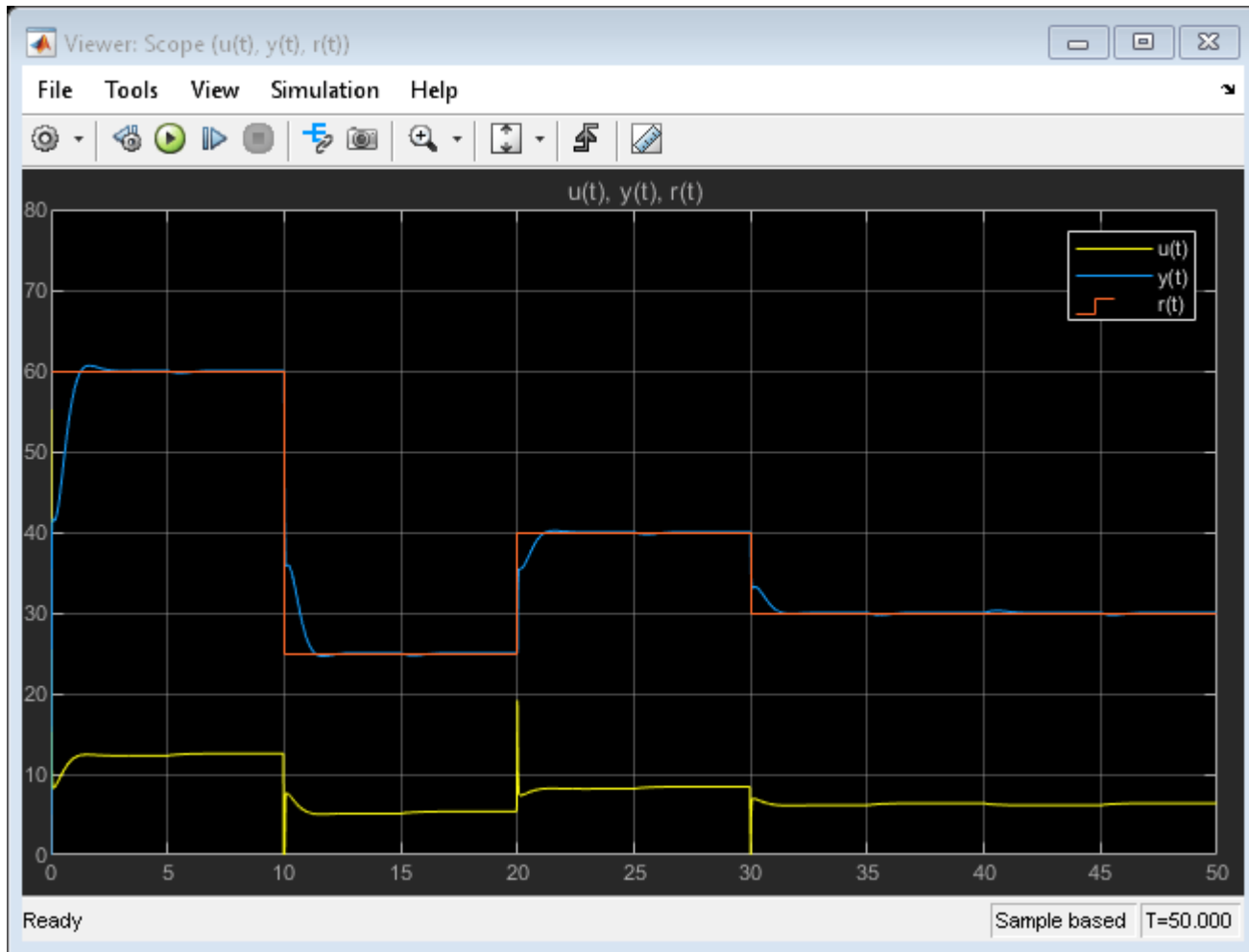

Figure 4: Control signal, setpoint vs. measured output.

Figure 4 clearly shows the spikes in the control signal, which are caused by aggressive proportional and derivative response to the setpoint change. Modifying the b and c weights can make this response less aggressive, as shown next.

Simulating with the $b = 0$ and $c = 0$

In this case, the two degree-of-freedom PID controller is known as I-PD where only the I action acts on the classical error signal, and the PD action acts only on the measured output.

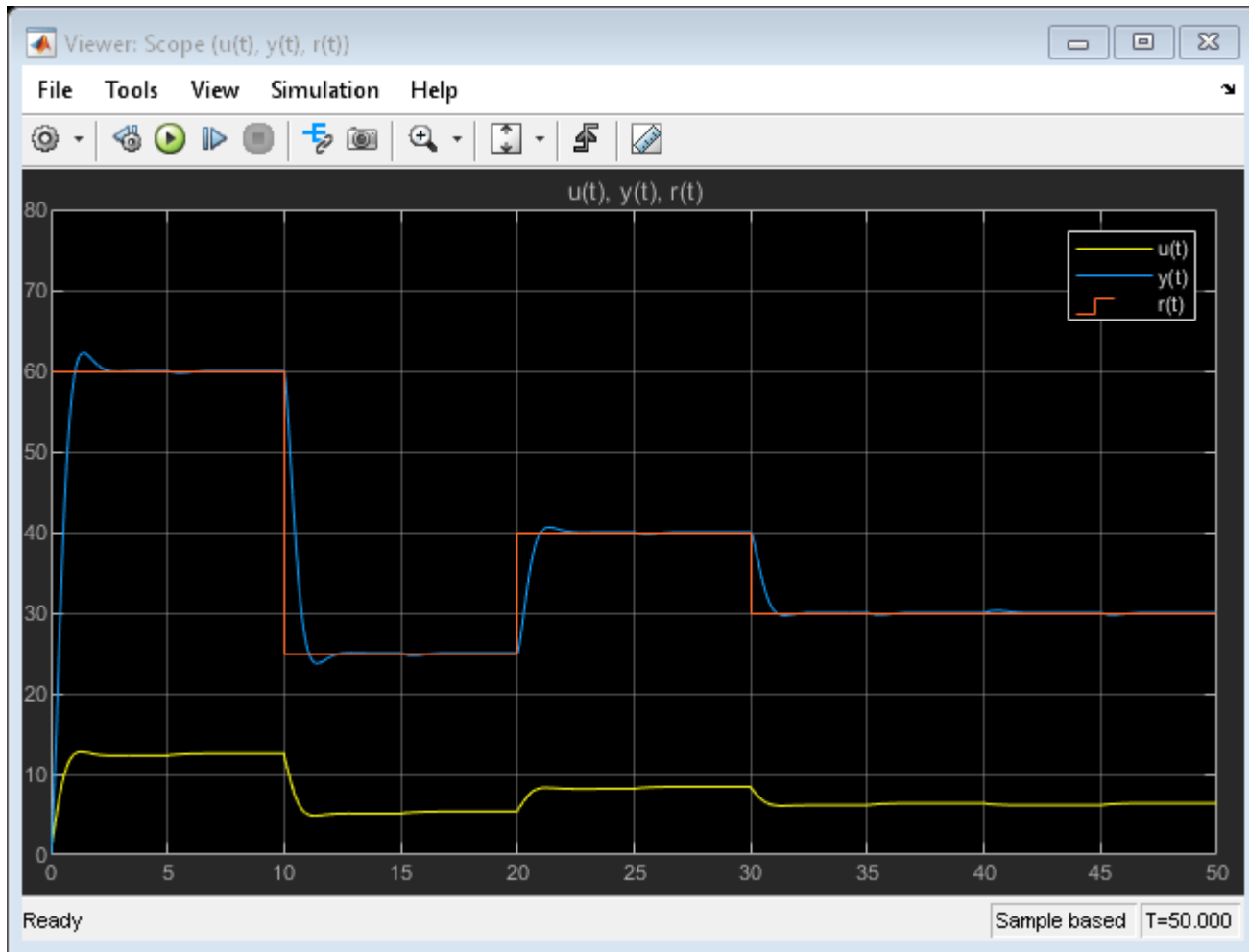

Figure 5: Control signal, setpoint vs. measured output.

The simulation results clearly show the absence of large transients in the control signal due to the sudden changes in the setpoint.

See Reference [1] for more information on how b and c are chosen.

Summary

The PID Controller (2DOF) block in Simulink supports two degree-of-freedom PID control. This block can be used for tracking complex setpoint profiles and moderating the impact of sudden setpoint changes on control signal transients. The PID tuner of Simulink® Control Design™ can be used to automatically tune all the gains (P, I, D, N, b , c) of the PID Controller (2DOF) block.

References

- 1 K. Åström, T. Hägglund, *Advanced PID Control*, ISA, Research Triangle Park, NC, August 2005.

See Also

PID Controller

More About

- “Continuous”
- “Simscape”

Data Typing in Simulink

This example shows how to use data types in Simulink®. The model used in this example converts a double-precision sine wave having an amplitude of 150 to various data types and displays the converted signals on two scopes.

The first scope shows the original sine wave and the result of converting this signal to signed and unsigned 8-bit integer data types with saturation enabled. The bottom axes show the boolean results of comparing the signed and unsigned integer values.

The second scope shows the original sine wave and the result of converting this signal to two fixed-point data types: one high-resolution, the other lower resolution. The bottom axes show the result of mapping the sine wave to an enumerated data type that indicates whether the signal is positive, negative, or zero.

Similar data type support exists for parameters and states. Simulink also supports other integer and floating-point data types, such as, single, int16, and uint32, and fixed-point types with slope/bias and wordlengths from 1 to 128 bits. You can also define types for bus signals and aliases for existing types.

NOTE: If you do not have a license for Fixed-Point Designer™ then the fixed-point signals will be replaced by single-precision signals.

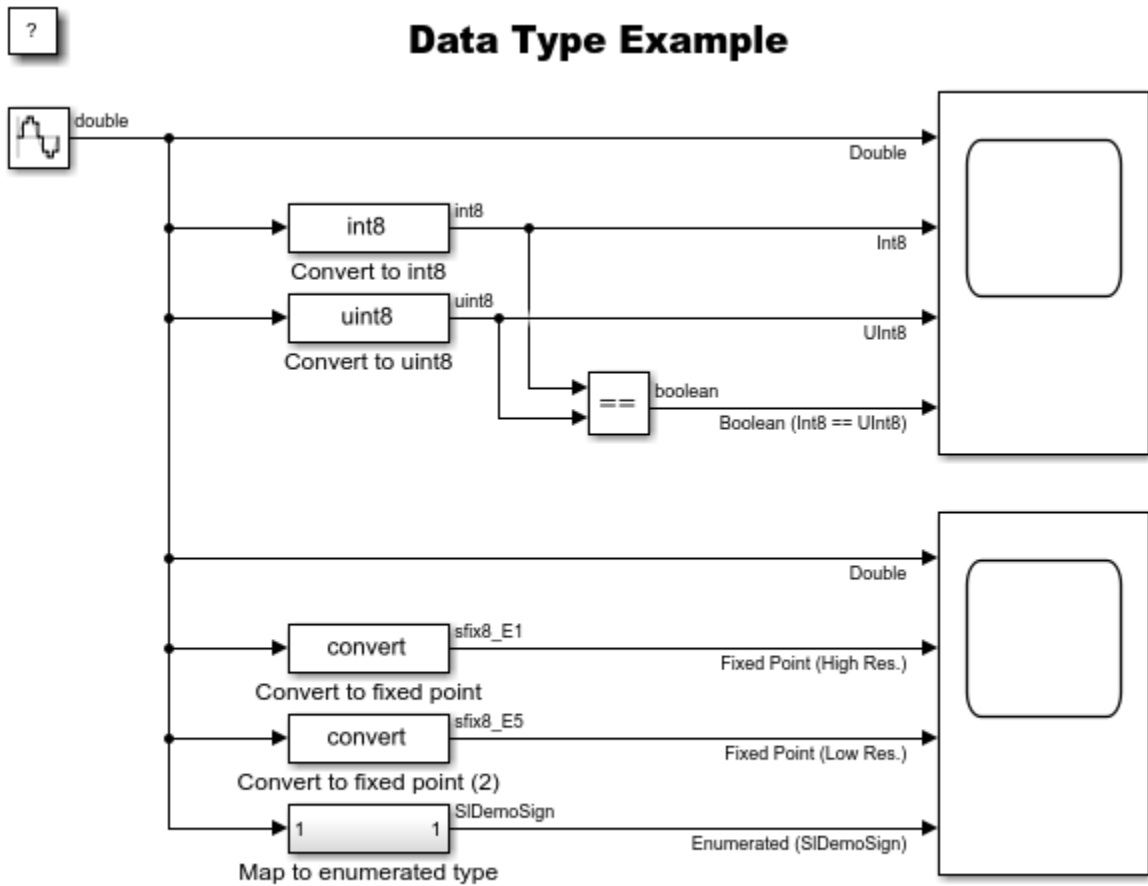

Copyright 2004-2015 The MathWorks, Inc.

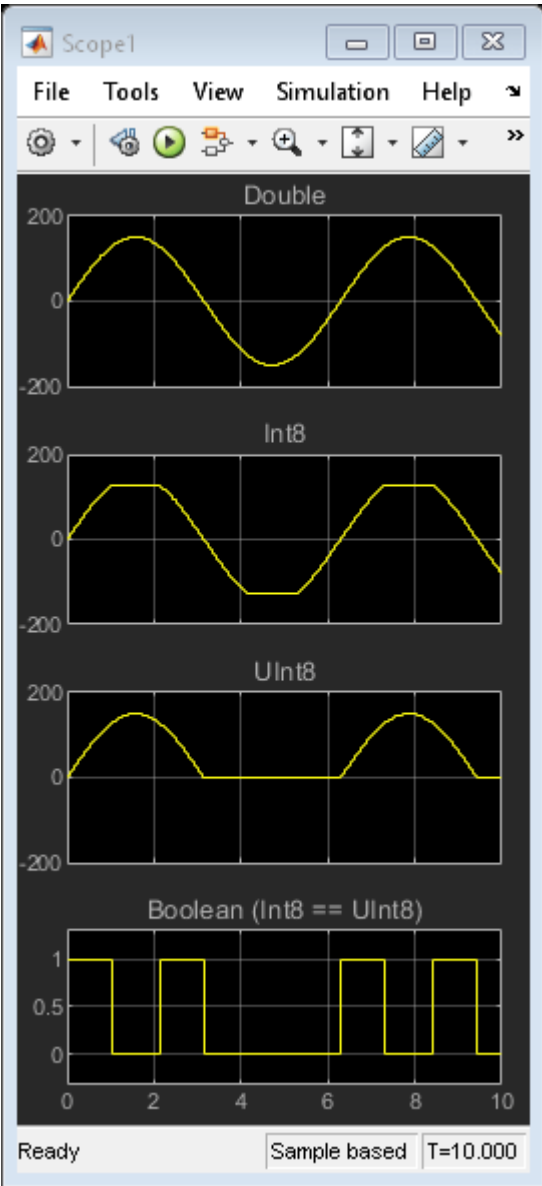

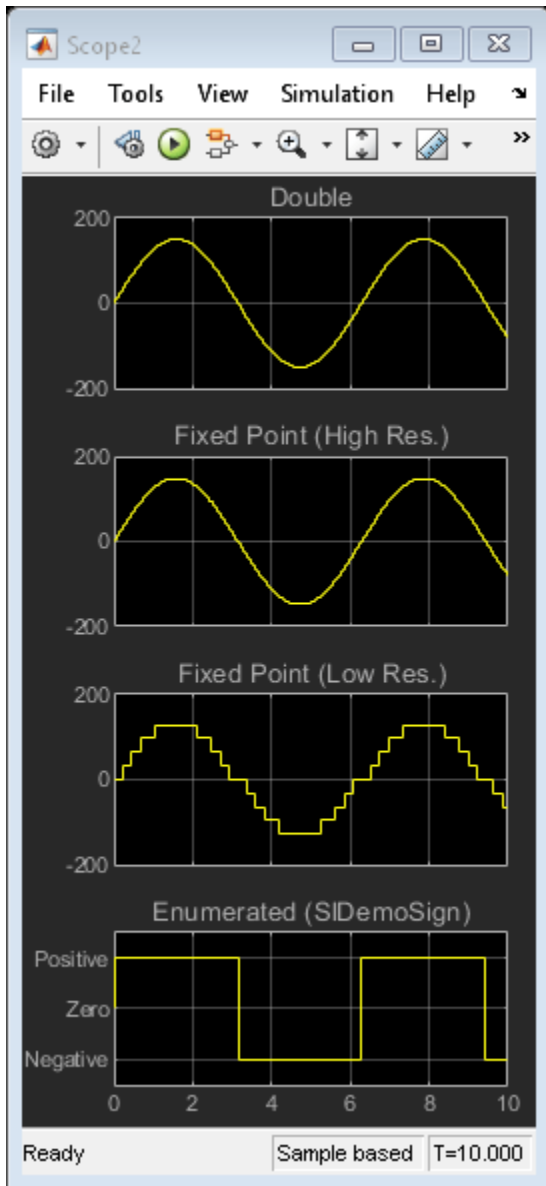

Data Typing Filter

This example shows how to apply a filter to signals of different data types using standard Simulink® blocks. In this example, a signal with some noise is produced. This signal is then fed into a filter as a single precision data type and a standard double data type. The output from the filter for each signal is then compared and the error is displayed on the scope.

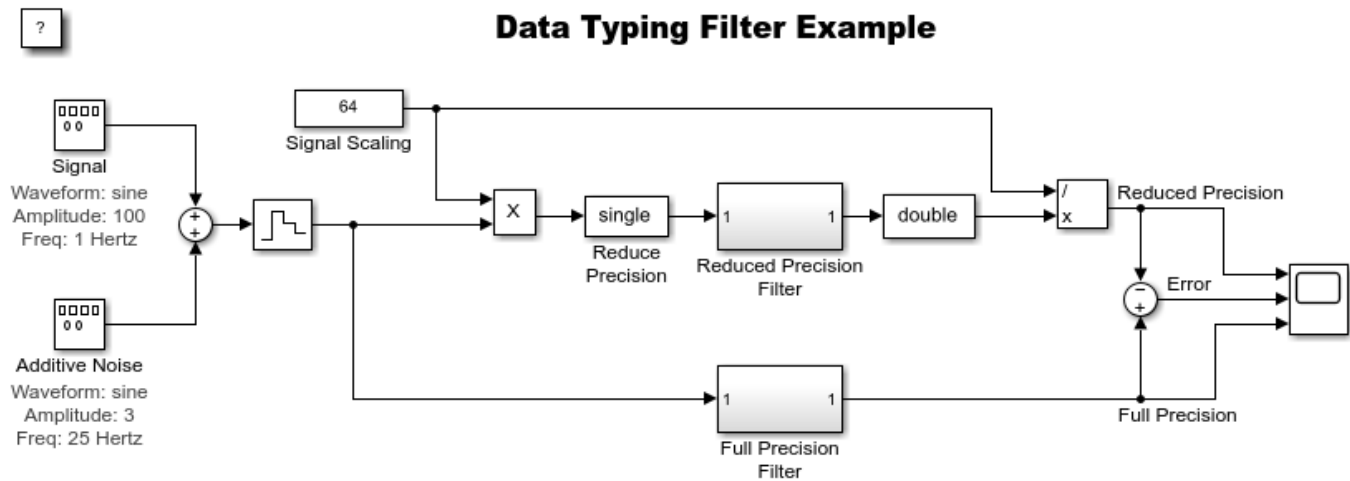

Copyright 2004-2015 The MathWorks, Inc.

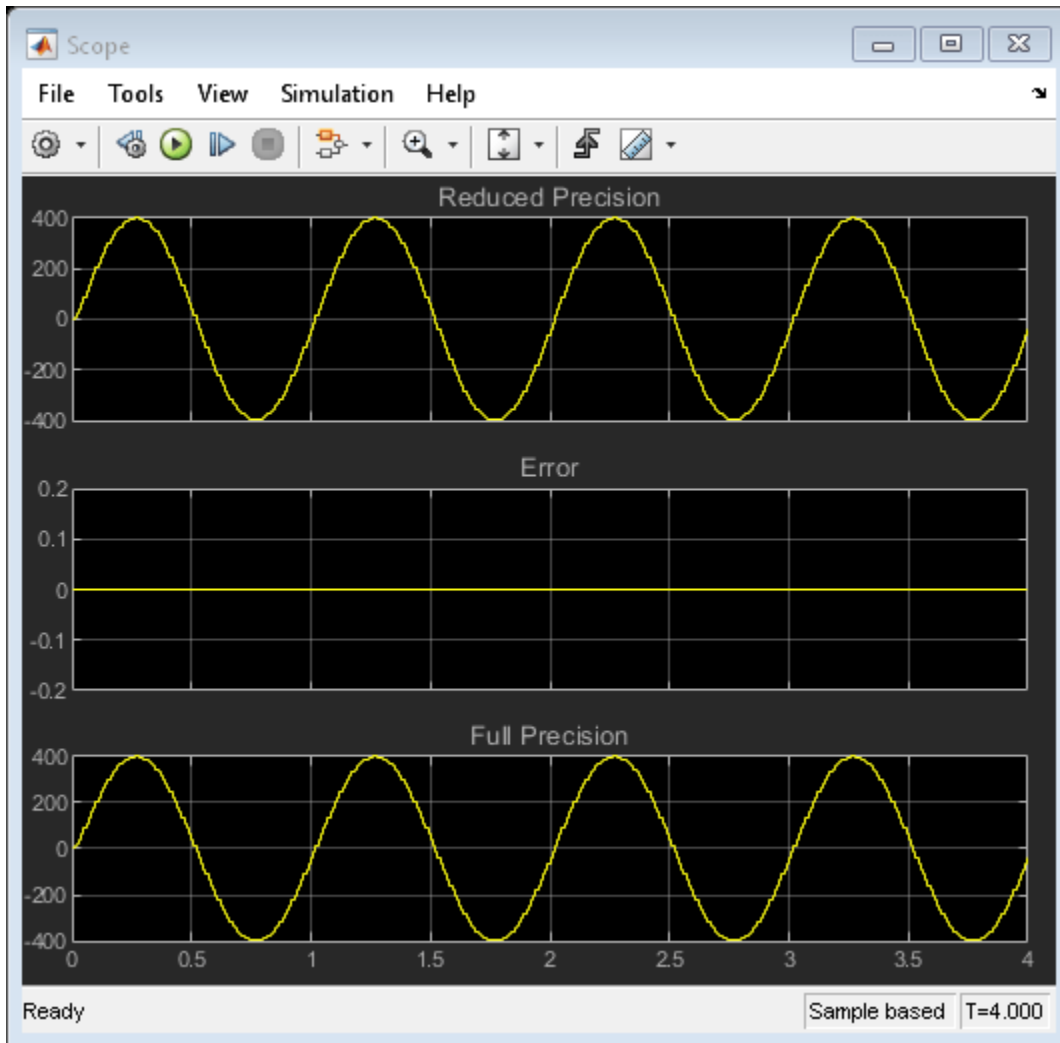

Explore Simulink Bus Capabilities

This example introduces you to Simulink® bus capabilities in three areas:

- Working with buses in components
- Using bus ports at component interfaces
- Smart editing to perform common bus workflows faster

Open the `sLexBusExample` model.

Explore Simulink Bus Capabilities ?

Working with Buses in Components

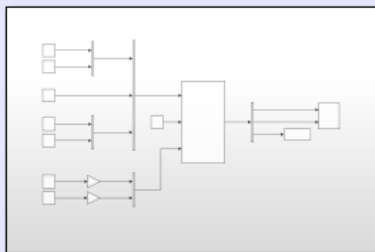

Bus Creation, Bus Element Selection, and Bus Element Assignment

Using Bus Ports at Component Interfaces

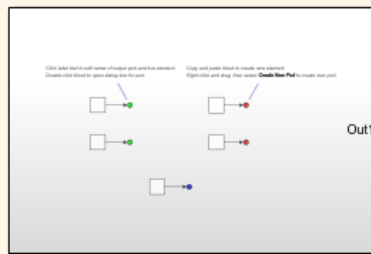

Bus Creation at Output Bus Port

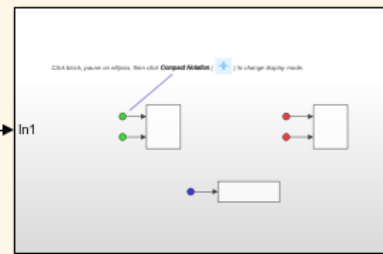

Bus Element Selection at Input Bus Port

Smart Editing to Perform Common Bus Workflows Faster

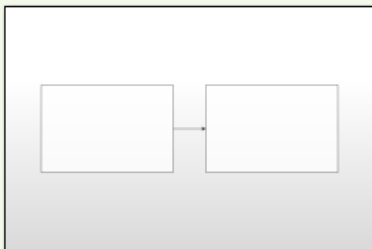

Conversion to Bus Ports

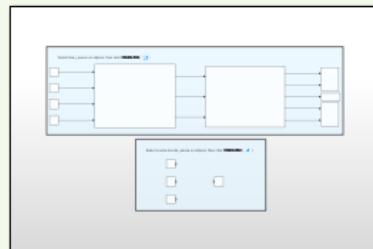

Bus Creation Actions

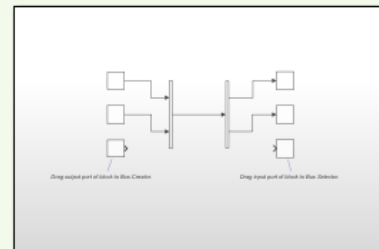

Automatic Port Creation on Blocks

Copyright 2004-2020 The MathWorks, Inc.

Display Bus Line Styles

When you open a model that contains buses, the buses have the same line style as scalar signals. To update the line styles, on the **Modeling** tab, select **Update Model**.

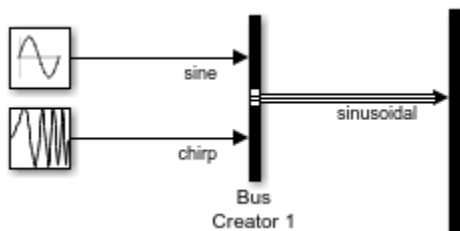

After the model compiles, several lines appear with three lines. This line style indicates that the line represents a bus.

Work with Buses in Components

The contents of the subsystem in the Working with Buses in Components area demonstrate how to:

- Create buses using Bus Creator blocks.
- Replace elements in a bus using a Bus Assignment block.
- Extract elements from a bus using a Bus Selector block.

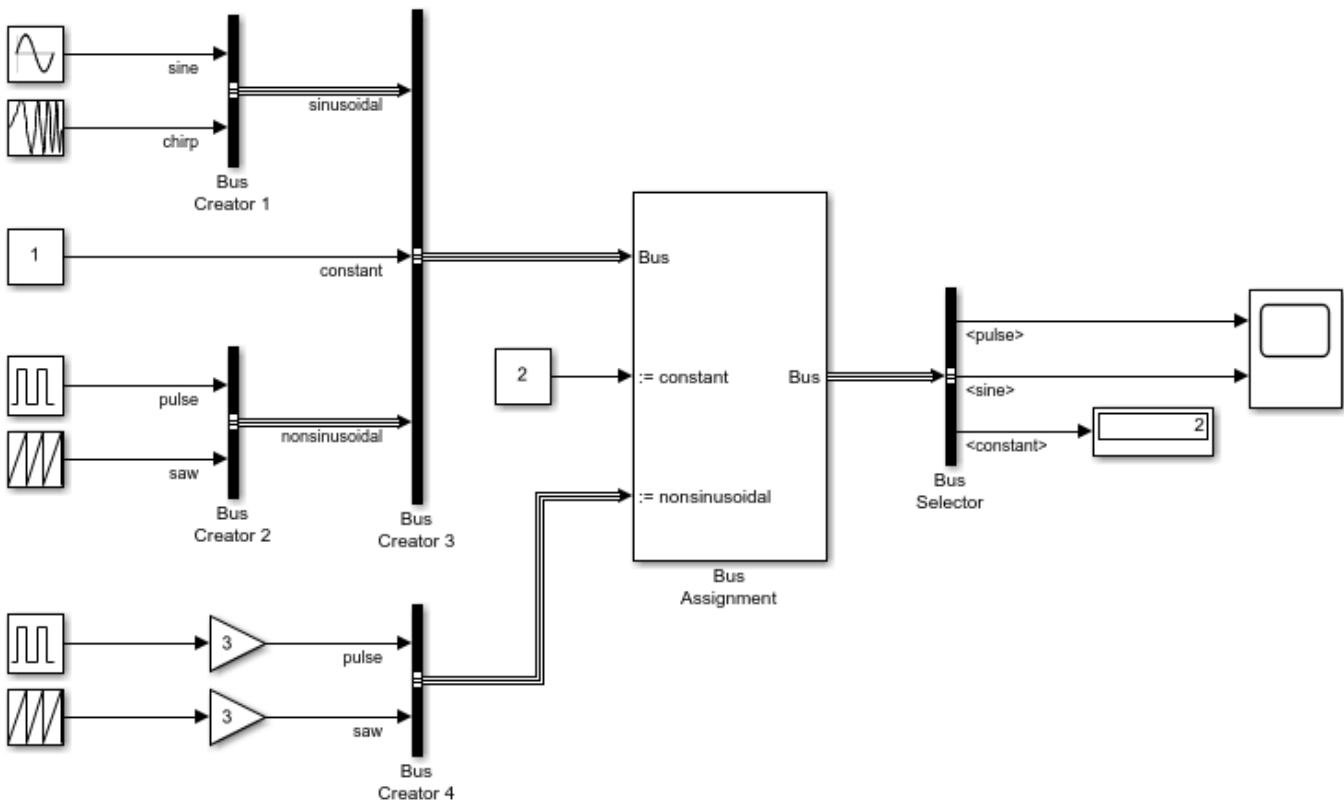

Each Bus Creator block groups the elements connected to its input port into a bus. A bus represents a set of elements, analogous to a bundle of wires tied together. For example, the bus created by the Bus Creator block named Bus Creator 1 contains the signals `sine` and `chirp`, which are connected to its input ports.

To view the hierarchy of the bus, click the bus and, on the **Signal** tab, select **Signal Hierarchy**.

You can also create *nested* buses. For example, `sinusoidal` and `nonsinusoidal` are nested buses in the bus created by the Bus Creator block named Bus Creator 3.

A Bus Assignment block replaces one or more elements in the bus that connects to its **Bus** input port. For example, the Bus Assignment block replaces the signals `constant` and `nonsinusoidal` in the bus created by the Bus Creator block named Bus Creator 3 with new signals. You can use the Bus Assignment block to replace nested buses and nonbus elements.

A Bus Selector block extracts one or more elements from the bus connected to its input. For example, the Bus Selector block selects the `nonsinusoidal.pulse`, `sinusoidal.sine`, and `constant` signals. To display the values of `nonsinusoidal.pulse` and `sinusoidal.sine` in the Scope block and `constant` in the Display block, simulate the model.

Use Bus Ports at Component Interfaces

The subsystems in the Using Bus Ports at Component Interfaces area demonstrate how to:

- Create buses at the output ports of components by using Out Bus Element blocks.
- Extract bus elements from the input ports of components by using In Bus Element blocks.

The first subsystem consists of five source blocks and five Out Bus Element blocks.

*Click label text to edit name of output port and bus element.
Double-click block to open dialog box for port.*

*Copy and paste block to create new element.
Right-click and drag, then select **Create New Port** to create new port.*

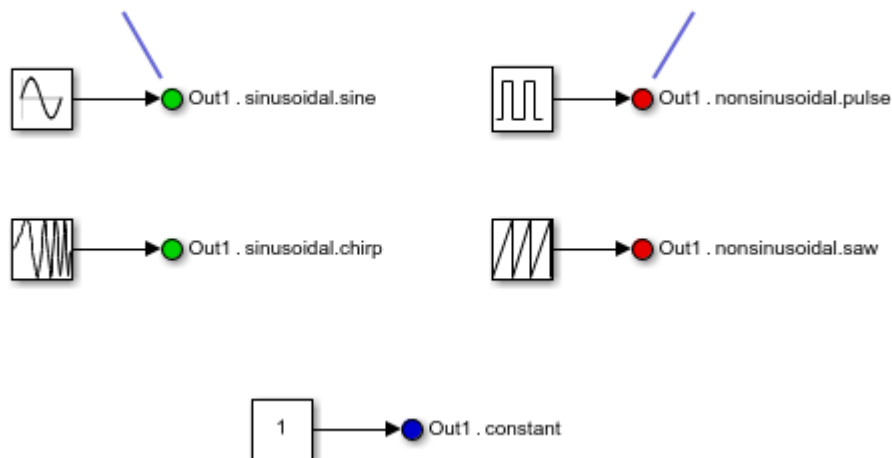

Out Bus Element blocks are similar to a Bus Creator block connected to an Outport block. Each Out Bus Element block has a label that you can edit directly to change the names of the output port and bus elements.



You can display the label in either expanded or compact notation.

- **Expanded Notation:** Label displays the corresponding port name and the element hierarchy. For example, the Out Bus Element block with the label `Out1.sinusoidal.sine` creates a bus element named `sine` in a nested bus named `sinusoidal` at the output port named **Out1**.
- **Compact Notation:** Label displays only the leaf bus element name. For example, the label `Out1.sinusoidal.sine` becomes `sine`.



In either mode, you can directly edit both parts of the label.

To create a new element in the bus, copy and paste an Out Bus Element block. To create a new output port at the interface, right-click and drag an Out Bus Element block, then select **Create New Port**.

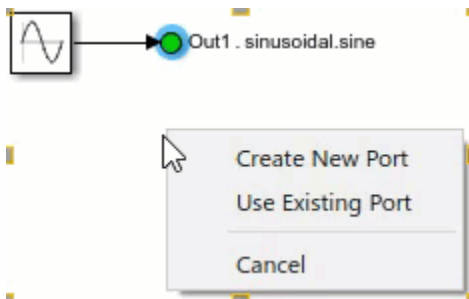

To see the bus created by a group of Out Bus Element blocks, double-click one of the blocks to open the dialog box for port properties. From the dialog box, you can:

- Change the name and number of the port.
- Highlight the lines that correspond to the elements you select.
- Change the colors of the blocks individually, by bus, or by selected elements.
- Reorder the elements in the bus.
- Add or delete bus elements and their corresponding blocks.
- Specify attributes.

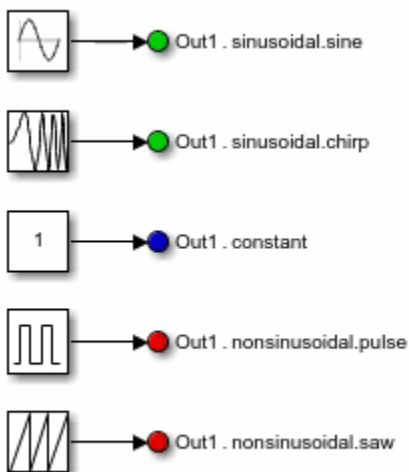

The second subsystem consists of two Scope blocks, one Display block, and five In Bus Element blocks.

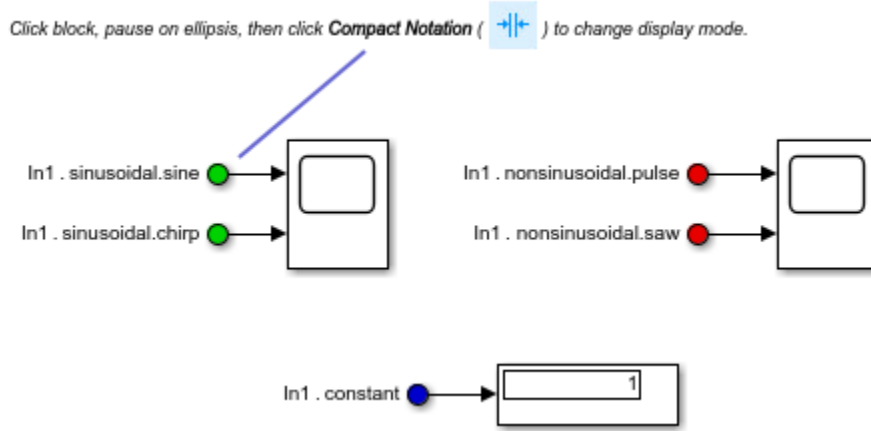

In Bus Element blocks are similar to an Inport block connected to a Bus Selector block. The labels of In Bus Element blocks work the same way as Out Bus Element block labels do. For example, the In Bus Element block with the label `In1 . sinusoidal . sine` selects a bus element named `sine` in a nested bus named `sinusoidal`.

To change the element selected from the input bus, edit the label text directly. When a bus is connected to the corresponding input port, you can select from the list of available signals.

`In1 . sinusoidal.sine` 

To select a new element from the bus, copy and paste an In Bus Element block. To create a new input port at the subsystem interface, right-click and drag an In Bus Element block, then select **Create New Port**.

To see the bus accessed by a group of In Bus Element blocks, double-click the icon of one of the blocks to open the dialog box for the port properties. From the dialog box, you can:

- Change the name and number of the port.
- Change the colors of the blocks individually, by bus, or by selected elements.
- Observe any missing or unused elements in the incoming bus.
- Add or delete blocks that correspond to selected elements.
- Specify attributes.

For more information about using In Bus Element and Out Bus Element blocks, see “Simplify Subsystem and Model Interfaces with Buses”.

Perform Common Bus Workflows Faster

The subsystems in the Smart Editing to Perform Common Bus Workflows Faster area show how to speed up common bus tasks:

- Convert Bus Selector and Bus Creator blocks to In Bus Element and Out Bus Element blocks.
- Create buses at subsystem interfaces and bundle outputs of individual blocks into a bus.
- Automatically create ports to add new elements to a Bus Creator block and select new elements from a Bus Selector block.

The **Bus Ports** smart editing cue converts Bus Selector and Bus Creator blocks at subsystem interfaces to In Bus Element and Out Bus Element blocks.

- 1 Click on a Bus Selector block that is connected to an Inport block or a Bus Creator block that is connected to an Outport block.
- 2 Select **Bus Ports** from the action bar.

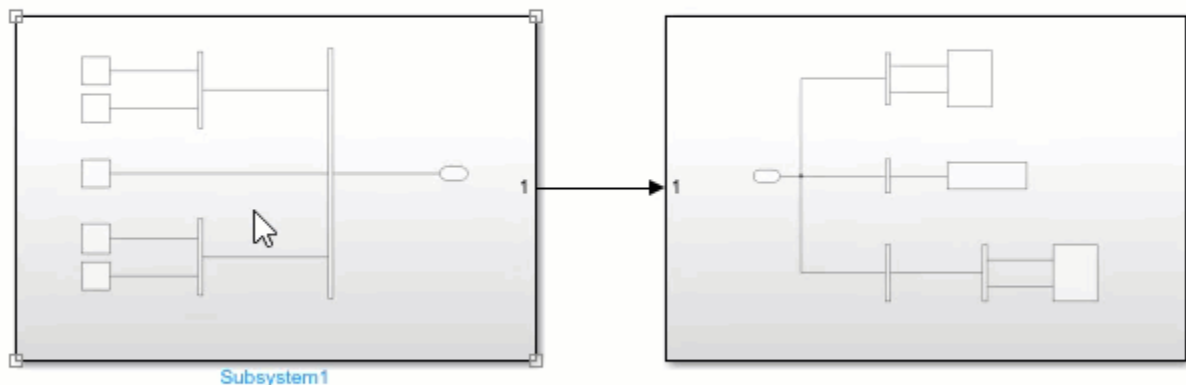

The **Create Bus** smart editing cue bundles multiple elements into a bus.

- 1 Drag a selection box around elements.
- 2 Select **Create Bus** from the action bar.

When creating a bus at subsystem interfaces, this action bundles the selected elements in a bus, replaces the Inport and Outport blocks with In Bus Element and Out Bus Element blocks in the subsystem, and adds Bus Creator and Bus Selector blocks to maintain connectivity outside of the subsystem.

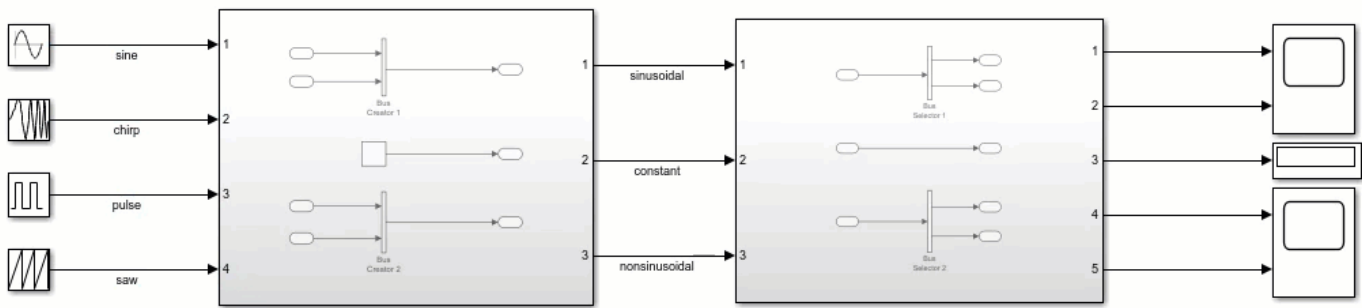

When creating a bus at the outputs of individual blocks, this action inserts a Bus Creator block, resizes it, and connects the elements.

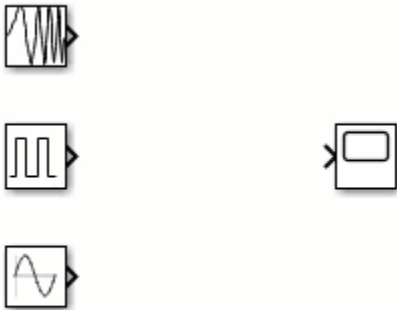

To add an element to a bus, drag a line to a Bus Creator block. To select an element from a bus, drag a line to a Bus Selector block and choose the element you want from the list of available elements.

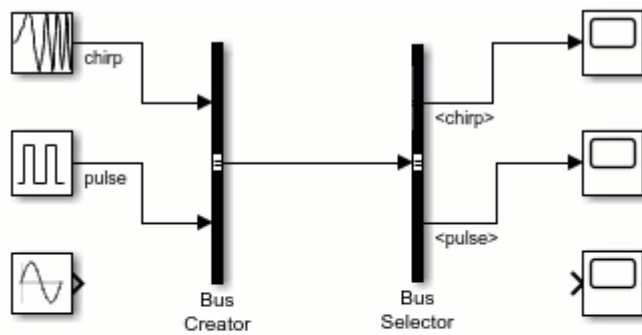

See Also

[Bus Assignment](#) | [Bus Creator](#) | [Bus Selector](#) | [In Bus Element](#) | [Out Bus Element](#)

Related Examples

- “Types of Composite Signals”
- “Group Signal Lines into Virtual Buses”
- “Simplify Subsystem and Model Interfaces with Buses”
- “Display Bus Information”
- “Replace Values of Bus Elements”

Model Arrays of Buses

Arrays of buses represent structured data compactly, eliminating the need to include multiple copies of the same buses. They also support iterative processing with For Each subsystems.

The input buses for an array of buses must be nonvirtual and of the same data type (with the same names, hierarchies, and attributes for the bus elements).

Open the `sldemo_bus_arrays` model.

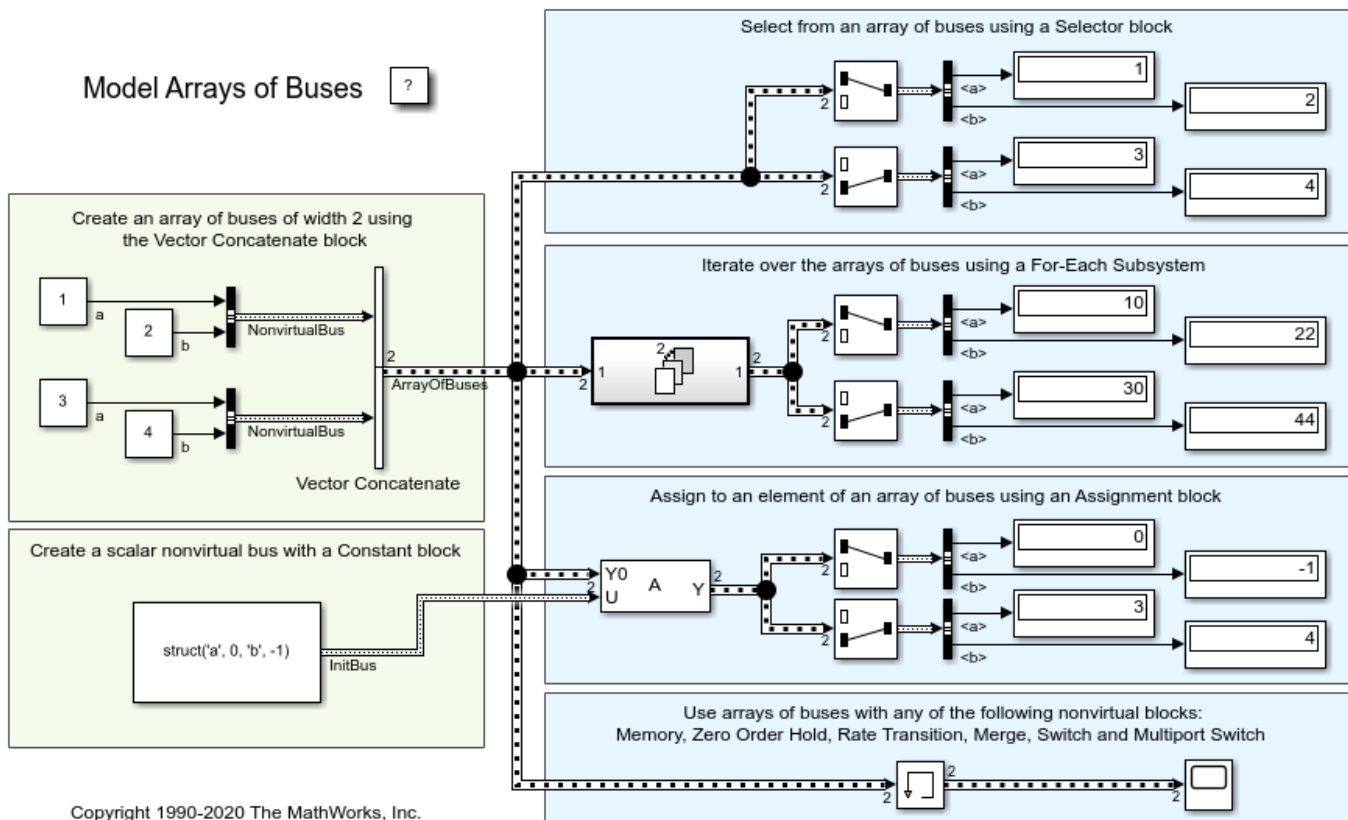

In this model, a Vector Concatenate block creates an array of buses from nonvirtual buses, and a Constant block creates an array of buses from a struct.

The model uses the array of buses with:

- Selector blocks, to extract nonvirtual buses from the array of buses.
- An Assignment block, to assign a bus in the array.
- A For Each Subsystem block, to iteratively process each bus in the array.
- A Memory block, to output the array of buses input from the previous time step.

See Also

Vector Concatenate

Related Examples

- “Types of Composite Signals”
- “Group Nonvirtual Buses in Arrays of Buses”
- “Work with Arrays of Buses”
- “Convert Models to Use Arrays of Buses”
- “Repeat an Algorithm Using a For Each Subsystem”

Matrix Signals

This example shows how to use matrix and frame signals in Simulink® diagrams. Through this example, you can access models that relate to the following practical applications.

- Feedback Systems
- Lunar Module Digital Autopilot
- Matrix Support S-Function
- Frame Signals

Matrix and Frame Support Models

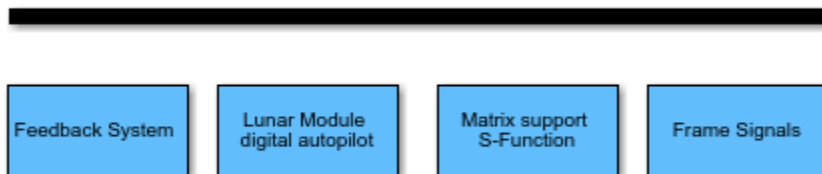

Copyright 2005-2015 The MathWorks, Inc.

See Also

Related Examples

- "Signals"

Variable-Size Signal Basic Operations

This example shows how variable-size signals can be generated. It also illustrates some of the operations that can be applied to them. The purpose of this example is to introduce the basic operations associated with variable-size signals.

About This Example

The model contains several blocks that support variable-size signals.

Common ways of generating variable-size signals are:

- Use a Switch block with a different size signal at each input port.
- Use a Selector block and allow the size selection index to change over time.

Eighty blocks can operate with variable-size signals including the Gain block, the Sum block, the Math Function block, the Matrix Concatenate block, and the Bus Creator block. In addition, you can probe variable-size signals using the Width or the Probe block, display variable-size signals on Scope blocks, and save variable-size signals to the workspace using the To Workspace block.

For a complete list of blocks that support variable-size signals, see “Simulink Block Support for Variable-Size Signals”.

Variable-Size Signal Generation and Operations

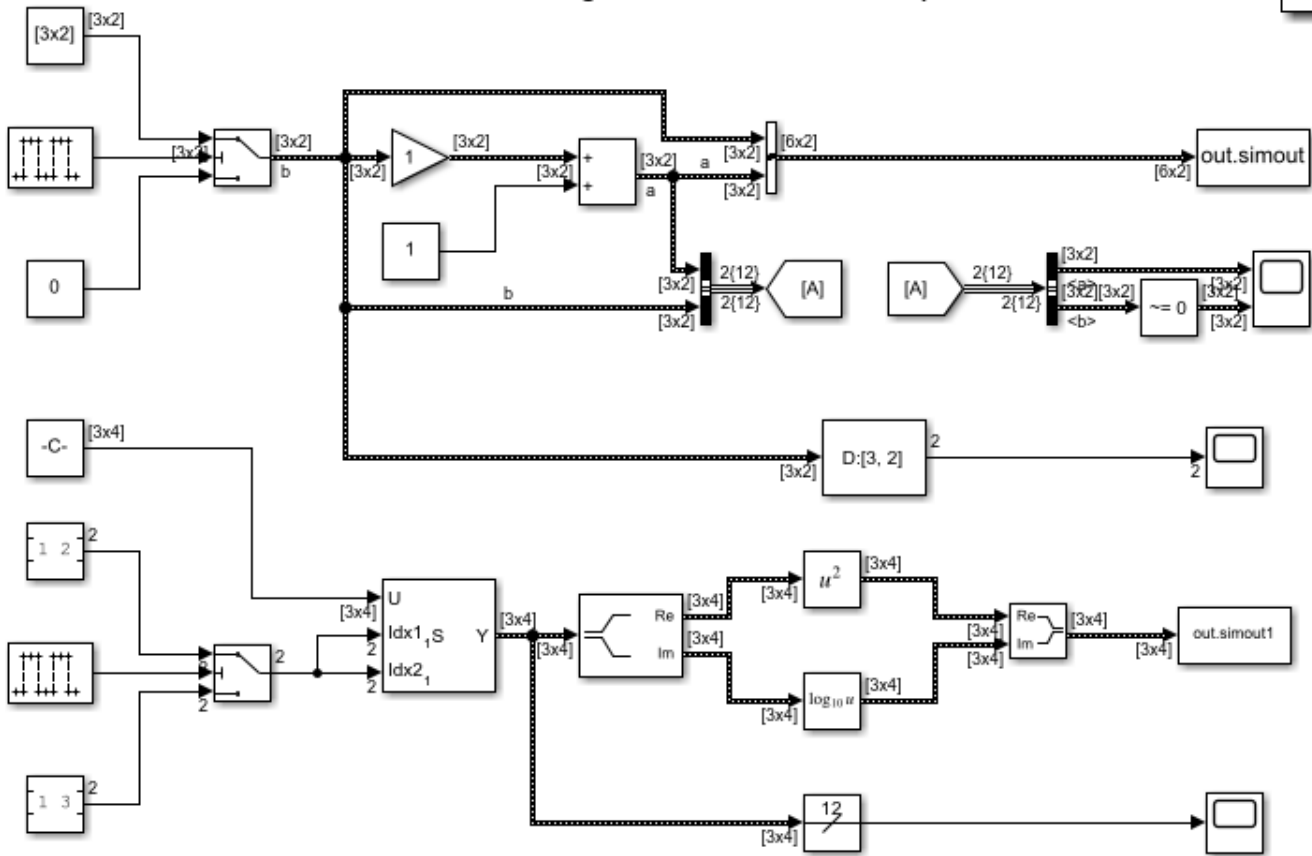

Copyright 2009-2013 The MathWorks, Inc.

Variable-Size Signal Length Adaptation

This example shows a hypothetical system where the length of a signal changes over time by adapting to the changes of a control signal.

About This Example

Open the example model.

This model consists of two sections: the left section generates a signal and converts the signal to variable size; the right section processes the variable-size signal and outputs it to a scope. Length adaptation is based on the value of the control signal. When the control signal falls within one of the three predefined ranges, the size of the data signal changes accordingly.

This variable-size signal is then fed into a processing block, where blocks supportive of variable-size signals operate on it. Note the application of a MATLAB Function block with both the input and the output signals of variable-size. The resulting signal and the signal width are fed to a scope for visualization.

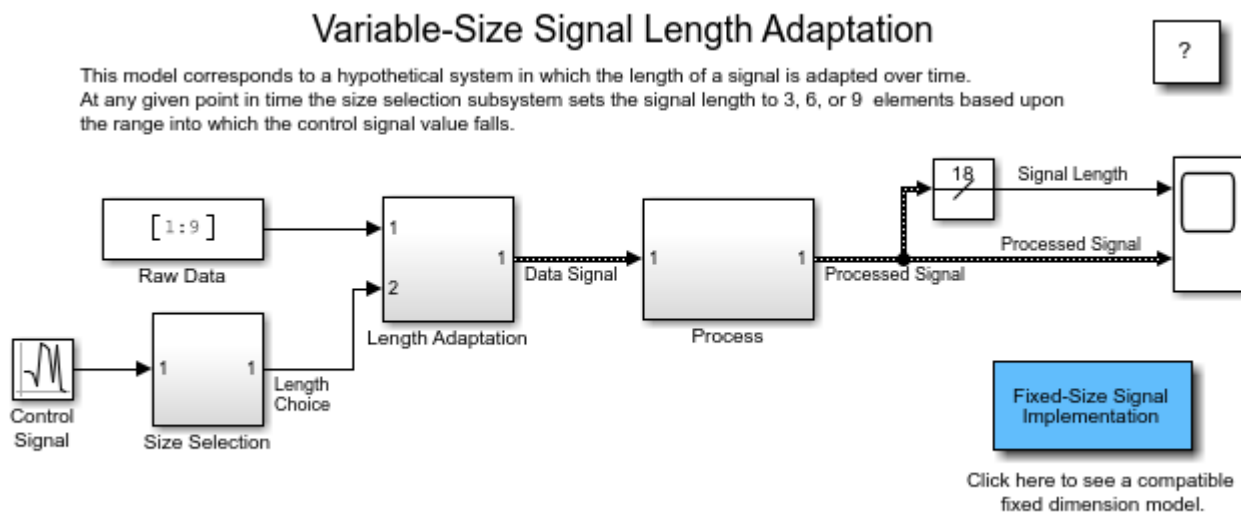

Copyright 2009-2015 The MathWorks, Inc.

Multimode Variable-Size Signal

This model shows how to use different operation modes to correspond to different signal sizes.

About This Example

Open the example model:

Mode-Dependent Variable-Size Signals



This model represents a system that has three operation modes. For each mode, the signal has a different size. One Function-Call subsystem with variable-size signals handles the processing of the different signal sizes for each mode. The Mode Control Logic block detects the data signal length changes, and responds by issuing mode switching events. This event triggers the reset of the state and the repropagation of signal sizes within the subsystem.

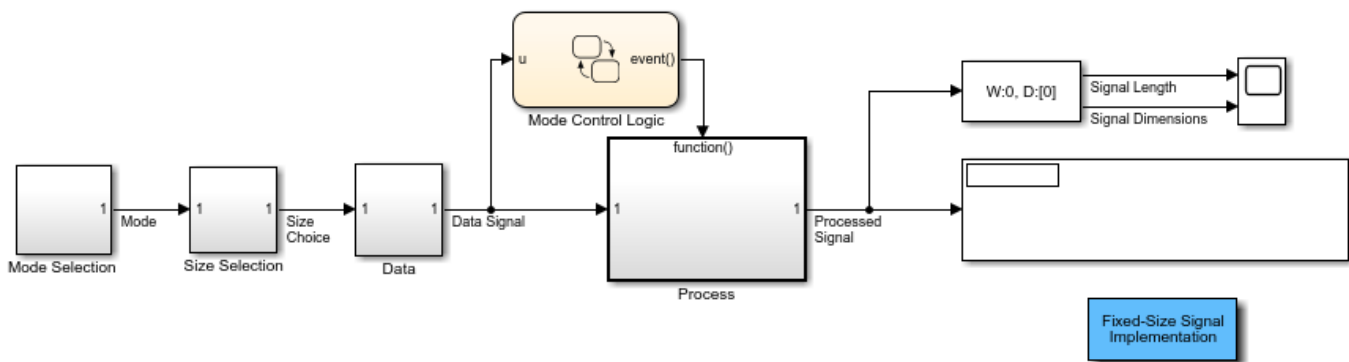

Copyright 2009-2015 The MathWorks, Inc.

[Click here to see a compatible fixed-size model.](#)

The processing subsystem in this model receives a variable-size signal, where the size of the signal depends on the operation mode of the system. For each mode change, the Mode Control Logic Stateflow® Chart generates a function-call to reset the blocks contained in the Process subsystem.

Parallel Channel Power Allocation

This model shows a potential use of the Find Nonzero Elements block. This block outputs a variable-size signal containing the indices of the nonzero values of the input.

Open the example model `sldemo_varsize_channel_pow_alloc`. This model implements the waterfilling algorithm for obtaining the optimal power allocation for communication channels when a power budget exists. The communication channels involved are independent (i.e., parallel channels) and have different noise levels.

The algorithm iteratively increases the value of the waterline, so that the channels which have a noise level less than the waterline are broadcast. The power used by these transmitting channels is equal to the difference between the waterline and the noise level of the channel. The sum of the power used by all the channels transmitting should satisfy the power budget within the specified tolerance.

The Find Nonzero Elements block is used in the calculation of the total power used for a certain waterline value. The channels which are set to transmit at that waterline level are selected using logical indexing. The logical indices are obtained after thresholding the difference of the waterline and the channel noise levels. As a result, the channels with noise levels larger than the waterline are assigned a logical 0, and those with noise levels below the waterline are assigned a logical 1. The Find Nonzero Elements block is used for converting the logical indices into linear indices. Note that this signal is properly modeled by a variable-size signal, since the number of channels below the threshold is unknown at compile time. The linear indices are fed into a Selector block that picks the channel transmission powers. Subsequently, these powers are summed to get the current value of used power. If this value is smaller than the power budget, the waterline is increased and the process is repeated until the used power equals the power constraint.

Optimal Power Allocation for Parallel Channels (Waterfilling)

The NL signal contains the channel noise levels.
The Pcon signal is the total available power budget.
Tol is the tolerance to use in the search for the waterline level.

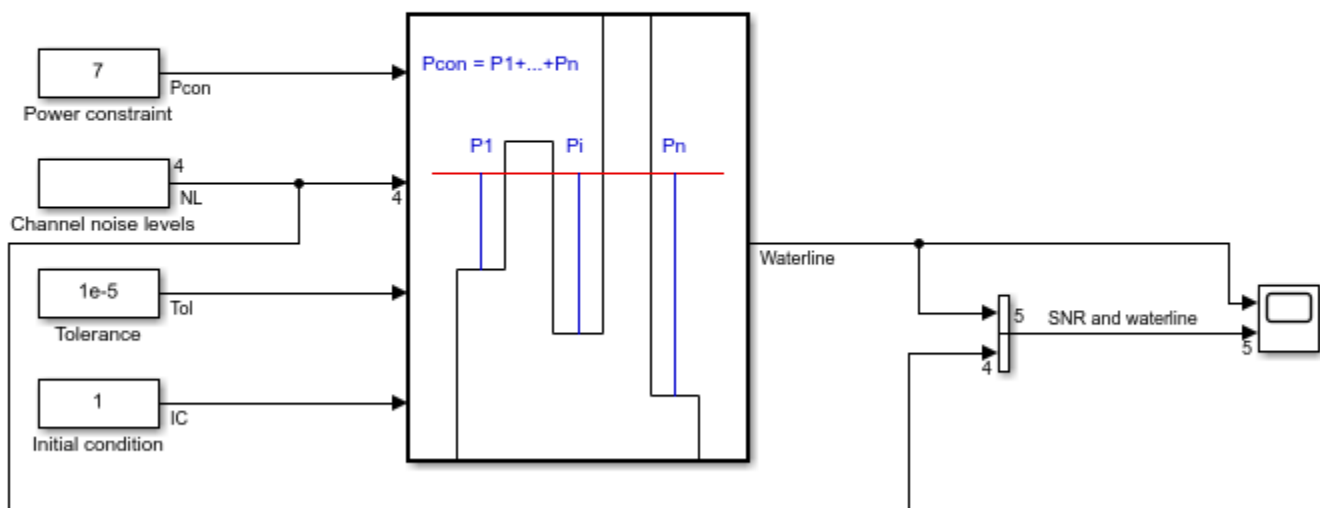

Copyright 2009-2013 The MathWorks, Inc.

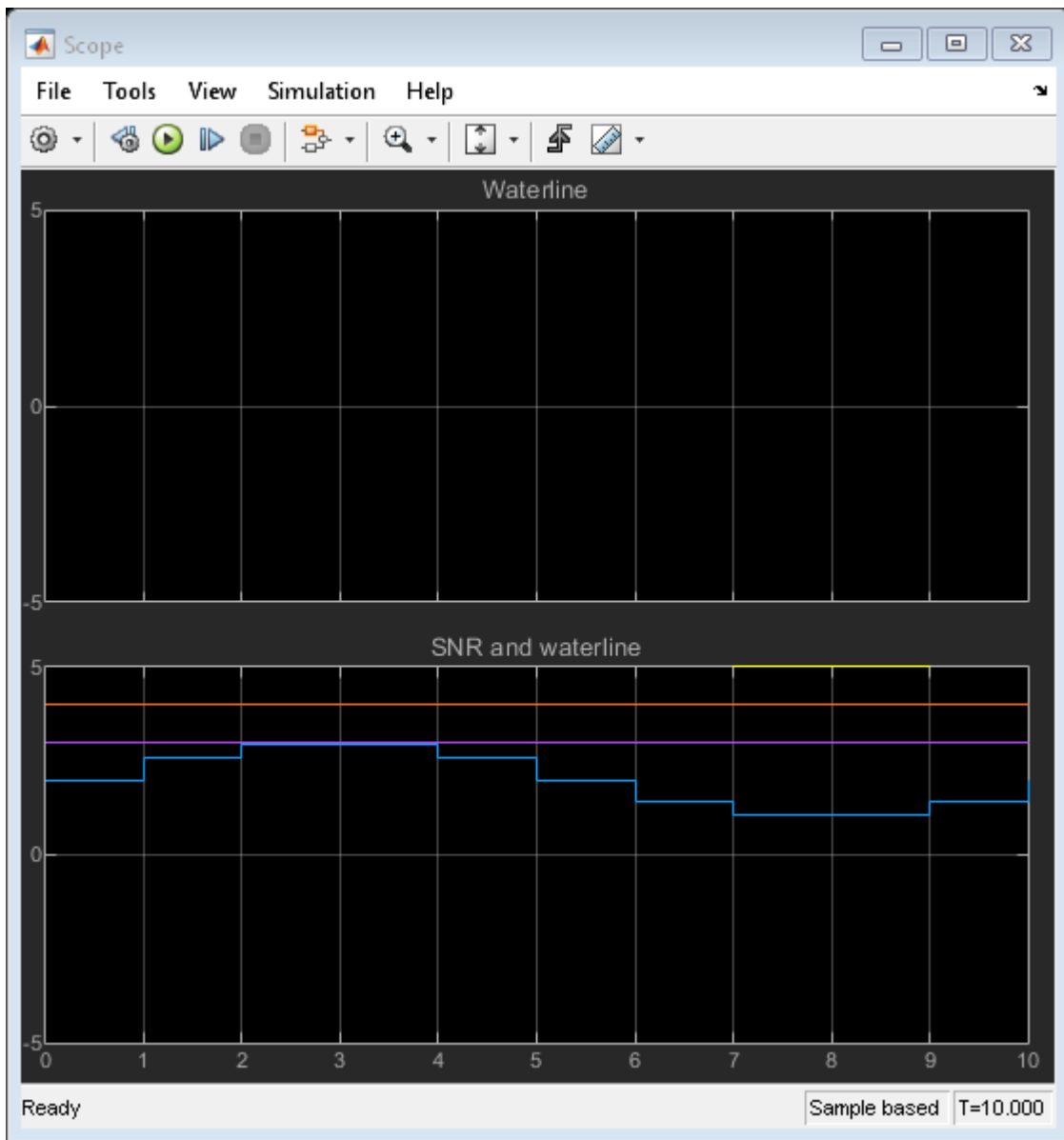

Merging Signals

This example shows how to use conditionally executed subsystems and the Merge block to combine two inputs into a single output. The Merge block output value at any time is equal to the most recently computed output of its driving blocks.

Use Merge blocks to interleave input signals that update at different times into a combined signal in which the interleaved values retain their separate identities and times. To combine signals that update at the same time into an array or matrix signal, use a Vector Concatenate, Matrix Concatenate block.

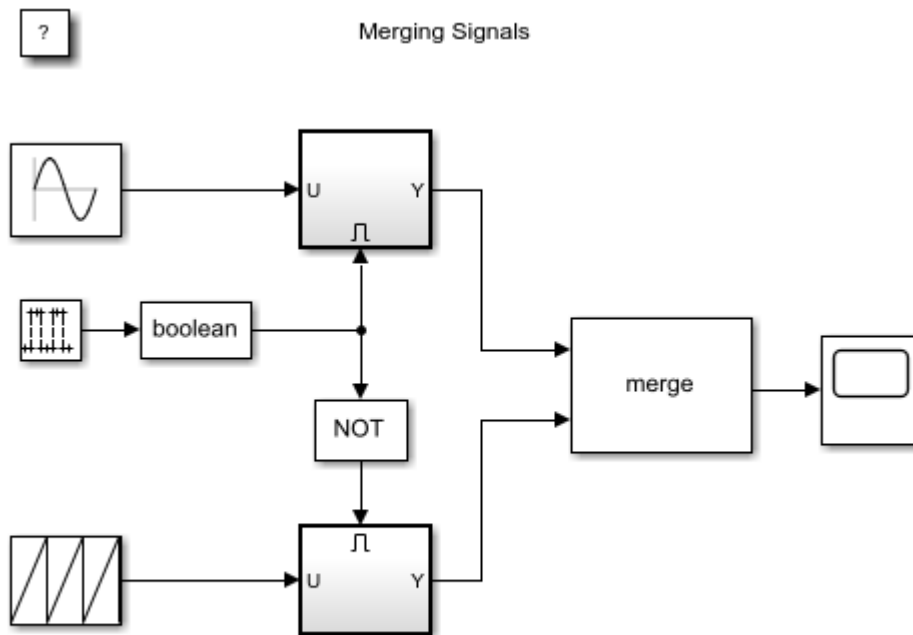

Copyright 2004-2015 The MathWorks, Inc.

The left side of the model contains two blocks Repeating Sequence blocks from the Simulink Sources library. Each block generates a scalar output signal of the form displayed on the block icon.

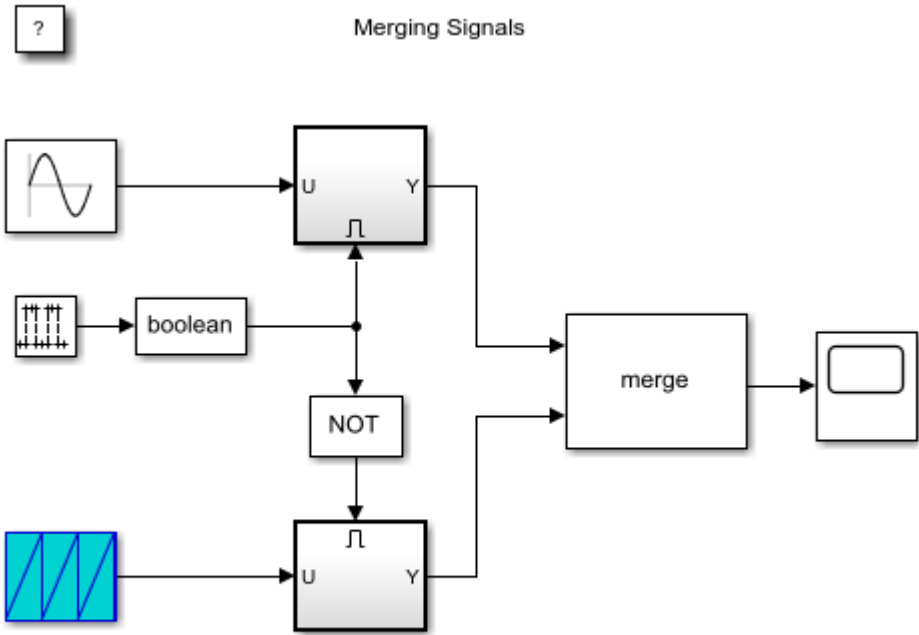

Copyright 2004-2015 The MathWorks, Inc.

These two signals are input into different Enabled Subsystem blocks, which are outlined with thick lines.

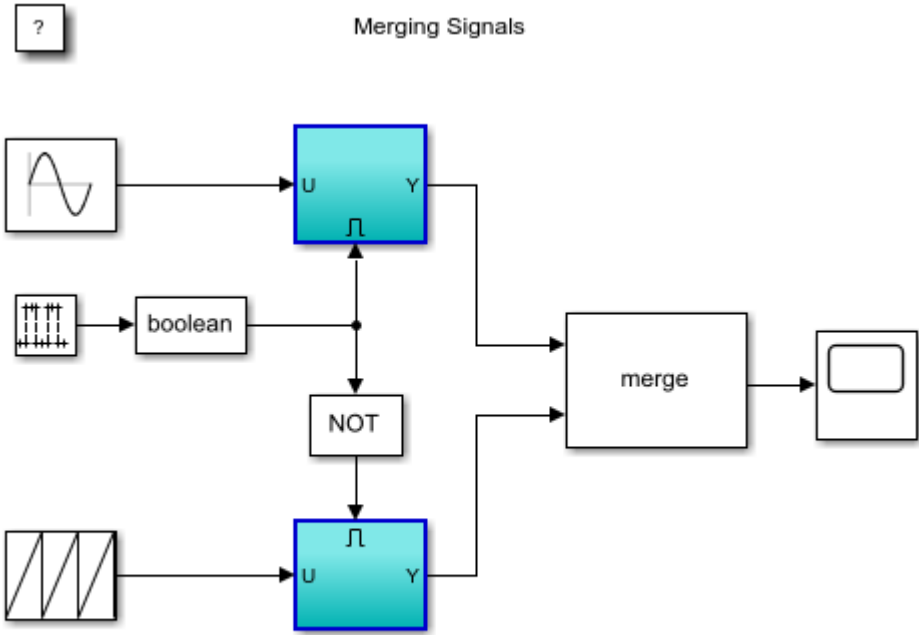

Copyright 2004-2015 The MathWorks, Inc.

A signal generated by the Pulse Generator block controls the enabled (or conditionally executed) subsystems.

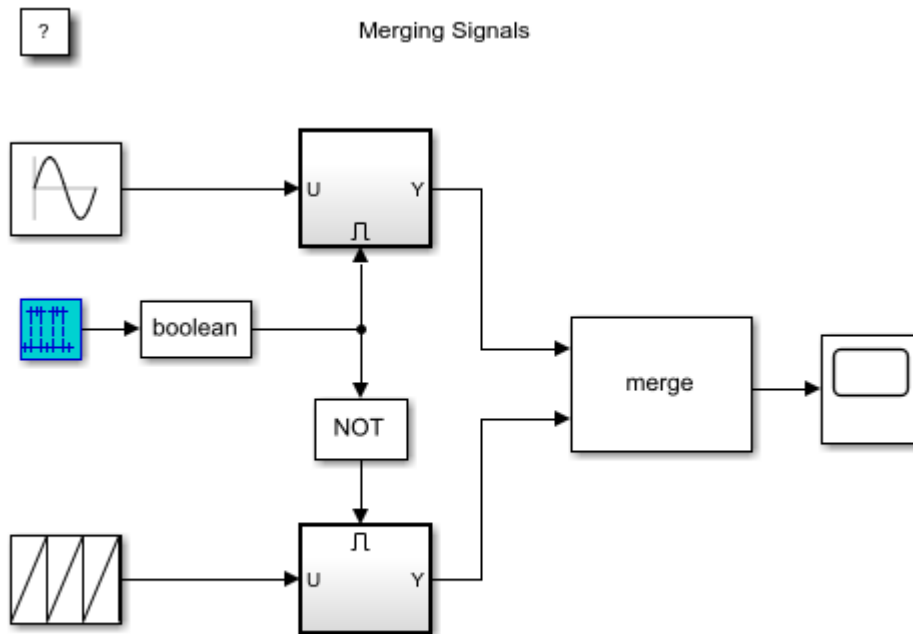

Copyright 2004-2015 The MathWorks, Inc.

This block output toggles between the values of zero and one every five seconds. When the output of the Discrete Pulse Generator block is positive, the top enabled subsystem is simulating. When the output of the Discrete Pulse Generator block is zero, the bottom enabled subsystem is simulating.

To force the bottom enabled subsystem to simulate when the Discrete Pulse Generator block output is zero, the output is passed through a Logical Operator block set to the NOT operator. The NOT block outputs a value of one when its input is zero.

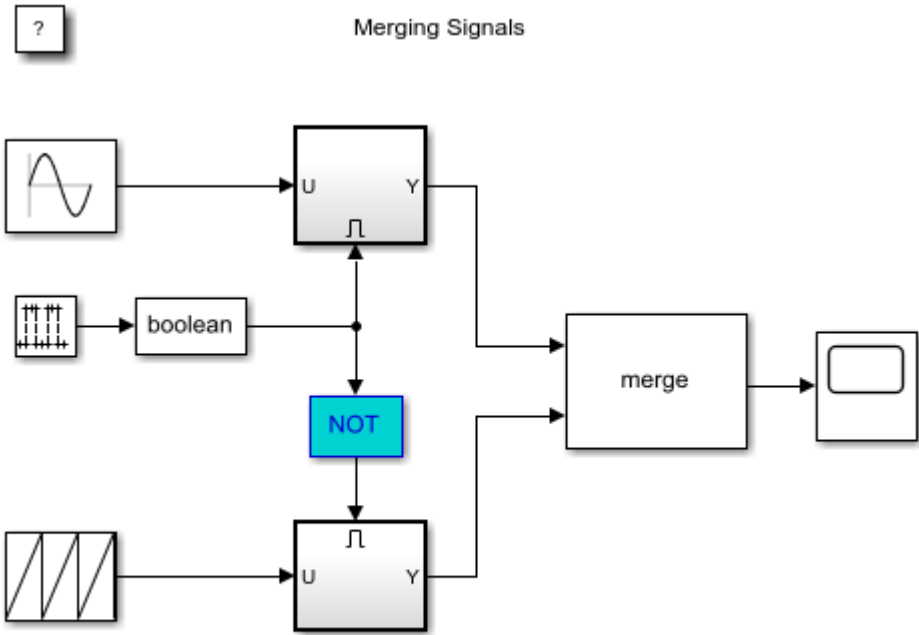

Copyright 2004-2015 The MathWorks, Inc.

The outputs of the two enabled subsystems are input into a Merge block.

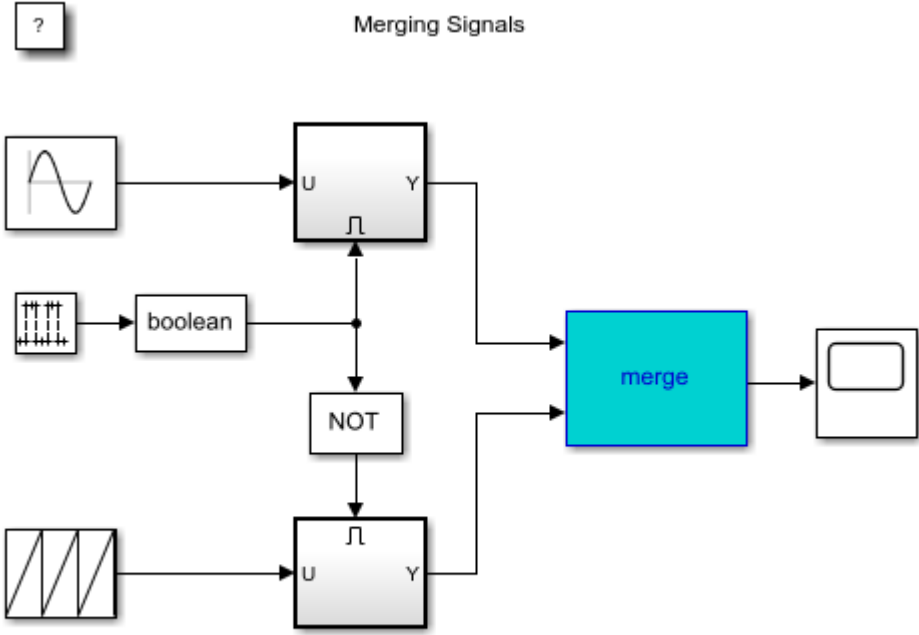

Copyright 2004-2015 The MathWorks, Inc.

A Scope block displays the Merge block output.

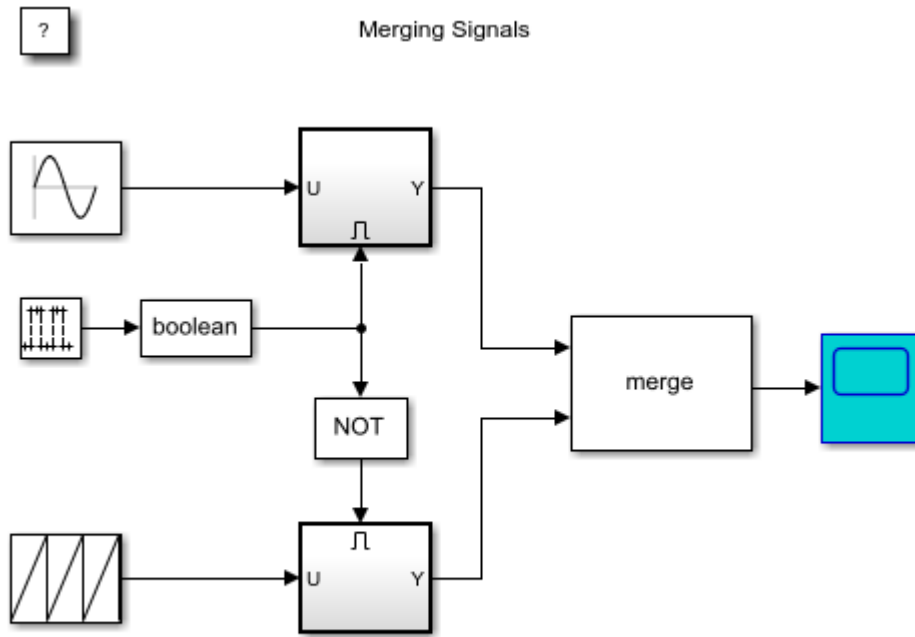

Copyright 2004-2015 The MathWorks, Inc.

Run the simulation to see the output of the Merge block on the Scope. Notice that the type of waveform shown on the Scope changes every five seconds. Due to the behavior of the Merge block, the type of waveform shown on the Scope changes every five seconds.

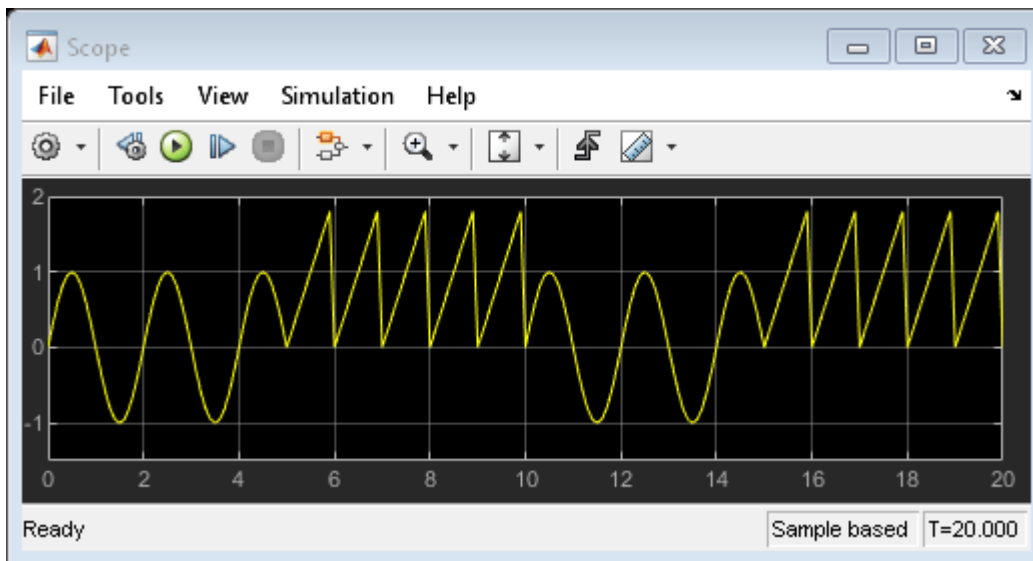

Conditionally Executed Subsystems

This Merge block example contains two conditionally executed subsystems.

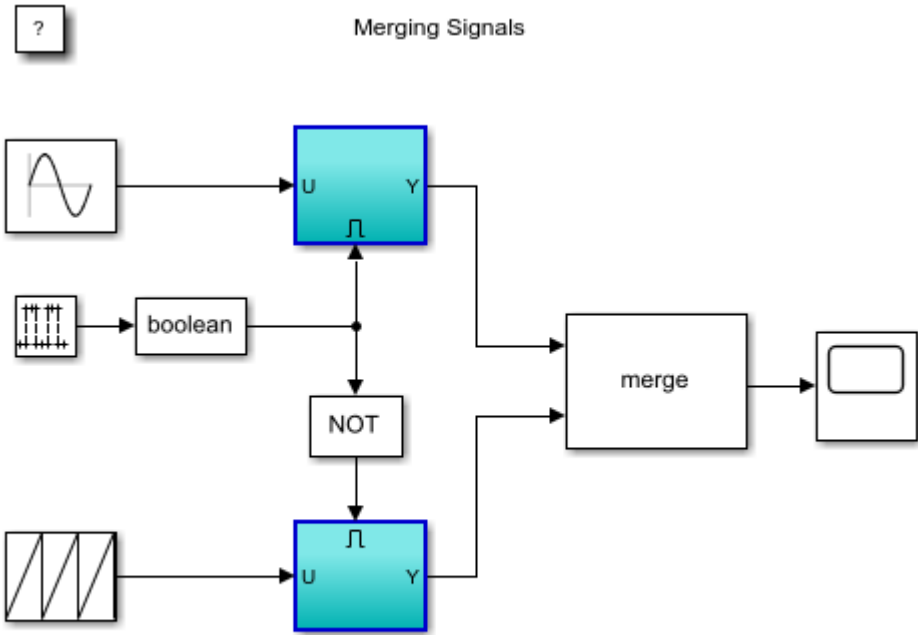

Copyright 2004-2015 The MathWorks, Inc.

A conditionally executed subsystem is a subsystem that is only executed at times during the simulation when certain conditions are met. In this case, the subsystems are enabled subsystems, distinguished by their icons and the additional input port on the top or bottom of the block.

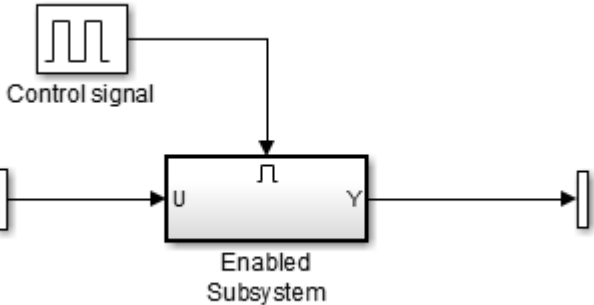

The signal feeding into the additional port is called the control signal. The value of this signal provides the condition that determines whether the subsystem is executed or not, at any given time step. Enabled subsystems are executed when the control signal is strictly positive.

In this example, you want to execute one of the enabled subsystems when the control signal is positive, and the other when the control signal is zero. You can do this by using the Logical Operator block.

Logical Operator Block

The Logical Operator block provides a method for incorporating logical operators and boolean signals into your model.

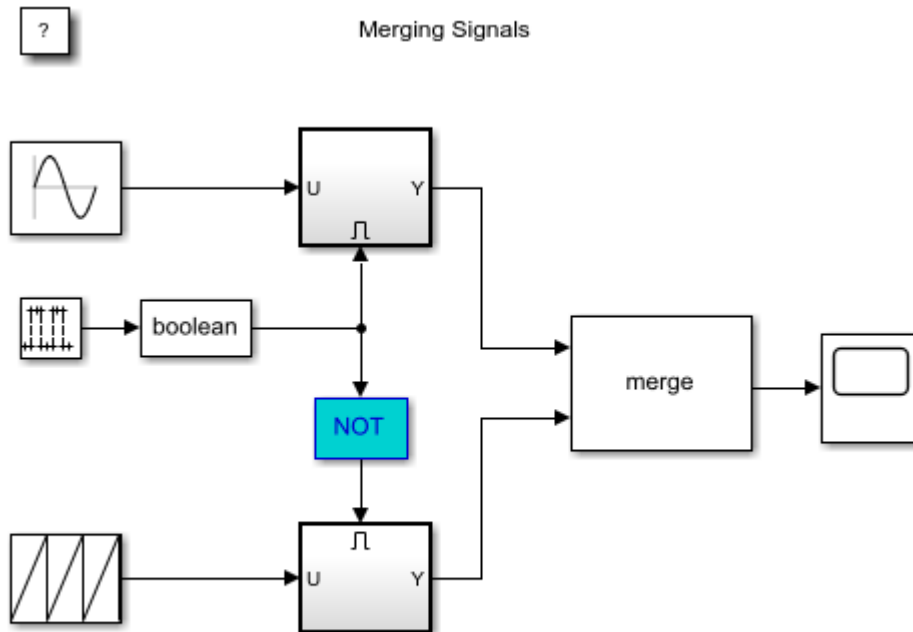

Copyright 2004-2015 The MathWorks, Inc.

Open the Logical Operator block to see the different types of operators. The current setting of NOT returns 1 (or TRUE) when the input signal is non-zero, or 0 (FALSE) when the input signal is strictly zero.

In this example, use this feature to generate a positive value when the control signal goes to zero by maintaining the current operator setting of NOT and closing the dialog.

Note: In the Simulink Editor, on the **Debug** tab, the **Information Overlays** menu offers options for displaying signal and port properties on the block diagram.

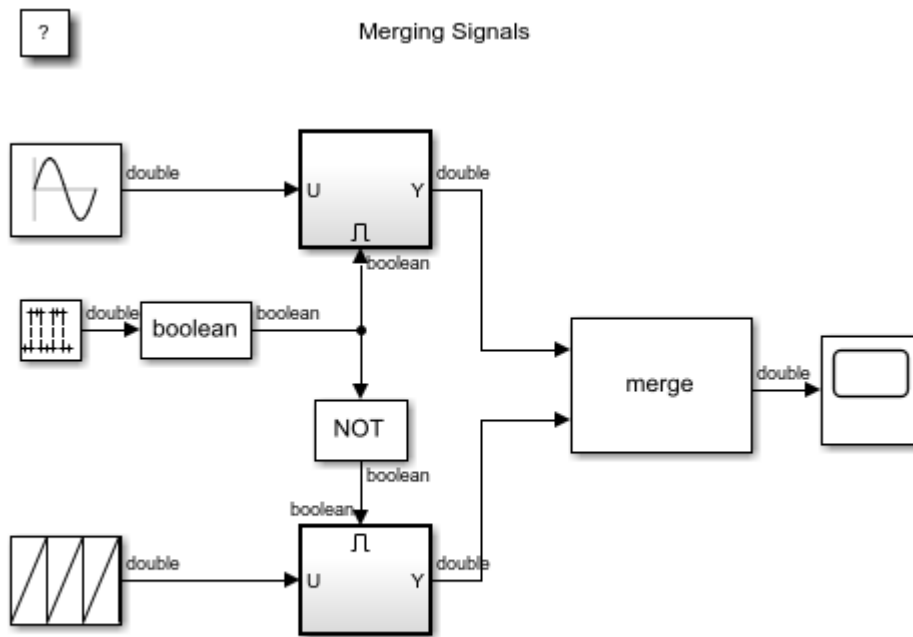

Copyright 2004-2015 The MathWorks, Inc.

Boolean Signals

You can have Simulink use boolean or double values for the inputs and outputs of the Logical Operator block, using the following steps.

1. To open the Configuration Parameters dialog box, in the Simulink Editor, on the **Modeling** tab, select **Model Settings**.
2. Go to the Optimization page in the Configuration Parameters dialog.
3. Verify that the **Implement logic signals as boolean data (vs. double)** parameter is enabled. This optimization tells Simulink whether or not it should allow a signal whose data type is double to be passed into and out of blocks that support the boolean data type.
4. Click the **OK** button on the **Configuration Parameters dialog**.

Placing the Data Type Conversion block after the Discrete Pulse Generator block avoids an error indicating that the Logical Operator block expects a boolean input signal.

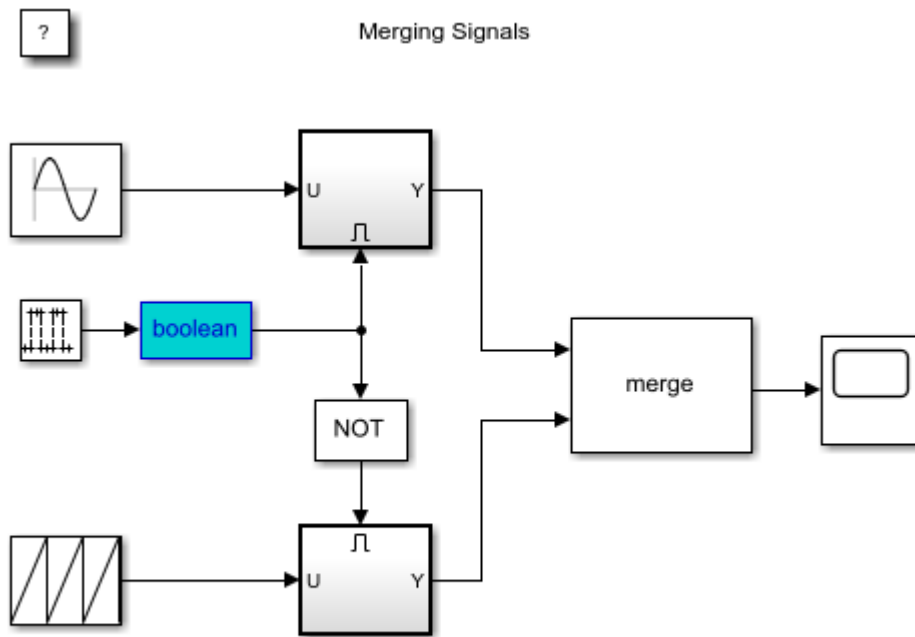

Copyright 2004-2015 The MathWorks, Inc.

Merge Block and Alternately Enabling Subsystems

Use the Merge block to create a single signal that is equal to the output of whichever enabled subsystem is currently executing.

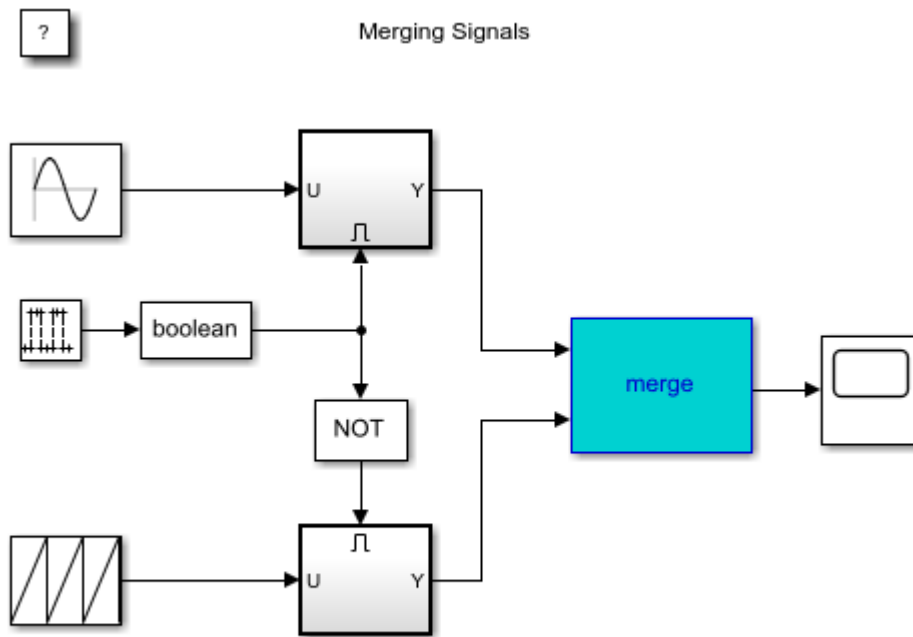

1. Open the Merge block dialog box by double-clicking the block.
2. Specify the **Number of inputs** as the number of enabled subsystems whose outputs you want to merge. In this case you want to set the *Number of inputs *to 2.
3. Leave the **Initial output field** empty to specify that the Merge block sets its initial output to the initial value of one of its input signals. In this case, the output will be the initial value of the subsystem that is enabled when the simulation starts.
4. Close the Merge block dialog box.
5. Connect the output of the two conditionally executed subsystems to the inputs of the Merge block.

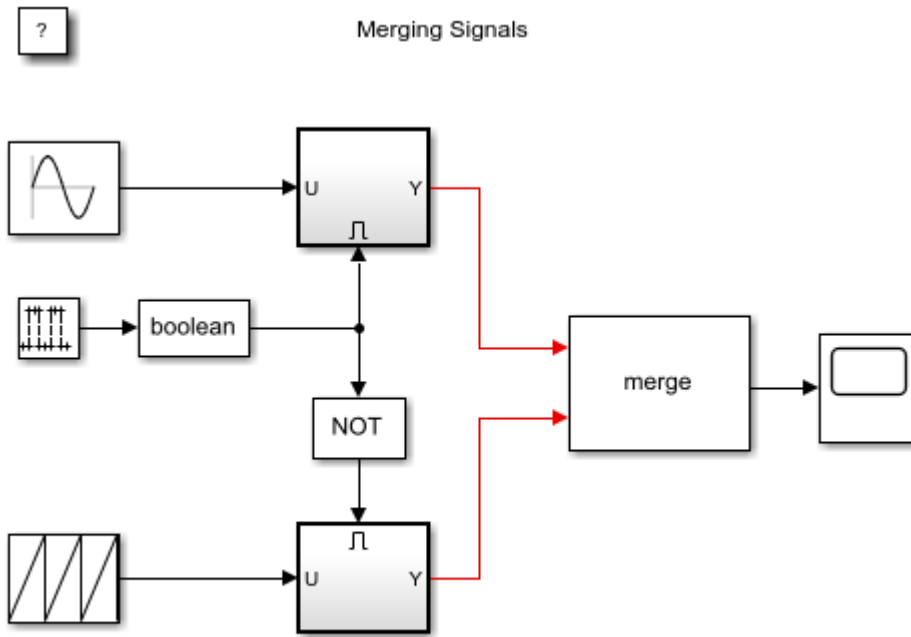

Copyright 2004-2015 The MathWorks, Inc.

As before, when you run the simulation, the output of the Merge block is the value of whatever conditionally executed subsystem is executing at any point in time.

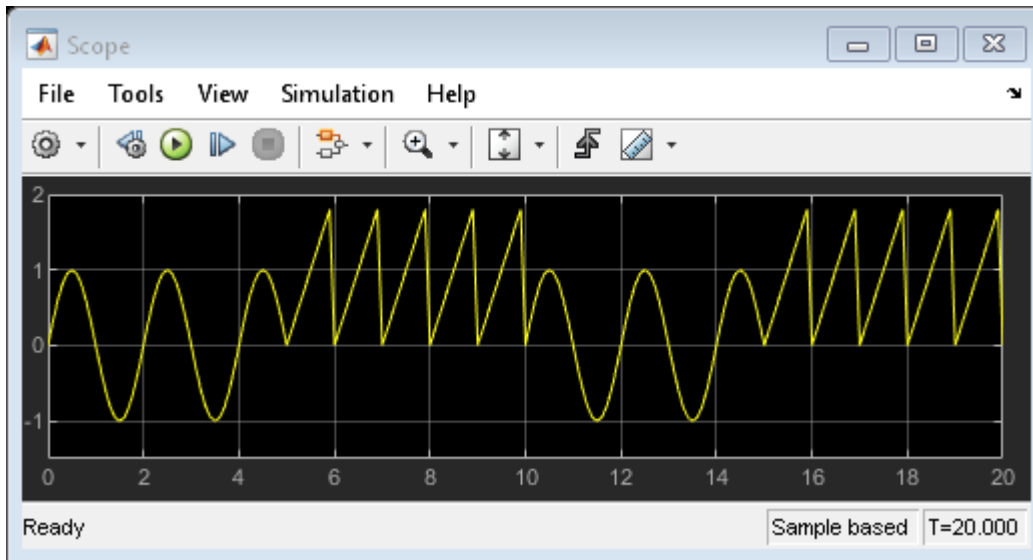

Programmatically Change Block Background Color

When you run the simulation, the color of the currently executing conditionally executing subsystems change. This does **not** happen automatically for all conditionally executing subsystems. This example uses an S-function and MATLAB® code to change the block background color.

At each time step, the S-function `mdlUpdate` subfunction executes. It sets the `BackgroundColor` property of the subsystems based on whether it is currently executing, or not, with the following command.

```
set_param('mergedemo/Subsystem','BackgroundColor','green')
```

See Also

Merge | Level-2 MATLAB S-Function

Related Examples

- “Conditionally Executed Subsystems Overview”
- “Using Enabled Subsystems”

Share Data Store Between Instances of a Reusable Algorithm

To reuse an algorithm, instead of copying and pasting the blocks, you can encapsulate them in a separate model file. Then, you can refer to the model repeatedly with Model blocks. Each Model block is a standalone instance of the algorithm.

By default, each instance calculates and stores its own copy of the signals that the model contains. Therefore, the instances do not interact. However, you can use a data store to share a piece of data between the instances.

This example shows how to share a fault indication between all instances of a reusable control algorithm. Any instance can set the fault, causing all instances to take action to clear it.

Explore Example Models

Open the example model `sldemo_shared_data`.

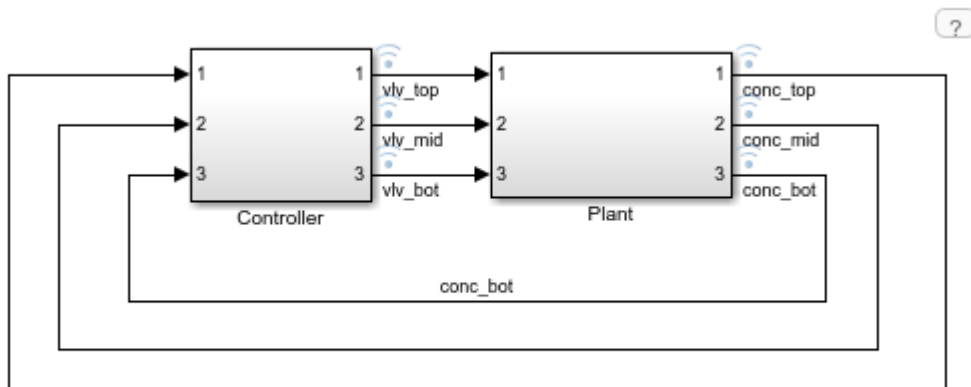

Copyright 2017 The MathWorks, Inc.

The Controller subsystem refers to the controller algorithm model, `sldemo_shared_data_alg`, multiple times through three Model blocks.

Open the algorithm model.

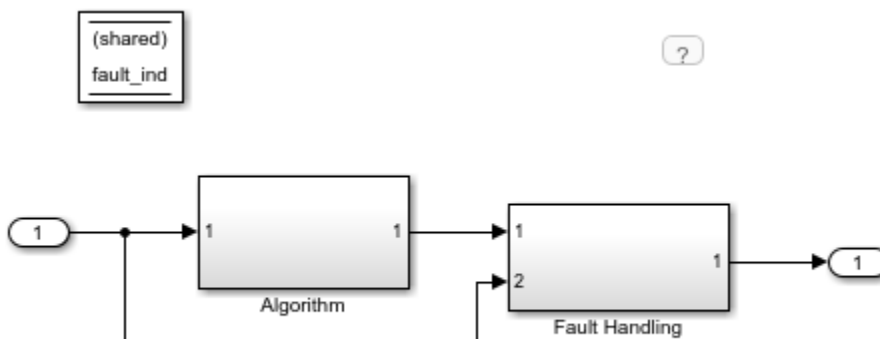

Copyright 2017-2020 The MathWorks, Inc.

The Data Store Memory block `fault_ind` represents a fault indication. The block parameter **Signal Attributes > Share across model instances** is selected, so all instances of `sldemo_shared_data_alg` share the indication. Because the block exists in `sldemo_shared_data_alg`, the indication is local to the model. Other models that refer to `sldemo_shared_data_alg` cannot read or write to the indication.

The Algorithm subsystem uses a PID controller to generate a position command for an actuator (represented by a block in `sldemo_shared_data`).

The Fault Handling subsystem sets and clears the fault indication. Each time an instance of the algorithm experiences a fault condition (the controlled input exceeds 2.63), the subsystem increments the value of the data store by 1. Each time an instance clears its fault condition, the subsystem decrements the value by 1.

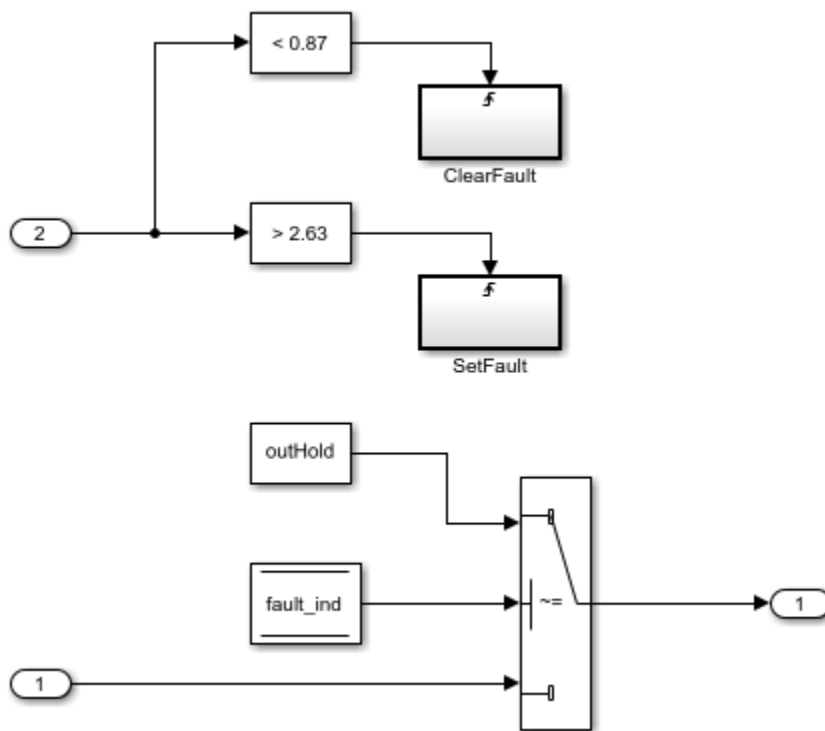

Simulate Example Models

Simulate the parent model, `sldemo_shared_data`.

Use the Simulation Data Inspector to observe the position commands and the controlled signals. In the Simulink Editor toolbar, click the highlighted button.

Partway through the simulation, the controlled signal `conc_mid` experiences a disturbance.

Current plot held

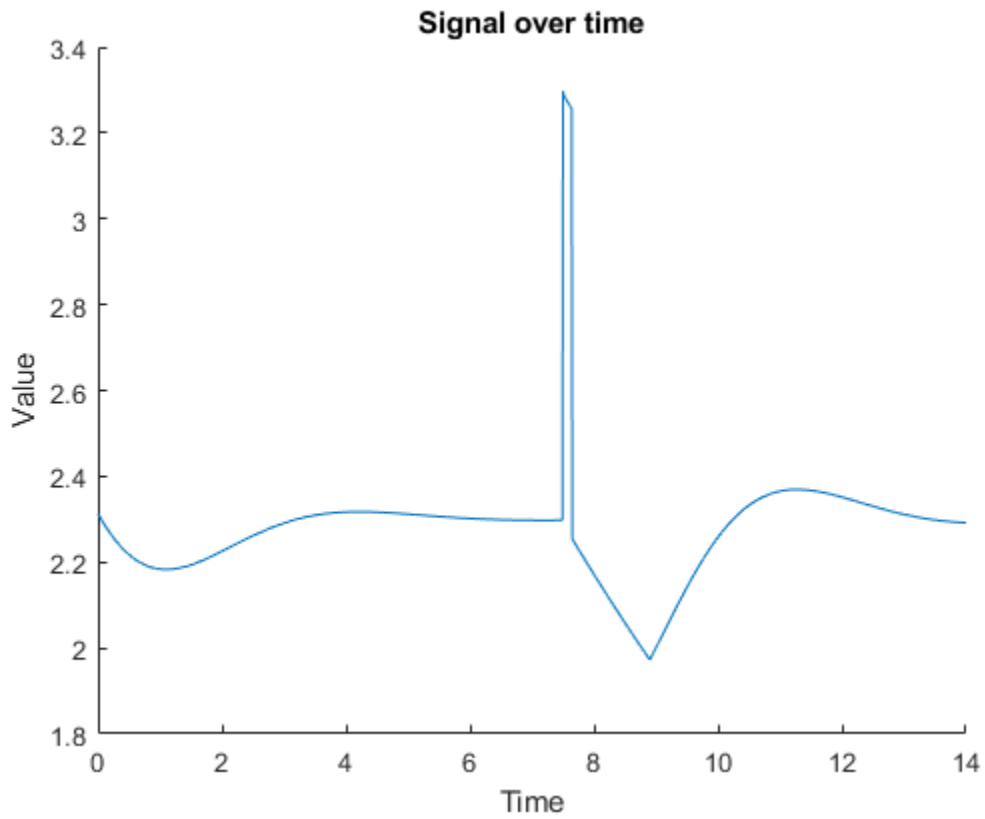

The disturbance triggers a fault in the corresponding instance of the control algorithm. Due to the fault, all three position commands (the `vlv` signals) lock at zero.

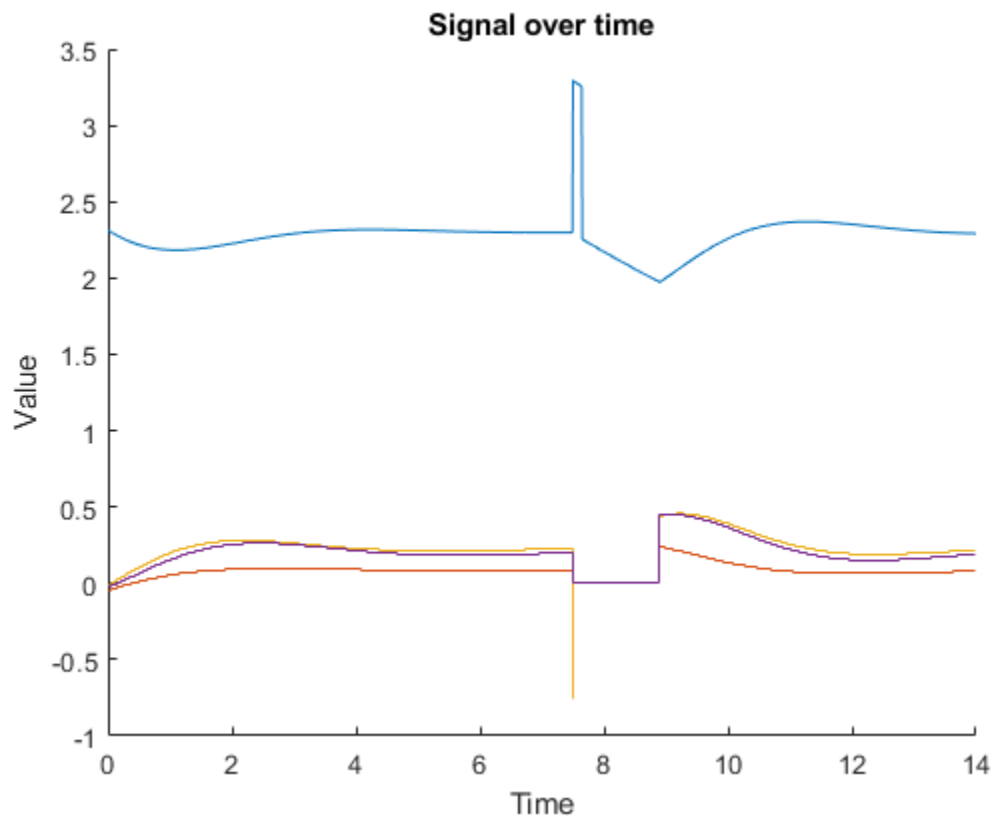

Later, when the fault condition clears, all of the position commands and controlled signals return to nominal values.

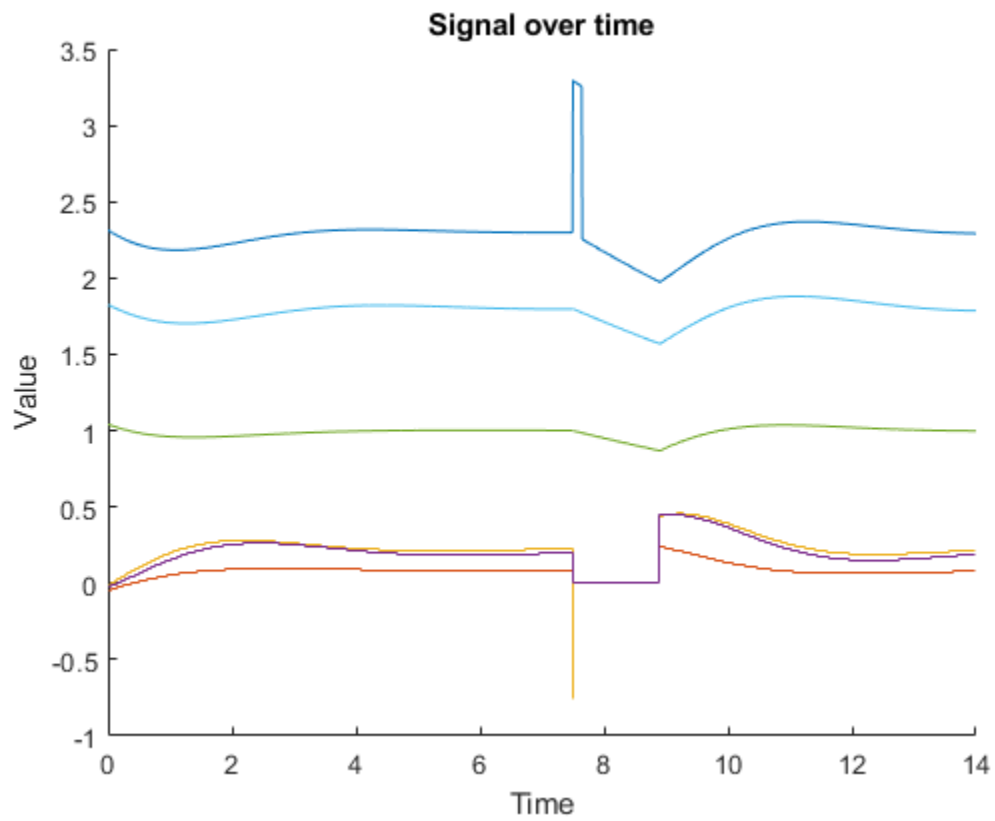

See Also

Data Store Memory

Related Examples

- "Data Store Basics"

Attaching Input Data to External Inputs via Custom Input Mappings

This example shows how to create a custom mapping function for the Root Inport Mapper tool. The Root Inport Mapper tool associates MAT-file data with a specific input port, based on one of these criteria.

- **Port Order** - Maps in the order it appears in the file to the corresponding port number.
- **Block Name** - Maps by variable name to the corresponding root inport with the matching block name.
- **Signal Name** - Maps by variable name to the corresponding root inport with the matching signal name.
- **Block Path** - Maps by the BlockPath parameter to the corresponding root inport with the matching block path.
- **Custom** - Maps using a MATLAB function.

Use a custom mapping criteria when the data you are trying to map does not match any of the other mapping criteria.

Custom Mapping Scenario

If the combination of input data and the model input ports does not match Port Order, Block Name, Signal Name, or Block Path mapping criteria, you can do one of the following:

- Rename the input data in the MAT-file
- Rename the input ports on the model
- Use the custom mapping mode

This example shows how to write a custom mapping function.

The workflow described below includes

- Create a MATLAB File to contain the custom mapping function
- Declare the custom mapping function name, inputs, and outputs
- Initialize the output for assignment of the return value
- Define and implement your mapping algorithm
- Validate your mapping algorithm

Create a New MATLAB Function File

Create a MATLAB function file. This file will contain your custom mapping function.

Declare Custom Mapping Function

Declare a custom mapping function name, and specify the inputs and outputs. `slexCustomMappingMyCustomMap` is the custom mapping function in this example. It declares the function inputs and outputs as defined below.

Inputs

- *modelName* - String that contains the model name.
- *signalNames* - Cell array of strings that contain variable names of signals to map
- *signals* - Cell array of signal data aligned with *signalNames* such that *signalNames*{1} is the variable name of the signal stored in *signals*{1}.

Outputs

- *inputMap* - Array or scalar of objects that result from the `getRootInportMap` function.

Initialize the Output

Initialize the value of the output variable `inputMap`. To do this use the `getRootInportMap` command with the empty property as shown in the example function `slexCustomMappingMyCustomMap` or in the code snippet below. This initializes the output variable to empty so that a value can be assigned to the output.

```
inputMap = getRootInportMap('empty');
```

Define Your Custom Mapping Algorithm

Things to think about when defining your custom mapping algorithm.

- What is the criteria for mapping signals to a root-level inport, for example `BlockName` mapping matches the name of the input signal to the name of the root-level inport block name.
- What information is needed to create a mapping.
- What happens if the mapping criteria determines that there is no match between signal and root-level inport.

The example addresses these items by

- Using the root-level port number and signal name for mapping criteria.
- Using a utility function `slexCustomMappingGetPortNames` to get root-level inport block names to provide as input along with the variable `|signalName|` to the `getRootInportMap` function which creates the mapping.
- Including a logical condition to handle the case where there is no match between port number and signal name.

Implement Your Mapping Algorithm

Next, implement your mapping algorithm.

In the `slexCustomMappingMyCustomMap` implementation, the root-level inport port number is the mapping criteria. The algorithm gets this port number from the root-level inport block. It then gets the numerical values appended to the names of the signals that are passed into the function, and compares the port number with the numerical values.

NOTE: In addition to implementing your mapping algorithm, you should also include a logical statement to handle situations where a mapping is not possible. The example function does this by using an `if` statement with the `isempty` function to determine if a mapping can be made.

Create the Mapping

The final step is to use the `getRootInportMap` function to create a custom map. The `getRootInportMap` function uses Property-Value pairs to create a custom map. The properties are:

- *model* - String that represents the model name.
- *signalName* - String or cell of strings that contains the value of the variable name of the signal to map.
- *blockName* - String or cell of strings that contains the value of the block name of the port to be mapped.

The following code is an example of this function. This same code appears in the example function `slexCustomMappingMyCustomMap`.

```
inputMap = getRootInportMap(...
    'model',modelName,...
    'signalName',signalNames,...
    'blockName',portNames);
```

Validate the Custom Mapping Function

To validate the custom mapping function at the command line:

- 1 Open the model against which you want to test your function.
- 2 Create some input signals to support the model.
- 3 Call your custom mapping function with the correct input parameters.
- 4 Validate the expected input string to send to the `sim` command, or to place in the model configuration parameters External Input String edit box.

Execute the lines of code in the following example. This code uses the custom mapping function provided with this example. If the custom map function succeeds, you should see a comma-separated list of variable names displayed in the order of the port number to which they are assigned ('port1,port2').

```
load_system('slexAutotransRootInportsExample'); port1 =
timeseries(ones(10,1)*10); port2 =
timeseries(zeros(10,1)); inputMap =
slexCustomMappingMyCustomMap('slexAutotransRootInportsExample',{'port1'
, 'port2'},{port1 , port2}); externalInputString =
getInputString(inputMap,'base');
close_system('slexAutotransRootInportsExample',0);
```

If your signals are in a `Simulink.SimulationData.Dataset`, you can execute the lines of code in the following example. This code uses the custom mapping function provided with this example. If the custom mapping function succeeds, you should see a comma-separated list of variable names displayed in the order of the port number to which they are assigned ('ds.getElement(1),port1,ds.getElement(2)').

```
load_system('slexAutotransRootInportsExample');
ds = Simulink.SimulationData.Dataset;
ds = ds.addElement( timeseries(ones(10,1)*10), 'port1');
ds = ds.addElement( timeseries(zeros(10,1)), 'port1');
inputMap = slexCustomMappingMyCustomMap('slexAutotransRootInportsExample',{'ds'},{ ds
```

```
externalInputString = getInputString(inputMap, 'base');  
close_system('slexAutotransRootInportsExample', 0);
```

Using Mapping Modes with Custom-Mapped External Inputs

This example shows how to implement a custom mapping algorithm similar to a Simulink mapping mode. It uses the `getSlRootInportMap` and `getRootInportMap` functions to implement the custom mapping.

Before running this example, make sure that you are familiar with the `getRootInportMap` command and the Root Inport Mapper Tool. For more information, see “Map Root Inport Signal Data”.

Workflow

This example shows how you can use a built-in Simulink mapping mode to perform as many mappings as possible. It then flags the root inports that were not able to be assigned a signal. The algorithm then overrides the flagged mappings with custom mappings to map the remaining signals. To implement such a solution, create a custom mapping function using the `getSlRootInportMap`.

This example uses a list of inputs with two kinds of signals:

- Signals that can be mapped using the Simulink block name mapping mode.
- Signals that cannot be mapped using the Simulink block name mapping mode. You must map these signals with a custom mapping mode.

Assume the following scenario:

- You want to use a group of signals as inputs to your Simulink model.
- The signals are named such that the variable names match the block name of the root-level inport.
- Each signal that uses this naming convention is within tolerance.
- Each signal that has the 'x' character appended to its name is considered outside tolerance.

This example uses a mapping mode similar to the Simulink block name mapping method.

The root-level inport block names are:

- Throttle
- Brake

The signal variable names are:

- Throttlex
- Brake

To map inputs to root-level inport blocks in this scenario, you need a custom mapping function for the Root Inport Mapper tool. This example uses the `AlmostBlockName` custom mapping function.

For this example, you will use the `slexAutotransRootInportsExample` model to validate your custom mapping function.

Declare the Custom Mapping Function

Declare the function name, inputs, and outputs. To do this, copy and paste the following code snippet into a MATLAB file and save the file as `AlmostBlockName.m`.

```
function inputMap = AlmostBlockName( modelName, signalNames, signals )
```

Get the Simulink BlockName Mapping

Next, map all the signals. To do this, first map all the signals within tolerance using the Simulink block name mapping mode, then map the signals outside tolerance.

To map signals within tolerance to a model using one of the Simulink mapping modes, use the function `getSlRootInportMap`. This function returns the `inputMap` and a vector of logical values. Each logical value indicates a successful or unsuccessful mapping of `inputMap` to a signal. To map by block name, insert the following lines of code just after the function declaration.

```
inputMap = getRootInportMap('empty');
if ~bdIsLoaded(modelName)
    load_system(modelName);
end

[inputMap, hasASignal] = getSlRootInportMap('Model', modelName, ...
    'MappingMode','BlockName',...
    'signalName',signalNames, 'signalValue', signals);
```

Find the Missing Input Signals

In the previous step, you created a mapping using a block name mapping mode. You must now account for an empty `inputMap` and for `inputMap(s)` that were not associated with a signal within tolerance. The function `getSlRootInportMap` has flagged these signals with the output variable `hasASignal`. To do this:

- 1 Check the `inputMap` variable.
- 2 If the `inputMap` variable is not empty, determine which elements of the `inputMap` vector were not assigned a signal. To do this, use the logical `~` on the `hasASignal` vector as shown below. The `emptyIndex` vector now contains a logical vector where true means the `inputMap` does not have a signal mapped to it.
- 3 Copy and paste the following code snippet under the call to the `getSlRootInportMap` and before the `end` to the `if bdIsLoaded(modelName)`.

```
if ~isempty(inputMap)
    emptyIndex = ~hasASignal;
end
```

The code snippet performs steps one and two for you.

Complete the Mapping

In the previous step, you created a logical vector `emptyIndex` to see if any of the `inputMap` objects were not associated to a signal. If all the elements of the `emptyIndex` vector are false, you have a complete mapping and the code added in this section will not be executed.

If the `emptyIndex` vector contains at least one value that is true, you have `inputMap` objects that are not associated to a signal. Manually assign the variable `signal(s)` to that `inputMap`. Then, override the `inputMap` with the signal name that matches the expected signal name:

- 1 In the `emptyIndex` vector, find all the items that are true. These items point to the `inputMap(s)` that still need to be associated with a signal.
- 2 For each `inputMap`, use the 'BlockName' property to get the name of the inport block that the `inputMap` is assigned to.

- 3 Append an 'x' to the block name to get the name of the signal to be assigned to the `inputMap`.
- 4 Compare the result to each item in the `signalNames` variable cell array.
- 5 If a match is found, override the `inputMap` with the signal name that matches the expected signal name. To override the `inputMap` object, use the `getRootInportMap` function with the 'InputMap' and the 'SignalName' properties.

```

if isa( signals{1}, 'Simulink.SimulationData.Dataset')
    signalNames = signals{1}.getElementNames';
end

idxEmpty = find(emptyIndex==true);
for kEmpty =1:length(idxEmpty)
    idxOfEmpty = idxEmpty(kEmpty);
    destBlockName = get(inputMap(idxOfEmpty),'BlockName');
    outSideToleranceSig = [destBlockName 'x'];
    isAMatch = strcmp(signalNames, outSideToleranceSig);
    if any(isAMatch)
        inputMap(idxOfEmpty) = getRootInportMap('InputMap', ...
            inputMap(idxOfEmpty),'SignalName',outSideToleranceSig);
    end
end
end

```

The Custom Map File

When you are done, the file `AlmostBlockName.m` should resemble the following code.

```

function inputMap = AlmostBlockName(modelName, signalNames, signals)
inputMap = getRootInportMap('empty');
if bdIsLoaded(modelName)

    [inputMap, hasASignal] = getSlRootInportMap('Model', modelName, ...
        'MappingMode','BlockName',...
        'signalName',signalNames, 'signalValue', signals);

    if ~isempty(inputMap)
        emptyIndex = ~hasASignal;
        idxEmpty = find(emptyIndex==1);

        if isa( signals{1}, 'Simulink.SimulationData.Dataset')
            signalNames = signals{1}.getElementNames';
        end

        for kEmpty =1:length(idxEmpty)
            idxOfEmpty = idxEmpty(kEmpty);
            destBlockName = get(inputMap(idxOfEmpty),'BlockName');
            nonNominalSig = [destBlockName 'x'];
            isAMatch = strcmp(signalNames, nonNominalSig);
            if any(isAMatch)
                inputMap(idxOfEmpty) = getRootInportMap('InputMap', ...
                    inputMap(idxOfEmpty),'SignalName',nonNominalSig);
            end
        end
    end

end
end
end

```

Validate the Custom Mapping

To validate your custom mapping:

- 1 Save the `AlmostBlockName` function in a file on the MATLAB path.
- 2 To see the results of your mapping function, copy and paste the following code snippet to the MATLAB Command Window.

```
modelName = 'slexAutotransRootInportsExample';
Throttlex = timeseries(zeros(10,1));
Brake     = timeseries(ones(10,1));
signalNames= {'Throttlex' , 'Brake'};
signals   = { Throttlex , Brake };
open_system(modelName);
inputMap  = AlmostBlockName(modelName, signalNames, signals);
inputStr  = getInputString(inputMap, 'base');
close_system(modelName);
```

After running the code snippet, the variable `inputStr` contains the string `'Throttlex,Brake'`.

If your signals are in a `Simulink.SimulationData.Dataset`, to see the results of your mapping function, use the following code snippet at the MATLAB Command Window.

```
modelName = 'slexAutotransRootInportsExample';
Throttlex = timeseries(zeros(10,1));
Brake     = timeseries(ones(10,1));
ds        = Simulink.SimulationData.Dataset;
ds        = ds.addElement( Throttlex, 'Throttlex' );
ds        = ds.addElement( Brake, 'Brake' );
signalNames= {'ds'};
signals   = { ds };
open_system(modelName);
inputMap  = AlmostBlockName(modelName, signalNames, signals);
inputStr  = getInputString(inputMap, 'base');
close_system(modelName);
```

After running the code snippet for signals in a `Simulink.SimulationData.Dataset`, the variable `inputStr` contains the string `'ds.getElement('Throttlex'),ds.getElement('Brake')'`.

See Also

[getRootInportMap](#) | [getSlRootInportMap](#)

Related Examples

- “Attaching Input Data to External Inputs via Custom Input Mappings” on page 13-336
- “Create and Use Custom Map Modes”

More About

- “Map Root Inport Signal Data”
- “Alternative Workflows to Load Mapping Data”

Converting Harness-Driven Models to Use Harness-Free External Inputs

This example shows how to convert a harness model that uses a Signal Builder block as an input to a harness-free model with root inputs. The example collects data from the harness model and stores it in MAT-files for the harness-free model. After storing the data, the example removes the Signal Builder block from the harness model and adds root inputs to create a harness-free model. Then, the data in the MAT-files is mapped to the root inputs of the model.

Save Harness Data to MAT-Files

Before converting the model to be harness-free, collect the test cases in the harness.

For this example, you will modify the model `sldemo_autotrans` from the **Modeling an Automatic Transmission Controller** example.

Open the example model. In the MATLAB Command Window, type `sldemo_autotrans`.

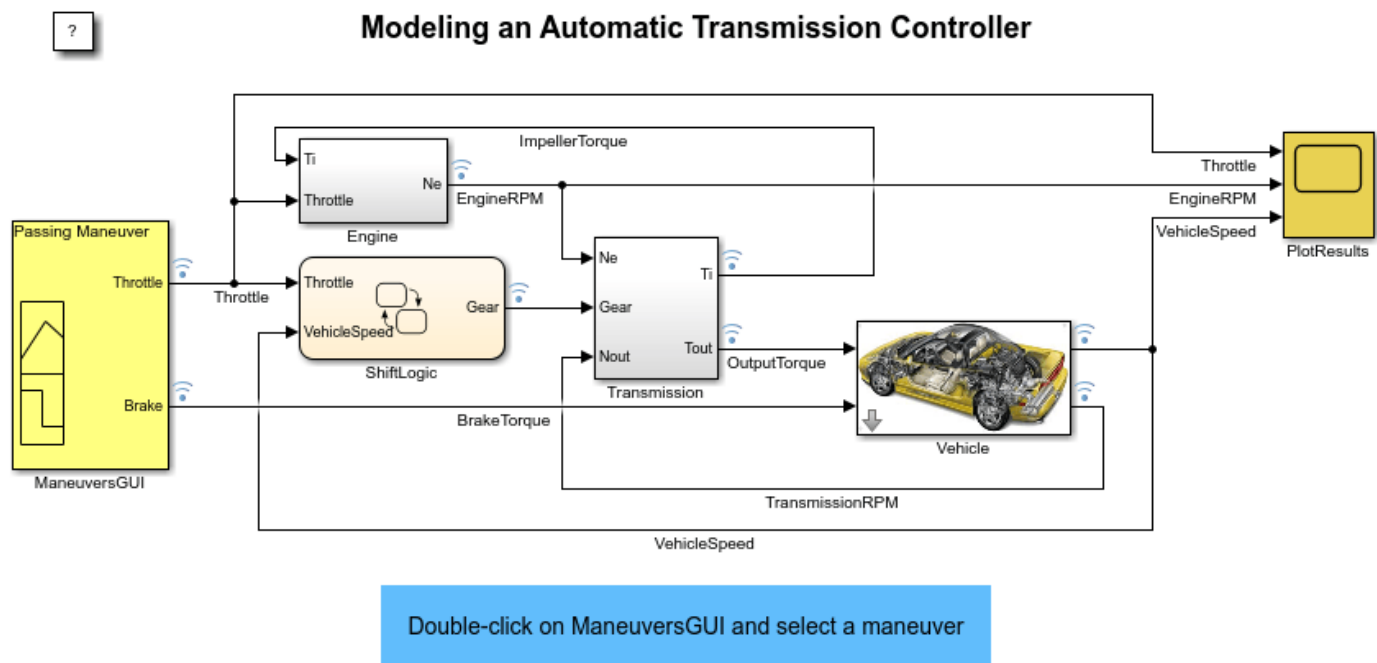

Exporting Signal Builder Block Groups

Export data that defines Signal Builder block signal groups to a MAT-file from the Signal Builder window. To export Signal Builder signal data, formatted as `Simulink.SimulationData.Dataset`, to a MAT-file, open the Signal Builder window and select **File > Export Data > To MAT-File**. In the dialog, enter a name for the MAT-file to contain the data and the number of the group you want to export. For this example, the file name is `slxAutotransRootInportPassingManeuver.mat` and the group number is 1 for the Passing Maneuver group.

Remove the Signal Builder Block

Remove the Signal Builder block named `ManeuversGUI` and replace it with two inports.

- 1 Delete the Signal Builder block named ManeuversGUI.
- 2 From the **Simulink/Commonly Used Blocks** library, drag two inport blocks into the model.
- 3 Connect the input ports to the lines previously connected to the Signal Builder block.
- 4 Rename the inport ports. Name the input port connected to the Throttle line **Throttle**. Name the input port connected to the BrakeTorque line **Brake**.

Save the model as `slexAutotransRootImportsExample1.slx` or use the example `slexAutotransRootImportsExample.slx`.

The remaining steps of this example use the model `slexAutotransRootImportsExample.slx`. If you saved the model with a different name use your model name in the steps going forward.



Modeling an Automatic Transmission Controller with Root Imports

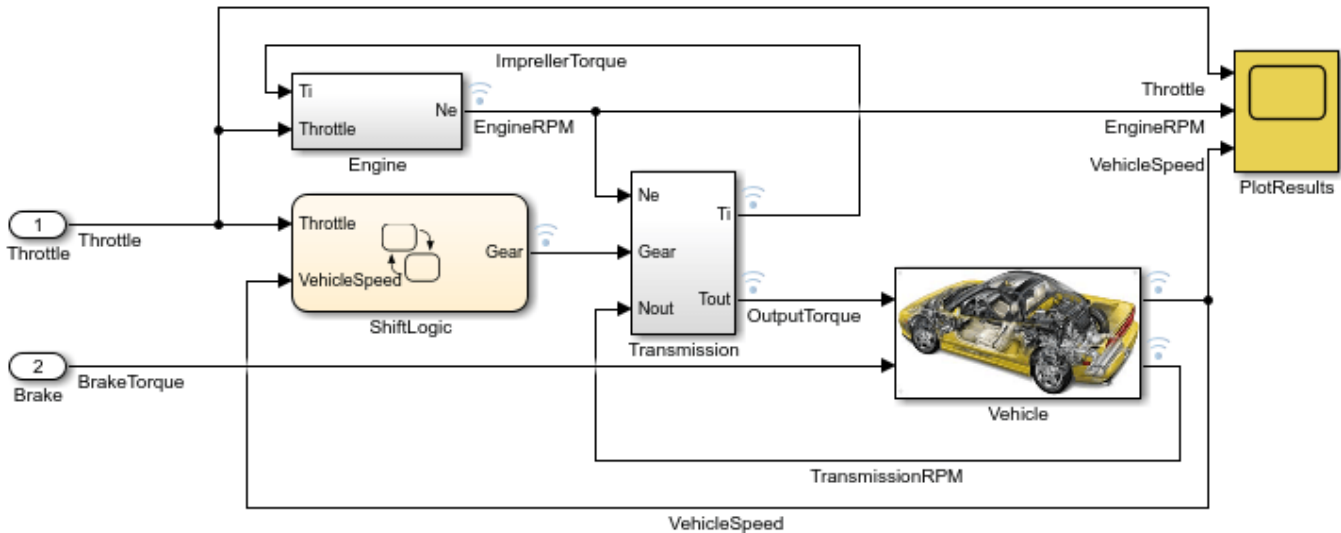

Copyright 2012 - 2014 The MathWorks, Inc.

Set Up Harness-Free Inputs

Now that the model is harness-free, set up the inputs that you already saved (See "Save Harness Data to MAT-Files").

In the Modeling tab, select Model Settings. In the Data Import/Export pane, click the **Connect Input** button.

Map Signals to Root Inport

The Root Inport Mapper tool opens.

The example uses this tool to set up the model inputs from the MAT-file and map those inputs to an input port, based on a mapping algorithm. To select the MAT-file that contains the input data, click the **From MAT-File** button on the Root Inport Mapper toolbar. When the link dialog appears, click the Browse button. In the browser, select the MAT-file that you saved earlier.

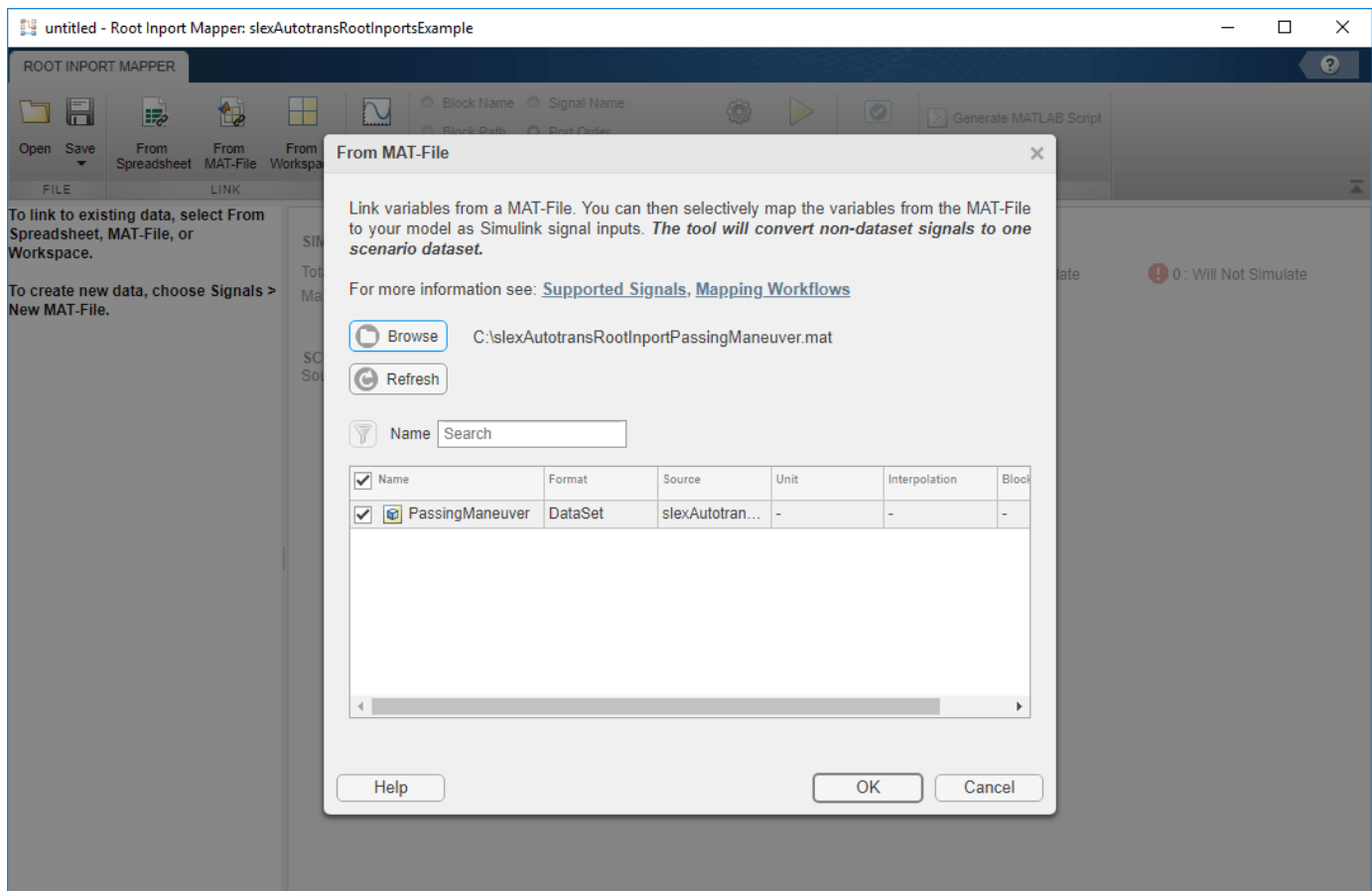

Select a Mapping Mode

When you select the MAT-file `slexAutotransRootInportPassingManeuver.mat` that contains the input data, determine the root input port to which to send input data. Simulink matches input data with input ports based on one of five criteria:

- **Port Order** - Maps in the order it appears in the file to the corresponding port number.
- **Block Name** - Maps by variable name to the corresponding root inport with the matching block name.
- **Signal Name** - Maps by variable name to the corresponding root inport with the matching signal name.
- **Block Path** - Maps by the BlockPath parameter to the corresponding root inport with the matching block path.
- **Custom** - Maps using a MATLAB function.

Earlier in this example, you saved input data to variables of the same name as the harness signals Throttle and Brake, and added input ports with names matching the variables. Given the set of conditions for the input data and the model input ports, the best choice for a mapping criteria is

Block Name. Using this criteria, Simulink tries to match input data variable names to the names of the input ports. To select this option:

- 1 Click the **Block Name** radio button.
- 2 Click the **Options** button and select **Update Model**. This verifies the mapping.
- 3 Click the **Map** button.

When compiling the data, Simulink evaluates inports against the following criteria to determine compatibility issues. The status of this compatibility is reflected by the table colors green, orange, or red. Warnings and errors are flagged with diagnostic messages. If the **Options > Update Model** option is not selected, Root Inport Mapper determines the compatibility status by evaluating these block parameters and assigned signals:

- **Data Type** - Double, single, enum,
- **Complexity** - Real or complex
- **Dimensions** - Signal dimensions vs port dimensions

The screenshot shows the 'ROOT INPORT MAPPER' application window. The interface includes a menu bar (FILE, LINK, SCENARIO, MAP TO MODEL, MODEL, SCRIPT), a toolbar with various icons, and a main workspace. The workspace is divided into several sections:

- SCENARIO DATASET:** A list showing 'PassingManeuver' with a 'Block Name' map mode and a green checkmark.
- MAPPING SUMMARY:** Displays 'Total Scenario Datasets: 1' with a breakdown: 0 Not Mapped, 1 Mapped, 0 Warnings, and 0 Errors. It also shows 'Marked For Simulation:'.
- SCENARIO DETAILS:** Shows the source as 'PassingManeuver - slxAutotransRootInportPassingManeuver.mat' and the mode as 'Block Name'.
- MAPPING TABLE:** A table with columns for STATUS, SCENARIO SIGNAL, PORT, BLOCK NAME, and MAPPED SIGNAL. It lists two mappings: 'Throttle' (Port 1) and 'Brake' (Port 2), both with green checkmarks.

| STATUS | SCENARIO SIGNAL | PORT | BLOCK NAME | MAPPED SIGNAL |
|--------|-----------------|------|------------|--|
| ✓ | Throttle | 1 | Throttle | PassingManeuver.getElement('Throttle') |
| ✓ | Brake | 2 | Brake | PassingManeuver.getElement('Brake') |

Finalize the Inputs to the Model

Review the results of the mapping compatibility. Click the Scenario Dataset 'PassingManeuver' in the scenario dataset list. To prepare for simulation, click **Mark for Simulation**. This action applies the mapping variables to the Configuration Parameter **Data Import/Export > External Input** text box. If this text box has content, it is overwritten.

Simulating the Model

With the changes applied you can now simulate the model and view the results. Run the model. To view the results of the simulation, double-click the Scope Block **PlotResults**.

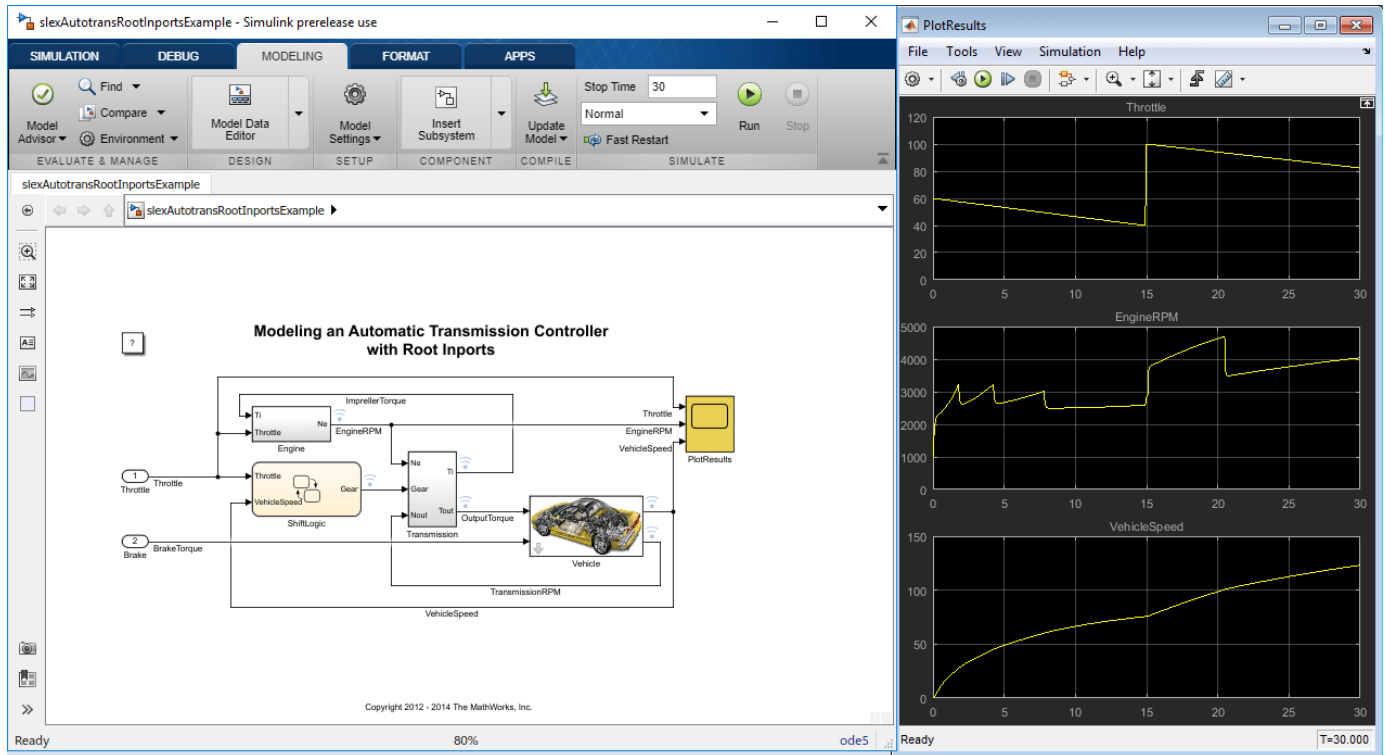

Logging States in Structure Format

Logging states using the Structure format can provide advantages over the Array format. When you log states using the Array format, the ordering of the states along the columns in the logged array depends on the block sorted order. Various factors can affect the block sorted order, which can alter the ordering of the states from one simulation to the next. When you use the Structure format, the block names are stored along with the logged state data for that block, so you can process your data without considering the block sorted order.

Logging States in Array Format

When you log states using the Array format, the logged data is stored in an array with N columns, where N is the number of states, and M rows, one for each simulation time step. This M-by-N matrix form is easy to manipulate in MATLAB®. However, the ordering of the state variables along the columns of the logged matrix depends on the block sorted order. Therefore, any MATLAB code which expects a fixed mapping between the states of blocks in the model and the columns of the states matrix is prone to breaking when the block sorted order changes due to changes in the model.

For example, consider the models `sldemo_state_logging1` and `sldemo_state_logging2`.

```
mdl1 = 'sldemo_state_logging1';
mdl2 = 'sldemo_state_logging2';
open_system(mdl1);
open_system(mdl2);
```



sldemo_state_logging1

Copyright 2006-2013 The MathWorks, Inc.

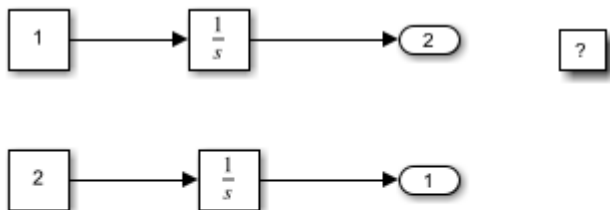

sldemo_state_logging2

Copyright 2006-2013 The MathWorks, Inc.

The two models contain the same blocks, connected the same way. The only difference is the order of the output ports. Simulate the models and log the states using the Array format.

```
simOut1 = sim mdl1, 'SaveFormat', 'Array';  
simOut2 = sim mdl2, 'SaveFormat', 'Array';
```

Extract the states vectors from the `Simulink.SimulationOutput` object, which contains all data logged in the simulation.

```
x1 = simOut1.get('xout');  
x2 = simOut2.get('xout');
```

The logged states data for `x1` and `x2` are different because the blocks are ordered differently, so the mapping between the columns in the logged array and the blocks in the model is different.

```
isequal(x1, x2)
```

```
ans =
```

```
logical
```

```
0
```

Log States Using the Structure Format

Simulate the models again, but this time log the states in structure format.

```
simOut1=sim mdl1, 'SaveFormat', 'Structure';  
simOut2=sim mdl2, 'SaveFormat', 'Structure';
```

Extract the structures, which contain the logged states, from the `SimulationOutput` object.

```
x1s = simOut1.get('xout');  
x2s = simOut2.get('xout');
```

Display these structures, which contain two fields: `time` and `signals`. The `time` field is empty because the data was logged using the `Structure` format and not the `StructureWithTime` format. You can use the `StructureWithTime` format when you need to save the time data along with the states data.

```
disp(x1s);  
disp(x2s);
```

```
time: []  
signals: [1x2 struct]
```

```
time: []  
signals: [1x2 struct]
```

The structure `signals` field is an array of structures, with one structure for each block in the model that has state data. Each block data structure within the `signals` field contains a `values` field with the states data and a `blockName` field with the name of the block that produced that state data. You can extract the states data into a matrix that you can process similar to how you would had you logged the states using the Array format.

To fix the state ordering problem, first use the block names to sort the states data into a fixed order. For example, you could sort the states data so that the blocks are in alphabetical order, which will stay the same from one simulation to the next, regardless of the block sorted order.

```
[~, idx1] = sort({x1s.signals.blockName});  
x1 = [x1s.signals(idx1).values];
```

```
[~, idx2] = sort({x2s.signals.blockName});  
x2 = [x2s.signals(idx2).values];
```

```
isequal(x1, x2)
```

```
ans =
```

```
    logical
```

```
     1
```

Once you reorder the signals fields alphabetically by block name, if you extract the values field data in the same order, you can then process the data similar to how you would when you use the Array format, but the order of the block states data does not change from one simulation to the next.

Saving and Restoring Simulation Operating Point

This example shows the workflow and the benefits of saving and restoring a simulation operating point using a `ModelOperatingPoint` object.

The `ModelOperatingPoint` object contains the complete snapshot of all variables that are related to the simulation of a model. After saving the `ModelOperatingPoint` object at the end of a simulation, Simulink® can reload the operating point and continue the simulation from the time at which the `ModelOperatingPoint` object was saved. This action produces the same simulation results as if the simulation were never interrupted.

This example illustrates:

- How saving the Final states (logged states) is not always sufficient for complete and accurate restoration of a simulation state.
- How you can save and restore the complete operating point of a simulation, yielding faster simulation workflows

Difficulties with Models with Variable Transport Delay

The states that are logged during a simulation are a subset of all the information needed to fully describe the state of a simulation. Certain blocks rely on internal information that is not logged as part of state logging and final state export. One such block is the Transport Delay block. Models with Transport Delay blocks are usually difficult to fully restore to a particular state because the state of the transport delay is not saved in the structure format or the array format as part of "Final states" data logging.

To illustrate this issue, compare the simulation results for two cases:

1. Simulate a model, which contains a Transport Delay block, from 0 to 5 seconds and save the "Final states" values in the workspace. Then load this first set of final states and simulate from 5 to 10 seconds.
2. Simulate the same model from 0 to 10 seconds and force the model to produce an output at 5 seconds. We call the result of this simulation the baseline result because it is a nonstop simulation.

The results of the first simulation match the first half of the baseline result. If the simulation state of the first simulation had been restored completely, the second simulation results would match the second half of the baseline.

To begin, load this model:

```
mdl = 'slexVariableTransportDelay';
load_system(mdl);
```

Simulate until time of 5 and save the final state in structure format:

```
out = sim(mdl, 'StopTime', '5', 'SaveFinalState', 'on', ...
          'FinalStateName', 'xFinal', 'SaveFormat', 'Structure');
y1 = out.ScopeData;
```

Load the final state from the last simulation and run to 10:

```
assignin('base', 'xFinal', out.get('xFinal'));
out1 = sim(mdl, 'StartTime', '5', 'StopTime', '10', ...
```



```

        'SaveFinalState', 'off', ...
        'LoadInitialState', 'on', 'InitialState', 'xFinal');
y2 = out1.ScopeData;

```

Run a nonstop simulation which will serve as the baseline result:

```

out2 = sim mdl, 'OutputOption', 'AdditionalOutputTimes', ...
            'OutputTimes', '[0 5 10]', 'LoadInitialState', 'off');
y = out2.ScopeData;

```

Plot the results. Note that the second half of the baseline result does not match the simulation from 5 to 10 seconds, whose initial state was restored from the final state saved at 5 seconds:

```

figure;
for idx=1:3
    subplot(3, 1, idx);
    plot(y.time,y.signals(idx).values);
    hold on;
    plot([y1.time; y2.time],...
        [y1.signals(idx).values;y2.signals(idx).values], 'r--');
    hold off;
    grid on;
end

```

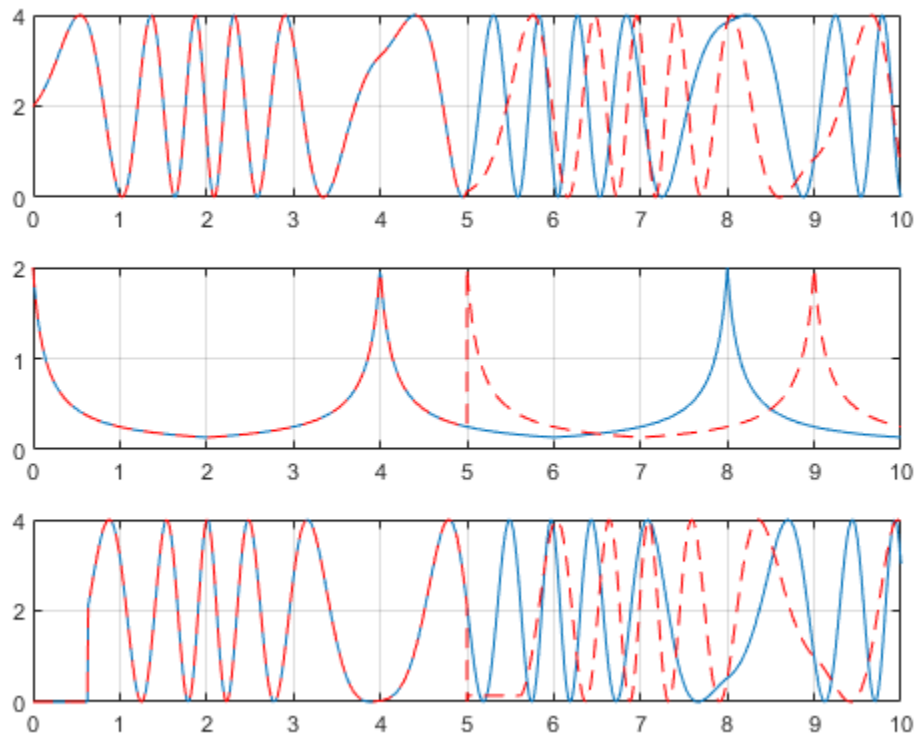

Saving and Restoring the Complete Operating Point of a Simulation

You can save the complete final operating point in a Simulink.op.ModelOperatingPoint object. The ModelOperatingPoint object contains all the variables which are needed to restore the simulation

results. By using the complete `ModelOperatingPoint`, Simulink is able to restore the simulation state completely and to reproduce the baseline simulation results.

Set the parameter for Simulink to save the complete operating point at the end of the simulation.

```
out3 = sim mdl, 'StopTime', '5', 'SaveFinalState', 'on', ...
           'LoadInitialState', 'off', 'SaveOperatingPoint', 'on', ...
           'FinalStateName', 'xFinal');
y1 = out3.ScopeData;
```

Load the `ModelOperatingPoint` from the last simulation and run for an additional 5 seconds. The start time value must remain 0.0 (that value was the start time of the original simulation). The software stores the original simulation start time in `xFinal`. This value must match the start time of the current simulation to enable restoration of the simulation state.

```
assignin('base', 'xFinal', out3.get('xFinal'));
out4 = sim mdl, 'StopTime', '10', 'SaveFinalState', 'off', ...
           'LoadInitialState', 'on', 'InitialState', 'xFinal');
y2 = out4.ScopeData;
```

Plot the results and compare them with the baseline simulation. Note that this time, the simulation state has been completely restored and the simulation results after the operating point restore match the baseline.

```
figure;
for idx=1:3
    subplot(3, 1, idx);
    plot(y.time, y.signals(idx).values);
    hold on
    plot([y1.time; y2.time], ...
         [y1.signals(idx).values; y2.signals(idx).values], 'r--');
    hold off;
    grid on;
end
```

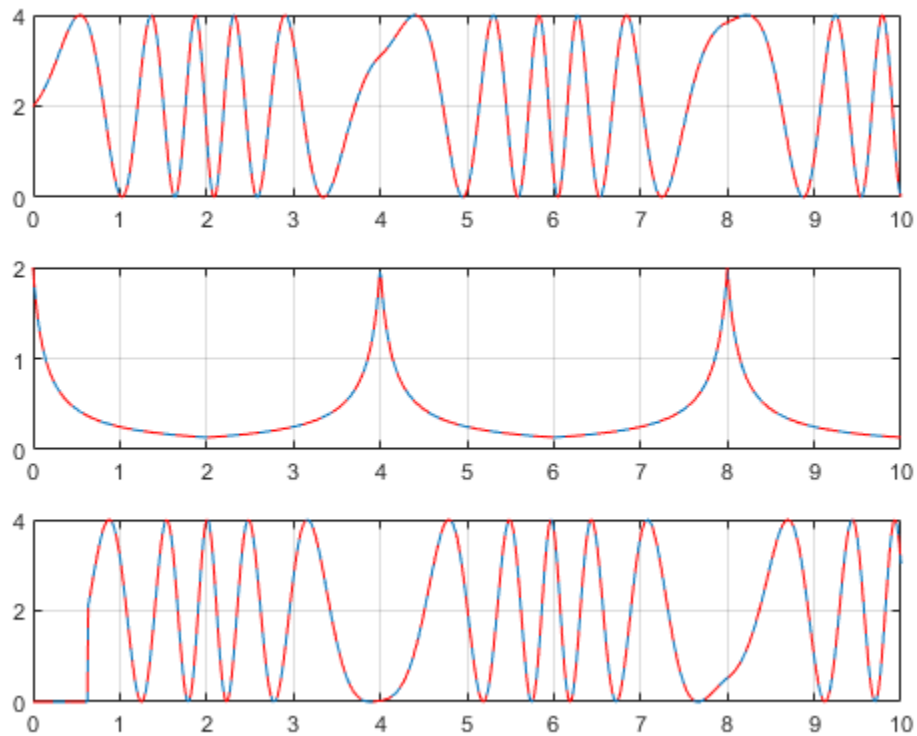

Close the model and clear the variables which were used in this example

```
close_system mdl, 0);  
clear mdl idx xFinal y y1 y2 y3 out out1 out2 out3 out4
```

Logging Intervals

This example shows how to specify logging intervals. Simulink® limits the data logging to the specified intervals.

Open the Example Model

Open the example model, `sldemo_mdhref_bus`.

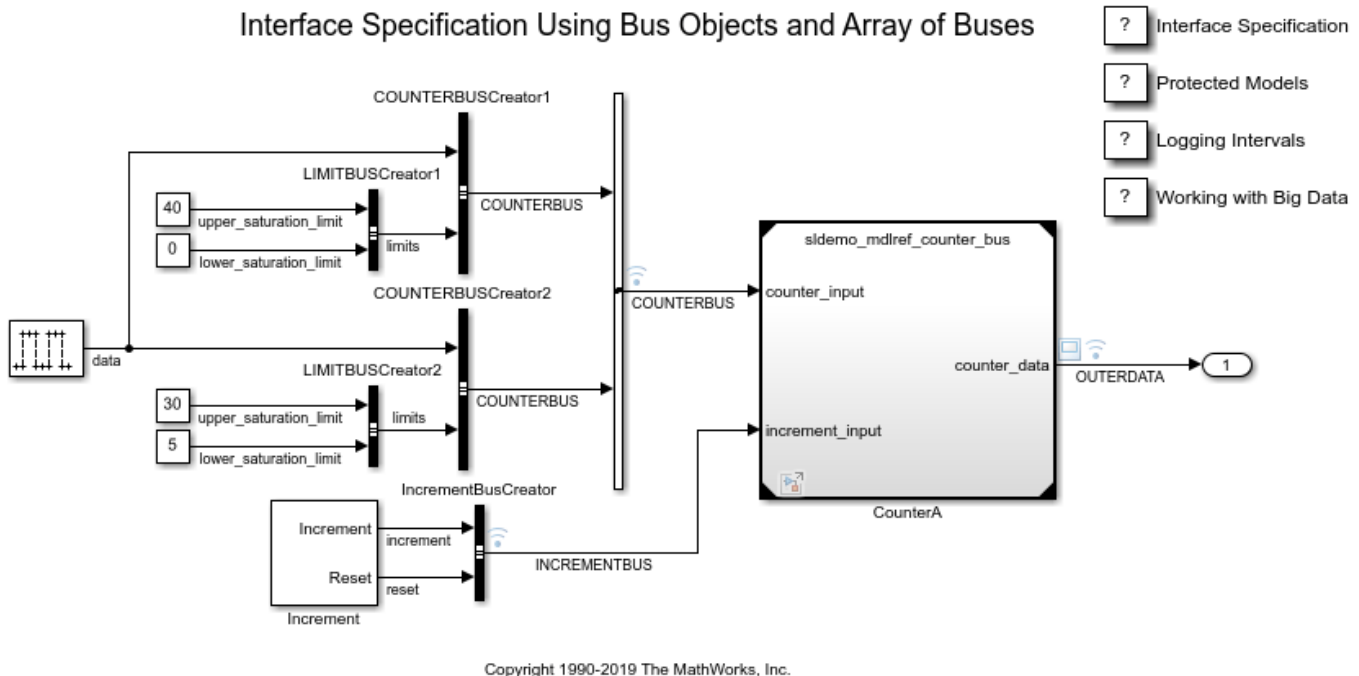

Set Logging Intervals

To reduce the amount of logged data, limit data logging to specific simulation time intervals. In this example, you specify two intervals to log the data of two system events triggered by the `increment` and `reset` signals. The first interval captures the first reset event. The second interval captures the behavior of the system after the increment event takes place and the signals reach the lower saturation limits. The intervals are based on the `increment` and `reset` signal values.

To set the **Logging Intervals** configuration parameter, in the Simulink Toolstrip, on the **Modeling** tab, click **Model Settings**. In the Configuration Parameters dialog box, on the **Data Import/Export** tab, enable the **Logging Intervals** parameter by selecting **Single simulation output**.

The **Logging Intervals** parameter value must be a real double matrix with two columns. The matrix elements must not be NaN. Each row defines the start and end times for an interval. Intervals must be disjoint and ordered.

For this example, set **Logging Intervals** to `[9, 10.5; 14.5, 30]`.

Simulate the Model and View Results

Simulate the model.

OUTERDATA is a wide signal with two elements. The scope shows the values of the OUTERDATA signal during simulation. The scope does not honor the **Logging Intervals** setting.

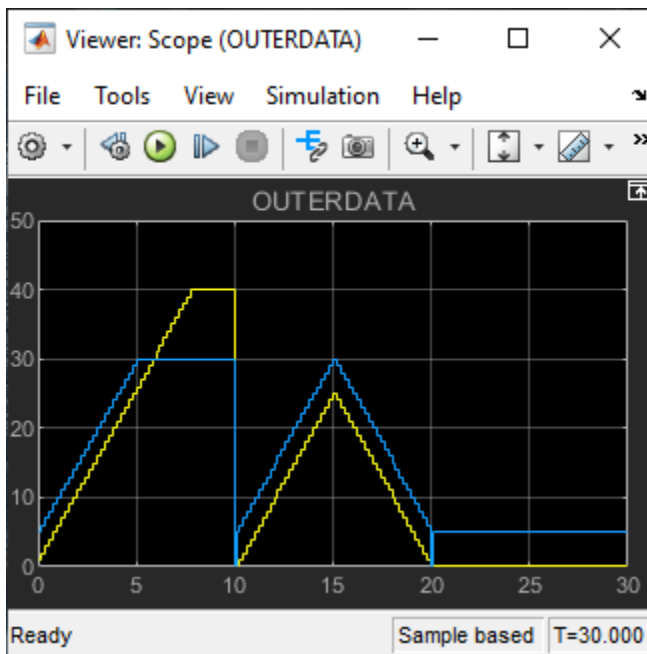

The **Logging Intervals** setting is honored when logging time, root outputs, signals, data store memory, states, and other kinds of data. To display the logged values of OUTERDATA captured as part of signal logging, use the `stem` function, which ignores the interpolation settings of the data.

```
time = out.get('topOut').get('OUTERDATA').Values.Time;
data = out.get('topOut').get('OUTERDATA').Values.Data;
stem(time,data,':. ');
xlabel('Simulation Time');
xlim([0 35]);
ylabel('OUTERDATA');
ylim([0 45]);
```

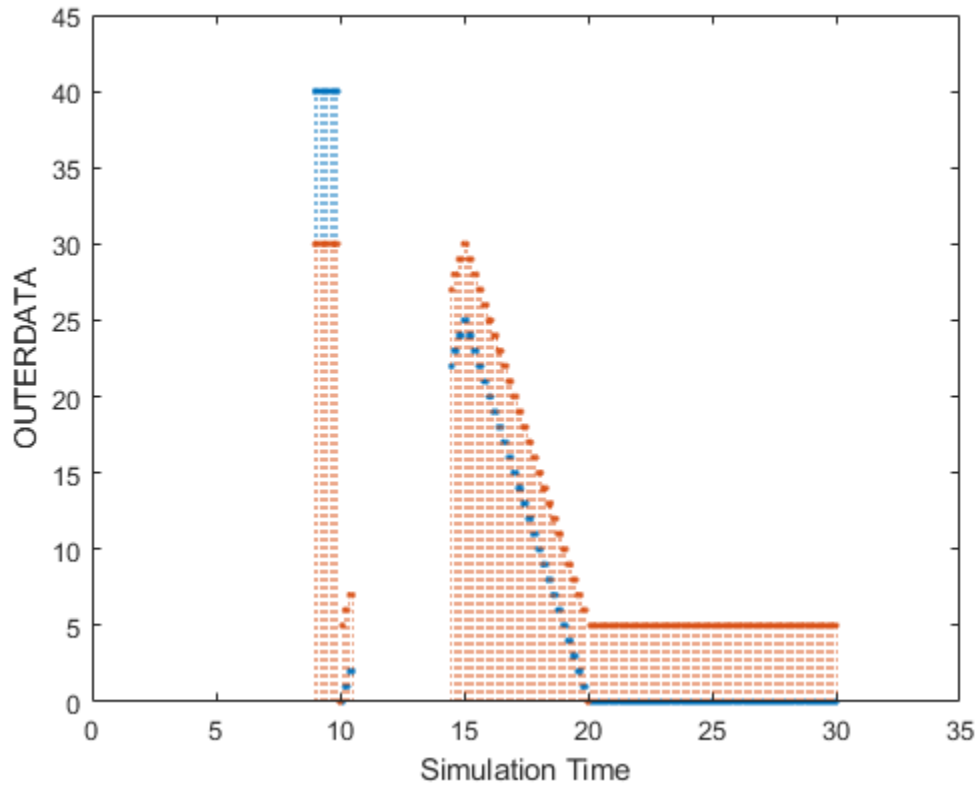

See Also

Related Examples

- “Export Simulation Data”
- “Export Signal Data Using Signal Logging”
- “Specify Signal Values to Log”

Working with Big Data

This example shows how Simulink models handle big data as input to and output from a simulation.

Description of the Example

Big data refers to data that is too large to load into system memory all at once.

Simulink can produce big data as simulation output and consume big data as simulation input. To handle big data for both input and output, the entire data is stored in a MAT-file on the hard disk. Only small chunks of this data are loaded into system memory at any time during simulation. This approach is known as streaming. Simulink can stream data to and from a MAT-file. Streaming solves the memory issues because the capacity of the hard disk is typically much greater than the capacity of the random access memory.

This example shows how to handle big data in Simulink simulations. The logging to file capability is used to stream big data as the output of a simulation. Streaming from file then supplies big data as input to a simulation.

Set up Logging to File

To stream output data to a MAT-file, enable logging to file.

Enable logging to file by selecting the "**Configuration Parameters > Data Import/Export > Log Dataset data to file**" option. You can also specify the name of the file that will contain the result.

The programmatic way to enable Logging to file is by setting the model parameter `LoggingToFile` to on.

When logging to file is enabled on a model, simulation of that model streams logged signals directly into the MAT-file. Additionally, if logging of States or Output is enabled and `SaveFormat` is specified as Dataset, those values are streamed into same the MAT-file.

Simulate the Model

This example changes the directory to a temporary directory, which has write permissions. Then the example calls the `sim` command to simulate the model, logging to file.

Set the parameter `SignalLoggingName`, which specifies the name of the Dataset object to hold the result of signal logging, to `topOut`. Set the parameter `LoggingFileName`, which specifies the name of the resulting MAT-file, to `top.mat`. The `StopTime` parameter is set to 5000 seconds. For a more realistic big data example, the stop time would be a much larger value, which would result in many more data samples to log. `cd(tempdir);`

```
### Starting serial model reference simulation build
### Successfully updated the model reference simulation target for: sldemo_mdref_counter_bus
```

Build Summary

Simulation targets built:

| Model | Action | Rebuild Reason |
|--------------------------|-----------------------------|---|
| sldemo_mdref_counter_bus | Code generated and compiled | sldemo_mdref_counter_bus_msf.mexw64 doe |

```
1 of 1 models built (0 models already up to date)
Build duration: 0h 0m 15.59s
```

Create a DatasetRef Object to Reference the Logged Dataset Within the MAT-file

Use a DatasetRef object to reference the resulting Dataset in the logged MAT-file. The benefit of using DatasetRef is that the referenced MAT-file is not loaded into memory. DatasetRef is a very light wrapper object for referencing a Dataset that is stored in a file. The alternative of calling the load function on this file loads the entire file into memory, which might not be possible if this Dataset contains big data.

Obtain a Reference to a Logged Signal

You can use { } indexing of DatasetRef object to reference individual signals within a Dataset, without loading these signals into memory. For example, to reference the seconds signal:

The Values field of sig2 is a SimulationDatastore object, which is a light-weight reference to the data of signal 2, stored on disk:

```
ans =
```

```
SimulationDatastore with properties:
```

```
    ReadSize: 100
  NumSamples: 50001
    FileName: 'C:\TEMP\Bdoc21b_1757077_3096\ib2EDA31\26\tp490052a0\ex31145726\top.mat'
```

```
Data Preview:
```

| Time | Data |
|---------|------|
| 0 sec | 1 5 |
| 0.1 sec | 1 5 |
| 0.2 sec | 2 6 |
| 0.3 sec | 2 6 |
| 0.4 sec | 3 7 |
| : | : |

Obtain More References to Other Logged Signals

This example uses some of these logged signals as inputs to the simulation of the referenced model. Create light-weight references for each of these. These are bus signals in the model and the resulting Values fields are structures of SimulationDatastore objects. Each structure reflects the hierarchy of the original bus signal.

Create a New Dataset Object to Use as Simulation Input

Specify the input signals to a simulation through a Dataset object. Each element in this Dataset provides input data to the inport block corresponding to the same index. Create an empty Dataset ds and then place the references to the logged signals into it as elements number one and two.

Use { } indexing on the Dataset object to assign elements into appropriate positions.

Within each element of the Dataset, you can mix references to signal data (e.g., SimulationDatastore object) with in-memory data (e.g., timeseries objects). To change one of the upper saturation limits from 30 to 37:

Stream Input Data into Simulation

Now simulate the referenced model `sldemo_md\ref_counter_bus`, and use the Dataset `ds` as input. The data that is referenced by SimulationDatastore objects is streamed into the simulation without overwhelming the system.

The data for upper saturation limit is not streamed because that signal is specified as an in-memory timeseries. The change in saturation limit is reflected at around time 6 in the scope (the signal now saturates to a value of 37 instead of 30).

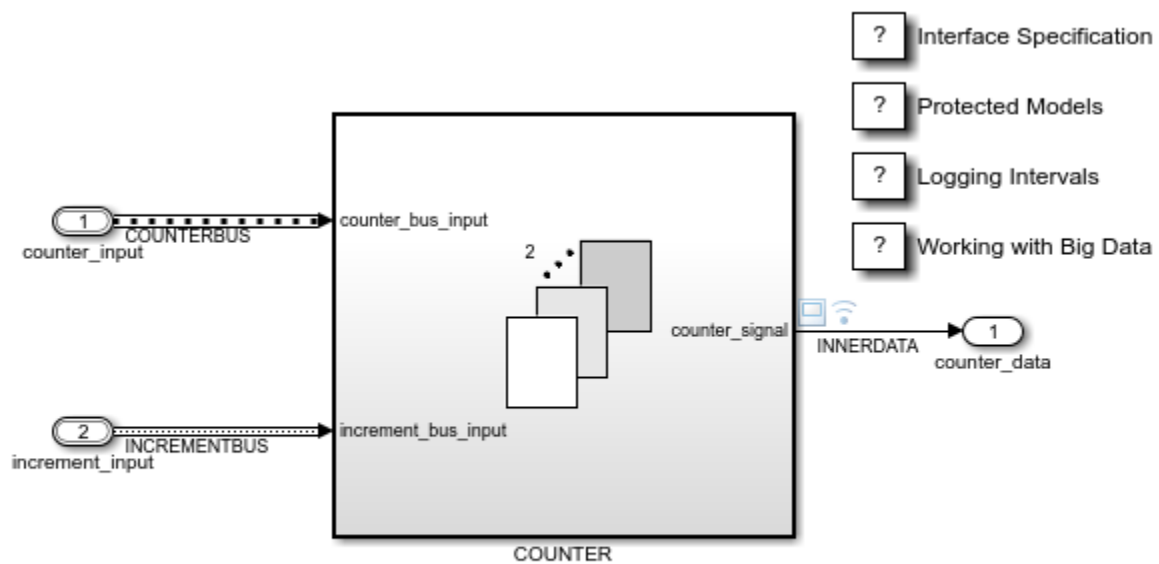

Copyright 1990-2019 The MathWorks, Inc.

Summary

This example has demonstrated a round trip workflow of big data from and to simulation. Logging to persistent storage was used to stream data from the first simulation into a MAT-file. A second simulation was then set up to stream the data from that file as input. A more realistic example would have a larger value for the model `StopTime` parameter, resulting in a larger logged MAT-file. The second simulation could also be configured for a longer `StopTime`. However, even with the larger data files for output and input, the memory requirements for the longer simulations remain the same!

MATLAB® Workflow

SimulationDatastore allows you to analyze the logged data incrementally in MATLAB. Going back to the reference to the second logged signal, assign the datastore to a new variable to simplify access to it.

Access the Data in Chunks

SimulationDatastore allows incremental reading of the referenced data. The reading is done in chunks and is controlled by the ReadSize property. The default value for ReadSize is 100 samples (each sample for a signal is the data logged for a single time step of simulation). Change it to 1000 for this example. Each read of the datastore returns a timetable representation of the data.

Reset the SimulationDatastore Read Counter

Each read on the datastore advances the read counter. You can reset this counter and start reading from the beginning:

Iterate Through All Data in the Datastore

Use SimulationDatastore for incremental access to the logged simulation data for big data analysis in MATLAB. You can iterate over the entire data record and chunks:

See Also

Classes

`matlab.io.datastore.SimulationDatastore` | `Simulink.SimulationData.DatasetRef`

Related Examples

- “Load Big Data for Simulations”
- “Analyze Big Data from a Simulation”

Simulink Subsystem Semantics

This set of examples shows different types of Simulink® Subsystems and what semantics are used when simulating these Subsystems. Each example provides a description of the model and the subtleties governing how it will be executed.

Examples are provided for the following Subsystem types.

- Virtual and Nonvirtual Subsystems
- Function-call Subsystems
- Triggered Subsystems
- Enabled Subsystems
- Triggered and Enabled Subsystems
- If/else Subsystems
- While Subsystems
- For Subsystems

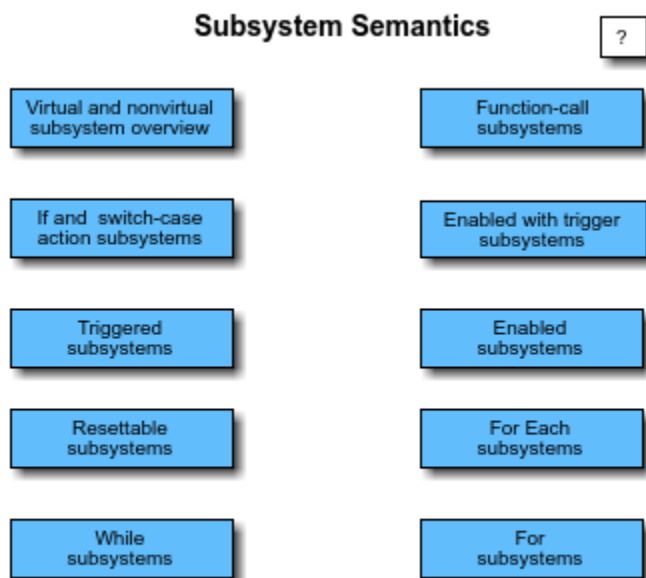

Copyright 1990-2015 The MathWorks, Inc.

See Also

Subsystem

More About

- “Subsystems”

If-Then-Else Blocks

This example shows the effect of feeding a sine wave into If Action Subsystem blocks. It is designed to illustrate the similarity between the If Action Subsystem block and the Enabled Subsystem block.

A pulse generator is connected to an If block, which compares the input to zero. If the input is positive, as specified by the `if` condition, then the If Action Subsystem `Abs` is activated, which outputs the absolute value of the sine wave input signal. If the input to the If block is not positive, as specified by the `else` condition, then the If Action Subsystem `Saturation between -0.75 and 0.75` is activated, which outputs a clipped version of the sine wave signal using a Saturation block.

The outputs of the two subsystems are never active at the same time and are merged into one signal with a Saturation block. The output signal is then biased by +2.

The scope shows the sine wave input, the triggering pulse input, and the merged and biased output. When the pulse is on, the output is the absolute value of the sine wave. When the pulse is off, the output is the clipped version of the sine wave. In each case, the output is biased by +2.

If Block Example

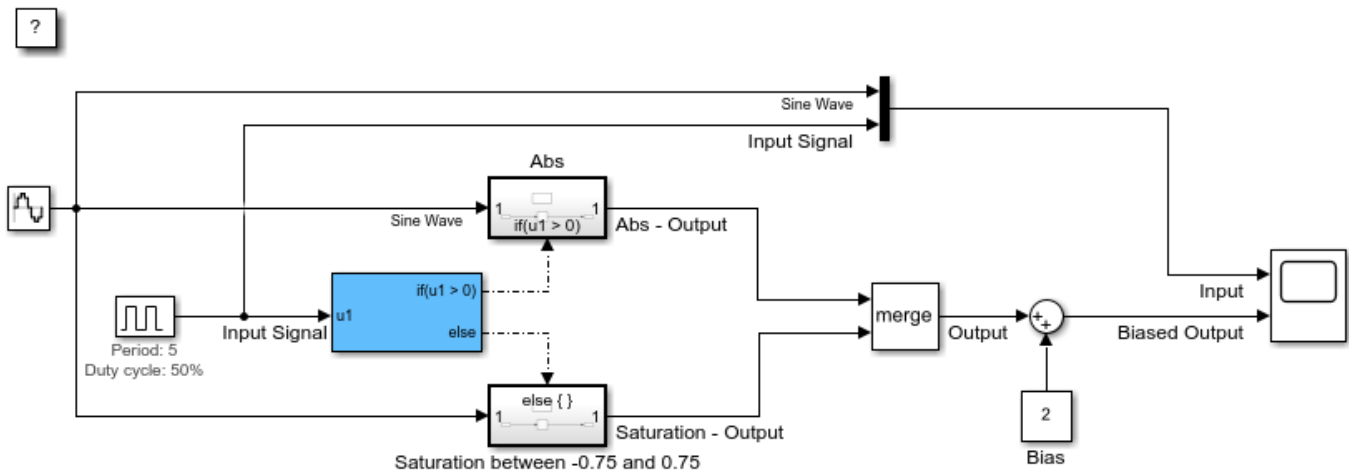

Copyright 1990-2021 The MathWorks, Inc.

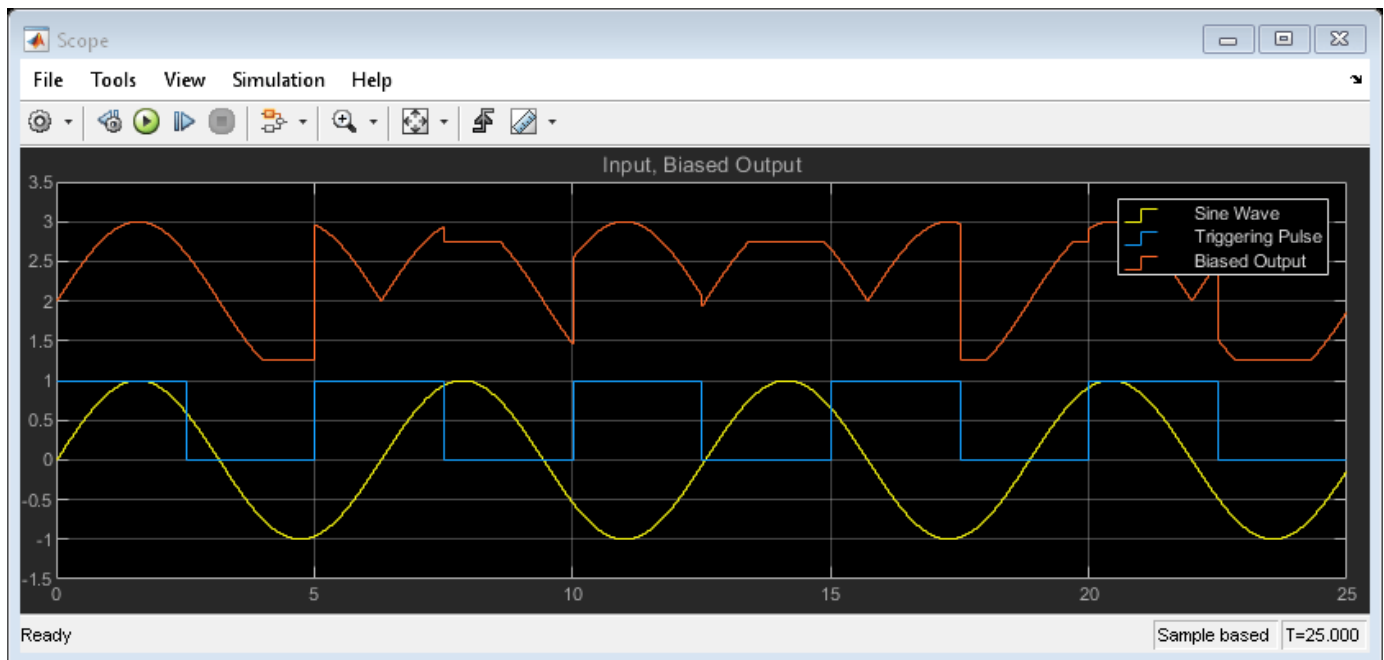

See Also

"Select Subsystem Execution" | Large-Scale Modeling for Embedded Applications

Related Examples

- "Simulink Subsystem Semantics" on page 13-363

Triggered Subsystems

This model shows triggered subsystems and describes the different trigger types. A triggered subsystem is executed for a single time step whenever the trigger port transitions in a specified direction. The transition of the trigger port may occur when the direction of the transition is rising, falling, or either rising or falling. A rising transition occurs when the trigger signal transitions from zero or below to a positive value. A falling transition occurs when the trigger signal transitions from zero or above to a negative value.

After running the simulation, look closely at the top plot in the scope. This shows a sine wave, a waveform, and the grounded value of zero. As the waveform transitions through zero, each of the subsystems is triggered appropriately. The output of each subsystem is equal to the current value of the sine wave at that time.

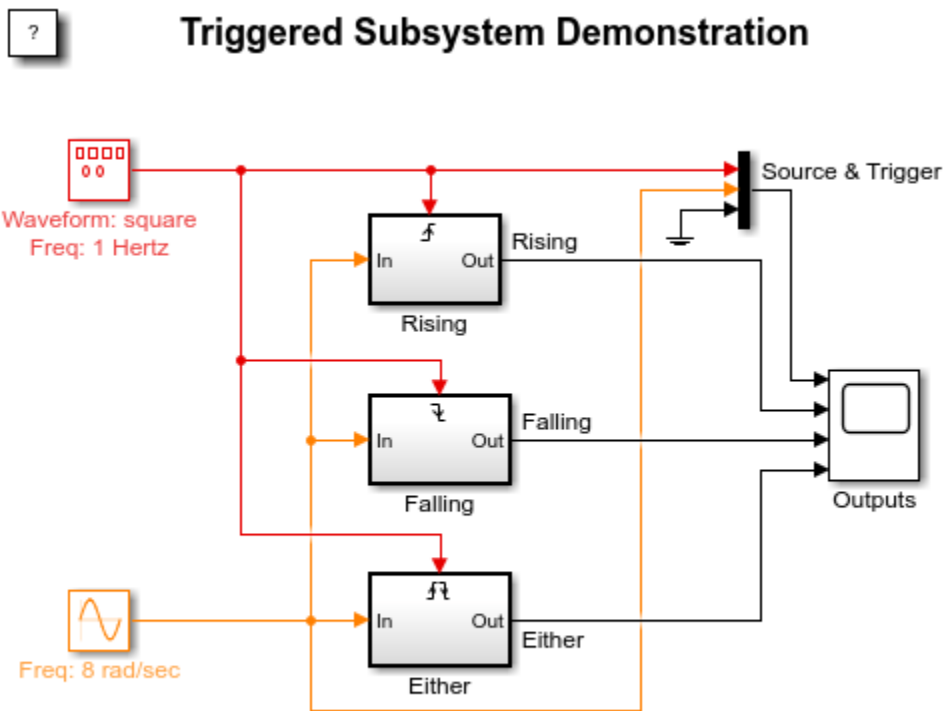

Copyright 1990-2015 The MathWorks, Inc.

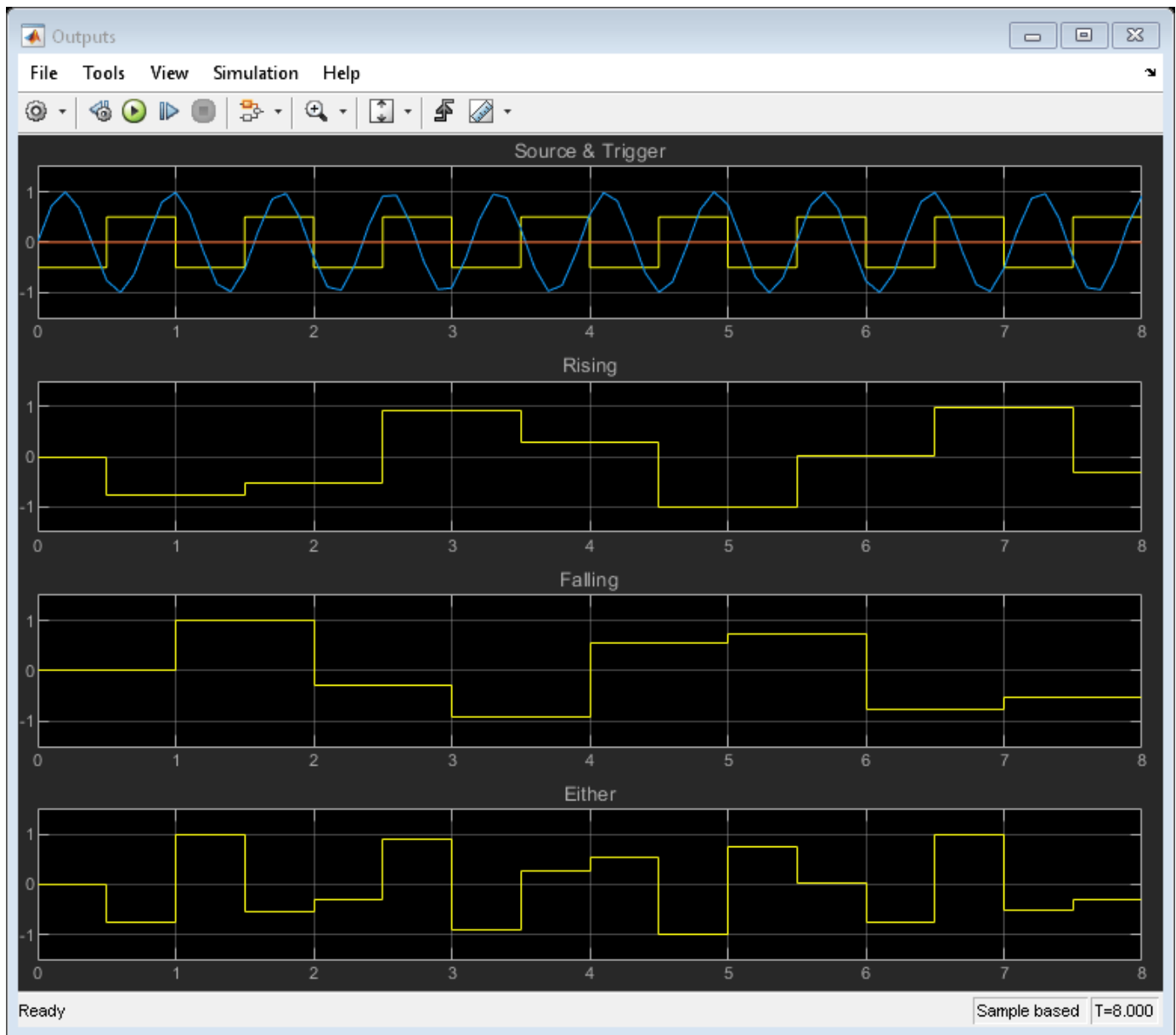

Enabled Subsystems

This example shows what happens when a sine wave is fed into an enabled subsystem. After running the simulation, the scope shows three plots.

The first of these plots shows the original sine wave and the absolute value of the original sine wave offset by two. The absolute value of the sine wave is shown only when the subsystem is enabled. This occurs between 0 and 2.5 seconds, and between 5 and 7.5 seconds. When the subsystem is not enabled, the output of the subsystem is reset to 0. The value of 0 is determined by the initial condition of the output. You can see when the subsystem is enabled by looking at the second plot. A value of 1 indicates that it is enabled.

The second plot shows the original value of the enable signal. When the signal is towards the top of the plot, the subsystem related to the first plot is enabled. When the signal is towards the bottom of the plot, the subsystem related to the third plot is enabled. The difference in when the subsystems are enabled is caused by the logical NOT block.

The third plot shows the original sine wave and the saturation limited sine wave offset by two. The saturated value of the sine wave is shown only when the subsystem is enabled. This occurs between 2.5 and 5 seconds, and between 7.5 and 10 seconds.

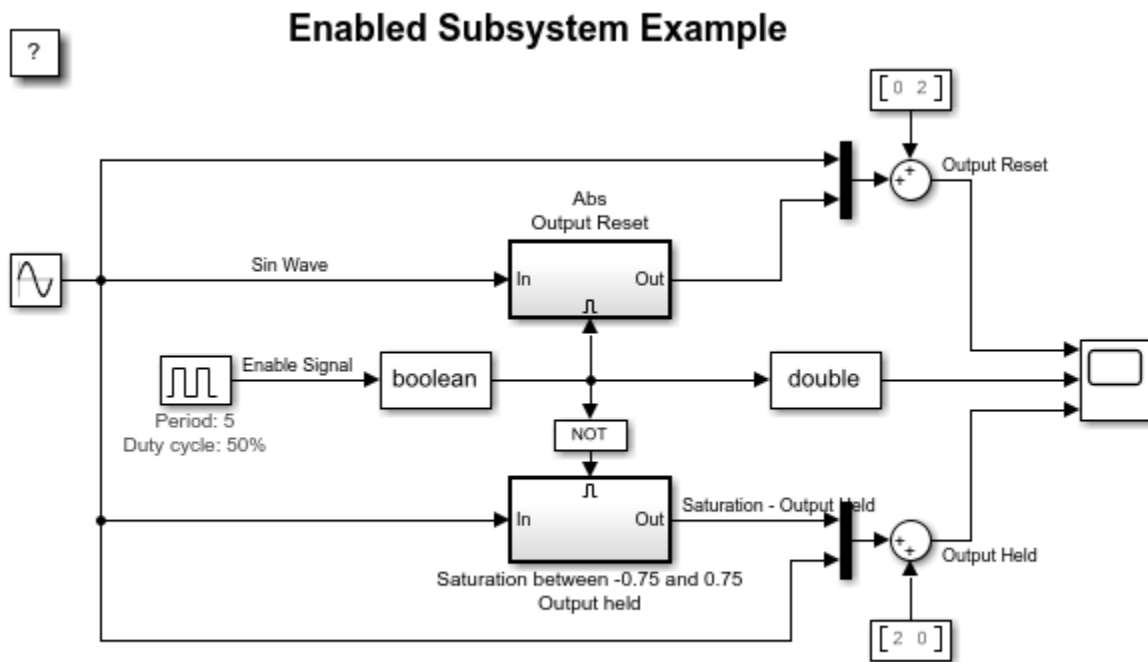

Copyright 2004-2015 The MathWorks, Inc.

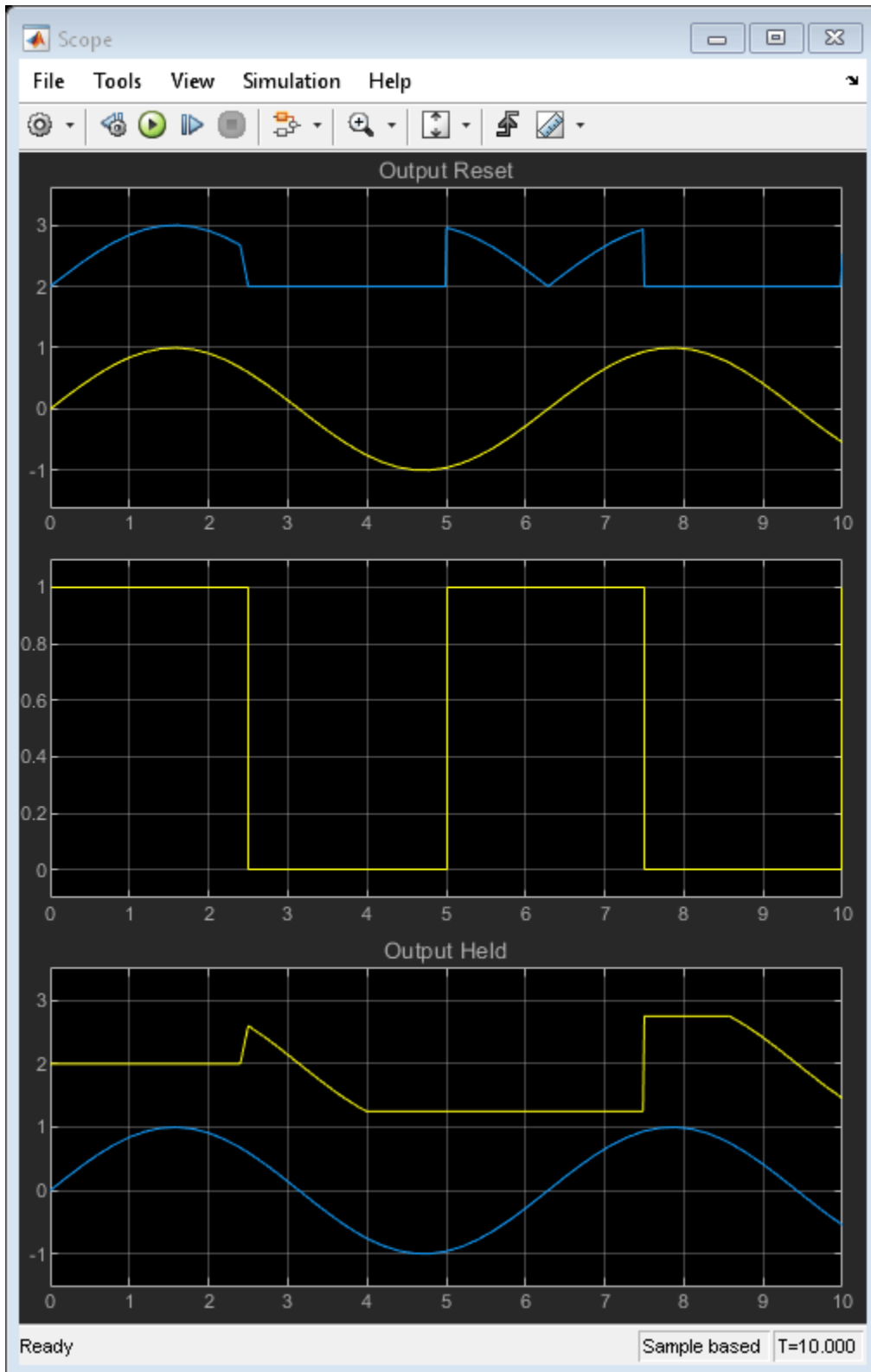

Advanced Enabled Subsystems

This model shows what happens when a sine wave is fed into an enabled subsystem. The four subsystems in the model contain integrators, either discrete or continuous as described by the subsystem name. After running the simulation, the two scopes show the results for the discrete enabled subsystems (top scope) and continuous enabled subsystems (bottom scope).

Each scope shows the output for all combinations of the states and outputs of the enabled subsystem being either held or reset when the subsystem is disabled. The colors on the scope correspond to the following state and output configurations:

Yellow: Reset states; Held outputs

Purple: Reset states; Reset outputs

Cyan: Held states; Held outputs

Red: Held states; Reset outputs

Enabled Subsystems in Simulink

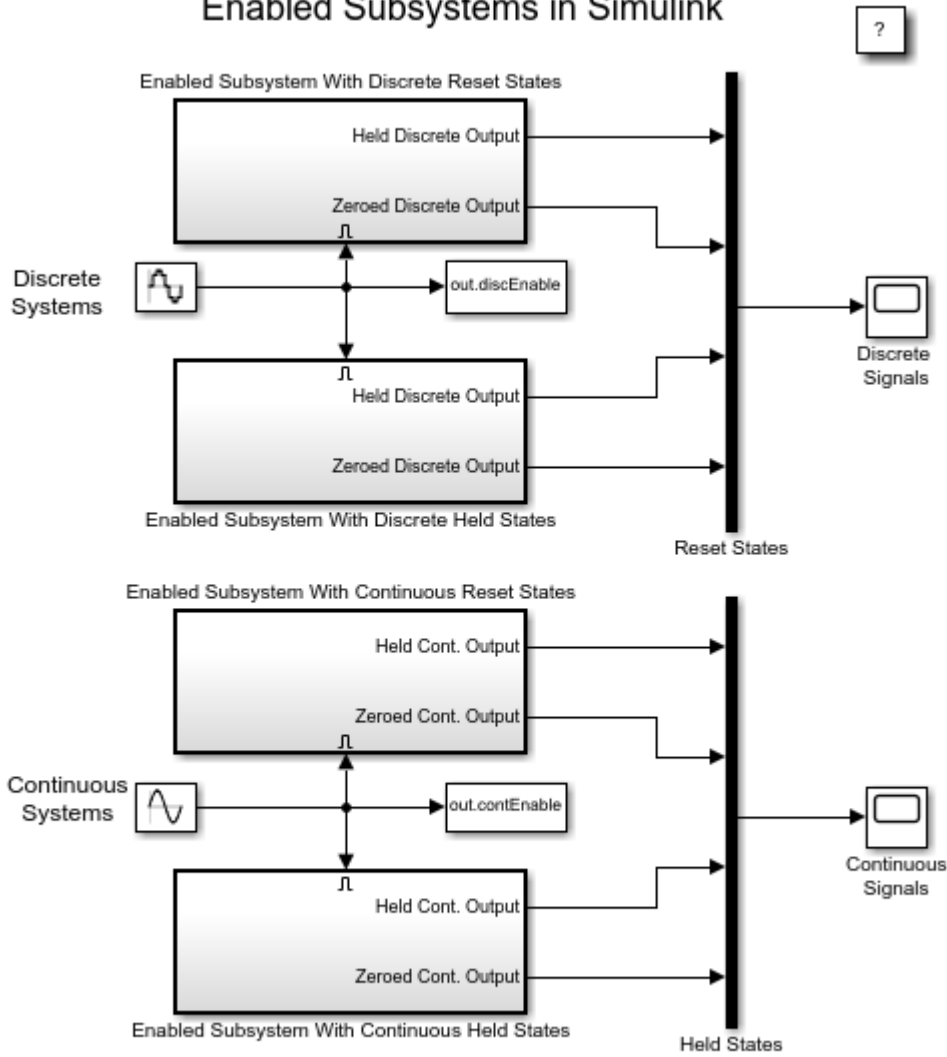

Copyright 2004-2015 The MathWorks, Inc.

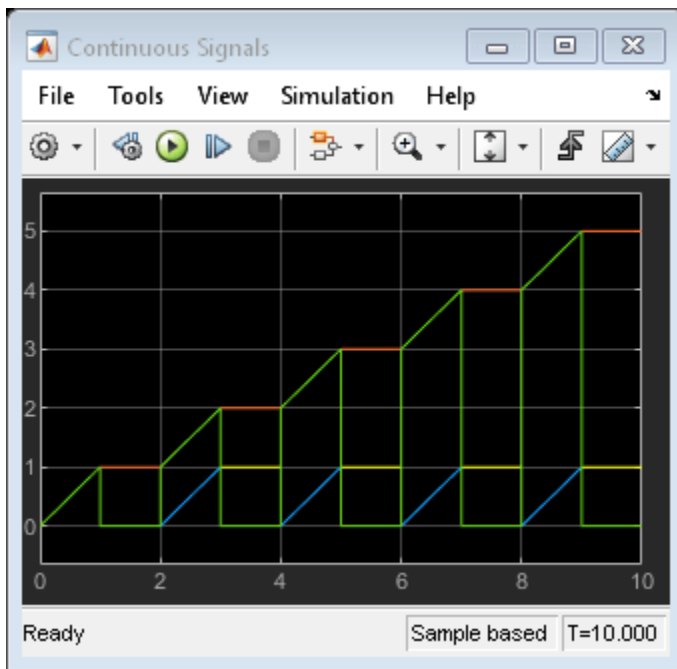
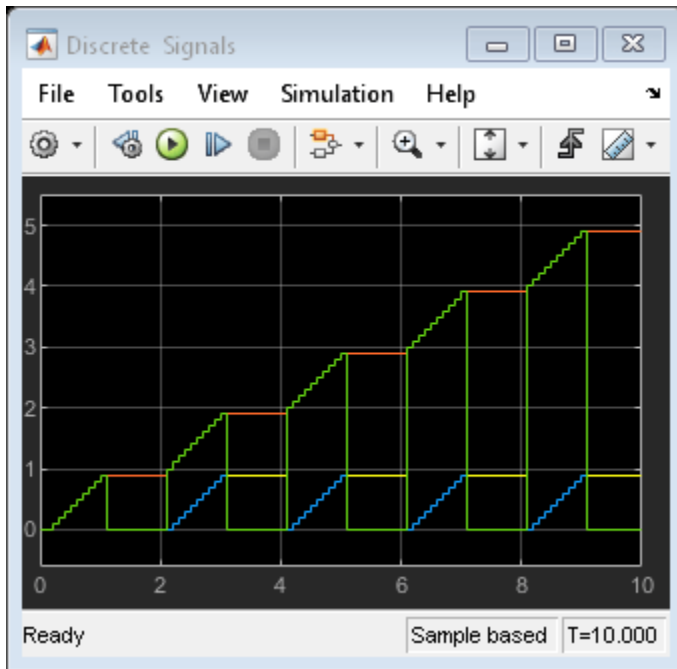

Resettable Subsystems

This example shows how to use two resettable subsystems to implement a ramp signal. Consider using resettable subsystems when you want to conditionally reset the states of all blocks within a subsystem to their initial condition. A resettable subsystem executes at every time step but conditionally resets the states of blocks within it when a trigger signal occurs at the reset port. For more information, see “Using Resettable Subsystems”.

After running the simulation, the scope shows three plots. The top and bottom plots show the original ramp as a reference, along with its integration. The subsystems corresponding to the top and bottom plots reset on every rising and falling edge of the pulse, respectively. When each subsystem resets, the state of the Integrator block is set to its initial condition value, which is 0. Refer to the middle plot to determine when each subsystem resets.

The reset happens for blocks within the subsystem, without the need for each block to have its own reset port. This provides a more convenient way of handling resets at a subsystem level.

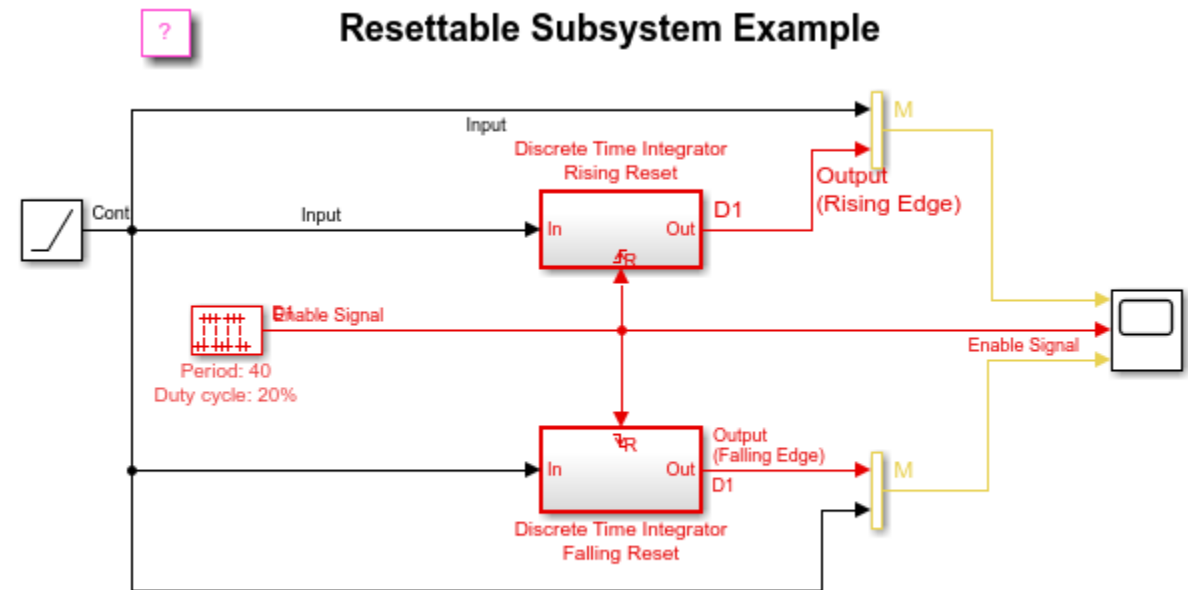

Copyright 2015 The MathWorks, Inc.

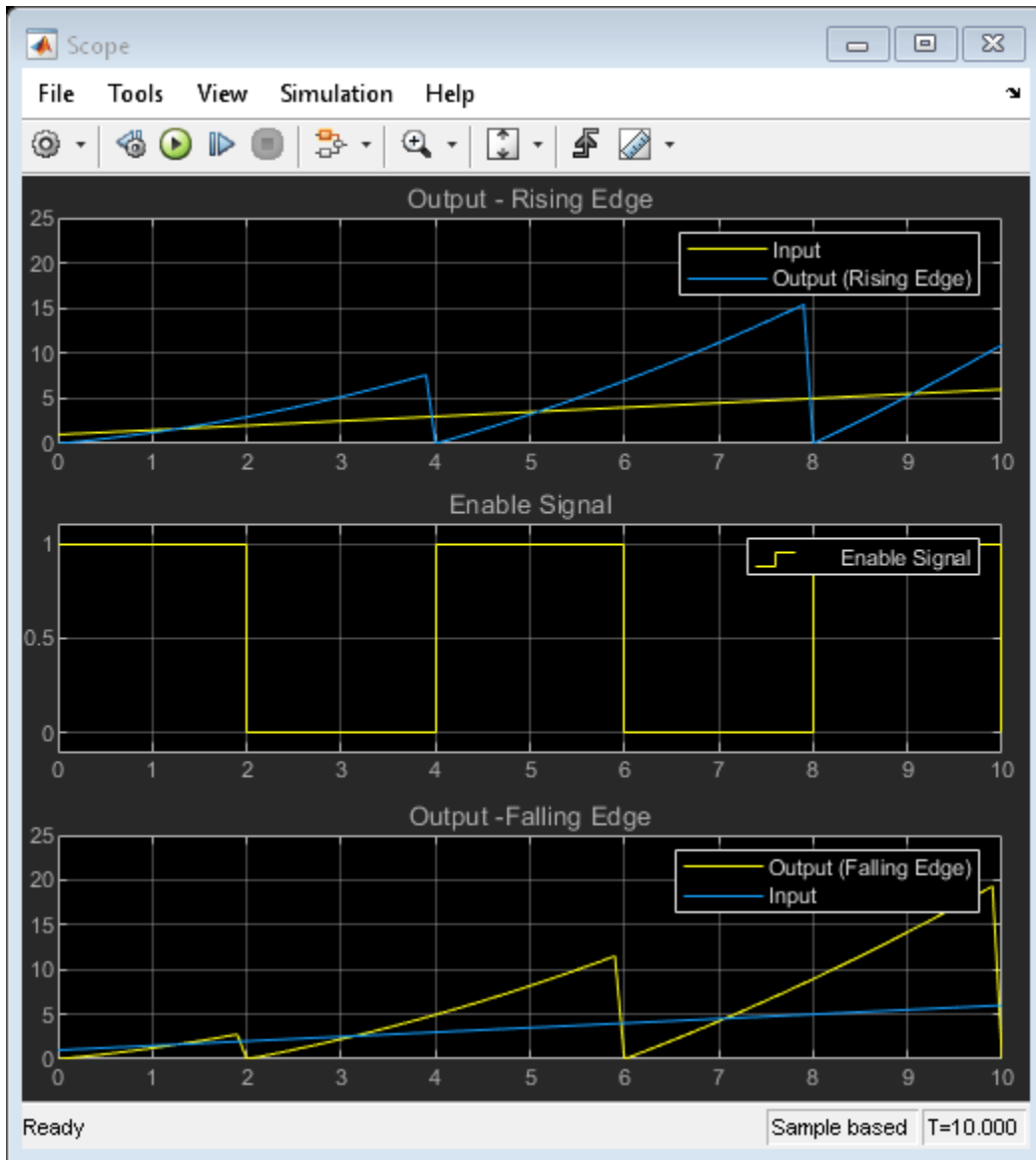

See Also

Resettable Subsystem

Related Examples

- “Discrete and Continuous Resettable Subsystems” on page 13-375

More About

- “Using Resettable Subsystems”

Discrete and Continuous Resettable Subsystems

This example shows the comparison between behaviors of discrete and continuous resettable subsystems. After running the simulation, the two scopes show the results for the discrete resettable subsystem (top scope), and continuous enabled subsystems (bottom scope).

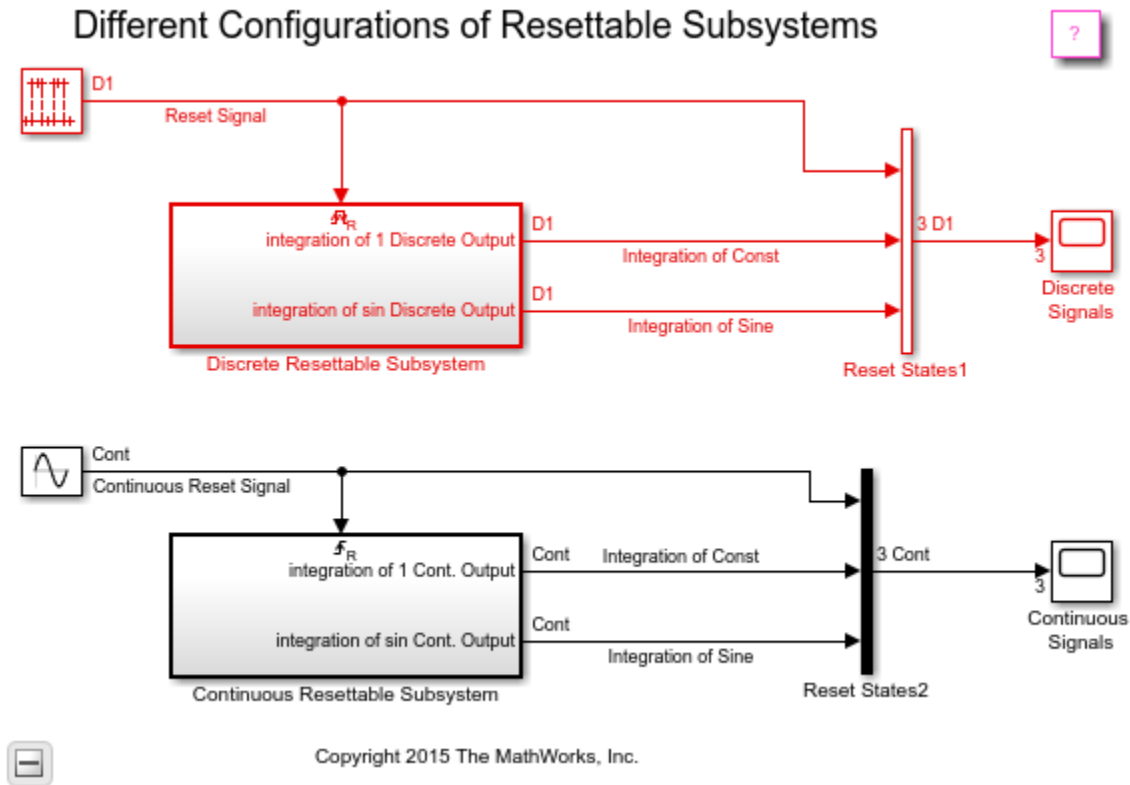

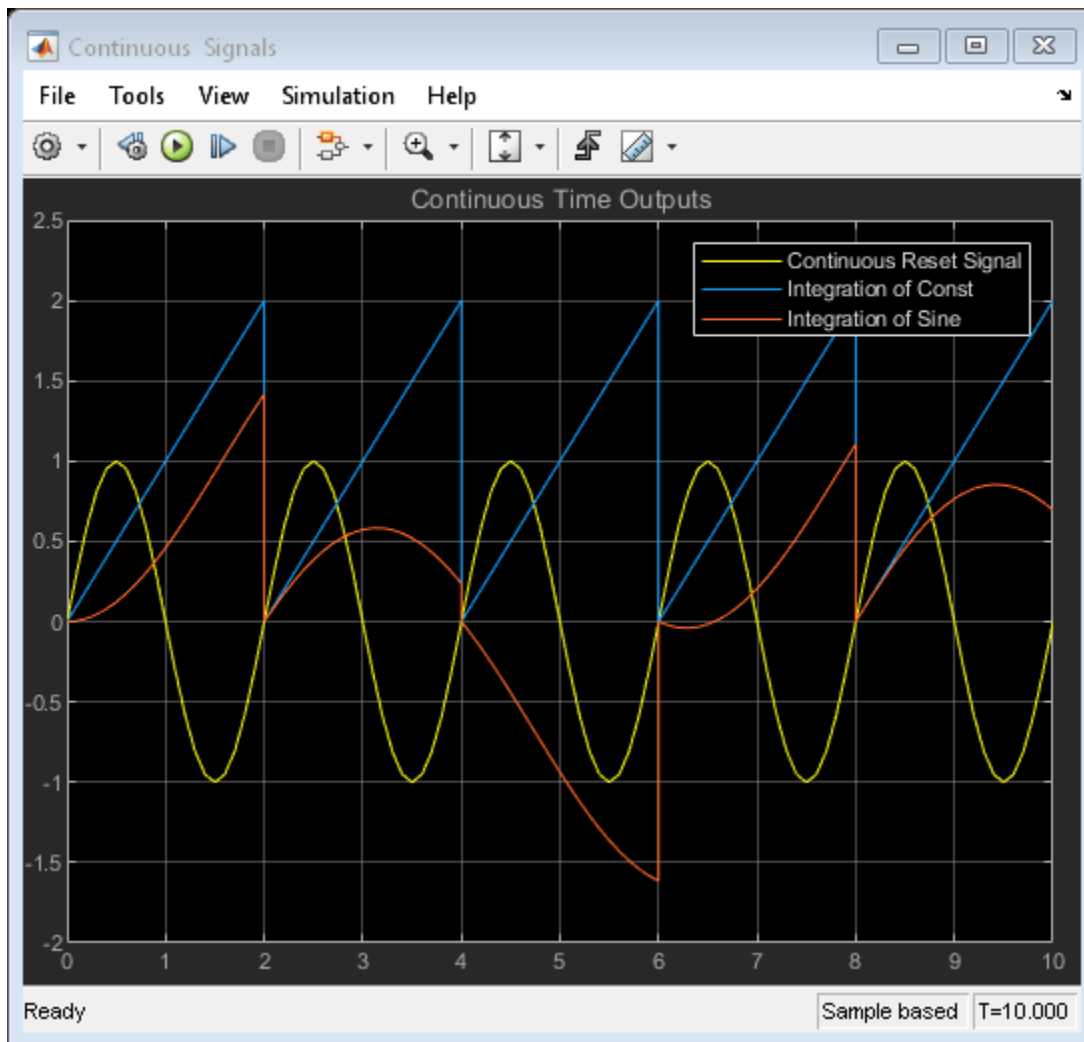

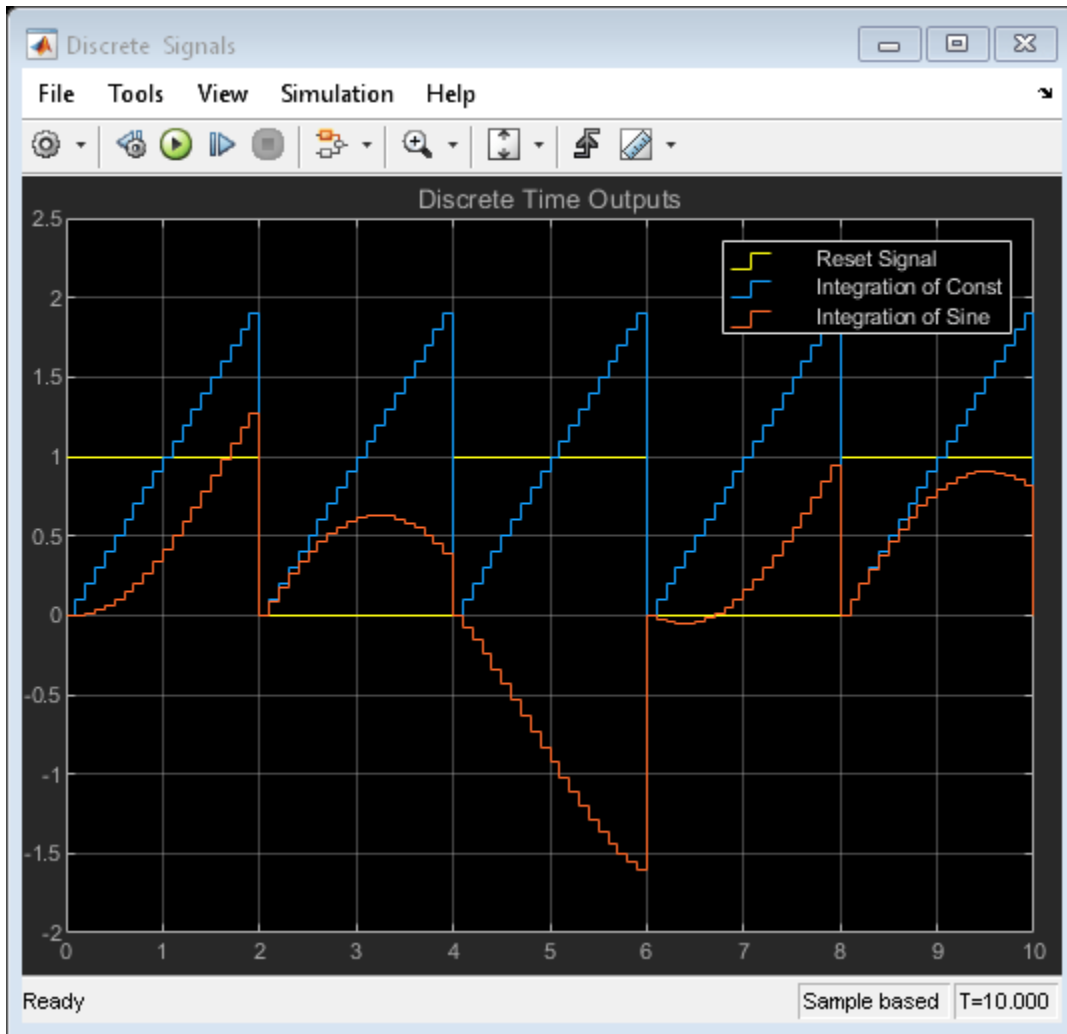

See Also

Resettable Subsystem | Enabled and Triggered Subsystem

Related Examples

- "Conditionally Executed Subsystems Overview"

Block Priority

This model shows what happens when blocks are assigned different priorities. The block priority affects the order in which the blocks are executed. You can set the block priority through the Block Properties dialog. A smaller number indicates a higher priority.

The block sorting order is calculated only at the beginning of a simulation. For this reason, changes to a block's Priority property are only updated when the simulation is started. Double click on the green block to change the priority levels for the blocks and see what happens.

Inside of each triggered subsystem is an S-Function which controls the coloring of the blocks and also slows down the simulation. The priority level of the block is displayed using the format attribute string that can be set in the Block Properties dialog.

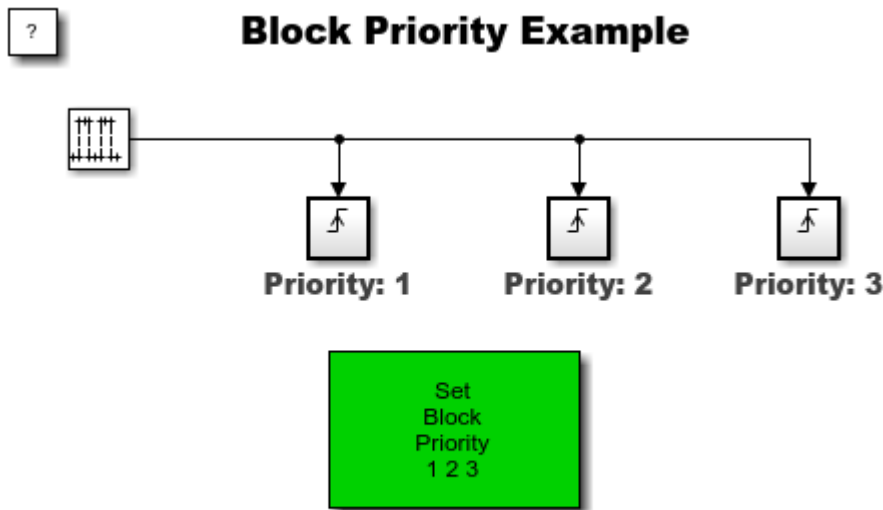

Copyright 2004-2015 The MathWorks, Inc.

See Also

“Specify Block Execution Priority and Tag” | “Control and Display Execution Order”

Monitoring Ink Status on a Shared Printer Using Simulink Functions

This example shows how clients, in this case three computers, can send jobs to a server, a printer, and receive status from that server. This example highlights how Simulink functions can be called from different subsystems and interact in both Simulink® and Stateflow®. (Note that when you simulate the example, Stateflow might generate code in the current working folder.)

The computers each generate randomly sized print jobs at regular intervals. The printer interacts with the computers through two Simulink functions on the Simulink canvas and one exported graphical function in Stateflow.

The clients use Function Caller blocks to invoke the `addPrintJob` interface of the printer. The client-server interaction modeled by this call may have a negative return value if the printer has run out of ink.

The example also shows how to interface Simulink and Stateflow using functions.

The implementation of `addPrintJob` uses a Function Caller block to invoke `queuePrintJob`, a Stateflow exported graphical function. The `queuePrintJob` function interacts with other content in the chart using a local chart variable `work`.

The implementation of the chart makes a call to `printerInk`, a Simulink function, which uses the graphical input and outputs to interact with the `addPrintJob` function.

You can also visualize and debug Simulink functions.

To enable the visualization lines connecting functions and their respective callers, in the Simulink Editor, on the **Debug** tab, under **Information Overlays**, click **Function Connectors**.

The Sequence Viewer block shows where calls to functions are generated and which functions are called at different times. This information allows you to understand the flow of calls with respect to time and analyze the arguments sent during these calls to functions.

Monitoring Ink Status on a Shared Printer Using Simulink Functions

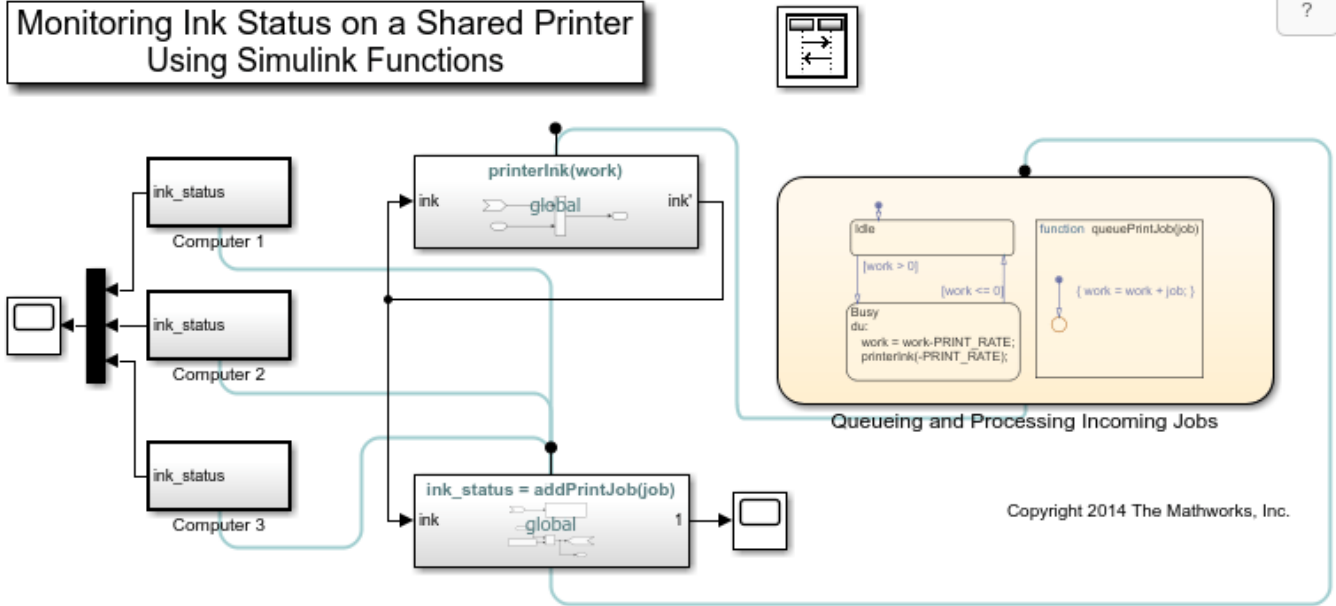

Modeling Reusable Components Using Multiply Instanced Simulink Functions

In this example, the model `slexCounterFunctionMdlRef` contains a Simulink function `update()`, which maintains a counter. Multiple instancing provides the ability to reuse this logic as `CounterA` and `CounterB` in this application model.

Overview

The qualified calling notation `CounterA.update` and `CounterB.update` is used to distinguish the two different instances of the counter logic. Note that each instance may be called from multiple caller blocks as illustrated in this example.

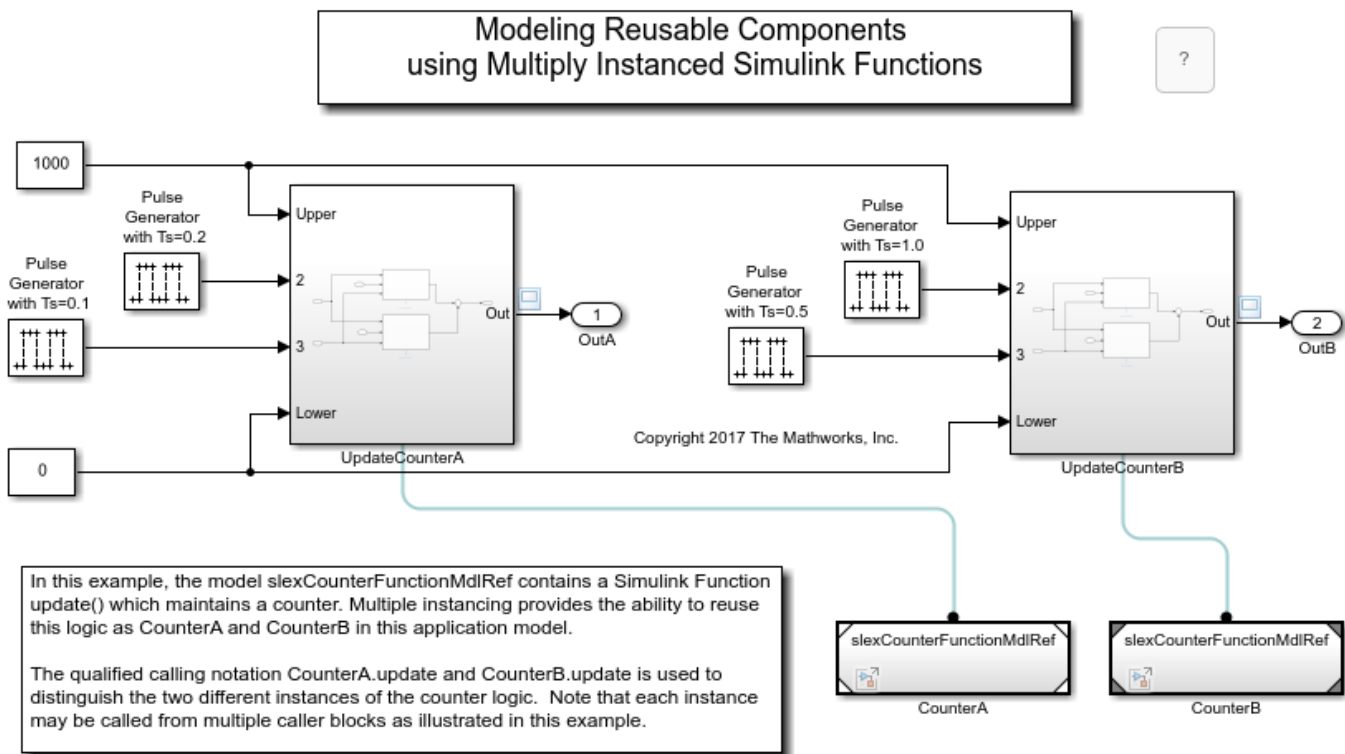

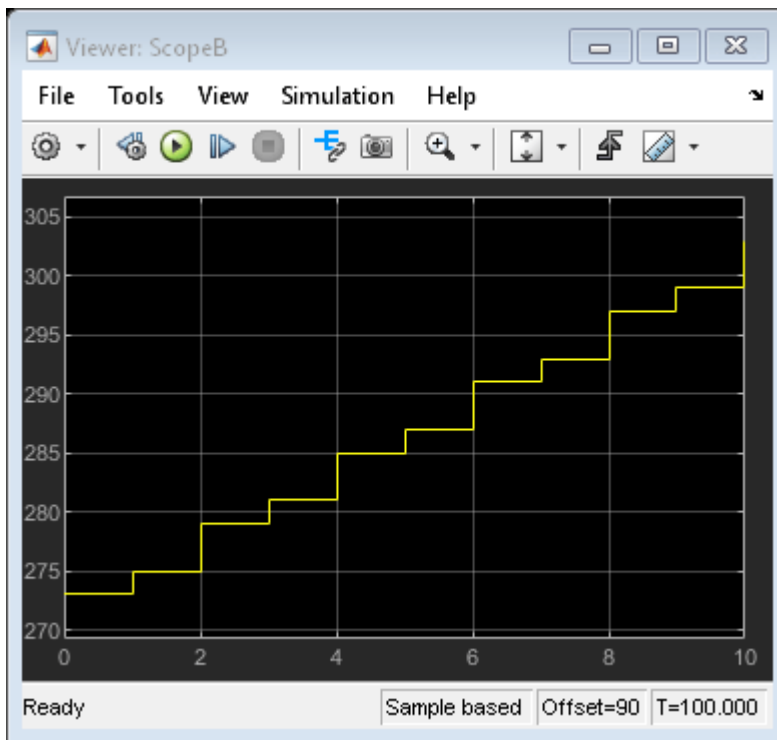
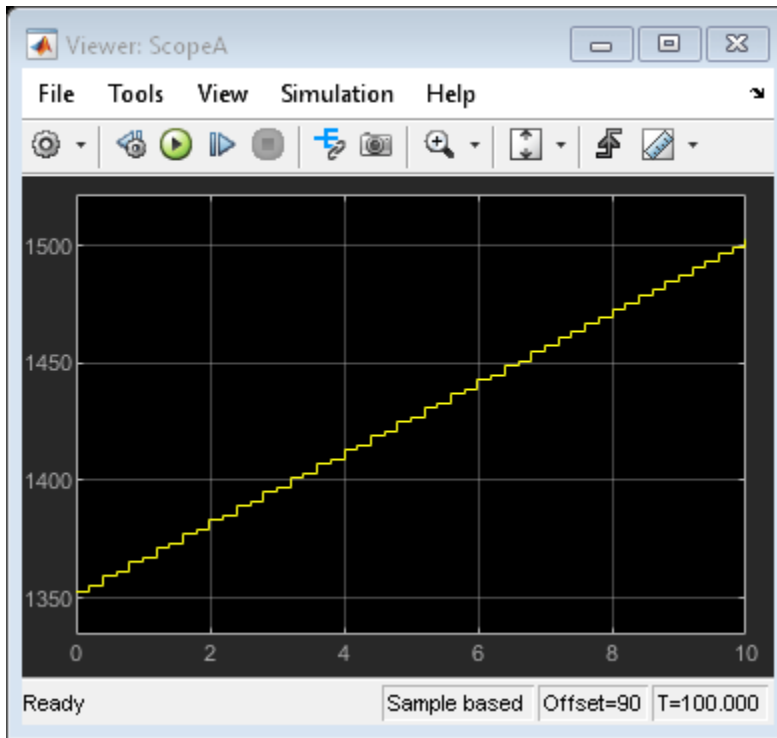

Dynamic Priority Scheduling of Functions

This example shows a common modeling pattern to dynamically schedule the execution of functions using a Stateflow® chart.

Overview

Simulink messages provide intrinsic support for creating and managing priority queues, which may be used to model a situation in which the execution order of the functions may change between execution intervals.

Additionally, the Sequence Viewer allows you to visualize execution sequences. To view the dynamically changing execution sequence: 1. Double-click on the 'Sequence Viewer' block 2. Click the 'Run' button once

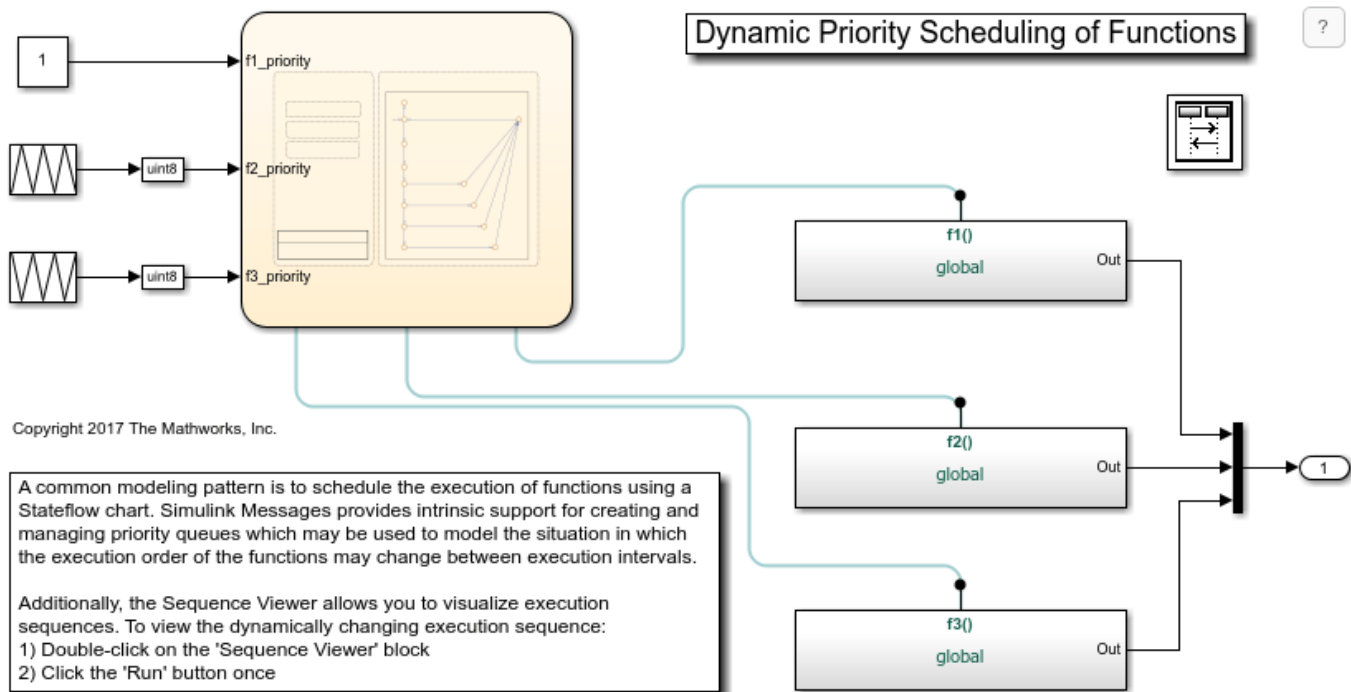

Component-Based Modeling with Model Reference

This example walks you through simulation and code generation of a model that references another model multiple times. In this example, Simulink® generates code for accelerated simulation, and Simulink® Coder™ generates code that can be deployed in standalone applications.

Model Reference Behavior

Model Reference has several advantages over subsystems:

- You can develop the referenced model independently from the models in which it is used.
- You can reference a model multiple times in another model without having to make redundant copies.
- Multiple models can reference a single model.
- The referenced model is not loaded until it is needed. This incremental loading speeds up model load times.
- If a model is referenced in accelerator mode, Simulink creates special binaries to be used in simulations. If the referenced model has not changed since the binaries were created, and the binaries are therefore up to date, no code generation occurs when models that use these binaries are simulated or compiled. This process is called *incremental code generation*. The use of binaries makes updating and simulating the model faster and increases modularity in code generation.
- Generating code for a model with Model blocks also takes advantage of incremental code generation.

Incremental Loading

Open the example model.

```
open_system('sldemo_mdref_basic')
```

Component-Based Modeling with Model Reference

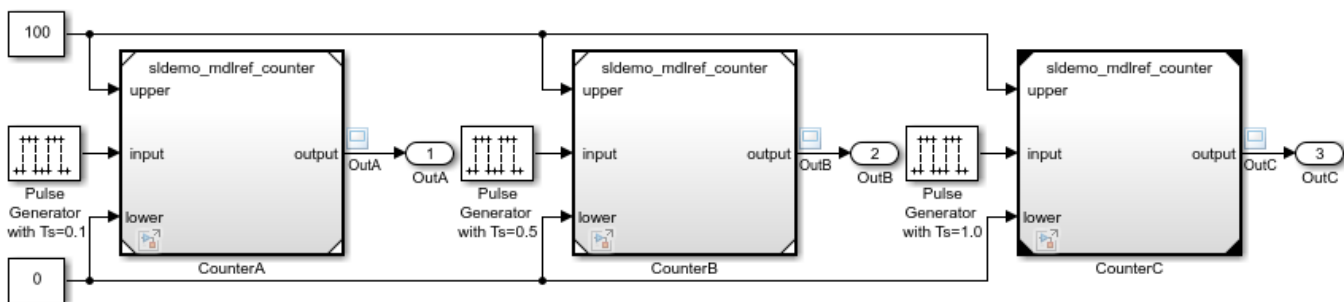

Copyright 1990-2014 The MathWorks, Inc.

This model contains three Model blocks: CounterA, CounterB and CounterC. These blocks reference the same model, `sldemo_mdref_counter`, which is a separate model and not a subsystem of `sldemo_mdref_basic`.

To determine what models are loaded in memory after opening the top model in the model hierarchy, enter this command:

```
get_param(Simulink.allBlockDiagrams, 'Name')
```

```
ans =
```

```
    'sldemo_mdref_basic'
```

The referenced model is not listed because it is not loaded.

Open the referenced model by double-clicking on any Model block or by entering this command:

```
open_system('sldemo_mdref_counter')
```

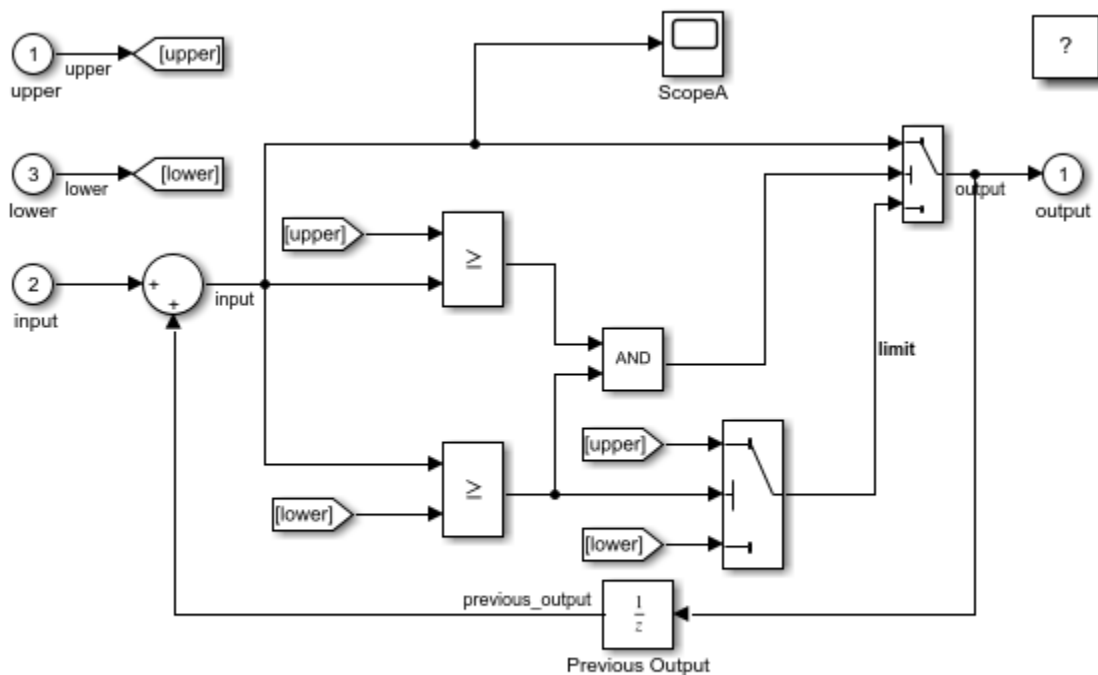

Copyright 1990-2014 The MathWorks, Inc.

Query the models loaded in memory again.

```
get_param(Simulink.allBlockDiagrams, 'Name')
```

```
ans =
```

```
2x1 cell array
```

```
    {'sldemo_mdref_counter'}  
    {'sldemo_mdref_basic' }
```

The referenced model is now listed, demonstrating that models are loaded incrementally as they are needed.

Inherited Sample Times

Navigate back to the parent model `sldemo_mdref_basic`.

`sldemo_mdref_basic` is configured to display sample time colors when it is compiled. On the **Debug** tab, click **Update Model**.

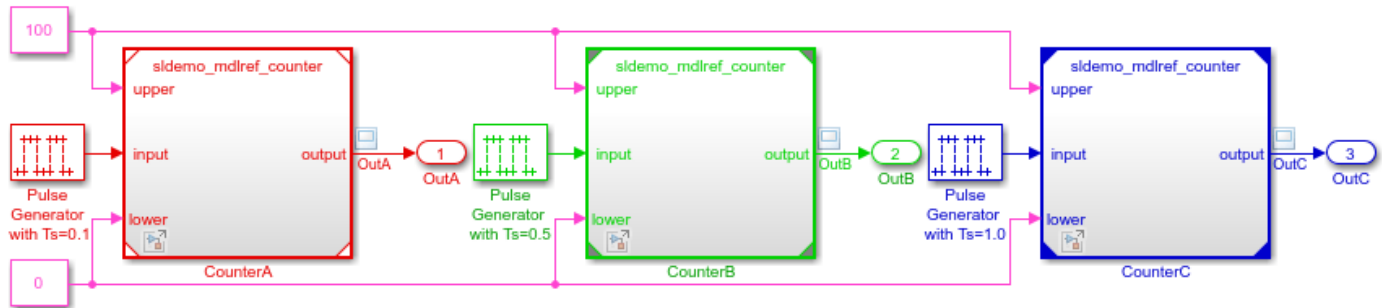

The Model blocks inherit different sample times because the referenced model `sldemo_mdref_counter` does not explicitly specify a sample time.

Simulation Through Code Generation (Does Not Require Simulink Coder)

Model blocks have a **Simulation mode** parameter that controls how the referenced model is simulated. If the parameter is set to **Normal**, the referenced model is simulated in interpreted mode. If the parameter is set to **Accelerator**, the referenced model is simulated through code generation. This process uses a binary file called a *simulation target* for each unique model referenced in accelerator mode. Generating a simulation target does not require a Simulink Coder license.

In this model, CounterA and CounterB reference `sldemo_mdref_counter` in normal mode, which is indicated by the hollow corners on the Model block icons. The other instance, CounterC, references `sldemo_mdref_counter` in accelerator mode, which is indicated by the filled corners on the Model block icon.

You can create the simulation target for the `sldemo_mdref_counter` model by performing any of these actions:

- Updating `sldemo_mdref_basic`
- Simulating `sldemo_mdref_basic`

To build the simulation target programmatically, use this command:

```
slbuild('sldemo_mdref_counter', 'ModelReferenceSimTarget')
```

Once the simulation target is built, subsequently simulating or updating `sldemo_mdref_basic` does not trigger a rebuild of the simulation target unless `sldemo_mdref_counter` has changed.

If all three instances of the referenced model were set to simulate in normal mode, the simulation target would not be built.

Code Generation for Standalone Applications (Requires Simulink Coder)

When creating a standalone executable for `sldemo_mdref_basic`, the build first generates the code and binaries for the *model reference coder target* of `sldemo_mdref_counter`. Generating a model reference coder target requires a Simulink Coder license.

You can build the model reference coder target for `sldemo_mdref_counter` and the standalone executable for `sldemo_mdref_basic` by performing any of these actions:

- Building the standalone executable for `sldemo_mdref_basic`.
- Building the model reference coder target of `sldemo_mdref_counter`, then building the standalone executable for `sldemo_mdref_basic`.

To build the standalone executable programmatically, use this command:

```
slbuild('sldemo_mdref_basic','StandaloneCoderTarget')
```

Once the model reference coder target is built, subsequently building `sldemo_mdref_basic` does not trigger a rebuild of the model reference coder target unless `sldemo_mdref_counter` has changed. The code generated for the referenced model `sldemo_mdref_counter` is reused.

The code generation report for `sldemo_mdref_basic` links to the report for `sldemo_mdref_counter` in the **Referenced Models** section.

See Also

Model

Related Examples

- “Model Reference Basics”
- “Reference Existing Models”
- “Visualize Model Reference Hierarchies” on page 13-396

Viewing Signals in Model Reference Instances

This example shows how to use the Simulation Data Inspector to view and analyze signals in referenced models. The Simulation Data Inspector relies on signal logging so this example shows how to configure your model to log signals in referenced models.

```
origdir = pwd;
```

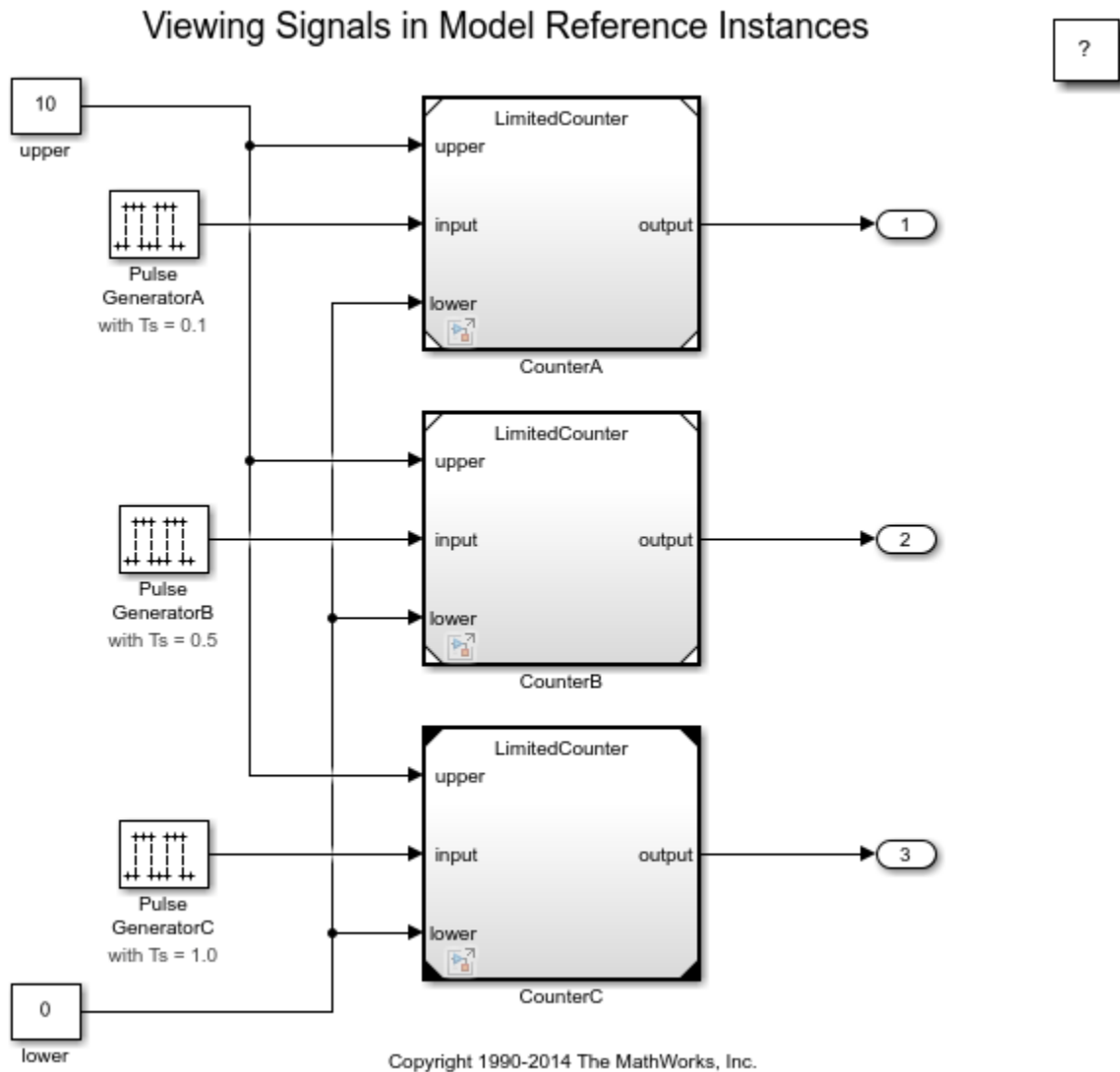

Configure Signals to Log in Referenced Models

The first task in setting up a referenced model to view signals using the Simulation Data Inspector is to configure that model for logging. To do that, edit the referenced model and mark the signals for logging. Four signals are already marked for logging in the referenced model. To mark the `raw_output` signal for logging, select the signal. Then, on the **Simulation** tab, select **Log Signals**.

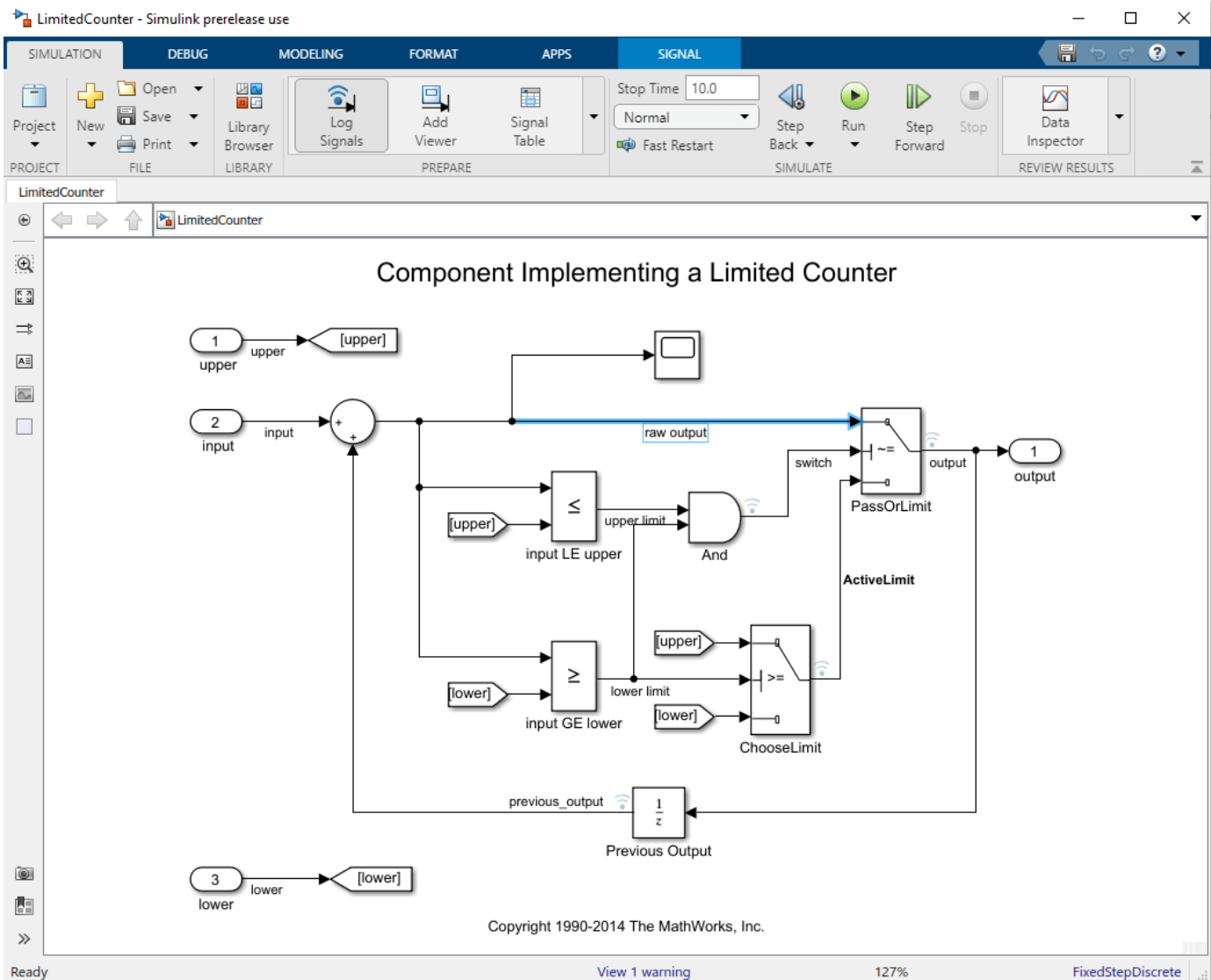

Once the signals to log have been selected in the referenced model, the next step is to select which signals to actually log from the topmost model in the hierarchy. In the top model, on the **Modeling** tab, click **Model Settings**.

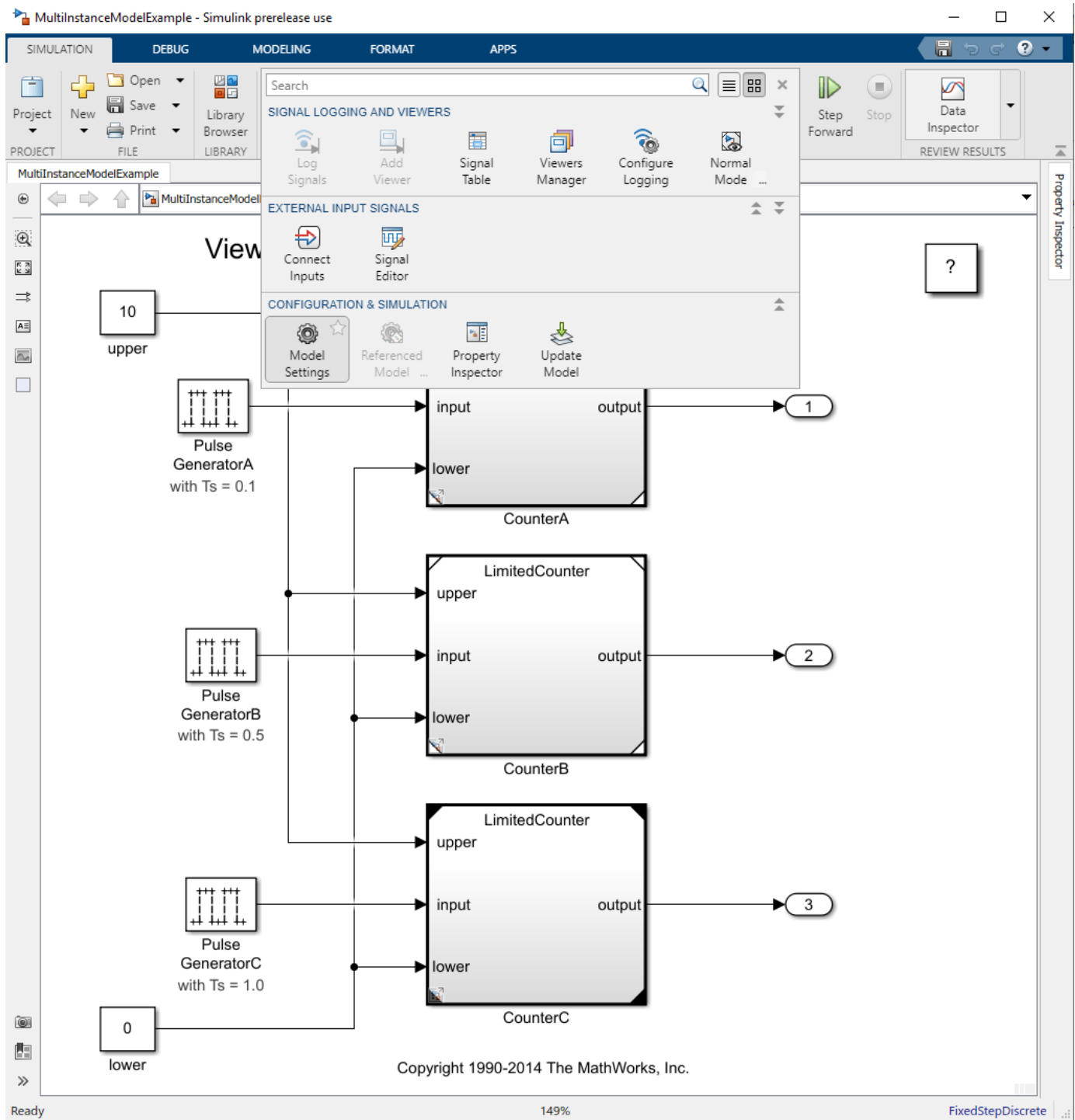

On the **Data Import/Export** pane, click the **Configure Signals to Log...** button to activate the Simulink Signal Logging Selector dialog.

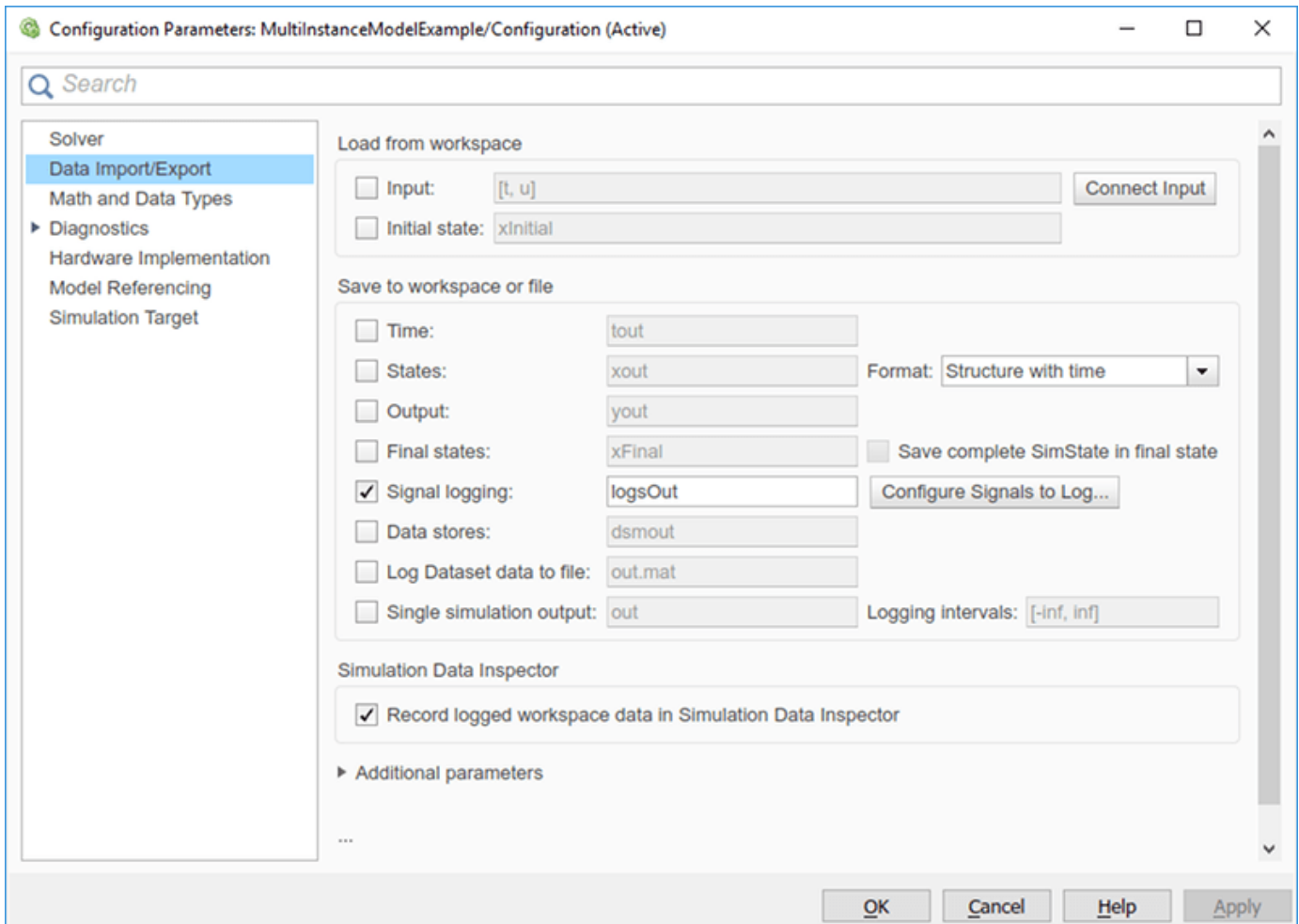

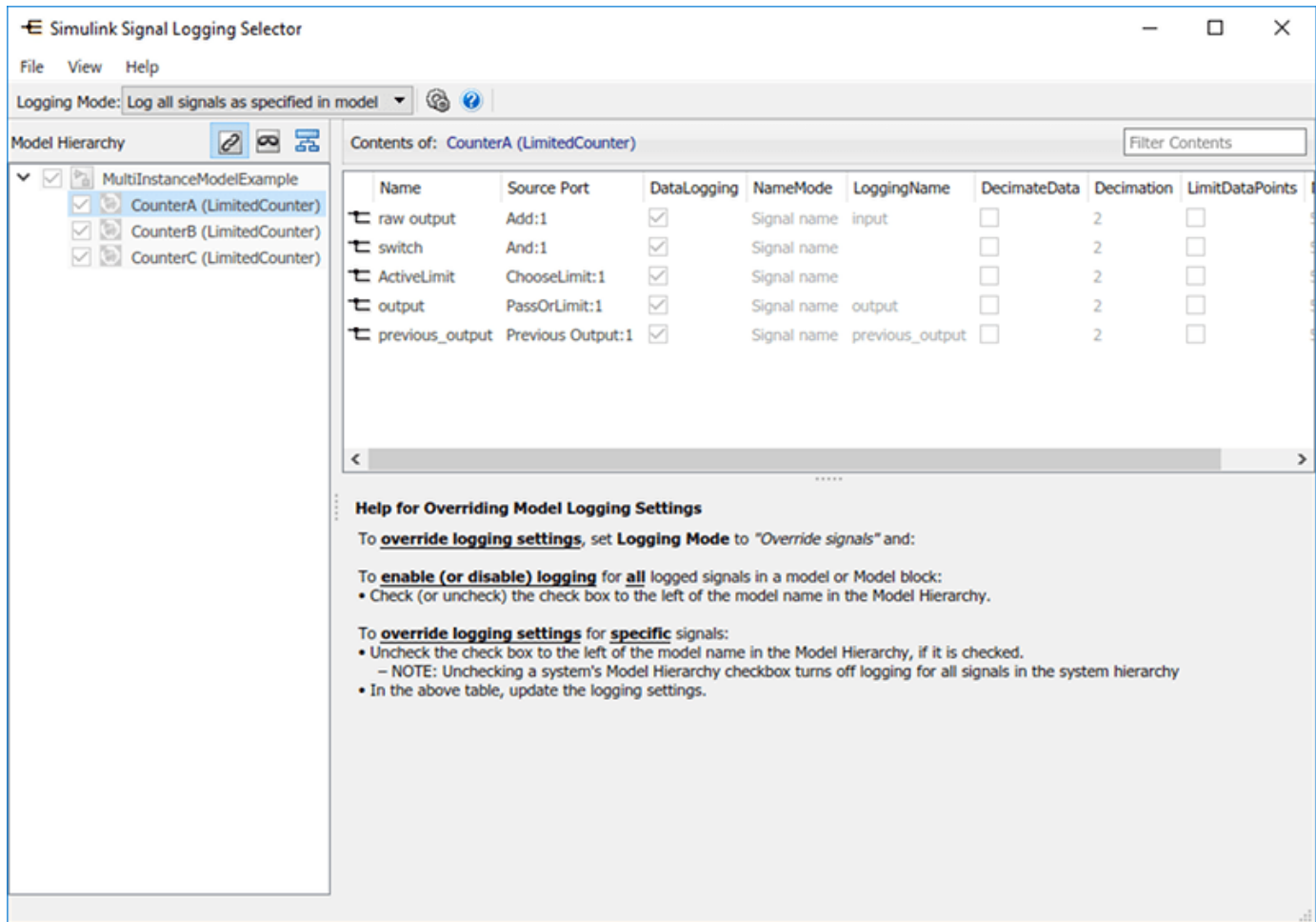

There are two Logging modes that can be used when logging signals in referenced models. The first is **Log all signals as specified in model**, which will honor any logging settings that were made in referenced models. If you need to override any of those settings, such as selecting only a subset of logged signals, then you should use the **Override signals** mode. In this mode, you are given the ability to select a subset of loggable signals and configure their properties, such as decimation and name.

Viewing and Analyzing Logged Signals Using the Simulation Data Inspector

Once logging has been configured for a model hierarchy and all changes to the models have been saved, the model can be simulated. The simulation creates a Dataset object in the base workspace. You can analyze and view the logged data in this object using standard MATLAB® tools. In addition, Simulink® provides the Simulation Data Inspector for viewing and analyzing data created from simulations.

With the Simulation Data Inspector, you can:

- View signal traces for any logged signals
- Visually compare signal values for any logged signals
- Compare signal values collected over multiple simulations

For example, you can use the Simulation Data Inspector to view the `output` signal of two of the instances of the model `LimitedCounter`. In the Simulation Data Inspector, you can see that `CounterA` increases more rapidly than `CounterB`. This behavior is expected because the Pulse Generator driving this model is running at a faster rate.

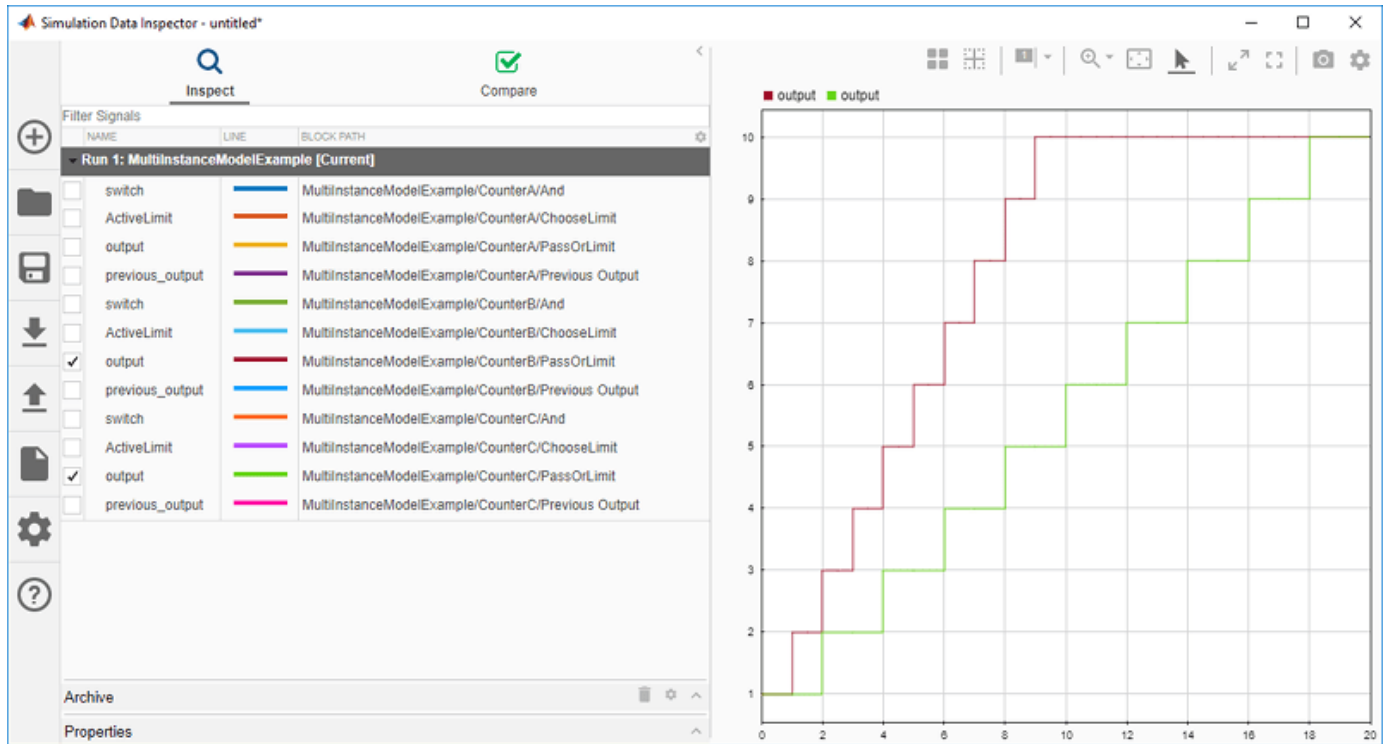

You can configure what to display in the inspect table by clicking the gear icon at the right top of the table.

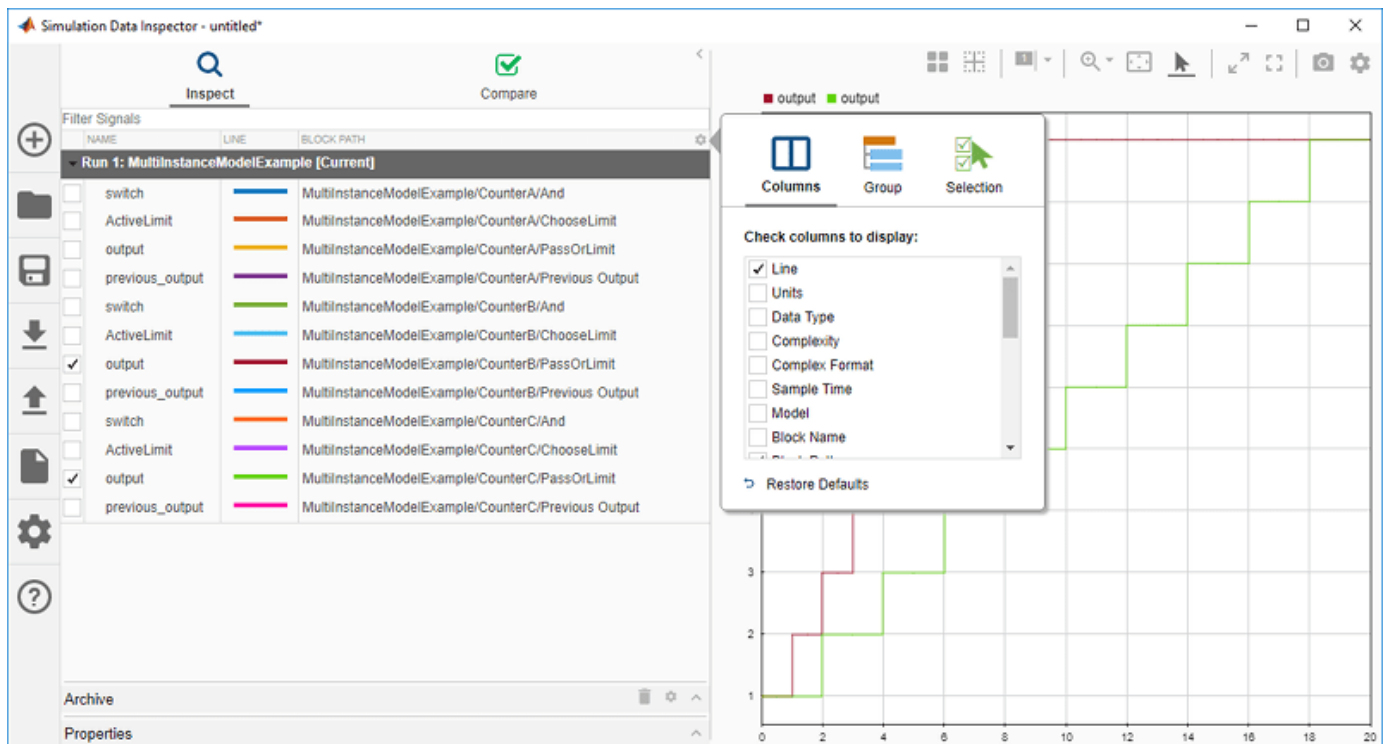

Another useful tool that the Simulation Data Inspector provides is the ability to compare multiple simulation runs. This functionality can help you understand how changes to your model affect results. For example, you can change the value of the upper limit of the counter models to 8 and simulate the model again to see how that affects output values. To change the value, double click on the block `MultiInstanceModelExample/upper` and modify the Value parameter to 8.

Now if you compare the results from the first simulation for the output of the CounterA instance of `LimitedCounter`, you see that the upper limit of this signal has changed from 10 to 8, as expected. Because the tolerances are set to zero, the red octagon next to each signal indicates that the values have changed between runs.

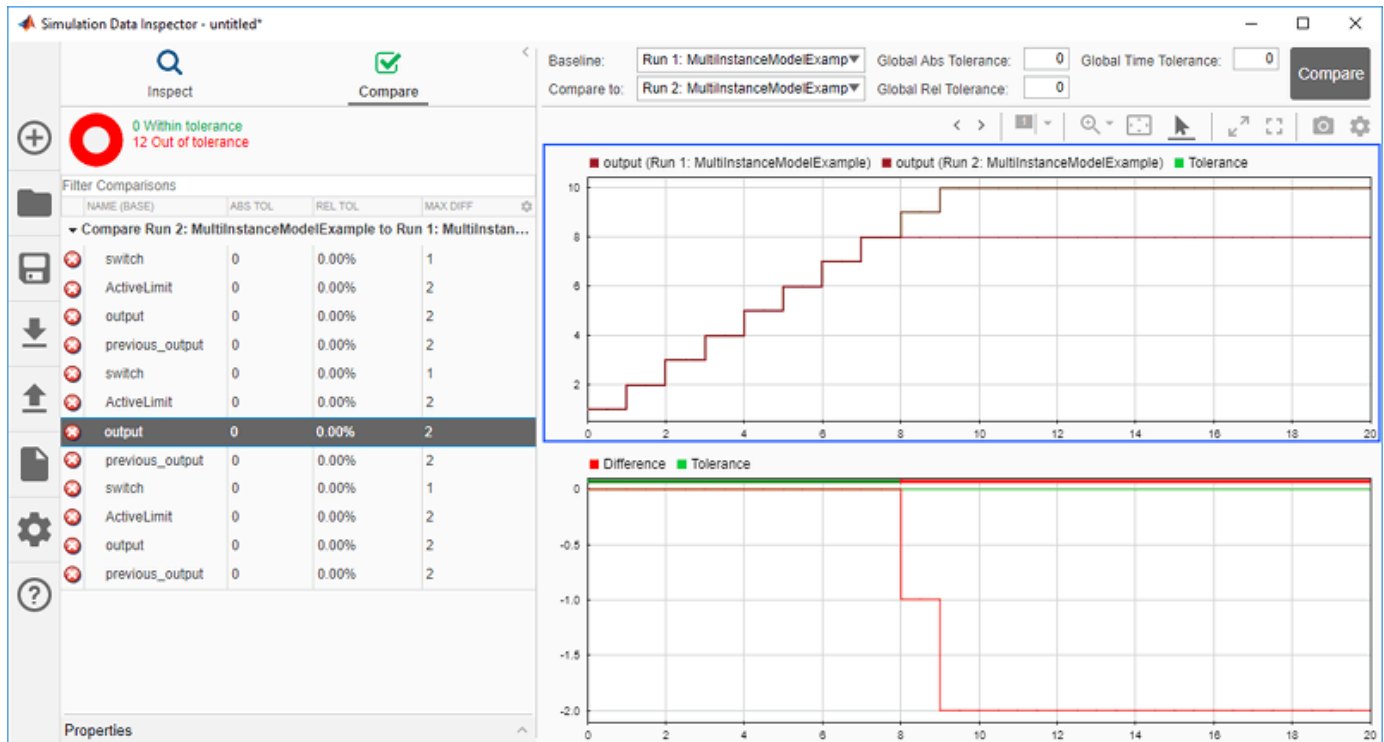

See Also

Tools

[Simulation Data Inspector](#)

Related Examples

- [“View Data in the Simulation Data Inspector”](#)
- [“Configure the Simulation Data Inspector”](#)

Visualize Model Reference Hierarchies

This example shows how to view, explore, and analyze model dependencies using the Dependency Analyzer. It shows how to find referenced models and interact with the dependency graph.

Open Model

Open the example model `sldemo_mdref_depgraph`, which contains multiple referenced models in a model hierarchy.

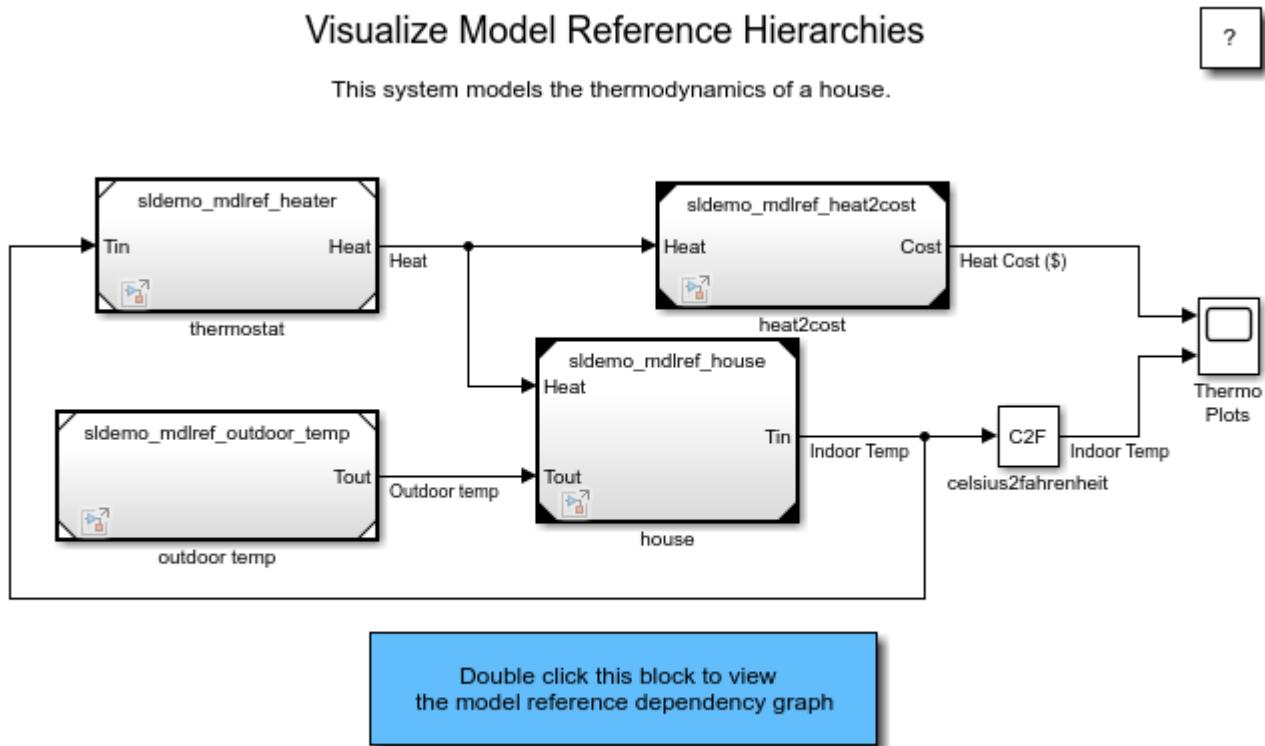

Copyright 1990-2014 The MathWorks, Inc.

Find Referenced Models

Use the `find_mdrefs` function to programmatically find referenced models and Model blocks. For example, enter this command in the MATLAB Command Window:

```
[refMdl, modelBlks] = find_mdrefs('sldemo_mdref_depgraph')
```

`find_mdrefs` returns two cell arrays, `refMdl` and `modelBlks`. `refMdl` contains the names of all models that are directly or indirectly referenced by `sldemo_mdref_depgraph`. By default, the last element in `refMdl` is the name of the input model. `modelBlks` contains block paths for all Model blocks in the top model and all referenced models.

View Model Reference Dependency Graph

To view the dependency graph for the `sldemo_mdref_depgraph` model, perform one of these actions to open the Dependency Analyzer for a model:

- Use the `depview` function.
- In the **Modeling** tab, in the **Design** section, click **Dependency Analyzer**.

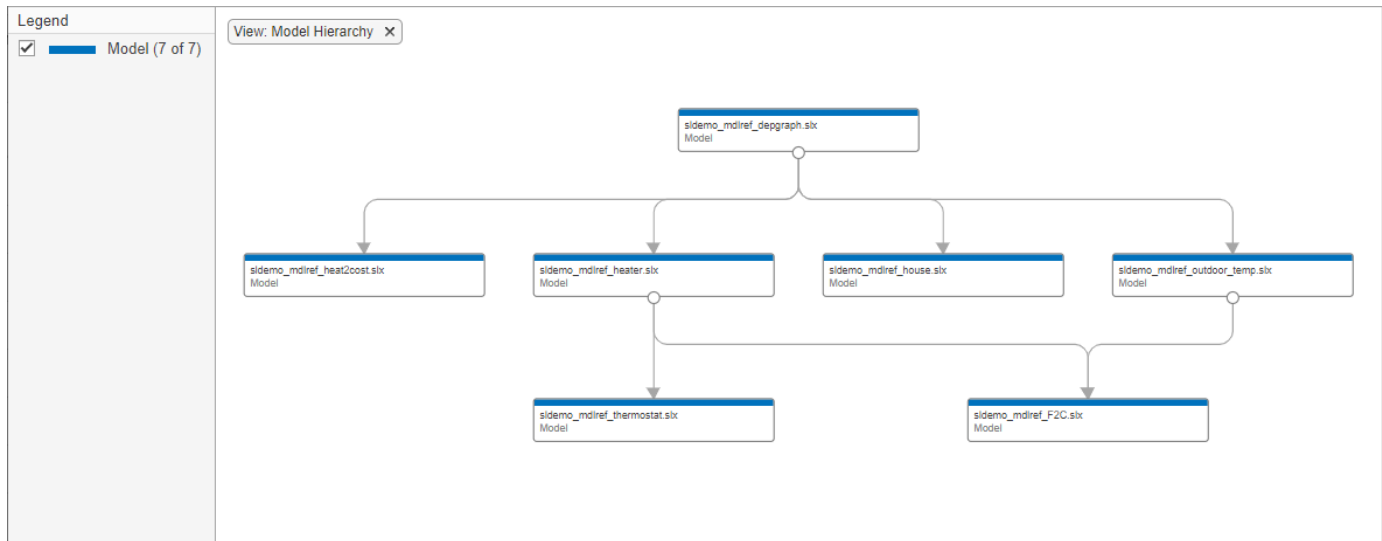

In the dependency graph, the boxes represent Simulink models. The arrows indicate dependencies. For example, the link from `sldemo_mdref_depgraph` to `sldemo_mdref_house` indicates that `sldemo_mdref_depgraph` references `sldemo_mdref_house`. If the model references libraries, subsystems, or protected models, the dependency graph shows them in the hierarchy.

In this view, only one box exists for each model in the graph and at most one arrow exists from one box to another box. The dependency graph does not show if multiple references exist from one model to another model. This view does not show which models are referenced in normal mode and which models are referenced in accelerator mode.

Interact with Dependency Graph

- To select a box, click it.
- To open the model or library associated with a box, double-click it.
- To pan the dependency graph, click and hold the mouse wheel button then drag the mouse.
- To zoom in and out, use the mouse wheel.
- To center the dependency graph and adjust the zoom so that the dependency graph fills the available space, press the space bar.

View Model Instances Dependency Graph

To view the referenced model instances in the dependency graph, perform one of these actions:

- Use `depview('sldemo_mdref_depgraph', 'ModelReferenceInstance', true)`.
- From the Dependency Analyzer, in the **Views** section, select **Model Instances**.

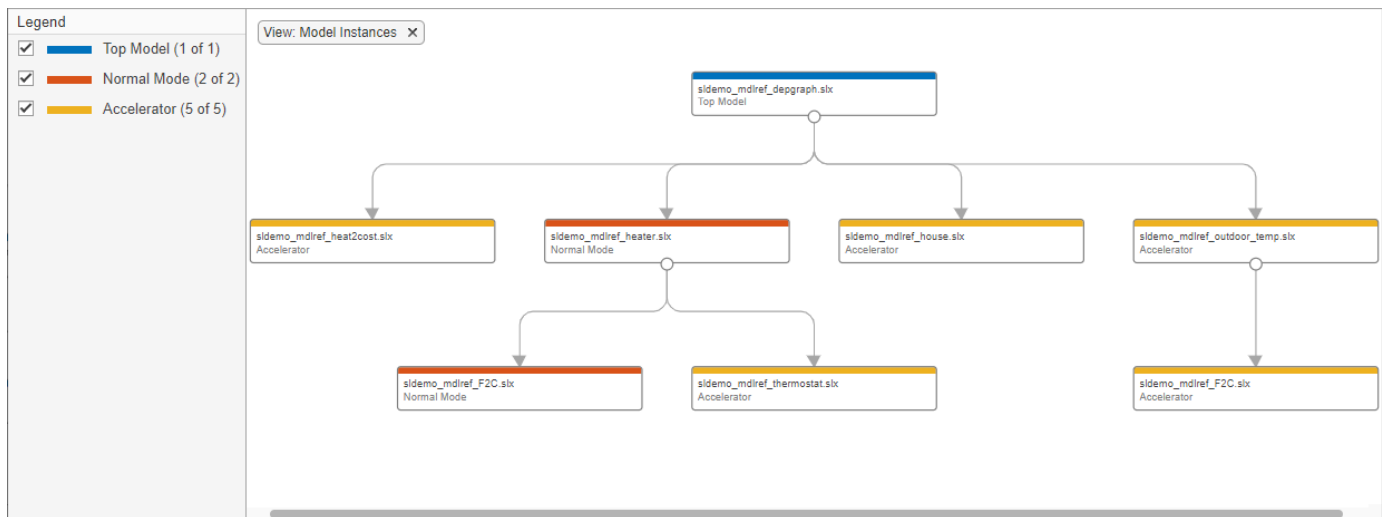

In the instance view, the boxes represent Simulink models. The arrows indicate dependencies. The dependency graph shows when multiple references exist from one model to another model. In the instance view, libraries are never shown.

In this view two boxes are labeled `sldemo_mdiref_F2C` because this model is referenced twice, once by `sldemo_mdiref_outdoor_temp` and once by `sldemo_mdiref_heater`. The top model is colored in blue. The red color denotes a normal mode reference, and the yellow color denotes an accelerator mode reference.

`sldemo_mdiref_heater` makes a normal mode reference to `sldemo_mdiref_F2C` and an accelerator mode reference to `sldemo_mdiref_thermostat`.

Explore Model Instance Views

Currently, the reference `sldemo_mdiref_outdoor_temp` makes to `sldemo_mdiref_F2C` is an accelerator mode reference. Suppose you want to change this reference to be a normal mode reference:

- 1 Select the arrow linking `sldemo_mdiref_outdoor_temp` to `sldemo_mdiref_F2C`.
- 2 In the **Properties** pane on the right, in the dependency table, click `Fahrenheit to Celsius`. Simulink opens the model `sldemo_mdiref_outdoor_temp` and highlights the Model block named `Fahrenheit to Celsius`. This Model block references `sldemo_mdiref_F2C`.
- 3 Select the Model block named `Fahrenheit to Celsius`.
- 4 In the **Model Block** tab, change the **Simulation Mode** to `Normal`.
- 5 To see this change, go to the dependency graph and click **Analyze**.

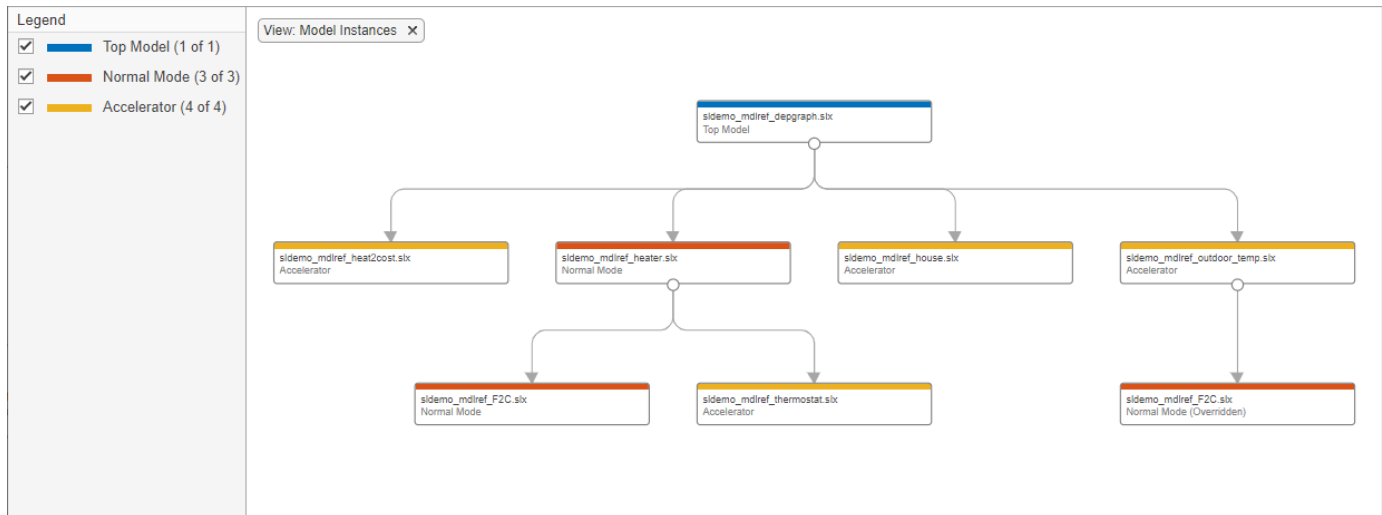

The dependency graph now shows the reference `sldemo_mdref_outdoor_temp` makes to `sldemo_mdref_F2C` as a Normal Mode (Overridden) reference. Note that `sldemo_mdref_F2C` is configured to run in normal mode but its parent, `sldemo_mdref_outdoor_temp`, is configured to run in accelerator mode. Normal mode references from models running in accelerator mode are not supported, so `sldemo_mdref_F2C` will run in accelerator mode during simulation.

To make this model run in normal mode, you must configure all of its ancestors to run in normal mode. To do this:

- 1 Select the arrow linking `sldemo_mdref_depgraph` to `sldemo_mdref_outdoor_temp`.
- 2 In the **Properties** pane on the right, in the dependency table, click `outdoor temp`. Simulink opens the model `sldemo_mdref_depgraph` and highlights the Model block named `outdoor temp`. This Model block references `sldemo_mdref_outdoor_temp`.
- 3 Select the Model block named `outdoor temp`.
- 4 In the **Model Block** tab, change the **Simulation Mode** to Normal. (If there were more accelerator mode ancestors of `sldemo_mdref_F2C`, these would also need to be changed to normal mode references.)
- 5 To see this change, go to the dependency graph and click **Analyze**.

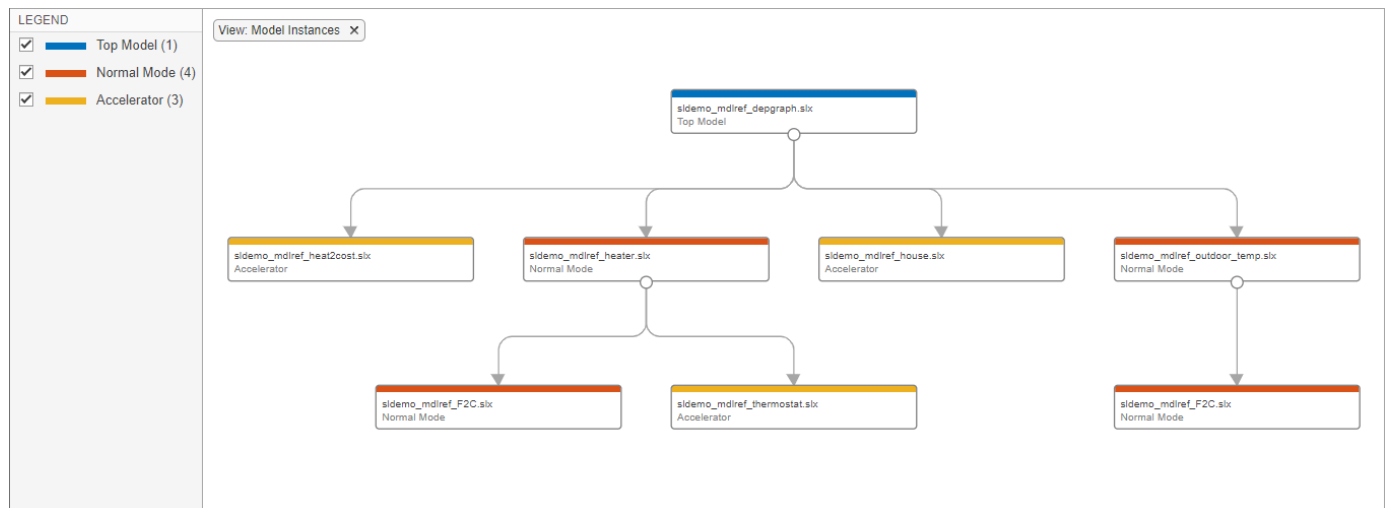

See Also

Related Examples

- “Model Reference Basics”
- “Analyze Model Dependencies”

Introduction to Managing Data with Model Reference

This example shows the basic concepts related to managing data with model reference.

For a more detailed discussion of this topic, see “Detailed Workflow for Managing Data with Model Reference” on page 13-412.

NOTE: This example uses the same model as the more detailed example. As a result, the model uses certain features that this introductory example does not describe.

Open the Example Model

Open the example model `sldemo_mdref_datamngt`.

? Managing Data with Model Reference

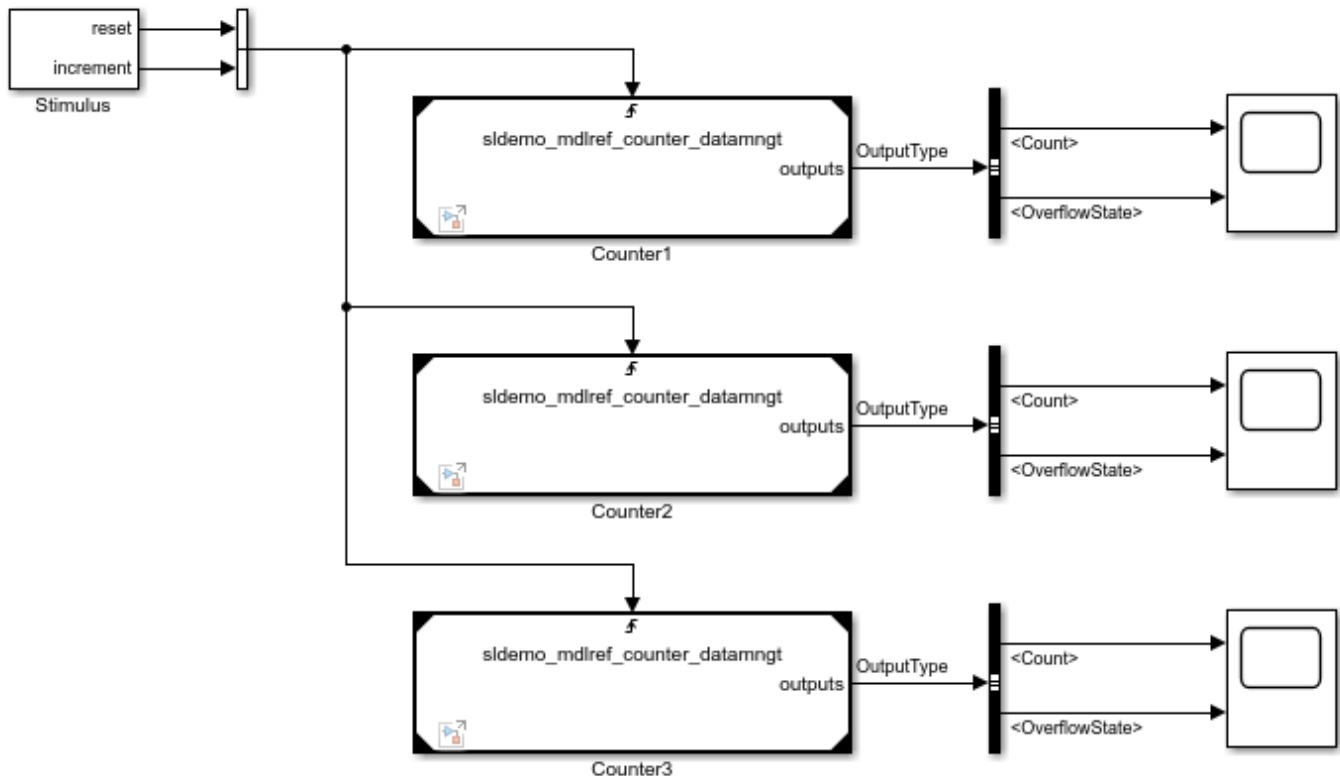

Copyright 1990-2014 The MathWorks, Inc.

Example Content

This example uses a top model `sldemo_mdref_datamngt` that contains three Model blocks: Counter1, Counter2, and Counter3. These blocks reference the same model `sldemo_mdref_counter_datamngt`.

The referenced model implements a limited counter algorithm that:

- Resets the counter if the first trigger input changes
- Increments the counter by a specified amount if the second input changes
- Saturates the counter between the specified upper and lower limits

The referenced model outputs a bus signal that contains:

- **Count:** the value of the counter as an 8-bit integer
- **OverflowState:** an enumerated value that indicates whether the counter is at the upper limit, lower limit, or in range

Example Outline

The sequence of steps in the example is as follows:

1. Prepare the referenced model (sldemo_mdhref_counter_datamngt) to use structures for the signals and parameters in its external interface.
2. Prepare the top model (sldemo_mdhref_datamngt) to call the referenced model.
3. Simulate the top model and examine the results.

Referenced Model: Setting Up Parameters

The referenced model has two model arguments (CounterParams, CounterICs) that parameterize the blocks in the model. Model arguments provide different parameter values to each instance of a referenced model. In this model, the arguments are defined as parameter structures to reduce the number of arguments being passed to the referenced model.

The process for defining the model arguments is as follows:

1. Open the referenced model sldemo_mdhref_counter_datamngt.

- * If reset input changes, set count to initial condition.
- * Otherwise (increment input changed), increment count.
- * In either case, limit the count to the upper/lower limits specified.

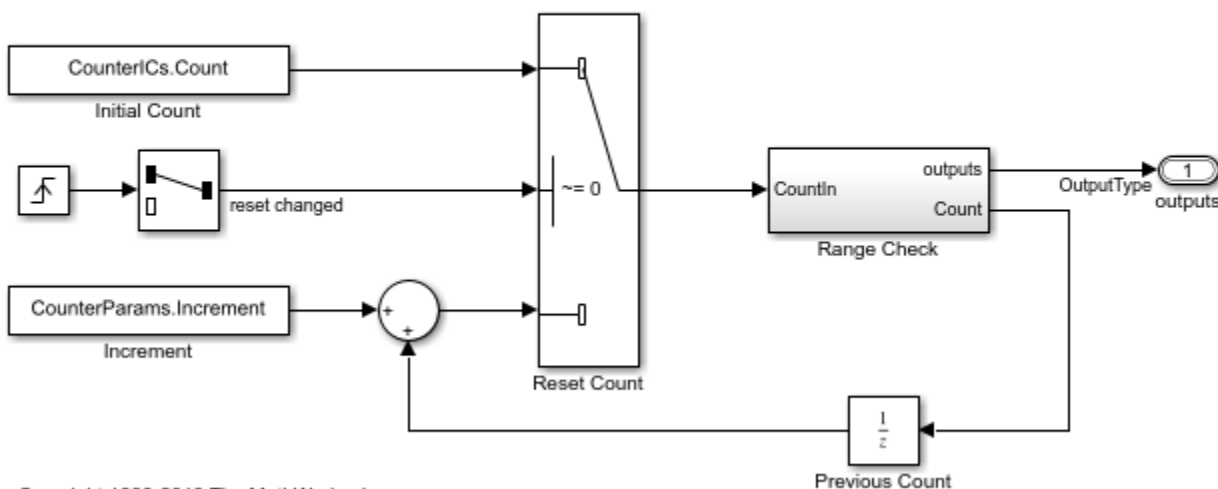

Copyright 1990-2013 The MathWorks, Inc.

2. Define MATLAB structures to parameterize the referenced model.

```
CounterParams.Increment = int8(1);
CounterParams.LowerLimit = int8(-10);
CounterParams.UpperLimit = int8(10);

CounterICs.Count = int8(0);
CounterICs.OverflowState = SLDemoRangeCheck.InRange;
```

NOTE: This example uses an 8-bit integer for the counter, so the numeric fields also use 8-bit integers.

3. Use the MATLAB structures as model arguments.

Model arguments are defined as variables in the model workspace of a referenced model. You can initialize the model workspace from a number of different data sources. This example uses a MATLAB script (`sldemo_mdref_counter_datamngt_wsdata`) to create the parameter structures for the model arguments. Using a MATLAB script makes it easy to create and modify the parameter structure outside the model. It also facilitates incremental changes, version control, and data differencing.

Set the data source in the dialog of the model workspace.

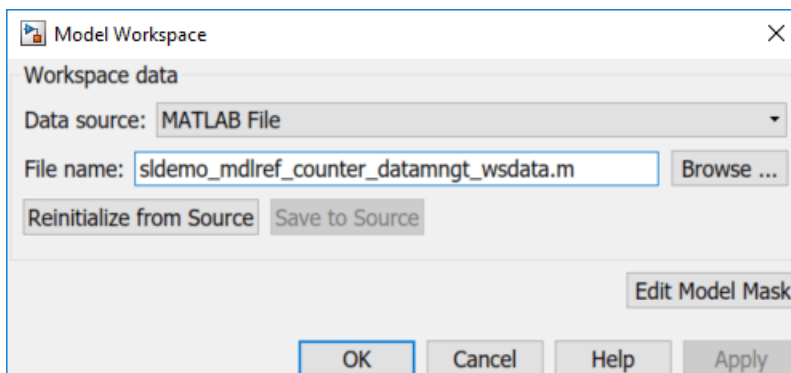

You can use the Model Explorer to view and edit the contents of the model workspace.

Select the Argument checkbox to configure variables as model arguments.

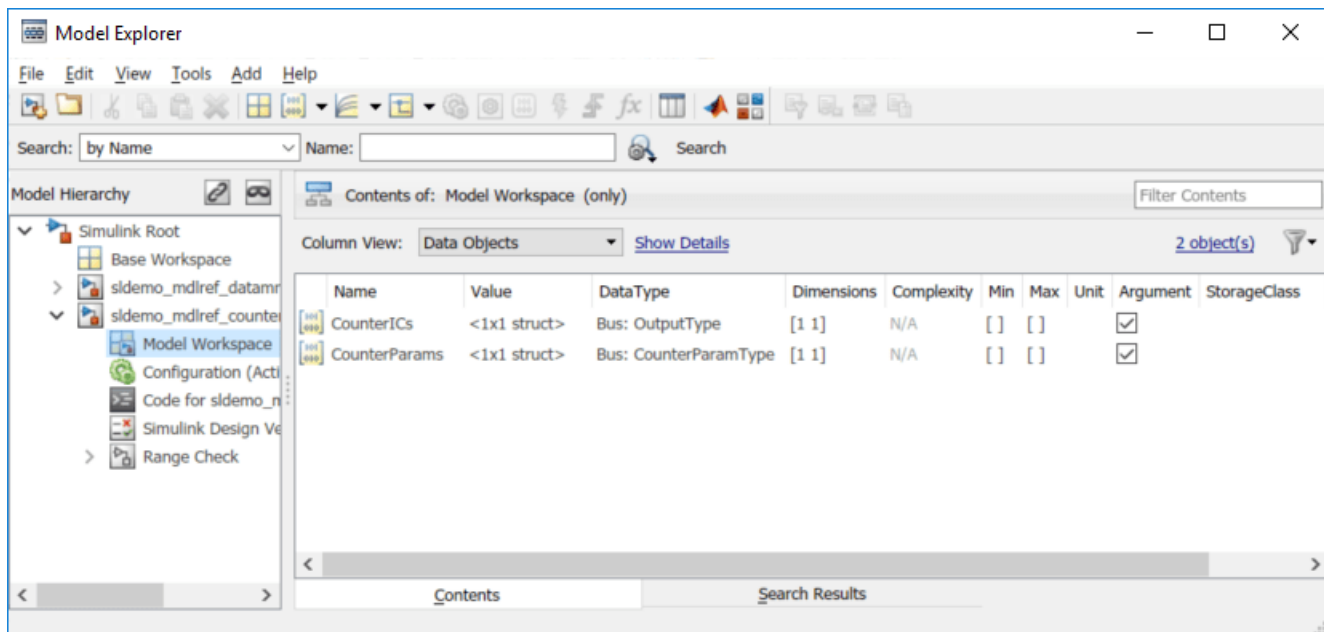

Referenced Model: Defining the Shape of the Output Bus Signal

The referenced model produces two results and packages them into a bus signal:

- **Count:** the value of the counter as an 8-bit integer
- **OverflowState:** an enumerated value that indicates whether the counter is at the upper limit, lower limit, or in range

To define the bus type for the root output of the referenced model:

1. Use the Bus Editor to define the bus object (OutputType).

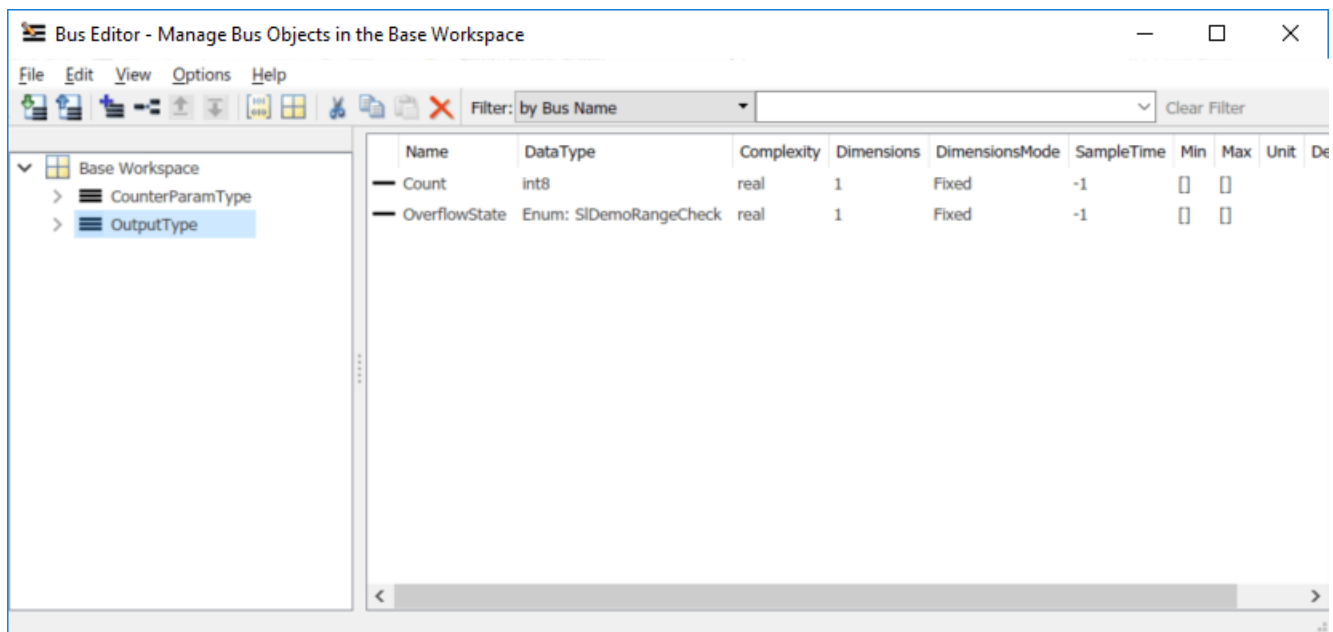

Alternatively, you can create the bus object at the MATLAB command line:

```
OutputType = Simulink.Bus;
OutputType.Elements = Simulink.BusElement;
OutputType.Elements(1).Name = 'Count';
OutputType.Elements(1).DataType = 'int8';
OutputType.Elements(2) = Simulink.BusElement;
OutputType.Elements(2).Name = 'OverflowState';
OutputType.Elements(2).DataType = 'Enum: SLDemoRangeCheck';
```

2. Configure the root output of the referenced model to output a nonvirtual bus signal based on this bus object (OutputType).

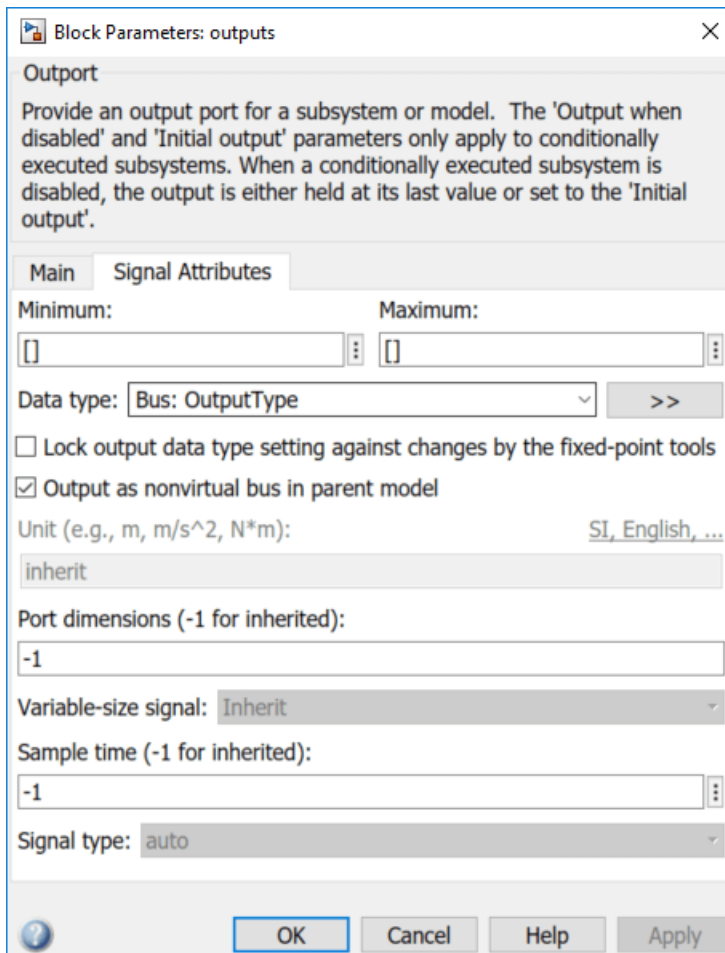

Referenced Model: Setting Initial Value for Bus Output

In general, the initial values for bus signals and states can be specified as '0', in which case all of the elements of the bus will be initialized to zero (or the relevant ground value). However, in certain cases, it is desirable to specify nonzero initial values for bus signals and states. In this example, the initial condition of the counter is tunable, so the initial value of output signal must be set consistently.

To specify the initial value of the output of the referenced model:

1. Create a parameter structure that is compatible with the bus signal that you want to initialize. One of the model arguments (CounterICs) is a parameter structure that matches the shape of the output signal. This structure was defined as follows:

```
CounterICs.Count          = int8(0);
CounterICs.OverflowState = SLDemoRangeCheck.InRange;
```

2. Open the dialog box for the root outputport and enter the name of the structure (CounterICs) into the **Initial output** field.

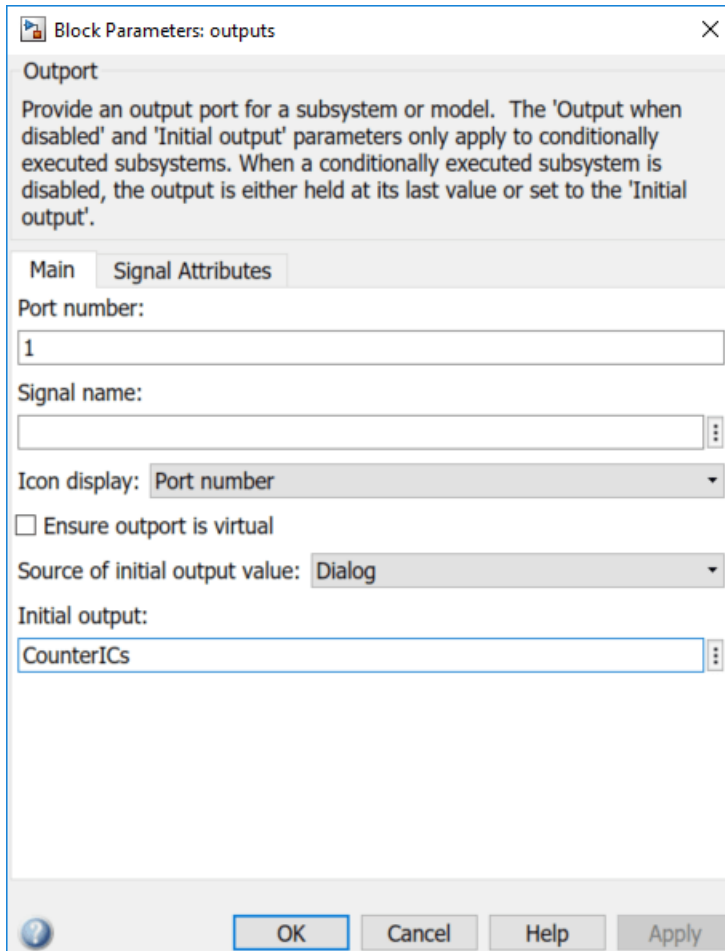

NOTE: In general, when initializing a bus signal or state, the parameter structure does not need to match the bus type exactly, but its fields must be a subset of the elements in the bus object and the attributes of these fields must match the elements in the bus object.

Referenced Model: Masking Referenced Model

It is often useful to mask the referenced model to customize the user interface. You can create a mask on a model and then reference it from a Model block. To mask a model, click **Create Model Mask** in the model workspace section of Model Explorer for the model.

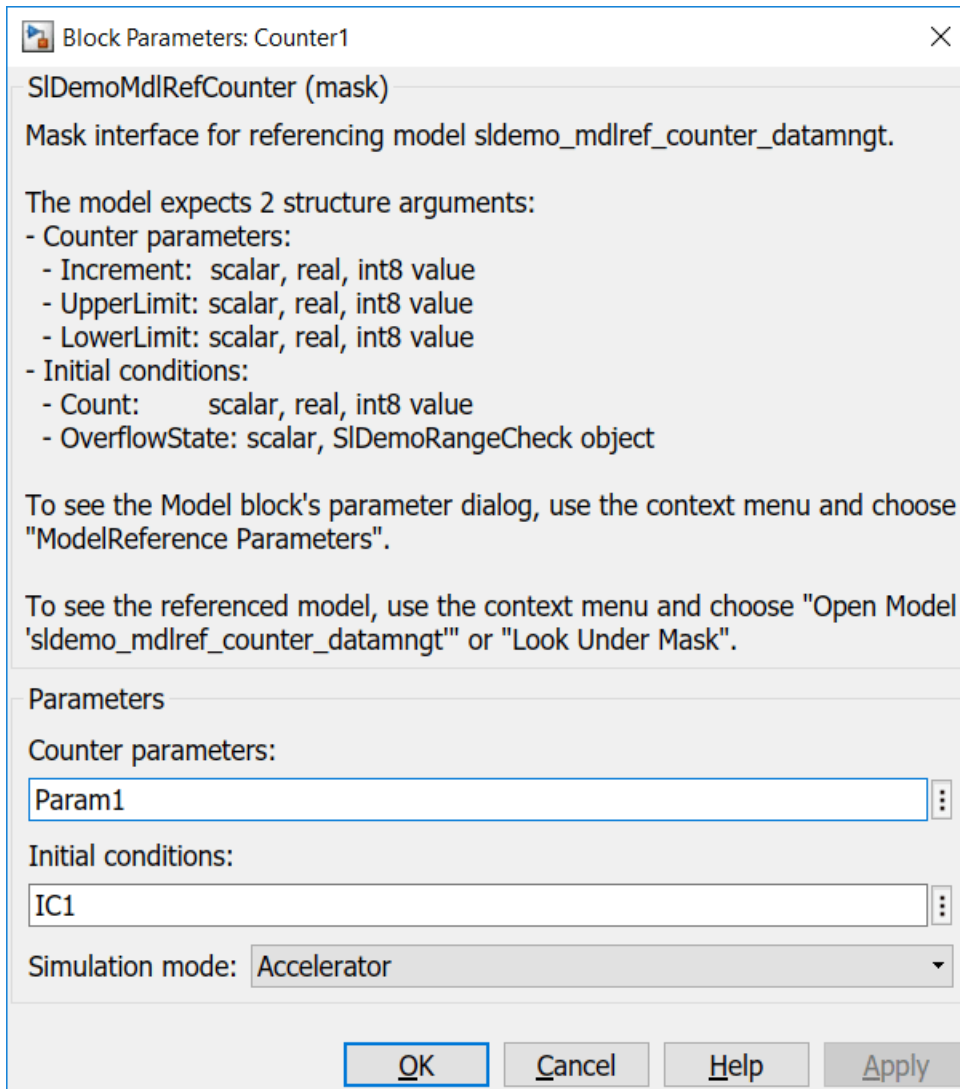

Top Model: Parameterizing Model Blocks

The referenced model is configured to accept a structure for its model argument. This example calls each instance of the referenced model with different parameter values.

1. Open the top model sldemo_md1ref_datamngt.

? Managing Data with Model Reference

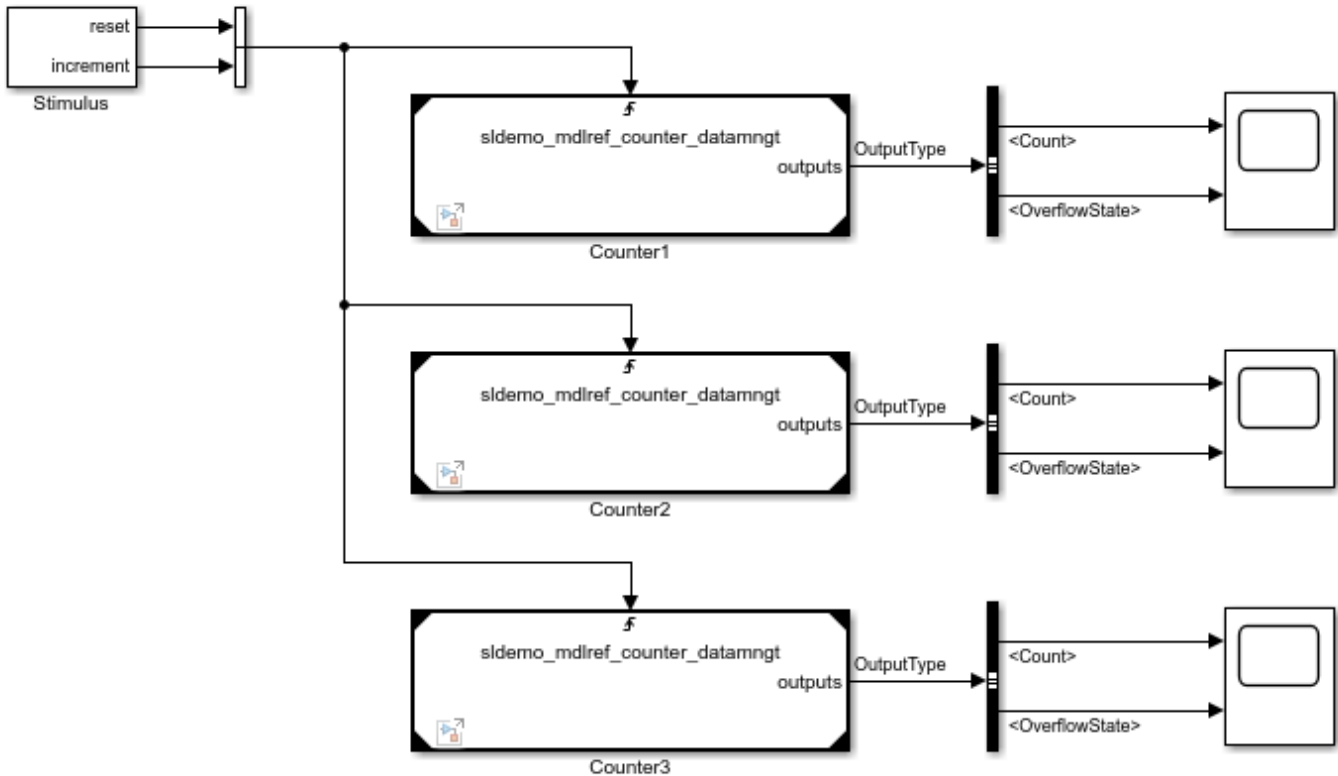

Copyright 1990-2014 The MathWorks, Inc.

2. Create parameter structures with the same "shape" as the model arguments defined in the referenced model.

```
clear Param1 Param2 IC1 IC2;
Param1.Increment = int8(1);
Param1.LowerLimit = int8(-20);
Param1.UpperLimit = int8(20);

Param2 = Param1;
Param2.Increment = int8(2);

IC1.Count = int8(0);
IC1.OverflowState = SLDemoRangeCheck.InRange;

IC2 = IC1;
IC2.Count = int8(-10);
```

3. Set the mask parameters on the masked Model blocks to use these parameters.

For example, the parameters of the first Model block 'sldemo_mdref_datamngt/Counter1' are set as:

- **Param1** for the **Counter parameters**
- **IC1** for the **Initial conditions**

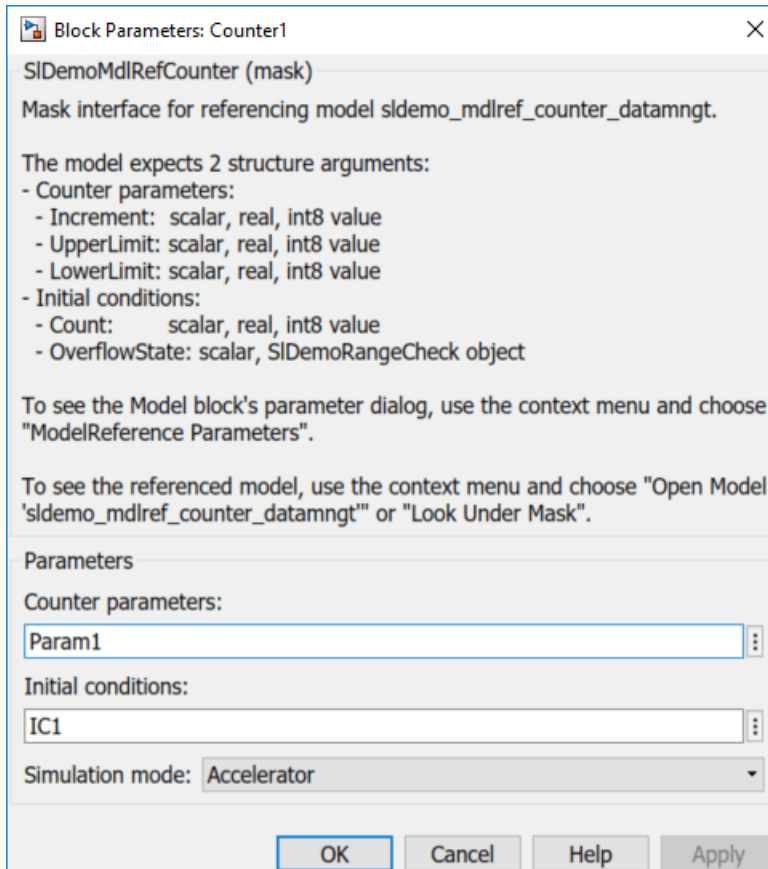

Top Model: Scheduling Calls to the Referenced Model

As mentioned earlier, the referenced model implements a limited counter algorithm with two trigger inputs. The algorithm detects "rising edges" in the trigger inputs and reacts as follows:

- Resets the counter if the first trigger input changes.
- Increments the counter by a specified amount if the second input changes.

In this example, you drive all three instances of the counter algorithm with the same trigger inputs, generated by the Stimulus subsystem. The period and sample time of the trigger inputs are defined by the values entered for the mask parameters of the Stimulus subsystem:

- Reset counter every 4 seconds.
- Increment counter 5 times per second (period = 0.2 second).
- Sample time is 0.1 second.

NOTE: Reset and increment periods must be at least 2 times the sample time.

Simulating the Top Model

1. Save or close the referenced model.

You need to save the referenced model before it can be used by the top model. Alternatively, you can close the referenced model and use the original version of the model provided with this example.

2. Simulate the top model by selecting **Simulation > Run**.

NOTE: Simulating the top model automatically generates a simulation target for the referenced model.

3. Review the simulation results as displayed by the Scope blocks.

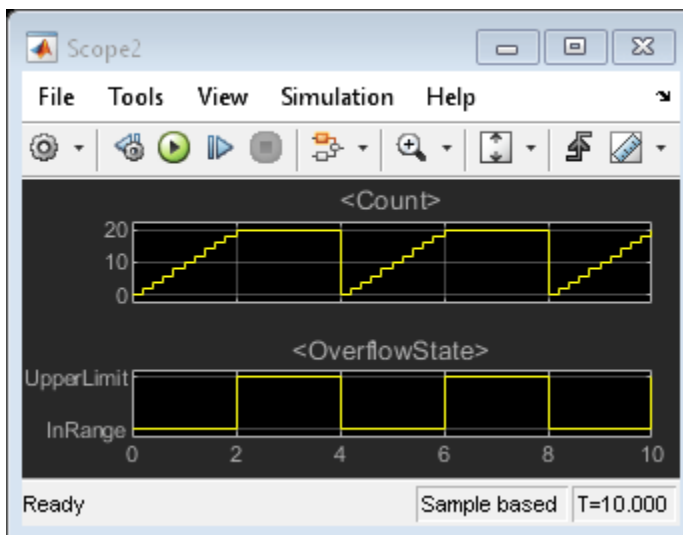
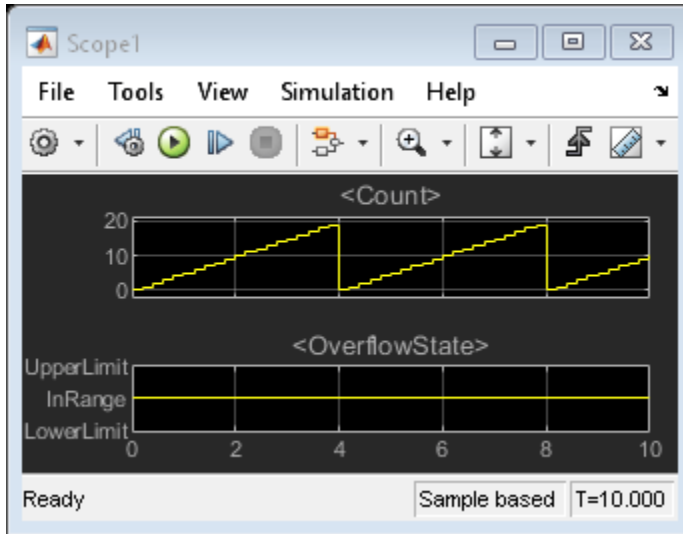

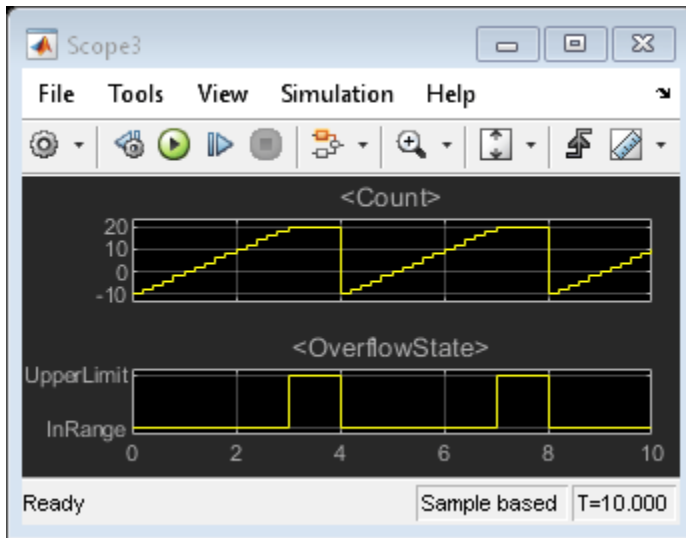

See Also

Model | Variant Subsystem, Variant Model

Related Examples

- "Model References"

Detailed Workflow for Managing Data with Model Reference

This example shows a number of tools and techniques that make up a workflow for managing data with model reference.

For a basic introduction to this topic, see: “Introduction to Managing Data with Model Reference” on page 13-401.

Example Requirements

During this example, Simulink® and Simulink® Coder™ generate code in the code generation folder created in the current directory. If you do not want to (or if you cannot) generate files in this directory, you should change your working directory. Simulink Coder is required to generate model reference binaries to be deployed in standalone applications.

If you plan to alter the example models:

1. Preserve the example in its original state by copying the following files from your MATLAB® installation directory, without changing their names, to a different directory:

```
toolbox/simulink/simdemos/simfeatures/modelreference/sldemo_mdref_datamngt.slx
toolbox/simulink/simdemos/simfeatures/modelreference/sldemo_mdref_datamngt_wsdata.m
toolbox/simulink/simdemos/simfeatures/modelreference/sldemo_mdref_counter_datamngt.slx
toolbox/simulink/simdemos/simfeatures/modelreference/sldemo_mdref_counter_datamngt_types.m
toolbox/simulink/simdemos/simfeatures/modelreference/sldemo_mdref_counter_datamngt_wsdata.m
```

2. Change your current directory to the directory to which you copied the files.

3. Continue with the example.

Open the Example Model

```
open_system('sldemo_mdref_datamngt')
```

Managing Data with Model Reference

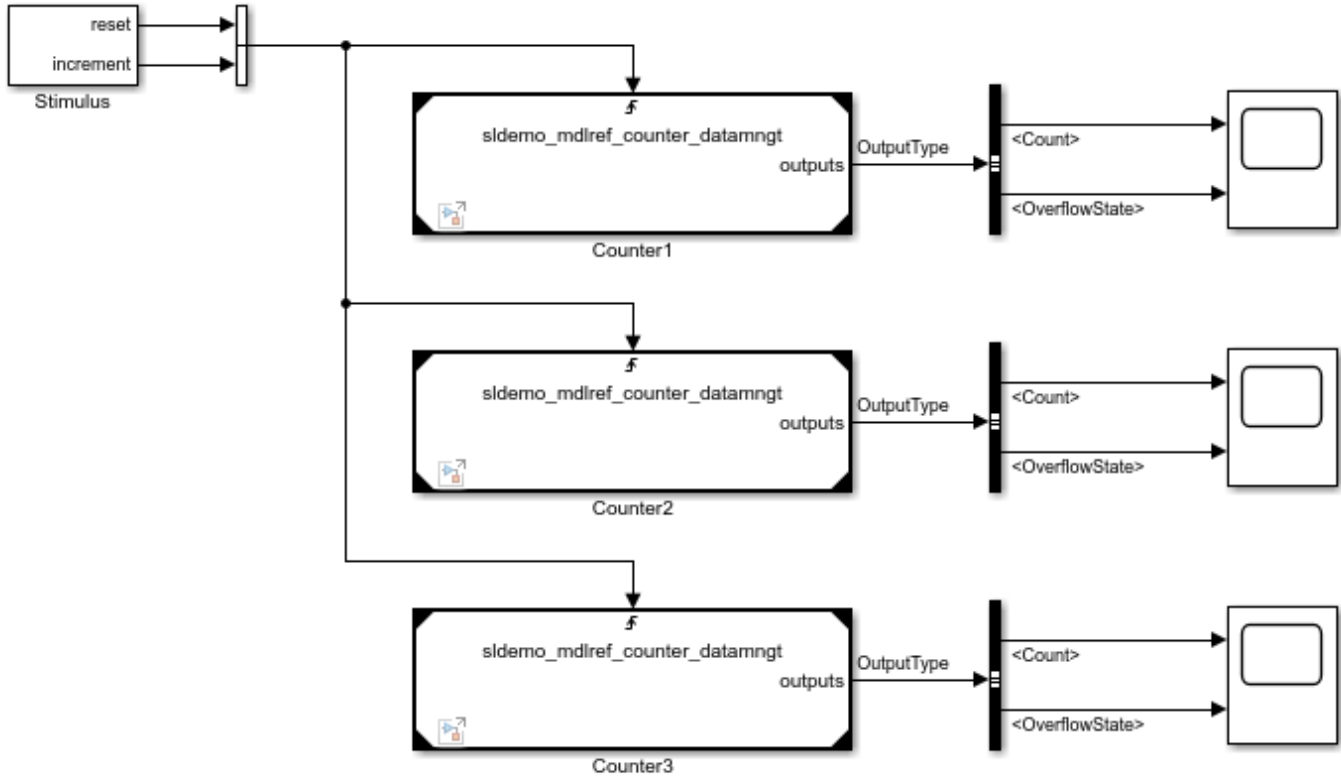

Copyright 1990-2014 The MathWorks, Inc.

Example Content

This example uses a top model (`sldemo_mdhref_datamngt`) that contains three Model blocks: Counter1, Counter2, and Counter3. These blocks reference the same model (`sldemo_mdhref_counter_datamngt`).

The referenced model implements a limited counter algorithm that:

- Resets the counter if the first trigger input changes
- Increments the counter by a specified amount if the second input changes
- Saturates the counter between the specified upper and lower limits

The referenced model outputs a bus signal that contains:

- **Count:** the value of the counter as an 8-bit integer
- **OverflowState:** an enumerated value that indicates whether the counter is at the upper limit, lower limit, or in range

This model is configured to show a number of Simulink features working together:

- **Tunable parameter structures:** Collect variables into a MATLAB structure that parameterizes the model. In this example, the model arguments of the referenced model are defined as parameter structures.
- **Model arguments:** Pass different parameter values to each model reference instance.
- **Bus objects:** Define the "shape" of structures for signals and parameters used in the model reference interface. Define type name for structure parameters and signals in generated code.
- **Simulink.Bus.createMATLABStruct:** Static method for creating a MATLAB structure that matches the shape of the bus object.
- **Bus initialization:** Uses a parameter structure to initialize bus signals and states.
- **Masked Model block:** Creates a customized interface for a model reference block.
- **Triggered model reference:** Explicit control over scheduling of components.

This example also uses other features that are useful for managing data in Simulink:

- **Simulink.saveVars:** Serialize workspace variables to a MATLAB script. Supports incremental modification, data differencing, and version control.
- **Simulink.findVars:** Discover how workspace variables are used by a model.

Example Outline

The sequence of steps in the example is as follows:

1. Prepare the referenced model (`sldemo_mdref_counter_datamngt`) to use structures for the signals and parameters in its external interface.
2. Prepare the top model (`sldemo_mdref_datamngt`) to call the referenced model.
3. Simulate the top model and examine the results.
4. Generate code to create a standalone executable for the top model.

Referenced Model: Setting Up Parameters

The referenced model has two model arguments (`CounterParams`, `CounterICs`) that parameterize the blocks in the model. Model arguments provide different parameter values to each instance of a referenced model. In this model, the arguments are defined as parameter structures to reduce the number of arguments being passed to the referenced model.

The process for defining the model arguments is as follows:

1. Open the referenced model (`sldemo_mdref_counter_datamngt`).

- * If reset input changes, set count to initial condition.
- * Otherwise (increment input changed), increment count.
- * In either case, limit the count to the upper/lower limits specified.

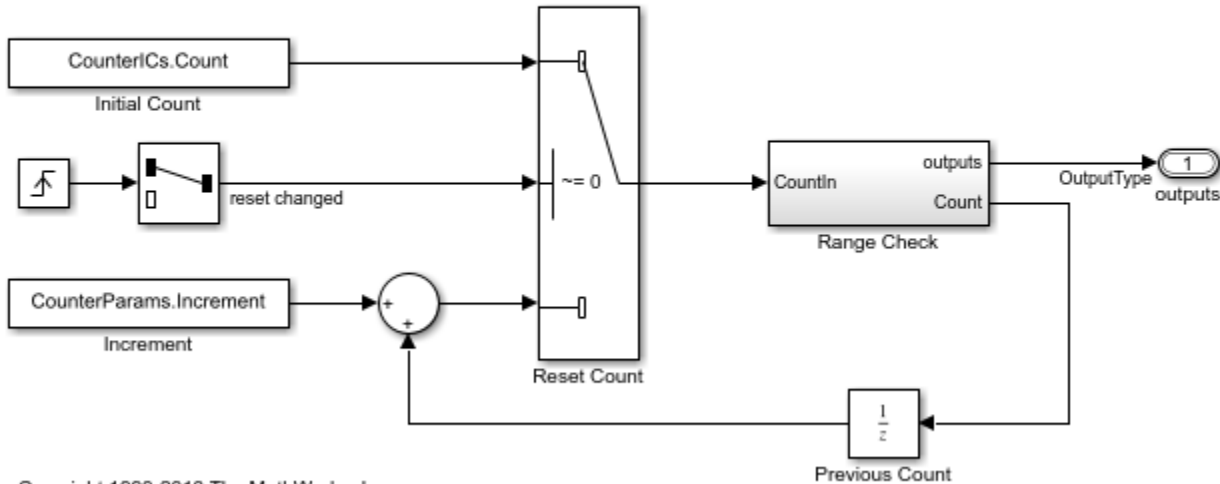

Copyright 1990-2013 The MathWorks, Inc.

2. Define MATLAB structures to parameterize the referenced model.

```
CounterParams.Increment = int8(1);
CounterParams.LowerLimit = int8(-10);
CounterParams.UpperLimit = int8(10);

CounterICs.Count = int8(0);
CounterICs.OverflowState = SLDemoRangeCheck.InRange;
```

NOTE: This example uses an 8-bit integer for the counter, so the numeric fields also use 8-bit integers.

3. Use the MATLAB structures as model arguments.

Model arguments are defined as variables in the model workspace of a referenced model. You can initialize the model workspace from a number of different data sources. This example uses a MATLAB script (`sldemo_mdlref_counter_datamngt_wsdata`) to create the parameter structures for the model arguments. Using a MATLAB script makes it easy to create and modify the parameter structure outside the model. It also facilitates incremental changes, version control, and data differencing.

Set the data source in the dialog of the model workspace.

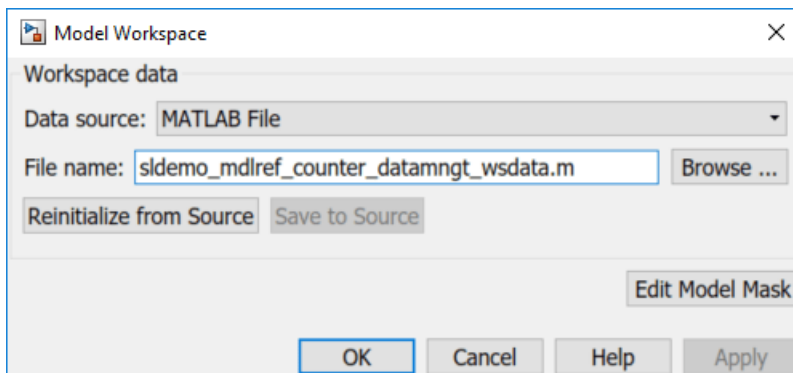

Alternatively, you can set the data source from the MATLAB command line:

```
hWS = get_param('sldemo_mdref_counter_datamngt', 'ModelWorkspace');
hWS.DataSource = 'MATLAB File';
hWS.FileName = 'sldemo_mdref_counter_datamngt_wsdata.m';
hWS.reload;
```

You can use the Model Explorer to view and edit the contents of the model workspace.

Select the Argument checkbox to configure variables as model arguments.

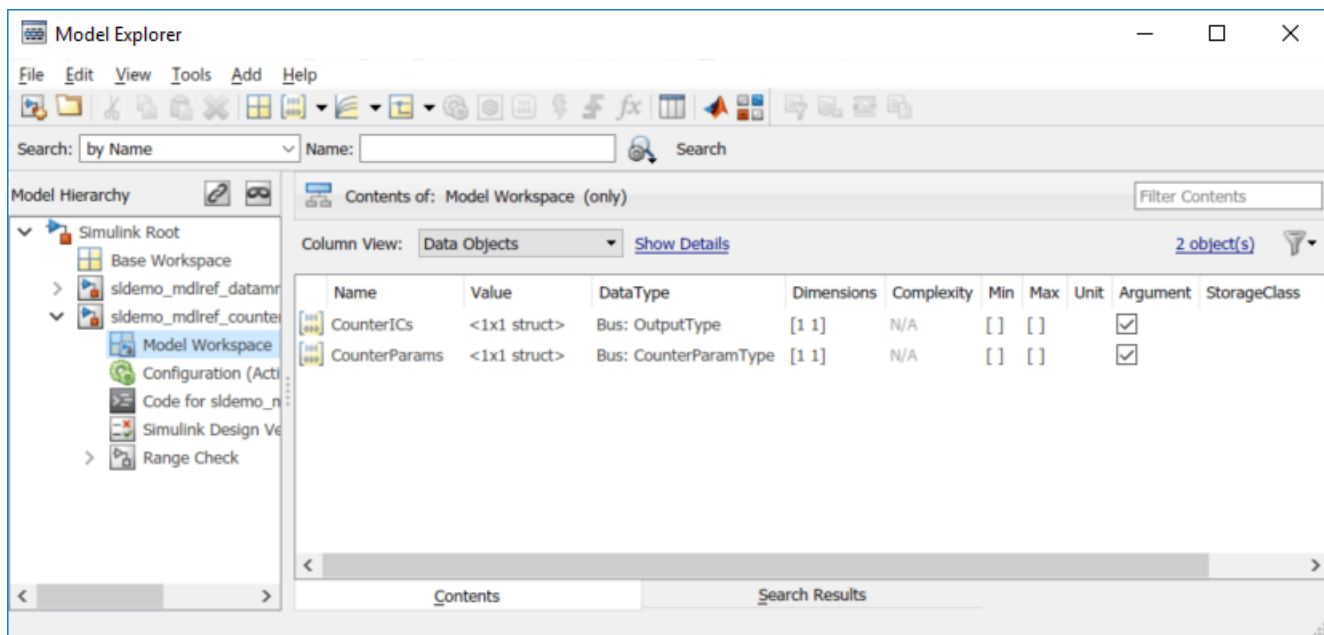

Alternatively, you can set the list of model arguments from the MATLAB command line:

```
set_param('sldemo_mdref_counter_datamngt', ...
    'ParameterArgumentNames', 'CounterParams,CounterICs');
```

4. Explore how the referenced model uses the model arguments.

A number of blocks in the referenced model use the model arguments:

- A Constant block specifies the increment amount (CounterParams.Increment).
- Various blocks inside the "Range Check" subsystem use the values of the lower and upper limits (CounterParams.LowerLimit and CounterParams.UpperLimit).
- Various blocks use the initial condition of the counter (CounterICs.Count).
- The root Output block uses the initial condition structure (CounterICs) to initialize the system output prior to execution.

You can use **Simulink.findVars** to discover the blocks that use the model argument.

```
paramInfo = Simulink.findVars('sldemo_mdhref_counter_datamngt', ...
                             'Name', 'CounterParams');
icInfo     = Simulink.findVars('sldemo_mdhref_counter_datamngt', ...
                             'SearchMethod', 'cached', ...
                             'Name',       'CounterICs');
```

```
paramBlks = paramInfo.UsedByBlocks
icBlks     = icInfo.UsedByBlocks
```

```
paramBlks =
```

```
3x1 cell array
```

```
{'sldemo_mdhref_counter_datamngt/Increment'          }
{'sldemo_mdhref_counter_datamngt/Range Check/Detect Overflow'}
{'sldemo_mdhref_counter_datamngt/Range Check/Saturate Count' }
```

```
icBlks =
```

```
3x1 cell array
```

```
{'sldemo_mdhref_counter_datamngt/Initial Count' }
{'sldemo_mdhref_counter_datamngt/Previous Count'}
{'sldemo_mdhref_counter_datamngt/outputs'      }
```

NOTE: Once you have compiled the model, you can use `Simulink.findVars` to retrieve the **'cached'** variable usage information.

Referenced Model: Defining the Shape of the Output Bus Signal

The referenced model produces two results and packages them into a bus signal:

- **Count:** the value of the counter as an 8-bit integer
- **OverflowState:** an enumerated value that indicates whether the counter is at the upper limit, lower limit, or in range

To define the bus type for the root output of the referenced model:

1. Use the Bus Editor to define the bus object (OutputType).

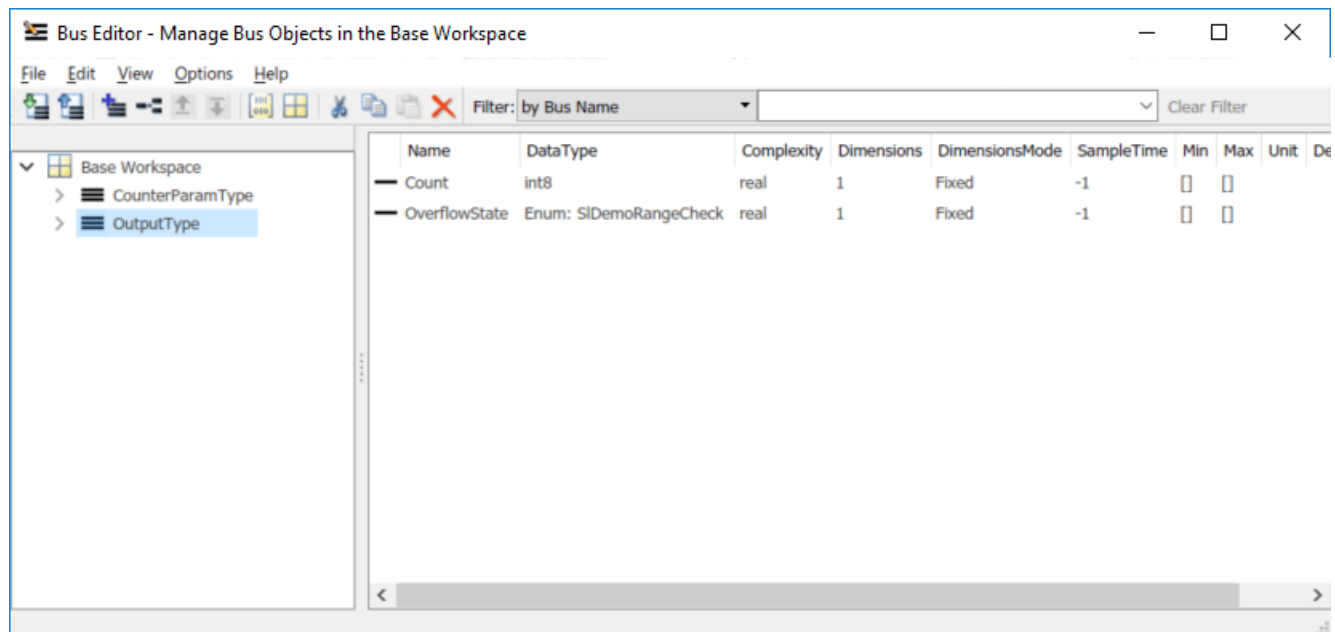

Alternatively, you can create the bus object at the MATLAB command line:

```
OutputType = Simulink.Bus;
OutputType.Elements = Simulink.BusElement;
OutputType.Elements(1).Name = 'Count';
OutputType.Elements(1).DataType = 'int8';
OutputType.Elements(2) = Simulink.BusElement;
OutputType.Elements(2).Name = 'OverflowState';
OutputType.Elements(2).DataType = 'Enum: SLDemoRangeCheck';
```

2. Configure the root output of the referenced model to output a nonvirtual bus signal based on this bus object (OutputType).

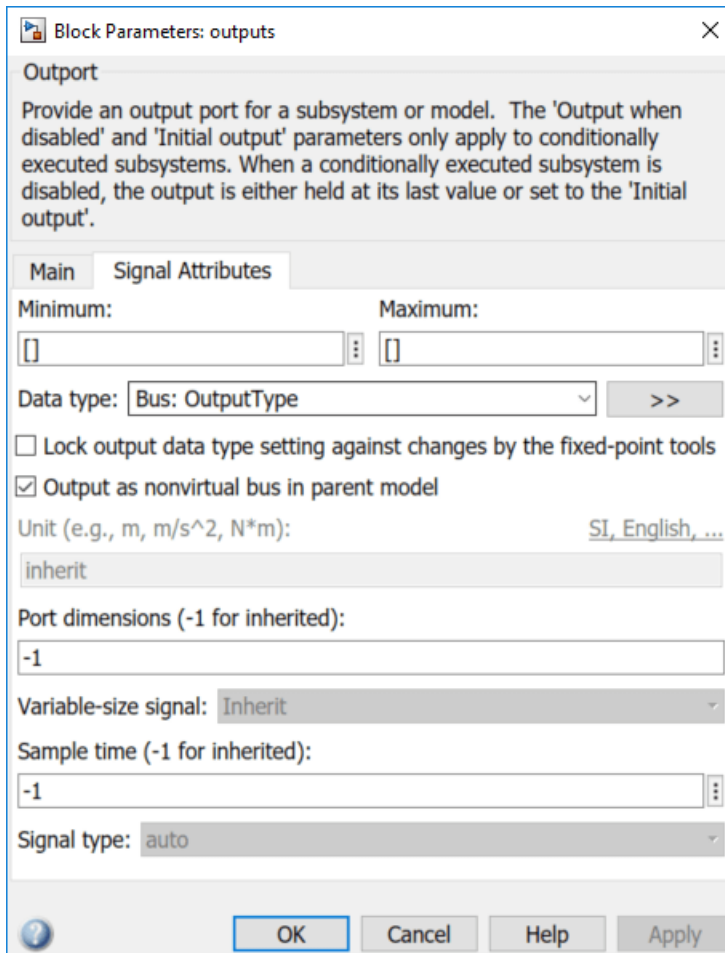

Alternatively, you can set the block parameters from the MATLAB command line:

```
set_param('sldemo_mdhref_counter_datamngt/outputs', ...
          'UseBusObject', 'on', ...
          'BusObject', 'OutputType', ...
          'BusOutputAsStruct', 'on');
```

3. Create a MATLAB script to recreate this bus object.

This example uses a MATLAB script (`sldemo_mdhref_counter_datamngt_types`) to recreate the bus objects used by the referenced model.

You can create this MATLAB script manually, or use **Simulink.saveVars**:

```
Simulink.saveVars('sldemo_mdhref_counter_datamngt_types.m', 'OutputType');
```

4. Configure the referenced model to create the global data that it uses.

It is common practice for a model to recreate all of the global data and types that it uses. In this example, the referenced model's **PreLoadFcn** is used to execute the MATLAB script that creates the bus objects for the referenced model. The referenced model does not use any other global variables.

To set the **PreLoadFcn** model callback, open the Model Properties dialog box from the **Modeling** tab by clicking the **Model Settings** button arrow, and then under **Top Model**, selecting **Model**

Properties. On the **Callbacks** tab of the Model Properties dialog box, in the **Model pre-load function** box, call the `sldemo_mdref_counter_datamngt_types` script, and then click **Apply**.

Alternatively, set the callback from the MATLAB command line.

```
set_param('sldemo_mdref_counter_datamngt', ...
         'PreLoadFcn', 'sldemo_mdref_counter_datamngt_types');
```

5. Explore how the bus type is used in the model hierarchy.

This bus type forms part of the interface for the referenced model and is referred to by blocks in both the top and referenced models. Use **find_mdrefs** and **Simulink.findVars** to find out about all the places where this bus object is used in the model reference hierarchy.

```
models = find_mdrefs('sldemo_mdref_datamngt');
open_system(models);
varInfo = Simulink.findVars(models, 'Name', 'OutputType');
blks = vars.UsedByBlocks
```

```
models =
```

```
2x1 cell array
```

```
 {'sldemo_mdref_counter_datamngt'}
 {'sldemo_mdref_datamngt' }
```

```
blks =
```

```
7x1 cell array
```

```
 {'sldemo_mdref_counter_datamngt/Initial Count' }
 {'sldemo_mdref_counter_datamngt/Previous Count' }
 {'sldemo_mdref_counter_datamngt/Range Check/Bus Creator'}
 {'sldemo_mdref_counter_datamngt/outputs' }
 {'sldemo_mdref_datamngt/Counter1' }
 {'sldemo_mdref_datamngt/Counter2' }
 {'sldemo_mdref_datamngt/Counter3' }
```

Referenced Model: Setting Initial Value for Bus Output

In general, the initial values for bus signals and states can be specified as '0', in which case all of the elements of the bus will be initialized to zero (or the relevant ground value). However, in certain cases, it is desirable to specify nonzero initial values for bus signals and states. In this example, the initial condition of the counter is tunable, so the initial value of output signal must be set consistently.

To specify the initial value of the output of the referenced model:

1. Create a parameter structure that is compatible with the bus signal that you want to initialize. One of the model arguments (CounterICs) is a parameter structure that matches the shape of the output signal. This structure was defined as follows:

```
CounterICs.Count = int8(0);
CounterICs.OverflowState = SLDemoRangeCheck.InRange;
```

Alternatively, you could have used the static method, `Simulink.Bus.createMATLABStruct` to create the structure using the ground value of the OutputType.

```
CounterICs = Simulink.Bus.createMATLABStruct('OutputType');
```

2. Open the dialog box for the root outport and enter the name of the structure (CounterICs) into the **Initial output** field.

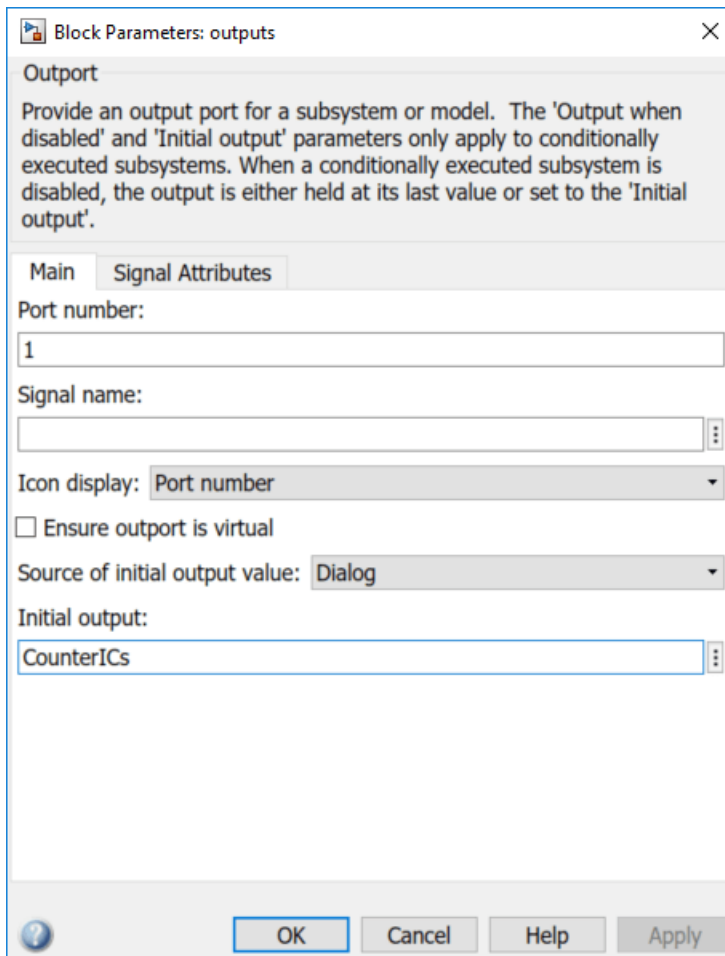

Alternatively, you can set the block parameters from the MATLAB command line:

```
set_param('sldemo_mdhref_counter_datamngt/outputs', ...
    'InitialOutput', 'CounterICs');
```

NOTE: In general, when initializing a bus signal or state, the parameter structure does not need to match the bus type exactly, but its fields must be a subset of the elements in the bus object and the attributes of these fields must match the elements in the bus object.

Referenced Model: Masking Referenced Model

It is often useful to mask the referenced model to customize the user interface. You can create a mask on a model and then reference it from a Model block. To mask a model, click **Create Model Mask** in the model workspace section of Model Explorer for the model.

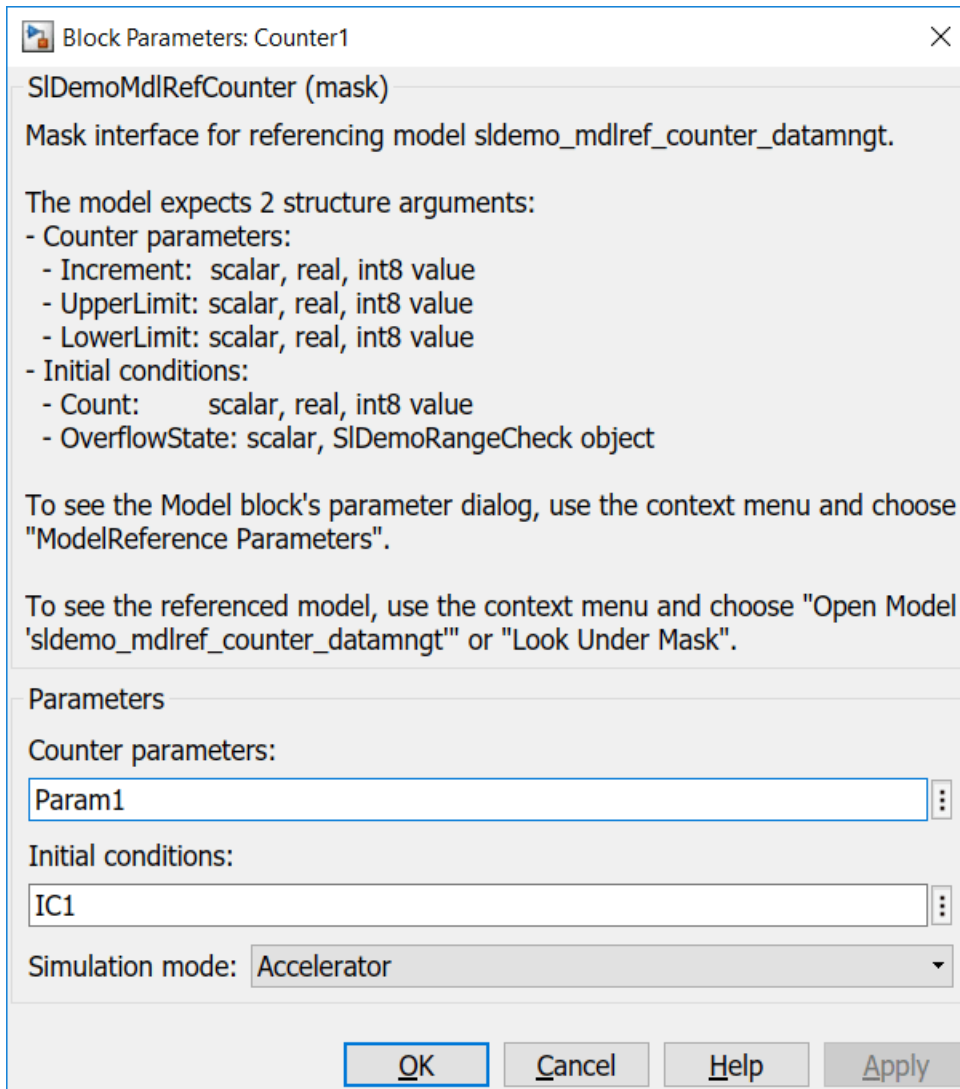

When you reference a masked model from a Model block, a mask is generated automatically on the Model block. For more information, see the topic **Create and Reference a Masked Model**.

Top Model: Parameterizing Model Blocks

The referenced model is configured to accept a structure for its model argument. This example calls each instance of the referenced model with different parameter values.

1. Open the top model (sldemo_mdref_datamngt).

Managing Data with Model Reference

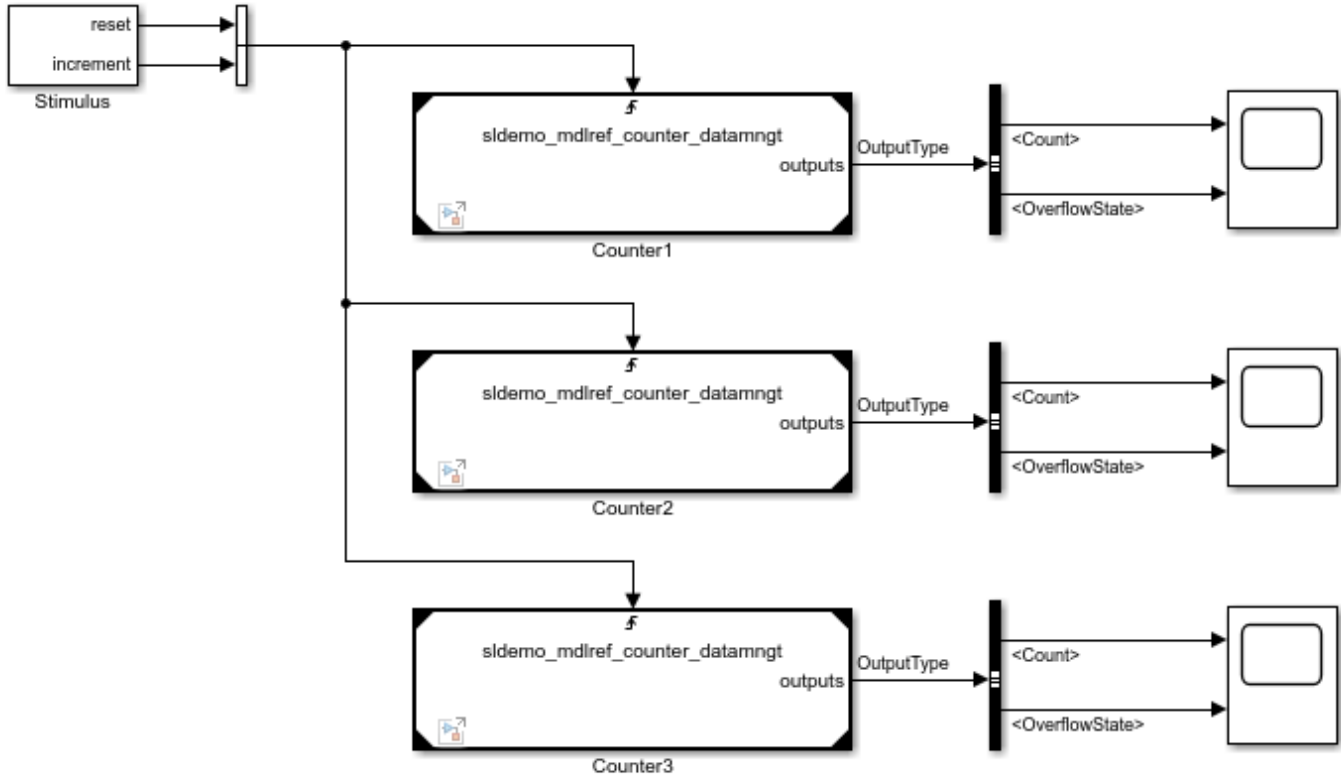

Copyright 1990-2014 The MathWorks, Inc.

2. Create parameter structures with the same "shape" as the model arguments defined in the referenced model.

```
Param1.Increment = int8(1);
Param1.LowerLimit = int8(-20);
Param1.UpperLimit = int8(20);
```

```
Param2 = Param1;
Param2.Increment = int8(2);
```

```
IC1.Count = int8(0);
IC1.OverflowState = SLDemoRangeCheck.InRange;
```

```
IC2 = IC1;
IC2.Count = int8(-10);
```

3. Set the mask parameters on the masked Model blocks to use these parameters.

For example, the parameters of the first Model block ('sldemo_mdhref_datamngt/Counter1') are set as:

- **Param1** for the **Counter** parameters

- **IC1** for the **Initial conditions**

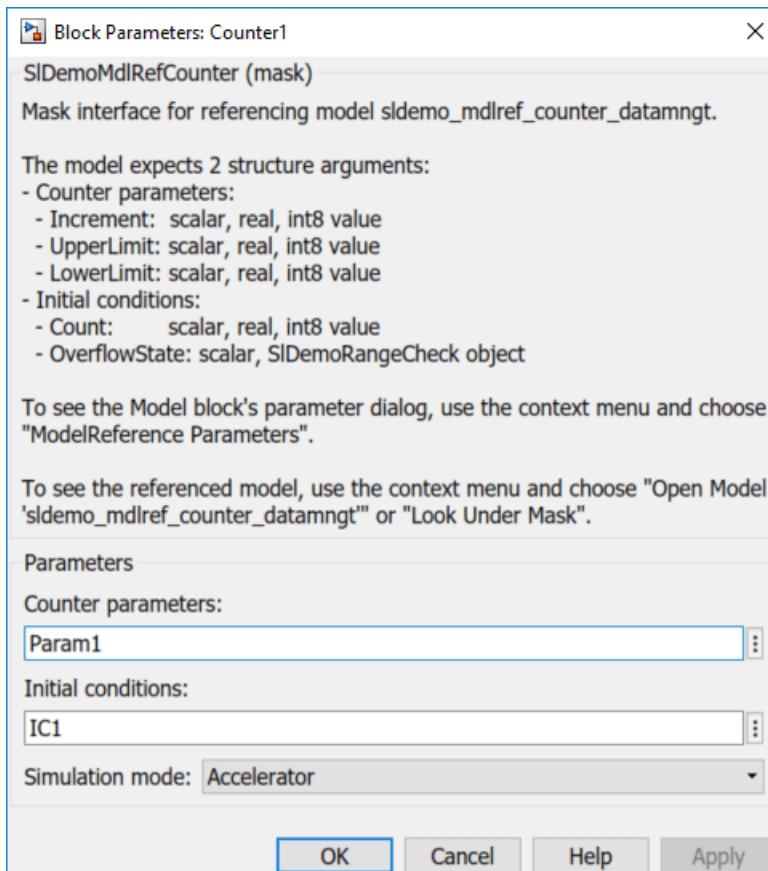

Alternatively, you can set the block parameters from the MATLAB command line:

```
set_param('sldemo_mdref_datamngt/Counter1', ...
          'CounterParams', 'Param1', ...
          'CounterICs', 'IC1');
```

3. Create a MATLAB script to recreate these workspace variables.

This example uses a MATLAB script (`sldemo_mdref_datamngt_wsdata`) to recreate these workspace variables.

You can create this MATLAB script manually, or use **Simulink.saveVars**:

```
Simulink.saveVars('sldemo_mdref_datamngt_wsdata.m', 'Param*');
```

4. Configure the top model to create all global variables.

It is good practice for the top model to recreate all of the global data and types used throughout the model reference hierarchy. This configuration avoids loading referenced models when simulating the top model.

In this example, the top model's **PreLoadFcn** is used to execute the MATLAB scripts that create the workspace data for the top model and the types for the referenced model. The referenced model does not use any global data.

```
set_param('sldemo_mdref_datamngt', ...
          'PreLoadFcn', ['sldemo_mdref_datamngt_wsdata; ', ...
                        'sldemo_mdref_counter_datamngt_types']);
```

Top Model: Scheduling Calls to the Referenced Model

As mentioned earlier, the referenced model implements a limited counter algorithm with two trigger inputs. The algorithm detects "rising edges" in the trigger inputs and reacts as follows:

- Resets the counter if the first trigger input changes.
- Increments the counter by a specified amount if the second input changes.

In this example, you drive all three instances of the counter algorithm with the same trigger inputs, generated by the Stimulus subsystem. The period and sample time of the trigger inputs are defined by the values entered for the mask parameters of the Stimulus subsystem:

- Reset counter every 4 seconds.
- Increment counter 5 times per second (period = 0.2 second).
- Sample time is 0.1 second.

NOTE: Reset and increment periods must be at least 2 times the sample time.

Simulating the Top Model

1. Save or close the referenced model.

You need to save the referenced model before it can be used by the top model. Alternatively, you can close the referenced model and use the original version of the model provided with this example.

2. Simulate the top model by selecting **Simulation > Run**.

```
sim('sldemo_mdref_datamngt')
```

NOTE: Simulating the top model automatically generates a simulation target for the referenced model.

3. Review the simulation results as displayed by the Scope blocks.

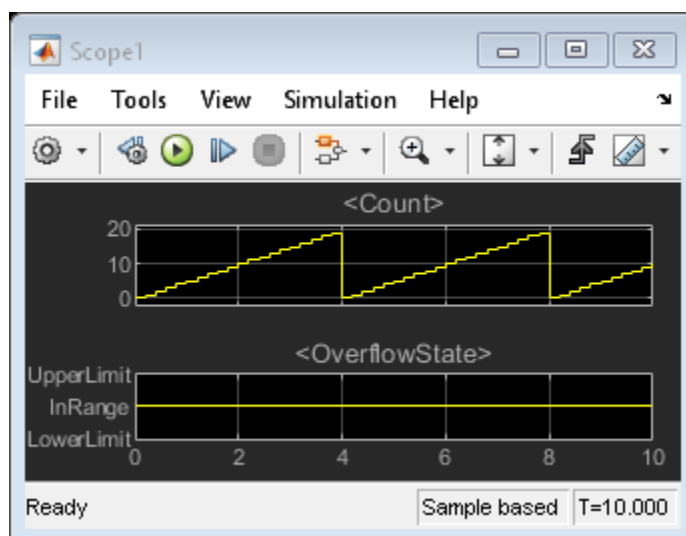

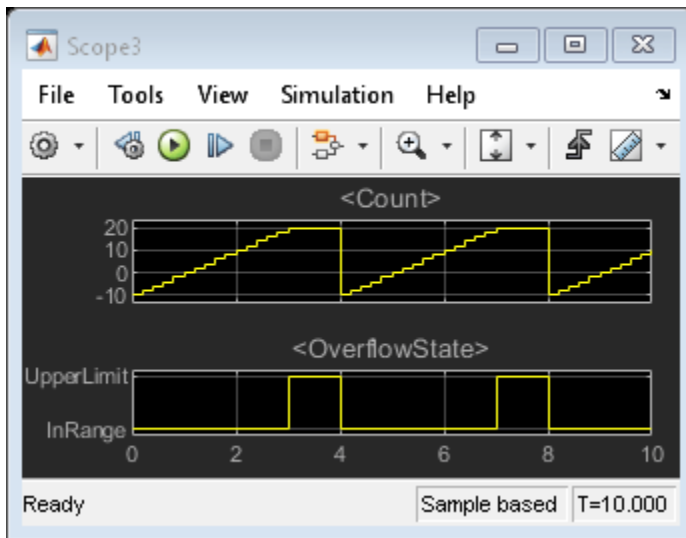
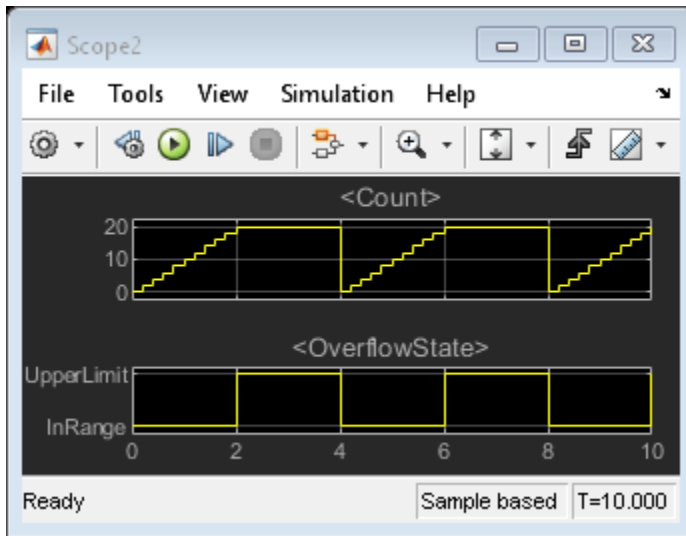

Generating Code for the Top Model (Requires Simulink Coder)

To generate code and build a standalone executable for the top model, open the top model, and then press **Ctrl+B**.

Alternatively, use `rtwbuild` at the MATLAB command line.

```
rtwbuild('sldemo_mdref_datamngt')
```

NOTE: When you generate code for the top model, Simulink Coder automatically generates code for the referenced model. Use Embedded Coder™ to generate embedded code for production deployment.

Controlling the Type Name for the Model Argument

By default, Simulink Coder generates an automatic name for the type of the parameter structures. This name is unique and deterministic, but not easy to recognize. You can control this type name by

using `Simulink.Parameter` objects to define the parameter structures and `Simulink.Bus` objects to define the type.

1. Define the bus type for the model argument by using the Bus Editor or by typing the following commands at the MATLAB command line:

```
CounterParamType = Simulink.Bus;
CounterParamType.Elements = Simulink.BusElement;
CounterParamType.Elements(1).Name = 'Increment';
CounterParamType.Elements(1).DataType = 'int8';
CounterParamType.Elements(2) = Simulink.BusElement;
CounterParamType.Elements(2).Name = 'LowerLimit';
CounterParamType.Elements(2).DataType = 'int8';
CounterParamType.Elements(3) = Simulink.BusElement;
CounterParamType.Elements(3).Name = 'UpperLimit';
CounterParamType.Elements(3).DataType = 'int8';
```

2. Modify the existing MATLAB script to recreate this bus object.

This bus type must be defined in the base workspace, along with the bus type for the referenced model's output. You can manually modify the MATLAB script that defines the types for the referenced model or use **Simulink.saveVars** to append this variable to the existing MATLAB script.

```
Simulink.saveVars('sldemo_mdhref_counter_datamngt_types.m', 'CounterParamType', '-append');
```

3. Create `Simulink.Parameters` to define the model arguments.

To associate the bus types with the model arguments, you must use `Simulink.Parameter` objects in place of the MATLAB structures in the model workspace of the referenced model.

```
CounterParams = Simulink.Parameter;
CounterParams.Value.Increment = 1;
CounterParams.Value.LowerLimit = -10;
CounterParams.Value.UpperLimit = 10;
CounterParams.DataType = 'Bus: CounterParamType';

CounterICs = Simulink.Parameter;
CounterICs.Value.Count = 0;
CounterICs.Value.OverflowState = SLDemoRangeCheck.InRange;
CounterICs.DataType = 'Bus: OutputType';
```

NOTE: When you set the data type of a parameter object to be a bus, you can use double-precision values for the numeric fields of the parameter structure. Simulink converts these double-precision values to the appropriate numeric data type during model compilation.

You can manually modify the MATLAB script that defines the model argument or use **Simulink.saveVars** to update the existing MATLAB script.

```
Simulink.saveVars('sldemo_mdhref_counter_datamngt_wsdata.m', '-update');
```

NOTE: When you use the **-update** option, you do not need to specify the variables to be written out because **Simulink.saveVars** writes out only the values of variables already defined in the MATLAB script.

5. Reload the contents of the model workspace.

You have modified the data source that is used by the referenced model's workspace. If this model is open, you must reload the contents of the model workspace.

You can reload by using the model workspace's dialog box or at the MATLAB command line.

```
hWS = get_param('sldemo_mdref_counter_datamngt', 'ModelWorkspace');  
hWS.reload;
```

Controlling Representation of Parameters in the Top Model

You can use a similar approach to convert the parameter structures in the top model to use `Simulink.Parameter` objects. This configuration gives you control over the type name and enables you to control how these parameters appear in the generated code.

1. Create `Simulink.Parameter` objects with the `ExportedGlobal` storage class to define the parameter structures for the top model as a exported, tunable variables in the generated code.

```
Param1 = Simulink.Parameter;  
Param1.Value.Increment = 1;  
Param1.Value.LowerLimit = -10;  
Param1.Value.UpperLimit = 10;  
Param1.DataType = 'Bus: CounterParamType';  
Param1.CoderInfo.StorageClass = 'ExportedGlobal';  
  
Param2 = Param1.copy;  
Param2.Value.Increment = 2;  
  
IC1 = Simulink.Parameter;  
IC1.Value.Count = 0;  
IC1.Value.OverflowState = SLDemoRangeCheck.InRange;  
IC1.DataType = 'Bus: OutputType';  
IC1.CoderInfo.StorageClass = 'ExportedGlobal';  
  
IC2 = IC1.copy;  
IC2.Value.Count = -10;
```

2. Modify the existing MATLAB script to recreate these workspace variables.

You can manually modify the MATLAB script that defines the parameters for the top model or use **`Simulink.saveVars`** to update the existing MATLAB script.

```
Simulink.saveVars('sldemo_mdref_datamngt_wsdata.m', '-update');
```

NOTE: When you use the **`-update`** option, you do not need to specify the variables to be written out because **`Simulink.saveVars`** writes out only the values of variables already defined in the MATLAB script.

Regenerate Code for the Top Model (Requires Simulink Coder)

To generate code and build a standalone executable for the top model, open the top model, and then press **Ctrl+B**.

Alternatively, use `rtwbuild` at the MATLAB command line.

```
rtwbuild('sldemo_mdref_datamngt')
```

Interface Specification Using Bus Objects

This example shows how to propagate buses into referenced models. It also shows how you can simulate the referenced models independently using logged signal data from the parent model.

Open the Example Model

Open and simulate the example model `sldemo_mdref_bus`.

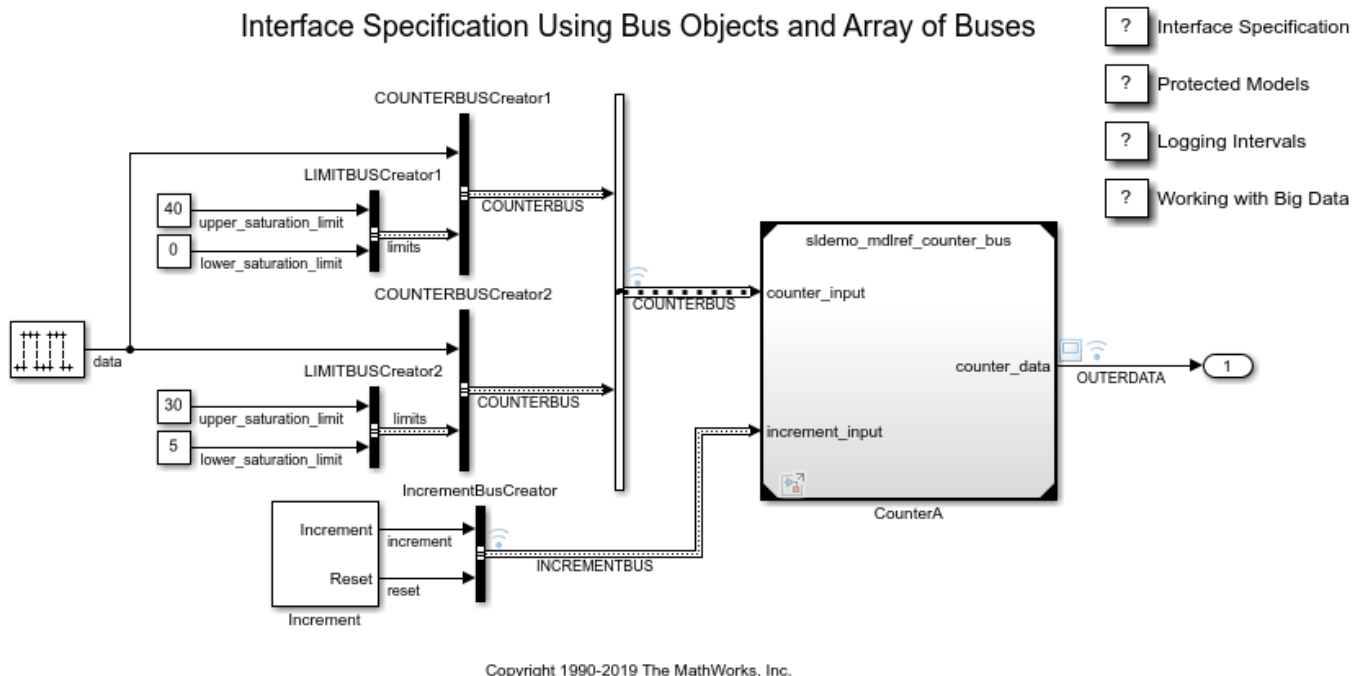

Examine the Model

The model contains a Model block named CounterA that references `sldemo_mdref_counter_bus`, which is a model of a simple counter.

An array of buses named COUNTERBUS feeds the data and the saturation limits of the counter into the model. The buses named COUNTERBUS each contain two elements: a data signal and a nested bus named LIMITBUS. The data is used in counting, and LIMITBUS contains the upper and lower limit values of the counter.

The Model block has a second input port that connects to a bus named INCREMENTBUS. This bus contains elements that change the increment and reset the counter.

The model uses a data dictionary file named `sldemo_mdref_bus.sldd` that contains Simulink.Bus objects that define the elements of COUNTERBUS, LIMITBUS, and INCREMENTBUS.

To view the Bus objects, open the Bus Editor. In the Simulink® Toolstrip, on the **Modeling** tab, in the **Design** gallery, click **Bus Editor**.

The model uses the Bus objects to specify the outputs of the following Bus Creator blocks:

- COUNTERBUSCreator1
- COUNTERBUSCreator2
- LIMITBUSCreator1
- LIMITBUSCreator2
- IncrementBusCreator

The Inport block named counter_input in sldemo_mdhref_counter_bus specifies the Bus object named COUNTERBUS. Double-click the block. In the Block Parameters dialog box, on the **Signal Attributes** tab, **Data type** is set to Bus: COUNTERBUS.

The Inport block named increment_input is similarly configured to use the Bus object named INCREMENTBUS.

Log Signal Data

These signals are marked for signal logging:

- COUNTERBUS
- INCREMENTBUS
- OUTERDATA
- INNERDATA

After you simulate the model, the logged signals are available in the base workspace in the topOut variable.

```
topOut =
```

```
Simulink.SimulationData.Dataset 'topOut' with 4 elements
```

| | Name | BlockPath |
|----------------|--------------|--|
| 1 [1x1 Signal] | COUNTERBUS | sldemo_mdhref_bus/Concatenate |
| 2 [1x1 Signal] | OUTERDATA | sldemo_mdhref_bus/CounterA |
| 3 [1x1 Signal] | INCREMENTBUS | sldemo_mdhref_bus/IncrementBusCreator |
| 4 [1x1 Signal] | INNERDATA | ...erA\sldemo_mdhref_counter_bus/COUNTER |

- Use braces { } to access, modify, or add elements using index.

The model uses Dataset format for signal logging. To access Dataset format logged data for a given signal, use the getElement method:

```
topOut.getElement('COUNTERBUS')
```

```
ans =
```

```
Simulink.SimulationData.Signal
Package: Simulink.SimulationData
```

```
Properties:
```

```
    Name: 'COUNTERBUS'
  PropagatedName: ''
```

```

BlockPath: [1x1 Simulink.SimulationData.BlockPath]
PortType: 'outport'
PortIndex: 1
Values: [2x1 struct]

```

Bus data is logged as a MATLAB® structure in the Values field:

```
topOut.getElement('COUNTERBUS').Values
```

```
ans =
```

```
2x1 struct array with fields:
```

```

data
limits

```

This structure contains MATLAB timeseries objects for each bus:

```
topOut.getElement('COUNTERBUS').Values(1).data
```

```
timeseries
```

```
Common Properties:
```

```

Name: 'data'
Time: [301x1 double]
TimeInfo: tsdata.timemetadata
Data: [301x1 int32]
DataInfo: tsdata.datametadata

```

```
topOut.getElement('COUNTERBUS').Values(2).data
```

```
timeseries
```

```
Common Properties:
```

```

Name: 'data'
Time: [301x1 double]
TimeInfo: tsdata.timemetadata
Data: [301x1 int32]
DataInfo: tsdata.datametadata

```

You can also plot the logged data using the plot function:

```
topOut.getElement('OUTERDATA').Values.plot()
```

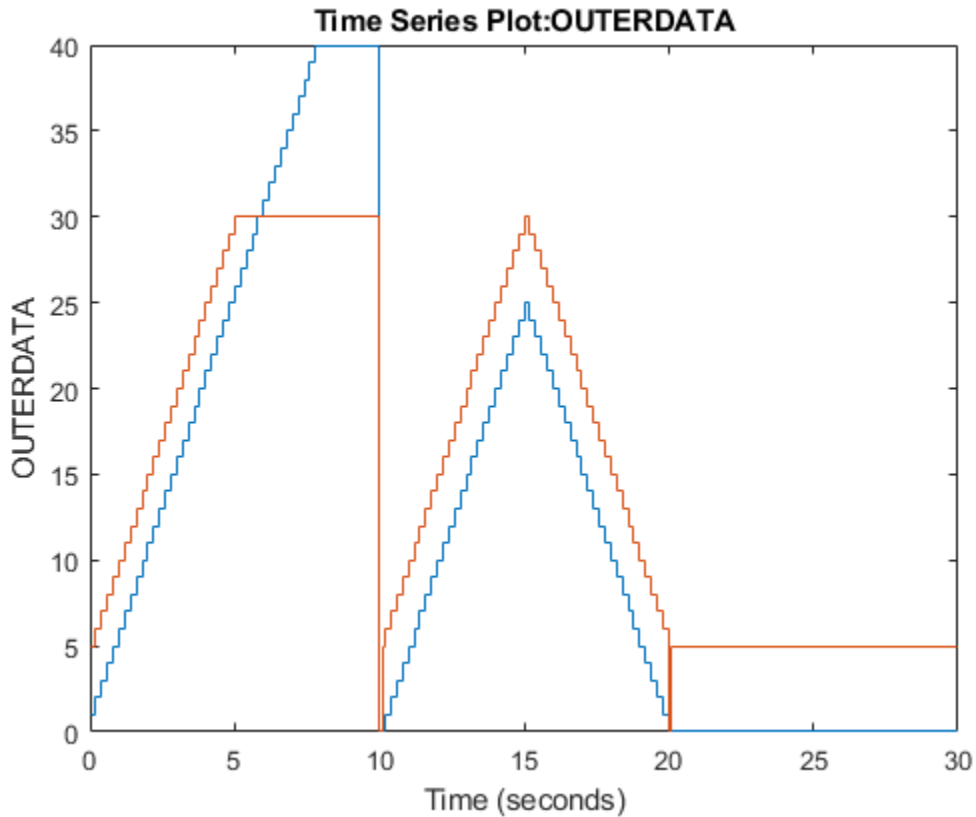

Log Referenced Model Signals

To log signals in the referenced model, select the Model block and click **Log Signals** on the **Model Block** tab.

For this model, **Logging Mode** is set to Log all signals as specified in model. All the signals that are logged when simulating `sldemo_mdref_counter_bus` as a top model are also logged when simulating it as a referenced model. To change logging for any of these signals or to log a subset of signals:

- 1 Set **Logging Mode** to Override signals.
- 2 In the **Model Hierarchy** pane, clear the **CounterA (sldemo_mdref_counter_bus)** check box to indicate that this model should not use the Log all signals as specified in model setting.
- 3 In the table, select the signals to log when simulating the top model.
- 4 To save the changes, save the top model.

Load Data

Open the referenced model `sldemo_mdref_counter_bus` as a top model by clicking the **Open As Top Model** badge at the lower left corner of the Model block.

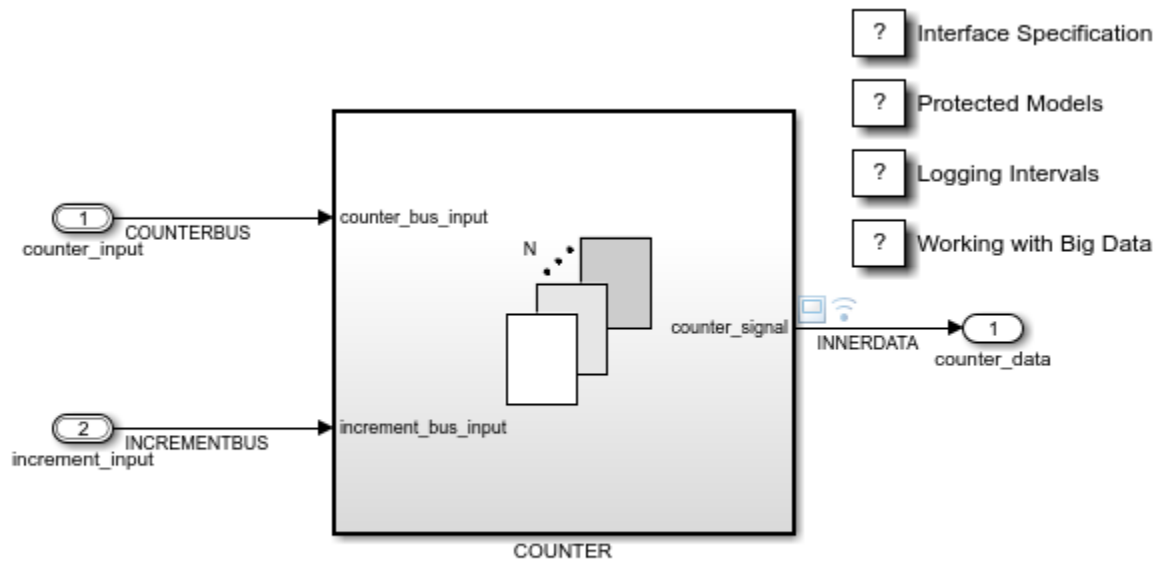

Copyright 1990-2019 The MathWorks, Inc.

The referenced model is configured to read the logged signal data through the root Inport blocks. To see this configuration, open the Configuration Parameters dialog box. In the Simulink Toolstrip, on the **Modeling** tab, click **Model Settings**. On the **Data Import/Export** tab, **Input** uses a comma-separated list to specify logged data from `topOut` for the two input ports. The **counter_input** port uses an array of structure of timeseries to load data for COUNTERBUS, and the **increment_input** port uses a structure of timeseries to load data for INCREMENTBUS.

- `topOut.getElement('COUNTERBUS')`
- `topOut.getElement('INCREMENTBUS')`

You can configure the **Input** field by clicking the **Connect Input** button. The Root Inport Mapper tool opens. In this example, the tool uses a mapping algorithm to set up the **Input** field from logged data in the base workspace.

To select the data to import:

- 1 In the Root Inport Mapper, click **From Workspace**.
- 2 Select the logged data `topOut` and click **OK**.
- 3 In the dialog box that opens, specify a file name and click **Save**.

With the data loaded into the Root Inport Mapper tool, you can determine the root input port for which to assign input data. Simulink matches input data with input ports based on one of these criteria: block name, block path, signal name, port order, or a custom algorithm. Because `topOut` is logged using signal names from the model, the best choice for a mapping criterion is **Signal Name**. Using this criterion, Simulink tries to match input data variable names to the names of the input signals.

To select this option:

- 1 In the Root Inport Mapper hierarchy pane, select scenario dataset `topOut`.

- 2 Click the **Signal Name** radio button.
- 3 Click the **Map to Model** button arrow, then click **Map All**.

When mapping data, Simulink evaluates input ports against the input data to determine compatibility. The Root Inport Mapper table reflects the status of this compatibility with a green check mark, orange warning triangle, or red error exclamation mark. In this example, the table shows a green status indicating there is no compatibility issue. You can simulate the model with this mapping of input data to input ports. The mapping also sets **Input** in the **Data Import/Export** tab of the Configuration Parameters dialog to the proper comma-separated list of inputs. To apply the changes to the model, in the Configuration Parameters dialog, click **Apply**.

Simulate Model with Imported Data

Simulate `sldemo_mdhref_counter_bus`.

After simulation, the scopes from `sldemo_mdhref_bus` (OUTERDATA) and `sldemo_mdhref_counter_bus` (INNERDATA) show the same trace.

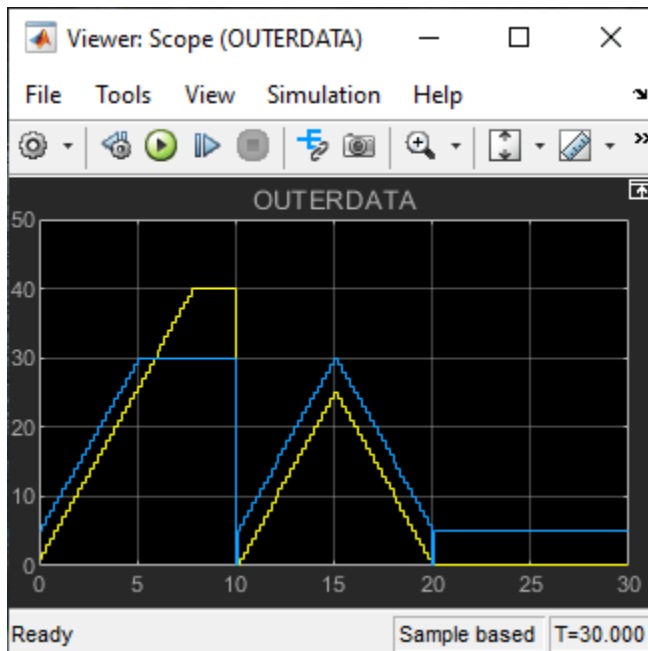

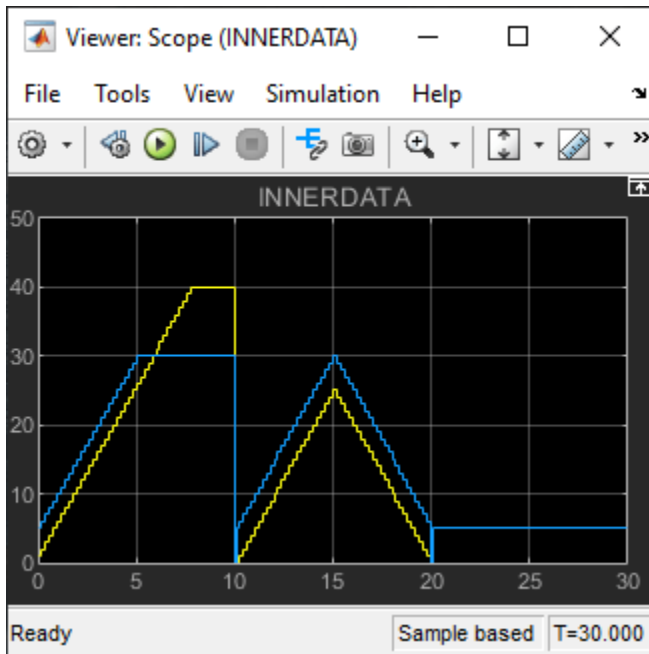

The signal feeding the scope in the referenced model is also logged. The logged data is available in the MATLAB workspace under the variable `subOut`. You can verify that the data in `topOut.getElement('OUTERDATA')` and `subOut.getElement('INNERDATA')` is the same.

See Also

`Simulink.Bus`

Related Examples

- “Component-Based Modeling with Model Reference” on page 13-384
- “Model Reference Basics”
- “Explore Simulink Bus Capabilities” on page 13-301
- “Types of Composite Signals”
- “Convert Subsystem to Referenced Model” on page 13-436

Convert Subsystem to Referenced Model

This example demonstrates how to convert a subsystem to a referenced model by using the **Model Reference Conversion Advisor** tool or the `Simulink.SubSystem.convertToModelReference` function.

Examine Example Model

Open and simulate the example model.

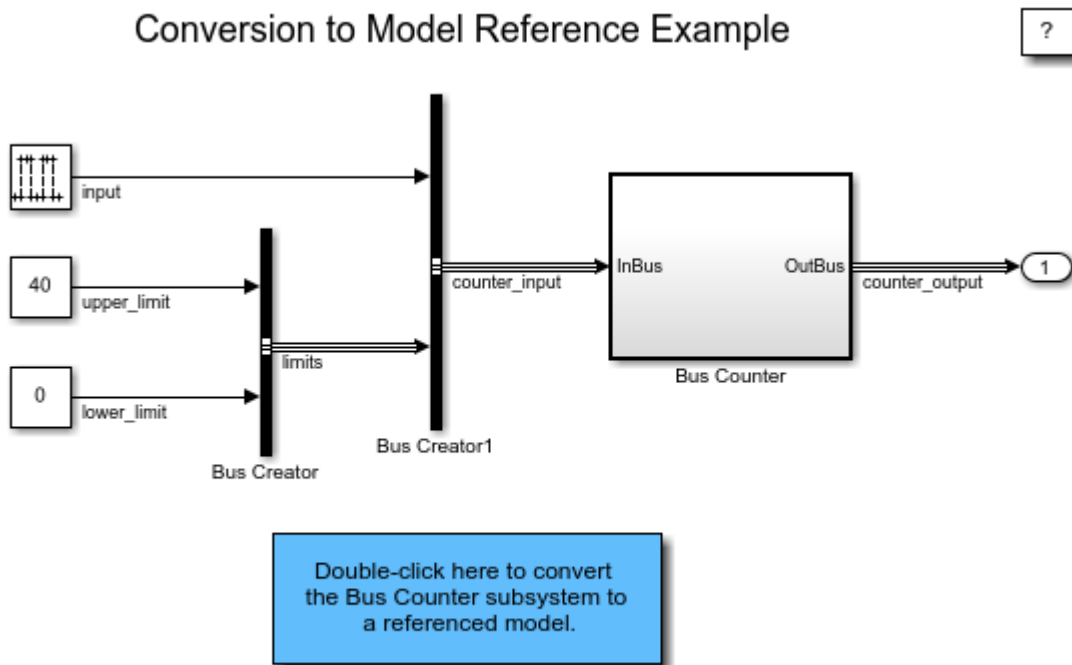

Copyright 1990-2020 The MathWorks, Inc.

The `sldemo_mdref_conversion` model contains an atomic subsystem named `Bus Counter` that models a counter algorithm.

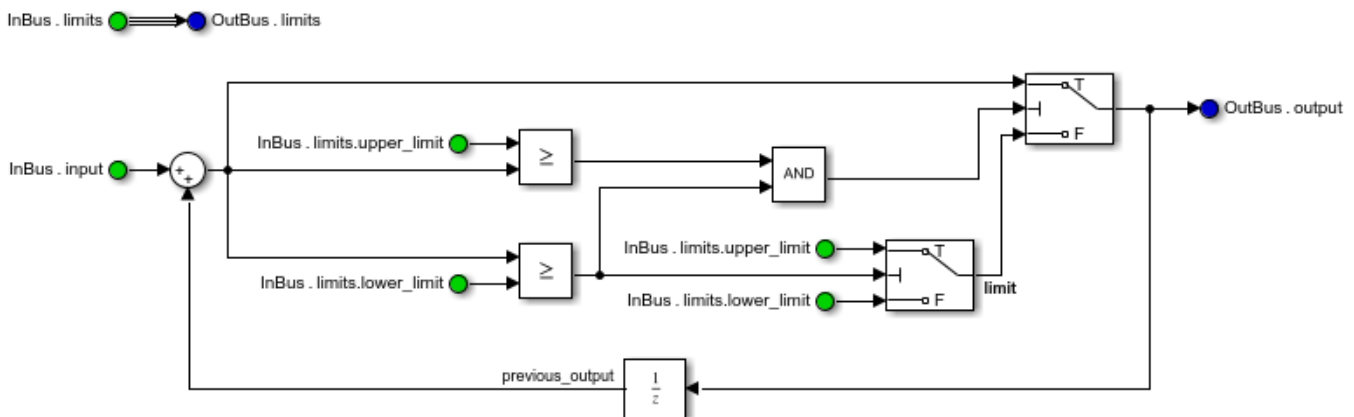

The subsystem interface uses In Bus Element and Out Bus Element blocks to pass a virtual bus into and out of the subsystem. The virtual buses inherit their data types. To more strongly define the interface of the new model after conversion, create `Simulink.Bus` objects and use them as the data types of the buses.

Interactively Convert Subsystem to Referenced Model

Use the Model Reference Conversion Advisor to interactively convert the subsystem. Select a Subsystem block, then on the **Subsystem Block** tab, select **Convert > Model Block**. In the Model Reference Conversion Advisor, set **New model name** to `sldemo_bus_counter`, then click **Convert**.

You can also open the Model Reference Conversion Advisor by setting `'UseConversionAdvisor'` to `'true'` when calling the `Simulink.SubSystem.convertToModelReference` function.

Programmatically Convert Subsystem to Referenced Model

Use the `Simulink.SubSystem.convertToModelReference` function to programmatically convert the atomic subsystem to a referenced model. To convert the Bus Counter subsystem to a referenced model named `sldemo_bus_counter` and to replace the Subsystem block with a Model block that references the new model, enter this command in the MATLAB® Command Window:

```
Simulink.SubSystem.convertToModelReference(...  
    'sldemo_mdref_conversion/Bus Counter', ...  
    'sldemo_bus_counter', ...  
    'ReplaceSubsystem', true);
```

Alternatively, double-click the blue block, which uses an `OpenFcn` block callback to execute this command.

See Also

Blocks

Subsystem | Model

Tools

Model Reference Conversion Advisor

Functions

`Simulink.SubSystem.convertToModelReference` | `Simulink.Bus.createObject`

More About

- “Model Reference Basics”
- “Component-Based Modeling Guidelines”
- “Convert Subsystems to Referenced Models”
- “Model Reference Requirements and Limitations”

Using Data Stores Across Multiple Models

This example shows how to use and log local data stores. It also shows how to define, use and log global data stores to share global data among referenced models.

Open the Example Models

Open the example models. The top model `sldemo_mdref_dsm` references models `sldemo_mdref_dsm_bot` and `sldemo_mdref_dsm_bot2`. Logging of data stores is turned on for `sldemo_mdref_dsm` on the Data Import/Export pane of the Configuration Parameters dialog box.

Reference model `sldemo_mdref_dsm_bot` amplifies the incoming signal by 5 if the signal is positive or by 2 if the signal is negative and writes the value of this signal to local data store `RefSignalVal`. This local data store is configured to log all written values to the workspace after simulation. The logging parameters for this local data store are controlled by the **Logging** tab of the block parameters dialog.

Reference model `sldemo_mdref_dsm_bot2` sets the value of a global boolean data store named `ErrorCond` to true if the value of its incoming signal is outside of the range $(-0.8, 0.8)$. The top model also monitors the data store `ErrorCond` and switches between the outputs of the two referenced models, depending on the value of that data store.

Using Data Stores Across Multiple Models

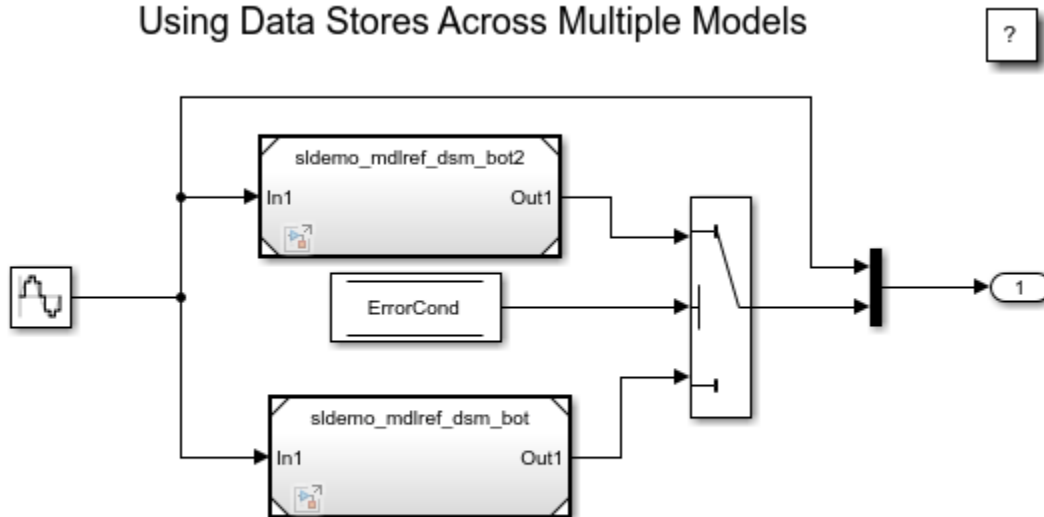

Copyright 1990-2013 The MathWorks, Inc.

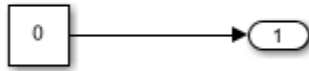
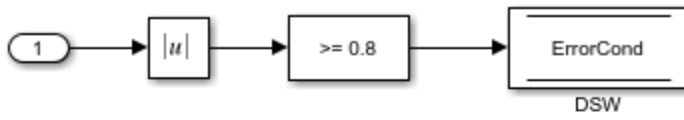

Copyright 1990-2013 The MathWorks, Inc.

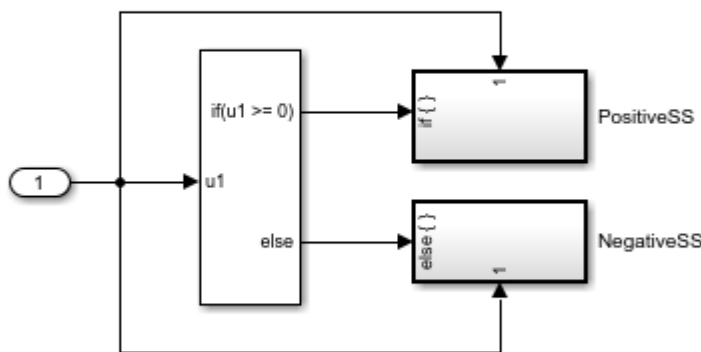
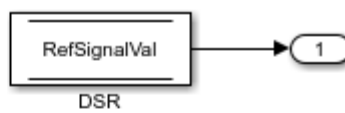

Copyright 1990-2013 The MathWorks, Inc.

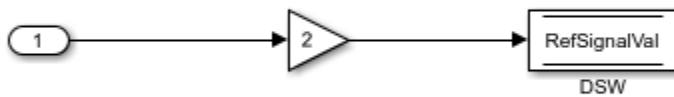
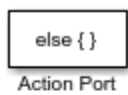

Copyright 1990-2013 The MathWorks, Inc.

Define a Global Data Store Using a Simulink® Signal Object

To specify to Simulink that the top model and both of the referenced models use the same memory for the data store named `ErrorCond` in each model, create an instance of a `Simulink.Signal` object named `ErrorCond` in a workspace or data dictionary that is visible to each model. Since this object is visible to each model, its scope encompasses the individual models and implies that there is one global data store of that name that is shared among the models. Note that none of the three models contains a Data Store Memory block with a data store name of `ErrorCond`. If any model contained such a block, that block would define a data store local to the model, which would shadow the global data store.

Since the object `ErrorCond` defines a global data store, it must explicitly define the `DataType`, `Complexity`, and `Dimensions` properties to non-inherited settings. `SampleTime` and `StorageClass` may be left as their inherited values, or explicitly set.

The example includes a MAT-file named `sldemo_mdref_dsm_data.mat` that contains the `Simulink.Signal` object `ErrorCond`. The preload function of the model `sldemo_mdref_dsm` loads this MAT-file causing the object to be loaded in the base workspace. You can view this object by selecting the base workspace in the Model Explorer. You can also create this object from the MATLAB® command prompt. The following commands define the object used in this example:

```
ErrorCond = Simulink.Signal;  
ErrorCond.Description = 'Use to signal that subsystem output is invalid';  
ErrorCond.DataType = 'boolean';  
ErrorCond.Complexity = 'real';  
ErrorCond.Dimensions = 1;  
ErrorCond.SampleTime = 0.1;  
ErrorCond.LoggingInfo.DataLogging = true;
```

Logging a Global Data Store

To log all the values written to the global data store, set the `DataLogging` property of the `LoggingInfo` property of the `Simulink.Signal` object. The `LoggingInfo` property also allows specification of other logging parameters such as decimation and maximum points.

```
Simulink.LoggingInfo (handle)  
  DataLogging: 1  
  NameMode: 0  
  LoggingName: ''  
  DecimateData: 0  
  Decimation: 2  
  LimitDataPoints: 0  
  MaxPoints: 5000
```

Simulate the Model

Now you can simulate `sldemo_mdref_dsm` to see the output. The reference model `sldemo_mdref_dsm_bot` writes to the data store `ErrorCond` while the top model `sldemo_mdref_dsm` reads from the data store. The blue line represents the input to `sldemo_mdref_dsm_bot`; the green line represents the output of the Switch block. Note that the output switches when the magnitude of the input signal falls outside of the range.

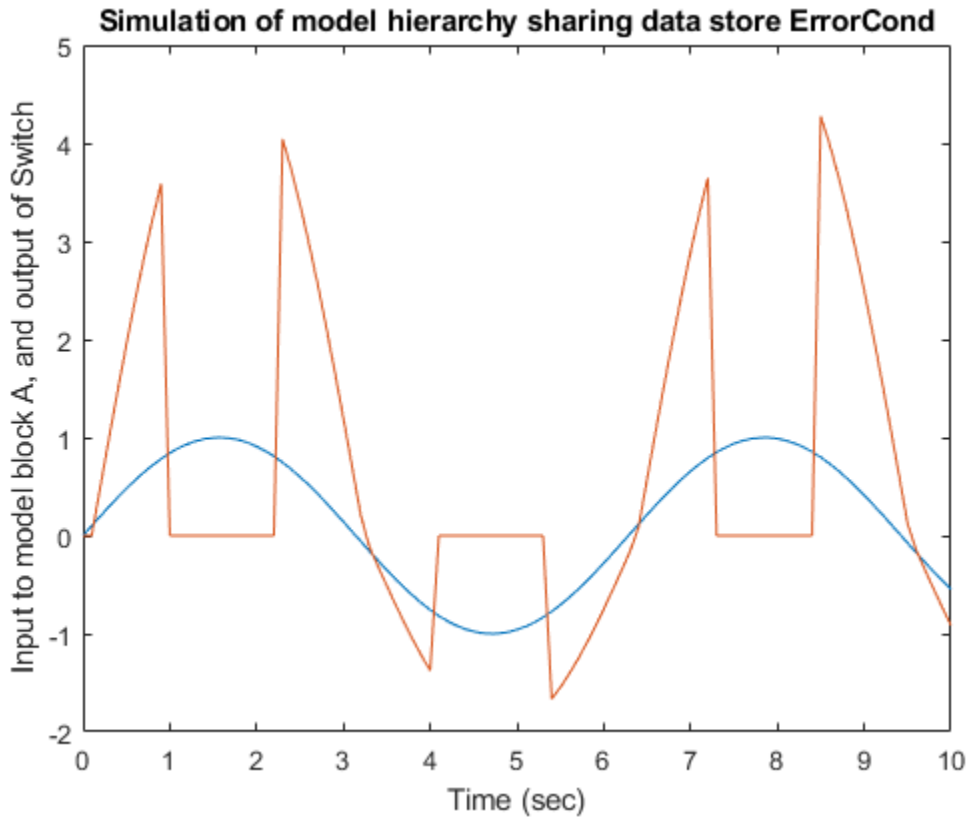

View Logged Results

Both the global data store `ErrorCond` and the local data store `RefSignalVal` are configured to log all written values after simulation. These logged results are stored in the base workspace in the `dsmout` variable.

```
dsmout =
```

```
Simulink.SimulationData.Dataset 'dsmout' with 2 elements
```

| | Name | BlockPath |
|-------------------------|--------------|---|
| 1 [1x1 DataStoreMemory] | ErrorCond | '' |
| 2 [1x1 DataStoreMemory] | RefSignalVal | ...dlref_dsm/A sldemo_mdref_dsm_bot/DSM |

- Use braces { } to access, modify, or add elements using index.

To access the data stored for the local data store, use the `getElement` function to get the correct data store element based on the name `RefSignalVal`.

```
>> dsmout.getElement('RefSignalVal')
```

```
Simulink.SimulationData.DataStoreMemory
Package: Simulink.SimulationData
```

```
Properties:
```

```

        Name: 'RefSignalVal'
        BlockPath: [1x1 Simulink.SimulationData.BlockPath]
        Scope: 'local'
        DSMWriterBlockPaths: [1x2 Simulink.SimulationData.BlockPath]
        DSMWriters: [101x1 uint32]
        Values: [1x1 timeseries]

```

Data is stored in a `timeseries` within the `Values` field.

```
>> plot(dsmout.getElement('RefSignalVal').Values);
```

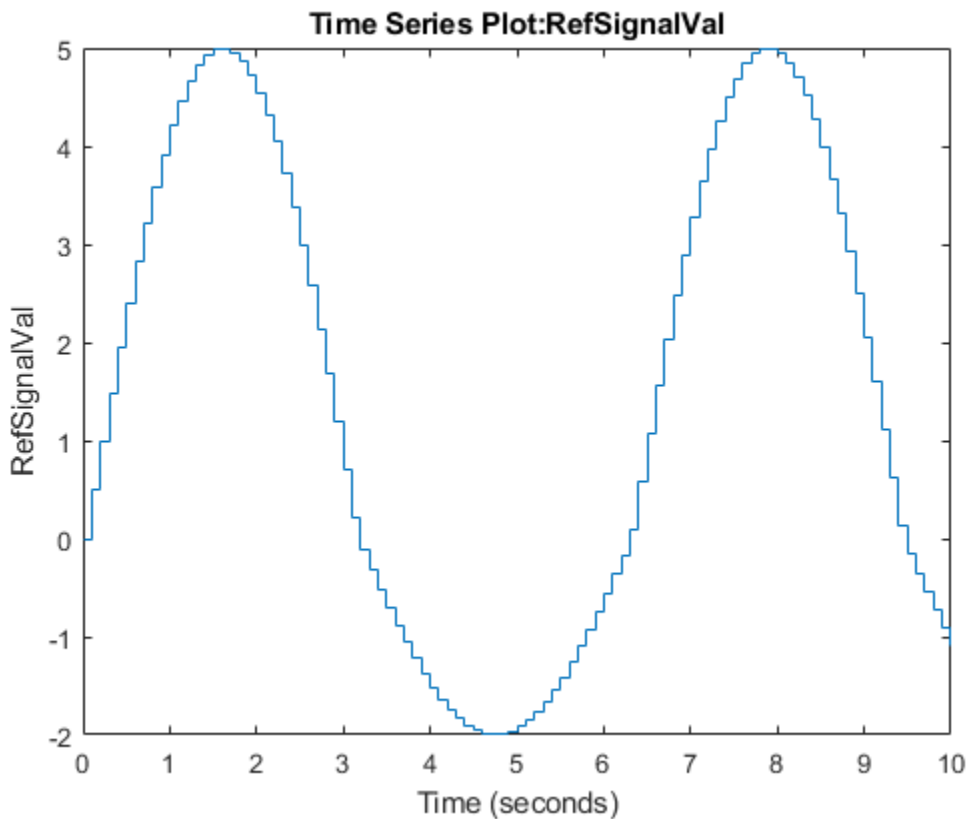

To determine which block wrote to the data store at a given time, use the `DSMWriters` property. This array contains a list of indices into the `DSMWriterBlockPaths` array. For example, the block path of the Data Store Write block that wrote the 5th value to the data store can be obtained as follows:

```
>> dsm = dsmout.getElement('RefSignalVal');
>> dsm.DSMWriterBlockPaths(dsm.DSMWriters(5))
```

```
Simulink.SimulationData.BlockPath
Package: Simulink.SimulationData
```

```
Block Path:
'sldemo_mdref_dsm/A'
'sldemo_mdref_dsm_bot/PositiveSS/DSW'
```

Use the `getBlock` method to access block path character vectors from this object.

See Also

[Data Store Memory](#) | [Data Store Read](#) | [Data Store Write](#)

Related Examples

- [“Data Store Basics”](#)
- [“Model Global Data by Creating Data Stores”](#)

Model Reference Function-Call

This example shows how to use a Model block that is explicitly triggered by means of its function-call trigger port.

Examine Example Model

Open the example model.

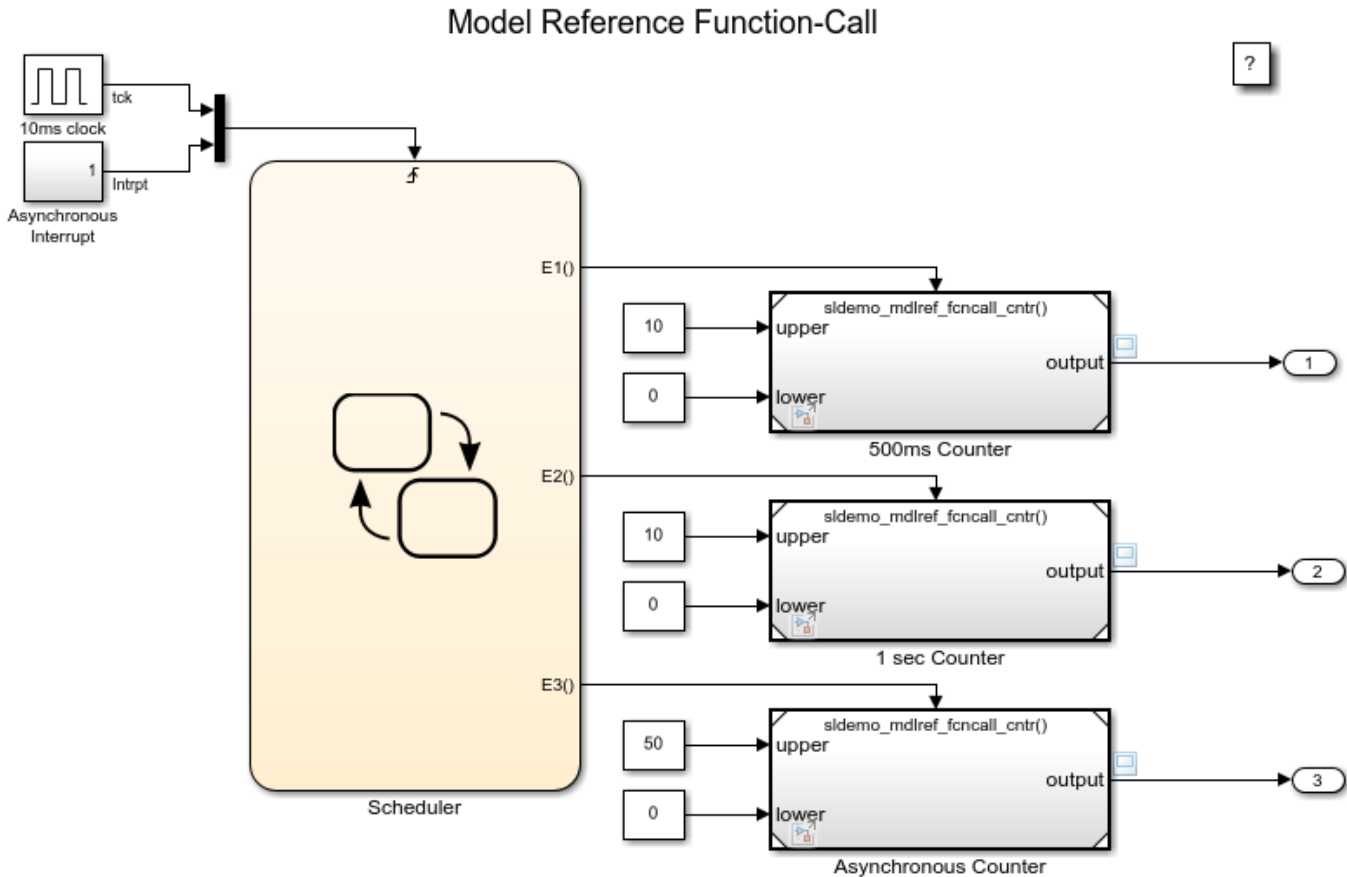

Copyright 1990-2014 The MathWorks, Inc.

This model contains three Model blocks: 500ms Counter, 1 sec Counter and Asynchronous Counter. These blocks reference the same model (`sldemo_mdref_fcncall_cntr`). The Model blocks represent saturating counters that increment their output values by one each time they are explicitly triggered through their function-call trigger ports. The Stateflow® chart calls each Model block at its specified rate.

Simulate Model and Examine Results

Simulate the model, and verify the behavior of the counters by examining the results displayed by the scope.

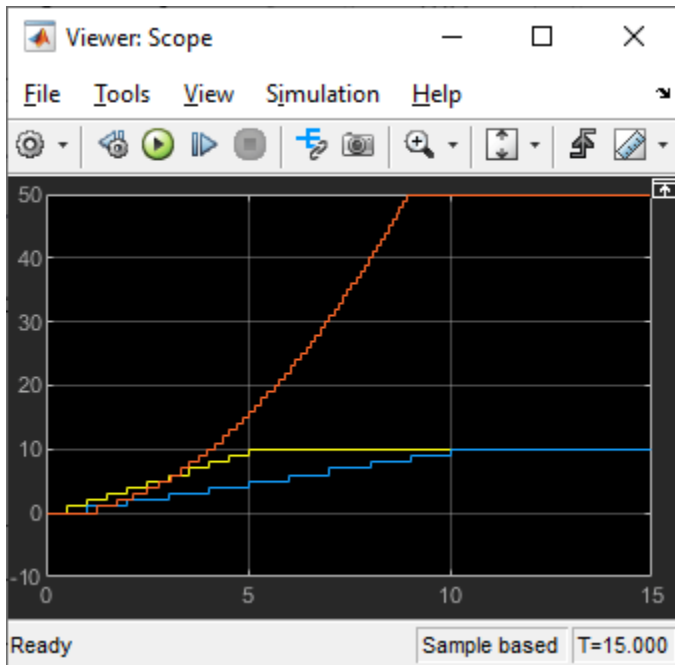

See Also

Model | Function-Call Generator | Function-Call Feedback Latch | Function-Call Split | Function-Call Subsystem

More About

- “Conditionally Execute Referenced Models”
- “Using Function-Call Subsystems”

Explore Protected Model Capabilities

This example shows how to create a protected model and use it in normal mode simulation, accelerator mode simulation, and code generation.

To create protected models, you must have Simulink® Coder™ installed. To generate the read-only view of protected models, you must have Simulink® Report Generator™ installed.

Open the Example Model

Open and simulate the example model `sldemo_mdref_bus`.

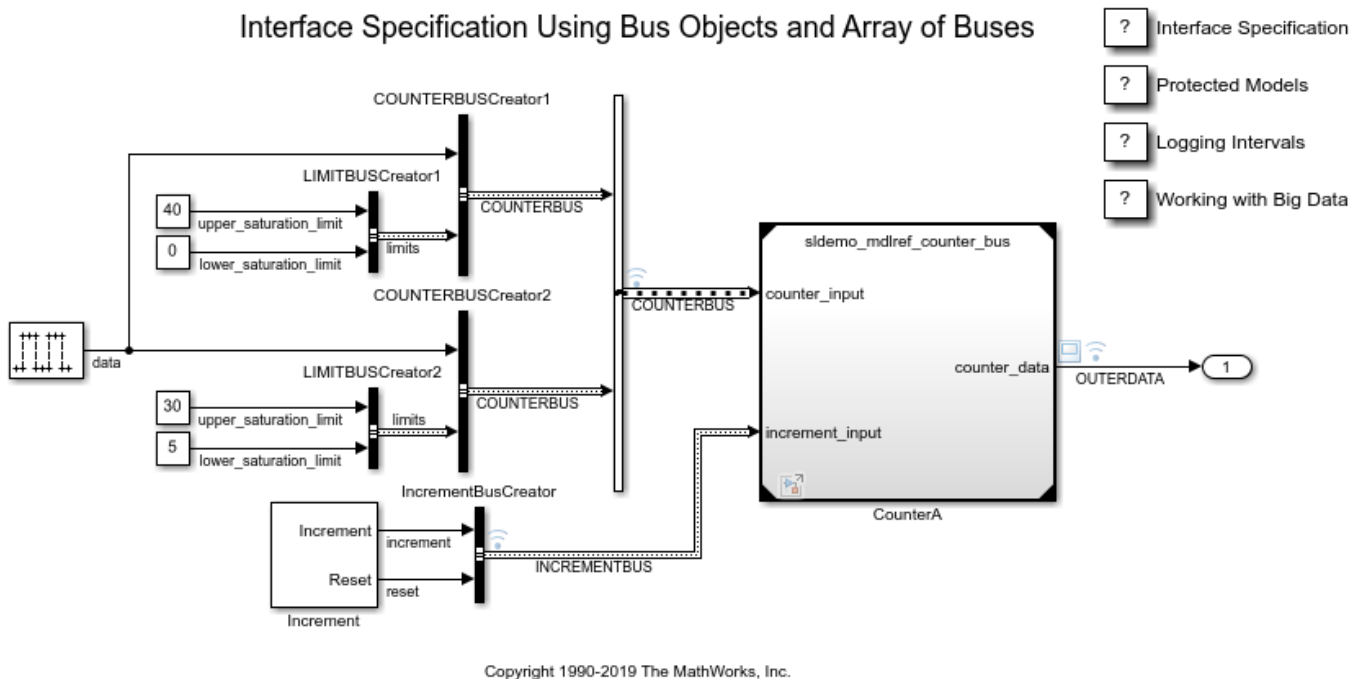

Protect the Referenced Model

The example model contains one Model block named CounterA. To protect the model referenced by this block, select the Model block and click **Protect** on the **Model Block** tab in the toolstrip. A dialog box opens where you can select options for creating a protected model.

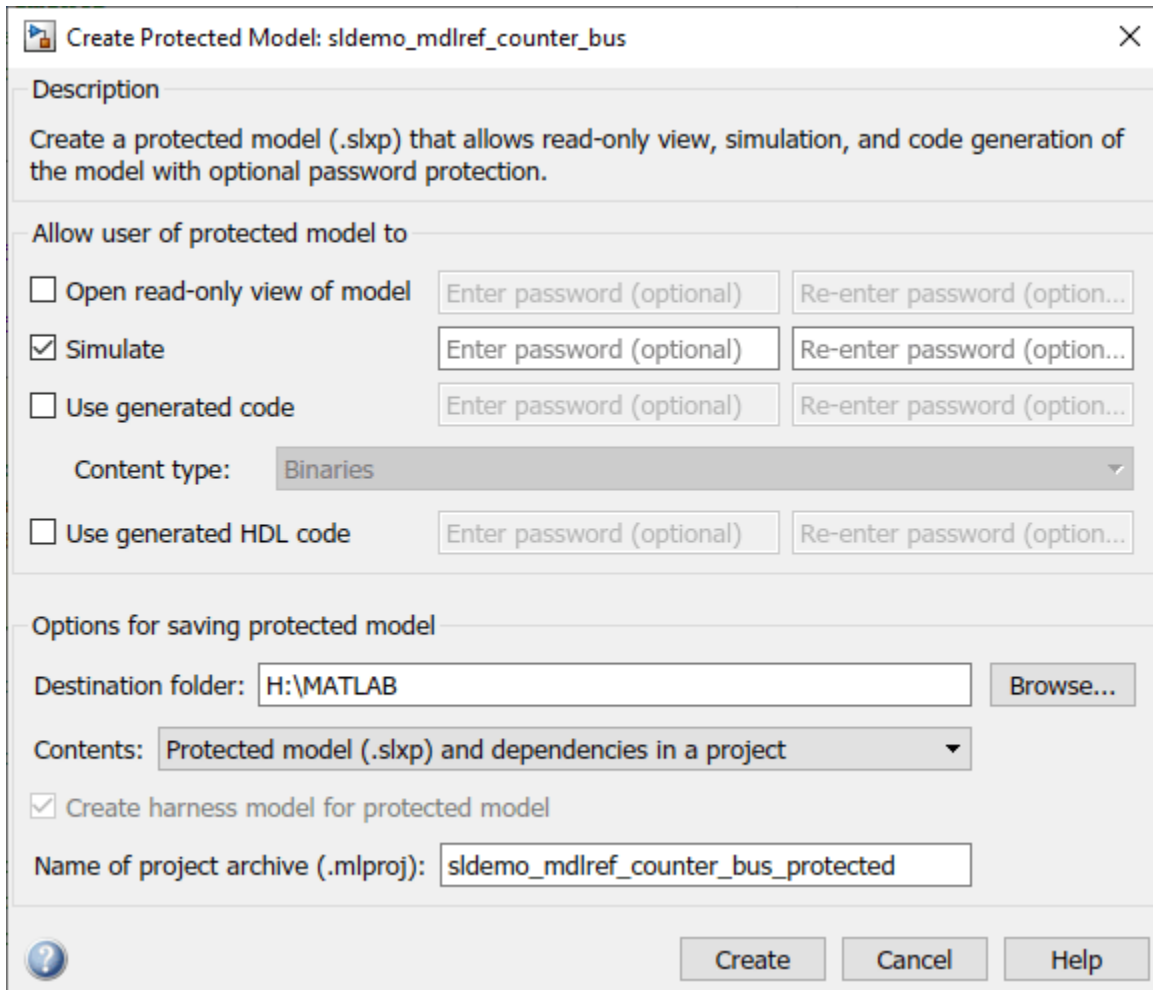

Under **Allow user of protected model to**, select **Open read-only view of model**, **Simulate**, and **Use generated code**. To password-protect these actions, you can enter a unique password for each action. Then, click **Create**.

A project archive for the protected model, `sldemo_mdhref_counter_bus_protected.mlproj`, is generated in the specified destination folder.

Double-click the project archive in the **Current Folder** browser to open the corresponding project that contains the protected model (`sldemo_mdhref_counter_bus.slxp`). The project also contains a harness model that provides an isolated environment for the protected model and a data dictionary that defines the variables used by the protected model.

You can use the protected model in normal mode simulation, accelerator mode simulation, and code generation. You can also open a read-only view of the model. The original model file is not required.

Use the Protected Model

When a Model block references a protected model, the block displays a shield badge.

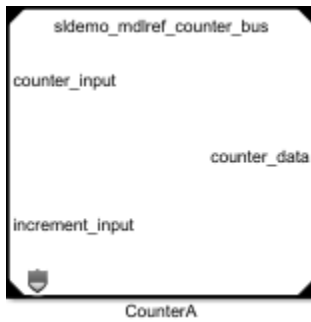

To enable password-protected functionality, right-click the shield badge and select **Authorize**. Enter the passwords you set while creating the protected model.

Password entry for model: 'sldemo_mdiref_counter_bus'

A password protected model 'sldemo_mdiref_counter_bus' is used in the current model reference hierarchy. Authorization is needed to proceed with the requested actions.

| | |
|-----------------|---|
| Model view | <input type="text" value="Enter password"/> |
| Simulation | <input type="text" value="Enter password"/> |
| Code generation | <input type="text" value="Enter password"/> |

After entering the passwords, you can simulate the model in either normal or accelerator mode. You can also generate code for the top model.

To open a read-only view of the protected model, double-click the Model block or right-click the shield badge and select **Show Webview**.

Protected model read-only view for model: sldemo_mdref_counter_bus

Find: Match Case

sldemo_mdref_counter_bus View All

sldemo_mdref_counter_bus

Copyright 1990-2019 The MathWorks, Inc.

Parameter Attributes

| | |
|-------------------|--------------------------|
| ModelVersion | 1.270 |
| LastModifiedDate | Fri Mar 27 03:56:08 2020 |
| LibraryLinkDis... | none |
| ModelBrowser... | off |
| Dirty | off |
| Description | |

OK Help

To open the protected model report, right-click the shield badge and select **Display Report**.

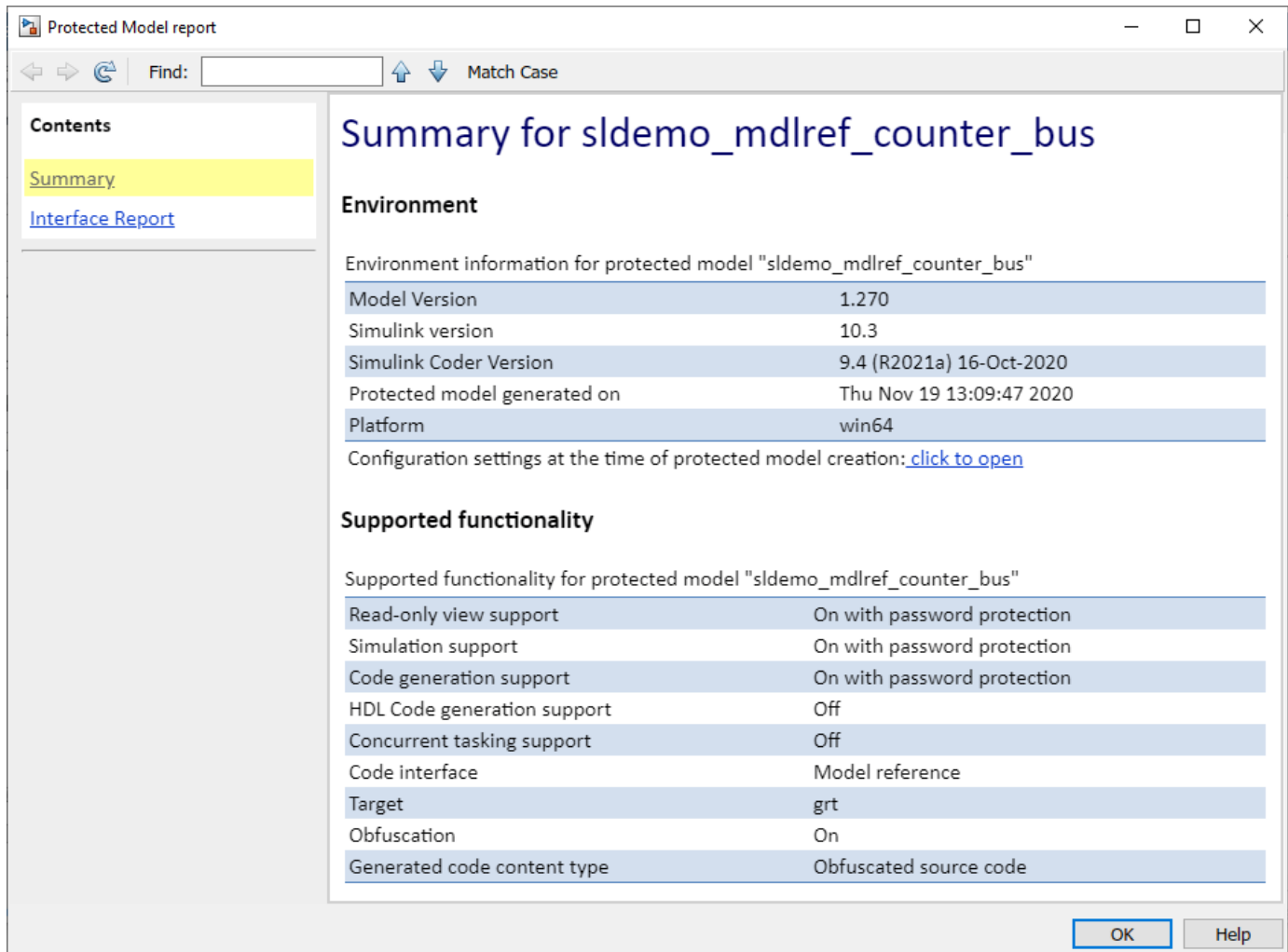

See Also

`Simulink.ModelReference.protect`

Related Examples

- "Protect Models to Conceal Contents" (Simulink Coder)
- "Package and Share Protected Models" (Simulink Coder)
- "Reference Protected Models from Third Parties"

Model Reference Variants

This example shows how to use model reference variants. A Model block is used to reference one Simulink® model from another Simulink model. A Variant Subsystem block can contain Model blocks as variants. A *variant* describes one of N possible modes in which a Variant Subsystem block can operate. Each variant references a specific model with its associated model-specific arguments. For a given Variant Subsystem block, only one variant is active during simulation. You can switch the active variant by changing the values of variables in the base workspace or by manually overriding variant selection using the Variant Subsystem block dialog box.

Switching Active Variants

The `sldemo_mdref_variants` model contains a Variant Subsystem block named Controller that references two models.

```
open_system('sldemo_mdref_variants')
```

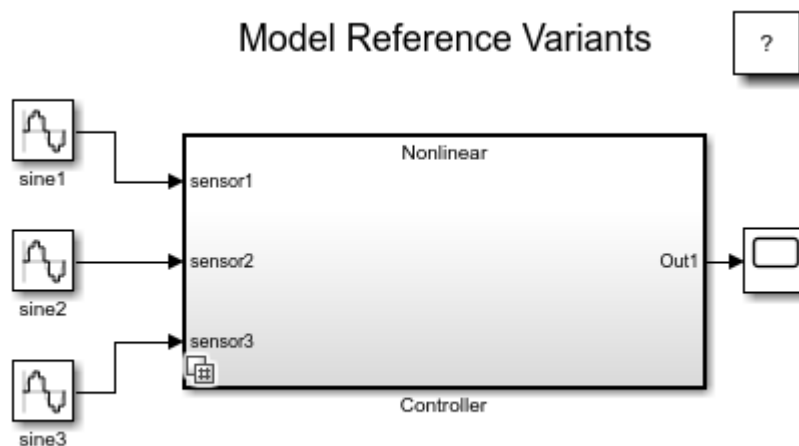

Copyright 2009-2020 The MathWorks, Inc.

To see the variant choices, right-click the Variant Subsystem block named Controller and select **Block Parameters (Subsystem)**. The active variant is determined by the value of the CTRL variable in the MATLAB® base workspace. Defining CTRL=1 activates the Model block named Linear, and defining CTRL=2 activates the Model block named Nonlinear.

Opening the `sldemo_mdref_variants` model runs the **PreLoadFcn** model callback, which sets CTRL to 2.

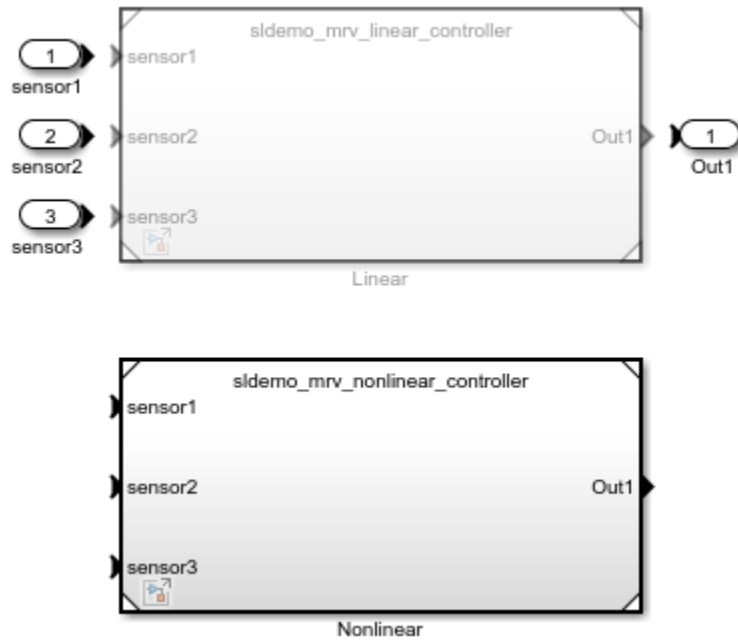

To simulate using the linear controller, define CTRL=1 in the base workspace, then simulate the model.

```
CTRL=1;
sim('sldemo_md1ref_variants');
```

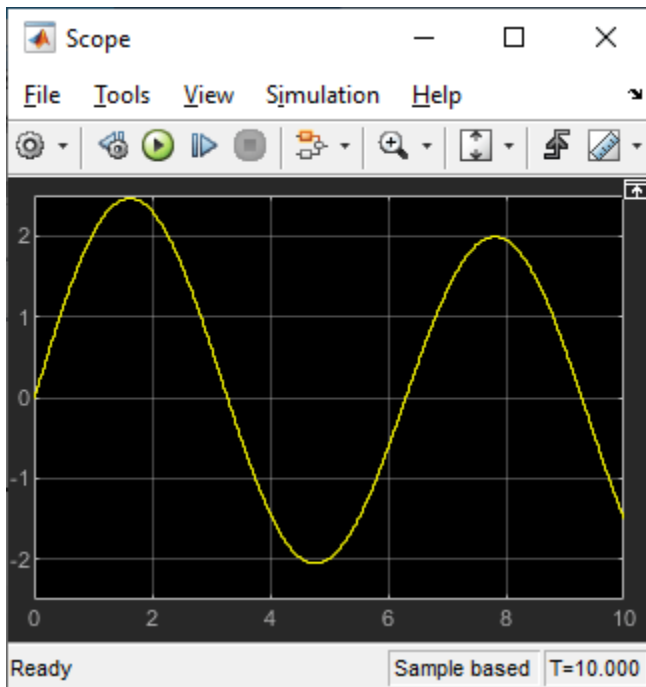

To simulate using the nonlinear controller, define CTRL=2 in the base workspace, then simulate the model.

```
CTRL=2;
sim('sldemo_mdref_variants');
```

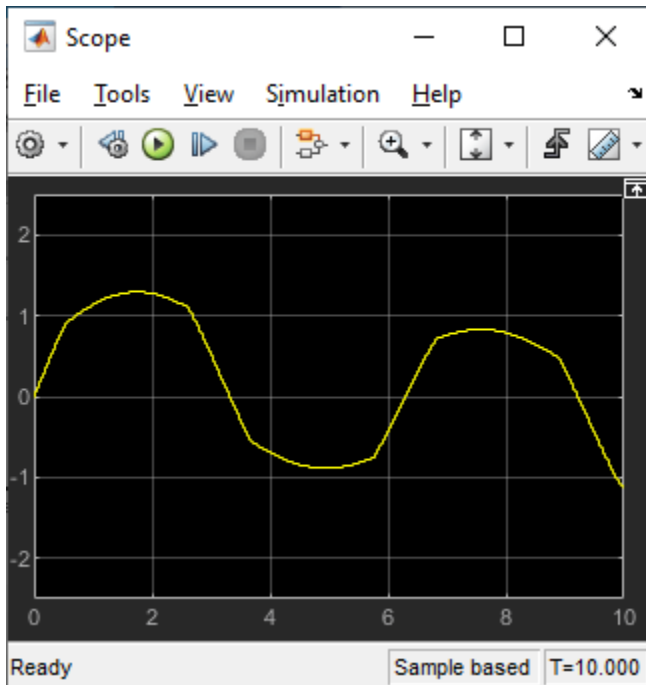

Enumerations and Reuse

The `sldemo_mdref_variants_enum` model demonstrates `Simulink.Variant` object capabilities:

- **Enumerations:** MATLAB enumeration classes can be used to improve the readability of the conditions of the `Variant` object.
- **Reuse:** `Variant` objects can be reused in different `Variant Subsystem` blocks.

The `Variant Subsystem` blocks in this model require the following variables be defined in the MATLAB base workspace:

- `VE_LINEAR_CONTROLLER = Simulink.Variant('E_CTRL==sldemo_mrv_CONTROLLER_TYPE.LINEAR')`
- `VE_NONLINEAR_CONTROLLER = Simulink.Variant('E_CTRL==sldemo_mrv_CONTROLLER_TYPE.NONLINEAR')`
- `E_CTRL = sldemo_mrv_CONTROLLER_TYPE.LINEAR`
- `VE_PROTOTYPE = Simulink.Variant('E_CURRENT_BUILD==sldemo_mrv_BUILD_TYPE.PROTOTYPE')`
- `VE_PRODUCTION = Simulink.Variant('E_CURRENT_BUILD==sldemo_mrv_BUILD_TYPE.PRODUCTION')`
- `E_CURRENT_BUILD = sldemo_mrv_BUILD_TYPE.PRODUCTION`

Each variant is associated with a `Simulink.Variant` object that uses either the `sldemo_mrv_BUILD_TYPE.m` or `sldemo_mrv_CONTROLLER_TYPE.m` enumeration class.

The `Variant` objects have a `Condition` property that is an expression. The expression evaluates to a Boolean and determines which variant is active. The expression can consist of scalar variables,

enumerations, equality, inequality, &&, ||, and ~. Parenthesis () can be used for precedence grouping. Variables may be standard MATLAB variables or Simulink.Parameter objects.

Opening the model `sldemo_mdhref_variants_enum` runs the **PreLoadFcn** model callback. This callback is set up to populate the base workspace with the variables required by the Variant Subsystem blocks.

```
open_system('sldemo_mdhref_variants_enum')
```

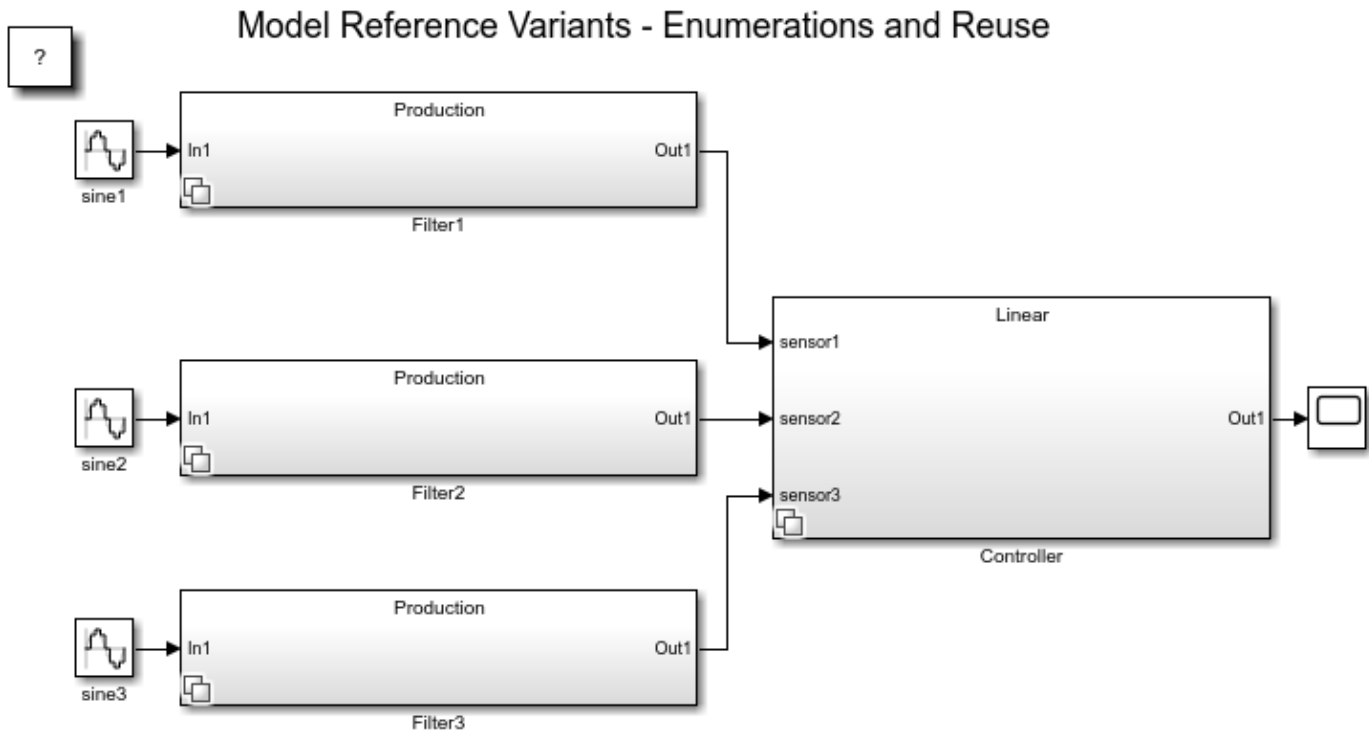

Copyright 2009-2017 The MathWorks, Inc.

The `VE_PROTOTYPE` and `VE_PRODUCTION` Variant objects are reused across the Variant Subsystem blocks named Filter1, Filter2, and Filter3.

The Block Parameters dialog box of the Variant Subsystem blocks show the **Condition** property of the related Variant objects.

See Also

Subsystem | Model | Variant Subsystem, Variant Model

More About

- “What Are Variants and When to Use Them”
- “Component-Based Modeling Guidelines”

Assigning Tasks to Cores for Multicore Programming

This example shows how to take advantage of executing code on a multicore processor by graphical partitioning. This example requires Simulink Coder™ to generate multithreaded code.

Introduction

Multicore programming allows you to make use of the processing power of modern multicore processors to create high-performance applications. Simulink™ allows you to take advantage of multicore programming by allowing you to graphically partition your algorithms and to assign the code generated from those partitions to parallel threads on your multicore processor.

The parallel threads are typically scheduled by an operating system, assigning threads to cores dynamically. This allows the scheduler to make good use of the cores while providing a notion of fairness. However, in many applications, you may need additional control on how the cores are used or you may want to dedicate a set of cores to specific logic, for example to improve determinism. This level of control is achievable through graphical partitioning and is illustrated in this example.

Try the Example

A typical situation for multicore consists of a multi-rate model for which you want to assign code for the fast rates to one core and the code for the slower rates to other cores. This may allow you to add more logic to these faster rates or to achieve more determinism. More generally, you may want to dedicate cores to application logic with the greatest demand on resources. To begin, open the multicore project:

slexMulticoreExample

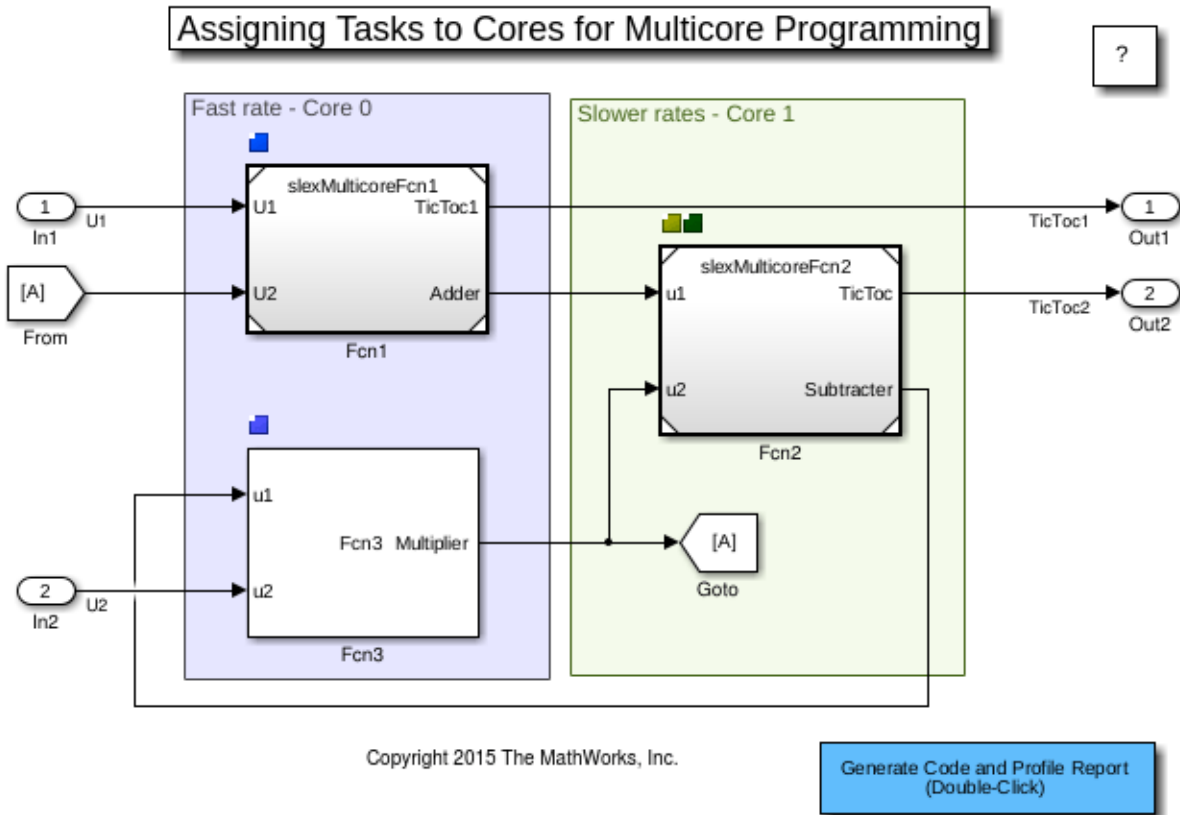

Copyright 2015 The MathWorks, Inc.

Generate Multithreaded Code

This application model is already partitioned into four concurrent tasks through the Concurrent Execution dialog which you may access from the Solvers pane of the model's Configuration Parameters. Use this dialog to specify logic, task and core assignments. In this example, we have partitioned the application logic as:

| Name | TriggerType | Period |
|-------------|-------------|--------|
| Block: Fcn1 | | |
| Core1:Task1 | Periodic | .1 |
| Block: Fcn2 | | |
| Core2:Task4 | Periodic | .4 |
| Core2:Task3 | Periodic | .2 |
| Block: Fcn3 | | |
| Core1:Task2 | Periodic | .1 |

Double-click on the 'Generate Code and Profile Report' button to generate multi-threaded code, and profile its execution. This action runs and instruments the generated executable and produces both profiling results and a core occupancy map, the latter illustrated below. The illustration shows how the cores were utilized at each time step of execution. In this example, the first core was used for the fast rates (Task1 and Task2) and the second core was used for the slower rates (Task3 and Task4).

You may go back to the Concurrent Execution dialog to try out different core assignments. In particular, you may try to specify no core affinity by leaving the 'Affinity' property as '[]'. This is the default setting which allows Simulink™ to generate multi-threaded code suitable for dynamic scheduling on your multicore processor.

| Clock Tick / Task | 0 | 10 | | | | | | | | | | | | | | | | | | 19 | | |
|-----------------------|---|----|----|----|---|----|----|----|---|----|----|----|---|----|----|----|---|----|----|----|---|----|
| Task1 | 0 | 0 | 0 | 0 | 0 | 0 | 0 | 0 | 0 | 0 | 0 | 0 | 0 | 0 | 0 | 0 | 0 | 0 | 0 | 0 | 0 | |
| Task2 | 0 | 0 | 0 | 0 | 0 | 0 | 0 | 0 | 0 | 0 | 0 | 0 | 0 | 0 | 0 | 0 | 0 | 0 | 0 | 0 | 0 | 0 |
| Task3 | 1 | NR | 1 | NR | 1 | NR | 1 | NR | 1 | NR | 1 | NR | 1 | NR | 1 | NR | 1 | NR | 1 | NR | 1 | NR |
| Task4 | 1 | NR | NR | NR | 1 | NR | NR | NR | 1 | NR | NR | NR | 1 | NR | NR | NR | 1 | NR | NR | NR | 1 | NR |

See Also

Related Examples

- “Concepts in Multicore Programming”

Implement an FFT on a Multicore Processor and an FPGA

This example shows you how to take advantage of a multicore processor target with FPGA acceleration by graphically partitioning a model. This example requires Simulink Coder™ to generate multi-threaded code and HDL Coder™ to generate HDL code. You cannot generate HDL code on Macintosh systems.

Introduction

Several modern processors include multicore processors integrated with FPGA components to create high-performance applications. These require multicore and FPGA programming, including programming of parallel threads, HDL, and communication interfaces between the cores of the system. Simulink™ allows you to take advantage of these approaches by graphically partitioning your algorithms and by assigning the software generated from those partitions to threads on your processor and to modules on your FPGA. The example uses one application level model to generate one executable, consisting of multiple threads and HDL code, to take advantage of the hardware parallelism of the FPGA. This is illustrated in the figure below.

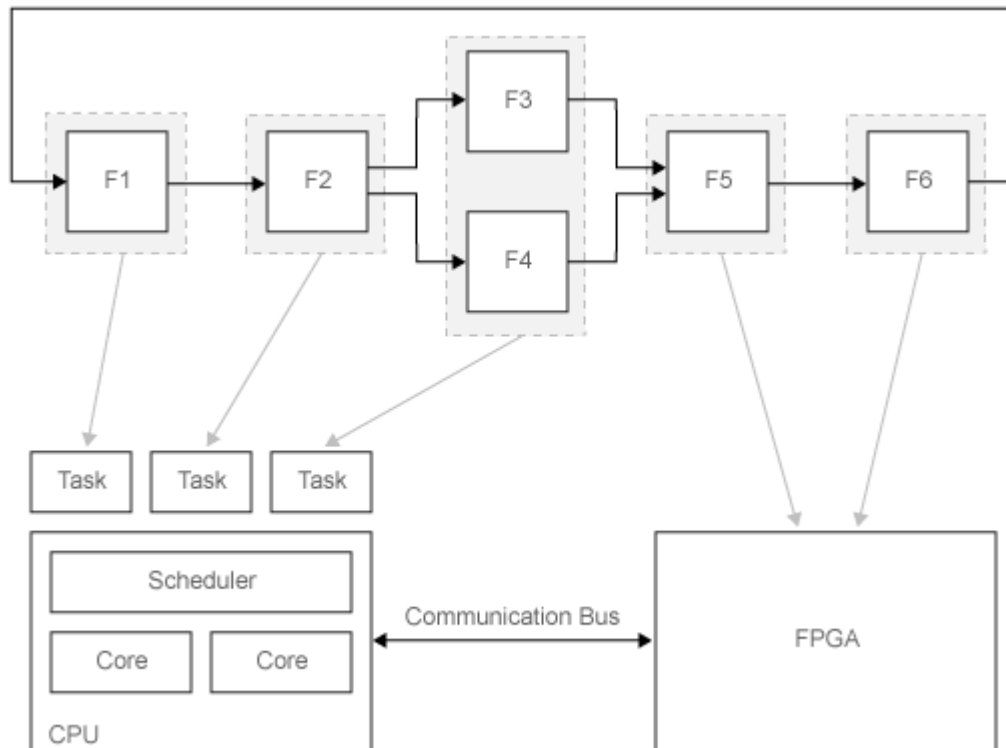

Example Model

Load the example model:

```
slexMulticoreFPGAExample
```

Implement an FFT on a Multicore Processor and an FPGA

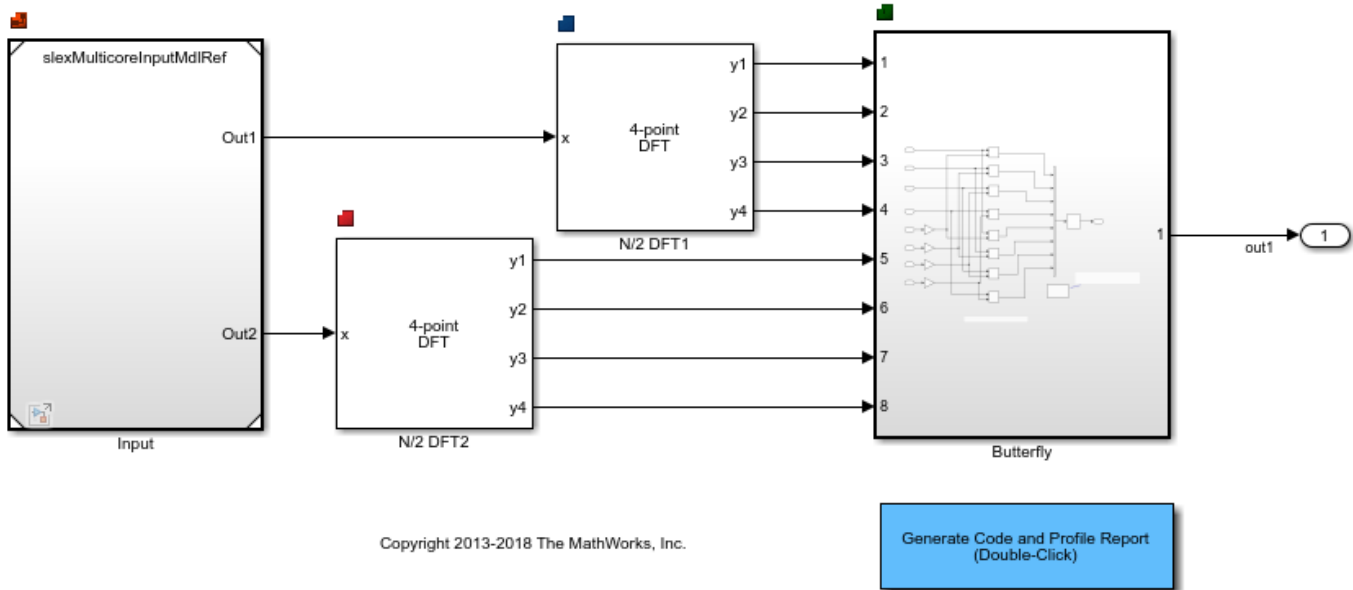

Architecture Definition

All concurrent execution settings for this model can be accessed in the Concurrent Execution dialog box (Configuration Parameters>Solvers>Configure Tasks).

The first step to implement our algorithm is to define structural elements of our target architecture. This includes structural elements of the hardware, such as the number and type of processing nodes (CPU, FPGA) and the communication channels (AXI, PCI).

This also includes software settings in the model's Configuration Parameters (e.g. System Target File, hardware Implementation, data transfer settings). In this example we have selected the pre-configured target architecture 'Sample architecture'. This architecture uses your desktop as a stand-in for the deployment process.

Software Node

Hardware Nodes

Simulation and Code Generation Options

Preconfigured Target Architectures including Simulink Real-Time and Zynq

Partitioning and Mapping the Model

Partition the model to decide which functions run sequentially and which run concurrently.





The example model is partitioned explicitly, consisting of MATLAB System blocks, a Model block, an Atomic Subsystem and an Outport block. Explicit partitioning creates partitions based on these blocks at the root-level of the model. Implicit partitioning, on the other hand, creates partitions based on the block sample times and other scheduling constraints.

After partitioning the model, you can map partitions to CPU tasks and FPGA nodes. You can change the mapping for design space exploration, through the GUI or the API. During mapping, signals will be auto-mapped to channels.

You can change how the blocks are mapped to the threads and to the FPGA in the Concurrent Execution dialog box. For more information, see “Optimize and Deploy on a Multicore Target”.

Map blocks to tasks

Refresh mapping table (*invokes update diagram) 

| Name | TriggerType | Period | Autogenerated |
|--|-------------|--------|---------------|
| Block: Butterfly | | | |
|  Butterfly | Periodic | 0.2 | No |
| Block: Input | | | |
|  FPGA2 | FPGA | | No |
| Block: N//2 DFT1 | | | |
|  DFT:DFT1 | Periodic | .2 | No |
| Block: N//2 DFT2 | | | |
|  DFT:DFT2 | Periodic | .2 | No |

Generate Multithreaded and HDL Code

Double-click on the 'Generate Code and Profile Report' button to generate multithreaded code. In this example, the host computer replaces the target environment. C code is generated for blocks mapped to processor tasks. This code is organized using threads native to the desktop machine. The code snippet shows how threads are created. In addition, HDL code is generated for blocks mapped to hardware nodes. The code snippet below illustrates how the module/entity is created in VHDL.

Host
Computer
Code

```
int main(int argc, char *argv[])
{
    /* Create periodic threads */
    for (i = 0; i < 2; i++) {
        periodicThread[i].index = (int_T) i;
        periodicThread[i].exitFlag = 0;

        /* Create the events that will be used by the thread */
        periodicThread[i].startEvent = CreateEvent(NULL, false, false, NULL);
        periodicThread[i].stopEvent = CreateEvent(NULL, false, true, NULL);

        /* Create the thread in suspended mode */
        periodicThread[i].threadHandle = (HANDLE) beginthreadex(NULL, 0,
            &periodicTask, &periodicThread[i], CREATE_SUSPENDED, &periodicThread[i].
            threadID);
    }
}
```

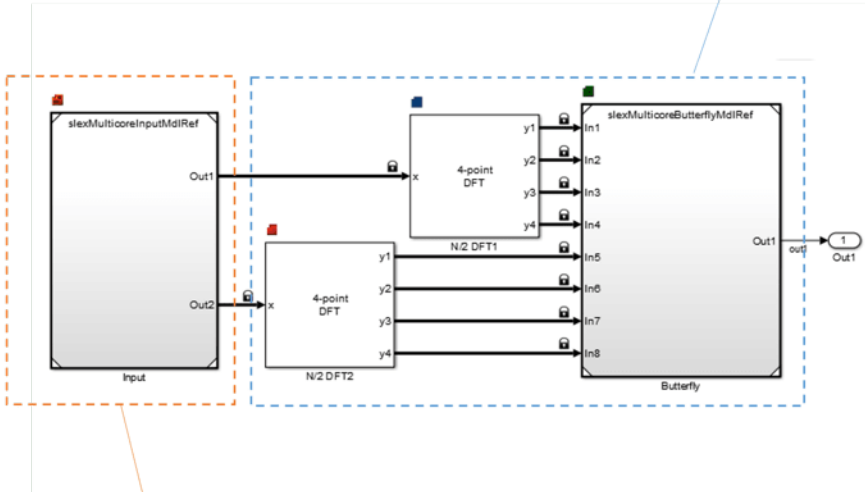

VHDL

```
ARCHITECTURE rtl OF slexMulticoreInputMdlRef IS
    -- Component Declarations
    COMPONENT Input
        PORT ( x
            ) : OUT vector_of_std_logic_vector32(0 TO 1023) -- int32 [1024]
    END COMPONENT;

    -- Component Configuration Statements
    FOR ALL : Input
        USE ENTITY work.Input (rtl);

    -- Signals
    SIGNAL x
        : vector_of_std_logic_vector32(0 TO 1023); -- ufix32 [1024]
    SIGNAL Mux_out1
        : vector_of_std_logic_vector32(0 TO 511); -- ufix32 [512]
    SIGNAL Mux1_out1
        : vector_of_std_logic_vector32(0 TO 511); -- ufix32 [512]
```

```
close_system('slexMulticoreFPGAExample',0);
```

Multicore Programming of a Field-Oriented Control on Zynq

This example demonstrates how to implement a control algorithm containing multiple rates on Zynq. To take advantage of both the cores and the FPGA hardware, the example uses graphical partitioning approach such that code from different partitions are distributed across the cores and the hardware.

Introduction

In this example, we show a workflow for generating code for a motor control algorithm, and testing the generated code on a Xilinx® Zynq™-7000 SoC ZC702 evaluation board. The motor control algorithm in the example is a Field-Oriented Control algorithm composed of a speed controller (fast component) and a torque controller (slow component). One typical workflow is to generate code for these two components of the controller, upload the generated code to an evaluation board, and then connect the evaluation board to a real-world motor. This workflow is illustrated in the block diagram below.

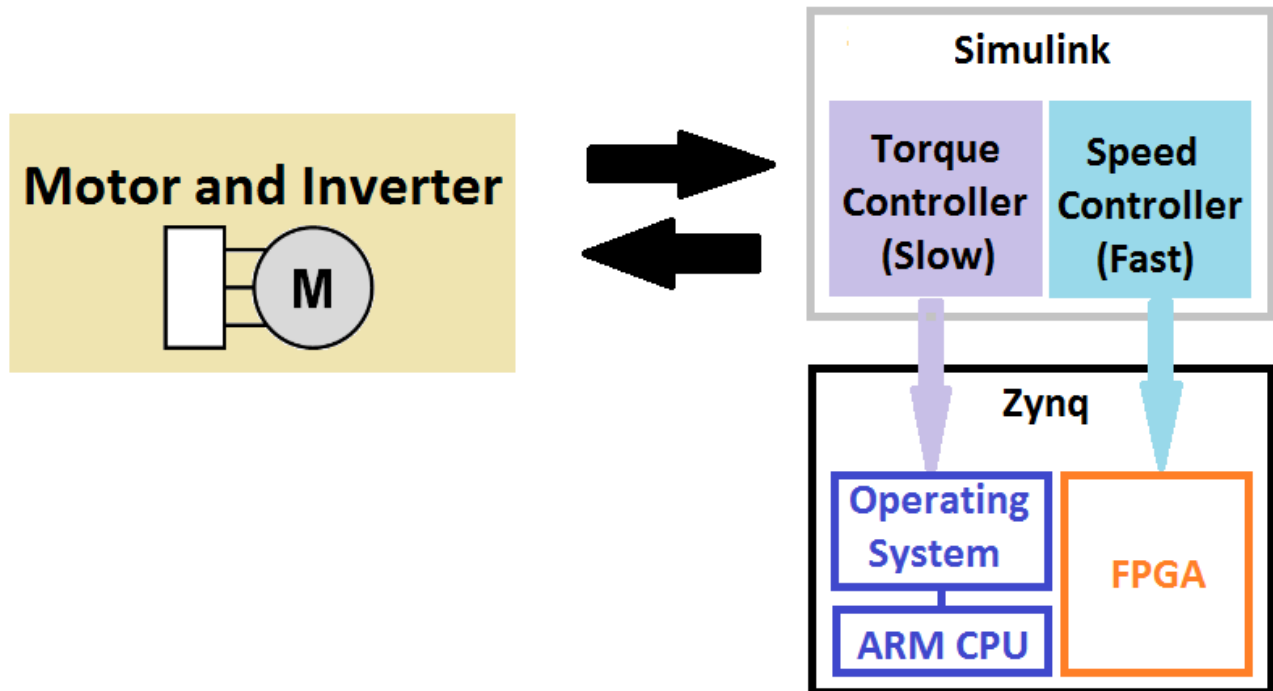

In order for this example to be self-contained, and since there is redundant computer power on the target processor, we model the motor using one of the tasks of the CPU of the evaluation board.

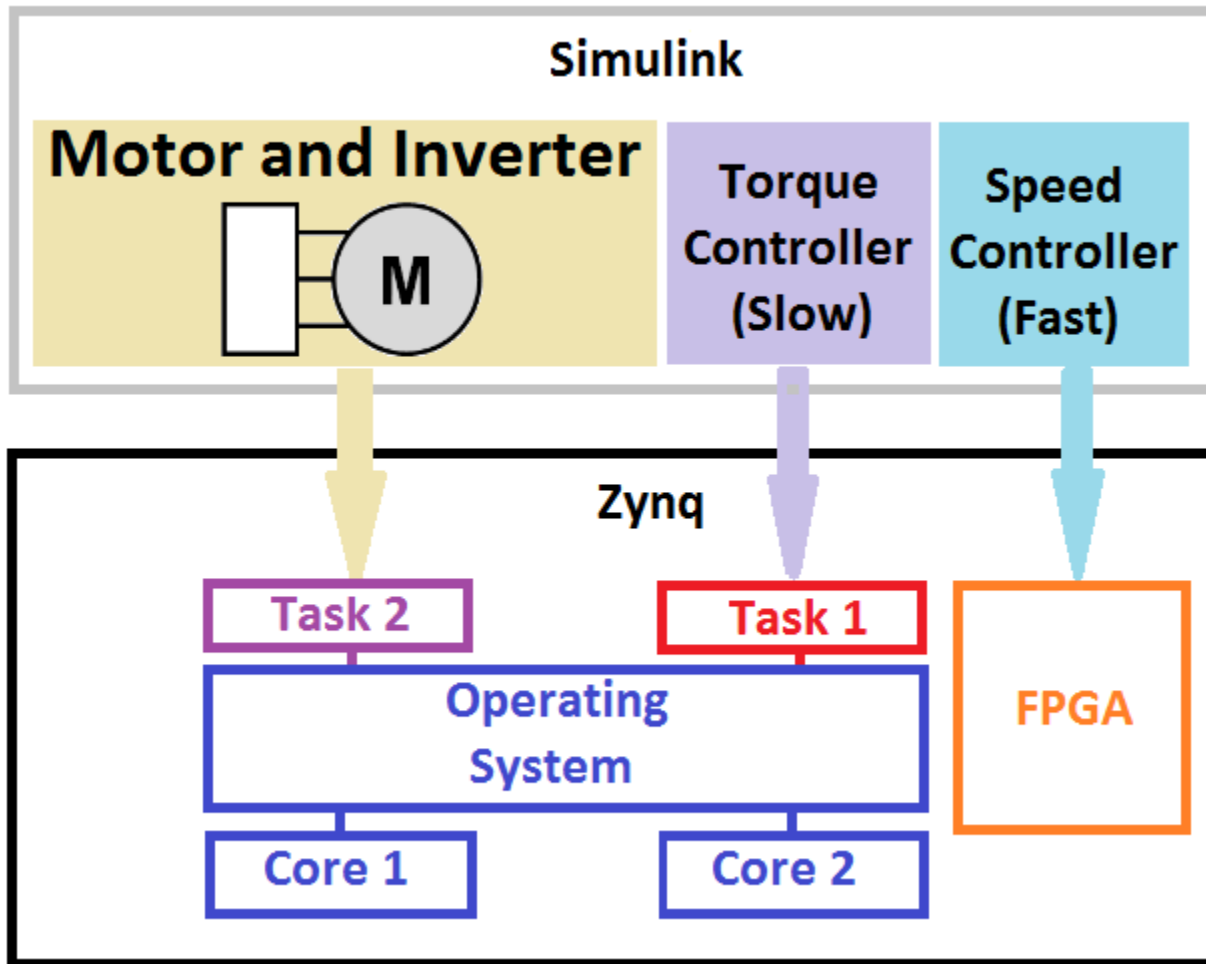

The example assumes that a Xilinx® Zynq™-7000 SoC ZC702 evaluation board is connected to your computer. You can find the connection and installation steps in the “Install Support for Xilinx Zynq Platform” (Embedded Coder Support Package for Xilinx Zynq Platform) documentation.

This example requires Embedded Coder™ to generate multi-threaded code, HDL Coder™ to generate HDL code, and Simscape Power Systems™ to model the permanent magnet synchronous machine in the example. You cannot generate HDL code on Macintosh systems.

Example Model

The example model consists of two Simulink areas. In the Permanent Magnet Synchronous Machine area, there are two blocks: "Speed and Torque Inputs" block which provides the reference inputs to the feedback system, and "Invertor and Motor" block which is the plant we aim to control in this example. The "Invertor and Motor" block also contains peripherals: a scope that can be used for investigating the simulation results and a UDP sender. The generated code for the UDP sender is responsible for sending the simulation data from the Zynq ZC702 evaluation board to the host machine. The Field-Oriented Control contains the controller blocks "Speed controller" and "Torque controller". To load the model, enter

```
slexFocZynqExample
```

Multicore Programming of a Field-Oriented Control on Zynq

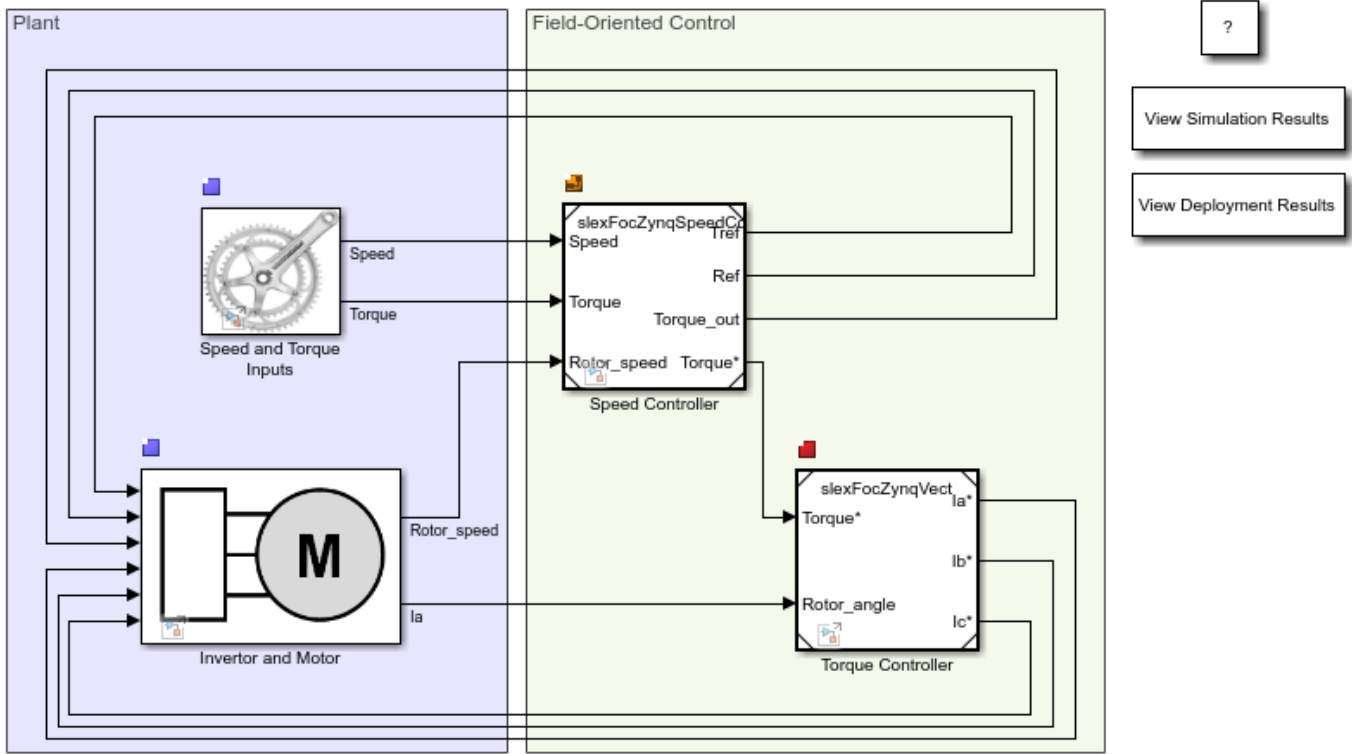

Copyright 2015 - 2020 The MathWorks, Inc.

Architecture Definition

The target architecture in the example is Xilinx Zynq ZC702 evaluation kit. This can be verified by accessing the **Concurrent Execution** dialog box.

In the **Modeling** tab, select **Model Settings**. In the **Model Configuration Parameters** dialog box, on the **Solver** tab, select **Allow tasks to execute concurrently on target**, then click **Configure Tasks**.

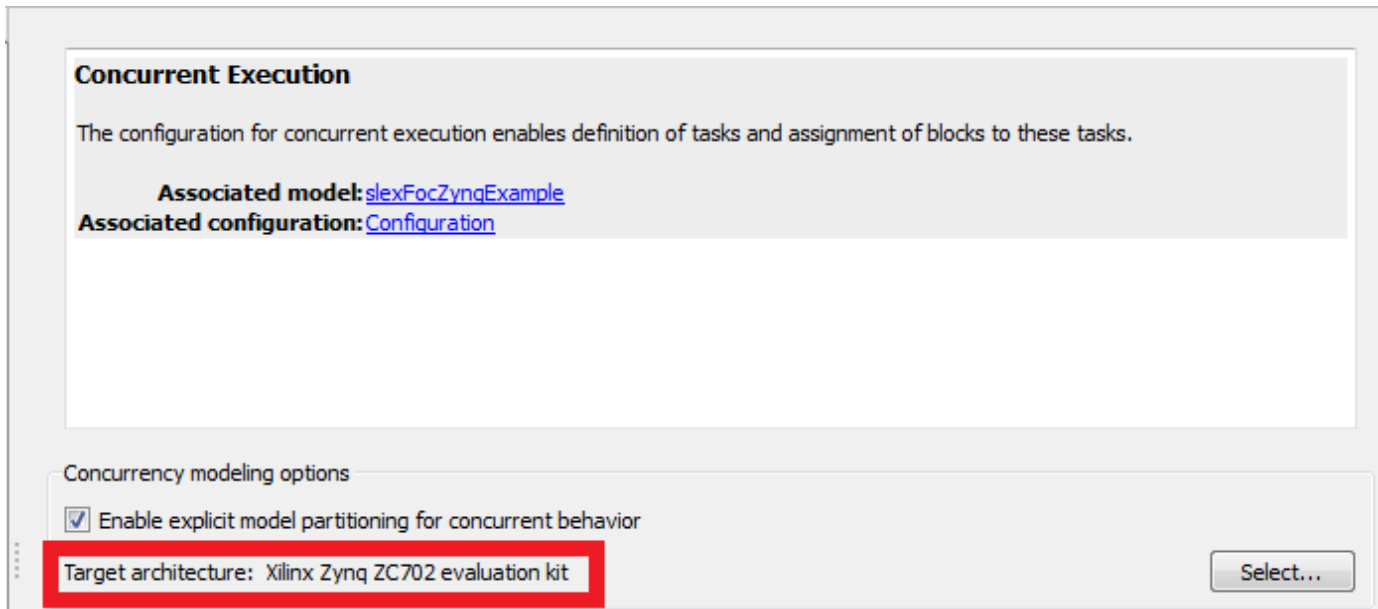

The evaluation board has an ARM Cortex-A9 CPU and a field-programmable gate array (FPGA). There are two tasks running on the ARM CPU. The "Torque controller" is mapped to the first task and the blocks that constitute the plant ("Speed and Torque Inputs" block and "Invertor and Motor") are mapped to the second task. The "Speed controller", which operates at high frequency in the control loop, is mapped to the FPGA. These settings can be changed in the "Tasks and Mapping" section of the "Concurrent Execution" dialog box.

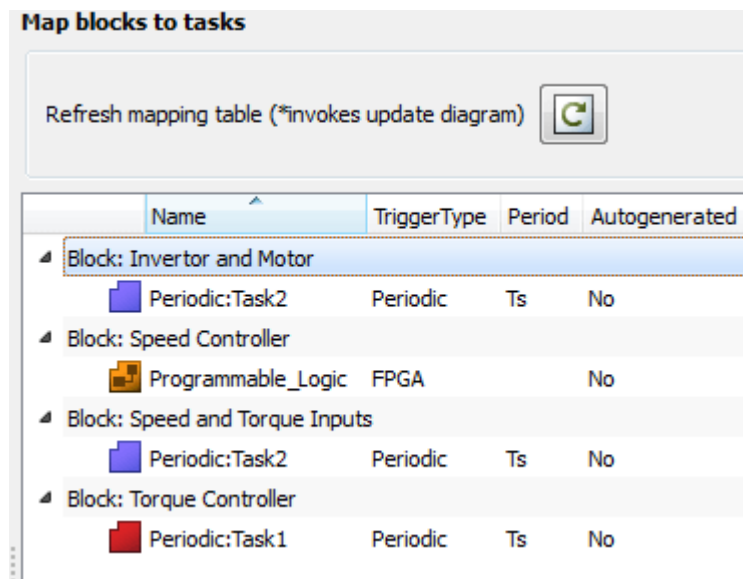

Generate Multi-threaded and HDL Code

Enter Ctrl-B or select **Deploy to Hardware** to generate the multi-threaded and HDL code. The generated executable and the FPGA bitstream will be uploaded to Zynq board automatically. This step requires that the Zynq board is connected to the computer and that the environment is set up

properly. For more information, see “Install Support for Xilinx Zynq Platform” (Embedded Coder Support Package for Xilinx Zynq Platform).

Receive Data from the Zynq

Open the scope by selecting **View Simulation Results**, and run the simulation to obtain the following output:

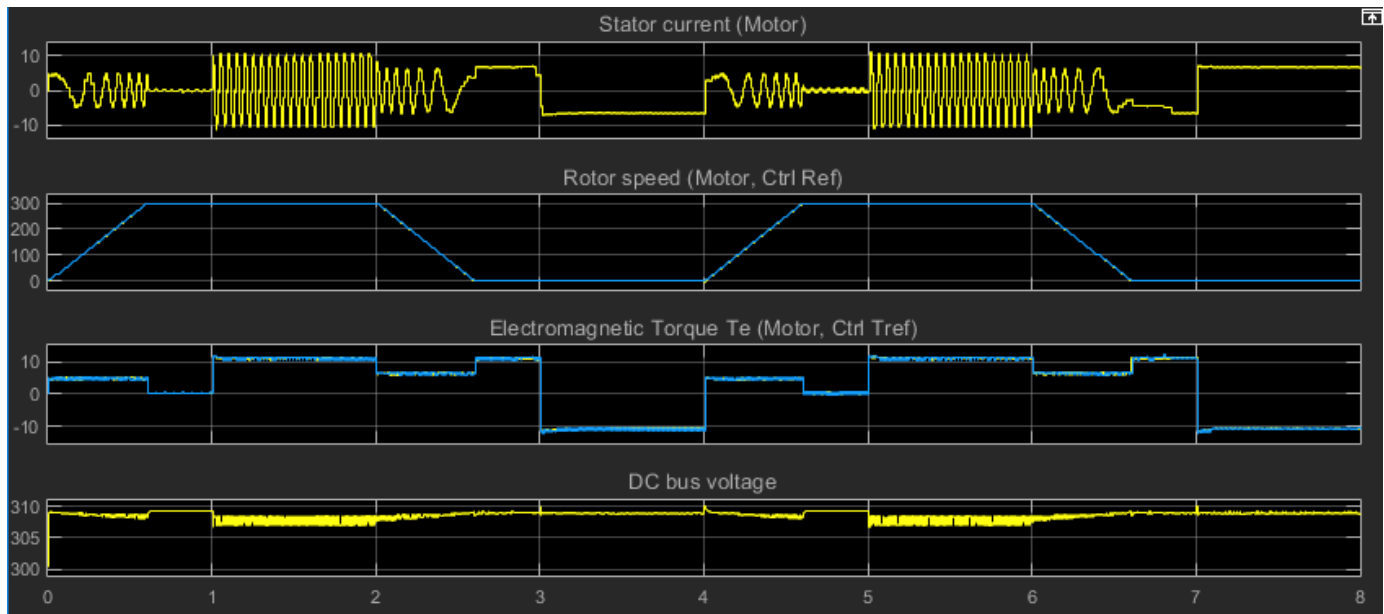

Compare this simulation output with the output of the executable that runs on the Zynq ZC702 board. In order to make this comparison, access the UDP receiver model by selecting **View Deployment Results**. When the UDP receiver model is selected, run the simulation. The run command will send a signal to the Zynq ZC702 board to start running the executable on the board. The simulation data will be sent via UDP from the Zynq ZC702 board to the host machine. The captured UDP signal is displayed on the scope of the UDP Receiver model.

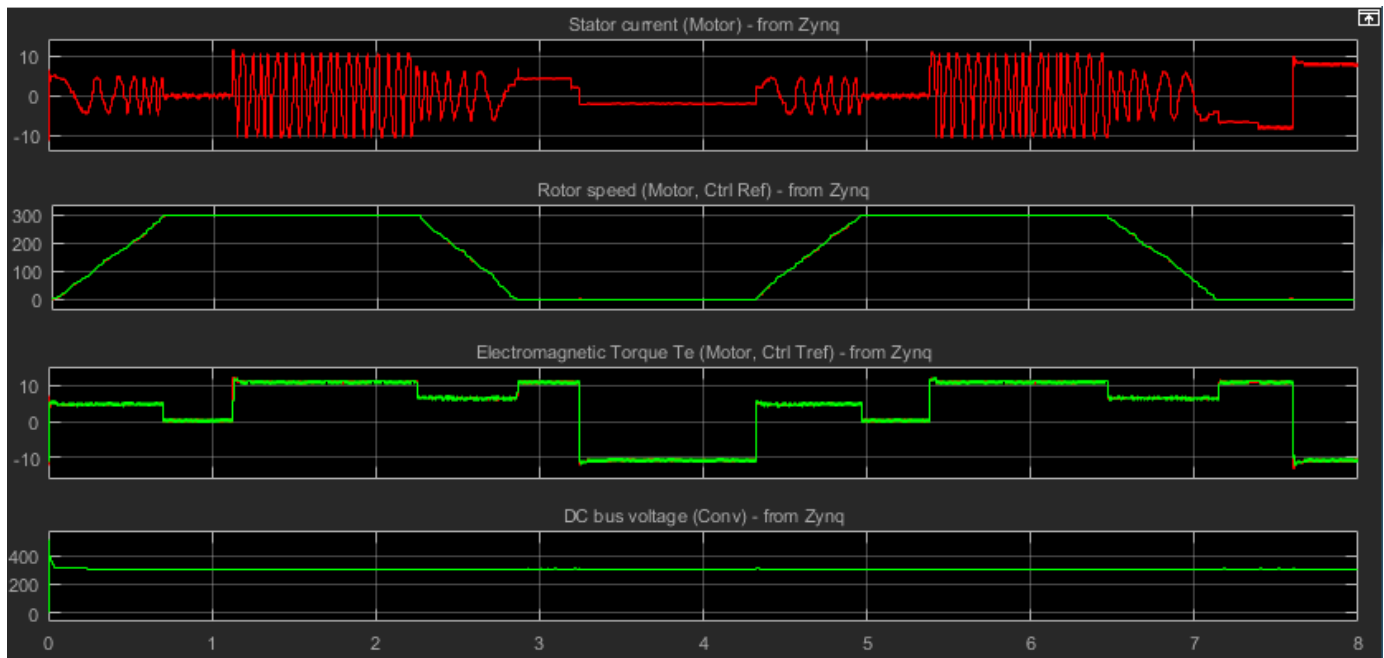

Close the Model

```
close_system('slexFocZynqExample', 0);
```

Multicore Deployment of a Plant Model

This example illustrates how to take advantage of executing multithreaded code on a multicore processor using graphical partitioning. This example requires Simulink® Coder™ to generate multithreaded code.

Overview

One objective of model-based design is to create realistic models of physical systems and to simulate these models in real-time, for example, to verify controllers using hardware-in-the-loop (HIL). However, as more features are added to the plant model, the computational requirements may exceed the resources available by single-core processing systems.

Partitioning the plant and controller into separate pieces is one way to address the computational needs of complex models. With Simulink® you can partition a plant using Model blocks and then assign the code generated by each sub-model to threads for real-time execution on an HIL system such as Simulink Real-Time™. To see how this works, let us use our host computer as a stand-in for the real-time execution environment and generate real-time multi-threaded code for the following model.

slexMulticoreSolverExample

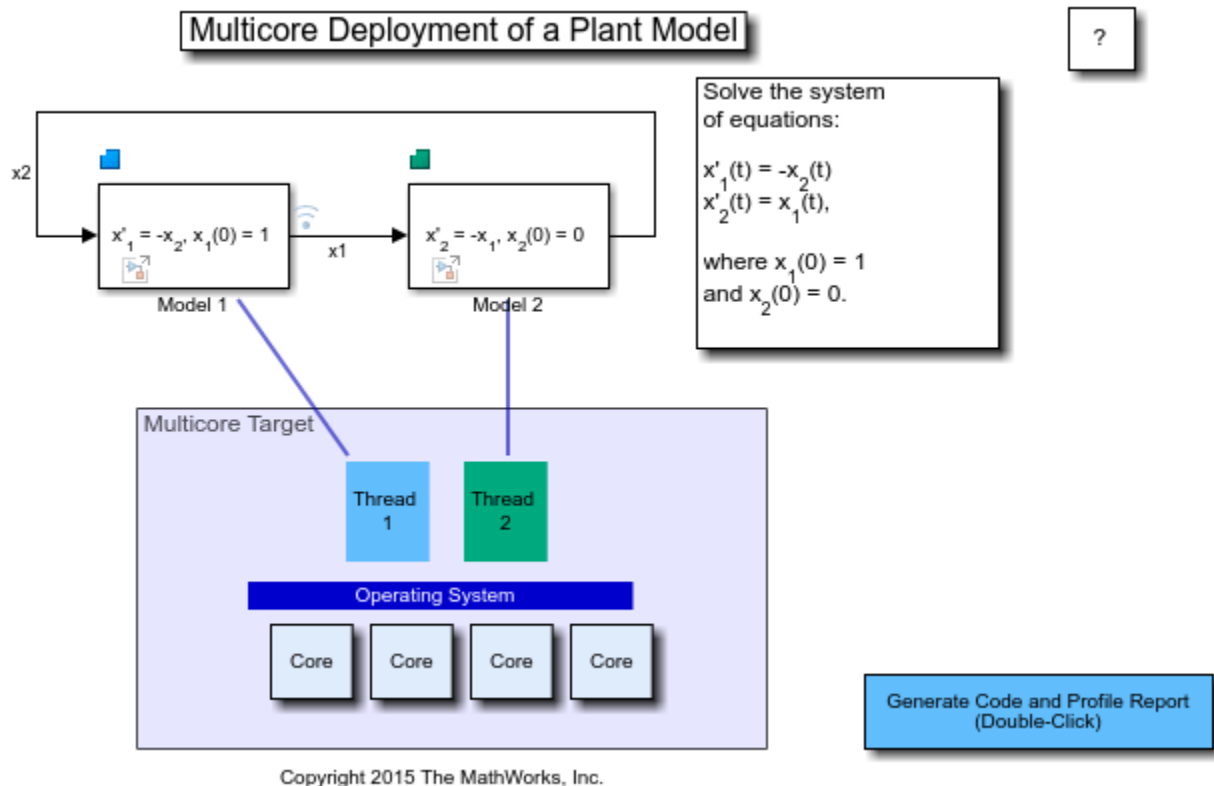

Symmetric Multicore Processing

The illustration above shows that the code generated for the model is separated into two threads. In this example, the target is assumed to be a Symmetric Multicore Processor, so that the threads are

not associated with any particular core. The operating system is responsible for making the best use of the cores when scheduling thread execution. Ideally, to provide maximum flexibility, the number of threads (Nt) should be greater than the number of cores (Nc). Double-click on the 'Generate Code and Profile Report' button to generate multi-threaded code, profile its execution and visualize the results. The visualization shows a core occupancy map of how the cores were utilized at each time step of execution. It can be seen that the threads float across cores as deemed best by the operating system scheduler. This kind of scheduling is good when the operating system also needs to run other processes.

| Clock Tick / Task | 0 | 10 | 19 |
|-------------------------|--|----|----|
| Thread1 | 14 6 6 12 12 14 12 12 12 4 4 0 0 4 6 8 14 10 10 12 | | |
| Thread2 | 10 2 0 0 0 0 14 14 14 2 2 14 14 2 2 0 0 0 14 4 | | |

Thread Synchronization

Simulink® Coder™ generates code such that the two threads may execute simultaneously and possibly on two different cores. This means that the signal values for x_1 and x_2 must be synchronized between the two threads. Simulink® provides several options to handle this requirement as illustrated here:

Data Transfer Options

Defaults

- Periodic signals: Ensure deterministic transfer (maximum delay)
- Continuous signals: Ensure deterministic transfer (maximum delay)
- Extrapolation method: Ensure data integrity only
- Automatically handle: Ensure deterministic transfer (maximum delay)
- Automatically handle: Ensure deterministic transfer (minimum delay)

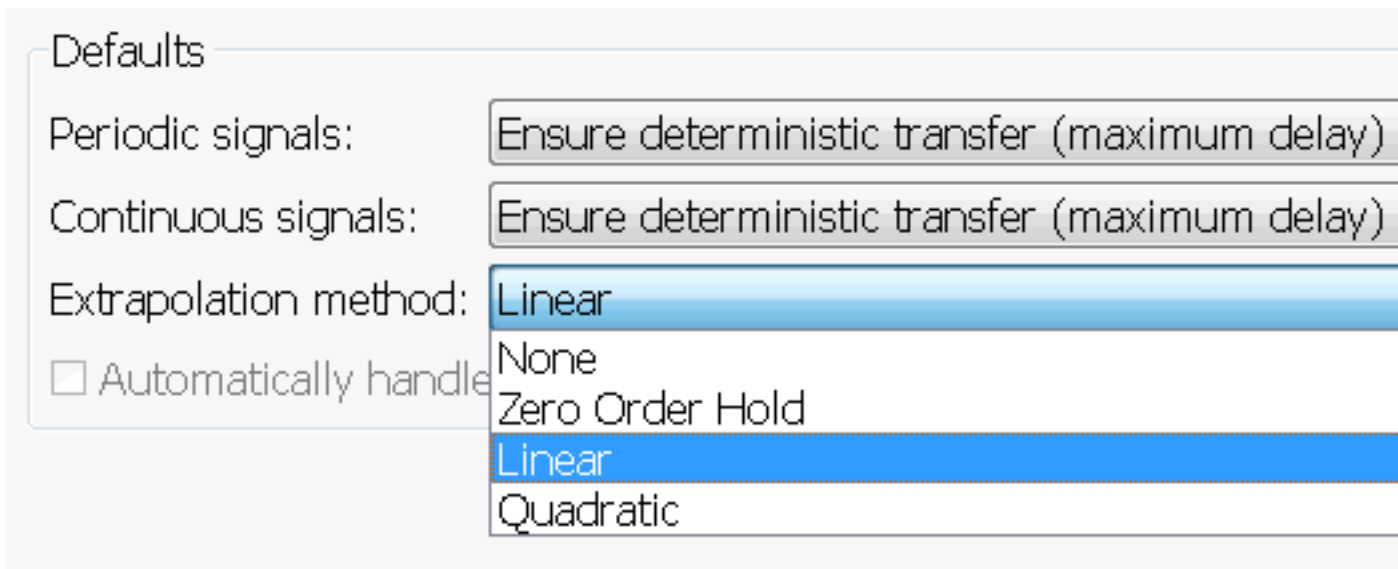

Using the script below, we will simulate and demonstrate the effect of the deterministic modes to understand how Simulink® handles synchronization.

- Reference solution (ode3) - Simulink® is configured to provide the reference solution by synchronizing data at each major and minor time step.
- Zero Order Hold - Each thread is solving a sub-system of equations using its own solver, while synchronizing data only on major time steps.
- Linear extrapolation - In addition to the Zero Order Hold mode, each solver extrapolates data using linear predictions to compensate for data latency errors.

For most systems where the synchronization points are smooth, the linear extrapolation mode provides a good tradeoff between communication bottlenecks and numerical accuracy.

```
h = figure;
hVal = ishold;
hold on;
mdl = 'slexMulticoreSolverExample';
dt = get_param(mdl, 'DataTransfer');

modes = { ...
    'Ensure deterministic transfer (minimum delay)', ...
    'None', 'k:', ...
    'Ensure deterministic transfer (maximum delay)', ...
    'Zero Order Hold', 'm', ...
    'Ensure deterministic transfer (maximum delay)', ...
    'Linear', 'b' ...
};

for i=1:3:length(modes)
dt.DefaultTransitionBetweenContTasks = modes{i};
dt.DefaultExtrapolationMethodBetweenContTasks = modes{i+1};
out = sim(mdl);
plot(out.logout.get('x1').Values.Time, ...
     out.logout.get('x1').Values.Data, ...
     modes{i+2});
end
```

```
legend('Reference solution (ode3)', ...  
      'Zero Order Hold Extrapolation', ...  
      'Linear Extrapolation');
```

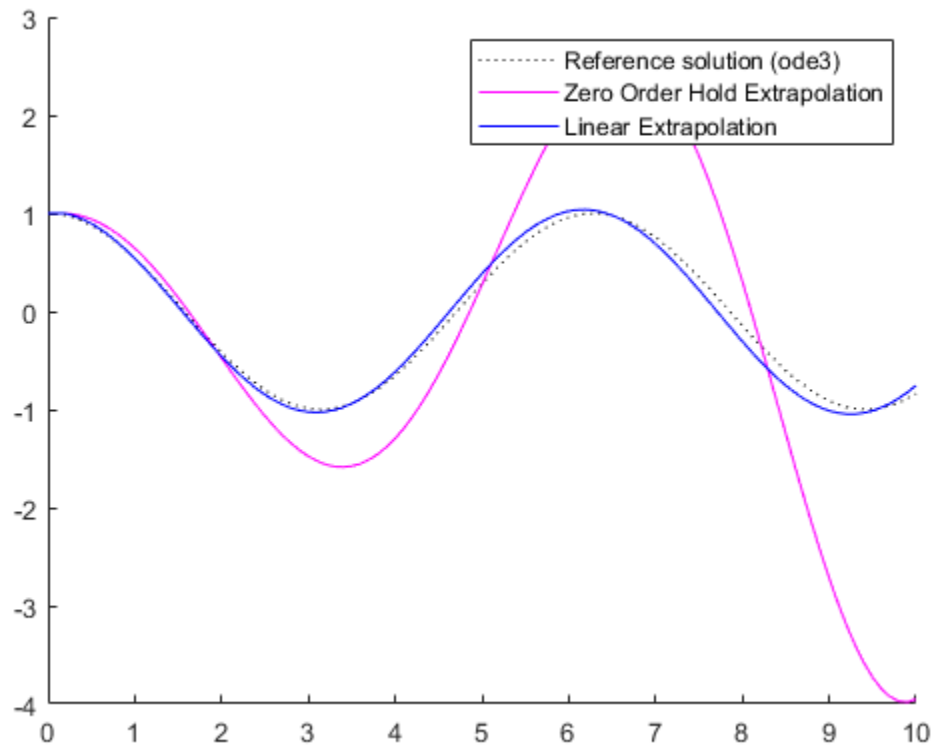

Closing the Models

```
close_system('slexMulticoreSolverExample',0);  
close_system('slexMulticoreSolverMdlref',0);  
if ~hVal, hold off; end  
delete(h);
```

Modeling Objects with Identical Dynamics Using For Each Subsystem

This example shows how to model multiple objects with identical dynamics using the For Each subsystem. The number of objects is parameterized by the length of the input signal.

This example illustrates how you can implement the model `sldemo_metro_basic`, using one For Each subsystem to model three identical metronomes and another to model the identical effect that the motion of each metronome has on the moving base.

The continuous dynamics of the three identical metronomes in `sldemo_metro_basic` are modeled in identical subsystems: `sldemo_metro_basic/Metronome1`, `sldemo_metro_basic/Metronome2`, and `sldemo_metro_basic/Metronome3`. You can represent these three subsystems as one For Each subsystem. The initial position of the metronomes is passed in as a mask parameter to the For Each subsystem, and is used as an initial condition for one of the integrators. The For Each subsystem is configured to partition this parameter along the first dimension. As a result, an input vector with three elements defines the initial positions for the three metronomes.

Exploring the Solver Jacobian Structure of a Model Base model for `sldemo_metro_foreach`

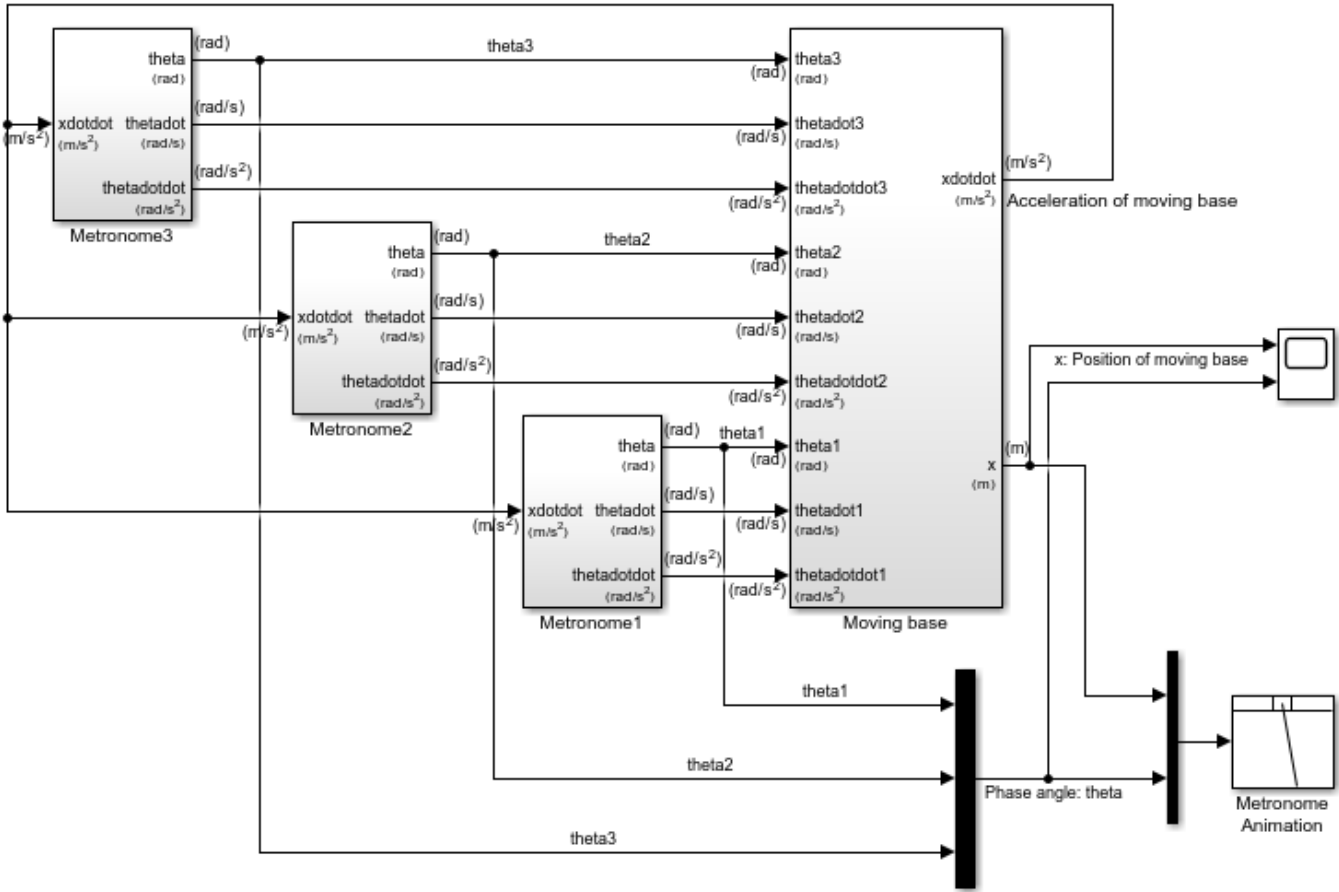

Copyright 2018 The MathWorks, Inc.

Figure 1: Metronomes modeled using three subsystems with identical dynamics

Modeling Objects with Identical Dynamics using For Each Subsystem

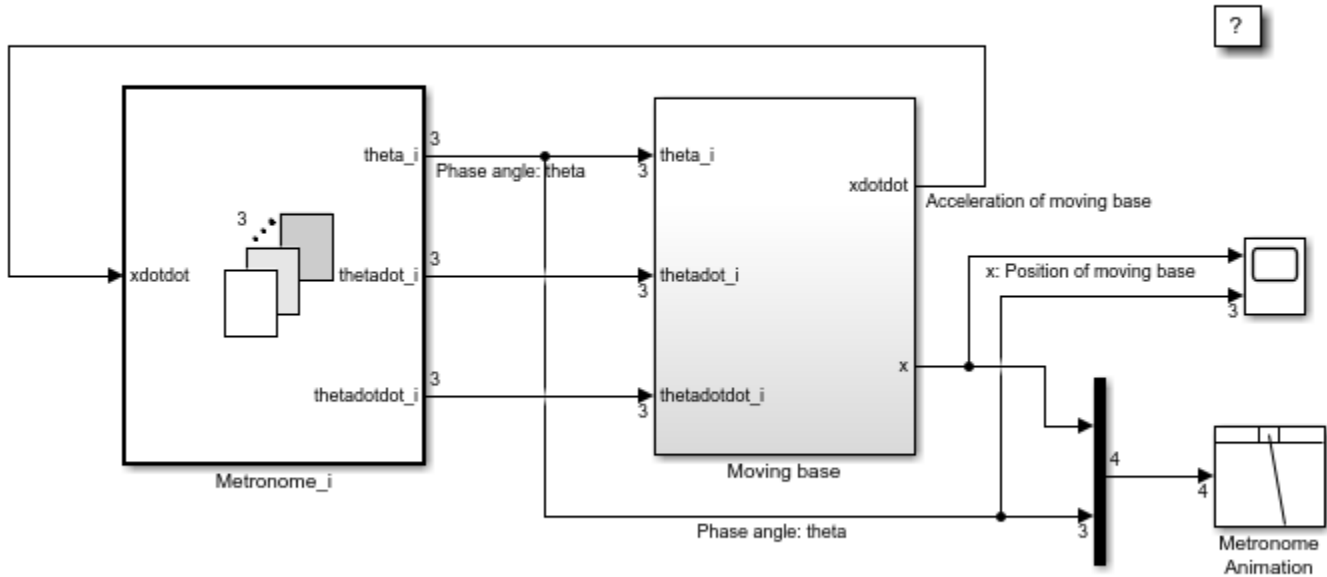

Copyright 2011-2014 The MathWorks, Inc.

Figure 2: Metronomes modeled using one For Each subsystem

On examining the dynamics of the moving base, note that it involves three identical second-order differential terms corresponding to each metronome. You can replace the three copies with one For Each Subsystem. Instead of nine input signals, the For Each subsystem requires only three input signals: the angular displacements, the angular velocities, and the angular accelerations for all metronomes. The For Each subsystem is configured to partition the input signal along the first dimension and operates on one element from each signal for one iteration (i.e. one metronome).

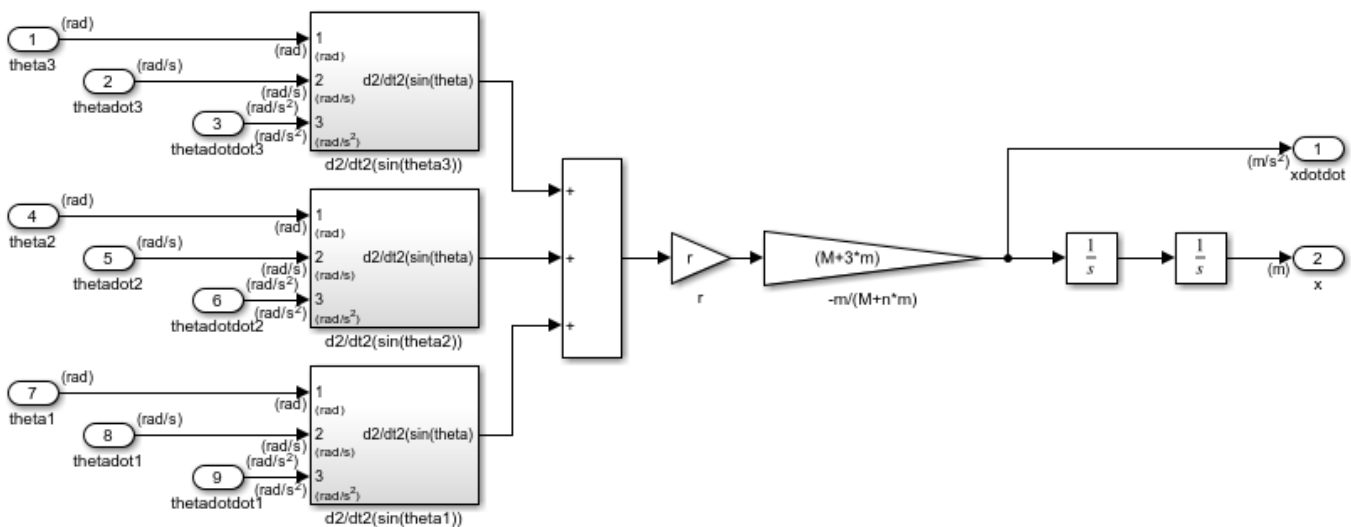

Figure 3: Second-order differential terms modeled using copies of the same subsystem

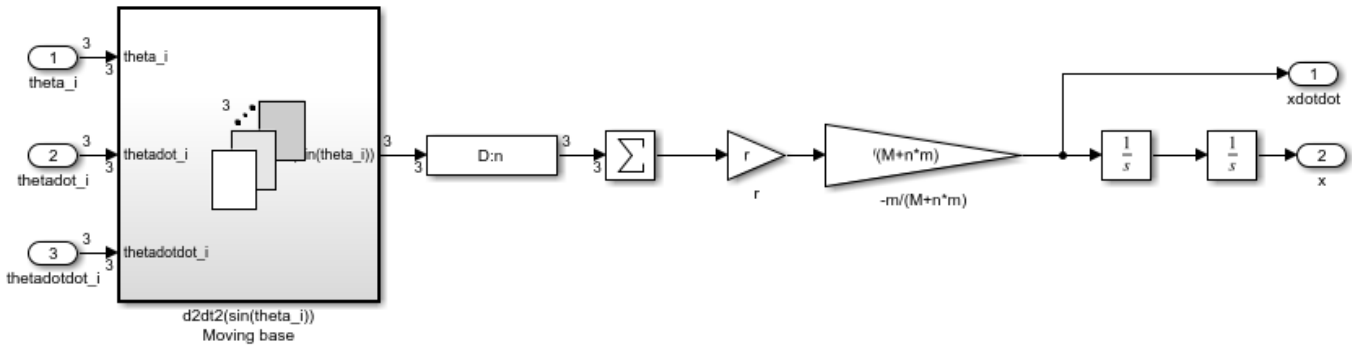

Figure 4: Second-order differential terms modeled using one For Each subsystem

After implementing the original model with two For Each subsystems, the model is now parameterized for the number of metronomes. To increase the number of metronomes, introduce a new value to the mask parameter.

For example:

Theta4 = 0.7568;

Double-click on the Metronome_i block to open the mask dialog and change Input Positions (Partitioned) to: [Theta1 Theta2 Theta3 Theta4]

Execute the model to see the displacement angles of the four metronomes and the position of the moving base.

```
sim('sldemo_metro_foreach');
```

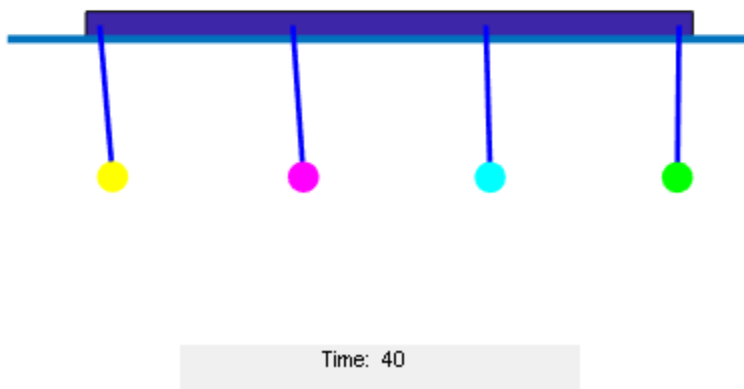

Figure 5: Simulation animation with For Each subsystem parameterized for four metronomes

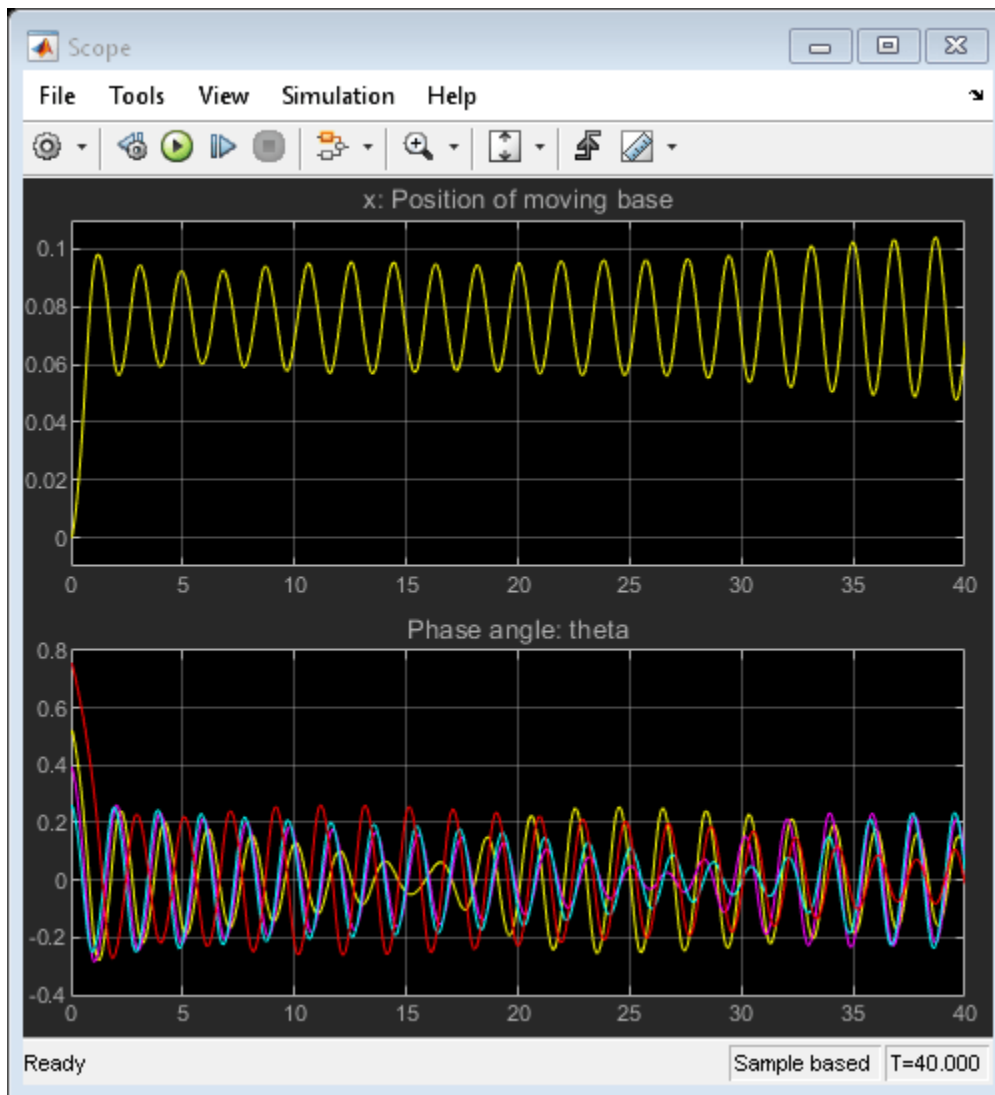

Figure 6: Simulation result with For Each subsystem parameterized for four metronomes

Vectorizing a Scalar Algorithm with a For Each Subsystem

This example shows how to use the For Each subsystem. In this example the operations are performed on a vector for simplicity.

Use the **Open Model** button to open the example model `sldemo_foreach_vectorized`. This model contains a For Each subsystem that processes the input signals one by one.

The inputs to the For Each subsystem are the signals to process, the coefficients of the FIR filter to use with each of these signals, and the common gain.

Each signal is scalar and needs to be processed individually. Consequently, the For Each block that controls the partition dimension is set to partition the input signal along dimension 1, by slicing through a partition width of 1. For each input signal, a corresponding set of coefficients must also be partitioned using the same criteria. The gain is common to all the signals, so this input is not partitioned.

Since the output signal dimension is expected to match the input signal dimension, the concatenation dimension is set equal to the partition dimension. If you prefer to change the signal dimension (a transpose in this case), you can choose 2 as the concatenation dimension.

For the For Each subsystem, you must set the partition dimension and width, but not the input signal size. A check then ensures that this size is a multiple of the partition width. If no error is detected, the subsystem then calculates the number of independent executions that the enclosed subsystem will perform. These executions are independent, in that the state associated with a given block contained in the subsystem has a unique value in each of the respective executions.

To see a non-vectorized implementation for this model, double-click on the block in the lower-right corner of the model. This implementation does not use the For Each subsystem, but mimics its functionality by replicating the subsystem as many times as necessary and also by selecting and concatenating the signals appropriately. This replication process is prone to error and is not scalable -- changing the input signal size would require changing the model accordingly.

For Each Subsystem: Vectorizing a Scalar Algorithm

?

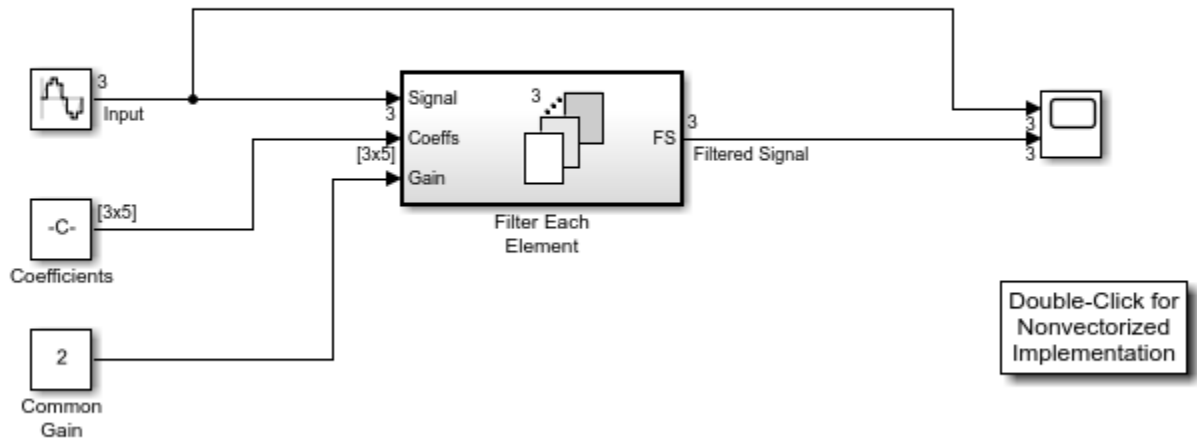

Copyright 2009-2015 The MathWorks, Inc.

Tiled Processing of 2D Signals with For Each Subsystem

This example shows how to use the For Each Subsystem. In this example the operations are performed on matrices.

Open the example model `sldemo_foreach_tiled`. This model contains a For Each subsystem that processes submatrices of a matrix input signal.

To process submatrices of a matrix signal, you will need to use nested For Each subsystems. The outer subsystem can be used to partition the signal along the first dimension, while the inner one can be used to partition along the second dimension. This order is arbitrary, and can be changed without affecting the result.

In this example a 4-by-4 matrix is to be partitioned into 2-by-2 submatrices. The outer subsystem partitions the signal along the first dimension. The resulting subarrays are then partitioned by the inner subsystem along the second dimension. Concatenation of the outputs respects the partitioning order to preserve the shape of the input signal. Note, however, that the output dimensions change since the processing of the submatrices results in scalar outputs.

To see a tile repetition implementation for this model, double-click on the subsystem in the lower-right corner of the model window. This implementation does not use the For Each Subsystem. Instead, it mimics the functionality of the For Each Subsystem by replicating the subsystem as many times as necessary and by selecting and concatenating the signals appropriately. This replication process is prone to error and is not scalable -- changing the input signal size would require changing the model accordingly.

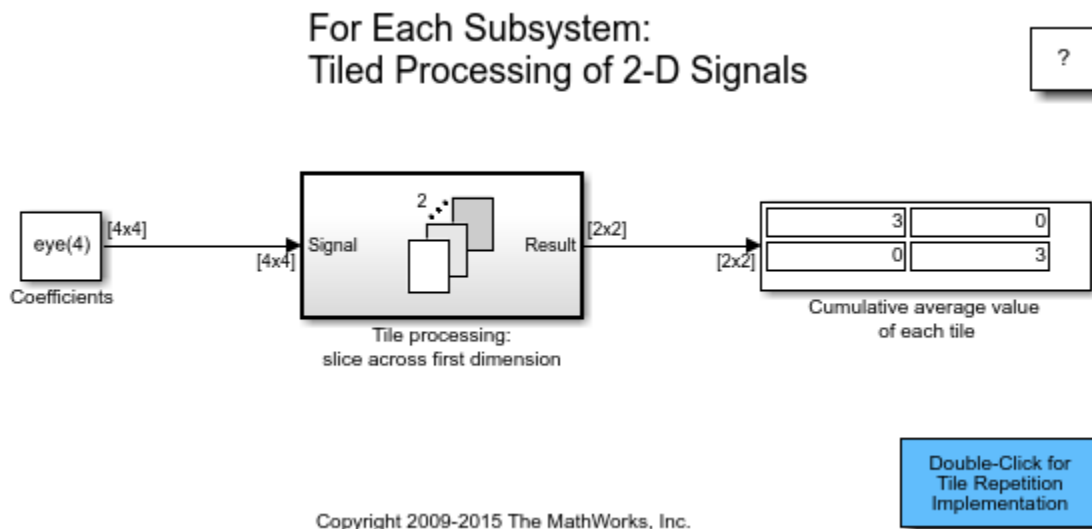

Neighborhood Processing Using For Each Subsystems

This example shows how to use the For Each Subsystem block to process submatrix data when neighboring submatrices overlap each other. To demonstrate this data processing approach, the example implements image edge detection with linear filters using the For Each Subsystem block. Each For Each Subsystem block has a For Each block that needs to be configured for partitioning and concatenation.

Open the example model `slxForEachOverlapExample`. This model uses a 3-by-3 kernel to implement the edge detection application for a given two-dimensional image. Because of the two-dimensional input signal, this example uses nested For Each subsystems.

- The outer For Each subsystem partitions the signal along the first dimension. The outer For Each block is configured to partition the input signal along dimension 1. The block specifies a partition width of 3 and a partition offset of -2. (A partition offset of -2 indicates that each slice overlaps its neighboring slices by 2 elements.)
- The inner For Each subsystem partitions the signal along the second dimension. The inner For Each block has the same settings as the outer For Each block, except that the inner block is set to partition and concatenate signals along dimension 2.

The partitioning order is arbitrary. To ensure correctness of the result, the concatenation order of the outputs follows the partitioning order.

For simplicity, this example does not handle data padding. As a result, the size of the output image is slightly smaller than that of the input image.

Neighborhood Processing Using For Each Subsystems: Image Edge Detection

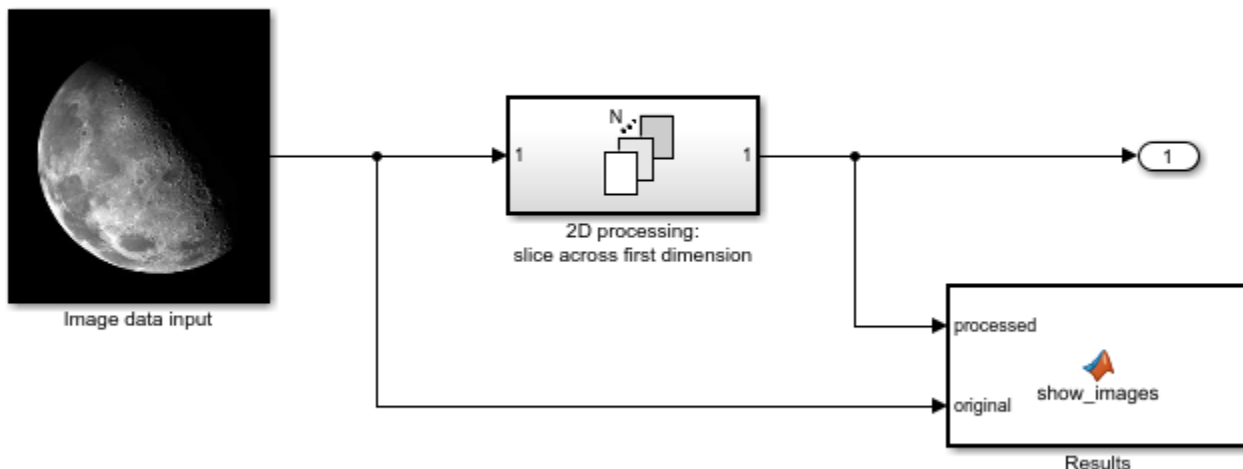

Copyright 2017 The MathWorks, Inc.

The result of the comparison between the original image and the processed image is shown below.





Figure 1: Original image vs. processed image

Using a Project with SVN

This example shows how to use a project to manage the files within your design. Starting with an existing project that is already checked into source control, this example shows how to view modified files, compare file revisions, and analyze project dependencies.

Set Up the Example Files and Open the Project

Create and open a working copy of the project example files. MATLAB® copies the files to an example folder so that you can edit them. The example project is under Subversion (SVN) version control.

```
sldemo_slproject_airframe_svn
```

```
Building with 'MinGW64 Compiler (C)'.
MEX completed successfully.
```

```
ans =
```

```
Project with properties:
```

```

        Name: "Airframe Example"
SourceControlIntegration: "SVN (1.9)"
  RepositoryLocation: "file:///C:/workSpace/examples/repositories/airframe2/trunk"
SourceControlMessages: [1x0 string]
      ReadOnly: 0
      TopLevel: 1
  Dependencies: [1x1 digraph]
    Categories: [1x1 matlab.project.Category]
      Files: [1x30 matlab.project.ProjectFile]
    Shortcuts: [1x7 matlab.project.Shortcut]
    ProjectPath: [1x7 matlab.project.PathFolder]
ProjectReferences: [1x0 matlab.project.ProjectReference]
  StartupFiles: [1x0 string]
  ShutdownFiles: [1x0 string]
DefinitionFileType: FixedPathMultiFile
  Description: "This is an example project. Use the "Project Shortcuts" toolstrip
  RootFolder: "C:\workSpace\examples\airframe2"
SimulinkCodeGenFolder: "C:\workSpace\examples\airframe2\work\codegen"
SimulinkCacheFolder: "C:\workSpace\examples\airframe2\work\cache"
ProjectStartupFolder: "C:\workSpace\examples\airframe2"
```

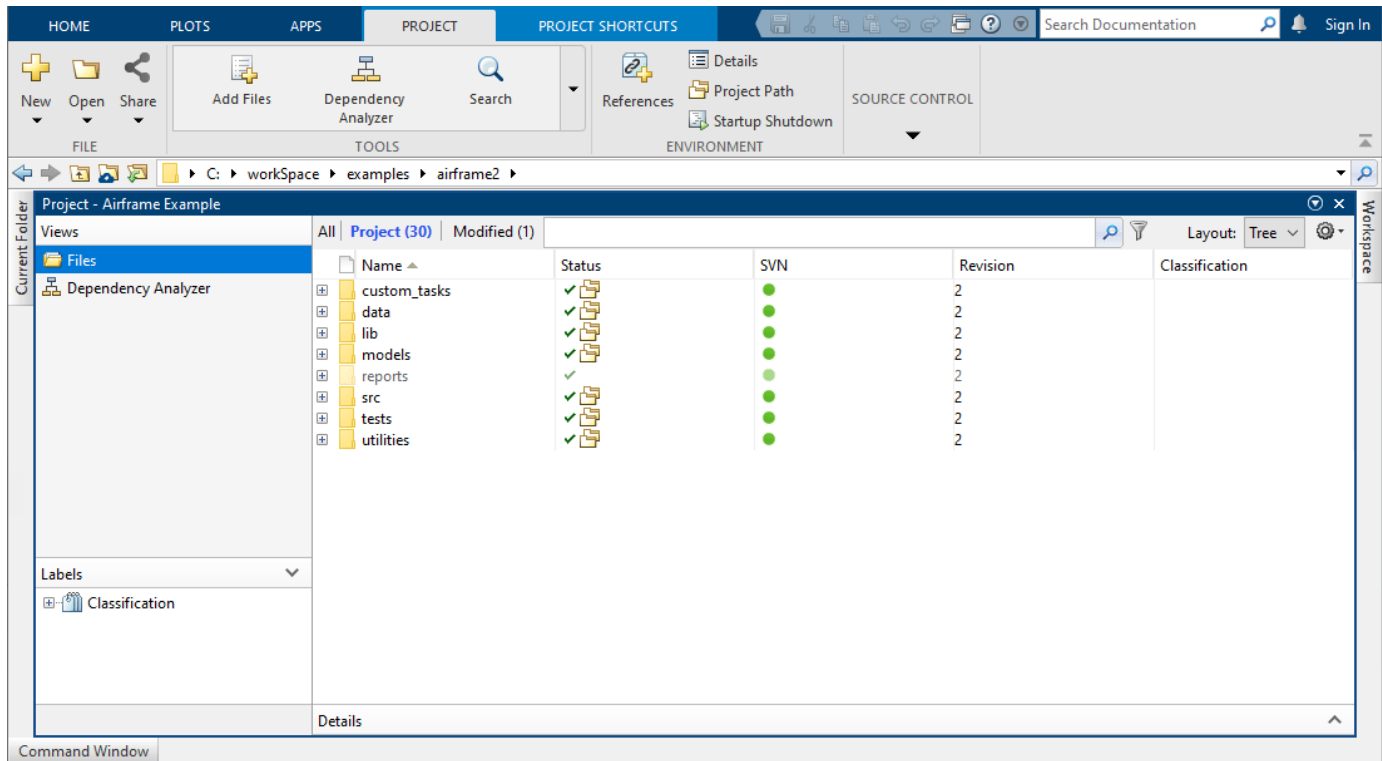

Manage the Project Path

When you open your project, MATLAB adds the project path to the MATLAB search path before applying startup shortcuts.

When you close your project, MATLAB removes the project path from the MATLAB search path after applying shutdown shortcuts.

1. To add or remove folders to the project path, on the **Project** tab, in the **Environment** section, click **Project Path**:

- To add a folder (without subfolders) to the project path, click **Add Folder**. If you want to add a folder and its subfolders, click **Add with Subfolders** instead. Then use the Open dialog box to add the new folder.
- To remove a folder from the project path, from the display list, select the folder. Then click **Remove**.

It is important to add project files to the project path to ensure the Dependency Analyzer detects all project files.

Specify Project Details, Startup Folder, and Derived Files Folders

2. On the **Project** tab, in the **Environment** section, click **Details**. Use the Project Details dialog box to:

- Edit the project name or add a description.
- View the **Project root** folder. You can change your project root by moving your entire project on your file system, and reopening your project in its new location. All project file paths are stored as relative paths.

- View or edit the **Start Up** folder. By default, this is set to the project root. When you open the project, the current working folder changes to the project root folder. You can specify a different startup folder or click **Clear**.
- View or edit the **Simulation cache folder** and **Code generation folder**.

To change the default project root for new projects, on the MATLAB **Home** tab, in the **Environment** section, click **Preferences**. Select **MATLAB > Project** and specify the **Default folder**.

Automate Startup and Shutdown Tasks

You can set project files, such as MATLAB scripts and Simulink® models, to run, open, or close when the project opens or closes.

3. To configure an existing file to run on project startup and shutdown, or to specify environment options, click the **Startup Shutdown** button in the **Project** tab. In the Manage Project Startup and Shutdown dialog box

- Add or remove startup and shutdown files. If execution order is important, change the order using the arrow buttons.
- Use the check boxes to specify environment options. Select **Start Simulink before this project starts** to start Simulink when you open the project. Select **Refresh Simulink customizations** to run `sl_customization` files on project startup and shutdown.

Project Shortcuts for Common Tasks

Create project shortcuts for common tasks to make it easy to find and access important files and operations. For example, find and open top models, run code, and simulate models.

4. On the **Project Shortcuts** tab, this example project has shortcuts for the top-level model, a utility function to rebuild s-functions, and a design description document.

- Click the shortcut *F14 Model* to open the root model for this project.
- Click the shortcut *Rebuild Project's S-functions* to generate the S-Function.
- Click the **New Shortcut** button to create new shortcuts for a project file.
- Right-click a shortcut and select **Edit Shortcut** to edit a shortcut.

View Source Control Information

On the **Project** tab, in the **Source Control** section, click **SVN Details**.

5. Use the Source Control Information dialog box to:

- View the **Repository location** folder. You can change your project root by moving your entire project on your file system, and reopening your project in its new location. All project file paths are stored as relative paths.
- View or change the used source control integration.

Explore Files Views

6. In the **Files** view, select the **Project (number of files)** view to manage the files within your project. This view only shows files that are part of your project.

7. Use the **All** view to see all the files in your working copy. This shows all the files that are under the project root, not just the files that are in the project. This view is useful for adding files to your project from your working copy.

8. Use the **Modified (number of files)** view to review the modified files before committing your changes to source control. The modified files view is visible only if you are using source control with your project.

9. In any **Files** view, at the top right, change the layout from **Tree** to **List** to view the files as a list. Click the Organize View button  to customize the views and to sort files.

The **SVN** column provides source control information on individual files such as Unmodified, Added, Modified, or Deleted.

View Modified Files and Compare Revisions

10. Open and make a change to one of the models in the `models` folder or to one of the MATLAB files in the `utility` folder. For example, add a comment in `find_top_models.m` in the `utility` folder.

11. To review, analyze, and commit modified or added project files, use the **Modified (number of files)** view. You see:

- The file you made changes to, for example, `find_top_models.m`.
- The files stored in the `resources/project` folder. These are internal project definition files generated by your changes. The project definition files allow you to add metadata to files, for example, by creating shortcuts, adding labels, and adding a project description. Project definition files also define the files that are added to your project. You can review changes in revisions of project definition files like any other project files.

12. To review changes in a modified file, right-click selected file, for example, `find_top_models.m`

- Select **Compare > Compare to Ancestor** to run a comparison against the local Git repository.
- Select **Compare > Compare to Revision** to compare the file to other revisions.

13. The Comparison Tool summarizes results in a report. Purple indicates modified items, blue indicates inserted items, and yellow indicates deleted items. To save a printable version of the report, select **Publish > HTML, Word, or PDF**.

14. If you are happy with your changes, on the **Project** tab, click the **Commit** button to commit your changes to source control.

Analyze Project Dependencies

15. Use the Dependency Analyzer to investigate dependencies visually and explore the structure of your project. On the **Project** tab, click the down arrow to expand the **Tools** gallery. Under **Apps**, click **Dependency Analyzer**.

The Dependency Analyzer summarizes the results in the pane on the right. It lists the names of the used **Products** and **Add-Ons**. It detects problems, such as missing files, files not in the project, unsaved changes, and out-of-date derived files. In this example, the analyzer identifies a "File not in project" and tags it with a warning sign .

16. To highlight problem files, in the **Problems** section, point to the problem message and click the magnifying glass. In this example, the `timesthree.mexw64` file is required by the project but is

not currently part of it. Right-click `timesthree.mexw64` and select **Add to Project** or **Hide Warnings**. The next time you run the dependency analysis, the analyzer will not mark this file as a problem.

17. Perform an impact analysis on a selected file.

An impact analysis shows you how a change affects other files before you make the change. For example, to find required files for `timesthree.mexw64` to run properly, right-click `timesthree.mexw64` and select **Find Required**. To find how changes to `timesthree.mexw64` impact files, right-click `timesthree.mexw64` and select **Find Impacted**.

See Also

“Resolve Conflicts with Simulink Three-Way Merge” on page 13-524

“Perform Impact Analysis with a Project” on page 13-497

“Run Custom Tasks with a Project” on page 13-508

Further Information

“Project Management”

Using a Project with Git

This example shows how to use a project to manage the files within your design. Starting with an existing project that is already checked into source control, this example shows how to view modified files, compare file revisions, and analyze project dependencies.

Set up the Example Files and Open the Project

Create and open a working copy of the project example files. MATLAB® copies the files to an example folder so that you can edit them. The example project is under Git™ source control.

```
sldemo_slproject_airframe
```

```
Building with 'MinGW64 Compiler (C)'.
MEX completed successfully.
```

```
ans =
```

```
Project with properties:
```

```

                Name: "Airframe Example"
SourceControlIntegration: "Git"
  RepositoryLocation: "C:\workSpace\examples\repositories\airframe"
SourceControlMessages: ["Current branch: master"      "No remote tracking branch"      "Branch
                      ReadOnly: 0
                      TopLevel: 1
Dependencies: [1x1 digraph]
Categories: [1x1 matlab.project.Category]
  Files: [1x32 matlab.project.ProjectFile]
  Shortcuts: [1x7 matlab.project.Shortcut]
ProjectPath: [1x7 matlab.project.PathFolder]
ProjectReferences: [1x0 matlab.project.ProjectReference]
StartupFiles: [1x0 string]
ShutdownFiles: [1x0 string]
DefinitionFileType: FixedPathMultiFile
  Description: "This is an example project. Use the "Project Shortcuts" toolstri
  RootFolder: "C:\workSpace\examples\airframe"
SimulinkCodeGenFolder: "C:\workSpace\examples\airframe\work\codegen"
ProjectStartupFolder: "C:\workSpace\examples\airframe"
SimulinkCacheFolder: "C:\workSpace\examples\airframe\work\cache"
```

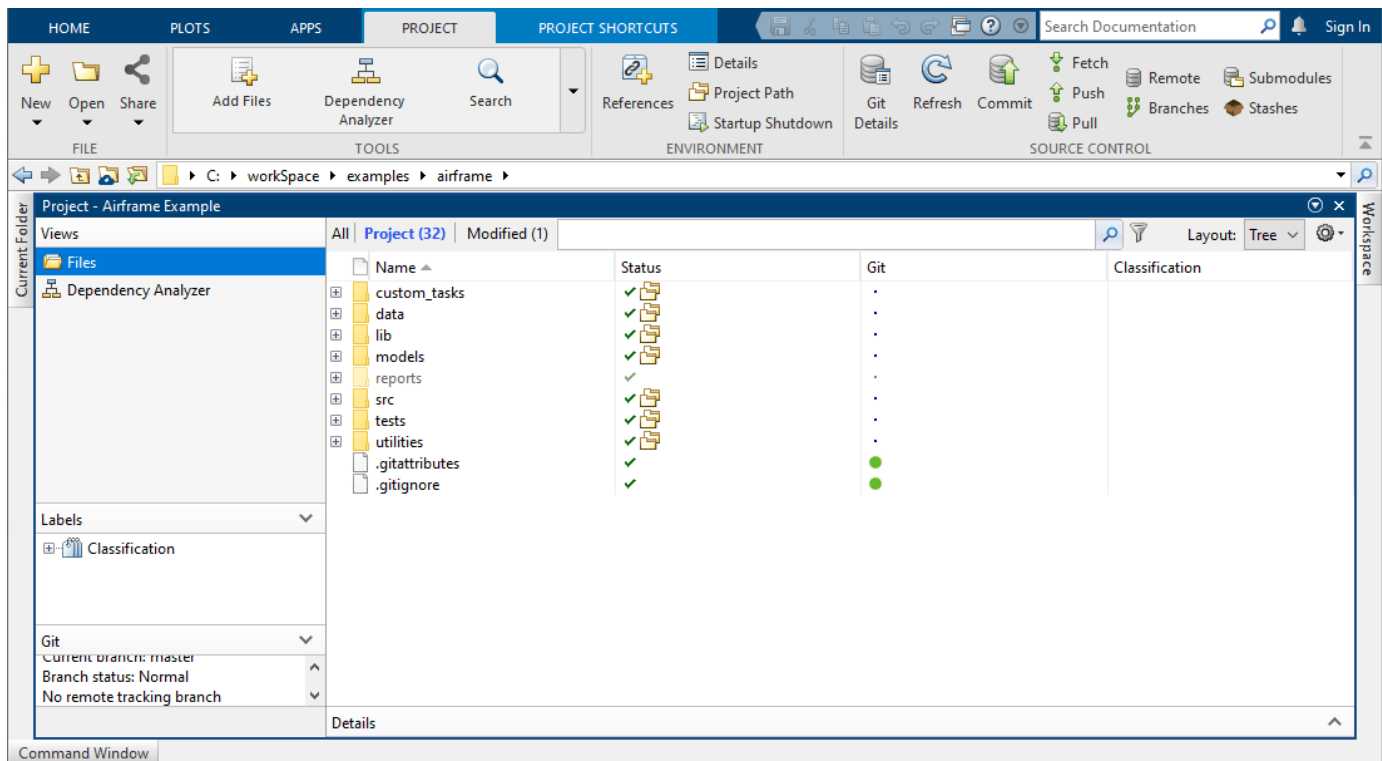
Manage the Project Path

When you open your project, MATLAB adds the project path to the MATLAB search path before applying startup shortcuts.

When you close your project, MATLAB removes the project path from the MATLAB search path after applying shutdown shortcuts.

1. To add or remove folders to the project path, on the **Project** tab, in the **Environment** section, click **Project Path**:

- To add a folder (without subfolders) to the project path, click **Add Folder**. If you want to add a folder and its subfolders, click **Add with Subfolders** instead. Then use the Open dialog box to add the new folder.
- To remove a folder from the project path, from the display list, select the folder. Then click **Remove**.

It is important to add project files to the project path to ensure the Dependency Analyzer detects all project files.

Specify Project Details, Startup Folder, and Derived Files Folders

2. On the **Project** tab, in the **Environment** section, click **Details**. Use the Project Details dialog box to:

- Edit the project name or add a description.
- View the **Project root** folder. You can change your project root by moving your entire project on your file system, and reopening your project in its new location. All project file paths are stored as relative paths.

- View or edit the **Start Up** folder. By default, this is set to the project root. When you open the project, the current working folder changes to the project root folder. You can specify a different startup folder or click **Clear**.
- View or edit the **Simulation cache folder** and **Code generation folder**.

To change the default project root for new projects, on the MATLAB **Home** tab, in the **Environment** section, click **Preferences**. Select **MATLAB > Project** and specify the **Default folder**.

Automate Startup and Shutdown Tasks

You can set project files, such as MATLAB scripts and Simulink® models, to run, open, or close when the project opens or closes.

3. To configure an existing file to run on project startup and shutdown, or to specify environment options, click the **Startup Shutdown** button in the **Project** tab. In the Manage Project Startup and Shutdown dialog box

- Add or remove startup and shutdown files. If execution order is important, change the order using the arrow buttons.
- Use the check boxes to specify environment options. Select **Start Simulink before this project starts** to start Simulink when you open the project. Select **Refresh Simulink customizations** to run `sl_customization` files on project startup and shutdown.

Project Shortcuts for Common Tasks

Create project shortcuts for common tasks to make it easy to find and access important files and operations. For example, find and open top models, run code, and simulate models.

4. On the **Project Shortcuts** tab, this example project has shortcuts for the top-level model, a utility function to rebuild s-functions, and a design description document.

- Click the shortcut *F14 Model* to open the root model for this project.
- Click the shortcut *Rebuild Project's S-functions* to generate the S-Function.
- Click the **New Shortcut** button to create new shortcuts for a project file.
- Right-click a shortcut and select **Edit Shortcut** to edit a shortcut.

View Source Control Information

On the **Project** tab, in the **Source Control** section, click **Git Details**.

5. Use the Source Control Information dialog box to:

- View the **Repository location** folder. You can change your project root by moving your entire project on your file system, and reopening your project in its new location. All project file paths are stored as relative paths.
- View or change the used source control integration.

Explore Files Views

6. In the **Files** view, select the **Project (number of files)** view to manage the files within your project. This view only shows files that are part of your project.

7. Use the **All** view to see all the files in your working copy. This shows all the files that are under the project root, not just the files that are in the project. This view is useful for adding files to your project from your working copy.

8. Use the **Modified (number of files)** view to review the modified files before committing your changes to source control. The modified files view is visible only if you are using source control with your project.

9. In any **Files** view, at the top right, change the layout from **Tree** to **List** to view the files as a list. Click the Organize View button  to customize the views and to sort files.

The **Git** column provides source control information on individual files such as Unmodified, Added, Modified, or Deleted.

View Modified Files and Compare Revisions

10. Open and make a change to one of the models in the `models` folder or to one of the MATLAB files in the `utility` folder. For example, add a comment in `find_top_models.m` in the `utility` folder.

11. To review, analyze, and commit modified or added project files, use the **Modified (number of files)** view. You see:

- The file you made changes to, for example, `find_top_models.m`.
- The files stored in the `resources/project` folder. These are internal project definition files generated by your changes. The project definition files allow you to add metadata to files, for example, by creating shortcuts, adding labels, and adding a project description. Project definition files also define the files that are added to your project. You can review changes in revisions of project definition files like any other project files.

12. To review changes in a modified file, right-click selected file, for example, `find_top_models.m`

- Select **Compare > Compare to Ancestor** to run a comparison against the local Git repository.
- Select **Compare > Compare to Revision** to compare the file to other revisions.

13. The Comparison Tool summarizes results in a report. Purple indicates modified items, blue indicates inserted items, and yellow indicates deleted items. To save a printable version of the report, select **Publish > HTML, Word, or PDF**.

14. If you are happy with your changes, on the **Project** tab, click the **Commit** button to commit your changes to source control.

Analyze Project Dependencies

15. Use the Dependency Analyzer to investigate dependencies visually and explore the structure of your project. On the **Project** tab, click the down arrow to expand the **Tools** gallery. Under **Apps**, click **Dependency Analyzer**.

The Dependency Analyzer summarizes the results in the pane on the right. It lists the names of the used **Products** and **Add-Ons**. It detects problems, such as missing files, files not in the project, unsaved changes, and out-of-date derived files. In this example, the analyzer identifies a "File not in project" and tags it with a warning sign .

16. To highlight problem files, in the **Problems** section, point to the problem message and click the magnifying glass. In this example, the `timesthree.mexw64` file is required by the project but is

not currently part of it. Right-click `timesthree.mexw64` and select **Add to Project** or **Hide Warnings**. The next time you run the dependency analysis, the analyzer will not mark this file as a problem.

17. Perform an impact analysis on a selected file.

An impact analysis shows you how a change affects other files before you make the change. For example, to find required files for `timesthree.mexw64` to run properly, right-click `timesthree.mexw64` and select **Find Required**. To find how changes to `timesthree.mexw64` impact files, right-click `timesthree.mexw64` and select **Find Impacted**.

See Also

“Resolve Conflicts with Simulink Three-Way Merge” on page 13-524

“Perform Impact Analysis with a Project” on page 13-497

“Run Custom Tasks with a Project” on page 13-508

Further Information

“Project Management”

Using a Project

This example shows how to use an existing project to manage the files within your design. It shows how to automate startup and shutdown tasks, add shortcuts for common tasks, run checks, upgrade project files, analyze project dependencies, and share your project.

As a design grows, managing referenced files and dependencies becomes more complicated. Projects help you organize large hierarchies by finding required files, managing and sharing files and settings, and interacting with source control.

This project example is not under source control. As a result, essential tools needed in a collaborative environment are not available for use, for example, comparing files to their ancestors, comparing revisions and resolving conflicts.

- To use available source control integration in MATLAB® such as Git™ and SVN, see “Using a Project with Git” on page 13-488 or “Using a Project with SVN” on page 13-483 example instead.
- To use an external source control with project, put the project folder under the source control of choice and customize it to use the MATLAB® Comparison Tool for diff and merge. For more information, see “Customize External Source Control to Use MATLAB for Diff and Merge”.

Set up the Example Files and Open the Project

Create and open a working copy of the project example files. MATLAB® copies the files to an example folder so that you can edit them.

```
sldemo_slproject_airframe_setup;
```

```
Building with 'MinGW64 Compiler (C)'.  
MEX completed successfully.
```

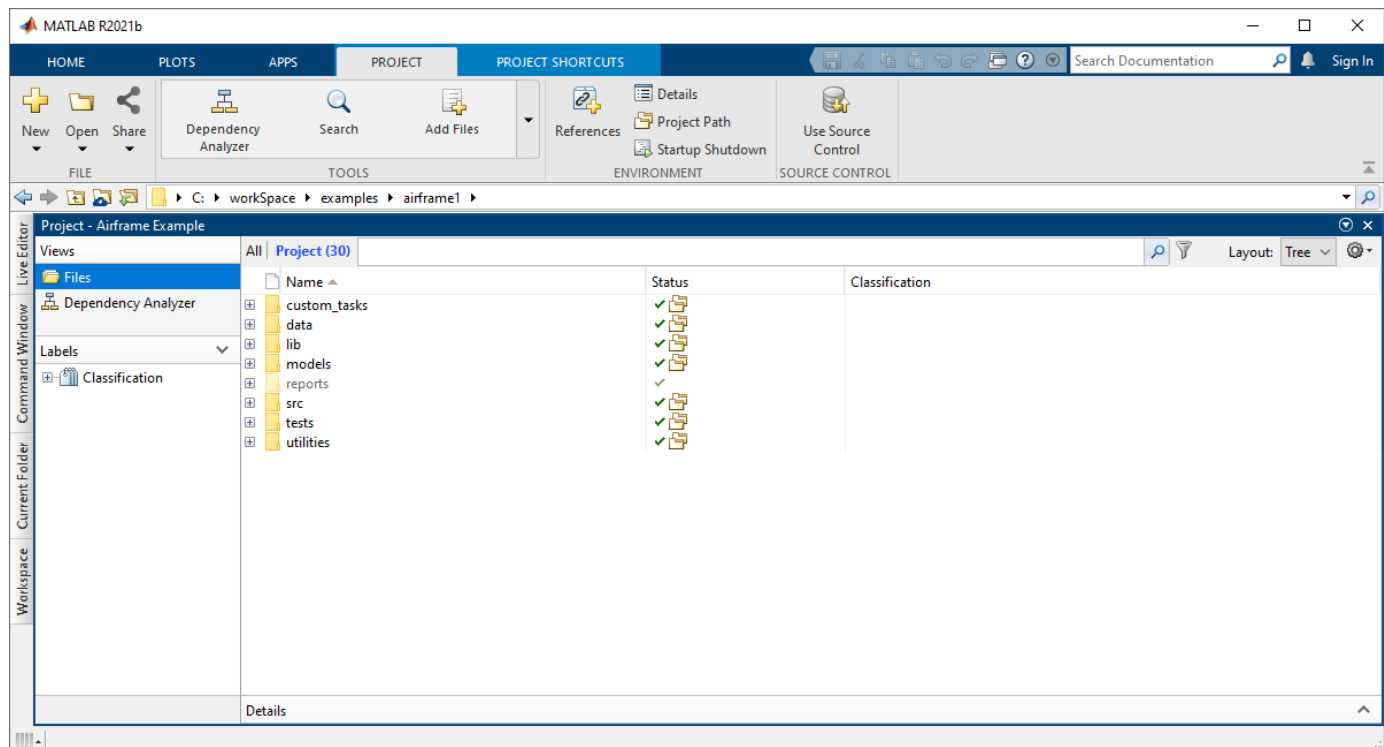

Manage the Project Path

When you open your project, MATLAB adds the project path to the MATLAB search path before applying startup shortcuts.

When you close your project, MATLAB removes the project path from the MATLAB search path after applying shutdown shortcuts.

1. To add or remove folders to the project path, on the **Project** tab, in the **Environment** section, click **Project Path**:

- To add a folder (without subfolders) to the project path, click **Add Folder**. If you want to add a folder and its subfolders, click **Add with Subfolders** instead. Then use the Open dialog box to add the new folder.
- To remove a folder from the project path, from the display list, select the folder. Then click **Remove**.

It is important to add project files to the project path to ensure the Dependency Analyzer detects all project files.

Specify Project Details, Startup Folder, and Derived Files Folders

2. On the **Project** tab, in the **Environment** section, click **Details**. Use the Project Details dialog box to:

- Edit the project name or add a description.
- View the **Project root** folder. You can change your project root by moving your entire project on your file system, and reopening your project in its new location. All project file paths are stored as relative paths.
- View or edit the **Start Up** folder. By default, this is set to the project root. When you open the project, the current working folder changes to the project root folder. You can specify a different startup folder or click **Clear**.
- View or edit the **Simulation cache folder** and **Code generation folder**.

To change the default project root for new projects, on the MATLAB **Home** tab, in the **Environment** section, click **Preferences**. Select **MATLAB > Project** and specify the **Default folder**.

Automate Startup and Shutdown Tasks

You can set project files, such as MATLAB scripts and Simulink® models, to run, open, or close when the project opens or closes.

3. To configure an existing file to run on project startup and shutdown, or to specify environment options, click the **Startup Shutdown** button in the **Project** tab. In the Manage Project Startup and Shutdown dialog box

- Add or remove startup and shutdown files. If execution order is important, change the order using the arrow buttons.
- Use the check boxes to specify environment options. Select **Start Simulink before this project starts** to start Simulink when you open the project. Select **Refresh Simulink customizations** to run `sl_customization` files on project startup and shutdown.

Project Shortcuts for Common Tasks

Create project shortcuts for common tasks to make it easy to find and access important files and operations. For example, find and open top models, run code, and simulate models.

4. On the **Project Shortcuts** tab, this example project has shortcuts for the top-level model, a utility function to rebuild s-functions, and a design description document.

- Click the shortcut *F14 Model* to open the root model for this project.
- Click the shortcut *Rebuild Project's S-functions* to generate the S-Function.
- Click the **New Shortcut** button to create new shortcuts for a project file.
- Right-click a shortcut and select **Edit Shortcut** to edit a shortcut.

Explore Files Views

6. In the **Files** view, select the **Project (number of files)** view to manage the files within your project. This view only shows files that are part of your project.

7. Use the **All** view to see all the files in your working copy. This shows all the files that are under the project root, not just the files that are in the project. This view is useful for adding files to your project from your working copy.

8. In any **Files** view, at the top right, change the layout from **Tree** to **List** to view the files as a list. Click the Organize View button  to customize the views and to sort files.

Analyze Project Dependencies

9. Use the Dependency Analyzer to investigate dependencies visually and explore the structure of your project. On the **Project** tab, click the down arrow to expand the **Tools** gallery. Under **Apps**, click **Dependency Analyzer**.

The Dependency Analyzer summarizes the results in the pane on the right. It lists the names of the used **Products** and **Add-Ons**. It detects problems, such as missing files, files not in the project, unsaved changes, and out-of-date derived files. In this example, the analyzer identifies a "File not in project" and tags it with a warning sign .

10. To highlight problem files, in the **Problems** section, point to the problem message and click the magnifying glass. In this example, the `timesthree.mexw64` file is required by the project but is not part of it. Right-click `timesthree.mexw64` and select **Add to Project** or **Hide Warnings**. The next time you run the dependency analysis, the analyzer will not mark this file as a problem.

11. Perform an impact analysis on a selected file.

An impact analysis shows you how a change affects other files before you make the change. For example, to find required files for `timesthree.mexw64` to run properly, right-click `timesthree.mexw64` and select **Find Required**. To find how changes to `timesthree.mexw64` impact files, right-click `timesthree.mexw64` and select **Find Impacted**.

Run Checks and Upgrade Project Files

12. Upgrade all models, libraries, and MATLAB code files in your project to the latest release using a simple workflow. On the **Project** tab, click the down arrow to expand the **Tools** gallery. Under **Project Checks**, click **Upgrade Project**.

To upgrade all files, run all checks, and apply fixes automatically where possible, click **Upgrade**. If you want to change the settings, use these options before clicking **Upgrade**:

- If you want to run upgrade checks but not apply fixes automatically where possible, clear the check box **Apply upgrades automatically**.
- If you want to change which files to upgrade and which checks to run, click **Change Options**. In the Upgrade Options dialog box, clear check boxes for models and checks you want to exclude from the upgrade.

The Upgrade Project tool apply all fixes automatically when possible, upgrade all model hierarchies in the project at once, and produce a report.

Share Project

Before sharing projects with other users, it is helpful to find required files and products using the Dependency Analyzer.

13. On the **Project** tab, select **Share** and explore the different sharing options.

You can share your project as an archive and send it by email. On the **Project** tab, select **Share > Archive**. You can export the whole project or just a part of it using **Export profile**. If you decide to exclude files from your project, use the Dependency Analyzer to examine the impact of excluding a file on the project. If you have referenced projects and want to export the referenced project files, then select the **Include referenced projects** check box.

You can also share your project and make it publicly available on GitHub®. This adds Git source control to the open project.

See Also

“Perform Impact Analysis with a Project” on page 13-497

“Run Custom Tasks with a Project” on page 13-508

Further Information

“Project Management”

Perform Impact Analysis with a Project

This example shows how to perform file-level impact analysis using the Dependency Analyzer. It shows how to visualize project structure, analyze project dependencies, find required add-ons and products, identify and fix problems, and assess how a change will affect other project files.

You can run a dependency analysis at any point in your workflow. In a collaborative environment, you typically check dependencies

- when you first set up or explore a project
- when you run tests to validate changes to your design
- before you submit a version of your project to source control
- before you share or package your project

Set Up the Example Files and Open the Project

Create and open a working copy of the project example files. MATLAB® copies the files to an example folder so that you can edit them. The example project is under Git™ source control.

```
sldemo_slproject_airframe;
```

```
Building with 'MinGW64 Compiler (C)'.  
MEX completed successfully.
```

Visualize Project Structure and Dependencies

Run a dependency analysis on all the files in your project.

1. On the **Project** tab, click the down arrow to expand the **Tools** section. Under **Apps**, click **Dependency Analyzer**.

The dependency graph shows:

- Your project structure and its file dependencies, including how files such as models, libraries, functions, data files, source files, and derived files relate to each other. Each item in the graph represents a file and each arrow represents a dependency
- Relationships between source and derived files (such as .m and .p files, .slx and .slxp, and .c and .mex files), and between C/C++ source and header files

When no file is selected, the **Properties** pane shows:

- The project details
- The required products and add-ons for the entire project
- The list of problems for the entire project, such as missing files, files not in the project, files with unsaved changes, and out-of-date derived files

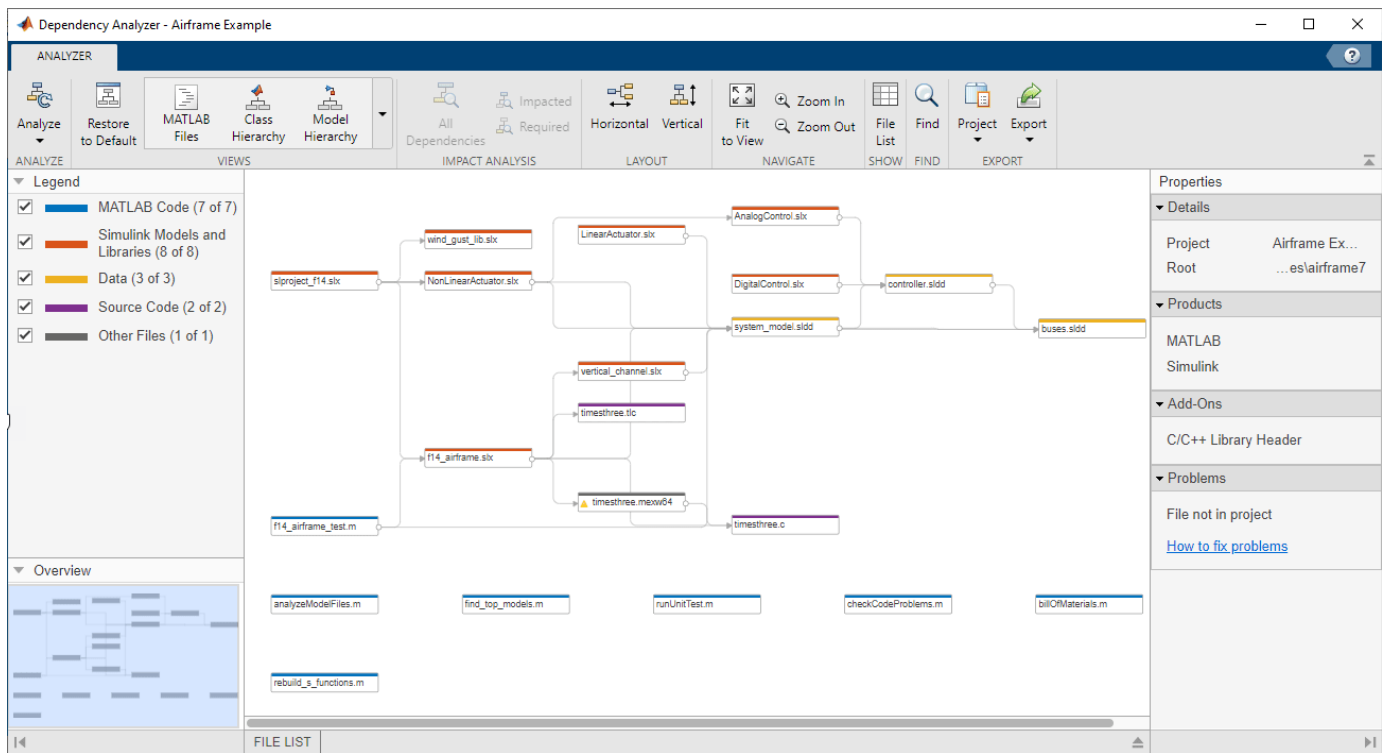

Investigate and Resolve Problems

The Dependency Analyzer identifies problems, such as missing files, files not in the project, unsaved changes, and out-of-date derived files. You can examine problem files using the dependency graph or the file list.

Use the graph to investigate problem files.

2. In the **Properties** pane, in the **Problems** section, point to **File not in project** and click the magnifying glass icon .

The graph highlights the files with this specific problem, in this example, `timesthree.mexw64`.

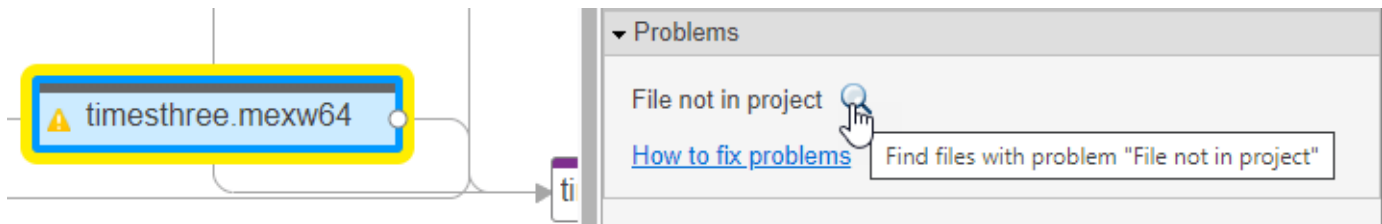

Take actions to resolve the problem file.

3. Right-click `timesthree.mexw64` and select **Add to Project**. To remove `timesthree.mexw64` from the problem list without adding it to the project, right-click and select **Hide Warnings**.

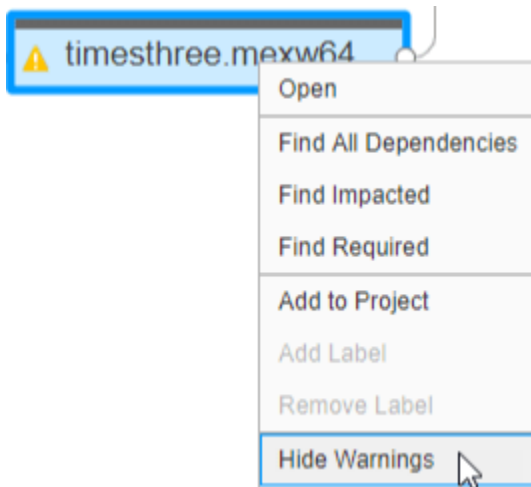

4. Click **Analyze** to update the graph and the **Problems** list.

Tip: For large projects, use the **File List** to investigate your project problem files. For more details, see “Investigate Problem Files in File List”.

View Modified Files

5. Open and make a change to one of the models, for example, `vertical_channel.slx`.

a. In the dependency graph, double-click `vertical_channel.slx` to open it.

b. Move a block in `vertical_channel.slx` and save the model.

Use the **Views** gallery to display the source control status of each file in the dependency graph.

6. In the Dependency Analyzer toolstrip, expand the **Views** gallery and click **Source Control**.

The color of each item in the graph now represents its source control status. Since you made a change to `vertical_channel.slx`, its source control status is **Modified**.

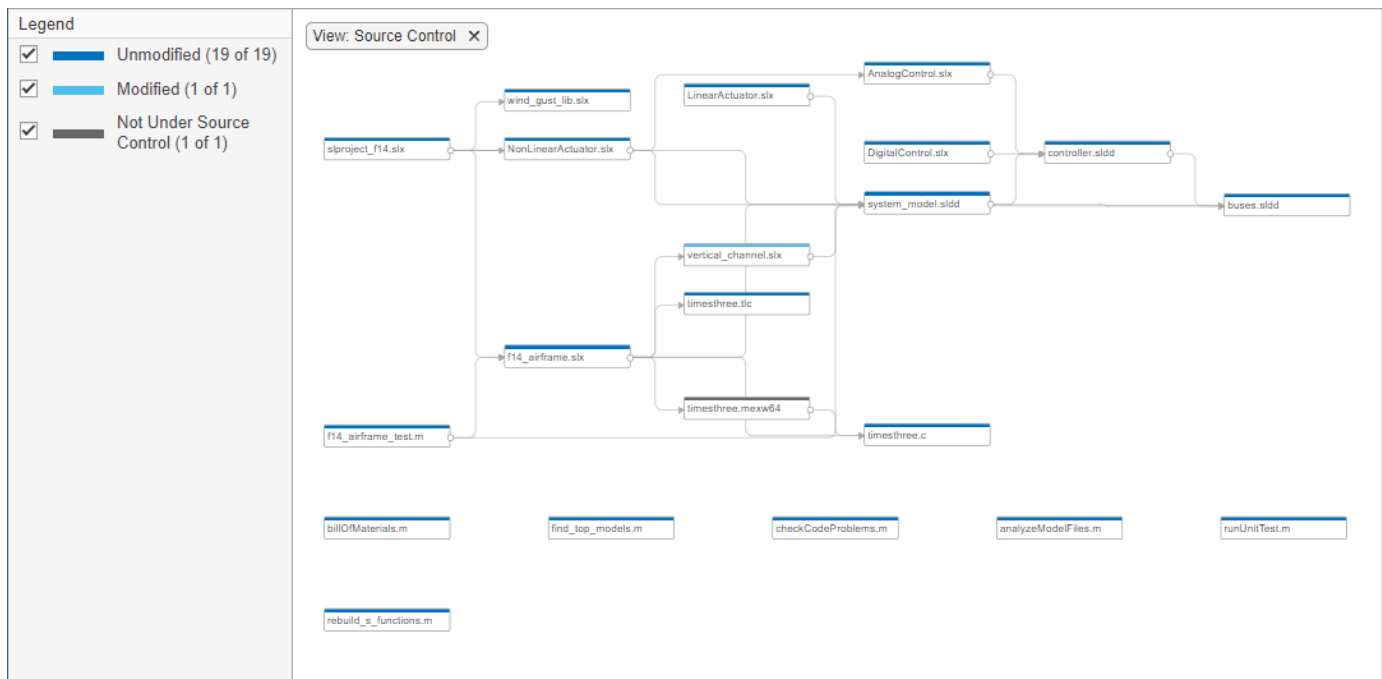

Find the Impact of the Change

You can use the **Impact Analysis** tools to find:

- the files impacted by a change to a file
- the files required by a file to run successfully

7. Use the **Impact Analysis** tools to assess the impact your change has on other files.

- In the dependency graph, select the file you modified, for example, `vertical_channel.slx`.
- In the **Impact Analysis** section, click **Impacted**.

The dependency graph filters files and shows only those impacted by the changes you made to `vertical_channel.slx`.

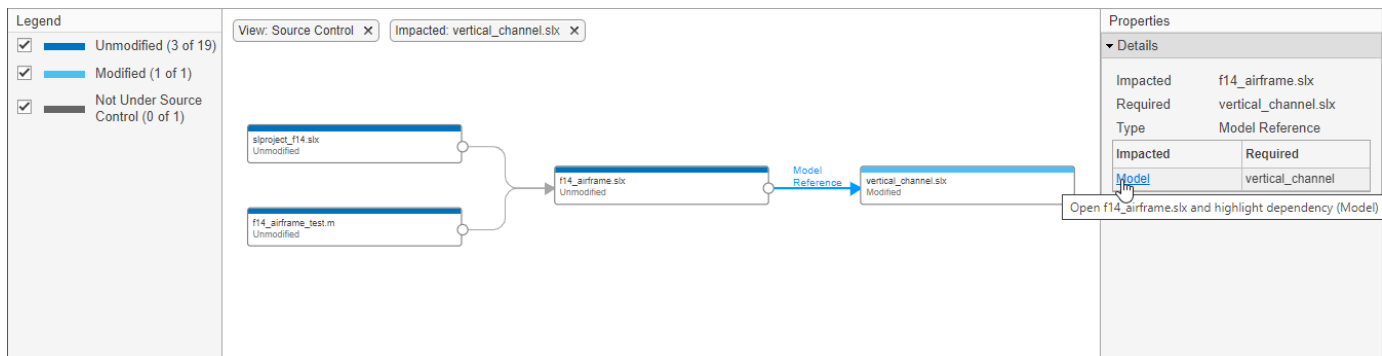

8. Find where the dependency to `vertical_channel.slx` is introduced in `f14_airframe.slx`.

- Select the dependency arrow linking `f14_airframe.slx` to `vertical_channel.slx`.

b. In the **Properties** pane, click the link under **Impacted**. Simulink® opens the model `f14_airframe.slx` and highlights the model block `vertical_channel`.

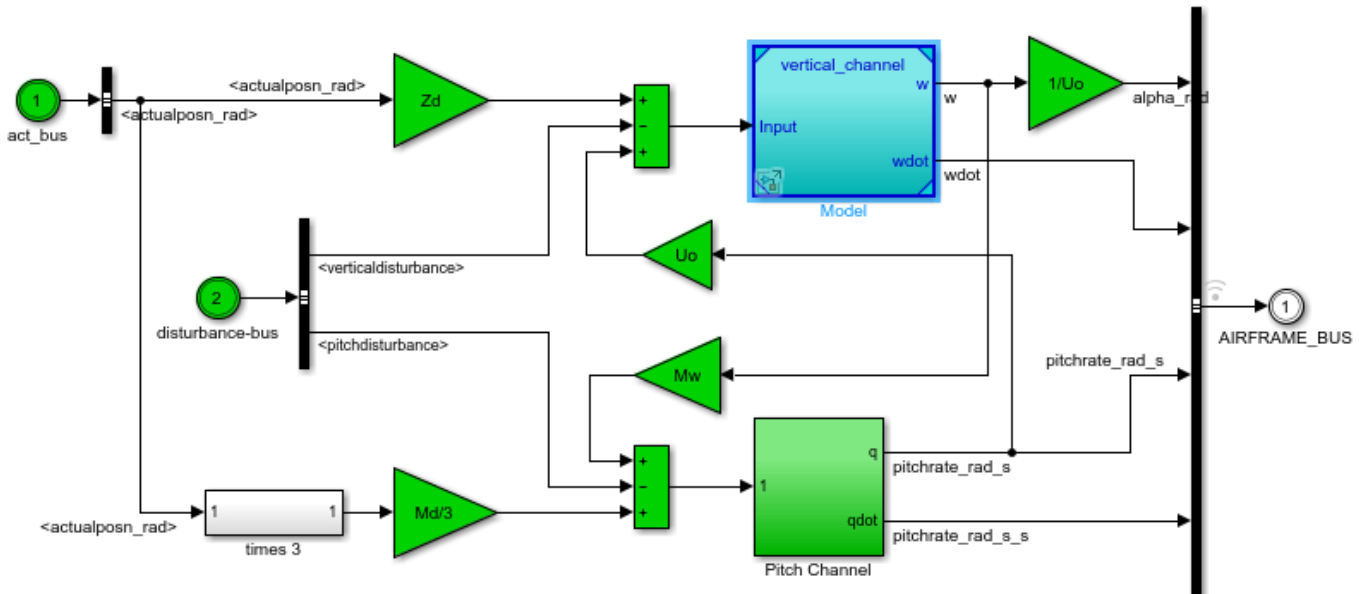

Copyright 1990-2018 The MathWorks, Inc.

Identify Tests to Run

Project automatically associates Classification labels to each project files. This includes **Design**, **Artifact**, **Convenience**, **Derived**, and **Test** labels. The **Test** label identifies which files are tests. You can create additional classification to label your files. See “Add Labels to Files”.

9. Determine which tests you need to run to validate the changes you made to `vertical_channel.slx`.

a. To display the Classification labels associated to each file in the dependency graph, expand the **Views** gallery and click **Classification**.

The dependency graph showing only files impacted by the changes you made to `vertical_channel.slx` is now colored by label Classifications.

b. Identify the tests affected by your change.

In the graph, there are two **Design** files and one **Test** file impacted by the changes you made to `vertical_channel.slx`. `f14_airframe_test.m` is the test you need to run to validate the design changes.

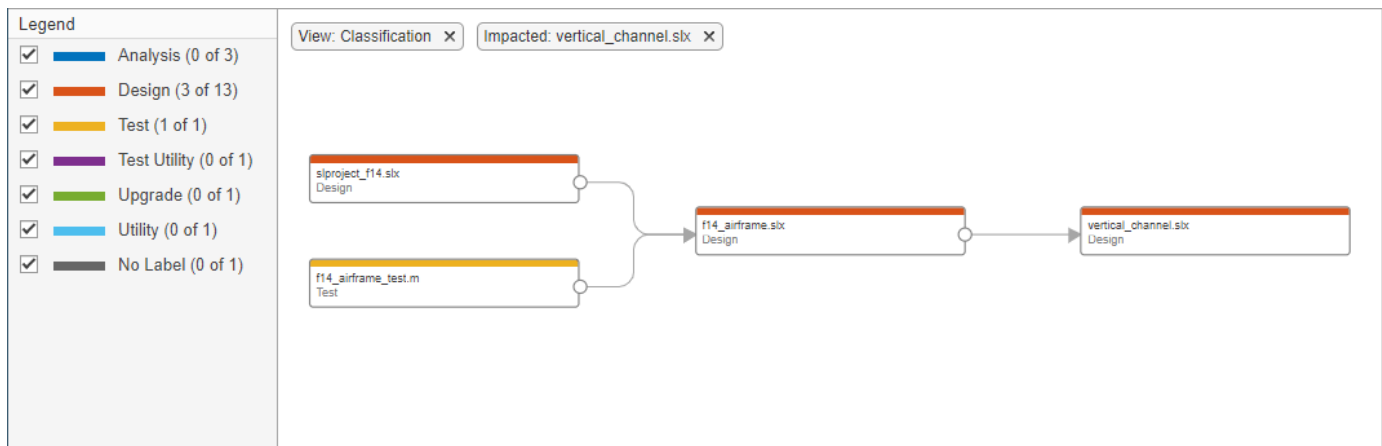

Tip: To clear all filters and restore the graph to show all analyzed dependencies in the project, click **Restore to Default**. Alternatively, manually remove all filters showing at the top of the graph.

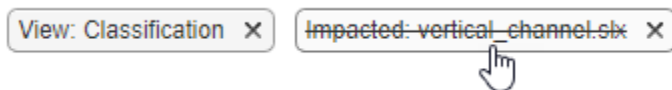

Export Results and Run Tests

You can send files to other Project tools using the **Project** menu. MATLAB exports only the selected files in the current filtered view.

10. Run the selected test to validate the design changes.

a. Select the test you want to run, in this example, `f14_airframe_test.m`.

b. In the Dependency Analyzer toolstrip, in the **Export** section, select **Project > Send to Custom Task**.

In the Custom Task dialog box, the test file `f14_airframe_test.m` exported from the impact analysis is already selected.

c. In the Custom Task dialog box, in the **Custom task** field, select **Run Unit Tests** and Click **Run Task**.

The **Run Unit Tests** custom task runs the MATLAB unit test you selected and creates a summary report. Examine the **Results** section after selecting the test you run, in this example `f14_airframe_test.m`.

- To save the selected file paths to a variable, select **Export > Save to Workspace**.
- To switch to the project **Files** view with the files selected, select **Project > Show in Project**.

See Also

“Run a Dependency Analysis”

“Perform an Impact Analysis”

“Check Dependency Results and Resolve Problems”

Referencing Projects from Another Project

This example shows how to use referenced projects as independent components within your project.

Setting Up the Example Files and Opening the Project

Create and open a working copy of the project example files. MATLAB® copies the files to an example folder so that you can edit them.

```
sldemo_slproject_airframe_references;
```

How Referenced Projects Work

When the parent project is loaded, the referenced projects are loaded first, to add project paths from the referenced project to the MATLAB search path, and to run startup shortcuts from the referenced projects.

- You can run the shortcuts in referenced projects from the parent project, using the Project Shortcuts tab.
- You can examine and open referenced projects by clicking the References node in the Views pane.

Example Referenced Projects

This project provides an airframe simulation which brings in functionality from these other projects by referencing them:

- Signal Multiplier: This referenced project shows how to develop an S-function as an independent project. The referenced project provides source code, build support and path management. The build directory is on the project path, so it is also on the path for the parent project. You can run the "rebuild s-function" shortcut from the parent project on the Project Shortcuts tab.
- Wind Gust library: This referenced project provides a library and a data dictionary that contains the required bus objects for the library. This project's path ensures that the library is set up for use in the parent project.

Further Information

"Componentization of Large Projects"

Automate Label Management in a Project

This example shows how to use the project functions to manage labels.

Open the Airframe Example Project

Create and open a working copy of the project example files. MATLAB® copies the files to an example folder so that you can edit them.

```
sldemo_slproject_airframe;

Starting: Simulink
Building with 'MinGW64 Compiler (C)'.
MEX completed successfully.
```

Get a Project Object.

Create a project object to manipulate the currently open project at the command line.

```
project = currentProject;
```

View the Labels of a File

Examine the files in the project.

```
files = project.Files;
disp(files);

1×31 ProjectFile array with properties:

    Path
    Labels
    Revision
    SourceControlStatus
```

Use indexing to access files in this list. For example, get file number 10. Each file has two properties describing its path and attached labels.

```
aFile = files(10);
disp(aFile);

ProjectFile with properties:

    Path: "C:\workSpace\examples\airframe2\data\system_model.sldd"
    Labels: [1×1 matlab.project.Label]
    Revision: "57973f5e87ca65215ab688e3544287e07db794c4"
    SourceControlStatus: Unmodified
```

Find information about a file attached labels by indexing into the file object Labels property. The following command gets the first label attached to this particular file.

```
label = aFile.Labels(1);
disp(label);

Label with properties:

    File: "C:\workSpace\examples\airframe2\data\system_model.sldd"
    DataType: 'none'
```

```
Data: []  
Name: "Design"  
CategoryName: "Classification"
```

Attach a Label to a Subset of Files.

The following code attaches the label **Design** in the **Classification** category to all files in the project with the .m file extension.

First get the list of files:

```
files = project.Files;
```

Then loop through each file and attach the label **Design** from the **Classification** category if the file has the extension .m.

```
for fileIdx = 1:numel(files)  
    file = files(fileIdx);  
    [~, ~, fileExtension] = fileparts(file.Path);  
    if strcmp(fileExtension, '.m')  
        addLabel(file, 'Classification', 'Design');  
    end  
end
```

Find a Named Label

You can set and query data on a label that is attached to a file. To do this, you first need to find the file object. You can do this by looping through all files in the project, as shown in the previous step. Alternatively, you can use the `findFile` function on the project.

The following code finds the file object for the file 'utilities/rebuild_s_functions.m'.

```
pathToLocate = fullfile('utilities', 'rebuild_s_functions.m');  
file = findFile(project, pathToLocate);
```

Examine the `Labels` property to get an array of Label objects, one for each label attached to the file.

```
labels = file.Labels;  
disp(labels);
```

Label with properties:

```
File: "C:\workSpace\examples\airframe2\utilities\rebuild_s_functions.m"  
DataType: 'none'  
Data: []  
Name: "Design"  
CategoryName: "Classification"
```

To find a label by name, use `findLabel` on the file object.

```
label = findLabel(file, 'Classification', 'Design');  
disp(label);
```

Label with properties:

```
File: "C:\workSpace\examples\airframe2\utilities\rebuild_s_functions.m"  
DataType: 'none'  
Data: []
```

```
Name: "Design"  
CategoryName: "Classification"
```

Create a New Category

You must create new labels before you can attach them to a file. You define labels in categories, giving each category a name and supported data type.

The following code creates a category of labels called Engineers which can be used to denote file ownership in a project. These labels have the char datatype for attaching String data.

```
createCategory(project, 'Engineers', 'char');  
engineersCategory = findCategory(project, 'Engineers');  
createLabel(engineersCategory, 'Sam');  
createLabel(engineersCategory, 'Pat');  
createLabel(engineersCategory, 'Alex');
```

You can now attach an Sam label from the 'Engineers' category to a file in the project.

```
addLabel(file, 'Engineers', 'Sam');  
label = findLabel(file, 'Engineers', 'Sam');
```

Set Label Data

The following command sets the data for the attached label.

```
label.Data = 'Maintenance responsibility';  
disp(label)
```

Label with properties:

```
File: "C:\workSpace\examples\airframe2\utilities\rebuild_s_functions.m"  
DataType: 'char'  
Data: 'Maintenance responsibility'  
Name: "Sam"  
CategoryName: "Engineers"
```

Further Information

“Project Management”

Run Custom Tasks with a Project

This example shows how to apply a custom task to a set of files managed by project. The example custom task analyzes the Simulink models which are in the project and reports the number of blocks in each model.

Set Up the Example Files and Open the Project

1. Create and open a working copy of the project example files. MATLAB® copies the files to an example folder so that you can edit them.

```
sldemo_slproject_airframe;
```

```
Building with 'MinGW64 Compiler (C)'.  
MEX completed successfully.
```

Select a Custom Task

2. On the **Project** tab, click the down arrow to expand the **Tools** gallery. Under **Project Checks**, click **Custom Tasks**.

You define a custom task with a MATLAB® function. The example Airframe project contains example custom tasks in the *custom_tasks* folder.

3. The **Custom task** menu lists available custom tasks.

To view, edit, and create custom tasks, on the **Project** tab, click the down arrow to expand the **Tools** gallery. Under **Project Checks**, click **Custom Tasks**. In the Custom Task dialog box, click **Manage**.

4. Select the *Analyze Model Files* custom task.

The function name of your selected custom task appears in the **Custom task** field. The example *analyzeModelFiles* adds a label from the category *Metrics* to each model file in the project. Labels in this category have numerical data. The custom task counts the number of blocks in each model and attaches this number to the label.

Select Files to Include in the Custom Task

5. In the Custom Task dialog box, in the **Include** column, verify that all the model files check boxes are selected.

Run a Custom Task

6. To run the custom task, click **Run Task**.

The results for a selected file are shown in the **Results** pane at the bottom of the dialog box. This can be useful when the returned results are long, or contain HTML markup.

The following example shows the dialog box after running the custom task on some models. You can customize the columns to show with the cog icon button .

The screenshot shows the 'Custom Task Report - analyzeModelFiles' window. The task is 'analyzeModelFiles', it has run on 23 files, and was completed at 13/08/2019 08:23. The report table lists the following files and their results:

| Name | Path | Results |
|-----------------------|------------------|-----------------|
| controller.sldd | \$(data) | |
| DigitalControl.slx | \$(models) | Block Count: 47 |
| f14_airframe.slx | \$(models) | Block Count: 28 |
| f14_airframe_test.m | \$(tests) | |
| find_top_models.m | \$(utilities) | |
| LinearActuator.slx | \$(models) | Block Count: 8 |
| NonLinearActuator.slx | \$(models) | Block Count: 9 |
| readme.txt | \$(lib) | |
| rebuild_s_functions.m | \$(utilities) | |
| runUnitTest.m | \$(custom_tasks) | |
| slproject_f14.pdf | \$(reports) | |
| slproject_f14.slx | \$(models) | Block Count: 39 |

The 'Results' section for DigitalControl.slx shows: Block Count: 47.

At the bottom of the window, the 'Custom task' is set to 'analyzeModelFiles'. A status bar at the bottom indicates '15 files are included but not shown in the current view'.

Edit an Existing Custom Task

Custom Tasks are MATLAB functions. Edit your custom task with the MATLAB Editor. For example, modify the custom task to programmatically add a label with data, as well as saving any dirty model files.

7. Run the following MATLAB code to create a Metrics category and a Block Count label in the project.

```
project = currentProject;
category = createCategory(project, 'Metrics', 'double');
```

8. Double-click *analyzeModelFiles.m* to edit it in the MATLAB Editor.

9. Add the following lines just after the `sprintf` command:

```
[~, compileStats] = sldiagnostics(name, 'CompileStats');
addLabel(projectFile, 'Metrics', 'CPU Compile Time', sum([compileStats.Statistics.CPUTime]));
```

You can use the MATLAB Editor to set breakpoints and debug a custom task function, just as with any other MATLAB function.

If you rerun the custom task, it adds the CPU Compile Time label to each model file that can be compiled, and attaches data to the label showing the total time for all compilation phases for the model. Models that cannot be compiled show **Failed to analyze file** in the Custom Task Report, and details display as a warning in the Command Window. Examine the custom task *analyzeModelFiles.m* to see how to handle errors.

To view the new metrics data, either show the **Metrics** column in the Custom Task Report, or look in the project **Files** view.

Create a New Custom Task

Create a new custom task by creating a new MATLAB function. Your custom tasks must:

- Be saved on the MATLAB path.
- Accept a single input argument: a full path to a file.
- Return a single output argument.

To create custom tasks, on the **Project** tab, click the down arrow to expand the **Tools** gallery. Under **Project Checks**, click **Custom Tasks**. In the Custom Task dialog box, click **Manage**. In the Manage Custom Tasks dialog box, click **Add** to open a new file with instructions that guide you to create a custom task with the correct function signature.

10. Select **Add>Add Using New Script**.

A file dialog opens asking you to choose where to create the new custom task. The custom task must be saved on the MATLAB path to run.

11. Provide a file name and save the file in the *custom_tasks* folder within the project.

The MATLAB editor opens the file pre-populated with a simple example custom task.

12. To create your new custom task, edit the contents of the example custom task function and save.

Further Information

“Project Management”

Upgrade Simulink Models Using a Project

Easily upgrade all the models in your project using the Upgrade Project tool in a project.

Setting Up the Example Files and Opening the Project

Run the following commands to create and open a working copy of the project files.

```
sldemo_slproject_airframe;
```

```
Building with 'MinGW64 Compiler (C)'.  
MEX completed successfully.
```

The project example copies files to a new folder so that you can edit them and use them under Git version control. Placing your files under version control lets you compare the upgraded model files with the original versions.

Automatically Upgrade All Project Models and MATLAB Code at Once

Upgrade all models and MATLAB code in your project to the latest release using a simple workflow. The Upgrade Project tool can apply fixes automatically when possible, upgrade all model hierarchies in the project at once, and produce a report.

On the Project tab, click the down arrow to expand the Tools gallery. Under Project Checks, click Upgrade Project.

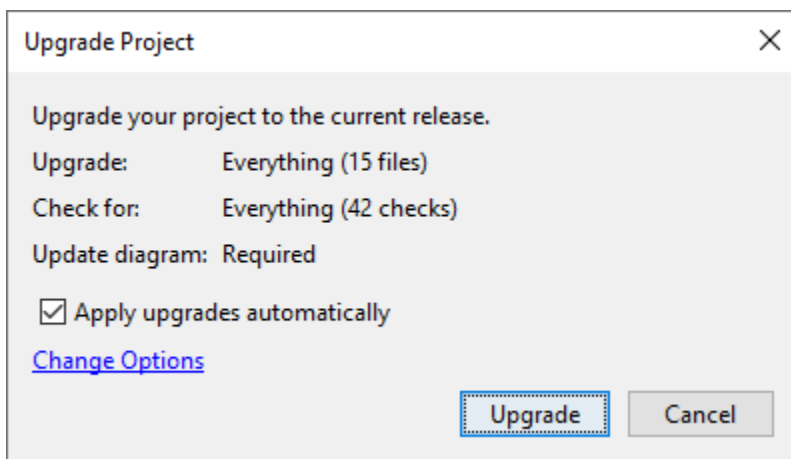

This loads the upgrade advisor checks and runs a dependency analysis on your project to ensure the project hierarchy is handled correctly.

Click Upgrade to run all upgrade checks on all models, libraries and MATLAB code in your project. If any check fails and there is a fix available, the project automatically applies the fix and runs the relevant checks again to ensure they now pass.

Inspect the results of the upgrade in the report.

The screenshot shows the 'Upgrade Project Report' window. At the top, a large green circle indicates '100% Passed'. Below this, a summary table shows the results for Models, Libraries, and MATLAB Code. The 'AnalogControl.slx' project is selected, and its details are shown in the main pane. A list of checks is displayed, all of which passed. The 'Turn off SLX file compression' check is highlighted, with a 'Learn more' link. The overall status is 'Passed'.

| Category | Passed | Need attention |
|-------------|--------|----------------|
| Models | 7 | - |
| Libraries | 1 | - |
| MATLAB Code | 7 | - |

| Check Name | Result |
|--|--------|
| Turn off SLX file compression | ✓ |
| Return all simulation outputs as a single Simulink.SimulationOutput object | ✓ |
| Resave in current version of Simulink | ✓ |
| Identify variant blocks using variant objects with empty conditions | ✓ |
| Identify Model Variants blocks and convert those to Variant Subsystem blocks containing Model block choi... | ✓ |
| Identify Model Info blocks that can interact with external source control tools | ✓ |
| Identify masked blocks that specify tabs in mask dialog using MaskTabNames parameter | ✓ |
| Identify configurable subsystem template blocks having the instances in the model for converting to varia... | ✓ |

Checks run on 08/08/2020 11:24

Further Information

“Project Management”

“Model Upgrades”

“Upgrade All Project Models, Libraries, and MATLAB Code Files”

Export a Subset of a Project Using an Export Profile

This example shows how to export a release version of a project using an export profile. The example export profile streamlines the exported project by removing files from the project which are only useful for the development of the project, but are not necessary for running the project's top-level models.

Set Up the Example Files and Open the Project

1. Run the following commands to create and open a working copy of the airframe project.

```
sldemo_slproject_airframe;  
  
Building with 'MinGW64 Compiler (C)'.  
MEX completed successfully.
```

The classification label set is used to define the purpose of each file in the project. This example project adds several new labels to the 'classification' label set: 'analysis', 'upgrade', and 'utility'. These labels are used to identify files which are used for custom analysis tasks, upgrading to the latest version and general purpose utility functions.

Some files in the project are useful for the development of the project, but do not need including in a release version of the project when it is exported. For this example, files labelled in the project with the labels 'analysis', 'test', 'upgrade' and 'artifact' do not need including in the release version of the project.

This example demonstrates how the export profile management feature can be used to exclude files from a project export based on the attached labels.

Open the Export Profile Manager Tool

To view the available export profiles for a project:

2. Click the "Share" button in the Project toolbar tab.
3. Select the menu item "Manage Export Profiles..."

The Manage Export Profiles dialog box will appear.

The left hand panel shows all of the defined export profiles. The airframe project defines one export profile called 'Release', which should be already be selected in the dialog box.

The export profile shows two panels. The first panels shows the labels which will cause a file to not be exported if attached to a file. The release profile has been defined such that any file which has the 'analysis', 'test', 'artifact', or 'upgrade' label attached will not be exported.

The second panel defines labels which will not be included in the exported project. Here the labels 'analysis' and 'upgrade' are removed because no files in the exported project will use them.

The export profile interface allows new profiles to be defined and existing profiles to be removed.

Using an Export Profile When Exporting a Project

To use an export profile:

4. Click the "Share" button in the Project toolbar tab.

5. Select the "Zip Archive".

6. In the project archive dialog, select the export profile to be applied. Select the 'Release' profile to use the profile that is defined by the airframe project.

7. Click the Archive button to export the project using the selected export profile.

Further Information

"Project Management"

Create and Reference a Project Programmatically

This example shows how to programmatically create a new project and add it as a reference project in your main project. It covers how to create a project from the command line, add files and folders, set up the project path, define project shortcuts and create a reference to the new project in another project.

Set up the Example Files

1. Create a working copy of the `Airframe Example` project and open the project. MATLAB® copies the files to an `examples` folder so that you can edit them. Use `currentProject` to create a project object from the currently loaded project.

```
sldemo_slproject_airframe_api;
mainProject = currentProject
```

```
mainProject =
```

```
Project with properties:
```

```

        Name: "Airframe Example"
SourceControlIntegration: "Git"
  RepositoryLocation: "C:\workSpace\examples\repositories\airRef9"
SourceControlMessages: ["Current branch: master"      "No remote tracking branch"      "Branch
        ReadOnly: 0
        TopLevel: 1
Dependencies: [1x1 digraph]
  Categories: [1x1 matlab.project.Category]
        Files: [1x22 matlab.project.ProjectFile]
  Shortcuts: [1x5 matlab.project.Shortcut]
  ProjectPath: [1x4 matlab.project.PathFolder]
ProjectReferences: [1x1 matlab.project.ProjectReference]
  StartupFiles: [1x0 string]
  ShutdownFiles: [1x0 string]
DefinitionFileType: FixedPathMultiFile
  Description: "This example project demonstrates the Project referencing feature
  RootFolder: "C:\workSpace\examples\airRef9\airRef"
  SimulinkCacheFolder: "C:\workSpace\examples\airRef9\airRef\work\cache"
  ProjectStartupFolder: "C:\workSpace\examples\airRef9\airRef"
  SimulinkCodeGenFolder: "C:\workSpace\examples\airRef9\airRef\work\codegen"
```

The `Airframe Example` project is a top level project (`TopLevel: 1`) with one referenced project (`ProjectReferences: [1x1]`).

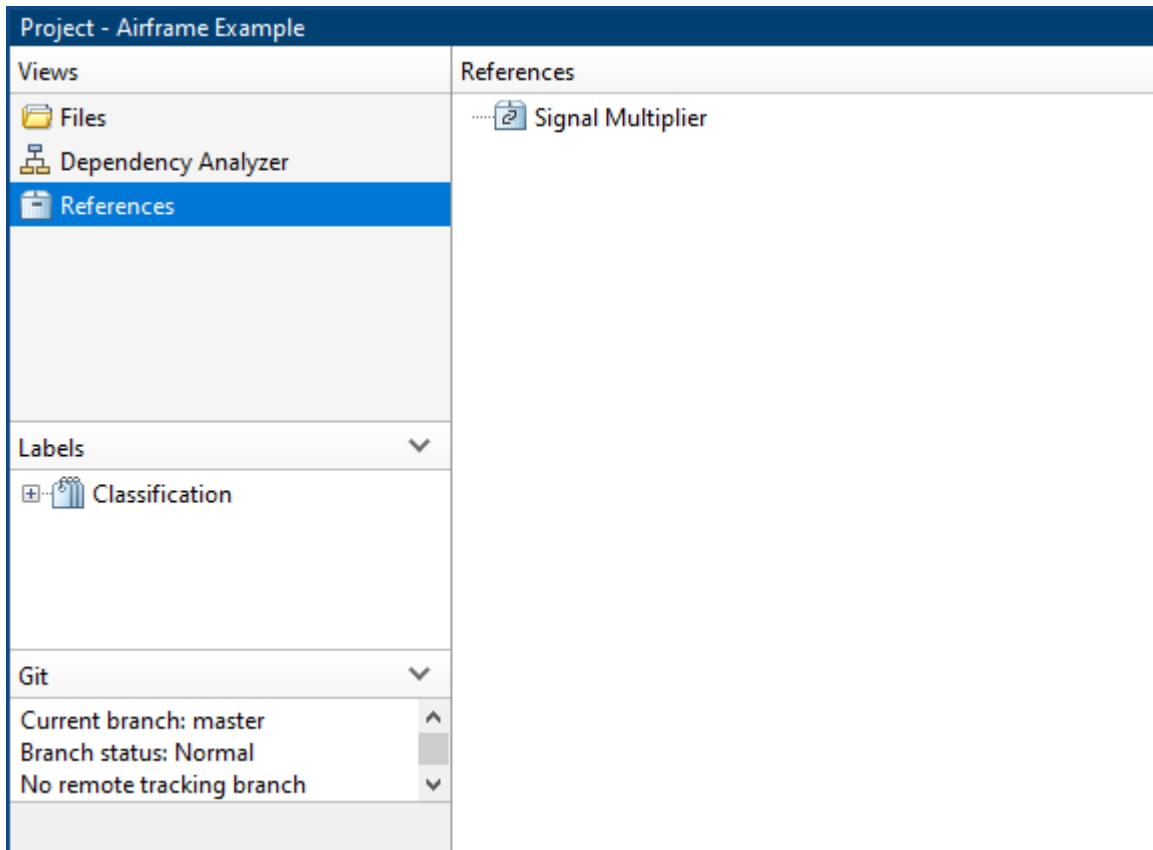

Create New Project

2. Create a new project called Wind Gust Library. Airframe project will use Wind Gust Library through a project reference.

a. Create a blank project and set the project name.

```
windGustFolder = fullfile(mainProject.RootFolder, "..", "WindGustLibrary");
windGust = matlab.project.createProject(windGustFolder);
windGust.Name = "Wind Gust Library";
```

b. Add the data folder and the wind_gust_lib.slx file to the Wind Gust Library project.

```
addFolderIncludingChildFiles(windGust, "data");
addFile(windGust, "wind_gust_lib.slx");
```

c. Add the data folder and the Wind Gust Library project root folder to the Wind Gust Library project path. This makes the files available when the Airframe Example project or any project that references the Wind Gust Library project is loaded.

```
addPath(windGust, "data");
addPath(windGust, windGust.RootFolder);
```

d. Create a Wind Gust Library project shortcut.

```
shortcut = addShortcut(windGust, "wind_gust_lib.slx");
shortcut.Group = "Top Level Model";
```

Add a Project Reference

3. Add the new Wind Gust Library project to the Airframe Example project as a project reference. This allows the Airframe Example project to view, edit, and run files in the Wind Gust Library project.

```
reload(mainProject);
addReference(mainProject,windGust)

ans =
    ProjectReference with properties:
        Project: [1x1 matlab.project.Project]
        File: "C:\workSpace\examples\airRef9\WindGustLibrary"
        StoredLocation: "../WindGustLibrary"
        Type: "Relative"
```

The main project Airframe Example references the Wind Gust Library stored in "../refs/Wind Gust Library".

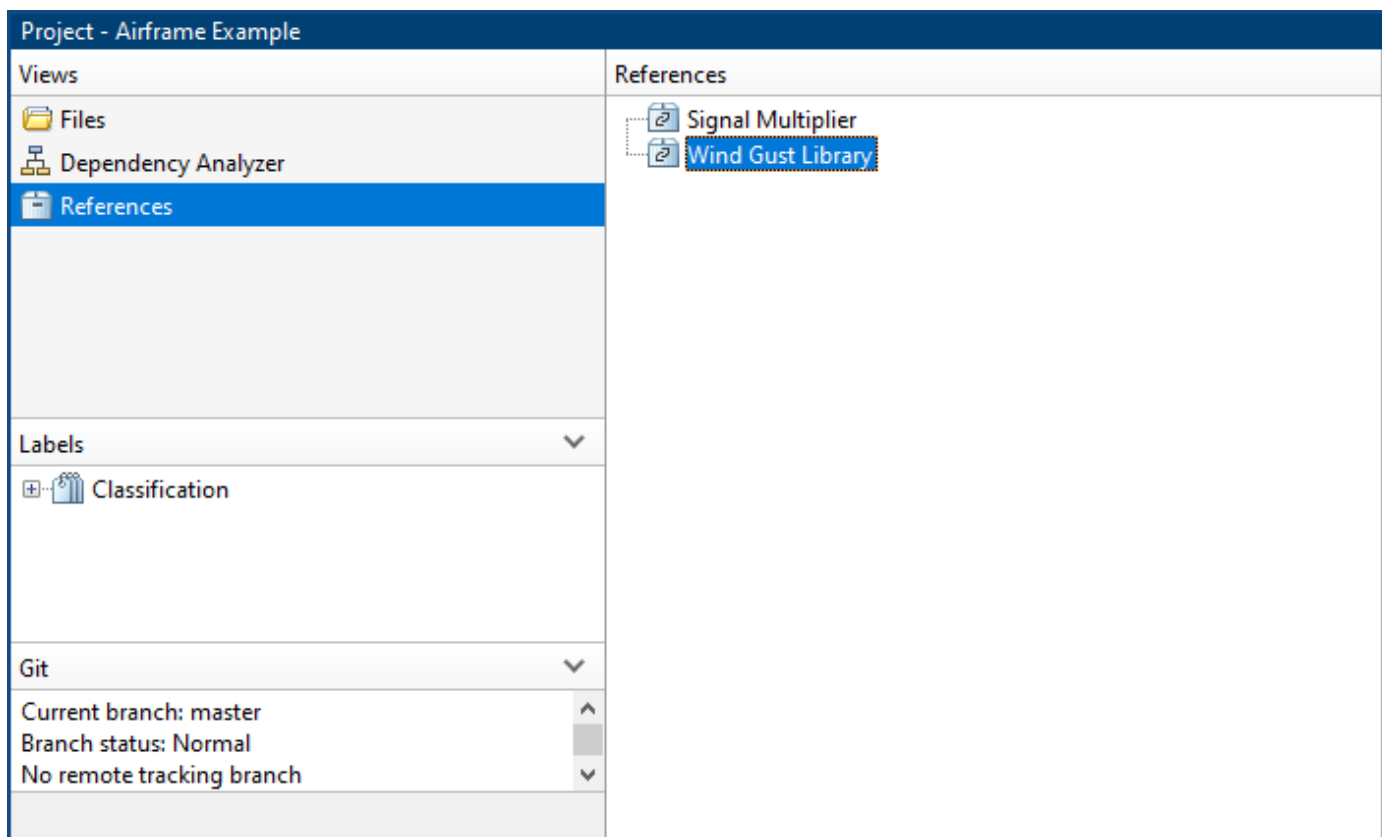

4. Use ProjectReferences method to query the Wind Gust Library project.

```
mainProject.ProjectReferences(2).Project

ans =
    Project with properties:
```

```
        Name: "Wind Gust Library"
SourceControlIntegration: ""
  RepositoryLocation: ""
  SourceControlMessages: [1x0 string]
    ReadOnly: 1
    TopLevel: 0
  Dependencies: [1x1 digraph]
    Categories: [1x1 matlab.project.Category]
    Files: [1x3 matlab.project.ProjectFile]
    Shortcuts: [1x1 matlab.project.Shortcut]
    ProjectPath: [1x2 matlab.project.PathFolder]
  ProjectReferences: [1x0 matlab.project.ProjectReference]
  StartupFiles: [1x0 string]
  ShutdownFiles: [1x0 string]
  DefinitionFileType: FixedPathMultiFile
  Description: ""
  RootFolder: "C:\workSpace\examples\airRef9\WindGustLibrary"
```

The Wind Gust Library project is not a top level project (TopLevel: 0). It is referenced by the top level project Airframe Example (TopLevel: 1).

Close Project

5. Close the project to run shutdown scripts and check for unsaved files.

```
close(mainProject)
```

See Also

“Componentization of Large Projects”

Compare and Merge Simulink Models

This example shows how to use the comparison report in MATLAB® to understand what has changed between two different designs. It shows how to view and merge the changes between two Simulink® models from the comparison report.

Comparing Models

Create a working copy of the example files. MATLAB® copies the files to an example folder so that you can edit them.

```
slcomparisons.examples.simulinkMerge;
```

A user made some changes to the model `sl_aircraft1` and saved the resulting model as `sl_aircraft2`.

Use `visdiff` to compare the `sl_aircraft1` and `sl_aircraft2` models.

```
visdiff('sl_aircraft1','sl_aircraft2');
```

Understanding Results

The Comparison Tool shows a report that only includes the differences between the two models, not the complete model hierarchies.

Colors indicate if items have been modified (purple), inserted (blue), or deleted (yellow).

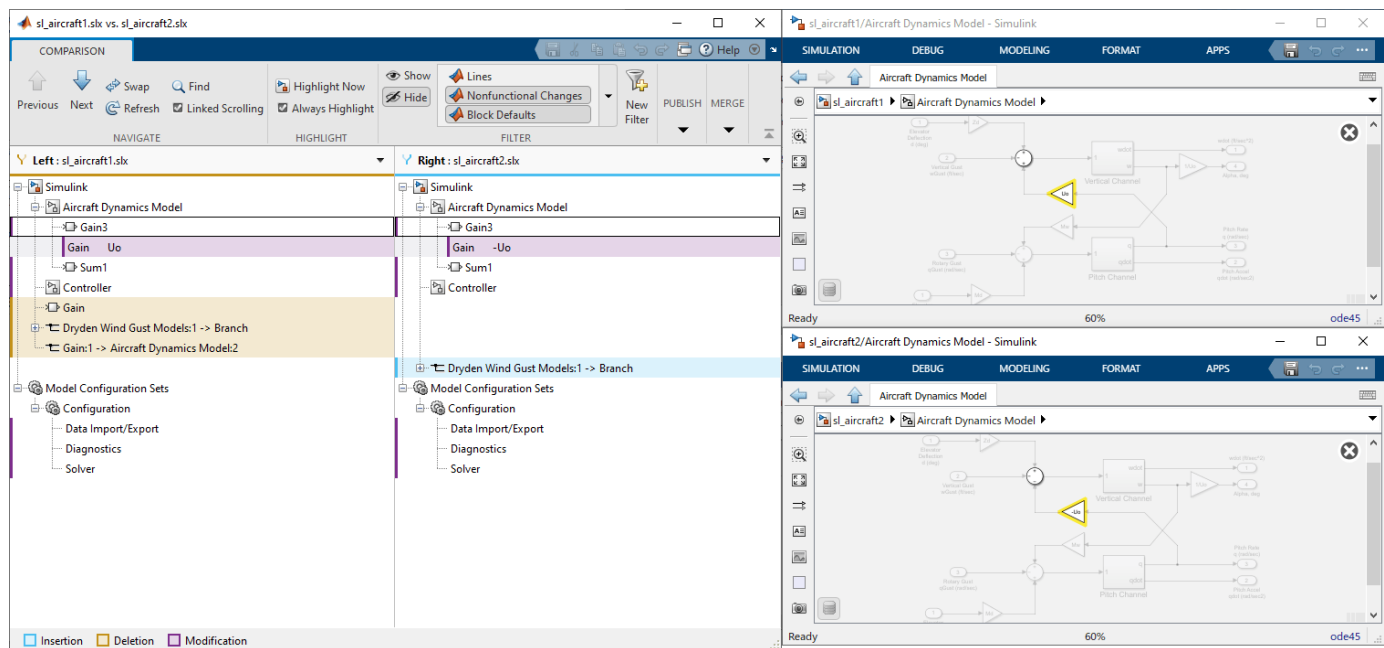

Stepping Through Differences

Use the **Next** and **Previous** navigation buttons on the **Comparison** tab to step through groups of changes in the report:

- The report goes through the changes one by one. If the selected item in the **Left** tree has a match, it will also be selected in the **Right** tree.

- MATLAB displays both models next to the report. The report highlights the selected items in both Simulink models if it is possible.

To control highlighting in models, on the **Comparison** tab, in the **Highlight** section, select or clear the check box **Always Highlight**. You can click the **Highlight Now** button to highlight the currently selected report node at any time.

Filtering Results

You can control the type of changes displayed in the comparison report by applying filters. To see the available filters and whether or not they are applied to the current report, on the **Comparison** tab, in the **Filter** section, click the down arrow to expand the filter gallery. Click filter names to toggle whether they are applied. In the **Filter** section, click **Show** or **Hide** to control how the filters are applied.

For example, some information in the Simulink model file is defined as being nonfunctional. These are changes that are unlikely to change the behavior of the design. Nonfunctional items are hidden by default. You can show them by deselecting the **Nonfunctional Changes** button when the **Hide** filter button is selected.

Publish Results

To save a printable version of a model comparison report, select **Publish > HTML, Word, or PDF**.

Merge Changes in Simulink Models

You can merge the changes between the two Simulink models by clicking the **Merge Mode** button in the toolbar. This creates a third file, `targetFile`, which can contain the changes from either the left model (`sl_aircraft1`) or right model (`sl_aircraft2`). Use the buttons in the **Target** tree to select the differences to keep in the `targetFile`.

Click the **Save File** button to save the changes you selected over the right model (`sl_aircraft2`).

Tip: Merge blocks before lines, and merge states and junctions before merging transitions. See “Merging Tips”.

See Also

`visdiff`

Further Information

“Compare Simulink Models”

“Comparing Models with Identical Names”

Related Examples

“Compare and Merge Simulink Models Containing Stateflow” on page 13-521

“Resolve Conflicts with Simulink Three-Way Merge” on page 13-524

Compare and Merge Simulink Models Containing Stateflow

This example shows how to use the comparison report in MATLAB® to understand what has changed between two different designs. It shows how to view and merge the changes between two Simulink® models containing Stateflow® using the comparison report. A Stateflow license is required to run this example.

Compare Models

Create a working copy of the example files. MATLAB® copies the files to an example folder so that you can edit them.

```
slcomparisons.examples.stateflowMerge;
```

A user added a new kickdown mode to the `shift_logic`. You can use the Simulink Model Comparison to compare the two models and produce a report to explore and merge the differences.

Use `visdiff` to compare the `sl_sfcar_1` and `sl_sfcar_2` models.

```
visdiff('sl_sfcar_1','sl_sfcar_2');
```

Understand Results

The Comparison Tool shows a report that only includes the differences between the two models, not the complete model hierarchies.

Colors indicate if items have been modified (purple), inserted (blue), or deleted (yellow).

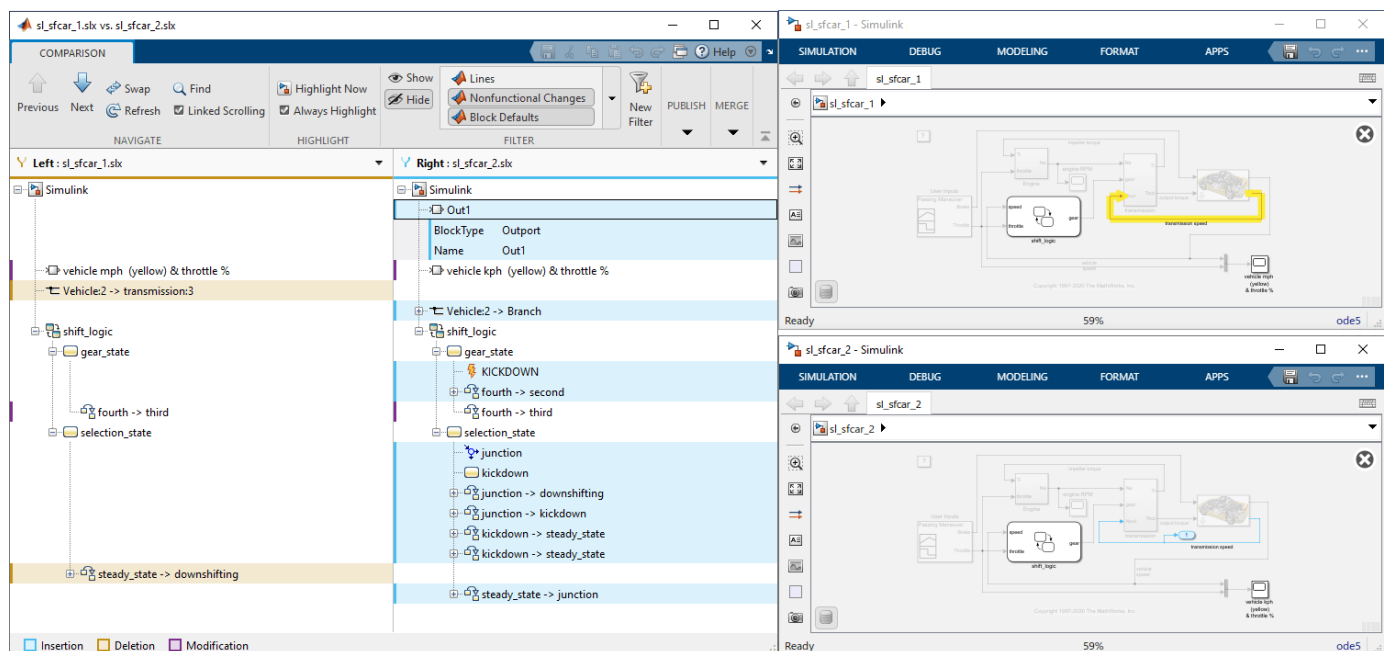

Stepping Through Differences

Use the **Next** and **Previous** navigation buttons on the **Comparison** tab to step through groups of changes in the report:

- The report goes through the changes one by one. If the selected item in the **Left** tree has a match, it will also be selected in the **Right** tree.
- MATLAB displays both models next to the report. The report highlights the selected items in both Simulink models if it is possible.

Highlight Differences in the Simulink Models

Select the tree node Out1 in the **Right** tree. Observe the report highlights Out1 in the report, and the corresponding block in the model sl_sfcar_2.

To control highlighting in models, on the **Comparison** tab, in the **Highlight** section, select or clear the check box **Always Highlight**. You can click the **Highlight Now** button to highlight the currently selected report node at any time.

Highlight Differences in a Stateflow Chart

Browse down the tree to locate the Stateflow charts in the report. Observe the Stateflow chart icon next to the shift_logic node. Click kickdown in the **Right** tree. The report displays both shift_logic Stateflow charts. Observe where the new kickdown functionality has been added to one of the charts.

Filtering Results

You can control the type of changes displayed in the comparison report by applying filters. To see the available filters and whether or not they are applied to the current report, on the **Comparison** tab, in the **Filter** section, click the down arrow to expand the filter gallery. Click filter names to toggle whether they are applied. In the **Filter** section, click **Show** or **Hide** to control how the filters are applied.

For example, some information in the Simulink model file is defined as being nonfunctional. These are changes that are unlikely to change the behavior of the design. Nonfunctional items are hidden by default. You can show them by deselecting the **Nonfunctional Changes** button when the **Hide** filter button is selected.

Merge Changes in Models Containing Stateflow

You can merge the changes between the two Simulink and Stateflow models by clicking the **Merge Mode** button in the toolbar. This creates a third file, targetFile, which can contain the changes from either the left model or right model. Use the buttons in the **Target** tree to select the differences to keep in the targetFile.

Click the **Save File** button to save the changes you selected over the right model (sl_sfcar_2).

Tip: Merge blocks before lines, and merge states and junctions before merging transitions. See “Merging Tips”.

See Also

visdiff

Further Information

“Compare Simulink Models”

“Comparing Models with Identical Names”

Related Examples

“Compare and Merge Simulink Models” on page 13-519

“Resolve Conflicts with Simulink Three-Way Merge” on page 13-524

Resolve Conflicts with Simulink Three-Way Merge

This example shows you how to use Simulink® Three-Way Merge to resolve conflicts in Simulink models. You can view and merge the Simulink model differences in the resulting report.

Set up the Example Project

Create and open a working copy of the example project. MATLAB® copies the files to an example folder so that you can edit them.

```
slcomparisons.examples.simulinkThreeWayMerge;
```

```
Building with 'MinGW64 Compiler (C)'.  
MEX completed successfully.
```

Simulink Model Changes and Conflicts

The example project is under Git™ source control. You attempt to merge the changes of another user on the master Git branch into your TaskBranch. This operation results in conflicts.

To resolve the conflicts using the Three-Way Model Merge tool, this example shows how to examine your local file (**Mine**), the conflicting revision (**Theirs**) and the common ancestor of these two files (**Base**).

Theirs: Another user updated the pilot model subsystem to use an explicit gain block for the amplitude of the pilot's input commands. He also updated the Simulation stop time.

Mine: You changed some configuration settings for the pilot model subsystem.

The Merge tool automatically merges nonconflicted differences. Follow the steps below to review the automerge choices, edit if desired, and decide how to resolve any remaining differences. After resolving the conflicts, commit the resolved model to source control.

Open Simulink Three-Way Merge

Look for conflicted files in the project files view. The `slproject_f14` file shows a red warning symbol in the Git column, which indicates a conflict.

1. To see a detailed report of the conflicts, right-click the `slproject_f14` file and select **View Conflicts**.

View Changes

The Three-Way Merge tool shows the changes to the two Simulink designs that have caused this file conflict.

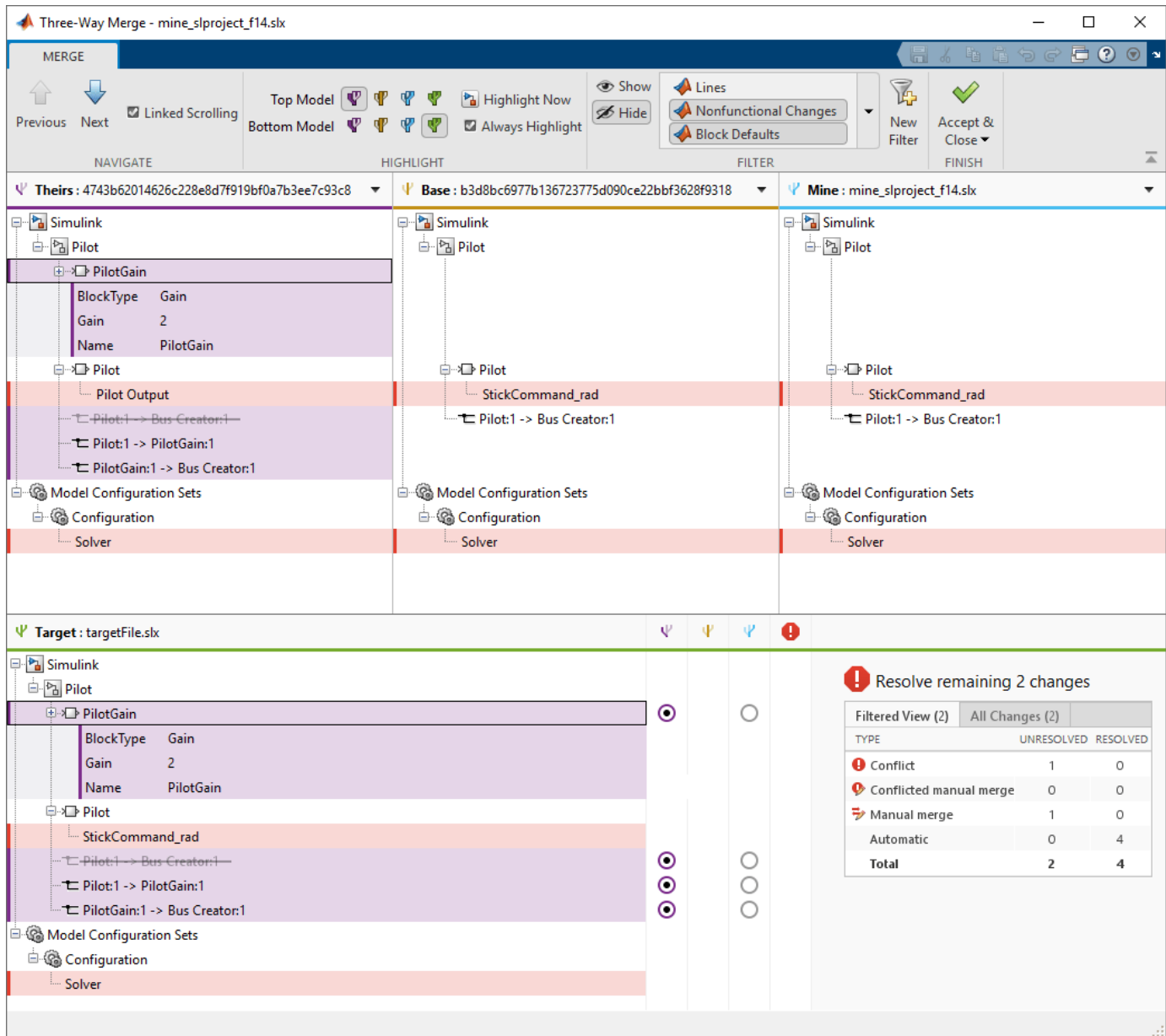

- The **Theirs**, **Base** and **Mine** trees show the differences between the conflicting revision, your revision, and the base ancestor of these files.
- The **Target** tree shows the file that you will merge changes into. This is a temporary file and will be copied into the project when you choose to accept the merge result.

2. Examine a difference by clicking a row in one of the trees. The merge tool displays the change for each model in an editor, for example the Simulink Editor or Configuration Parameters dialog box, to the right of the Three-Way Merge window.

3. On the **Merge** tab, in the **Highlight** section, choose the models to display with the **Top Model** or **Bottom Model** buttons.

Review Automatic Merges

The merge tool automatically merges most nonconflicted differences.

4. Examine the first change at the top of the **Theirs** tree by clicking the row called `PilotGain`. This node has been merged automatically and you can adjust the automatic choices using the buttons in the **Target** tree. If you want, review the other automatic merge choices.

Resolve Conflicts

There are two types of difference that require user action.

Conflict: The merge tool cannot automatically resolve these differences and you need to choose which design you want in the target file. In the **Target** pane, look for warnings in the conflict column



Manual merge: Some differences must be merged manually in Simulink or ignored. In the **Target**

pane, these items are indicated by a pencil icon in the conflict column

5. Select the `StickCommand_rad` row. This difference requires a manual merge, indicated by a pencil icon in the conflict column .

Resolve the line change difference in the `targetFile` by renaming the line connected to the output of the block named `Pilot` in the Simulink Editor from `StickCommand_rad` to `Pilot Output`.

After resolving the difference save the changes in the Editor, and mark the change resolved using the manual merge control in the Conflicts column.

The merge report does not update to show any changes you make in the Editor.

6. Use the **Next** toolbar button to review and resolve the changes until you reach a conflict. This `StopTime` parameter has been changed by both users and is conflicted. Resolve the conflict using the **Mine** change. Select the button next to `StopTime` in the mine column in the **Target** pane.

Change Filters

By default, the report hides all nonfunctional changes, such as the repositioning of items.

7. On the **Merge** tab, in the **Filter** section, turn on and off filters to explore the different changes between these designs.

Accept Changes

8. After you resolve all filtered and unfiltered changes, click **Accept & Close**. The merge tool closes the report and the models, accepts the merge result in the `targetFile`, and marks the conflict as resolved in the source control tool. You can now commit changes to source control and continue your work.

Further Information

“Compare Simulink Models”

“Source Control in Projects”

“Resolve Conflicts”

“Compare Revisions”

“Customize External Source Control to Use MATLAB for Diff and Merge”

Related Examples

“Compare and Merge Simulink Models” on page 13-519

“Compare and Merge Simulink Models Containing Stateflow” on page 13-521

Call C Functions Using C Caller Block

This example shows how to use the C Caller block to call your handwritten C functions.

In this example, four custom C functions are defined in `my_func.h`, and implemented in `my_func.c`.

The header file and the source file are specified in "**Model Configuration Parameters > Simulation Target**". Then C functions can be called via C Caller blocks. For example, the block 'add' adds a signal and a constant together, and the block 'timesK' multiplies the signal by a parameter K. C Caller block supports C structure and enumeration types. Use command "**Simulink.importExternalCTypes**" to import these types into Simulink as matching `Simulink.Bus` object or `Simulink.IntEnumType`.

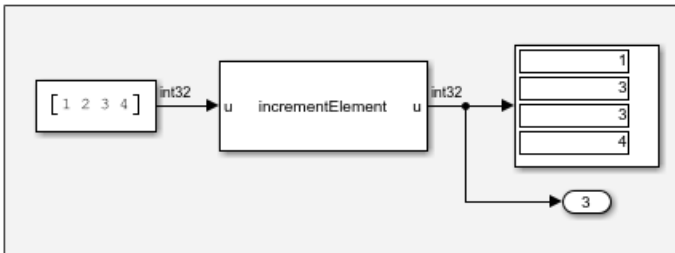
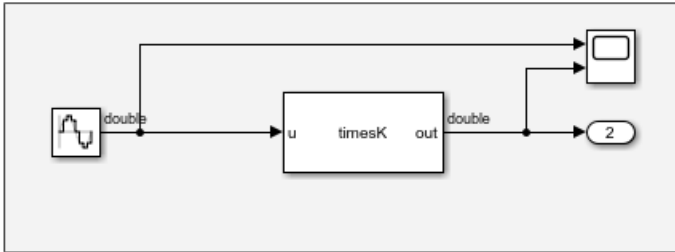
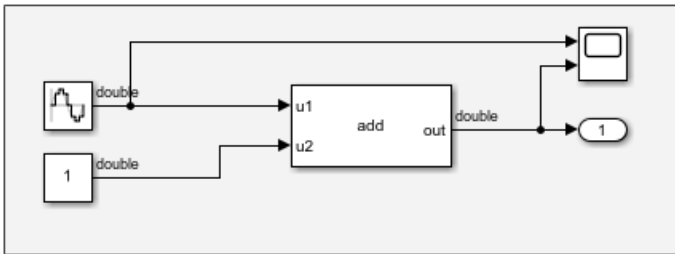

Call C Functions Using C Caller Block

?

my_func.h

my_func.c

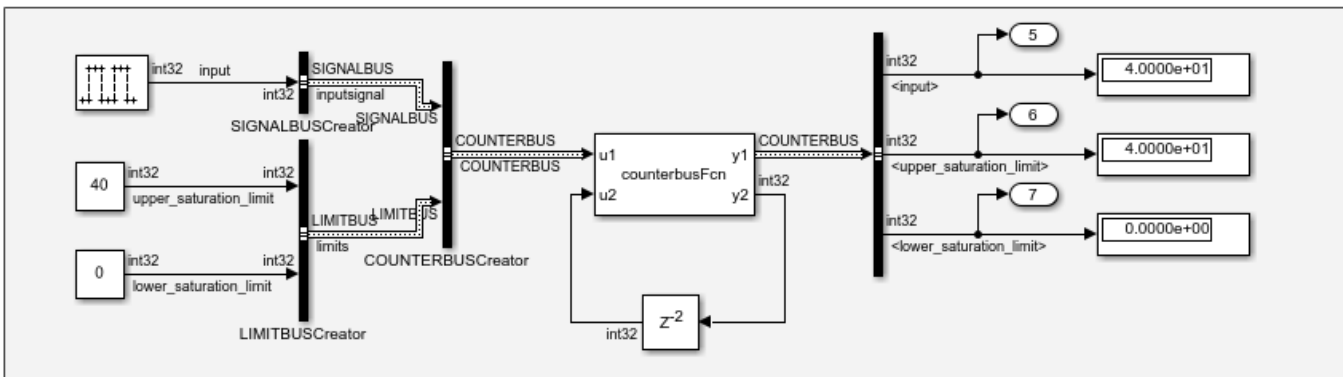
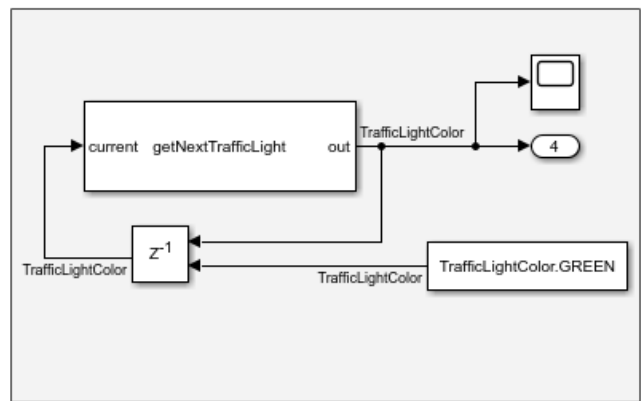

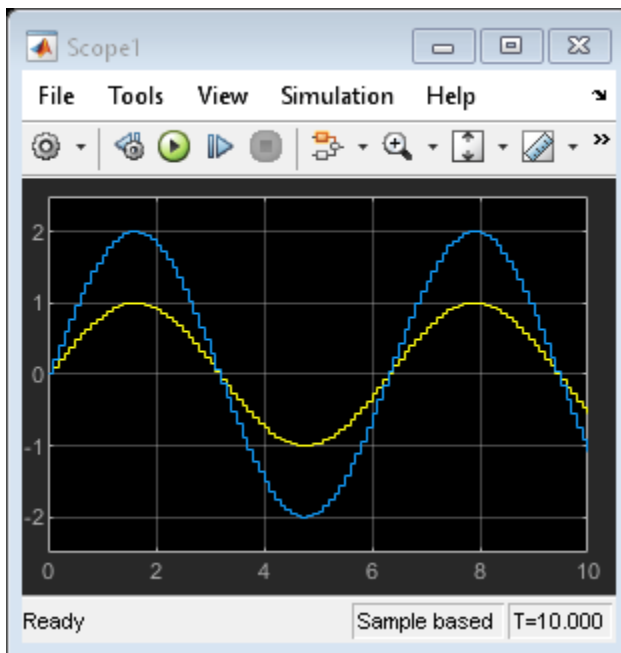
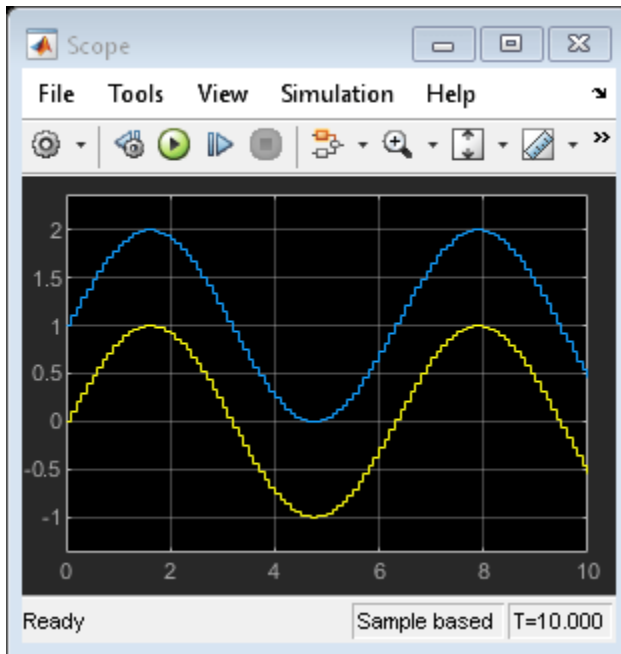

Set up custom C code in model configuration

Add '#include "my_func.h"' to "**Configuration Parameters > Simulation Target > Header File**" field.

Add 'include' to "**Configuration Parameters > Simulation Target > Include directories**" field.

Add 'src/my_func.c' to "**Configuration Parameters > Simulation Target > Source Files**" field.

See Also

C Caller

Related Examples

- "Integrate C Code Using C Caller Blocks"

Bring Custom Image Filter Algorithms as Reusable Blocks in Simulink

This example shows how to bring in C code image filter algorithms using C Caller blocks in a reusable Simulink library.

In this example, three image filter blocks are C Caller blocks in a library model. Their dependent C code is specified in the library model custom code settings.

The image filter C functions are implemented using "Row-major" array layout. Library custom code settings have "Default function array layout" set accordingly to "Row-major".

These library image filter blocks can be reused by adding them to models.

```
model = 'slexCCallerExampleImageFilter';
open_system(model);
```

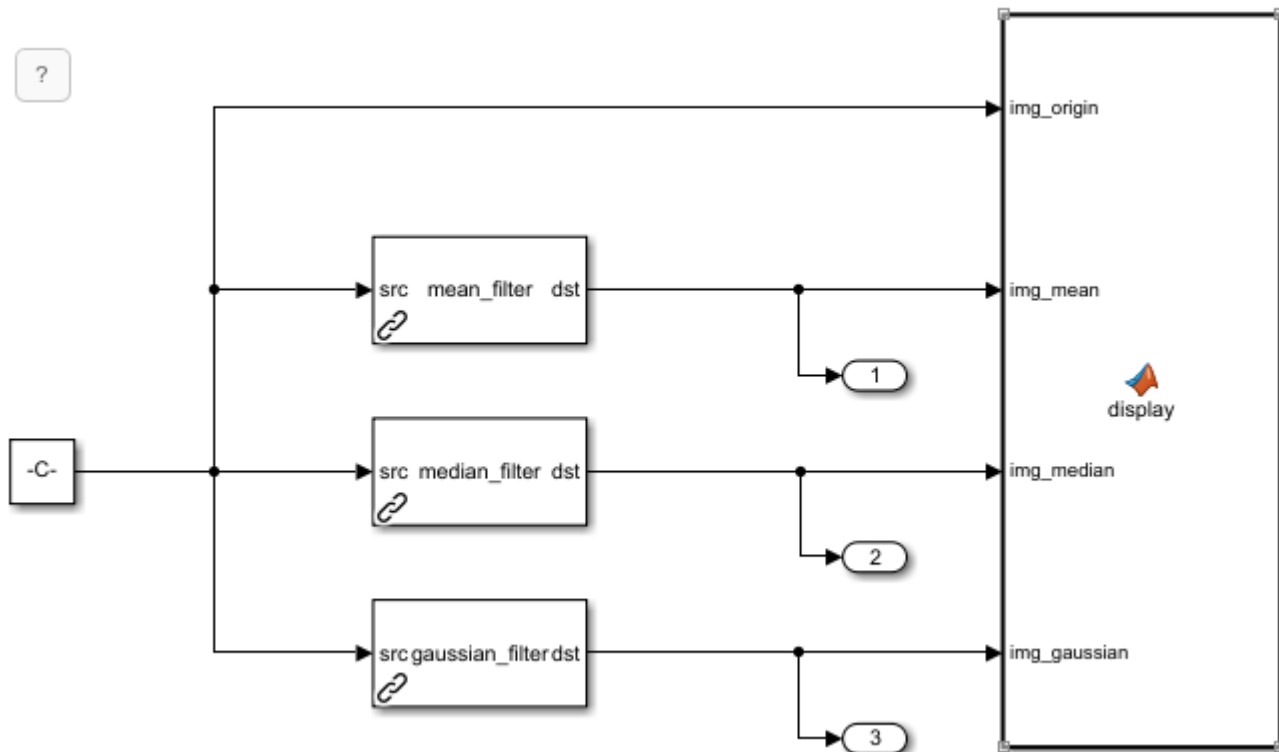

As the simulation runs, the MATLAB Function block displays the filtered images.

```
evalc('sim(model)');
```



```
slcc('clearCustomCodeModules'); % unload custom libs before delete slprj folder
```

See Also

C Caller

Related Examples

- “Integrate C Code Using C Caller Blocks”

Custom Code and Hand Coded Blocks using the S-function API

This library launches examples of different types of Simulink® S-functions. Simulink S-functions allow you to extend Simulink with new hand coded blocks, interface to custom external code, and create live interfaces to other programs. Use this example to access models containing S-functions in the C, C++, M, and Fortran.

Each example contains a model that exercises an S-function block and a link for editing the S-function code. You can also access the main S-function file by using the Edit button on the S-function block dialog. In some of the models, use **Look Under Mask** to access the S-function. Additionally, the S-function Builder block is a masked version of the S-function block. The block includes an editor that builds an S-function out of a core algorithm.

By default, the S-function Builder also creates a TLC file for use with Simulink® Coder™ and Embedded Coder™.

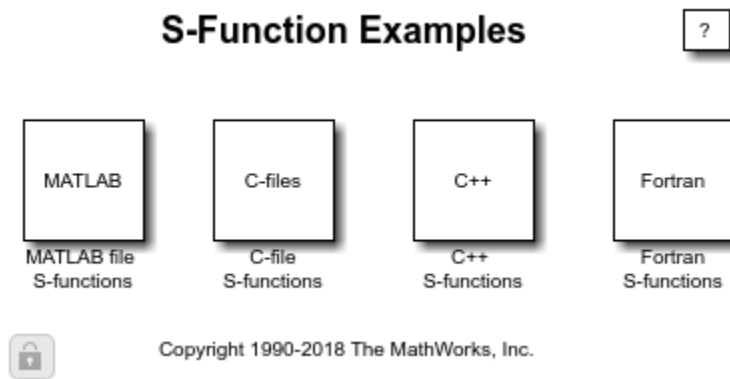

See Also

[S-Function](#) | [S-Function Builder](#)

Related Examples

- [“S-Function Examples”](#)

Inputs Passed by Value or Address to Legacy Functions

This example shows you how to use the Legacy Code Tool to integrate legacy C functions that pass their input arguments by value versus address.

The Legacy Code Tool allows you to:

- Provide the legacy function specification,
- Generate a C-MEX S-function that is used during simulation to call the legacy code, and
- Compile and build the generated S-function for simulation.

Providing the Legacy Function Specification

Functions provided with the Legacy Code Tool take a specific data structure or array of structures as the argument. The data structure is initialized by calling the function `legacy_code()` using 'initialize' as the first input. After initializing the structure, you have to assign its properties to values corresponding to the legacy code being integrated. The prototypes of the legacy functions being called in this example are:

- FLT filterV1(const FLT signal, const FLT prevSignal, const FLT gain)
- FLT filterV2(const FLT* signal, const FLT prevSignal, const FLT gain)

where FLT is a typedef to float. The legacy source code is found in the files `your_types.h`, `myfilter.h`, `filterV1.c`, and `filterV2.c`.

Note the difference in the `OutputFcnSpec` defined in the two structures; the first case specifies that the first input argument is passed by value, while the second case specifies pass by pointer.

```

defs = [];

% sldemo_sfun_filterV1
def = legacy_code('initialize');
def.SFunctionName = 'sldemo_sfun_filterV1';
def.OutputFcnSpec = 'single y1 = filterV1(single u1, single u2, single p1)';
def.HeaderFiles = {'myfilter.h'};
def.SourceFiles = {'filterV1.c'};
def.IncPaths = {'sldemo_lct_src'};
def.SrcPaths = {'sldemo_lct_src'};
defs = [defs; def];

% sldemo_sfun_filterV2
def = legacy_code('initialize');
def.SFunctionName = 'sldemo_sfun_filterV2';
def.OutputFcnSpec = 'single y1 = filterV2(single u1[1], single u2, single p1)';
def.HeaderFiles = {'myfilter.h'};
def.SourceFiles = {'filterV2.c'};
def.IncPaths = {'sldemo_lct_src'};
def.SrcPaths = {'sldemo_lct_src'};
defs = [defs; def];

```

Generating and Compiling an S-Function for Use During Simulation

The function `legacy_code()` is called again with the first input set to 'generate_for_sim' in order to automatically generate and compile the C-MEX S-function according to the description provided by the input argument 'defs'. This S-function is used to call the legacy functions in simulation. The

source code for the S-function is found in the files `sldemo_sfund_filterV1.c` and `sldemo_sfund_filterV2.c`.

```
legacy_code('generate_for_sim', defs);
```

```
### Start Compiling sldemo_sfund_filterV1
    mex('-IC:\TEMP\Bdoc21b_1757077_3096\ib2EDA31\26\tp490052a0\ex08075368\sldemo_lct_src', '-IC:
Building with 'Microsoft Visual C++ 2019 (C)'.
MEX completed successfully.
    mex('sldemo_sfund_filterV1.c', '-IC:\TEMP\Bdoc21b_1757077_3096\ib2EDA31\26\tp490052a0\ex08075
Building with 'Microsoft Visual C++ 2019 (C)'.
MEX completed successfully.
### Finish Compiling sldemo_sfund_filterV1
### Exit

### Start Compiling sldemo_sfund_filterV2
    mex('-IC:\TEMP\Bdoc21b_1757077_3096\ib2EDA31\26\tp490052a0\ex08075368\sldemo_lct_src', '-IC:
Building with 'Microsoft Visual C++ 2019 (C)'.
MEX completed successfully.
    mex('sldemo_sfund_filterV2.c', '-IC:\TEMP\Bdoc21b_1757077_3096\ib2EDA31\26\tp490052a0\ex08075
Building with 'Microsoft Visual C++ 2019 (C)'.
MEX completed successfully.
### Finish Compiling sldemo_sfund_filterV2
### Exit
```

Generating an `rtwmakecfg.m` File for Code Generation

After the TLC block file is created, the function `legacy_code()` can be called again with the first input set to `'rtwmakecfg_generate'` in order to generate an `rtwmakecfg.m` file to support code generation through Simulink® Coder™. Generate the `rtwmakecfg.m` file if the required source and header files for the S-functions are not in the same directory as the S-functions, and you want to add these dependencies in the makefile produced during code generation.

Note: Complete this step only if you are going to simulate the model in accelerated mode.

```
legacy_code('rtwmakecfg_generate', def);
```

Generating Masked S-Function Blocks for Calling the Generated S-Functions

After the C-MEX S-function source is compiled, the function `legacy_code()` can be called again with the first input set to `'slblock_generate'` in order to generate masked S-function blocks which are configured to call those S-functions. The blocks are placed in a new model and can be copied to an existing model.

```
% legacy_code('slblock_generate', defs);
```

Integrate the Legacy Code

The model `sldemo_lct_filter` shows integration with the legacy code. The subsystem `TestFilter` serves as a harness for the calls to the legacy C functions via the generate S-functions, with unit delays serving to store the previous output values.

```
open_system('sldemo_lct_filter')
open_system('sldemo_lct_filter/TestFilter')
sim('sldemo_lct_filter');
```

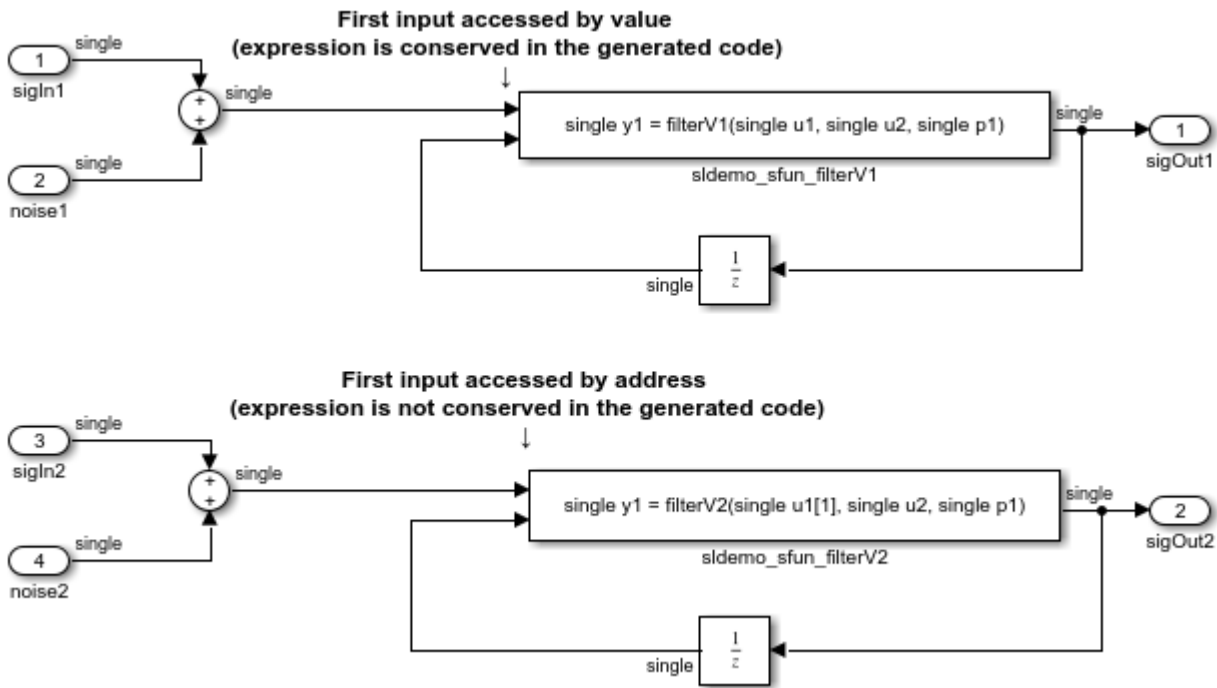
See Also

“Implement Algorithms Using Legacy Code Tool”

Output Passed by Return Argument from Legacy Functions

This example shows you how to use the Legacy Code Tool to integrate legacy C functions that pass their output as a return argument.

The Legacy Code Tool allows you to:

- Provide the legacy function specification,
- Generate a C-MEX S-function that is used during simulation to call the legacy code, and
- Compile and build the generated S-function for simulation.

Providing the Legacy Function Specification

Functions provided with the Legacy Code Tool take a specific data structure or array of structures as the argument. The data structure is initialized by calling the function `legacy_code()` using 'initialize' as the first input. After initializing the structure, you have to assign its properties to values corresponding to the legacy code being integrated. The prototype of the legacy functions being called in this example is:

```
FLT gainScalar(const FLT in, const FLT gain)
```

where FLT is a typedef to float. The legacy source code is found in the files `your_types.h`, `gain.h`, and `gainScalar.c`.

```
% sldemo_sfun_gain_scalar
def = legacy_code('initialize');
def.SFunctionName = 'sldemo_sfun_gain_scalar';
def.OutputFcnSpec = 'single y1 = gainScalar(single u1, single p1)';
def.HeaderFiles    = {'gain.h'};
def.SourceFiles    = {'gainScalar.c'};
def.IncPaths       = {'sldemo_lct_src'};
def.SrcPaths       = {'sldemo_lct_src'};
```

Generating and Compiling an S-Function for Use During Simulation

The function `legacy_code()` is called again with the first input set to 'generate_for_sim' in order to automatically generate and compile the C-MEX S-function according to the description provided by the input argument 'def'. This S-function is used to call the legacy functions in simulation. The source code for the S-function is found in the file `sldemo_sfun_gain_scalar.c`.

```
legacy_code('generate_for_sim', def);
```

```
### Start Compiling sldemo_sfun_gain_scalar
mex('-IC:\TEMP\Bdoc21b_1757077_3096\ib2EDA31\26\tp490052a0\ex60439838\sldemo_lct_src', '-IC:
Building with 'Microsoft Visual C++ 2019 (C)'.
MEX completed successfully.
mex('sldemo_sfun_gain_scalar.c', '-IC:\TEMP\Bdoc21b_1757077_3096\ib2EDA31\26\tp490052a0\ex60
Building with 'Microsoft Visual C++ 2019 (C)'.
MEX completed successfully.
### Finish Compiling sldemo_sfun_gain_scalar
### Exit
```

Generating an `rtwmakecfg.m` File for Code Generation

After the TLC block file is created, the function `legacy_code()` can be called again with the first input set to 'rtwmakecfg_generate' in order to generate an `rtwmakecfg.m` file to support code

generation through Simulink® Coder™. Generate the `rtwmakecfg.m` file if the required source and header files for the S-functions are not in the same directory as the S-functions, and you want to add these dependencies in the makefile produced during code generation.

Note: Complete this step only if you are going to simulate the model in accelerated mode.

```
legacy_code('rtwmakecfg_generate', def);
```

Generating a Masked S-Function Block for Calling the Generated S-Function

After the C-MEX S-function source is compiled, the function `legacy_code()` can be called again with the first input set to `'slblock_generate'` in order to generate a masked S-function block that is configured to call that S-function. The block is placed in a new model and can be copied to an existing model.

```
% legacy_code('slblock_generate', def);
```

Integrate the Legacy Code

The model `sldemo_lct_gain` shows integration with the legacy code. The subsystem `TestGain` serves as a harness for the call to the legacy C function via the generate S-function.

```
if isempty(find_system('SearchDepth',0,'Name','sldemo_lct_gain'))
    open_system('sldemo_lct_gain')
    open_system('sldemo_lct_gain/TestGain')
    sim('sldemo_lct_gain');
end
```

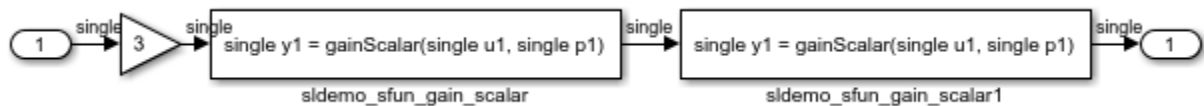

See Also

“Implement Algorithms Using Legacy Code Tool”

Fixed Point Signals in Legacy Functions

This example shows you how to use the Legacy Code Tool to integrate legacy C functions that pass their inputs and outputs using signals of fixed point data type.

The Legacy Code Tool allows you to:

- Provide the legacy function specification,
- Generate a C-MEX S-function that is used during simulation to call the legacy code, and
- Compile and build the generated S-function for simulation.

Providing the Legacy Function Specification

Functions provided with the Legacy Code Tool take a specific data structure or array of structures as the argument. The data structure is initialized by calling the function `legacy_code()` using 'initialize' as the first input. After initializing the structure, you have to assign its properties to values corresponding to the legacy code being integrated. The prototype of the legacy functions being called in this example is:

```
myFixpt timesS16(const myFixpt in1, const myFixpt in2, const uint8_T fracLength)
```

where `myFixpt` is logically a fixed point data type which is physically a typedef to a 16-bit integer:

```
myFixpt = Simulink.NumericType;
myFixpt.DataTypeMode = 'Fixed-point: binary point scaling';
myFixpt.Signed = true;
myFixpt.WordLength = 16;
myFixpt.FractionLength = 10;
myFixpt.IsAlias = true;
myFixpt.HeaderFile = 'timesFixpt.h';
```

The legacy source code is found in the files `timesFixpt.h` and `timesS16.c`.

```
% sldemo_sfun_times_s16
def = legacy_code('initialize');
def.SFunctionName = 'sldemo_sfun_times_s16';
def.OutputFcnSpec = 'myFixpt y1 = timesS16(myFixpt u1, myFixpt u2, uint8 p1)';
def.HeaderFiles = {'timesFixpt.h'};
def.SourceFiles = {'timesS16.c'};
def.IncPaths = {'sldemo_lct_src'};
def.SrcPaths = {'sldemo_lct_src'};
```

Generating and Compiling an S-Function for Use During Simulation

The function `legacy_code()` is called again with the first input set to 'generate for sim' in order to automatically generate and compile the C-MEX S-function according to the description provided by the input argument 'def'. This S-function is used to call the legacy functions in simulation. The source code for the S-function is found in the file `sldemo_sfun_times_s16.c`.

```
legacy_code('generate_for_sim', def);
```

```
### Start Compiling sldemo_sfun_times_s16
mex('-IC:\TEMP\Bdoc21b_1757077_3096\ib2EDA31\26\tp490052a0\ex15473442\sldemo_lct_src', '-IC:
Building with 'Microsoft Visual C++ 2019 (C)'.
MEX completed successfully.
```

```

    mex('sldemo_sfun_times_s16.c', '-IC:\TEMP\Bdoc21b_1757077_3096\ib2EDA31\26\tp490052a0\ex1547
Building with 'Microsoft Visual C++ 2019 (C)'.
MEX completed successfully.
### Finish Compiling sldemo_sfun_times_s16
### Exit

```

Generating an `rtwmakecfg.m` File for Code Generation

After the TLC block file is created, the function `legacy_code()` can be called again with the first input set to `'rtwmakecfg_generate'` in order to generate an `rtwmakecfg.m` file to support code generation through Simulink® Coder™. Generate the `rtwmakecfg.m` file if the required source and header files for the S-functions are not in the same directory as the S-functions, and you want to add these dependencies in the makefile produced during code generation.

Note: Complete this step only if you are going to simulate the model in accelerated mode.

```
legacy_code('rtwmakecfg_generate', def);
```

Generating a Masked S-Function Block for Calling the Generated S-Function

After the C-MEX S-function source is compiled, the function `legacy_code()` can be called again with the first input set to `'slblock_generate'` in order to generate a masked S-function block that is configured to call that S-function. The block is placed in a new model and can be copied to an existing model.

```
% legacy_code('slblock_generate', def);
```

Integration with Legacy Code

The model `sldemo_lct_fixpt_signals` shows integration with the legacy code. The subsystem `TestFixpt` serves as a harness for the call to the legacy C function via the generated S-function, and the scope compares the output of the function with the output of the built-in Simulink® product block; the results are identical.

```

open_system('sldemo_lct_fixpt_signals')
open_system('sldemo_lct_fixpt_signals/TestFixpt')
sim('sldemo_lct_fixpt_signals')

ans =

    Simulink.SimulationOutput:
        yout: [101x2 double]

    SimulationMetadata: [1x1 Simulink.SimulationMetadata]
    ErrorMessage: [0x0 char]

```

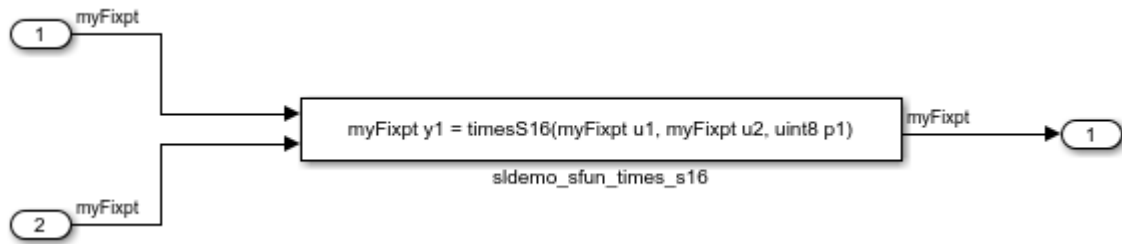

See Also

“Implement Algorithms Using Legacy Code Tool”

Fixed Point Parameters in Legacy Functions

This example shows you how to use the Legacy Code Tool to integrate legacy C functions that pass their inputs and outputs using parameters of fixed point data type.

The Legacy Code Tool allows you to:

- Provide the legacy function specification,
- Generate a C-MEX S-function that is used during simulation to call the legacy code, and
- Compile and build the generated S-function for simulation.

Providing the Legacy Function Specification

Functions provided with the Legacy Code Tool take a specific data structure or array of structures as the argument. The data structure is initialized by calling the function `legacy_code()` using 'initialize' as the first input. After initializing the structure, you have to assign its properties to values corresponding to the legacy code being integrated. The prototype of the legacy functions being called in this example is:

```
myFixpt timesS16(const myFixpt in1, const myFixpt in2, const uint8_T fracLength)
```

where `myFixpt` is logically a fixed point data type which is physically a typedef to a 16-bit integer:

```
myFixpt = Simulink.NumericType;
myFixpt.DataTypeMode = 'Fixed-point: binary point scaling';
myFixpt.Signed = true;
myFixpt.WordLength = 16;
myFixpt.FractionLength = 10;
myFixpt.IsAlias = true;
myFixpt.HeaderFile = 'timesFixpt.h';
```

The legacy source code is found in the files `timesFixpt.h`, and `timesS16.c`.

```
% sldemo_sfun_gain_fixpt
def = legacy_code('initialize');
def.SFunctionName = 'sldemo_sfun_gain_fixpt';
def.OutputFcnSpec = 'myFixpt y1 = timesS16(myFixpt u1, myFixpt p1, uint8 p2)';
def.HeaderFiles = {'timesFixpt.h'};
def.SourceFiles = {'timesS16.c'};
def.IncPaths = {'sldemo_lct_src'};
def.SrcPaths = {'sldemo_lct_src'};
```

Generating and Compiling an S-Function for Use During Simulation

The function `legacy_code()` is called again with the first input set to 'generate for sim' in order to automatically generate and compile the C-MEX S-function according to the description provided by the input argument 'def'. This S-function is used to call the legacy functions in simulation. The source code for the S-function is found in the file `sldemo_sfun_gain_fixpt.c`.

```
legacy_code('generate_for_sim', def);
```

```
### Start Compiling sldemo_sfun_gain_fixpt
mex('-IC:\TEMP\Bdoc21b_1757077_3096\ib2EDA31\26\tp490052a0\ex52665162\sldemo_lct_src', '-IC:
Building with 'Microsoft Visual C++ 2019 (C)'.
MEX completed successfully.
```

```
mex('sldemo_sfun_gain_fixpt.c', '-IC:\TEMP\Bdoc21b_1757077_3096\ib2EDA31\26\tp490052a0\ex526')
Building with 'Microsoft Visual C++ 2019 (C)'.
MEX completed successfully.
### Finish Compiling sldemo_sfun_gain_fixpt
### Exit
```

Generating an `rtwmakecfg.m` File for Code Generation

After the TLC block file is created, the function `legacy_code()` can be called again with the first input set to `'rtwmakecfg_generate'` in order to generate an `rtwmakecfg.m` file to support code generation through Simulink® Coder™. Generate the `rtwmakecfg.m` file if the required source and header files for the S-functions are not in the same directory as the S-functions, and you want to add these dependencies in the makefile produced during code generation.

Note: Complete this step only if you are going to simulate the model in accelerated mode.

```
legacy_code('rtwmakecfg_generate', def);
```

Generating a Masked S-Function Block for Calling the Generated S-Function

After the C-MEX S-function source is compiled, the function `legacy_code()` can be called again with the first input set to `'slblock_generate'` in order to generate a masked S-function block that is configured to call that S-function. The block is placed in a new model and can be copied to an existing model.

```
% legacy_code('slblock_generate', def);
```

Integration with Legacy Code

The model `sldemo_lct_fixpt_params` shows integration with the legacy code. The subsystem `TestFixpt` serves as a harness for the call to the legacy C function via the generated S-function.

```
open_system('sldemo_lct_fixpt_params')
open_system('sldemo_lct_fixpt_params/TestFixpt')
sim('sldemo_lct_fixpt_params')
```

ans =

```
Simulink.SimulationOutput:
      yout: [101x4 double]

SimulationMetadata: [1x1 Simulink.SimulationMetadata]
      ErrorMessage: [0x0 char]
```

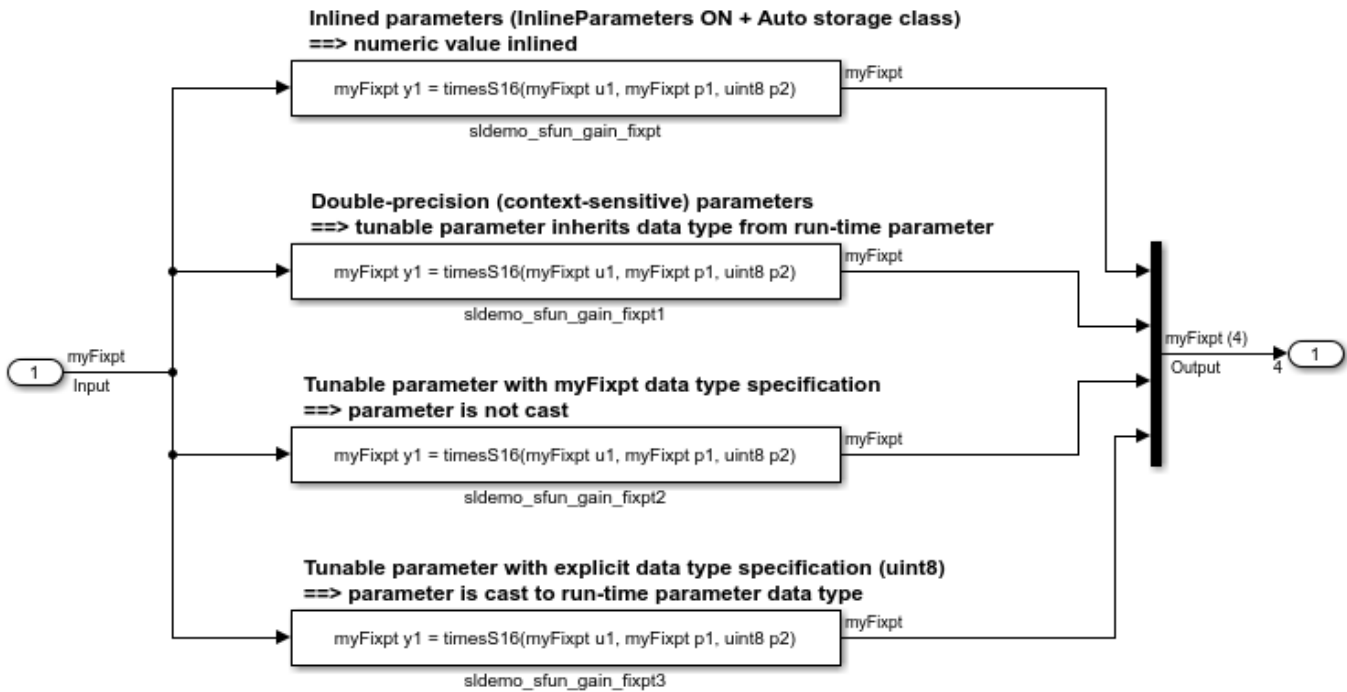
See Also

“Implement Algorithms Using Legacy Code Tool”

Lookup Tables Implemented in Legacy Functions

This example shows you how to use the Legacy Code Tool to integrate legacy C functions that implement N-dimensional table lookups.

The Legacy Code Tool allows you to:

- Provide the legacy function specification,
- Generate a C-MEX S-function that is used during simulation to call the legacy code, and
- Compile and build the generated S-function for simulation.

Providing the Legacy Function Specification

Functions provided with the Legacy Code Tool take a specific data structure or array of structures as the argument. The data structure is initialized by calling the function `legacy_code()` using 'initialize' as the first input. After initializing the structure, you have to assign its properties to values corresponding to the legacy code being integrated. The prototype of the legacy function being called in this example is:

```
FLT directLookupTableND(const FLT *tableND, const UINT32 nbDims, const UINT32 *tableDims,
const UINT32 *tableIdx)
```

where FLT is a typedef to float, and UINT32 is a typedef to unsigned int32. The legacy source code is found in the files `your_types.h`, `lookupTable.h`, and `directLookupTableND.c`.

```
defs = [];
evalin('base','load sldemo_lct_data.mat')
```

```
% sldemo_sfun_dlut3D
```

```
def = legacy_code('initialize');
def.SFunctionName = 'sldemo_sfun_dlut3D';
def.OutputFcnSpec = 'single y1 = DirectLookupTable3D(single p1[][][], uint32 p2[3], uint32 u1[3]);
def.HeaderFiles = {'lookupTable.h'};
def.SourceFiles = {'directLookupTableND.c'};
def.IncPaths = {'sldemo_lct_src'};
def.SrcPaths = {'sldemo_lct_src'};
defs = [defs; def];
```

```
% sldemo_sfun_dlut4D
```

```
def = legacy_code('initialize');
def.SFunctionName = 'sldemo_sfun_dlut4D';
def.OutputFcnSpec = 'single y1 = DirectLookupTable4D(single p1[][][][], uint32 p2[4], uint32 u1[4]);
def.HeaderFiles = {'lookupTable.h'};
def.SourceFiles = {'directLookupTableND.c'};
def.IncPaths = {'sldemo_lct_src'};
def.SrcPaths = {'sldemo_lct_src'};
defs = [defs; def];
```

Generating and Compiling an S-Function for Use During Simulation

The function `legacy_code()` is called again with the first input set to 'generate_for_sim' in order to automatically generate and compile the C-MEX S-function according to the description provided by the input argument 'defs'. This S-function is used to call the legacy functions in simulation. The source code for the S-function is found in the files `sldemo_sfun_dlut3D.c` and `sldemo_sfun_dlut4D.c`.

```
legacy_code('generate_for_sim', defs);
```

```
### Start Compiling sldemo_sfun_dlut3D
mex('-IC:\TEMP\Bdoc21b_1757077_3096\ib2EDA31\26\tp490052a0\ex11439596\sldemo_lct_src', '-IC:
Building with 'Microsoft Visual C++ 2019 (C)'.
MEX completed successfully.
mex('sldemo_sfun_dlut3D.c', '-IC:\TEMP\Bdoc21b_1757077_3096\ib2EDA31\26\tp490052a0\ex11439596
Building with 'Microsoft Visual C++ 2019 (C)'.
MEX completed successfully.
### Finish Compiling sldemo_sfun_dlut3D
### Exit
```

```
### Start Compiling sldemo_sfun_dlut4D
mex('-IC:\TEMP\Bdoc21b_1757077_3096\ib2EDA31\26\tp490052a0\ex11439596\sldemo_lct_src', '-IC:
Building with 'Microsoft Visual C++ 2019 (C)'.
MEX completed successfully.
mex('sldemo_sfun_dlut4D.c', '-IC:\TEMP\Bdoc21b_1757077_3096\ib2EDA31\26\tp490052a0\ex11439596
Building with 'Microsoft Visual C++ 2019 (C)'.
MEX completed successfully.
### Finish Compiling sldemo_sfun_dlut4D
### Exit
```

Generating an rtwmakecfg.m File for Code Generation

After the TLC block file is created, the function `legacy_code()` can be called again with the first input set to `'rtwmakecfg_generate'` in order to generate an `rtwmakecfg.m` file to support code generation through Simulink® Coder™. Generate the `rtwmakecfg.m` file if the required source and header files for the S-functions are not in the same directory as the S-functions, and you want to add these dependencies in the makefile produced during code generation.

Note: Complete this step only if you are going to simulate the model in accelerated mode.

```
legacy_code('rtwmakecfg_generate', def);
```

Generating a Masked S-Function Block for Calling the Generated S-Function

After the C-MEX S-function source is compiled, the function `legacy_code()` can be called again with the first input set to `'slblock_generate'` in order to generate a masked S-function block that is configured to call that S-function. The block is placed in a new model and can be copied to an existing model.

```
% legacy_code('slblock_generate', defs);
```

Integrate the Legacy Code

The model `sldemo_lct_lut` shows integration with the legacy code. The subsystem `TestFixpt` serves as a harness for the call to the legacy C function, and the Display blocks compare the output of the function with the output of the built-in Simulink® lookup blocks; the results are identical.

```
open_system('sldemo_lct_lut')
open_system('sldemo_lct_lut/TestLut1')
sim('sldemo_lct_lut');
```

LookUp Table are defined as:

```
>> LUT3D = single(reshape([1:4*5*6], [4 5 6]));  
>> LUT4D = single(reshape([1:4*5*6*2], [4 5 6 2]));
```

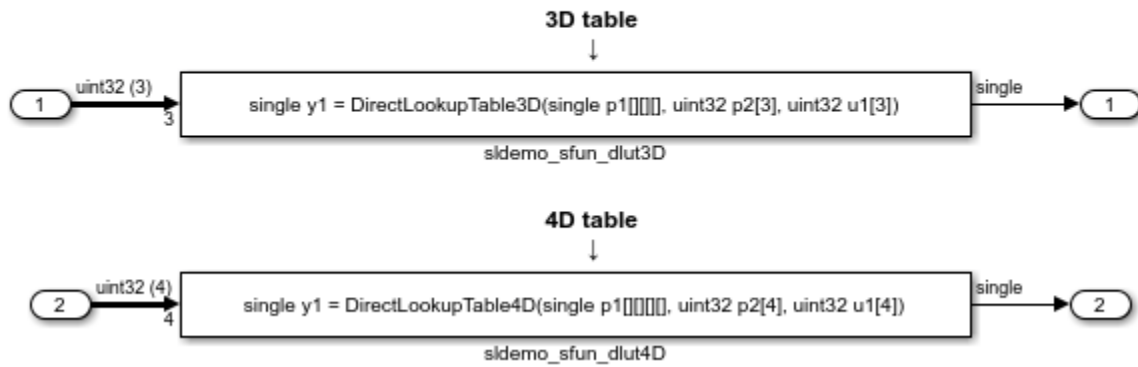

See Also

“Implement Algorithms Using Legacy Code Tool”

Start and Terminate Actions Within Legacy Functions

This example shows you how to use the Legacy Code Tool to integrate legacy C functions that have start and terminate actions.

The Legacy Code Tool allows you to:

- Provide the legacy function specification,
- Generate a C-MEX S-function that is used during simulation to call the legacy code, and
- Compile and build the generated S-function for simulation.

Providing the Legacy Function Specification

Functions provided with the Legacy Code Tool take a specific data structure or array of structures as the argument. The data structure is initialized by calling the function `legacy_code()` using the 'initialize' first input. After initializing the structure, you have to assign its properties to values corresponding to the legacy code being integrated. The prototypes of the legacy functions being called in this example are:

- `void initFaultCounter(unsigned int *counter)`
- `void openLogFile(void **fid)`
- `void incAndLogFaultCounter(void *fid, unsigned int *counter, double time)`
- `void closeLogFile(void **fid)`

To open the model and files, click **Open Model**. The legacy source code is found in the files `your_types.h`, `fault.h`, and `fault.c`.

```
% sldemo_sfun_fault
def = legacy_code('initialize');
def.SFunctionName = 'sldemo_sfun_fault';
def.InitializeConditionsFcnSpec = 'initFaultCounter(uint32 work2[1])';
def.StartFcnSpec = 'openLogFile(void **work1)';
def.OutputFcnSpec = 'incAndLogFaultCounter(void *work1, uint32 work2[1], double u)';
def.TerminateFcnSpec = 'closeLogFile(void **work1)';
def.HeaderFiles = {'fault.h'};
def.SourceFiles = {'fault.c'};
def.IncPaths = {'sldemo_lct_src'};
def.SrcPaths = {'sldemo_lct_src'};
def.Options.useTlcWithAccel = false;
```

Generating and Compiling an S-Function for Use During Simulation

The function `legacy_code()` is called again with the first input set to 'generate_for_sim' in order to automatically generate and compile the C-MEX S-function according to the description provided by the input argument 'def'. This S-function is used to call the legacy functions in simulation. The source code for the S-function is found in the file `sldemo_sfun_fault.c`.

```
legacy_code('generate_for_sim', def);

### Start Compiling sldemo_sfun_fault
mex('-IC:\TEMP\Bdoc21b_1757077_3096\ib2EDA31\26\tp490052a0\ex33158503\sldemo_lct_src', '-IC:
Building with 'Microsoft Visual C++ 2019 (C)'.
MEX completed successfully.
```

```

    mex('sldemo_sfun_fault.c', '-IC:\TEMP\Bdoc21b_1757077_3096\ib2EDA31\26\tp490052a0\ex33158503
Building with 'Microsoft Visual C++ 2019 (C)'.
MEX completed successfully.
### Finish Compiling sldemo_sfun_fault
### Exit

```

Generating an rtwmakecfg.m File for Code Generation

After the TLC block file is created, the function `legacy_code()` can be called again with the first input set to `'rtwmakecfg_generate'` in order to generate an `rtwmakecfg.m` file to support code generation through Simulink® Coder™. Generate the `rtwmakecfg.m` file if the required source and header files for the S-functions are not in the same directory as the S-functions, and you want to add these dependencies in the makefile produced during code generation.

Note: Complete this step only if you are going to simulate the model in accelerated mode.

```
legacy_code('rtwmakecfg_generate', def);
```

Generating a Masked S-Function Block for Calling the Generated S-Function

After the C-MEX S-function source is compiled, the function `legacy_code()` can be called again with the first input set to `'slblock_generate'` in order to generate a masked S-function block that is configured to call that S-function. The block is placed in a new model and can be copied to an existing model.

```
% legacy_code('slblock_generate', def);
```

Integrate the Legacy Code

The model `sldemo_lct_start_term` shows integration with the legacy code. The subsystem `TestFixpt` serves as a harness for the call to the legacy C function, and the scope compares the output of the function with the output of the built-in Simulink® product block; the results should be identical.

```
open_system('sldemo_lct_start_term')
open_system('sldemo_lct_start_term/TestFault')
sim('sldemo_lct_start_term');
```

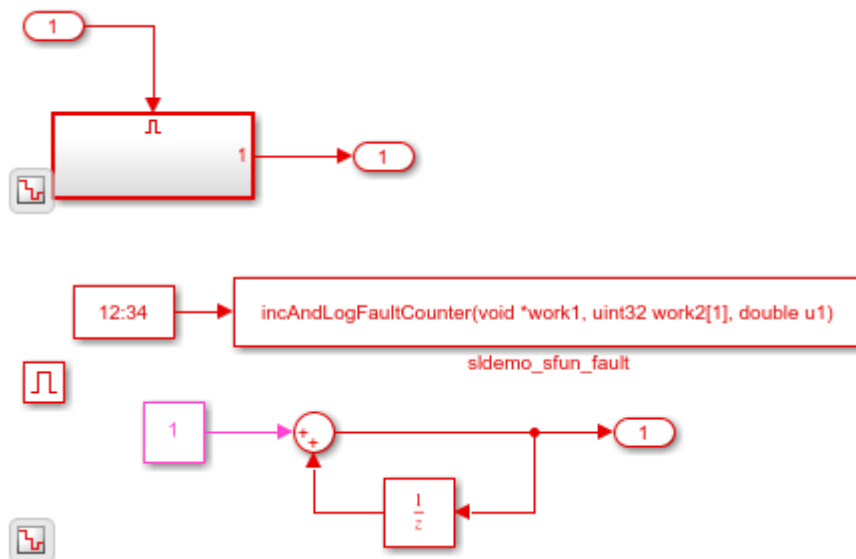

Use the Legacy Code Tool to call legacy functions that have start and terminate actions

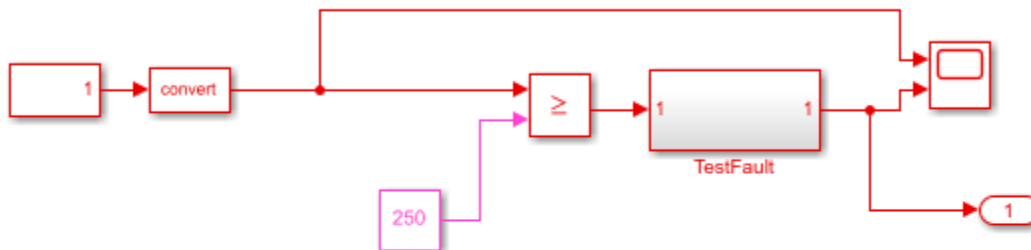

mdlInitializeConditions → call `initFaultCounter()` → reset the fault counter
 mdlStart → call `openLogFile()` → open the file 'sldemo_lct_fault.log' for logging faults
 mdlOutput → call `incAndLogFaultCounter()` → increment the fault counter and append one line in the log file
 mdlTerminate → call `closeLogFile()` → close the logging file

- run the model and edit the generated logging file 'sldemo_lct_fault.log'

To view the source files, click these links.

- open legacy files `fault.h` and `fault.c`
- open generated S-Function `sldemo_sfuns_fault.c`



Copyright 1990-2020 The MathWorks, Inc.

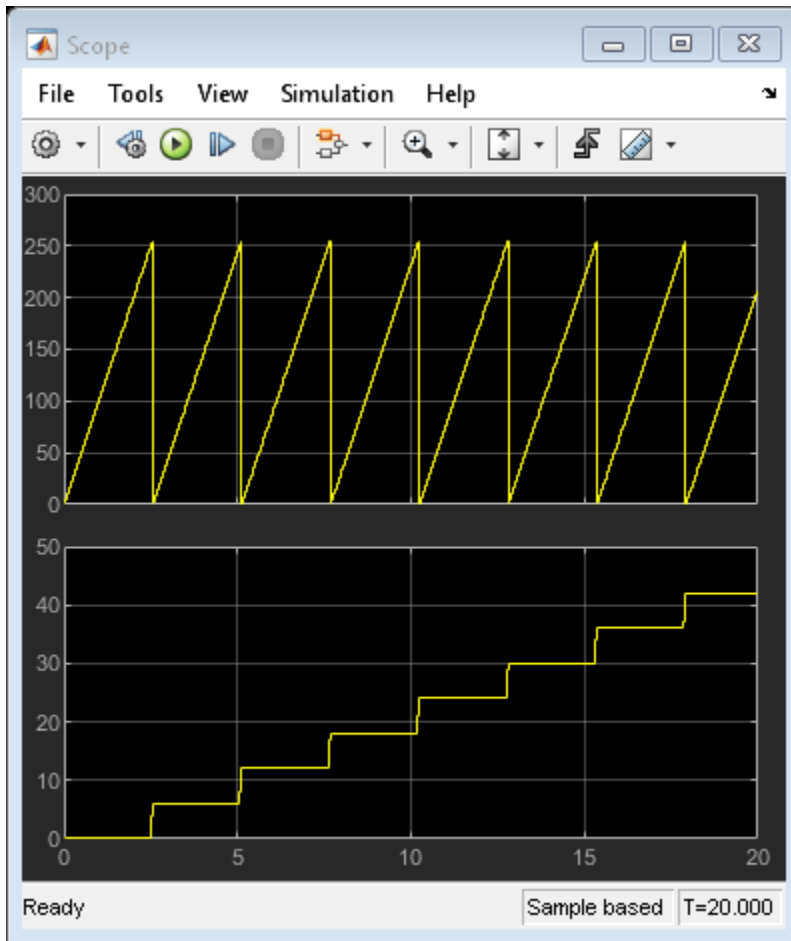

See Also

“Implement Algorithms Using Legacy Code Tool”

Using Buses with Legacy Functions Having Structure Arguments

This example shows you how to use the Legacy Code Tool to integrate legacy C functions with structure arguments using Simulink® buses.

The Legacy Code Tool allows you to:

- Provide the legacy function specification,
- Generate a C-MEX S-function that is used during simulation to call the legacy code, and
- Compile and build the generated S-function for simulation.

Providing the Legacy Function Specification

Functions provided with the Legacy Code Tool take a specific data structure or array of structures as the argument. The data structure is initialized by calling the function `legacy_code()` using 'initialize' as the first input. After initializing the structure, you have to assign its properties to values corresponding to the legacy code being integrated. The prototype of the legacy functions being called in this example is:

```
counterbusFcn(COUNTERBUS *u1, int32_T u2, COUNTERBUS *y1, int32_T *y2)
```

where `COUNTERBUS` is a struct typedef defined in `counterbus.h` and implemented with a `Simulink.Bus` object in the base workspace. The legacy source code is found in the files `counterbus.h` and `counterbus.c`. To open the model and files, click **Open Model**.

```
evalin('base','load sldemo_lct_data.mat')
```

```
% sldemo_sfun_counterbus
def = legacy_code('initialize');
def.SFunctionName = 'sldemo_sfun_counterbus';
def.OutputFcnSpec = 'void counterbusFcn(COUNTERBUS u1[1], int32 u2, COUNTERBUS y1[1], int32 y2[1])';
def.HeaderFiles = {'counterbus.h'};
def.SourceFiles = {'counterbus.c'};
def.IncPaths = {'sldemo_lct_src'};
def.SrcPaths = {'sldemo_lct_src'};
```

Generating and Compiling an S-Function for Use During Simulation

The function `legacy_code()` is called again with the first input set to 'generate_for_sim' in order to automatically generate and compile the C-MEX S-function according to the description provided by the input argument 'def'. This S-function is used to call the legacy functions in simulation. The source code for the S-function is found in the file `sldemo_sfun_counterbus.c`.

```
legacy_code('generate_for_sim', def);
```

```
### Start Compiling sldemo_sfun_counterbus
mex('-IC:\TEMP\Bdoc21b_1757077_3096\ib2EDA31\26\tp490052a0\ex39753963\sldemo_lct_src', '-IC:
Building with 'Microsoft Visual C++ 2019 (C)'.
MEX completed successfully.
mex('sldemo_sfun_counterbus.c', '-IC:\TEMP\Bdoc21b_1757077_3096\ib2EDA31\26\tp490052a0\ex397
Building with 'Microsoft Visual C++ 2019 (C)'.
MEX completed successfully.
```

```
### Finish Compiling sldemo_sfun_counterbus
### Exit
```

Generating an `rtwmakecfg.m` File for Code Generation

After the TLC block file is created, the function `legacy_code()` can be called again with the first input set to `'rtwmakecfg_generate'` in order to generate an `rtwmakecfg.m` file to support code generation through Simulink® Coder™. Generate the `rtwmakecfg.m` file if the required source and header files for the S-functions are not in the same directory as the S-functions, and you want to add these dependencies in the makefile produced during code generation.

Note: Complete this step only if you are going to simulate the model in accelerated mode.

```
legacy_code('rtwmakecfg_generate', def);
```

Generating a Masked S-Function Block for Calling the Generated S-Function

After the C-MEX S-function source is compiled, the function `legacy_code()` can be called again with the first input set to `'slblock_generate'` in order to generate a masked S-function block that is configured to call that S-function. The block is placed in a new model and can be copied to an existing model.

```
% legacy_code('slblock_generate', def);
```

Integrate the Legacy Code

The model `sldemo_lct_bus` shows integration with the legacy code. The subsystem `TestCounter` serves as a harness for the call to the legacy C function.

```
open_system('sldemo_lct_bus')
open_system('sldemo_lct_bus/TestCounter')
open_system('sldemo_lct_bus/ScopeA')
open_system('sldemo_lct_bus/ScopeA1')
sim('sldemo_lct_bus')
```

```
ans =
```

```
Simulink.SimulationOutput:
  ScopeDataA: [301x4 double]
  ScopeDataA1: [301x4 double]
  tout: [301x1 double]

SimulationMetadata: [1x1 Simulink.SimulationMetadata]
ErrorMessage: [0x0 char]
```

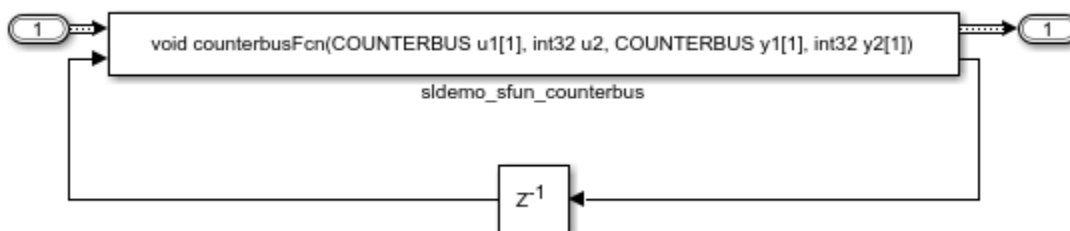

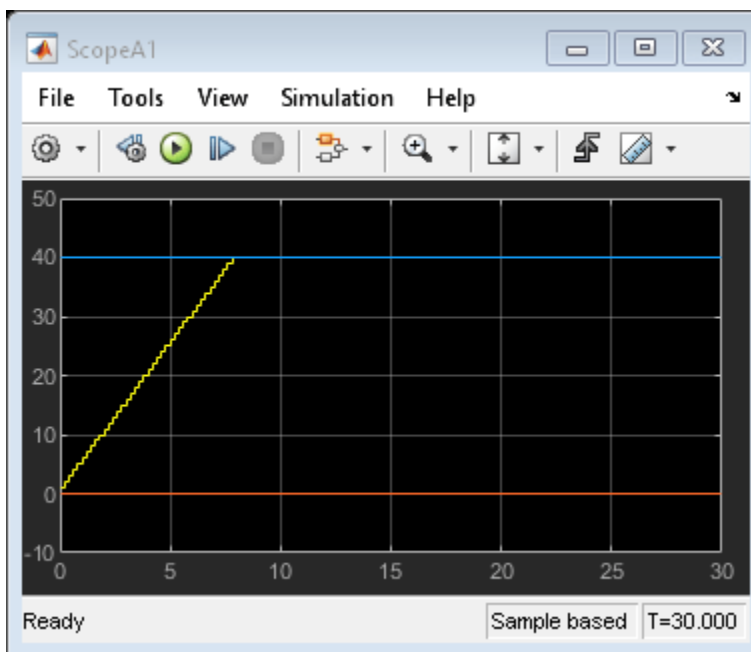
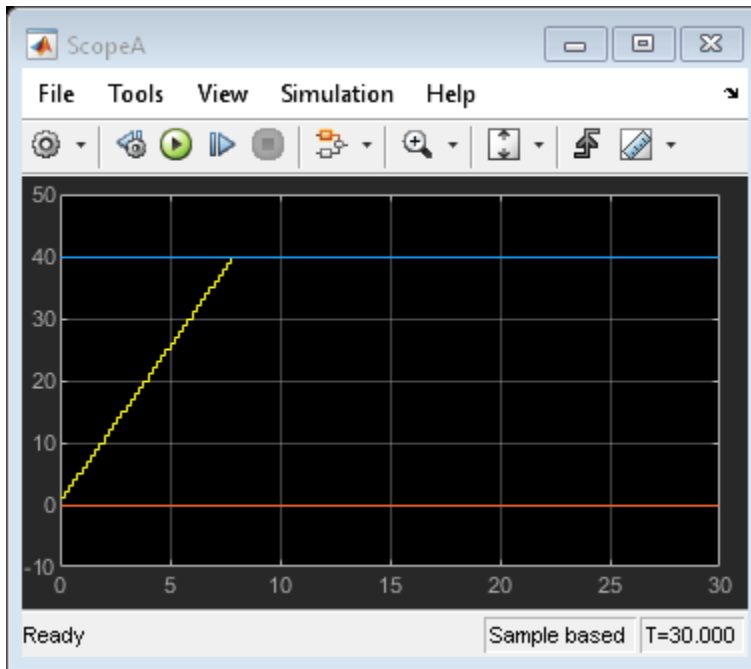

See Also

“Implement Algorithms Using Legacy Code Tool”

Inherited Signal Dimensions for Legacy Function Arguments

This example shows you how to use the Legacy Code Tool to integrate legacy C functions whose arguments have inherited dimensions.

The Legacy Code Tool allows you to:

- Provide the legacy function specification,
- Generate a C-MEX S-function that is used during simulation to call the legacy code, and
- Compile and build the generated S-function for simulation.

Providing the Legacy Function Specification

Functions provided with the Legacy Code Tool take a specific data structure or array of structures as the argument. The data structure is initialized by calling the function `legacy_code()` using 'initialize' as the first input. After initializing the structure, you have to assign its properties to values corresponding to the legacy code being integrated. The prototypes of the legacy functions being called in this example are:

- `void mat_add(real_T *u1, real_T *u2, int32_T nbRows, int32_T nbCols, real_T *y1)`
- `void mat_mult(real_T *u1, real_T *u2, int32_T nbRows1, int32_T nbCols1, int32_T nbCols2, real_T *y1)`

where `real_T` is a typedef to `double`, and `int32_T` is a typedef to a 32-bit integer. The legacy source code is found in the files `mat_ops.h` and `mat_ops.c`.

```

defs = [];

% sldemo_sfun_mat_add
def = legacy_code('initialize');
def.SFunctionName = 'sldemo_sfun_mat_add';
def.OutputFcnSpec = ['void mat_add(double u1[][], double u2[][], ' ...
                    'int32 u3, int32 u4, double y1[size(u1,1)][size(u1,2)]]'];
def.HeaderFiles    = {'mat_ops.h'};
def.SourceFiles    = {'mat_ops.c'};
def.IncPaths       = {'sldemo_lct_src'};
def.SrcPaths       = {'sldemo_lct_src'};
defs = [defs; def];

% sldemo_sfun_mat_mult
def = legacy_code('initialize');
def.SFunctionName = 'sldemo_sfun_mat_mult';
def.OutputFcnSpec = ['void mat_mult(double u1[p1][p2], double u2[p2][p3], ' ...
                    'int32 p1, int32 p2, int32 p3, double y1[p1][p3]']];
def.HeaderFiles    = {'mat_ops.h'};
def.SourceFiles    = {'mat_ops.c'};
def.IncPaths       = {'sldemo_lct_src'};
def.SrcPaths       = {'sldemo_lct_src'};
defs = [defs; def];

```

Generating and Compiling an S-Function for Use During Simulation

The function `legacy_code()` is called again with the first input set to 'generate_for_sim' in order to automatically generate and compile the C-MEX S-function according to the description provided by the input argument 'defs'. This S-function is used to call the legacy functions in simulation. The

source code for the S-function is found in the files `sldemo_sfund_mat_add.c` and `sldemo_sfund_mat_mult.c`.

```
legacy_code('generate_for_sim', defs);
```

```
### Start Compiling sldemo_sfund_mat_add
    mex('-IC:\TEMP\Bdoc21b_1757077_3096\ib2EDA31\26\tp490052a0\ex63241227\sldemo_lct_src', '-IC:
Building with 'Microsoft Visual C++ 2019 (C)'.
MEX completed successfully.
    mex('sldemo_sfund_mat_add.c', '-IC:\TEMP\Bdoc21b_1757077_3096\ib2EDA31\26\tp490052a0\ex632412
Building with 'Microsoft Visual C++ 2019 (C)'.
MEX completed successfully.
### Finish Compiling sldemo_sfund_mat_add
### Exit

### Start Compiling sldemo_sfund_mat_mult
    mex('-IC:\TEMP\Bdoc21b_1757077_3096\ib2EDA31\26\tp490052a0\ex63241227\sldemo_lct_src', '-IC:
Building with 'Microsoft Visual C++ 2019 (C)'.
MEX completed successfully.
    mex('sldemo_sfund_mat_mult.c', '-IC:\TEMP\Bdoc21b_1757077_3096\ib2EDA31\26\tp490052a0\ex63241
Building with 'Microsoft Visual C++ 2019 (C)'.
MEX completed successfully.
### Finish Compiling sldemo_sfund_mat_mult
### Exit
```

Generating an `rtwmakecfg.m` File for Code Generation

After the TLC block file is created, the function `legacy_code()` can be called again with the first input set to `'rtwmakecfg_generate'` in order to generate an `rtwmakecfg.m` file to support code generation through Simulink® Coder™. Generate the `rtwmakecfg.m` file if the required source and header files for the S-functions are not in the same directory as the S-functions, and you want to add these dependencies in the makefile produced during code generation.

Note: Complete this step only if you need to simulate the model in accelerated mode.

```
legacy_code('rtwmakecfg_generate', def);
```

Generating Masked S-Function Blocks for Calling the Generated S-Functions

After the C-MEX S-function source is compiled, the function `legacy_code()` can be called again with the first input set to `'slblock_generate'` in order to generate masked S-function blocks which are configured to call those S-functions. The blocks are placed in a new model and can be copied to an existing model.

```
% legacy_code('slblock_generate', defs);
```

Integrate the Legacy Code

The model `sldemo_lct_inherit_dims` shows integration with the legacy code. The subsystem `TestMatOps` serves as a harness for the calls to the legacy C functions, with unit delays serving to store the previous output values.

```
open_system('sldemo_lct_inherit_dims')
open_system('sldemo_lct_inherit_dims/TestMatOps')
sim('sldemo_lct_inherit_dims');
```

Input/Output matrix dimensions are related to the parameter's values

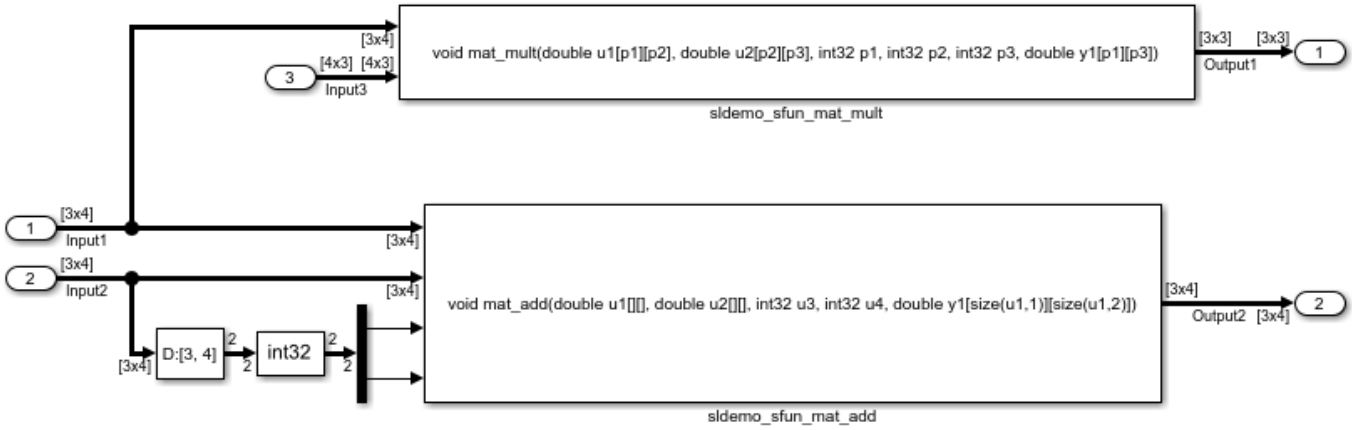

Input matrices are dynamically sized
the Output matrix dimensions are related to the Input matrices dimensions

See Also

“Implement Algorithms Using Legacy Code Tool”

C++ Object Methods as Legacy Functions

This example shows you how to use the Legacy Code Tool to integrate legacy C++ object methods.

The Legacy Code Tool allows you to:

- Provide the legacy function specification,
- generate a C++ MEX S-function that is used during simulation to call the legacy code, and
- Compile and build the generated S-function for simulation.

Providing the Legacy Function Specification

Functions provided with the Legacy Code Tool take a specific data structure or array of structures as the argument. The data structure is initialized by calling the function `legacy_code()` using 'initialize' as the first input. After initializing the structure, you have to assign its properties to values corresponding to the legacy code being integrated. The definition of the legacy C++ class being used in this example is:

```
class adder {
private:
    int int_state;
public:
    adder();
    int add_one(int increment);
    int get_val();
};
```

The legacy source code is found in the files `adder_cpp.h` and `adder_cpp.cpp`.

```
% sldemo_sfun_adder_cpp
def = legacy_code('initialize');
def.SFunctionName = 'sldemo_sfun_adder_cpp';
def.StartFcnSpec = 'createAdder()';
def.OutputFcnSpec = 'int32 y1 = adderOutput(int32 u1)';
def.TerminateFcnSpec = 'deleteAdder()';
def.HeaderFiles = {'adder_cpp.h'};
def.SourceFiles = {'adder_cpp.cpp'};
def.IncPaths = {'sldemo_lct_src'};
def.SrcPaths = {'sldemo_lct_src'};
def.Options.language = 'C++';
def.Options.useTlcWithAccel = false;
```

Generating and Compiling an S-Function for Use During Simulation

The function `legacy_code()` is called again with the first input set to 'generate_for_sim' in order to automatically generate and compile the C-MEX S-function according to the description provided by the input argument 'def'. This S-function is used to call the legacy functions in simulation. The source code for the S-function is found in the file `sldemo_sfun_adder_cpp.cpp`.

```
legacy_code('generate_for_sim', def);
```

```
### Start Compiling sldemo_sfun_adder_cpp
mex('-IC:\TEMP\Bdoc21b_1757077_3096\ib2EDA31\26\tp490052a0\ex93865240\sldemo_lct_src', '-IC:
Building with 'Microsoft Visual C++ 2019'.
MEX completed successfully.
```

```
mex('sldemo_sfun_adder_cpp.cpp', '-IC:\TEMP\Bdoc21b_1757077_3096\ib2EDA31\26\tp490052a0\ex93  
Building with 'Microsoft Visual C++ 2019'.  
MEX completed successfully.  
### Finish Compiling sldemo_sfun_adder_cpp  
### Exit
```

Generating an rtwmakecfg.m File for Code Generation

After the TLC block file is created, the function `legacy_code()` can be called again with the first input set to `'rtwmakecfg_generate'` in order to generate an `rtwmakecfg.m` file to support code generation through Simulink® Coder™. Generate the `rtwmakecfg.m` file if the required source and header files for the S-functions are not in the same directory as the S-functions, and you want to add these dependencies in the makefile produced during code generation.

Note: Complete this step only if you are going to simulate the model in accelerated mode.

```
legacy_code('rtwmakecfg_generate', def);
```

Generating a Masked S-Function Block for Calling the Generated S-Function

After the C-MEX S-function source is compiled, the function `legacy_code()` can be called again with the first input set to `'slblock_generate'` in order to generate a masked S-function block that is configured to call that S-function. The block is placed in a new model and can be copied to an existing model.

```
% legacy_code('slblock_generate', def);
```

Integration with Legacy Code

The model `sldemo_lct_cpp` `sldemo_lct_cpp` shows integration with the legacy code.

```
open_system('sldemo_lct_cpp')  
sim('sldemo_lct_cpp');
```

Use the Legacy Code Tool to
call C++ object member functions

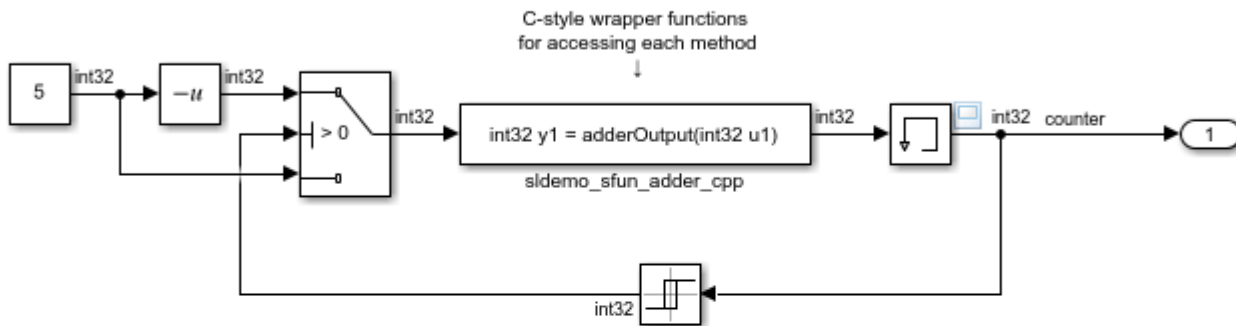

For this example to run, at the MATLAB command prompt enter: `>> mex -setup`
and select a C++ compiler.

To view the source files, click these links.

- open legacy files [adder_cpp.h](#) and [adder_cpp.cpp](#)
- open generated S-Function [sldemo_sfund_adder_cpp.cpp](#)

Copyright 1990-2021 The MathWorks, Inc.

See Also

“Implement Algorithms Using Legacy Code Tool”

```
Building with 'Microsoft Visual C++ 2019 (C)'.
MEX completed successfully.
### Finish Compiling sldemo_sfunk_work
### Exit
```

Generating an `rtwmakecfg.m` File for Code Generation

After the TLC block file is created, the function `legacy_code()` can be called again with the first input set to `'rtwmakecfg_generate'` in order to generate an `rtwmakecfg.m` file to support code generation through Simulink® Coder™. Generate the `rtwmakecfg.m` file if the required source and header files for the S-functions are not in the same directory as the S-functions, and you want to add these dependencies in the makefile produced during code generation.

Note: Complete this step only if you are going to simulate the model in accelerated mode.

```
legacy_code('rtwmakecfg_generate', def);
```

Generating a Masked S-Function Block for Calling the Generated S-Function

After the C-MEX S-function source is compiled, the function `legacy_code()` can be called again with the first input set to `'slblock_generate'` in order to generate a masked S-function block that is configured to call that S-function. The block is placed in a new model and can be copied to an existing model.

```
% legacy_code('slblock_generate', def);
```

Integrate the Legacy Code

The model `sldemo_lct_work` shows integration with the legacy code. The subsystem `memory_bus` serves as a harness for the call to the legacy C function.

```
open_system('sldemo_lct_work')
open_system('sldemo_lct_work/memory_bus')
sim('sldemo_lct_work')

ans =

    Simulink.SimulationOutput:
        ScopeDataA: [11x3 double]
        tout: [11x1 double]

    SimulationMetadata: [1x1 Simulink.SimulationMetadata]
    ErrorMessage: [0x0 char]
```



This legacy function apply a one integration step delay. The output is the previous input value. The parameters P1 and P2 set the initial values of the sub structure fields "upper_saturation_limit" and "lower_saturation_limit"



See Also

"Integrate C Functions Using Legacy Code Tool"

Multi-Dimensional Signals in Legacy Functions

This example shows you how to use the Legacy Code Tool to integrate legacy C functions with Multi-Dimensional Signals.

The Legacy Code Tool allows you to:

- Provide the legacy function specification,
- Generate a C-MEX S-function that is used during simulation to call the legacy code, and
- Compile and build the generated S-function for simulation.

Providing the Legacy Function Specification

Functions provided with the Legacy Code Tool take a specific data structure or array of structures as the argument. The data structure is initialized by calling the function `legacy_code()` using 'initialize' as the first input. After initializing the structure, you have to assign its properties to values corresponding to the legacy code being integrated. The prototype of the legacy functions being called in this example are:

```
void array3d_add(real_T *y1, real_T *u1, real_T *u2, int32_T nbRows, int32_T nbCols, int32_T nbPages);
```

where `real_T` is a typedef to `double`, and `int32_T` is a typedef to a 32-bit integer. The legacy source code is found in the files `ndarray_ops.h` and `ndarray_ops.c`.

```
% sldemo_sfun_ndarray_add
def = legacy_code('initialize');
def.SFunctionName = 'sldemo_sfun_ndarray_add';
def.OutputFcnSpec = ['void array3d_add(double y1[size(u1,1)][size(u1,2)][size(u1,3)], ', ...
                    'double u1[][][], double u2[][][], ' ...
                    'int32 size(u1,1), int32 size(u1,2), int32 size(u1,3)'];
def.HeaderFiles    = {'ndarray_ops.h'};
def.SourceFiles    = {'ndarray_ops.c'};
def.IncPaths       = {'sldemo_lct_src'};
def.SrcPaths       = {'sldemo_lct_src'};
```

where `y1` is a 3-D output signal of same dimensions as the 3-D input signal `u1`. Note that the last 3 arguments passed to the legacy function correspond to the number of element in each dimension of the 3-D input signal `u1`.

Generating and Compiling an S-Function for Use During Simulation

The function `legacy_code()` is called again with the first input set to 'generate_for_sim' in order to automatically generate and compile the C-MEX S-function according to the description provided by the input argument 'def'. This S-function is used to call the legacy functions in simulation. The source code for the S-function is found in the file `sldemo_sfun_ndarray_add.c`.

```
legacy_code('generate_for_sim', def);
```

```
### Start Compiling sldemo_sfun_ndarray_add
mex('-IC:\TEMP\Bdoc21b_1757077_3096\ib2EDA31\26\tp490052a0\ex68315702\sldemo_lct_src', '-IC:
Building with 'Microsoft Visual C++ 2019 (C)'.
MEX completed successfully.
mex('sldemo_sfun_ndarray_add.c', '-IC:\TEMP\Bdoc21b_1757077_3096\ib2EDA31\26\tp490052a0\ex683
```

```
Building with 'Microsoft Visual C++ 2019 (C)'.
MEX completed successfully.
### Finish Compiling sldemo_sfun_ndarray_add
### Exit
```

Generating an rtwmakecfg.m File for Code Generation

After the TLC block file is created, the function `legacy_code()` can be called again with the first input set to `rtwmakecfg_generate` in order to generate an `rtwmakecfg.m` file to support code generation through Simulink® Coder™. Generate the `rtwmakecfg.m` file if the required source and header files for the S-functions are not in the same directory as the S-functions, and you want to add these dependencies in the makefile produced during code generation.

Note: Complete this step only if you are going to simulate the model in accelerated mode.

```
legacy_code('rtwmakecfg_generate', def);
```

Generating a Masked S-Function Block for Calling the Generated S-Function

After the C-MEX S-function source is compiled, the function `legacy_code()` can be called again with the first input set to `slblock_generate` in order to generate a masked S-function block that is configured to call that S-function. The block is placed in a new model and can be copied to an existing model.

```
% legacy_code('slblock_generate', def);
```

Integrate the Legacy Code

The model `sldemo_lct_ndarray` shows integration with the legacy code. The subsystem `ndarray_add` serves as a harness for the call to the legacy C function.

```
open_system('sldemo_lct_ndarray')
open_system('sldemo_lct_ndarray/ndarray_add')
sim('sldemo_lct_ndarray');
```

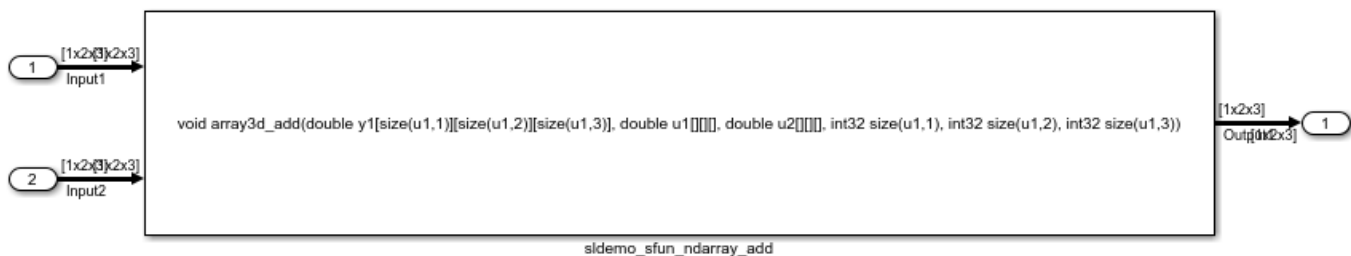

```
This legacy function computes the addition of the 2 input signals:
- Input1 and Input2 are dynamically sized 3D arrays
- Output1 is a dynamically sized 3D array of same size as Input1
- the last 3 function's arguments allow to pass the Input1's dimensions to the legacy function
```

See Also

“Implement Algorithms Using Legacy Code Tool”

Complex Signals in Legacy Function

This example shows you how to use the Legacy Code Tool to integrate legacy C functions using complex signals.

The Legacy Code Tool allows you to:

- Provide the legacy function specification,
- Generate a C-MEX S-function that is used during simulation to call the legacy code, and
- Compile and build the generated S-function for simulation.

Providing the Legacy Function Specification

Functions provided with the Legacy Code Tool take a specific data structure or array of structures as the argument. The data structure is initialized by calling the function `legacy_code()` using 'initialize' as the first input. After initializing the structure, you have to assign its properties to values corresponding to the legacy code being integrated. The prototype of the legacy functions being called in this example is:

```
void cplx_gain(creal_T *input, creal_T *gain, creal_T *output);
```

where `creal_T` is the complex representation of a double. The legacy source code is found in the files `cplxgain.h` and `cplxgain.c`.

```
% sldemo_sfun_gain_scalar
def = legacy_code('initialize');
def.SFunctionName = 'sldemo_sfun_cplx_gain';
def.OutputFcnSpec = 'void cplx_gain(complex<double> u1[1], complex<double> p1[1], complex<double>';
def.HeaderFiles = {'cplxgain.h'};
def.SourceFiles = {'cplxgain.c'};
def.IncPaths = {'sldemo_lct_src'};
def.SrcPaths = {'sldemo_lct_src'};
```

Generating and Compiling an S-Function for Use During Simulation

The function `legacy_code()` is called again with the first input set to 'generate_for_sim' in order to automatically generate and compile the C-MEX S-function according to the description provided by the input argument 'def'. This S-function is used to call the legacy functions in simulation. The source code for the S-function is found in the file `sldemo_sfun_cplx_gain.c`.

```
legacy_code('generate_for_sim', def);

### Start Compiling sldemo_sfun_cplx_gain
mex('-IC:\TEMP\Bdoc21b_1757077_3096\ib2EDA31\26\tp490052a0\ex34942047\sldemo_lct_src', '-IC:');
Building with 'Microsoft Visual C++ 2019 (C)'.
MEX completed successfully.
mex('sldemo_sfun_cplx_gain.c', '-IC:\TEMP\Bdoc21b_1757077_3096\ib2EDA31\26\tp490052a0\ex34942047');
Building with 'Microsoft Visual C++ 2019 (C)'.
MEX completed successfully.
### Finish Compiling sldemo_sfun_cplx_gain
### Exit
```

Generating an `rtwmakecfg.m` File for Code Generation

After the TLC block file is created, the function `legacy_code()` can be called again with the first input set to 'rtwmakecfg_generate' in order to generate an `rtwmakecfg.m` file to support code generation

through Simulink® Coder™. Generate the `rtwmakecfg.m` file if the required source and header files for the S-functions are not in the same directory as the S-functions, and you want to add these dependencies in the makefile produced during code generation.

Note: Complete this step only if you are going to simulate the model in accelerated mode.

```
legacy_code('rtwmakecfg_generate', def);
```

Generating a Masked S-Function Block for Calling the Generated S-Function

After the C-MEX S-function source is compiled, the function `legacy_code()` can be called again with the first input set to `'slblock_generate'` in order to generate a masked S-function block that is configured to call that S-function. The block is placed in a new model and can be copied to an existing model.

```
% legacy_code('slblock_generate', def);
```

Integration with Legacy Code

The model `sldemo_lct_cplxgain` shows integration with the legacy code. The subsystem `complex_gain` serves as a harness for the call to the legacy C function via the generate S-function.

```
if isempty(find_system('SearchDepth',0,'Name','sldemo_lct_cplxgain'))
    open_system('sldemo_lct_cplxgain')
    open_system('sldemo_lct_cplxgain/complex_gain')
    sim('sldemo_lct_cplxgain');
end
```

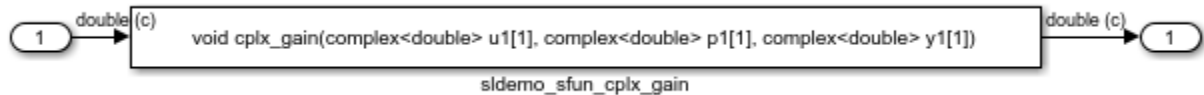

See Also

“Implement Algorithms Using Legacy Code Tool”

Specified or Inherited Sample Time with Legacy Functions

This example shows you how to use the Legacy Code Tool to integrate legacy C functions with the sample time specified, inherited and parameterized.

The Legacy Code Tool allows you to:

- Provide the legacy function specification,
- Generate a C-MEX S-function that is used during simulation to call the legacy code, and
- Compile and build the generated S-function for simulation.

Providing the Legacy Function Specification

Functions provided with the Legacy Code Tool take a specific data structure or array of structures as the argument. The data structure is initialized by calling the function `legacy_code()` using 'initialize' as the first input. After initializing the structure, you have to assign its properties to values corresponding to the legacy code being integrated. The prototypes of the legacy functions being called in this example are:

```
FLT gainScalar(const FLT in, const FLT gain)
```

where FLT is a typedef to float. The legacy source code is found in the files `your_types.h`, `gain.h`, and `gainScalar.c`.

```
defs = [];
```

```
% sldemo_sfun_st_inherited
def = legacy_code('initialize');
def.SFunctionName = 'sldemo_sfun_st_inherited';
def.OutputFcnSpec = 'single y1 = gainScalar(single u1, single p1)';
def.HeaderFiles = {'gain.h'};
def.SourceFiles = {'gainScalar.c'};
def.IncPaths = {'sldemo_lct_src'};
def.SrcPaths = {'sldemo_lct_src'};
defs = [defs; def];
```

```
% sldemo_sfun_st_fixed
def = legacy_code('initialize');
def.SFunctionName = 'sldemo_sfun_st_fixed';
def.OutputFcnSpec = 'single y1 = gainScalar(single u1, single p1)';
def.HeaderFiles = {'gain.h'};
def.SourceFiles = {'gainScalar.c'};
def.IncPaths = {'sldemo_lct_src'};
def.SrcPaths = {'sldemo_lct_src'};
def.SampleTime = [2 1];
defs = [defs; def];
```

```
% sldemo_sfun_st_parameterized
def = legacy_code('initialize');
def.SFunctionName = 'sldemo_sfun_st_parameterized';
def.OutputFcnSpec = 'single y1 = gainScalar(single u1, single p1)';
def.HeaderFiles = {'gain.h'};
def.SourceFiles = {'gainScalar.c'};
def.IncPaths = {'sldemo_lct_src'};
def.SrcPaths = {'sldemo_lct_src'};
```

```
def.SampleTime = 'parameterized';
defs = [defs; def];
```

Generating and Compiling an S-Function for Use During Simulation

The function `legacy_code()` is called again with the first input set to `'generate_for_sim'` in order to automatically generate and compile the C-MEX S-function according to the description provided by the input argument `'defs'`. This S-function is used to call the legacy functions in simulation. The source code for the S-function is found in the files `sldemo_sfuns_inherited.c`, `sldemo_sfuns_fixed.c`, and `sldemo_sfuns_parameterized.c`.

```
legacy_code('generate_for_sim', defs);
```

```
### Start Compiling sldemo_sfuns_inherited
    mex('-IC:\TEMP\Bdoc21b_1757077_3096\ib2EDA31\26\tp490052a0\ex32622275\sldemo_lct_src', '-IC:
Building with 'Microsoft Visual C++ 2019 (C)'.
MEX completed successfully.
    mex('sldemo_sfuns_inherited.c', '-IC:\TEMP\Bdoc21b_1757077_3096\ib2EDA31\26\tp490052a0\ex3
Building with 'Microsoft Visual C++ 2019 (C)'.
MEX completed successfully.
### Finish Compiling sldemo_sfuns_inherited
### Exit

### Start Compiling sldemo_sfuns_fixed
    mex('-IC:\TEMP\Bdoc21b_1757077_3096\ib2EDA31\26\tp490052a0\ex32622275\sldemo_lct_src', '-IC:
Building with 'Microsoft Visual C++ 2019 (C)'.
MEX completed successfully.
    mex('sldemo_sfuns_fixed.c', '-IC:\TEMP\Bdoc21b_1757077_3096\ib2EDA31\26\tp490052a0\ex32622
Building with 'Microsoft Visual C++ 2019 (C)'.
MEX completed successfully.
### Finish Compiling sldemo_sfuns_fixed
### Exit

### Start Compiling sldemo_sfuns_parameterized
    mex('-IC:\TEMP\Bdoc21b_1757077_3096\ib2EDA31\26\tp490052a0\ex32622275\sldemo_lct_src', '-IC:
Building with 'Microsoft Visual C++ 2019 (C)'.
MEX completed successfully.
    mex('sldemo_sfuns_parameterized.c', '-IC:\TEMP\Bdoc21b_1757077_3096\ib2EDA31\26\tp490052a0
Building with 'Microsoft Visual C++ 2019 (C)'.
MEX completed successfully.
### Finish Compiling sldemo_sfuns_parameterized
### Exit
```

Generating an `rtwmakecfg.m` File for Code Generation

After the TLC block file is created, the function `legacy_code()` can be called again with the first input set to `'rtwmakecfg_generate'` in order to generate an `rtwmakecfg.m` file to support code generation through Simulink® Coder™. Generate the `rtwmakecfg.m` file if the required source and header files for the S-functions are not in the same directory as the S-functions, and you want to add these dependencies in the makefile produced during code generation.

Note: Complete this step only if you are going to simulate the model in accelerated mode.

```
legacy_code('rtwmakecfg_generate', def);
```

Generating Masked S-Function Blocks for Calling the Generated S-Functions

After the C-MEX S-function source is compiled, the function `legacy_code()` can be called again with the first input set to `'slblock_generate'` in order to generate masked S-function blocks which are configured to call those S-functions. The blocks are placed in a new model and can be copied to an existing model.

```
% legacy_code('slblock_generate', defs);
```

Integration the Legacy Code

The model `sldemo_lct_sampletime` shows integration with the legacy code. The subsystem `sample_time` serves as a harness for the calls to the legacy C functions, with unit delays serving to store the previous output values.

```
open_system('sldemo_lct_sampletime')
open_system('sldemo_lct_sampletime/sample_time')
sim('sldemo_lct_sampletime');
```

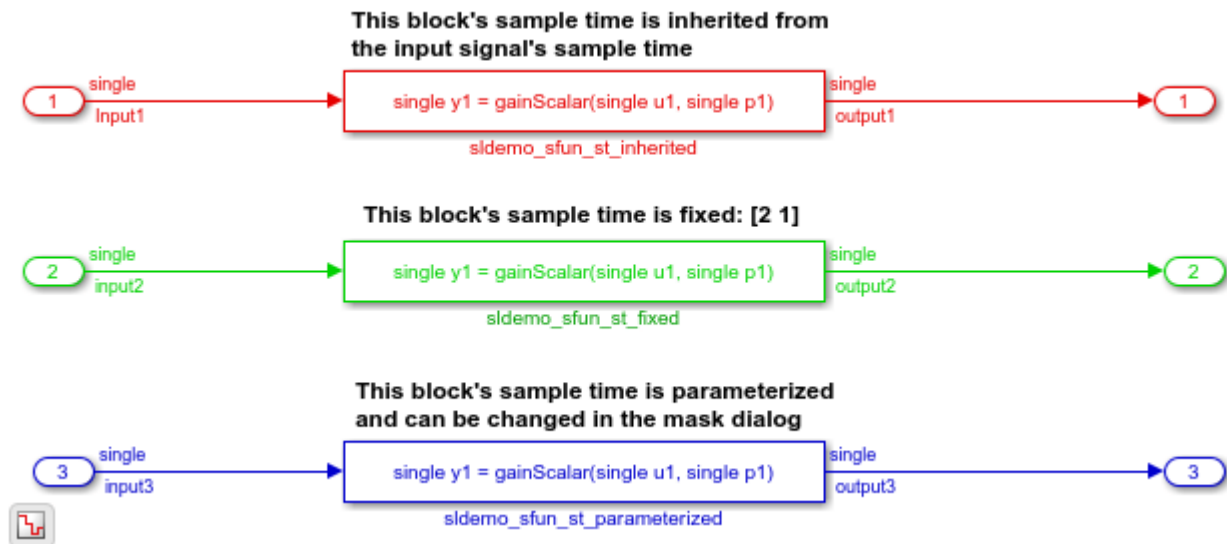

See Also

"Implement Algorithms Using Legacy Code Tool"

Illustration of Law of Large Numbers

This example shows how to use MATLAB System blocks to illustrate the law of large numbers.

The law of large numbers states that the cumulative average probability of an event approaches the expected value as the number of trials approaches infinity. You can see this in the generated plot.

A Uniform Random Number block connected to Compare To Constant block acts as a Bernoulli trial. The example uses the high value as successful outcome of the experiment.

This example highlights the use of MATLAB System block as follows:

- The Success Counter counts the number of successful trials. The Total Trials Counter counts the total number of trials. Both blocks use the same System object™. This System object is a source block that uses the "resetImpl" method to count the number of times the block has run at consecutive time steps.
- The Analysis and Plot block calculates the average probability and plots it. It uses a System object that inherits from the interface classes matlab.System. The interface class matlab.System is required for all System objects. To use features not supported for code generation, such as unsupported functions, define propagator methods for the System object. As a result, this block cannot simulate in "Code generation" mode. It must simulate in "Interpreted execution" mode.
- The two MATLAB System blocks use custom icons. The Analysis and Plot block uses an image file icon. The Total Trials Counter block uses a multiline text icon. The "getIconImpl" methods of the corresponding System objects define these custom icons.

MATLAB System Block Example: Illustration of Law of Large Numbers

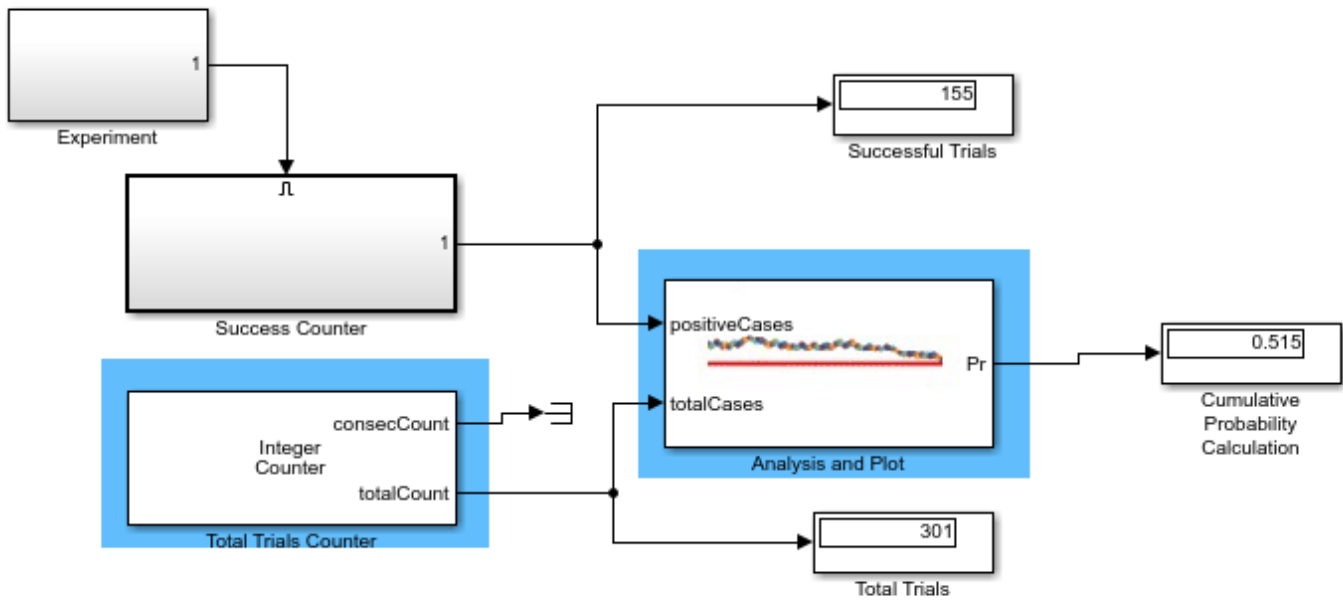

Copyright 2013 The Mathworks, Inc.

Using Buses with MATLAB System Blocks

This example shows how to use buses as inputs and outputs to the MATLAB System block.

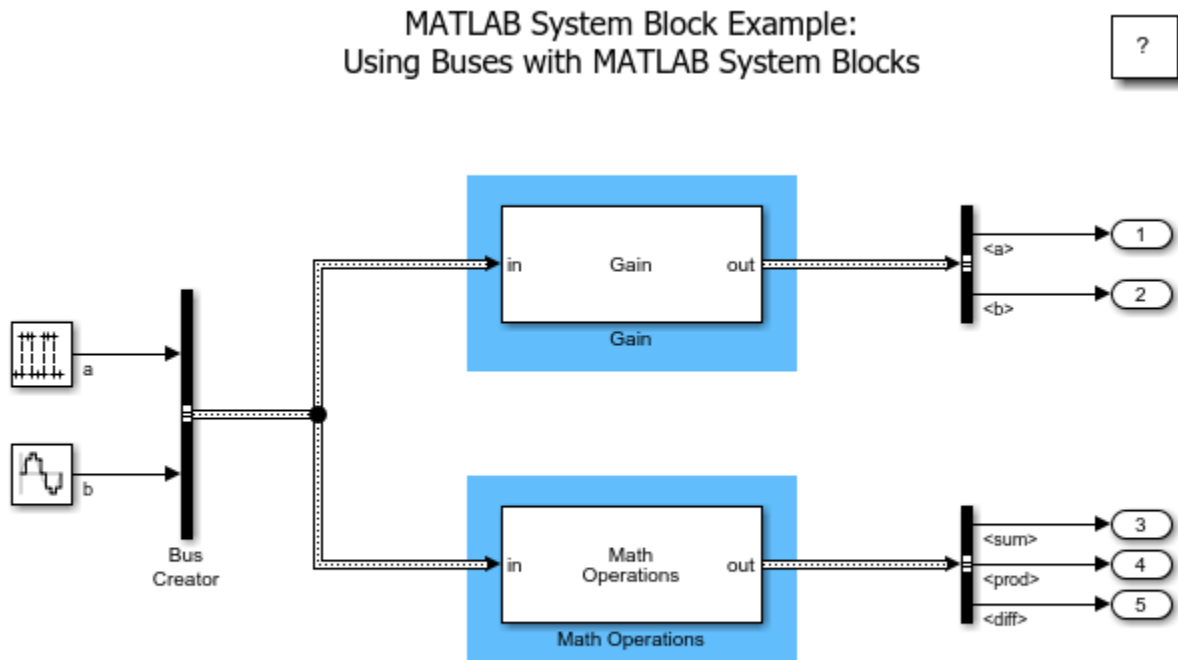

Copyright 2015 The MathWorks, Inc.

The Gain block uses a System object™ that applies the gain specified in the block to the bus elements 'a' and 'b' of the incoming bus. The output of the block is the same bus type as the input.

The Math Operations block uses a System object that computes the sum, product, and difference between the two bus elements 'a' and 'b' of the input bus. The output of the block is a bus with three elements: 'sum', 'prod', and 'diff'.

If a MATLAB System block output bus is the same type as the input bus, you must still specify the output bus name in the 'getOutputDataTypeImpl' method. This is because the 'propagatedInputDataType' method does not return the input bus object during bus propagation.

Before model initialization, all bus types used as either inputs or outputs to the MATLAB System block must be available in the MATLAB base workspace.

See Also

MATLAB System

More About

- “Nonvirtual Buses and MATLAB System Block”
- “Define System Object for Use in Simulink”

- “System Design in Simulink Using System Objects”

Run Quality Checks on S-Functions

This example shows how to use S-Function analyzer APIs to check S-functions, in order to identify potential problems and improvements.

The S-Function analyzer MATLAB command line APIs consist of:

- **Simulink.sfunction.Analyzer** - Class used to launch S-function analyzer and get analysis results.
- **Simulink.sfunction.analyzer.BuildInfo** - Class used to create an object to specify the build information for an S-function.
- **Simulink.sfunction.analyzer.Options** - Class used to specify the running options for S-function Analyzer.
- **Simulink.sfunction.analyzer.findSfunctions** - Static method to return all feasible S-functions in a model or library for S-function analyzer.

See the help for more detailed information about the above APIs.

Specify the Input Model or Library (required)

The S-Function analyzer requires a model or a library in MATLAB path as input, which contains the S-function blocks to be analyzed.

```
model = 'slexSfunctionCheckExample';
```

Specify the Build Information for S-functions (optional)

S-Function analyzer checks the source code of S-functions when they are available. Heuristics are applied to automatically locate the source code based on S-function names. For example, if S-function source code and the input model are in the same folder, the source code will be included in the analysis automatically. Otherwise, the build information has to be specified through `Simulink.sfunction.analyzer.BuildInfo`. If no source code is available, this section can be skipped.

To specify the build information, first determine the eligible S-functions in the input model, then create a `Simulink.sfunction.analyzer.BuildInfo` object for each S-function. For S-function `slexBadSFcn`, there are two associated source files: `slexBadSFcn.c` and `slexBadSFcn_wrapper.c`

```
sfunctions= Simulink.sfunction.analyzer.findSfunctions(model);
bdInfo= Simulink.sfunction.analyzer.BuildInfo(fullfile(matlabroot,'examples','simulink_features',
    'ExtraSrcFileList',{'slexBadSFcn_wrapper.c'},...
    'SrcPaths',{fullfile(matlabroot,'examples','simulink_features','slexBadSFcn')});
```

Specify the Running Options for S-function Analyzer (optional)

The execution options for S-function analyzer can be configured through `Simulink.sfunction.analyzer.Options` object, such as whether to enable Polyspace checks and Parameter Robustness checks, model simulation timeout, and output path for result report. If no specific options are needed, this section can be skipped. All default options will be applied.

```
opts = Simulink.sfunction.analyzer.Options();
opts.EnableRobustness = 1;
```

Run the S-function Analyzer and See the Result (required)

```
sfunAnalyzer = Simulink.sfunction.Analyzer(model, 'BuildInfo', {bdInfo}, 'Options', opts);  
analysisResult=sfunAnalyzer.run();  
sfunAnalyzer.generateReport();
```

Using the Prelookup and Interpolation Blocks

This examples shows how to use the Prelookup and Interpolation Using Prelookup blocks.

Introduction

This model uses Prelookup and Interpolation Using Prelookup blocks. The Prelookup block minimizes the number of index searches performed across a set of lookup tables. It also mixes clipping, extrapolation, and index search algorithms within one table calculation. Note how the Prelookup blocks perform the index search portion of the computation and the Interpolation Using Prelookup blocks perform the rest:

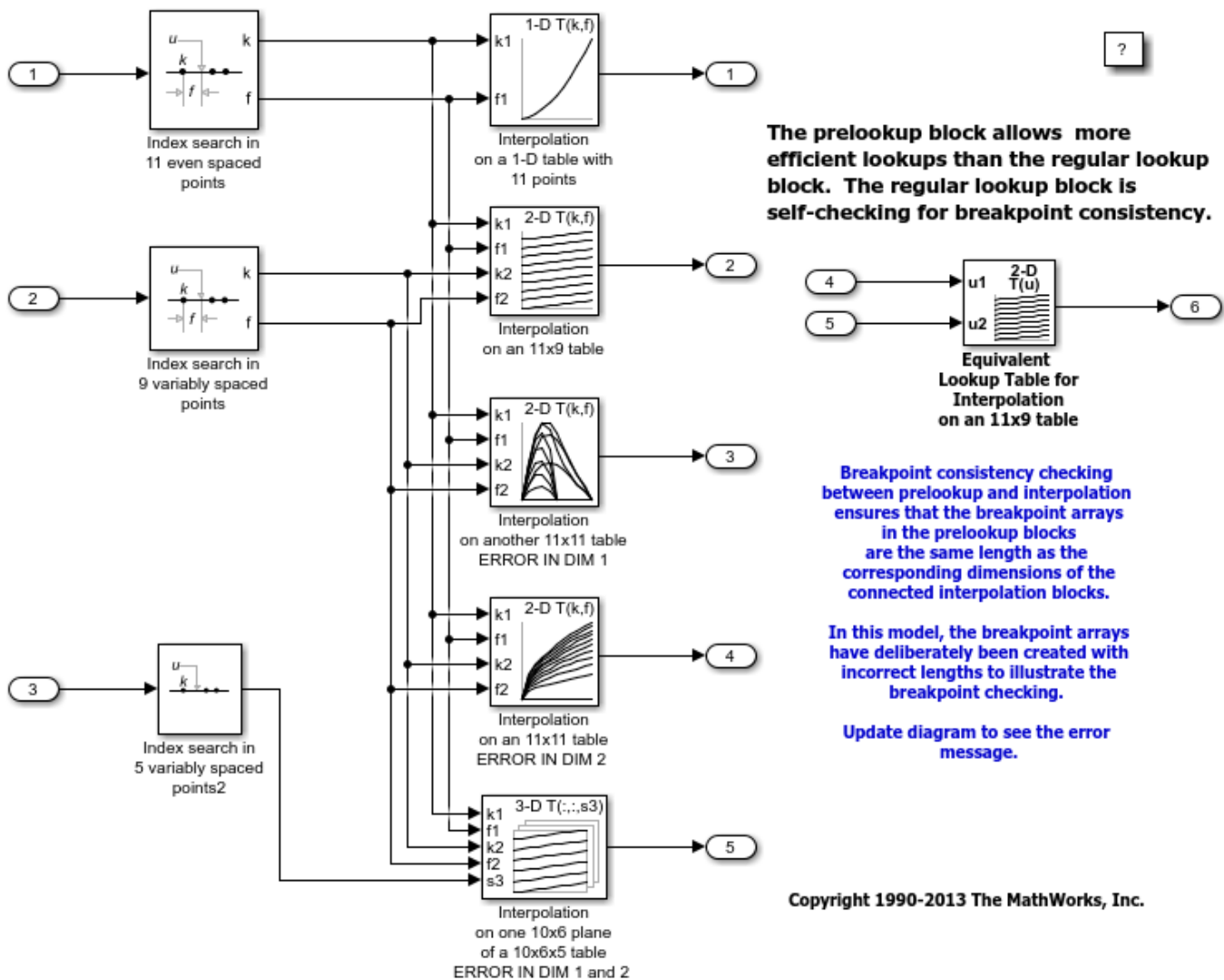

These blocks are in the Simulink® block library in the Lookup Tables sublibrary:

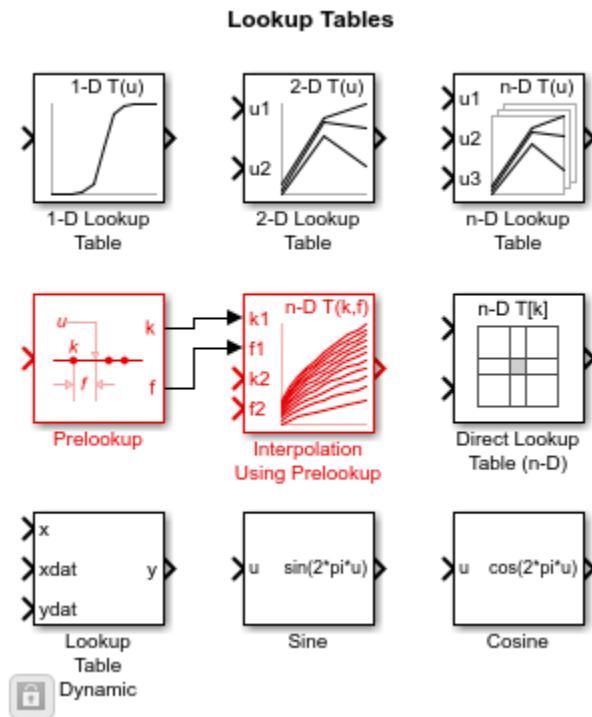

Optimization: PreLookup and Interpolation Using Prelookup Blocks

Consider using PreLookup block for tables with intensive index searches in breakpoint sets. The Prelookup blocks allow you to perform an index search once and reuse the result in many table lookups. In this model, three index search results are used in five blocks in a total of ten uses. Equivalent regular lookup tables such as the example to the right would have required ten index searches instead of three.

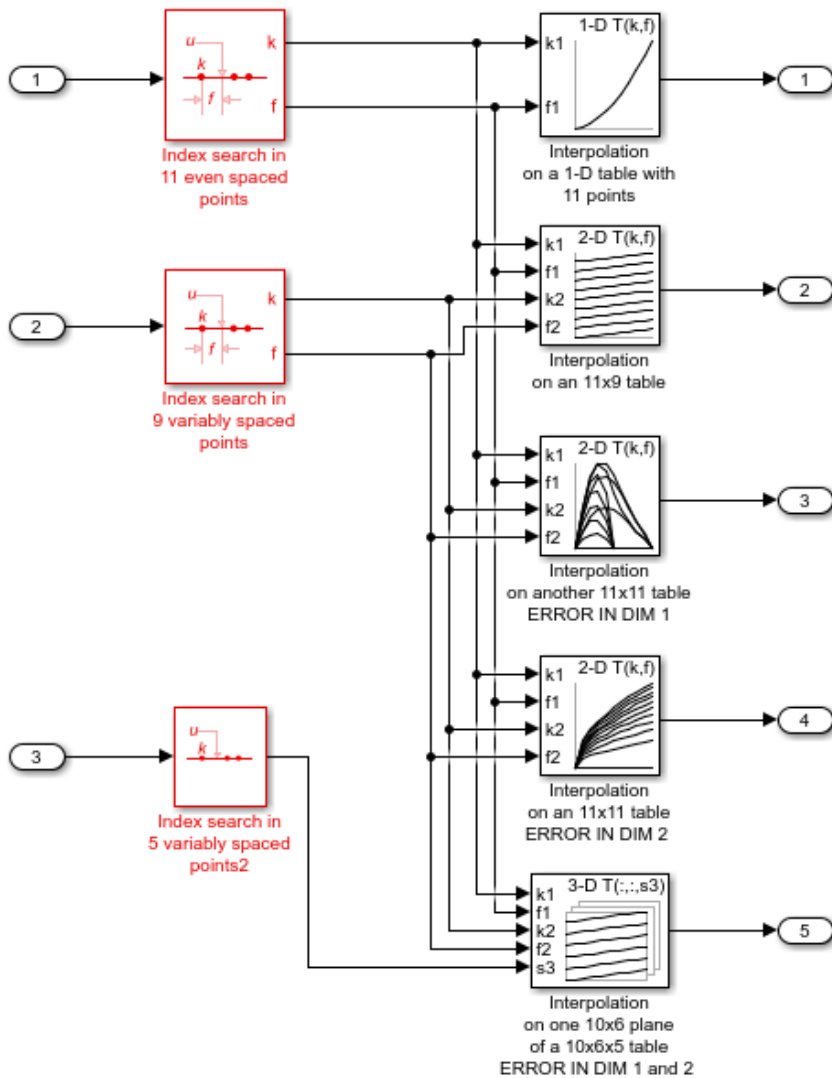

The prelookup block allows more efficient lookups than the regular lookup block. The regular lookup block is self-checking for breakpoint consistency.

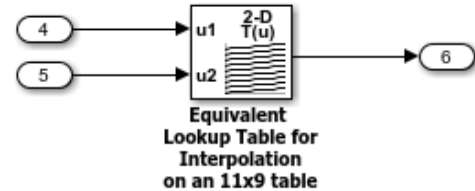

Breakpoint consistency checking between prelookup and interpolation ensures that the breakpoint arrays in the prelookup blocks are the same length as the corresponding dimensions of the connected interpolation blocks.

In this model, the breakpoint arrays have deliberately been created with incorrect lengths to illustrate the breakpoint checking.

Update diagram to see the error message.

Copyright 1990-2013 The MathWorks, Inc.

Optimization: Subtable Selection Option in the Interpolation Using Prelookup Blocks

One of the interpolation blocks in this model is configured using a capability: trailing dimensions of an n-D table can be marked as "selection dimensions", meaning that the input for that dimension is an integer used only to make a subtable selection, such as picking a 2-D plane from a 3-D table. The subtable is then interpolated normally.

Interpolation of subtables can save tremendous amounts of computation. For every dimension eliminated from interpolation, the computation almost halves. Since an N-dimensional interpolation takes $(2^N)-1$ individual interpolation operations ($y = y_{low} + f \cdot (y_{high} - y_{low})$), just one dimension of selection can almost double the speed of the interpolation. Extreme example: a 5-D table with three dimensions of subtable selection and 2-D interpolation: 5-D interpolation would take $2^5 - 1 = 31$ interpolations, but a 2-D interpolation takes only $2^2 - 1 = 3$.

The selection ports support vectorization to allow multiple subtable selection/interpolations in a single block.

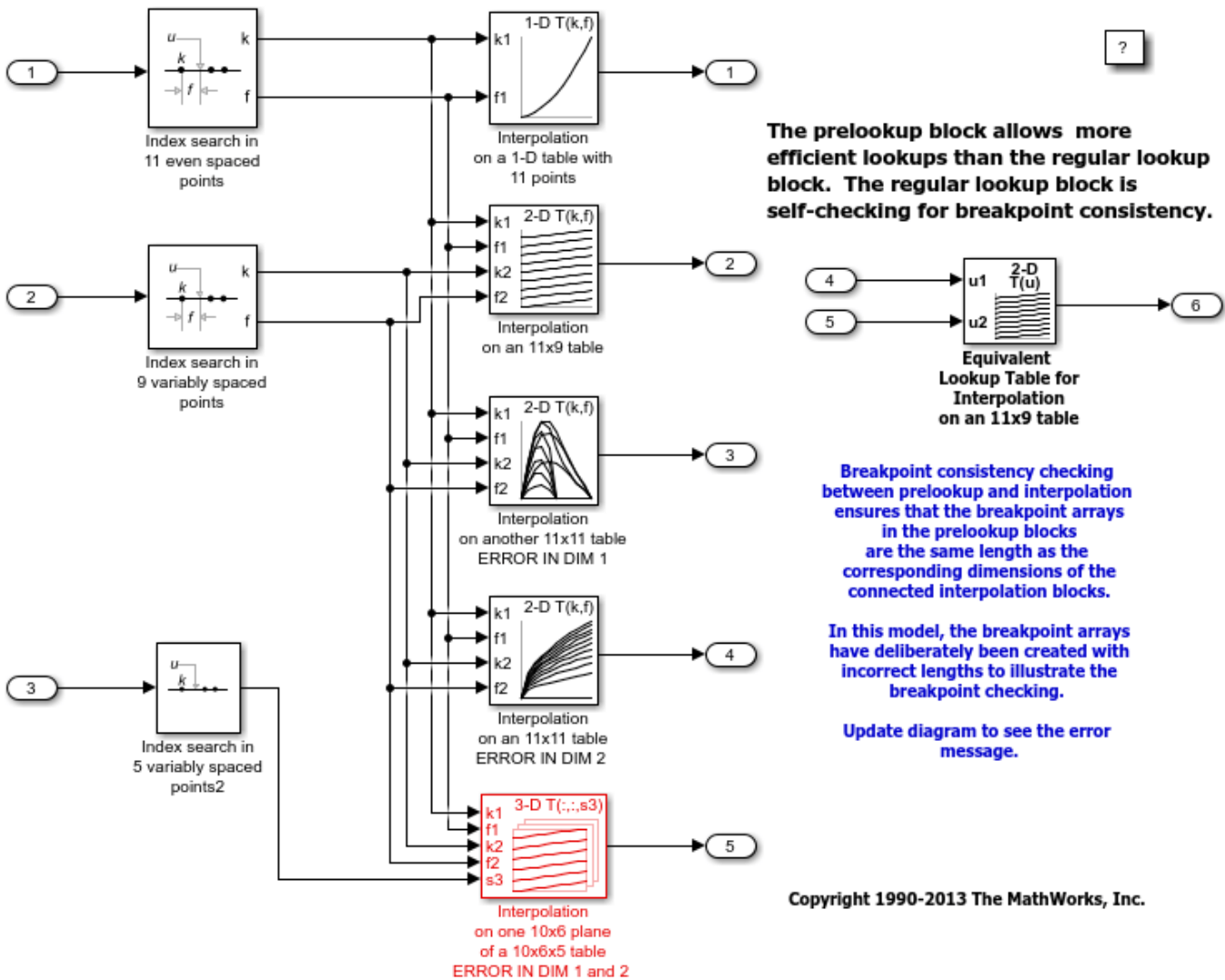

The subtable or multitable mode of operation is activated by setting a positive integer for the 'Number of sub-table selections dimensions' parameter in the block parameter dialog. The number you set is interpreted as the number of dimensions to select from the highest dimensions. For example, if you have a 3-D table and choose 2, that means the first dimension will be interpolated and dimensions 2 and 3 will be selected:

NOTE: You can remove highlighting from a model using the View/Remove highlighting menu item or this command:

```
set_param mdl, 'HiliteAncestors', 'none'
```

Breakpoint and Table Data Consistency Checking

Using Prelookup and Interpolation Using Prelookup blocks introduces a need to ensure that the length of the 'Breakpoint data' parameter in the Prelookup blocks matches the corresponding dimension of the 'Table data' parameter in the connected Interpolation Using Prelookup blocks.

Simulink® always checks the consistency between the two blocks when updating the block diagram. Simulink reports errors if it encounters inconsistent breakpoint and table data. For example:

```
try
    evalc(['sim(', mdl, ')']);
catch E
    disp(['Error:', E.message]);
end
```

Error:The range of values for input port k2 of block '<a href="matlab:open_and_hilite_hyperlink

Saving Memory in Prelookup and Interpolation Blocks by Using Smaller Data

This example shows how to save memory in Prelookup and Interpolation blocks. The Prelookup and Interpolation Using Prelookup blocks allow you to explicitly set data type storing breakpoints and table data. Note that the Prelookup block allows the breakpoint data to differ from the input data type, and the Interpolation Using Prelookup block allows the table data to differ from the output data type.

In this model, the breakpoints and table are stored using single precision floating-point data type, and the calculations are performed using double precision floating-point data type. This reduces the amount of breakpoint and table data memory by half.

To see this in the generated code, open the model and build it.

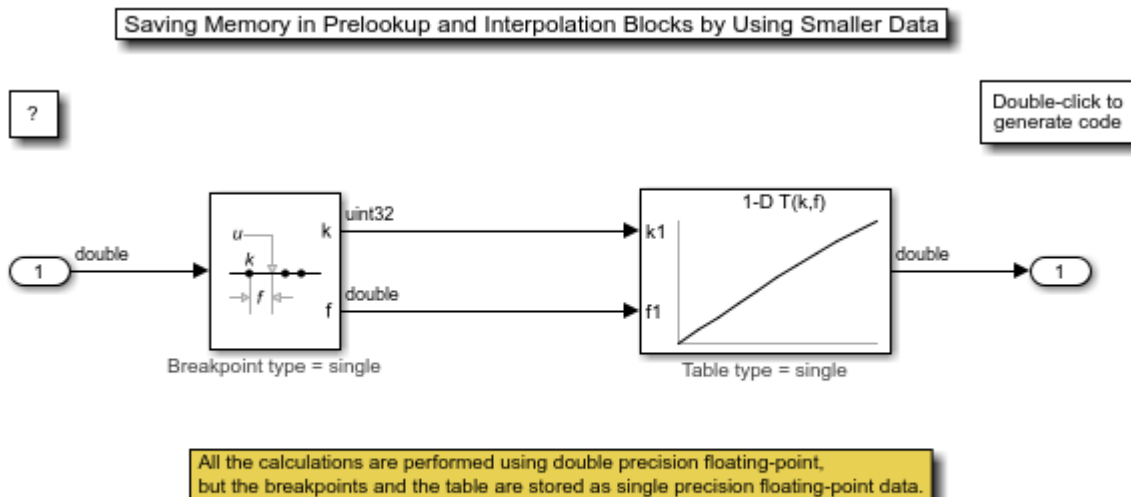

Model Advisor

This example shows the capabilities of the Model Advisor to check a model or subsystem for conditions and configuration settings that can result in inaccurate or inefficient simulation of the system represented by the model or generation of inefficient code from the model. The Model Advisor produces a report that lists all the suboptimal conditions or settings that it finds, suggesting better model configuration settings where appropriate.

The Model Advisor can be started through menus or the command line and can also be configured and used through a comprehensive API.

```
open_system('sldemo_mdladv')  
evalc('sim(''sldemo_mdladv'')');
```

See Also

modeladvisor | Simulink.ModelAdvisor

Related Examples

- “Check Your Model Using the Model Advisor”

More About

- “Analyze and Remodel Design”
- “Modeling Guidelines”

Introduction to Profiling Models

This example shows how to use the **Simulink Profiler** to examine the `slAccelDemoF14` model and identify issues that can contribute to poor simulation performance. Consider using the **Simulink Profiler** to manually optimize model settings, identify simulation slowdowns, and resolve performance bottlenecks.

To automatically optimize your model and achieve faster simulation, see “Improve Simulation Performance Using Performance Advisor”.

To learn more about accelerator modes for faster simulation, see “What Is Acceleration?”.

Activate the Profiler

To activate the Simulink® Profiler, in the Simulink Editor, on the **Debug** tab, under **Performance Advisor**, click **Simulink Profiler**. You can also issue a `set_param` command at the command prompt.

```
modelName = 'slAccelDemoF14';  
load_system(modelName)  
set_param(modelName, 'Profile', 'on');
```

Run Simulation

While the simulation runs, the profiler is collecting data for the report. Once the simulation is complete it creates an HTML report.

```
open_system(modelName)  
sim(modelName);
```

F-14 Longitudinal Flight Control

This example models a flight control for the longitudinal motion of a Grumman Aerospace F-14.

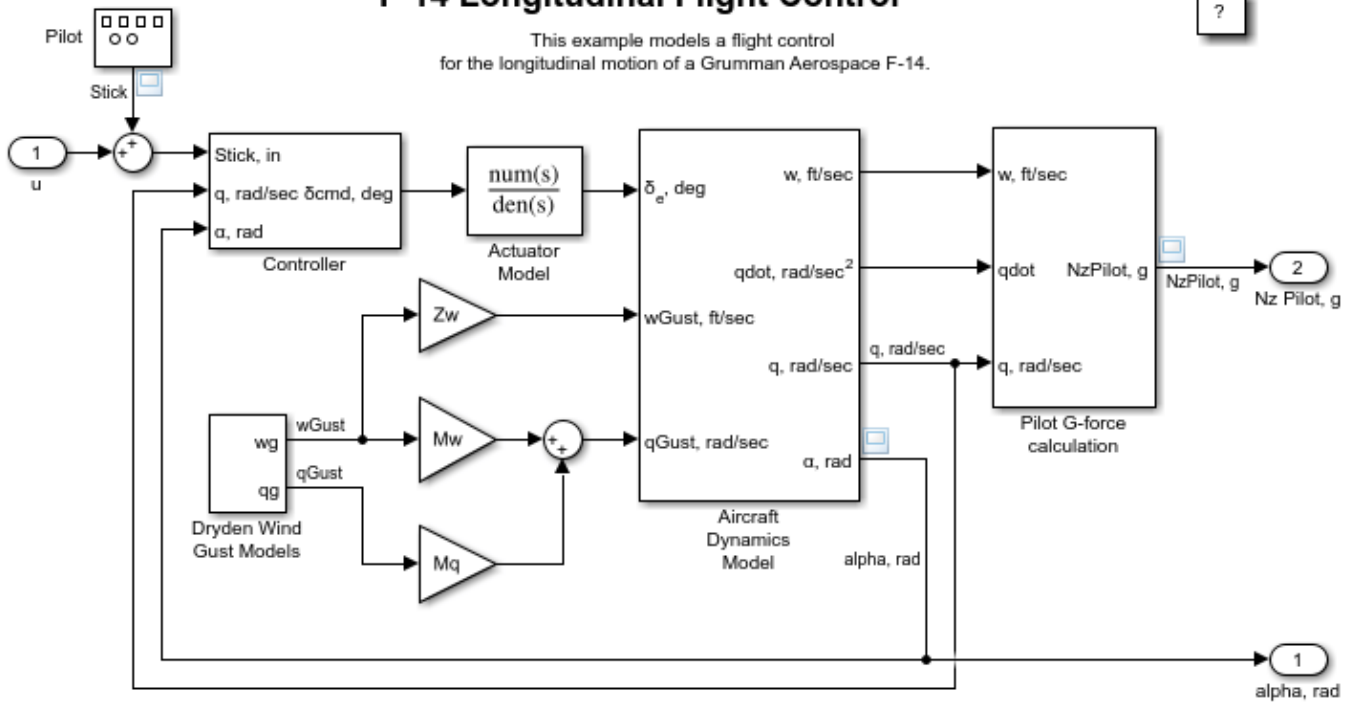

Copyright 1990-2020 The MathWorks, Inc.

View Report

A detailed profiling report is shown in a docked panel on the Simulink Editor. Select a row to see the breakdown of the self-time of the specific model element in the Property Inspector.

The screenshot displays the Simulink Profiler interface for the 'F-14 Longitudinal Flight Control' model. The main window shows the Simulink block diagram with various components like 'Stick in', 'Controller', 'Dryden-Wind Gust Models', 'Actuator Model', 'Aircraft Dynamics Model', and 'Pilot G-force calculation'. The Profiler Report is visible at the bottom, showing a table of performance metrics for different blocks.

| Path | Time (s) | Total Time (s) | Self Time (s) | Number of Calls |
|------------------------------|----------|----------------|---------------|-----------------|
| Root Profiler | 4.388 | 5.629 | 25002 | |
| Scope1 | 0.456 | 0.456 | 39556 | |
| Controller | 0.023 | 0.008 | 0 | |
| ...to-sensor Low-pass Filter | 0.008 | 0.008 | 21709 | |
| Stick Profiler | 0.002 | 0.002 | 21709 | |
| PI2H Rate Limit Filter | 0.002 | 0.002 | 21709 | |
| Sum2 | 0.002 | 0.002 | 39557 | |
| ...les Integral compensator | 0.002 | 0.002 | 21709 | |
| Gain2 | 0.001 | 0.001 | 39556 | |
| Gain3 | 0.001 | 0.001 | 39556 | |
| Sum3 | 0.001 | 0.001 | 39557 | |
| Gain | 0.001 | 0.001 | 39556 | |

The Profiler Report also includes a 'Total Time Breakdown for Stick Profiler' section, which shows a total time of 0.002 s (Total Time) = 0.002 s (Self Time) + 0.000 s (Total Time of children). The report also includes a 'Self Time Breakdown for Stick Profiler' table with columns for Path, Time (s), and Calls.

Share Report

You can share the profiling report with others as an HTML report or as a MAT file. To share your profiling run, select the desired run from the **Run** menu of the Profiling Report. Then select your desired export format from the **Share** menu on the Toolstrip.

See Also

Simulink Profiler

Related Examples

- “Introduction to Accelerating Models” on page 13-588

More About

- “How Profiler Captures Performance Data”
- “Use Performance Advisor to Improve Simulation Efficiency”

Turn on the Accelerator

To activate the Simulink® Accelerator, in the Simulink Editor, on the **Simulation** tab, under **Simulate**, select **Accelerator**. You can also issue a `set_param` command at the MATLAB® command prompt.

```
set_param(modelName, 'SimulationMode', 'Accelerator')
```

Build Accelerated Model

Build the accelerated model and simulate it. When running in Accelerator mode, you can start the model by selecting **Run** on the **Simulation** tab or by running the command:

```
sim(modelName)
```

at the MATLAB prompt. In either case, the progress of the code generation process will be displayed in the MATLAB command window. To suppress this display wrap the `sim` command inside an `evalc`.

```
evalc('sim(modelName);');
```

Simulate the Accelerated Model

Simulate the model again. Notice the model simulation runs much faster on subsequent runs.

```
tic
sim(modelName);
toc
```

```
Elapsed time is 5.201667 seconds.
```

Change Tunable Parameter and Simulate Accelerated Model

Change the value of one of the tunable parameters in the model and simulate the model again. Notice the accelerated version of the model does not have to be re-generated and so the simulation still runs more quickly in Accelerated mode than in Normal mode.

```
modelWorkspace = get_param(modelName, 'ModelWorkspace');
evalin(modelWorkspace, 'Mw=Mw*2;');
tic
sim(modelName);
toc
```

```
Elapsed time is 4.869604 seconds.
```

See Also

Related Examples

- “Introduction to Profiling Models” on page 13-585

Determine Why Simulink Accelerator Is Regenerating Code

Sometimes Simulink® regenerates the simulation target for a model at the beginning of a simulation in Accelerator Mode but it is not always clear why regeneration happens. This example shows how to use Simulink MATLAB® commands to determine why Simulink regenerates code for Accelerator Mode simulations.

Simulink's Accelerator Mode speeds up simulation of your model by creating an executable version of the model, called a simulation target, and running this target instead of interpreting the model, as is done during Normal Mode simulation.

The process of code generation happens during the first time that you simulate your model in Accelerator Mode. Additionally, code generation may happen on subsequent simulations, especially if the model changes between simulations (for example, after addition of a block). Code generation takes times and it is often desirable to avoid it, in order to maximize the number of simulations within a given time span.

Simulink uses the model's checksum to determine if the code needs to be regenerated. This checksum is an array of four integers computed by using an md5 checksum algorithm based on attributes of the model and the blocks that it contains. Any change in the model that changes the checksum causes Simulink to regenerate the simulation target for Accelerator Mode.

Sometimes, it is not clear which model change triggered a checksum change and hence code regeneration. This example shows how to investigate why Simulink needs to regenerate code for Accelerator Mode simulation for a given model and its configuration.

Open an Example Model

We will use a simple model, `slAccelDemoWhyRebuild`, throughout this example.

```
model = 'slAccelDemoWhyRebuild';
open_system(model)
```

Determine Why Simulink Accelerator Re-Builds

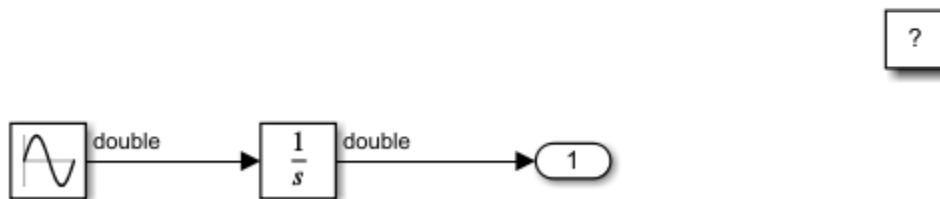

```
set_param(model, 'AccelVerboseBuild', 'on');
```

The first time the model runs in Accelerator mode, it generates and compiles code as expected.

```
simOutput = evalc(['sim('',model,')']);
if ~isempty(strfind(simOutput,'Building the Accelerator target for model'))
    disp('Built Simulink Accelerator mex file')
else
    disp('Did not build Simulink Accelerator mex file')
end
```

```
Built Simulink Accelerator mex file
```

If the simulation is run again, without any changes to the model, we expect that Simulink can reuse the existing code and does not need to regenerate the code. Execute the same commands to verify.

```
simOutput = evalc(['sim('',model,'')']);
if ~isempty(strfind(simOutput,'Building the Accelerator target for model'))
    disp('Built Simulink Accelerator mex file')
else
    disp('Did not build Simulink Accelerator mex file')
end
```

```
Did not build Simulink Accelerator mex file
```

Now we change some parameters in the model. We will set the following settings for the block 'Integrator':

- Set 'Ignore limit and reset when linearizing' to 'on'
- Set 'Initial Condition' to '5'

```
set_param([model,'/Integrator'],'IgnoreLimit','on');
set_param([model,'/Integrator'],'InitialCondition','5');
```

When we run the simulation again, we see that Simulink regenerates the code.

```
simOutput = evalc(['sim('',model,'')']);
if ~isempty(strfind(simOutput,'Building the Accelerator target for model'))
    disp('Built Simulink Accelerator mex file')
else
    disp('Did not build Simulink Accelerator mex file')
end
```

```
Built Simulink Accelerator mex file
```

We would like to know why.

To determine if the previously generated code is still valid for the current model configuration, Simulink compares the checksum of the model as used to generate the code to the current checksum. If they are equal, the previously generated code is still valid and Simulink Accelerator Mode reuses it for the current simulation. If the values differ, Simulink Accelerator Mode regenerates and rebuilds the code. Thus, examining the details of the checksum computation can reveal why Simulink regenerated the code.

Get Checksum Details

The following command gets the model checksum computation details:

```
[cs1,csdet1]=Simulink.BlockDiagram.getChecksum(model);
```

The first output is the model checksum value itself. The second output gives details of what went into the checksum computation.

Let us set the modified block parameters to their original values and get the checksum and details for that configuration.

```
set_param([model,'/Integrator'],'IgnoreLimit','off');
set_param([model,'/Integrator'],'InitialCondition','0');
[cs2,csdet2]=Simulink.BlockDiagram.getChecksum(model);
```

Comparing these two checksum values is equivalent to determining if the Simulink Accelerator will regenerate code. Note that the checksum values are different, as we expect based on the fact that Simulink Accelerator regenerates code every time it runs.

```
if (cs1 ~= cs2)
    disp('Checksums are different')
else
    disp('Checksums are the same')
end
```

Checksums are different

Now that we know that the checksums differ, the next question is why. Many things go into the checksum computation, including signal data types, some block parameter values, and block connectivity information. To understand why the checksums differ, we need to see what has changed about the items used in computing the checksum. The checksum details returned as the second argument give that information.

```
csdet1

csdet1 = struct with fields:
    ContentsChecksum: [1x1 struct]
    InterfaceChecksum: [1x1 struct]
    ContentsChecksumItems: [187x1 struct]
    InterfaceChecksumItems: [49x1 struct]
```

The checksum details is a structure array with four fields. Two of the fields are the component checksums of the model checksum (these are called ContentsChecksum and InterfaceChecksum) and the other two are the corresponding checksum details. These details correspond to various information which went into to the computation of the two component checksums. The model [structural] checksum is a function of ContentsChecksum and InterfaceChecksum.

First, let's determine if the difference lies in the model's contents or the model's interface.

```
if (csdet1.ContentsChecksum.Value ~= csdet2.ContentsChecksum.Value)
    disp('Contents checksums are different')
else
    disp('Contents checksums are the same')
end
```

Contents checksums are different

```
if (csdet1.InterfaceChecksum.Value ~= csdet2.InterfaceChecksum.Value)
    disp('Interface checksums are different')
else
    disp('Interface checksums are the same')
end
```

Interface checksums are the same

Use Details to Determine Why Checksum Changed

Now that we know the change is in the ContentsChecksum, we can look at the ContentsChecksumItems to see what has changed.

```
idxForDifferences=[];
for idx = 1:length(csdet1.ContentsChecksumItems)
```



```

if (~strcmp(csdet1.ContentsChecksumItems(idx).Handle, ...
           csdet2.ContentsChecksumItems(idx).Handle))
    idxForDifferences=[idxForDifferences,idx];
    disp(['Handles different for item ',num2str(idx)]);
end
if (~strcmp(csdet1.ContentsChecksumItems(idx).Identifier, ...
           csdet2.ContentsChecksumItems(idx).Identifier))
    disp(['Identifiers different for item ',num2str(idx)]);
    idxForDifferences=[idxForDifferences,idx];
end
if(ischar(csdet1.ContentsChecksumItems(idx).Value))
    if (~strcmp(csdet1.ContentsChecksumItems(idx).Value, ...
               csdet2.ContentsChecksumItems(idx).Value))
        disp(['String Values different for item ',num2str(idx)]);
        idxForDifferences=[idxForDifferences,idx];
    end
end
if(isnumeric(csdet1.ContentsChecksumItems(idx).Value))
    if (csdet1.ContentsChecksumItems(idx).Value ~= ...
        csdet2.ContentsChecksumItems(idx).Value)
        disp(['Numeric values are different for item ',num2str(idx)]);
        idxForDifferences=[idxForDifferences,idx];
    end
end
end
end

```

```
String Values different for item 40
```

Now that we know the differences are in the items at the indices listed in `idxForDifferences`, we can look at those items in the two `ContentsChecksumItems` arrays.

```

blk1 = csdet1.ContentsChecksumItems(idxForDifferences(1)).Handle

blk1 =
'slAccelDemoWhyRebuild/Integrator'

blk2 = csdet2.ContentsChecksumItems(idxForDifferences(1)).Handle

blk2 =
'slAccelDemoWhyRebuild/Integrator'

id1 = csdet1.ContentsChecksumItems(idxForDifferences(1)).Identifier

id1 =
'IgnoreLimit'

id2 = csdet2.ContentsChecksumItems(idxForDifferences(1)).Identifier

id2 =
'IgnoreLimit'

```

The Handle for both items is 'slAccelDemoWhyRebuild/Integrator', which indicates the block with the changing data. The identifier for both is 'IgnoreLimit' which tells us that this was the block setting which changed, resulting in a different checksum for the model. The setting for the Initial Condition of the block does not appear in the checksum detail. Therefore, we expect that if only the setting for the Initial Condition is modified, that no rebuild will occur.

Avoid Rebuild on Successive Simulations

Now that we found the parameter which causes the checksums to differ for this workflow, we can validate the findings by keeping that parameter constant and seeing whether rebuild occurs on successive simulations.

Let's simulate the model in Accelerator mode again. We expect it to rebuild for this simulation because we changed the parameter ('IgnoreLimit') for the checksum computation above.

```
simOutput = evalc(['sim('',model,'')']);
if ~isempty(strfind(simOutput,'Building the Accelerator target for model'))
    disp('Built Simulink Accelerator mex file')
else
    disp('Did not build Simulink Accelerator mex file')
end
```

```
Built Simulink Accelerator mex file
```

Now let's only change the Initial Condition setting and simulate again. We expect that no rebuild should happen this time.

```
set_param([model,'/Integrator'],'InitialCondition','-3');
simOutput = evalc(['sim('',model,'')']);
if ~isempty(strfind(simOutput,'Building the Accelerator target for model'))
    disp('Built Simulink Accelerator mex file')
else
    disp('Did not build Simulink Accelerator mex file')
end
```

```
Did not build Simulink Accelerator mex file
```

As expected from the checksum analysis, changing the parameter for 'Initial Condition' does not cause a regeneration of code for simulation in Accelerator mode.

See Also

[Simulink.BlockDiagram.buildRapidAcceleratorTarget](#) | [Simulink.BlockDiagram.getChecksum](#) | [Simulink.SubSystem.getChecksum](#)

Related Examples

- “Acceleration”

Parallel Simulations Using Parsim: Test-Case Sweep

This example shows how you can run multiple Simulink® simulations corresponding to different test cases in the Signal Editor block using SimulationInput objects and the `parsim` command. The `parsim` command uses Parallel Computing Toolbox™, if it is available, to run simulations in parallel, otherwise the simulations are run in serial.

Model Overview

The model `sldemo_suspn_3dof` shown below simulates the vehicle dynamics based on the road - suspension interaction for different road profiles. The vehicle dynamics are captured in three degrees of freedom: vertical displacement, roll, and pitch. The road profile data for the left and right tires is imported into the Signal Editor block as different test cases. The Road-Suspension Interaction subsystem calculates the suspension forces on the vehicle at the four tire locations based on the road data and the current vehicle state. In the Body Dynamics subsystem these forces and the resulting pitch and roll moments are used to determine the vehicle motion in three degrees of freedom: vertical displacement, roll, and pitch.

The suspension model is simulated using different road profiles to determine if the design meets desired performance goals. Parallel Computing Toolbox is used to speed up these multiple simulations, as illustrated below.

```
mdl = 'sldemo_suspn_3dof';
isModelOpen = bdIsLoaded(mdl);
open_system(mdl);
```

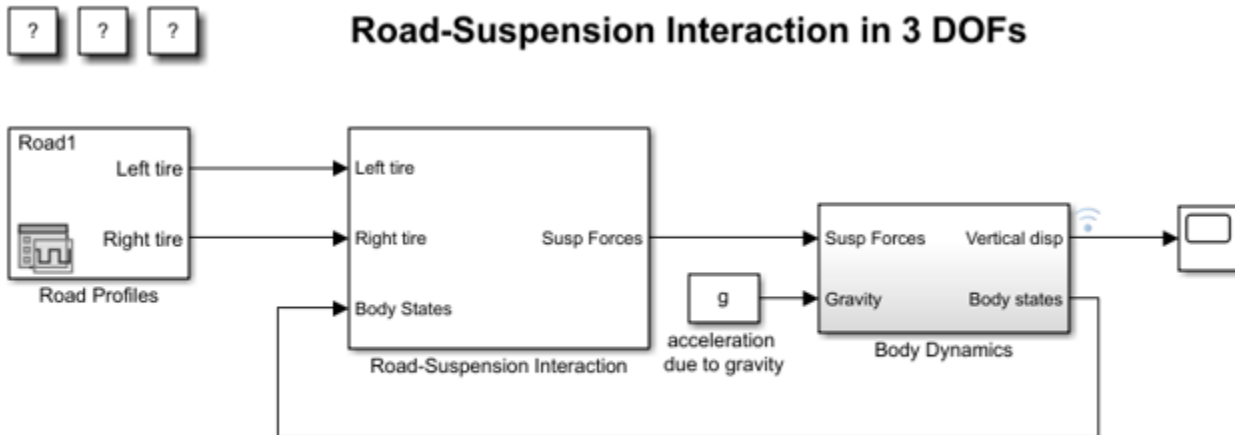

Copyright 2011-2018 The MathWorks, Inc.

Set up Data Required for Multiple Simulations

Determine the number of cases in the Signal Editor block using the `NumberOfScenarios` parameter of the Signal Editor block. The number of cases is used to determine the number of iterations to run in step 3.

```
sigEditBlk = [mdl '/Road Profiles'];
numCases = str2double(get_param(sigEditBlk, 'NumberOfScenarios'));
```

Create an array of `Simulink.SimulationInput` objects to define the set of simulations to run. Each `SimulationInput` object corresponds to one simulation and will be stored as an array in a variable, `in`. The mask parameter, `ActiveScenario`, specifies the sweep value for the Signal Editor block scenario. The active scenario is set for each simulation.

```
for idx = numCases:-1:1
    in(idx) = Simulink.SimulationInput mdl;
    in(idx) = setBlockParameter(in(idx), sigEditBlk, 'ActiveScenario', idx);
end
```

Note that specifying the model parameter on the `SimulationInput` object does not apply it to the model immediately. The specified value will be applied during the simulation and reverted back to its original value, if possible, after the simulation finishes.

Run Simulations in Parallel Using Parsim

Use the `parsim` function to execute the simulations in parallel. The array of `SimulationInput` objects, `in`, created in the last step is passed into the `parsim` function as the first argument. The output from the `parsim` command is an array of `Simulink.SimulationOutput` objects which is stored in the variable `out`. Set the 'ShowProgress' option to 'on' to print a progress of the simulations on the MATLAB command window.

```
out = parsim(in, 'ShowProgress', 'on');
```

```
[21-Feb-2021 01:43:41] Checking for availability of parallel pool...
Starting parallel pool (parpool) using the 'local' profile ...
Connected to the parallel pool (number of workers: 6).
[21-Feb-2021 01:44:30] Starting Simulink on parallel workers...
[21-Feb-2021 01:45:05] Configuring simulation cache folder on parallel workers...
[21-Feb-2021 01:45:07] Loading model on parallel workers...
[21-Feb-2021 01:45:13] Running simulations...
[21-Feb-2021 01:45:26] Completed 1 of 20 simulation runs
[21-Feb-2021 01:45:26] Completed 2 of 20 simulation runs
[21-Feb-2021 01:45:26] Completed 3 of 20 simulation runs
[21-Feb-2021 01:45:26] Completed 4 of 20 simulation runs
[21-Feb-2021 01:45:26] Completed 5 of 20 simulation runs
[21-Feb-2021 01:45:26] Completed 6 of 20 simulation runs
[21-Feb-2021 01:45:28] Completed 7 of 20 simulation runs
[21-Feb-2021 01:45:29] Completed 8 of 20 simulation runs
[21-Feb-2021 01:45:29] Completed 9 of 20 simulation runs
[21-Feb-2021 01:45:29] Completed 10 of 20 simulation runs
[21-Feb-2021 01:45:29] Completed 11 of 20 simulation runs
[21-Feb-2021 01:45:29] Completed 12 of 20 simulation runs
[21-Feb-2021 01:45:31] Completed 13 of 20 simulation runs
[21-Feb-2021 01:45:31] Completed 14 of 20 simulation runs
[21-Feb-2021 01:45:31] Completed 15 of 20 simulation runs
[21-Feb-2021 01:45:31] Completed 16 of 20 simulation runs
[21-Feb-2021 01:45:31] Completed 17 of 20 simulation runs
[21-Feb-2021 01:45:31] Completed 18 of 20 simulation runs
[21-Feb-2021 01:45:34] Completed 19 of 20 simulation runs
[21-Feb-2021 01:45:34] Completed 20 of 20 simulation runs
[21-Feb-2021 01:45:34] Cleaning up parallel workers...
```

Each `SimulationOutput` object contains the logged signal along with the `SimulationMetadata`. When running multiple simulations using `parsim`, errors are captured so that subsequent simulations can continue to run. Any errors would show up in the `ErrorMessage` property of the `SimulationOutput` object.

Plot Results

Plot the vertical vehicle displacement from the different simulations to see how the vehicle performed to the different road profiles. The signal is logged in the SimulationOutput object in the Dataset format. Use the get method to obtain the timeseries object containing the time and signal data from each element of out.

```

legend_labels = cell(1,numCases);
for i = 1:numCases
    simOut = out(i);
    ts = simOut.logout.get('vertical_disp').Values;
    ts.plot;
    legend_labels{i} = ['Run ' num2str(i)];
    hold all
end
title('Response of a 3-DoF Suspension Model')
xlabel('Time (s)');
ylabel('Vehicle vertical displacement (m)');
legend(legend_labels,'Location','NorthEastOutside');

```

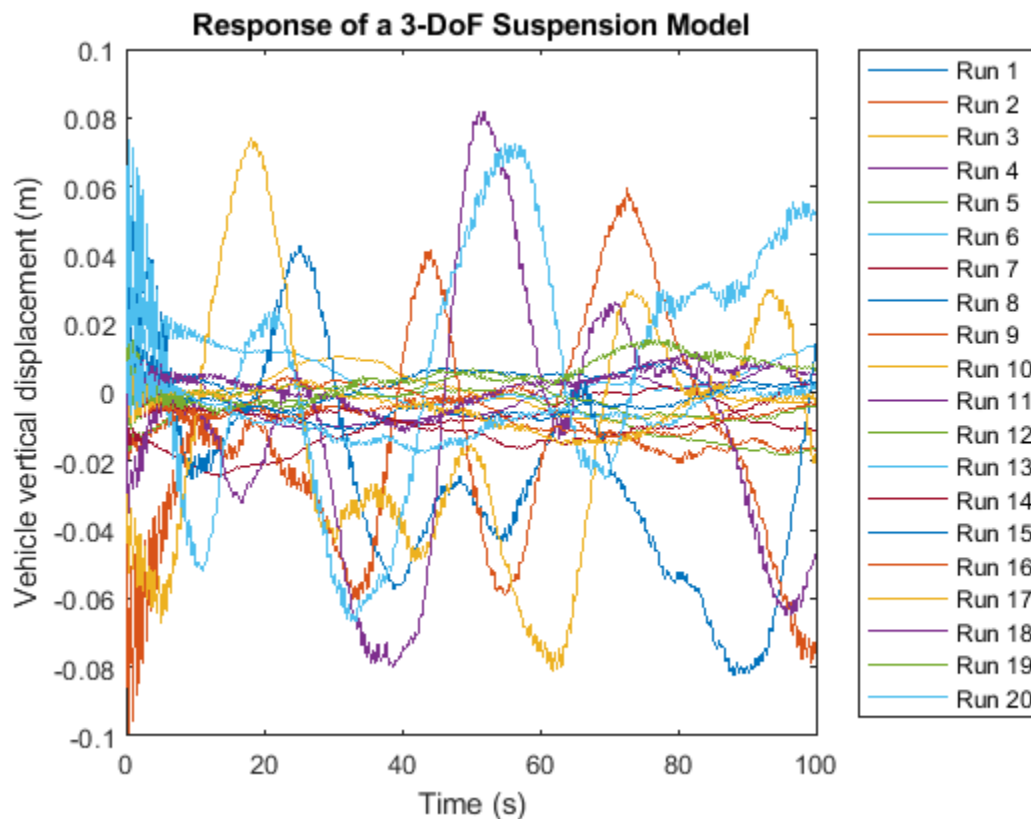

Close MATLAB Workers

Last, close the parallel pool and the model if they were not previously opened.

```

if(~isModelOpen)
    close_system mdl, 0);

```

```
end  
delete(gcf('nocreate'));
```

See Also

[parsim](#) | [Simulink.SimulationInput](#) | [Simulink.Simulation.Variable](#)

Related Examples

- “Running Multiple Simulations”
- “Run Parallel Simulations for a Thermal Model of a House Using parsim”
- “Run Parallel Simulations”
- “Comparison Between Multiple Simulation Workflows”

Parallel Simulations Using Parsim: Parameter Sweep in Normal Mode

This example shows how to run multiple simulations of a Monte Carlo study in parallel by using Parallel Computing Toolbox™. Parallel execution leverages the multiple cores of your host machine to run many simulations more quickly. These simulations could also be run in parallel on computer clusters using the MATLAB Parallel Server™. This example will work even if the Parallel Computing Toolbox™ or the MATLAB Parallel Server™ is not available, but the simulations will run in serial.

Explore Example Model

The model `sldemo_suspn_3dof` simulates vehicle dynamics based on the interaction between road and suspension for different road profiles. The model captures vehicle dynamics in three degrees of freedom: vertical displacement, roll, and pitch. The Signal Editor block stores measured road profile data for the left and right tires as different test groups. The Road-Suspension Interaction subsystem calculates the suspension forces on the vehicle at the four tire locations based on the road data and the current vehicle state. The Body Dynamics subsystem uses these forces and the resulting pitch and roll moments to calculate the vehicle motion in each of the three degrees of freedom.

In this Monte Carlo study, you inspect the impact of the front suspension coefficients on the vehicle dynamics. You run multiple simulations, each with a different coefficient value.

```
mdl = 'sldemo_suspn_3dof';
isModelOpen = bdIsLoaded(mdl);
open_system(mdl);
```

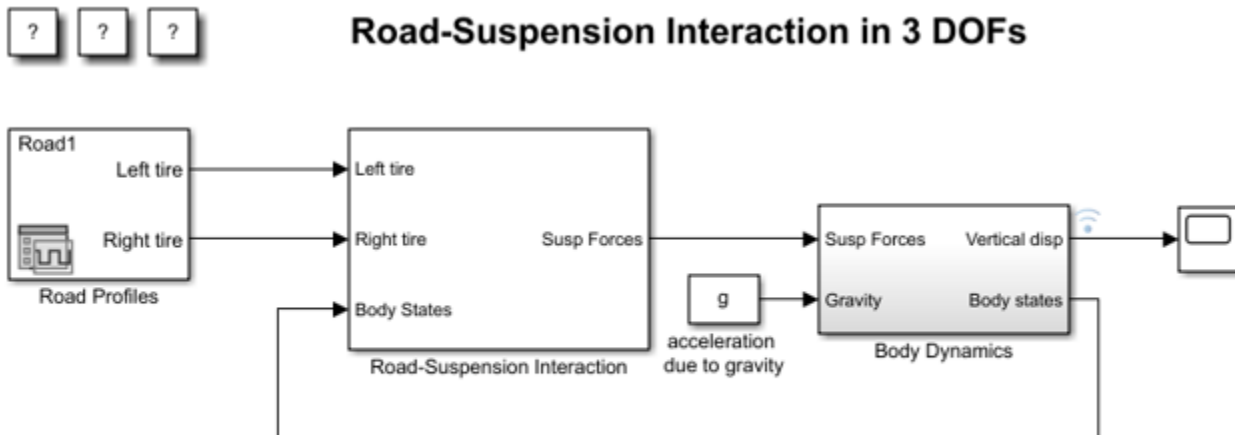

Copyright 2011-2018 The MathWorks, Inc.

In the model, double-click the Road-Suspension Interaction block. The mask dialog box opens. The mask parameter **Front susp. damping** sets the value of the damping coefficient, 150.

For the Body Dynamics block, find the signal that exits the `Vertical disp` output port. This signal represents the vertical vehicle displacement over time, which the suspension damping coefficient influences.

Right-click the signal and select **Properties**.

In the Signal Properties dialog box, the **Logging and accessibility** tab has **Log signal data** checked on, indicating that the signal is configured for logging. After the simulation finishes, you can use the specified logging name, `vertical_disp`, to identify the signal and acquire the simulation output data from the `SimulationOutput` object.

Prepare Parameter Inputs

Calculate the sweep values for the coefficient as percentages of the design value ranging from 5% to 95% in increments of 10%. Store the values in a variable, `Cf_sweep`, in the base workspace.

```
Cf_sweep = Cf*(0.05:0.1:0.95);
```

Determine the number of simulations to run, which is equal to the number of sweep values. Store the number in a variable, `numSims`.

```
numSims = length(Cf_sweep);
```

Use a `for` loop to:

- 1 Create `Simulink.SimulationInput` objects for the model. Create one object per simulation. Store the objects as an array in a variable, `in`.
- 2 Specify the sweep value for each simulation. Identify the target mask parameter by its underlying name, `Cf`.

```
for i = numSims:-1:1
    in(i) = Simulink.SimulationInput mdl;
    in(i) = setBlockParameter(in(i), [mdl '/Road-Suspension Interaction'], 'Cf', num2str(Cf_sweep(i)));
end
```

Note that specifying the block parameter on the `SimulationInput` object does not apply it to the model immediately. The specified value will be applied during the simulation and reverted back to its original value, if possible, after the simulation finishes.

Run Simulations in Parallel Using Parsim

Use the `parsim` function to execute the simulations in parallel. The array of `SimulationInput` objects, `in`, created in the last step is passed into the `parsim` function as the first argument. The output from the `parsim` command is an array of `SimulationOutput` objects which is stored in the variable `out`. Set the `'ShowProgress'` option to `'on'` to print a progress of the simulations on the MATLAB command window.

```
out = parsim(in, 'ShowProgress', 'on');
```

```
[20-Feb-2021 23:49:38] Checking for availability of parallel pool...
Starting parallel pool (parpool) using the 'local' profile ...
Connected to the parallel pool (number of workers: 6).
[20-Feb-2021 23:50:23] Starting Simulink on parallel workers...
[20-Feb-2021 23:51:11] Configuring simulation cache folder on parallel workers...
[20-Feb-2021 23:51:13] Loading model on parallel workers...
[20-Feb-2021 23:51:18] Running simulations...
[20-Feb-2021 23:51:31] Completed 1 of 10 simulation runs
[20-Feb-2021 23:51:31] Completed 2 of 10 simulation runs
[20-Feb-2021 23:51:31] Completed 3 of 10 simulation runs
[20-Feb-2021 23:51:31] Completed 4 of 10 simulation runs
[20-Feb-2021 23:51:31] Completed 5 of 10 simulation runs
[20-Feb-2021 23:51:31] Completed 6 of 10 simulation runs
[20-Feb-2021 23:51:33] Completed 7 of 10 simulation runs
```



```
[20-Feb-2021 23:51:33] Completed 8 of 10 simulation runs
[20-Feb-2021 23:51:33] Completed 9 of 10 simulation runs
[20-Feb-2021 23:51:34] Completed 10 of 10 simulation runs
[20-Feb-2021 23:51:34] Cleaning up parallel workers...
```

Each `SimulationOutput` object contains the logged signal along with the `SimulationMetadata`. When running multiple simulations using `parsim`, errors are captured so that subsequent simulations can continue to run. Any errors would show up in the `ErrorMessage` property of the `SimulationOutput` object.

Plot Results

Plot the vertical vehicle displacement from the different simulations to see how varying the damping coefficient affects the vehicle dynamics. The signal is logged in the `SimulationOutput` object in the `Dataset` format. Use the `get` method to obtain the timeseries object containing the time and signal data from each element of `out`.

```
legend_labels = cell(1,numSims);

for i = numSims:-1:1
    simOut = out(i);
    ts = simOut.logout.get('vertical_disp').Values;
    % 'ts' is a MATLAB 'timeseries' object that stores the time and
    % data values for the logged 'vertical_disp' signal.
    % Use the 'plot' method of the object to plot the data against the
    % time.
    plot(ts);
    legend_labels{i} = ['Run ' num2str(i)];
    hold all
end

title('Response of a 3-DoF Suspension Model')
xlabel('Time (s)');
ylabel('Vehicle vertical displacement (m)');
legend(legend_labels,'Location','NorthEastOutside');
```

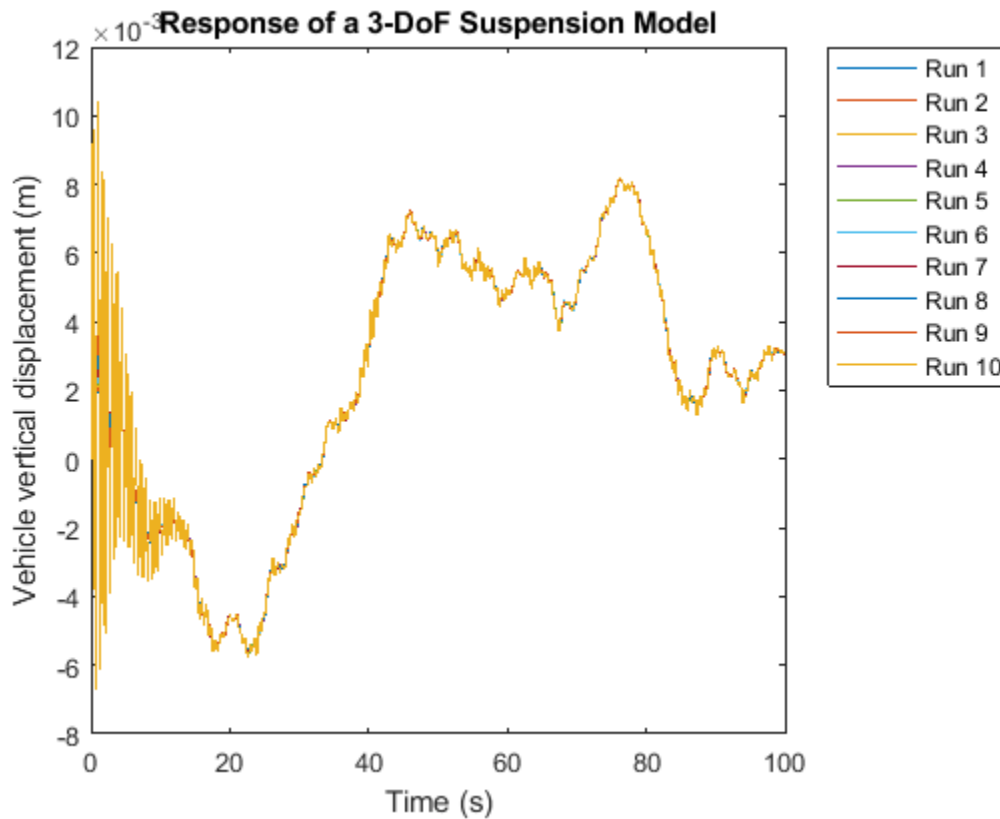

Close MATLAB Workers

Last, close the parallel pool and the model if they were not previously opened.

```
if(~isModelOpen)
    close_system mdl, 0);
end
delete(gcf('nocreate'));
```

Parallel pool using the 'local' profile is shutting down.

See Also

[parsim](#) | [Simulink.SimulationInput](#) | [Simulink.Simulation.Variable](#)

Related Examples

- “Running Multiple Simulations”
- “Run Parallel Simulations for a Thermal Model of a House Using parsim”
- “Run Parallel Simulations”
- “Comparison Between Multiple Simulation Workflows”

Parallel Simulations Using Parsim: Parameter Sweep in Rapid Accelerator Mode

This example shows how to run multiple simulations of a Monte Carlo study in parallel by using Parallel Computing Toolbox™. Parallel execution leverages the multiple cores of your host machine to run many simulations more quickly. These simulations could also be run in parallel on computer clusters using the MATLAB Parallel Server™. This example will work even if the Parallel Computing Toolbox™ or the MATLAB Parallel Server™ is not available, but the simulations will run in serial.

Explore Example Model

The model `sldemo_suspn_3dof` simulates vehicle dynamics based on the interaction between road and suspension for different road profiles. The model captures vehicle dynamics in three degrees of freedom: vertical displacement, roll, and pitch. The Signal Editor block stores measured road profile data for the left and right tires as different test groups. The Road-Suspension Interaction subsystem calculates the suspension forces on the vehicle at the four tire locations based on the road data and the current vehicle state. The Body Dynamics subsystem uses these forces and the resulting pitch and roll moments to calculate the vehicle motion in each of the three degrees of freedom.

In this Monte Carlo study, the vehicle mass is varied to study its effect on the vehicle dynamics. Parallel Computing Toolbox is used to speed up these multiple simulations, as illustrated below.

```
mdl = 'sldemo_suspn_3dof';
isModelOpen = bdIsLoaded(mdl);
open_system(mdl);
```

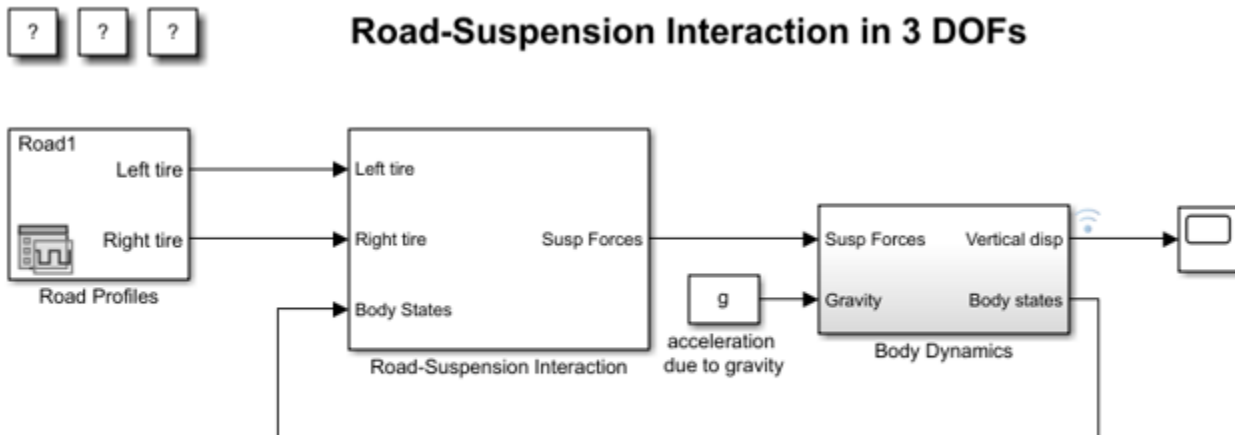

Copyright 2011-2018 The MathWorks, Inc.

Setup to Build the Rapid Accelerator Target

The Rapid Accelerator executable for the model is built in the `SetupFcn` call using the `Simulink.BlockDiagram.buildRapidAcceleratorTarget` function. The `buildRapidAcceleratorTarget` function returns the default run-time parameter set which is assigned to a global variable, `RTP`, in the `SetupFcn` and is used in the next step to modify the parameter values. Open `sldemo_parsim_paramsweep_suspn_raccel_setup` in the editor to inspect the

code. Note that the build process is optimized so that if the build files are already present and compatible with the model and machine architecture then it returns early.

Set up Multiple Simulations Using SimulationInput Objects

Store the sweep values in a variable, `Mb_sweep`, in the base workspace.

```
Mb_sweep = Mb*(0.5:5:45.5);
```

Determine the number of simulations to run, which is equal to the number of sweep values. Store the number in a variable, `numSims`.

```
numSims = length(Mb_sweep);
```

Use a for loop to:

- 1 Create `Simulink.SimulationInput` objects for the model. Create one object per simulation. Store the objects as an array in a variable, `in`.
- 2 Specify the model parameters on the `SimulationInput` object.

```
for i = numSims:-1:1
    in(i) = Simulink.SimulationInput mdl;
    in(i) = in(i).setModelParameter('SimulationMode', 'rapid', ...
        'RapidAcceleratorUpToDateCheck', 'off');
    in(i).PreSimFcn = @(x) sldemo_parsim_paramsweep_suspn_raccel_presim(x, Mb_sweep(i));
end
```

The `SimulationInput` object is used to modify the model parameters. 'SimulationMode' is set to use rapid accelerator and 'RapidAcceleratorUpToDateCheck' model parameter is set to 'off' to skip up-to-date checks since there are no structural changes made to the model between simulations and the same build files can be used. Note that specifying the model parameter on the `SimulationInput` object does not apply it to the model immediately. The specified value will be applied during the simulation and reverted back to its original value, if possible, after the simulation finishes. Inspect the code in the `PreSimFcn`, `sldemo_parsim_paramsweep_suspn_raccel_presim`. It uses `modifyTunableParameters` from the `Simulink.BlockDiagram` package to change the parameter corresponding to vehicle mass. The first argument to the `PreSimFcn` is always the `SimulationInput` object, and is passed into the function by `Simulink@`. The `PreSimFunction` adds another model parameter to the `SimulationInput` object and returns it to be used for simulation.

Run Simulations in Parallel Using Parsim

Use the `parsim` function to execute the simulations in parallel. The array of `SimulationInput` objects, `in`, created in the last step is passed into the `parsim` function as the first argument. The output from the `parsim` command is an array of `Simulink.SimulationOutput` objects which is stored in the variable `out`. Set the 'ShowProgress' option to 'on' to print a progress of the simulations on the MATLAB command window. As mentioned earlier, the `SetupFcn` is passed as a parameter to the `parsim` command to build the rapid accelerator target on the workers if required.

```
out = parsim(in, 'ShowProgress', 'on', ...
    'SetupFcn', @() sldemo_parsim_paramsweep_suspn_raccel_setup mdl);
```

```
[29-Jun-2021 11:44:35] Checking for availability of parallel pool...
Starting parallel pool (parpool) using the 'local' profile ...
Connected to the parallel pool (number of workers: 6).
[29-Jun-2021 11:45:42] Starting Simulink on parallel workers...
Analyzing and transferring files to the workers ...done.
```

```
[29-Jun-2021 11:46:45] Configuring simulation cache folder on parallel workers...
[29-Jun-2021 11:46:47] Running SetupFcn on parallel workers...
[29-Jun-2021 11:48:04] Loading model on parallel workers...
[29-Jun-2021 11:48:12] Running simulations...
[29-Jun-2021 11:48:26] Completed 1 of 10 simulation runs
[29-Jun-2021 11:48:26] Completed 2 of 10 simulation runs
[29-Jun-2021 11:48:26] Completed 3 of 10 simulation runs
[29-Jun-2021 11:48:26] Completed 4 of 10 simulation runs
[29-Jun-2021 11:48:26] Completed 5 of 10 simulation runs
[29-Jun-2021 11:48:26] Completed 6 of 10 simulation runs
[29-Jun-2021 11:48:32] Completed 7 of 10 simulation runs
[29-Jun-2021 11:48:32] Completed 8 of 10 simulation runs
[29-Jun-2021 11:48:32] Completed 9 of 10 simulation runs
[29-Jun-2021 11:48:32] Completed 10 of 10 simulation runs
[29-Jun-2021 11:48:32] Cleaning up parallel workers...
```

Each `SimulationOutput` object contains the logged signal along with the `SimulationMetadata`. When running multiple simulations using `parsim`, errors are captured so that subsequent simulations can continue to run. Any errors would show up in the `ErrorMessage` property of the `SimulationOutput` object.

Plot Results

Plot the vertical vehicle displacement from the different simulations to see how varying the vehicle mass affected the vehicle dynamics. Use the `get` method of the `SimulationOutput` object to obtain the time and signal data contained in each element of `simout`.

```
legend_labels = cell(1,numSims);
for i = 1:numSims
    simOut = out(i);
    ts = simOut.logout.get('vertical_disp').Values;
    ts.plot;
    legend_labels{i} = ['Run ' num2str(i)];
    hold all
end
title('Response of a 3-DoF Suspension Model')
xlabel('Time (s)');
ylabel('Vehicle vertical displacement (m)');
legend(legend_labels,'Location','NorthEastOutside');
```

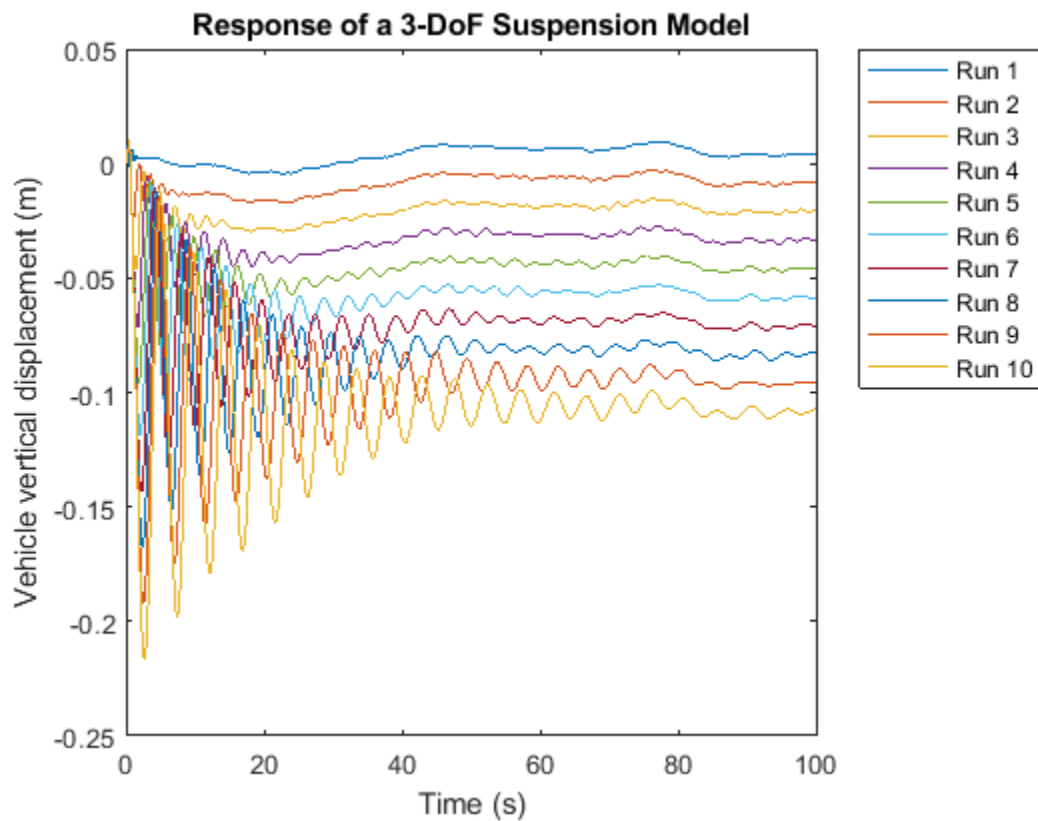

Close MATLAB Workers

Last, close the parallel pool and the model if they were not previously opened.

```
if(~isModelOpen)
    close_system mdl, 0);
end
delete(gcp('nocreate'));
```

Parallel pool using the 'local' profile is shutting down.

See Also

[parsim](#) | [Simulink.SimulationInput](#) | [Simulink.Simulation.Variable](#)

Related Examples

- “Running Multiple Simulations”
- “Run Parallel Simulations for a Thermal Model of a House Using parsim”
- “Run Parallel Simulations”
- “Comparison Between Multiple Simulation Workflows”

Rapid Accelerator Simulations Using Parsim

This example shows the use of Rapid Accelerator in applications that require running parallel simulations for a range of input and parameter values.

The example uses a model that simulates the idle speed of an engine. The model input is the voltage of the bypass air valve. The output is the idle speed.

Use `parsim` to run parallel simulations with two sets of valve voltages. Independently vary two of the three transfer function gain parameters over a range of two values. The following table lists the eight simulations, along with the parameter values. In Step 2, create the external inputs, `inpSets`. The variables `gain2` and `gain3` correspond to the two gain parameters.

| | | | |
|-------|-------------------------|-------------------------|-------------------------|
| Run 1 | <code>inpSets(1)</code> | <code>gain2 = 25</code> | <code>gain3 = 20</code> |
| Run 2 | <code>inpSets(1)</code> | <code>gain2 = 25</code> | <code>gain3 = 30</code> |
| Run 3 | <code>inpSets(1)</code> | <code>gain2 = 35</code> | <code>gain3 = 20</code> |
| Run 4 | <code>inpSets(1)</code> | <code>gain2 = 35</code> | <code>gain3 = 30</code> |
| Run 5 | <code>inpSets(2)</code> | <code>gain2 = 25</code> | <code>gain3 = 20</code> |
| Run 6 | <code>inpSets(2)</code> | <code>gain2 = 25</code> | <code>gain3 = 30</code> |
| Run 7 | <code>inpSets(2)</code> | <code>gain2 = 35</code> | <code>gain3 = 20</code> |
| Run 8 | <code>inpSets(2)</code> | <code>gain2 = 35</code> | <code>gain3 = 30</code> |

Step 1: Preparation

First, open the model. The simulation mode is set to Rapid Accelerator. The default input data, and the required parameters are preloaded in the base workspace.

Open model:

```
mdl = 'sldemo_raccel_engine_idle_speed';
open_system(mdl);
```

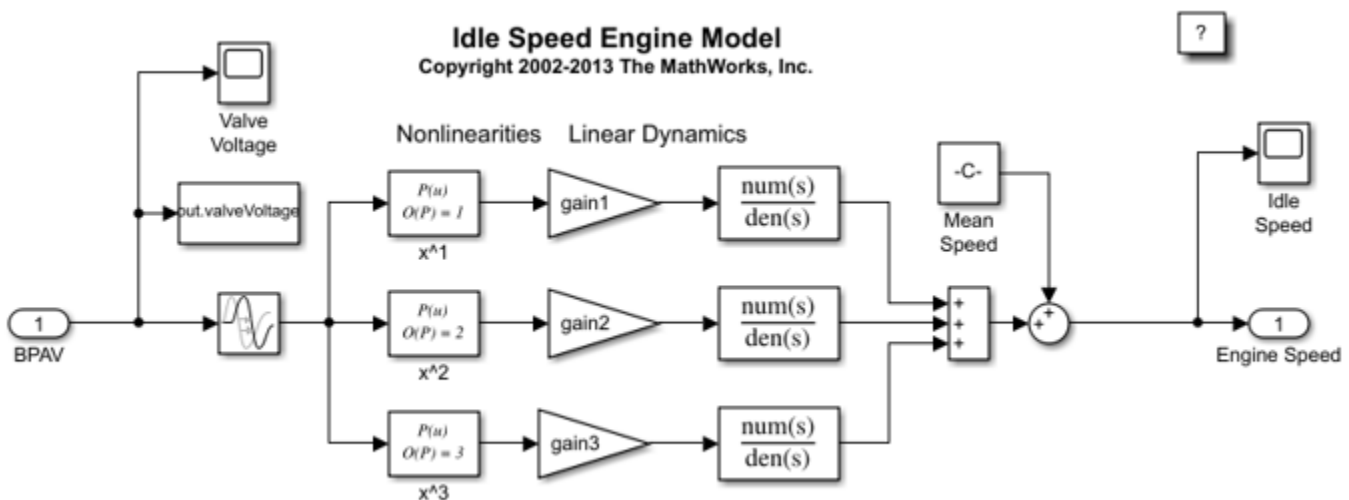

Step 2: Create Input Sets

Perturb the default input values vector to obtain a new input values vector.

```
inpSets(1) = timeseries(inpData, time);
rndPertb = 0.5 + rand(length(time), 1);
inpSets(2) = timeseries(inpData.*rndPertb, time);
numInpSets = length(inpSets);
```

Step 3: Create Parameter Sets

Next, examine how the idle speed changes for different values of parameters `gain2` and `gain3`. Create an array of `Simulink.SimulationInput` objects to specify the different parameter values and external input for each simulation. The array of `SimulationInput` objects is preallocated for better performance. Note that you can directly specify the external input on the `SimulationInput` object instead of using a model parameter.

```
gain2_vals = 25:10:35;
gain3_vals = 20:10:30;

num_gain2_vals = length(gain2_vals);
num_gain3_vals = length(gain3_vals);

numSims = num_gain2_vals*num_gain3_vals*numInpSets;
in(1:numSims) = Simulink.SimulationInput mdl);

idx = 1;
for iG2 = 1:num_gain2_vals
    for iG3 = 1:num_gain3_vals
        for inpSetsIdx = 1:numInpSets
            in(idx) = in(idx).setModelParameter('SimulationMode', 'rapid', ...
                'RapidAcceleratorUpToDateCheck', 'off', ...
                'SaveTime', 'on', ...
                'SaveOutput', 'on');
            % Use setVariable to specify a new value for a variable during
            % simulations
            in(idx) = in(idx).setVariable('gain2', gain2_vals(iG2));
            in(idx) = in(idx).setVariable('gain3', gain3_vals(iG3));
            in(idx).ExternalInput = inpSets(inpSetsIdx);
            idx = idx + 1;
        end
    end
end
```

Note: This example uses the `setModelParameter` method of the `SimulationInput` object to set model parameters to run the simulations in Rapid Accelerator mode and enable logging. The Rapid Accelerator target is built using the `SetupFcn`. The Rapid Accelerator target is built once and used by all subsequent simulations, saving the time required for model compilation. Here is the code for the `SetupFcn`

```
function sldemo_parallel_rapid_accel_sims_script_setup mdl)
    % Temporarily change the current folder on the workers to an empty
    % folder so that any existing slprj folder on the client does not
    % interfere in the build process.
    currentFolder = pwd;
    tempDir = tempname;
    mkdir(tempDir);
```



```

    cd (tempDir);
    oc = onCleanup(@() cd (currentFolder));
    Simulink.BlockDiagram.buildRapidAcceleratorTarget mdl;
end

```

Step 4: Execute Simulations

Use the `parsim` function to execute the simulations in parallel. The array of `SimulationInput` objects, `in`, created in the last step is passed into the `parsim` function as the first argument. Store the simulation output data in a variable, `out`, whose value is an array of `Simulink.SimulationOutput` objects. Each `SimulationOutput` object contains the logged signal along with the `SimulationMetadata`. When running multiple simulations using `parsim`, errors are captured so that subsequent simulations can continue to run. Any errors would show up in the `ErrorMessage` property of the `SimulationOutput` object.

```

out = parsim(in, 'ShowProgress', 'on', ...
    'SetupFcn', @() sldemo_parallel_rapid_accel_sims_script_setup mdl);

```

```

[21-May-2021 17:46:47] Checking for availability of parallel pool...
Starting parallel pool (parpool) using the 'local' profile ...
Connected to the parallel pool (number of workers: 6).
[21-May-2021 17:47:51] Starting Simulink on parallel workers...
Analyzing and transferring files to the workers ...done.
[21-May-2021 17:48:54] Configuring simulation cache folder on parallel workers...
[21-May-2021 17:48:55] Running SetupFcn on parallel workers...
[21-May-2021 17:50:14] Loading model on parallel workers...
[21-May-2021 17:50:22] Running simulations...
[21-May-2021 17:50:29] Completed 1 of 8 simulation runs
[21-May-2021 17:50:29] Completed 2 of 8 simulation runs
[21-May-2021 17:50:29] Completed 3 of 8 simulation runs
[21-May-2021 17:50:29] Completed 4 of 8 simulation runs
[21-May-2021 17:50:29] Completed 5 of 8 simulation runs
[21-May-2021 17:50:29] Completed 6 of 8 simulation runs
[21-May-2021 17:50:36] Completed 7 of 8 simulation runs
[21-May-2021 17:50:36] Completed 8 of 8 simulation runs
[21-May-2021 17:50:36] Cleaning up parallel workers...

```

Step 5: Plot Results

Plot the engine idle speed with respect to time for different parameter values and inputs. The output is logged in the array format and can be accessed from the `SimulationOutput` object.

```

for i = 1:numSims
    simOut = out(i);
    t = simOut.tout;
    y = simOut.yout;
    plot(t, y)
    hold all
end

```

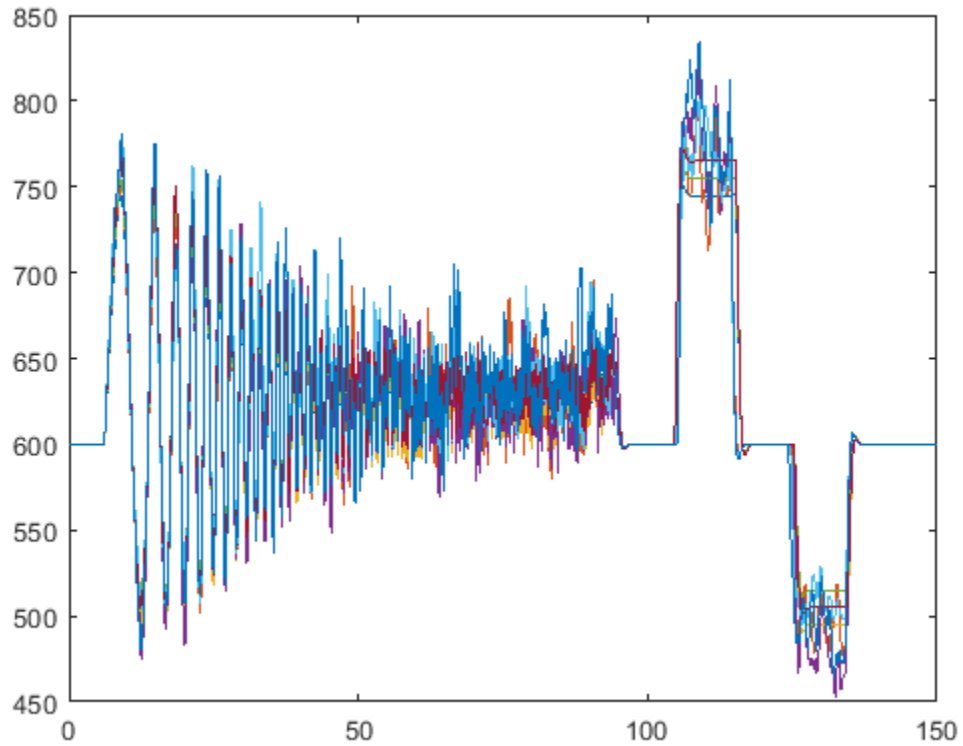
**Step 6: Close MATLAB Workers**

```
delete(gcf('nocreate'))
```

See Also

parsim

Related Examples

- “Acceleration”
- “Running Multiple Simulations”

Multiple Simulations Workflow Tips

The goal of this example is to provide helpful tips for running multiple simulations using parallel simulation tools. This example will work even if the Parallel Computing Toolbox™ is not available, but the simulations will run in serial. We will be using the model `sldemo_suspn_3dof`.

```
mdl = 'sldemo_suspn_3dof';
isModelOpen = bdIsLoaded(mdl);
open_system(mdl);
```

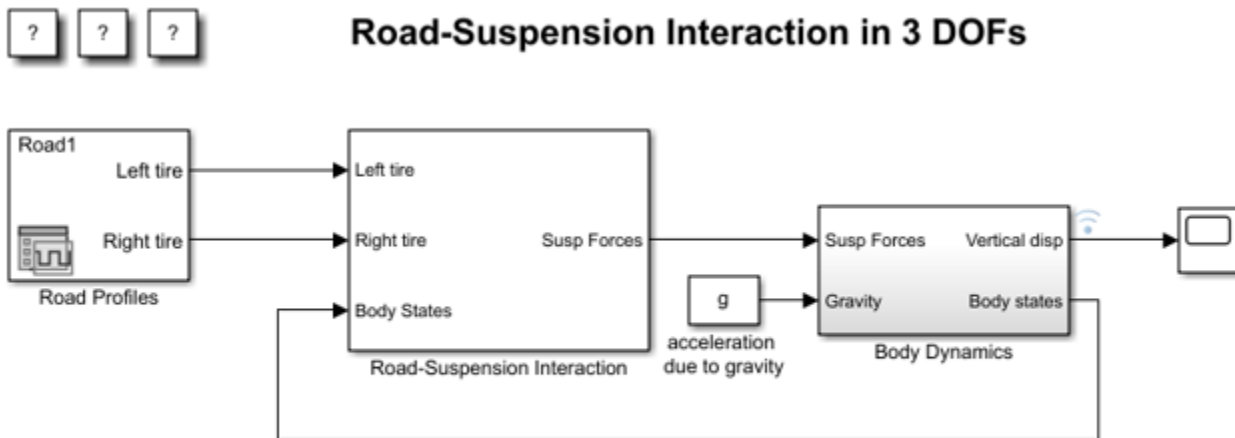

Copyright 2011-2018 The MathWorks, Inc.

Initializing an Array of Simulink.SimulationInput Objects

Typically you will construct an array of `Simulink.SimulationInput` objects in order to run multiple simulations. There are several ways to initialize the array before populating it with data.

```
numSims = 5;
Cf_sweep = Cf*linspace(.05,.95, numSims);
```

Method 1: Initialize the array before the loop

```
in(numSims) = Simulink.SimulationInput;
for idx = 1:numSims
    % Need to populate the model name since we get any empty array by default
    in(idx).ModelName = 'sldemo_suspn_3dof';
    in(idx) = in(idx).setVariable('Cf', Cf_sweep(idx));
end
```

Method 2: Initialize the array in the loop

Note that the loop variable `idx` starts from the largest value so that the entire array is pre-allocated.

```
for idx = numSims:-1:1
    % Since we are indexing from 5 to 1, the first iteration will
    % initialize the array.
    in(idx) = Simulink.SimulationInput('sldemo_suspn_3dof');
    in(idx) = in(idx).setVariable('Cf', Cf_sweep(idx));
end
```

Setting Model and Block Parameters

The `setModelParameter` and `setBlockParameter` methods use the same parameter-value pair syntax that the `set_param` API uses. This means that most values you pass in to these methods should be character arrays, not their literal value.

```
for idx = numSims:-1:1
    in(idx) = Simulink.SimulationInput('sldemo_suspn_3dof');

    % Incorrect
    in(idx) = in(idx).setModelParameter('StartTime', 5);

    % Correct
    in(idx) = in(idx).setModelParameter('StartTime', '3');
end
```

Setting Variables

The `setVariable` method expects that you will pass the literal value you want to assign to a variable. The idea is that this closely reflects the `assignin` syntax.

```
for idx = numSims:-1:1
    in(idx) = Simulink.SimulationInput('sldemo_suspn_3dof');

    % Incorrect, Cf is expected to be a double, not a character array
    in(idx) = in(idx).setVariable('Cf', '2500');

    % Correct, Cf is a scalar double
    in(idx) = in(idx).setVariable('Cf', 2500);
end
```

Diagnosing Runtime Errors

Assume that you've accidentally set up an array of `Simulink.SimulationInput` objects with an incorrect value.

```
Mb_sweep = linspace(0, 1500, numSims);
for idx = numSims:-1:1
    in(idx) = Simulink.SimulationInput('sldemo_suspn_3dof');

    % Accidentally set the Mass to 0 on the first iteration
    in(idx) = in(idx).setVariable('Mb', Mb_sweep(idx));

    % Shorten the stop time
    in(idx) = in(idx).setModelParameter('StopTime', '1');
end
```

Simulating these will cause a runtime error

```
out = sim(in);
```

```
[23-Feb-2021 21:52:51] Running simulations...
[23-Feb-2021 21:53:01] Completed 1 of 5 simulation runs. Run 1 has errors.
[23-Feb-2021 21:53:01] Completed 2 of 5 simulation runs
[23-Feb-2021 21:53:01] Completed 3 of 5 simulation runs
[23-Feb-2021 21:53:02] Completed 4 of 5 simulation runs
[23-Feb-2021 21:53:09] Completed 5 of 5 simulation runs
Warning: Simulation(s) with indices listed below completed with
```

errors. Please inspect the corresponding SimulationOutput to get more details about the error:

```
[1]
```

Fortunately, you can inspect the Simulink.SimulationOutput object to see any error messages that come from a simulation.

```
out(1).ErrorMessage
```

```
ans =
```

```
'Derivative of state '1' in block '<a href="matlab:open_and_hilite_hyperlink ('sldemo_suspn_3dof'
```

This works to debug issues on parallel workers too.

```
for idx = numSims:-1:1
    in(idx) = Simulink.SimulationInput('sldemo_suspn_3dof');

    % Accidentally set the Mass to 0 on the first iteration
    in(idx) = in(idx).setVariable('Mb', Mb_sweep(idx));

    % Shorten the stop time
    in(idx) = in(idx).setModelParameter('StopTime', '1');
end
```

```
out = parsim(in);
```

```
[23-Feb-2021 21:53:09] Checking for availability of parallel pool...
Starting parallel pool (parpool) using the 'local' profile ...
Connected to the parallel pool (number of workers: 6).
[23-Feb-2021 21:53:53] Starting Simulink on parallel workers...
[23-Feb-2021 21:54:30] Configuring simulation cache folder on parallel workers...
[23-Feb-2021 21:54:32] Loading model on parallel workers...
[23-Feb-2021 21:54:38] Running simulations...
[23-Feb-2021 21:54:48] Completed 1 of 5 simulation runs. Run 1 has errors.
[23-Feb-2021 21:54:48] Completed 2 of 5 simulation runs
[23-Feb-2021 21:54:48] Completed 3 of 5 simulation runs
[23-Feb-2021 21:54:48] Completed 4 of 5 simulation runs
[23-Feb-2021 21:54:48] Completed 5 of 5 simulation runs
Warning: Simulation(s) with indices listed below completed with
errors. Please inspect the corresponding SimulationOutput to
get more details about the error:
[1]
[23-Feb-2021 21:54:48] Cleaning up parallel workers...
```

Inspecting the Simulink.SimulationOutput reveals a non-finite derivative error.

```
out(1).ErrorMessage
```

```
ans =
```

```
'Derivative of state '1' in block 'sldemo_suspn_3dof/Body Dynamics/Vertical (Z) dynamics/Zdof'
```

The applyToModel method will configure your model with the settings on the SimulationInput so you can debug the problem locally.

```
in(1).applyToModel;
```

Notice that the value of the variable **Mb** in the base workspace changes to 0 to reflect the value that was used in the simulation corresponding to the first `SimulationInput` object in `in`.

Close MATLAB Workers

Last, close the parallel pool and the model if they were not previously opened.

```
if(~isModelOpen)
    close_system mdl, 0);
end
delete(gcf('nocreate'));
```

See Also

`parsim` | `Simulink.SimulationInput`

Related Examples

- “Parallel Simulations Using Parsim: Parameter Sweep in Normal Mode” on page 13-599
- “Parallel Simulations Using Parsim: Parameter Sweep in Rapid Accelerator Mode” on page 13-603
- “Parallel Simulations Using Parsim: Test-Case Sweep” on page 13-595

Streamline Simulink Blockset Authoring Process with Blockset Designer

This example shows how to manage artifacts associated with a Simulink blockset with a single Blockset Designer Project.

Introduction

Simulink Blockset Designer is a Project™ based environment to author a Simulink blockset. It provides a one-stop shop for the development and maintenance of Simulink blockset artifacts such as source code, TLC-files, build scripts, test suites, libraries, models, and documentations. This example demonstrates how to streamline such a Simulink blockset project.

Try the Example

Run `slexBlocksetDesignerExample` to open the Simulink Blockset Designer project. Then click the 'Run All' button in toolstrip to start.

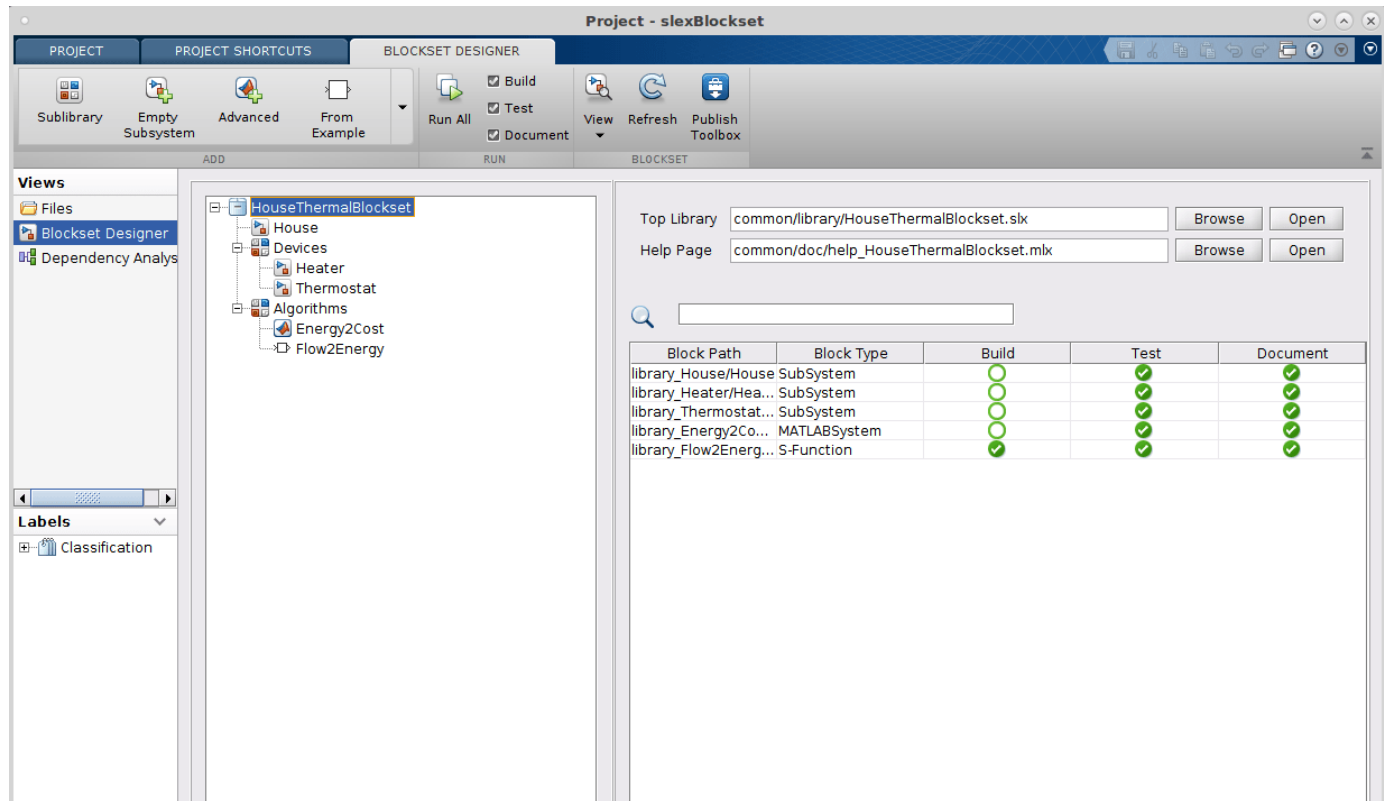

See Also

S-Function Builder

Importing a Co-Simulation FMU into Simulink

This model shows how to use the FMU Import block to load an FMU file. The FMU file supports execution in co-simulation mode. Simulink supports stepping back and forth, tuning parameters in between, and saving states for the FMU Import block as long as the FMU itself supports these features.

Importing a Co-Simulation FMU into Simulink

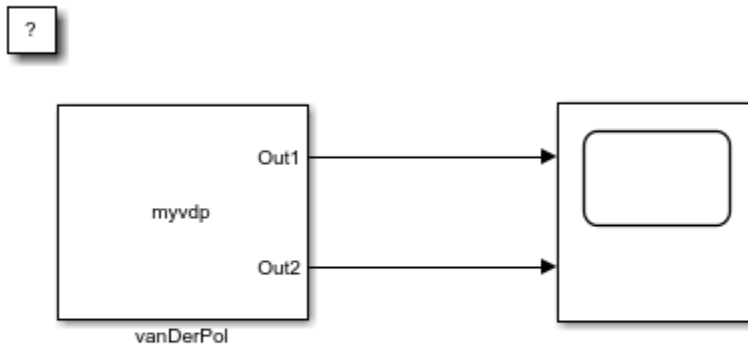

Copyright 2017 The MathWorks, Inc.

See Also

FMU

Related Examples

- “Import FMUs”
- “Implement an FMU Block”

Importing a Model Exchange FMU into Simulink

This model shows how to use the FMU Import block to load an FMU file. The FMU file supports execution in Model Exchange mode.

Bouncing Ball System

This FMU file models a bouncing ball system, which is an example of a hybrid dynamic system. The FMU file supports FMI 2.0 Model Exchange mode. You can change acceleration due to gravity and coefficient of restitution in the FMU block dialog. You can also tune parameters during simulation.

Importing a Model Exchange FMU into Simulink

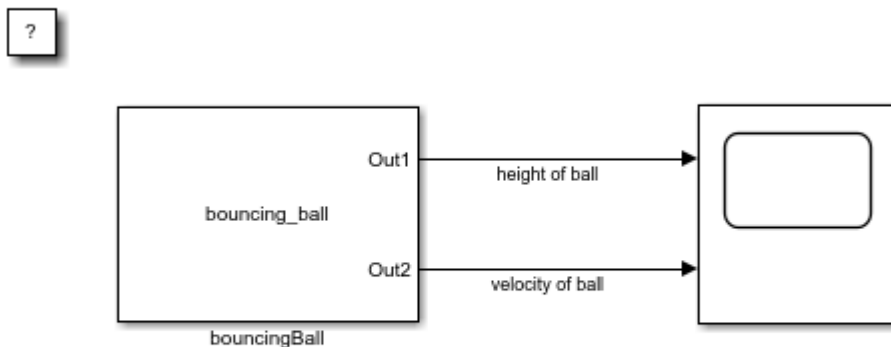

Copyright 2017 The MathWorks, Inc.

See Also

FMU

Related Examples

- "Import FMUs"
- "Implement an FMU Block"

Simplify Interface for Structured Data with FMU Import Block

This examples shows how to use the FMU block to simplify the Simulink interface for structured data. The FMU block imports existing functional mockup units (FMUs) into Simulink®.

This FMU file models a simple system that computes the weighted average of two input bus signals, `vehicle`, packed into an array of buses. Each of the input bus signals contains four bus elements, `wheel`. Each bus element contains two scalar signals, `position` and `speed`. The FMU accepts two structure parameters, `Weight` and `Bias`, and uses them to compute the weighted average ev of input signals:

```
ev.wheel(i).position = vehicle(1).wheel(i).position * Weight.v1 + Bias.v1 +
vehicle(2).wheel(i).position * Weight.v2 + Bias.v2
```

```
ev.wheel(i).speed = vehicle(1).wheel(i).speed * Weight.v1 + Bias.v1 +
vehicle(2).wheel(i).speed * Weight.v2 + Bias.v2
```

where

$i = 1 \dots 4$.

The FMU file supports FMI 1.0 Model Exchange mode.

The FMU Import block supports non-virtual bus types. You must create a bus object whose structure matches the associated structure in the FMU file. When naming the bus object structures, use the variable names defined in the `modelDescription.xml` of the FMU file.

Using Bus Signals and Structure Parameters in the FMU Import Block

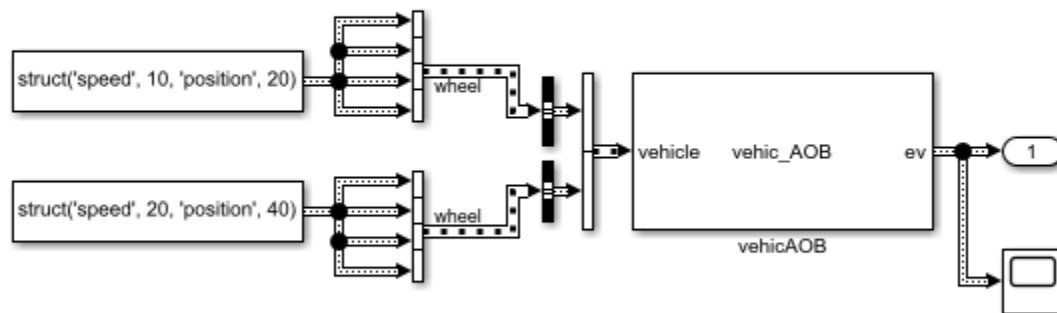

Copyright 2017 The MathWorks, Inc.

See Also

`fmudialog.createBusType` | FMU

Related Examples

- “Import FMUs”
- “Implement an FMU Block”

Co-Simulation Signal Compensation

This example shows how to use co-simulation and signal compensation for interfacing signals.

In co-simulation, components have their own local solver. During simulation, local solvers maintain their own time by integrating from the previous step to the current step using the data exchanged between components at the previous step.

Simulink serves as an integration platform and performs data exchange between the components. The components do not expose their internal states. Simulink treats the components as discrete blocks that exchange data at discrete time intervals.

Connecting these co-simulation components does not form an algebraic loop. Instead, it introduces one-step delay during data exchange. This one-step delay can cause simulation to be less accurate or unstable.

To mitigate this issue, Simulink automatically identifies interfacing signals between these components. These signals are ideally continuous quantities that must be sampled due to co-simulation. To achieve better co-simulation stability and accuracy, Simulink performs numerical compensation on these signals. A 'gear' icon displays on the affected component to indicate this.

Triple Mass-Spring System

This example shows how to perform numerical compensation for three standalone mass-spring components (two implemented in C-MEX S-Function, one implemented using FMU Co-Simulation v2.0). These components are connected to form a triple mass-spring system. When you update the block diagram, the numerical compensation icons appear at the input ports.

The monolithic subsystem uses Simulink continuous blocks and is solved using a Simulink solver. It represents a pure form of the triple mass-spring system. Simulating the monolithic subsystem results in the most accurate output. Experiment toggling the numerical compensation behavior of the co-simulation components and compare the output of the co-simulation components with the monolithic subsystem output.

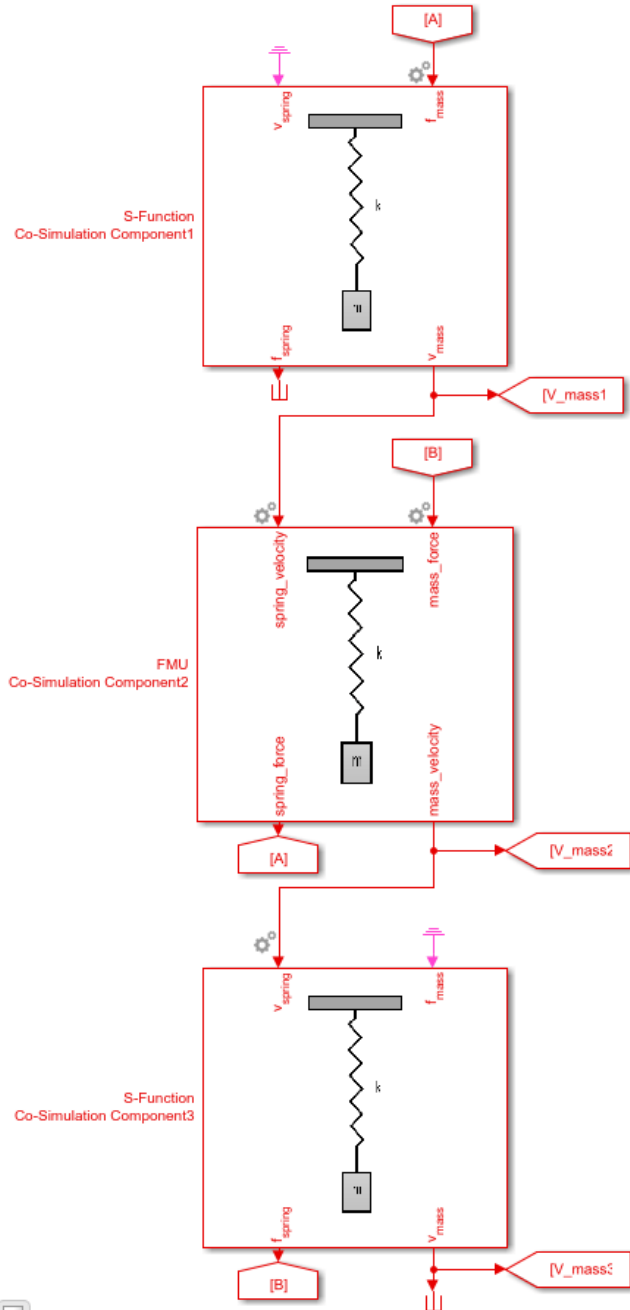

Co-Simulation Signal Compensation

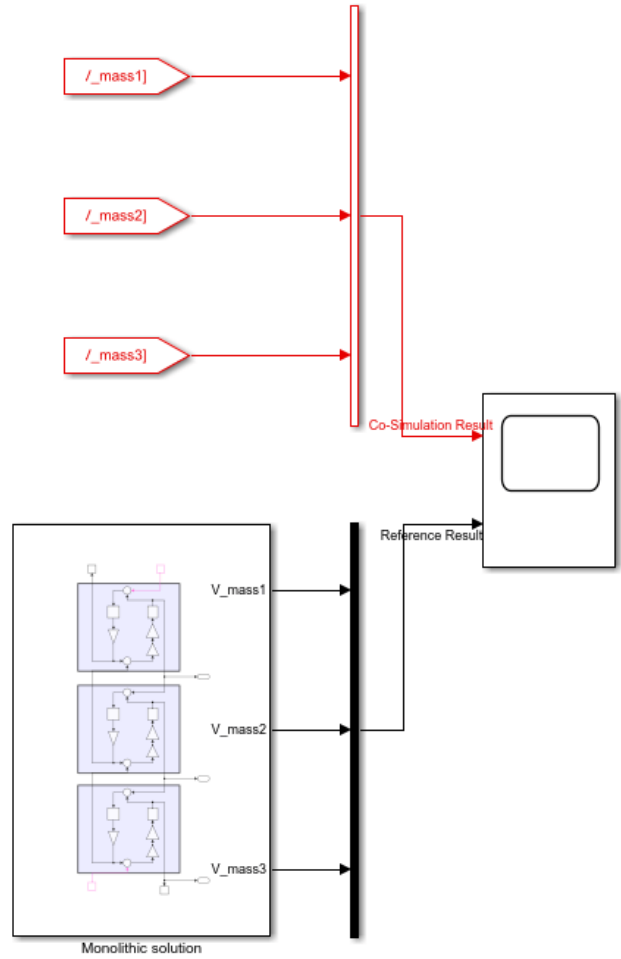

Copyright 2017 The MathWorks, Inc.

See Also

FMU

Related Examples

- “Co-Simulation Execution and Numerical Compensation”
- “Run Co-Simulation Components on Multiple Cores”

Multithread Co-Simulation

This example shows how to run co-simulation on multiple threads.

Simulink is an integration platform that supports co-simulation between components with local solvers or that involves simulation tools. For example, co-simulation can involve an S-function as a co-simulation gateway between Simulink and third-party tools or custom code. It can also involve an FMU in co-simulation mode imported to Simulink.

By default, Simulink configures all models to run on multiple threads with the `MultiThreadCoSim` parameter.

This example shows how to run multithreaded co-simulation of three components (two implemented in C-MEX S-Function, one implemented using FMU Co-Simulation v2.0). These components compute prime numbers to find the maximum prime number that is smaller than or equal to the given input.

Multithreaded co-simulation best suits models with computationally intensive and loosely coupled components. In this example, each component computes prime numbers using a brute-force search. The intensity of the computation is directly proportional to the given range, which is a block input that you can experiment with. Also, components exchange a scalar signal, which is the maximum prime number within the given range, at communication times.

Experiment toggling the `MultithreadedSim` parameter and measuring the wall clock time.

```
open_system('slexCoSimPrimeExample')
sim('slexCoSimPrimeExample');
```

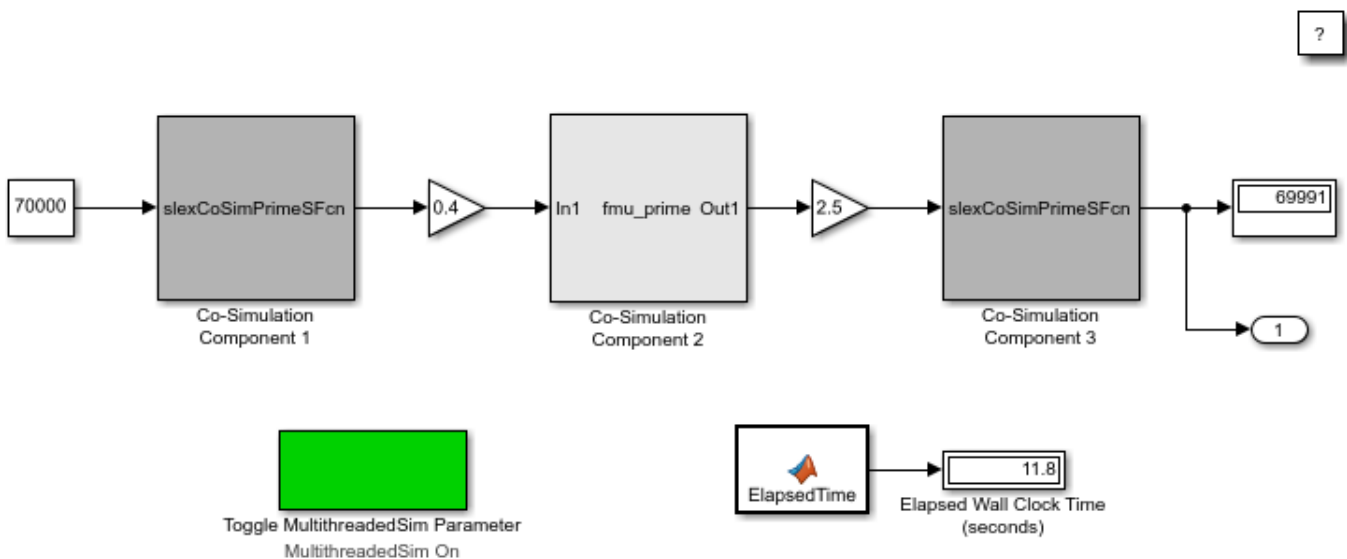

Copyright 2017 The MathWorks, Inc.

See Also

FMU

Related Examples

- “Co-Simulation Execution and Numerical Compensation”
- “Run Co-Simulation Components on Multiple Cores”

Pulse Width Modulation Using MATLAB System Block

This example shows how to use MATLAB System block to generate Pulse Width Modulation (PWM) signals based on the input period and duty cycle signals by using controllable sample time and `setNumTicksUntilNextHit`.

In this example, MATLAB System block registers a controllable sample time so that it can schedule the next hit while changing the output value. In this example, the MATLAB System block has two input ports and one output port. The first input port is the duty cycle signal and the second input port is the period signal. The MATLAB System block has two block parameters: the amplitude of the generated PWM signal and the resolution of the controllable sample time.

In this example, the MATLAB System block demonstrates the use of the function: `* createSampleTime(obj, 'Type', 'Controllable', 'TickTime', obj.Resolution)` to register a controllable sample time in `getSampleTimeImpl` method. The resolution must be a positive finite integer that defines the fundamental step size that the MATLAB System block can schedule the next hit for this sample time.

MATLAB System Block demonstrates the use of the method: `* setNumTicksUntilNextHit(obj, numTicks)` to schedule the next hit of the controllable sample time. The next hit happens after $t = t_{\text{current}} + \text{numTicks} * \text{resolution}$. `numTicks` must be a positive integer. The MATLAB System block can use this method to schedule the execution of the controllable sample time in `setupImpl` and `stepImpl`.

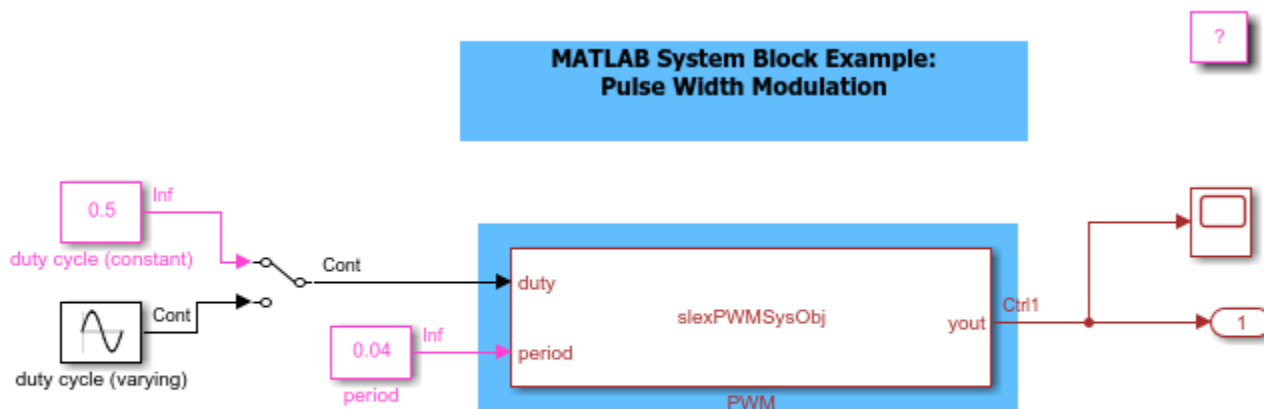

Copyright 2017 The MathWorks, Inc.

Modeling Cyber-Physical Systems

Cyber-physical systems combine computer and physical systems to achieve design goals. Simulation of cyber-physical systems requires a combination of modeling techniques such as continuous-time, discrete-time, discrete-event, and finite state modeling. Simulink® and its companion products provide functionality to apply a wide range of modeling techniques and seamlessly integrate them in one simulation environment, which is ideal for modeling cyber-physical systems.

This example shows how continuous-time, discrete-event, and finite-state modeling techniques combine to simulate the behavior of a variable speed conveyor belt system. In SimEvents®, entities are discrete items of interest in a discrete-event simulation. Because passengers are discrete individuals, they are modeled by SimEvents® entities, created by the Entity Generator block. A Stateflow® chart models the operational modes and motor dynamics of the variable speed conveyor belt. Finally, the Entity Transport Delay block models passenger throughput as a function of conveyor belt dynamics, providing a bridge between the discrete-event and continuous-time domains.

Note: The example uses blocks from SimEvents® and Stateflow®. If you do not have a SimEvents or Stateflow license, you can open and simulate the model but only make basic changes such as modifying block parameters.

Model Structure

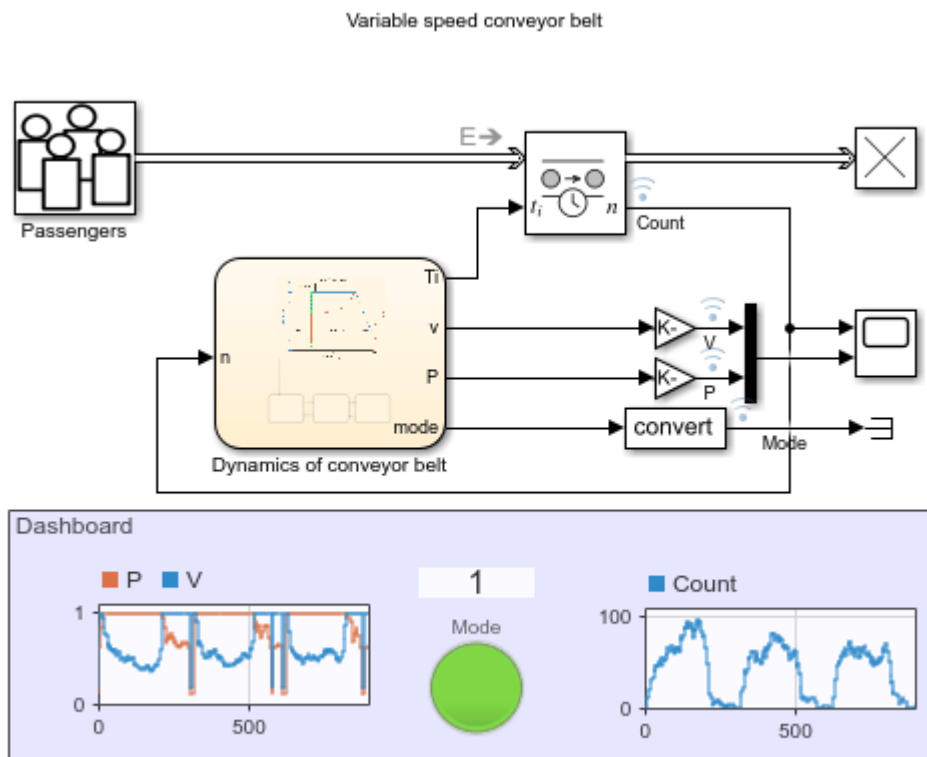

The model includes these key components:

- **Passengers** — Models the arrival of passengers as a Poisson process. The output is a sequence of SimEvents® entities corresponding to the passengers who step on the conveyor belt. The

distribution of inter-arrival time (Δt) of a Poisson process is $P(\Delta t) = \lambda e^{-\lambda \Delta t}$, where λ is the arrival rate. λ is modeled by a MATLAB action in the Entity Generator block for *rush hour*, *normal hour*, and *free hour*. The passenger arrival rate changes with time as:

$$\lambda(t) = \begin{cases} 2, & \text{mod}(t, 300) \in [0, 180), \quad \text{rush hour} \\ 0.5, & \text{mod}(t, 300) \in [180, 240), \quad \text{normal hour} \\ 0.1, & \text{mod}(t, 300) \in [240, 300), \quad \text{free hour} \end{cases}$$

- **Entity Transport Delay** — Holds the passengers on the conveyor belt until they arrive at the other terminal, based on the time delay calculated by the Stateflow chart.
- **Dynamics of conveyor belt** — Models the operation of a variable speed conveyor belt. See the Conveyor Belt Dynamics section for more details.
- **Dashboard** — Shows the runtime status of the conveyor belt. The color of the Mode Lamp indicates the mode of the conveyor belt.

Conveyor Belt Dynamics

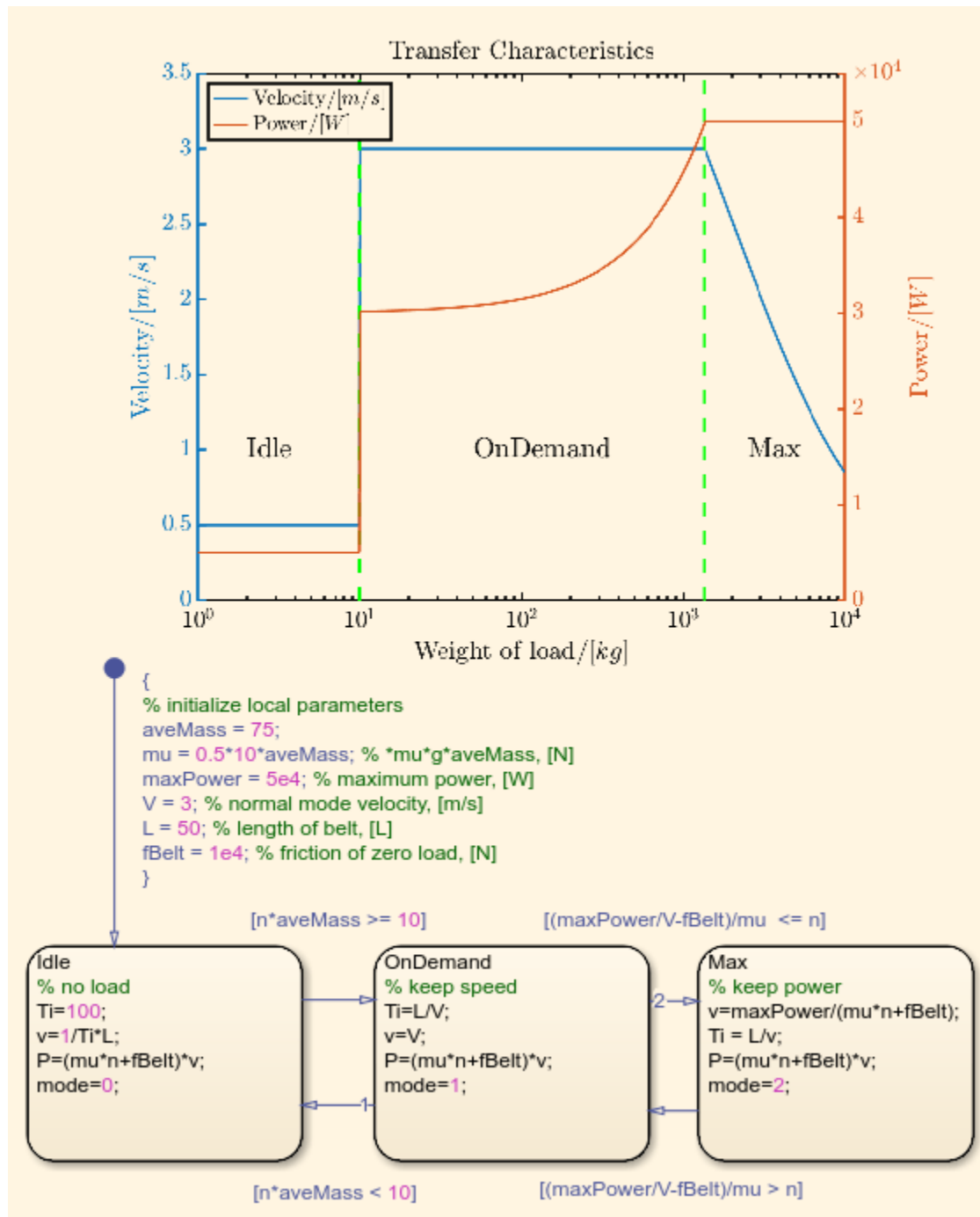

A Stateflow® chart models the dynamics of the variable speed conveyor belt. Note in the chart that the velocity and power of the belt are plotted against a logarithmic scale of the load weight. The conveyor belt has these modes:

- **Idle** — The weight of the load is small. The belt maintains a low velocity to save energy. The Mode Lamp is gray in this mode.

- **OnDemand** — This is the normal operating mode, which maintains the optimal velocity for passenger comfort and throughput. The power will proportionally increase with the weight of the load. The Mode Lamp is green in this mode.
- **Max** — Maximum power mode. The weight of the load is too large for the conveyor belt to maintain the optimal velocity. The conveyor belt operates at the maximum possible velocity that does not exceed the maximum power. The Mode Lamp is red in this mode.

Results

The Scope and blocks in the DashBoard show the simulation results.

Simulation results: 1. Number of passengers versus simulation time. 2. Velocity (blue) and power (red) versus simulation time.

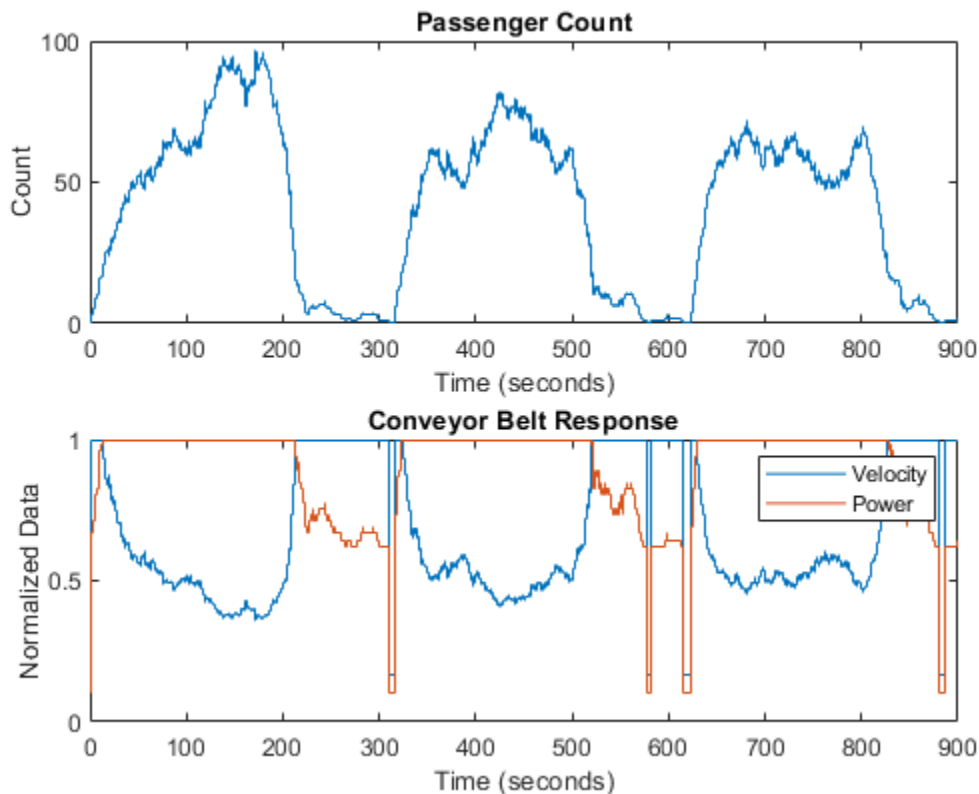

Three operation cycles are observed within a time span of 900. Each cycle has a period of 300, which aligns with the period of the arrival rate. The top plot shows the number of passengers on the conveyor belt over time, and the bottom plot shows the velocity and power of the conveyor belt. The velocity and power are normalized for better visualization.

The first two thirds of each period correspond to *rush hour*, and the number of passengers on the conveyor belt increases dramatically. Consequently, the conveyor belt enters into the **Max** mode quickly, which is characterized by the maximum output power with a velocity that is inversely proportional to the number of passengers. In the last third of each period, the airport is in the *normal hour* followed by the *free hour*. Therefore, the number of passengers on the conveyor belt drops and even becomes zero for some time.

The conveyor belt then operates in **OnDemand** and **Idle** modes accordingly. In **OnDemand** mode, the velocity is locked to a default value, and the power is proportional to the number of passengers. In **Idle** mode, both the velocity and power are maintained at low values to reduce energy consumption. Overall, the conveyor belt operates according to the load of the airport.

Schedule an Export-Function Model Using the Schedule Editor

This example shows how to view and edit the order of function-calls in an export-function model using the Schedule Editor. As in all export-function models, the desired functionality is modeled as function-call subsystems. These function-call subsystems define the partitions that are scheduled by the Schedule Editor.

With the Schedule Editor, you can easily view and edit the schedule of the function-calls. The behavior of the system depends on the order of these partitions. In this example, we change the order and observe its effects on the behavior of the system by simulating the model. To see the impact of editing the schedule on the simulation, we compare the model simulations before and after scheduling.

Create Partitions from Referenced Export-Function Model

To view and edit the schedule of the export-function model, reference the model.

```
open_system('ThrottlePositionControlTop.slx');
```

Schedule an Export-Function Model with the Schedule Editor

Copyright 2018 The MathWorks, Inc.

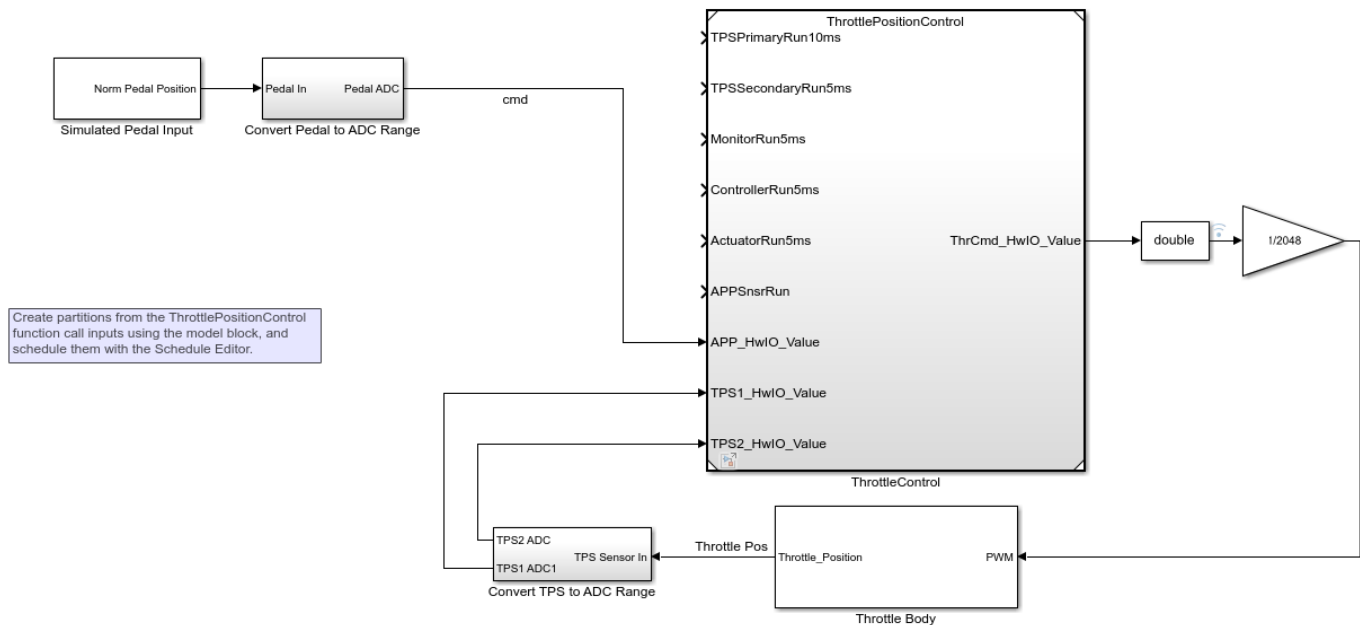

ThrottlePositionControl is the referenced export-function model. By default, each function has an input port that can be used to trigger these functions. The Schedule Editor automatically handles these ports. To use the Schedule Editor, set the Schedule Rates With parameter to Schedule Editor.

```
set_param('ThrottlePositionControlTop/ThrottleControl', 'ScheduleRatesWith', 'Schedule Editor');
```

Establish a Simulation Baseline

To observe the impact of scheduling on the model behavior, establish a baseline by simulating the model before editing the schedule. Simulate the model.

```
sim('ThrottlePositionControlTop');
```

Open the Schedule Editor

To open the Schedule Editor, click **Schedule Editor** in the **Design** section of the **Modeling** tab. In the Schedule Editor, different components of the model are represented as partitions. Update the diagram to see the partitions. Partitions are the entry-points in the model. The Schedule Editor shows the order and data communications of these partitions. The arrows are data connections between the partitions that show the data flow. The dashed lines indicate that there is a delay because the source runs after the destination. The solid lines indicate that there is no delay as the source runs before the destination.

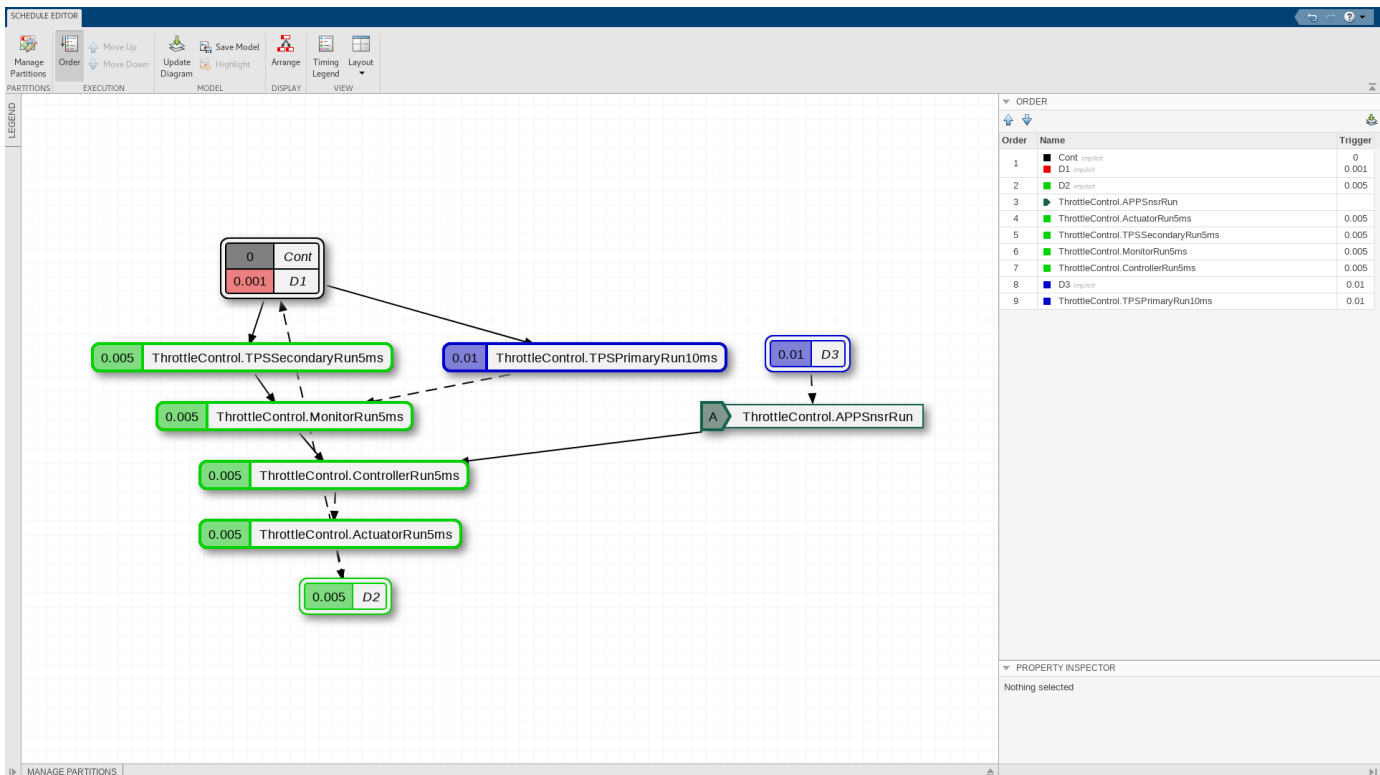

Edit Partition Schedule

The Order pane shows the order the partitions run in at a given time step. Assume that the order of the partitions is in an imperfect state. In this case, to remove the delay, you want to run the `ThrottleControl.ActuatorRun5ms` partition after the `ThrottleControl.ControllerRun5ms` partition.

Drag `ThrottleControl.ActuatorRun5ms` after the `ThrottleControl.ControllerRun5ms` in the Order pane. Observe that the delay between the `ThrottleControl.ControllerRun5ms` and the `ThrottleControl.ActuatorRun5ms` partitions changes to a dependency. Observe that now there is no delay between the executions of `ThrottleControl.ControllerRun5ms` and `ThrottleControl.ActuatorRun5ms`.

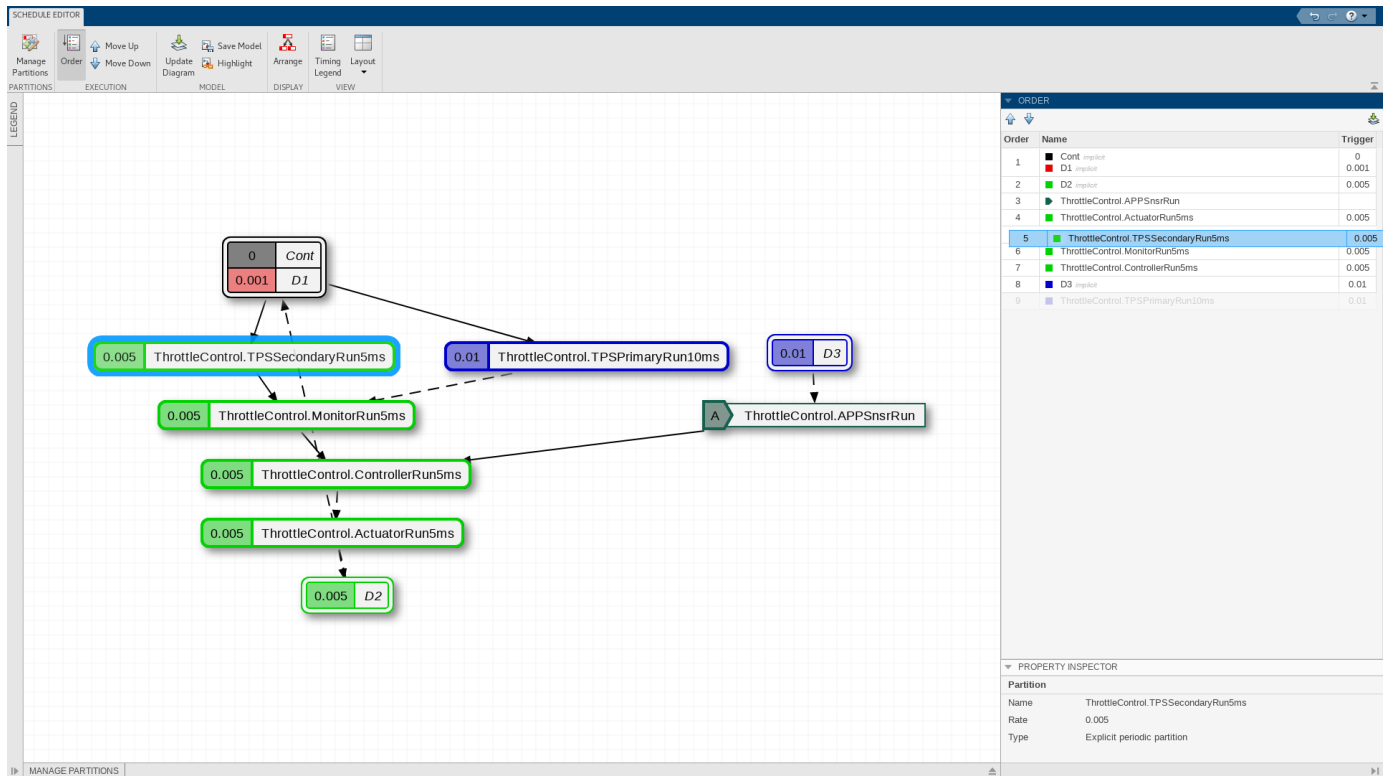

Schedule the Execution of Aperiodic Partitions

The export-function model contains an unconstrained partition, AccelerationPedalPositionSensor. Suppose you want to schedule an unconstrained partition to simulate as if it were discrete. Schedule ThrottleControl.APPSnrRun partition to run at [0:0.02:100] to observe its behavior at different instances of time. Click the unconstrained partition and enter [(1:5000)*.02] for Hit Times in the Property Inspector.

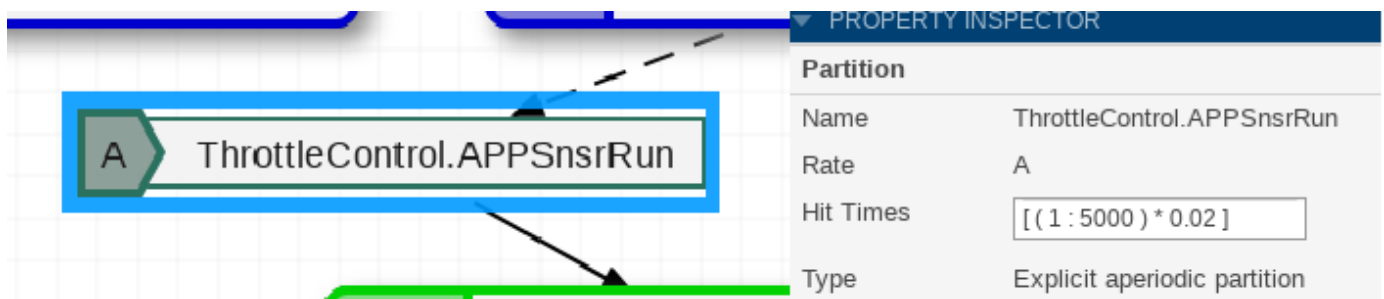

Compare the Runs in Simulation Data Inspector

Now, simulate the model with the changed schedule.

Open the Simulation Data Inspector. Select the two runs and compare. You can see how changing the schedule impacts the model behavior.

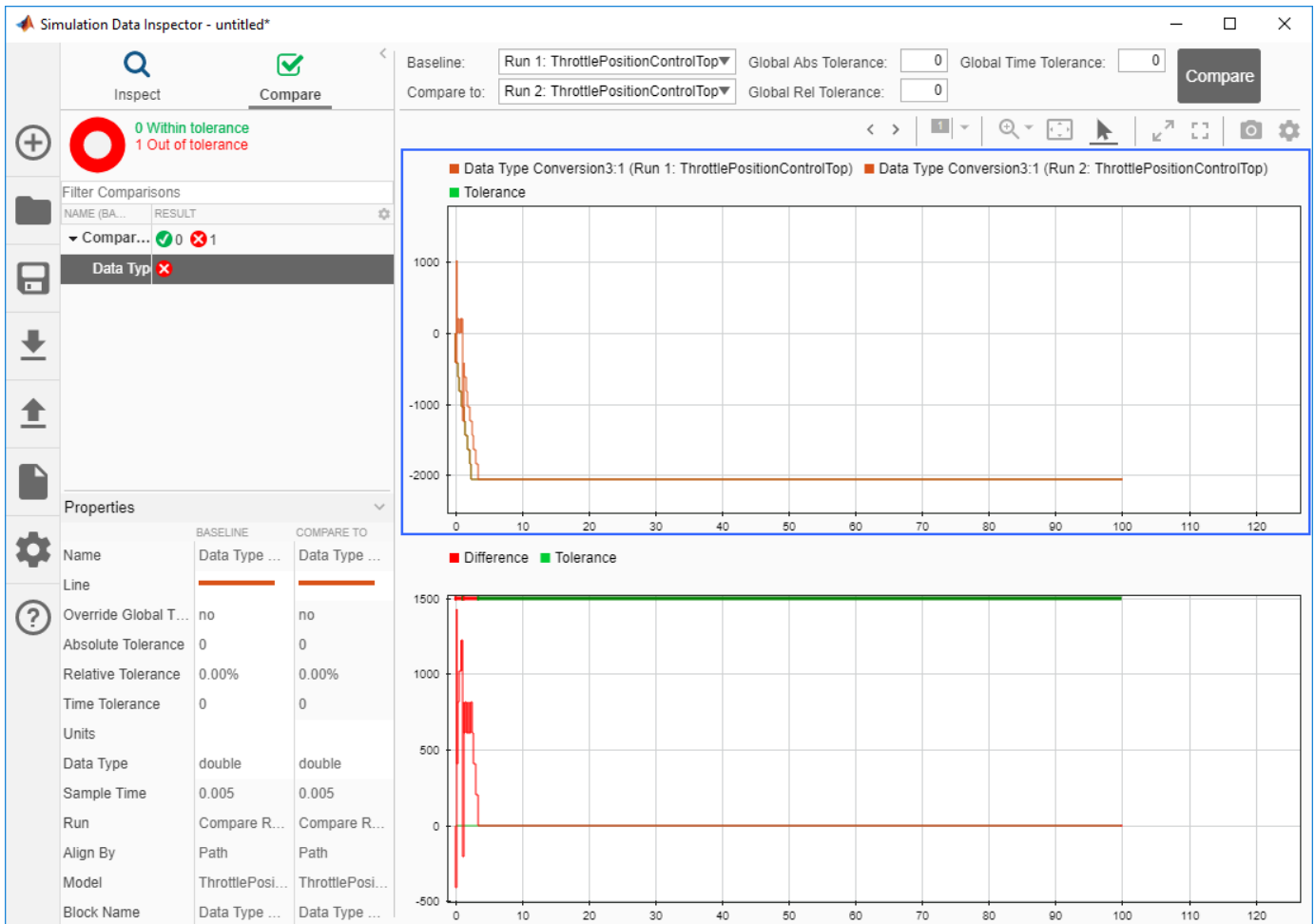

Copyright 2018-2019 The MathWorks, Inc.

Promote Block Parameters on a Mask

You can use Parameter Promotion to promote any underlying parameter of a block either to a block mask or to a subsystem mask. This model contains a subsystem that has 3 Gain blocks (**Gain1**, **Gain2**, and ***Gain3**). The variable K represents the Gain parameter for these Gain blocks. You can promote only the Gain parameter of each of these Gain blocks to the block mask as a single parameter. When you do so, the parameter K is available on the mask for editing and its value will be applied to **Gain1** , **Gain2** , and **Gain3** blocks.



- 1 Select the Subsystem block.
- 2 On the **Subsystem Block** tab, in the **Mask** group, click **Create Mask/Edit Mask**.
- 3 In the Mask Editor dialog box, click the **Parameters & Dialog** tab.
- 4 In the **Controls** pane, click **Promote** .
- 5 In the **Property editor** pane, **Type options** field, click
- 6 In the **Promoted Parameter Selector** dialog box, select **Gain1** .
- 7 Select **Gain** from the **Promotable parameters** table and click the Add to promoted parameter list button. Similarly, add Gain parameter for **Gain2**.
- 8 Click **OK** .
- 9 In the Mask Editor dialog box, edit the prompt names for the **Gain** parameter. Here the Prompt used is **Common gain** .
- 10 Click **OK** to finish creating subsystem mask with many-to-one promotion.
- 11 Simulate the model. Notice that the value 4 is passed from the mask to the underlying block **Gain1**, **Gain2** , and **Gain3** . In this case, the output shows 64.

Graph-Based Multithread Simulation

This example shows how graph-based algorithms optimize simulation on multiple threads.

Graph-based algorithm

This example contains four nondirect feedthrough blocks followed by four direct feedthrough blocks. Direct feedthrough means that the output port signal of a block is computed from the values of its input port signals in the same time step. The graph-based algorithm runs the four nondirect feedthrough blocks in parallel and groups the following direct feedthrough blocks into the same branch. Then, the model uses multithreading to run those four branches. Thus, the algorithm speeds up the simulation almost four times on a four or more core machine compared to a single-threaded simulation on the same machine.

Open model and simulate

```
open_system('slexGraphBasedMultiThreadSimExample');  
  
% Press "Toggle MultithreadedSim Parameter" block to turn off / on  
% multithreaded simulation and compare the elapsed time.
```

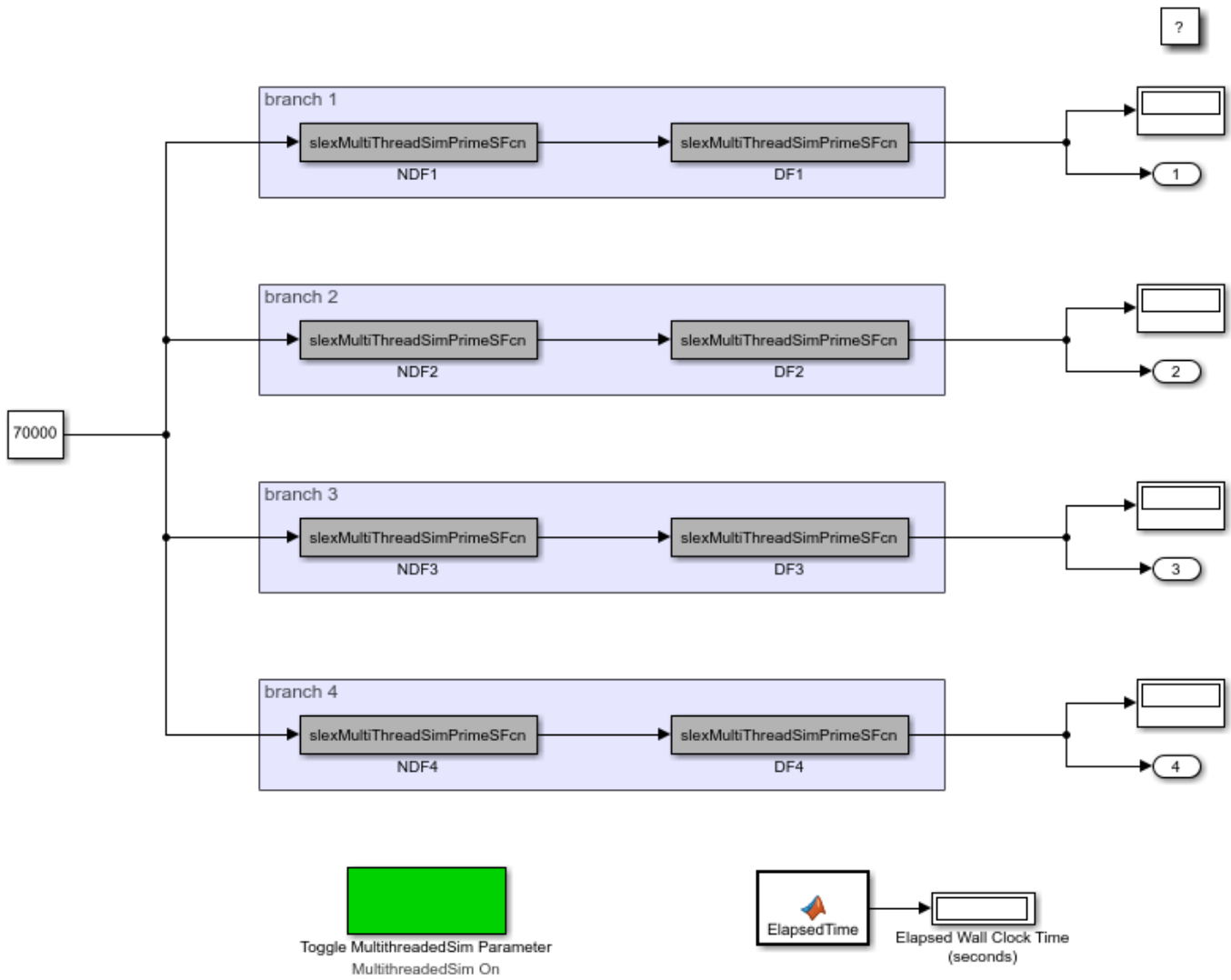

Graph-based multithreaded simulation enables DirectFeedThrough blocks to run in parallel.

Copyright 2020
The MathWorks, Inc.

Exit

```
bdclose all;
```

Find Shortest Control Path in Simulink Model

Model Description

This example shows how to find the shortest control path for a hybrid electrical vehicle using Signal Tracing Command-line API.

To open the model, enter this command in the example folder.

```
open_system('sldemo_hevc')
```

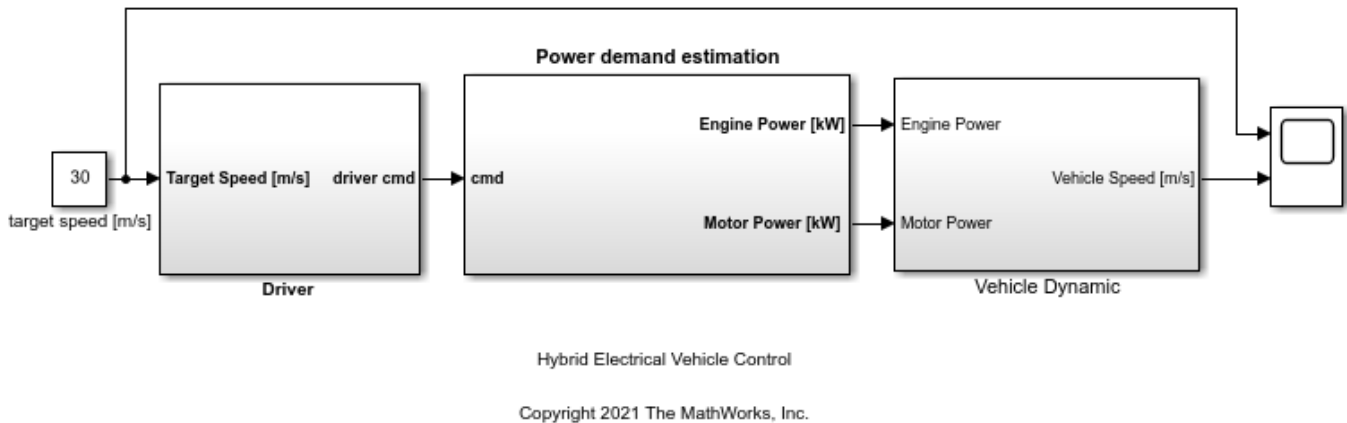

In this model, a hybrid electrical vehicle drives on a slope and the initial speed is 0 m/s. Set the target speed to 30 m/s. In **Driver**, a PID control compares the actual speed with the target speed and sends a command to increase or decrease speed to the power demand estimation module. **Power demand estimation** converts to the desired power, and the power is primarily provided by the electrical motor. If electrical motor is unable to provide enough torque, then the engine and provides additional torque. In **Vehicle Dynamic**, road resistance including rolling resistance and gravity resistance as well as the aero drag are calculated. The actual speed of the vehicle is constantly returned to **Driver** through the feedback loop until the vehicle reaches the target speed.

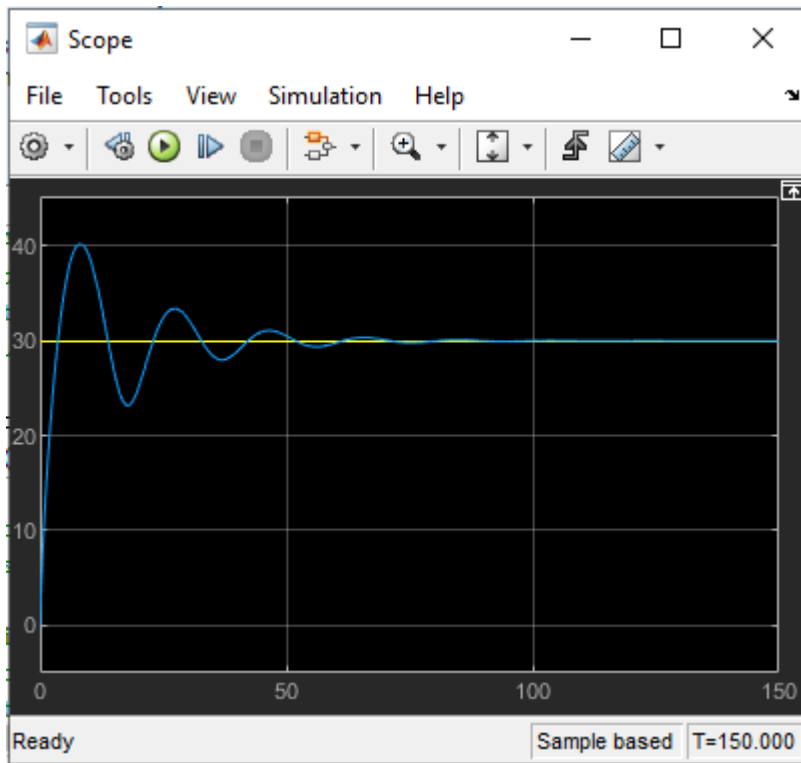

Trace All Sources that Control the Actual Speed

Use the signal tracing API to find the shortest control path to the actual speed. Since the actual speed signal goes into the second input of Scope, use Scope as the tracing origin.

```
g = sltrace('sldemo_hevc/Scope', 'source', 'port', '2', 'traceall', 'on');
highlight(g);
```

Obtain the Trace Graph

The tracing results can be expressed as a MATLAB digraph. The trace graph includes edges and nodes.

A node in trace graph corresponds to a block port in a Simulink® model. The second port of Scope is a node. You can find the node information nodes table.

```
nodes = g.TraceGraph.Nodes;
```

The edges are shown as pair of node indexes in trace graph. You can access the node information from the nodes table with the corresponding node index. The Simulink® line between nodes is shown as segment handle(s).

```
edges = g.TraceGraph.Edges;
```

Compute the edges of the trace graph of the `sltrace.Graph` object and use built-in MATLAB® digraph features to plot the trace graph, as shown in the figure.

```
fig = g.TraceGraph.plot('Layout', 'force');
```

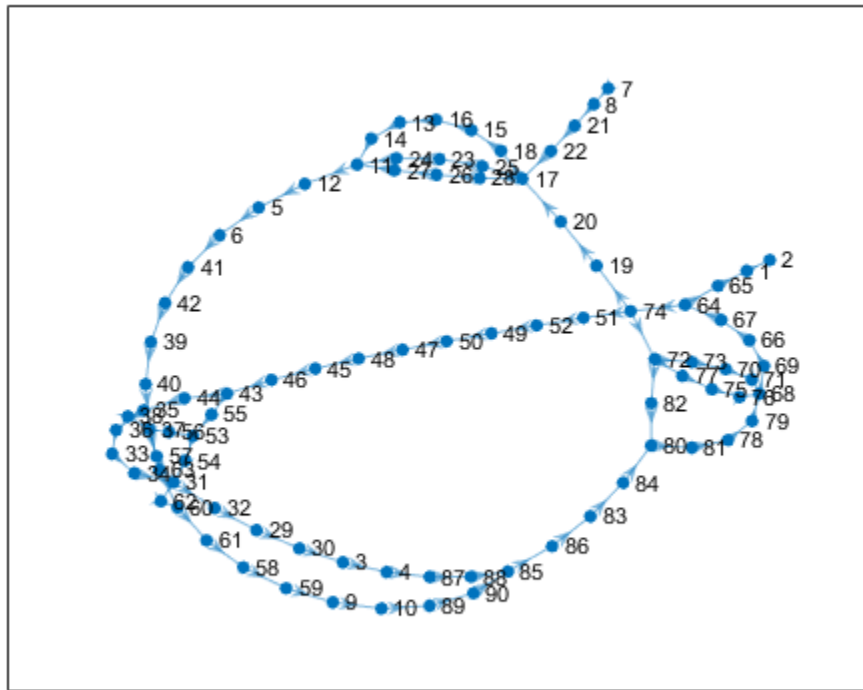

Find the Shortest Path from trace graph

The start node is the outport of target speed [m/s], and the end node is the second inport of Scope. Use the nodes table to obtain the node indexes of the start node and end node and compute the shortest path between them, as shown in the figure.

```
startNode = 7;
endNode = 2;
shortestPath = g.TraceGraph.shortestpath(startNode, endNode);
highlight(fig, shortestPath, 'EdgeColor','r','NodeColor','r','MarkerSize',6,'LineWidth',1);
```

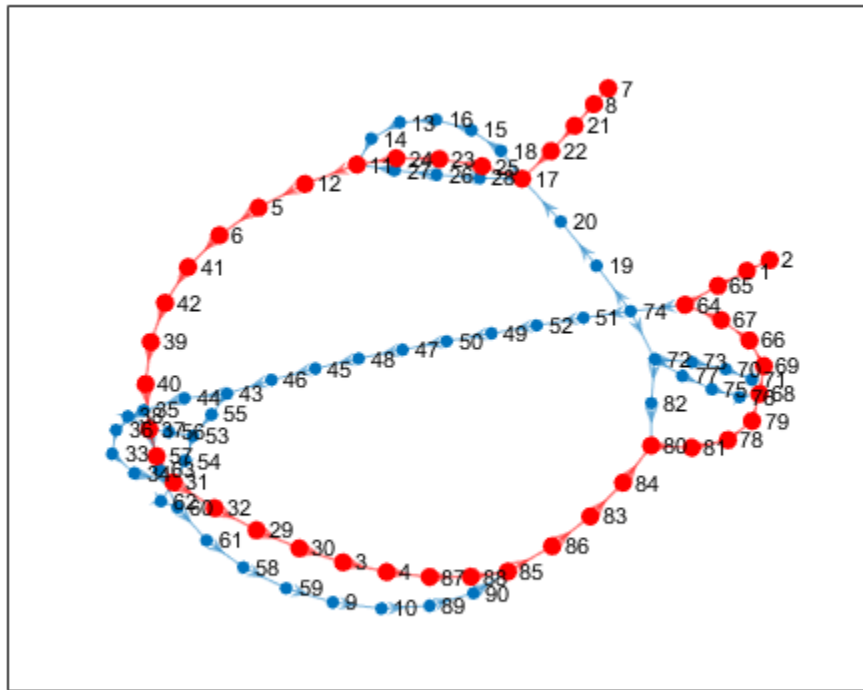

Find the Shortest Control Path from the Simulink Model

The edges table contains two types of edges: real edges and virtual edges, including internal edges and hidden edges. First, filter out the virtual edges using the MATLAB find function.

```
realEdgeIdx = find(cellfun(@(x) ~ischar(x), edges.Segments) == 1);
realEdges = edges(realEdgeIdx, :);
```

Process each node in the shortest path to obtain the corresponding blocks and segments. Since one source node may be connected to multiple destination nodes, iterate over all the edges from the same source node and find the target destination node on the shortest path.

```
elements = [];
for i = 1:length(shortestPath) - 1
    srcNodeIdx = shortestPath(i);
    dstNodeIdx = shortestPath(i+1);
    srcBlockHandle = nodes.Block(srcNodeIdx);
    srcNodeEdgeIdx = find(realEdges.EndNodes(:,2) == dstNodeIdx);
    if length(srcNodeEdgeIdx) > 1
        dstNodeEdgeIdx = find(realEdges.EndNodes(srcNodeEdgeIdx, 2) == dstNodeIdx);
        edgeIdx = srcNodeEdgeIdx(dstNodeEdgeIdx);
    elseif length(srcNodeEdgeIdx) == 1
        edgeIdx = srcNodeEdgeIdx;
    else
        continue;
    end
    elements = [elements srcBlockHandle flip(realEdges.Segments{edgeIdx})];
end
```

Process the last node in the shortest path and highlight the shortest path in the Simulink model, as shown in the figure.

```
lastNodeIdx = shortestPath(end);  
lastBlockHandle = nodes.Block(lastNodeIdx);  
elements = [elements lastBlockHandle];  
highlight(g, elements)
```

